

THIS DOCUMENT IS THE PROPERTY OF KEYSTONE ELECTRONICS CORP. AND SHALL NOT BE REPRODUCED, DISTRIBUTED OR USED AS A BASIS FOR MANUFACTURE WITHOUT PRIOR WRITTEN PERMISSION FROM KEYSTONE ELECTRONICS CORP.

MTG. DETAIL

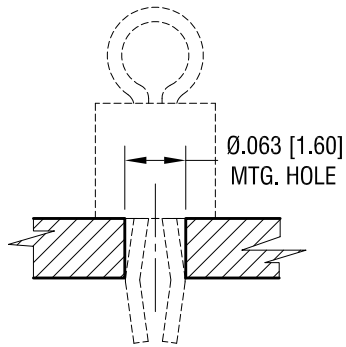

ACTUAL SIZE

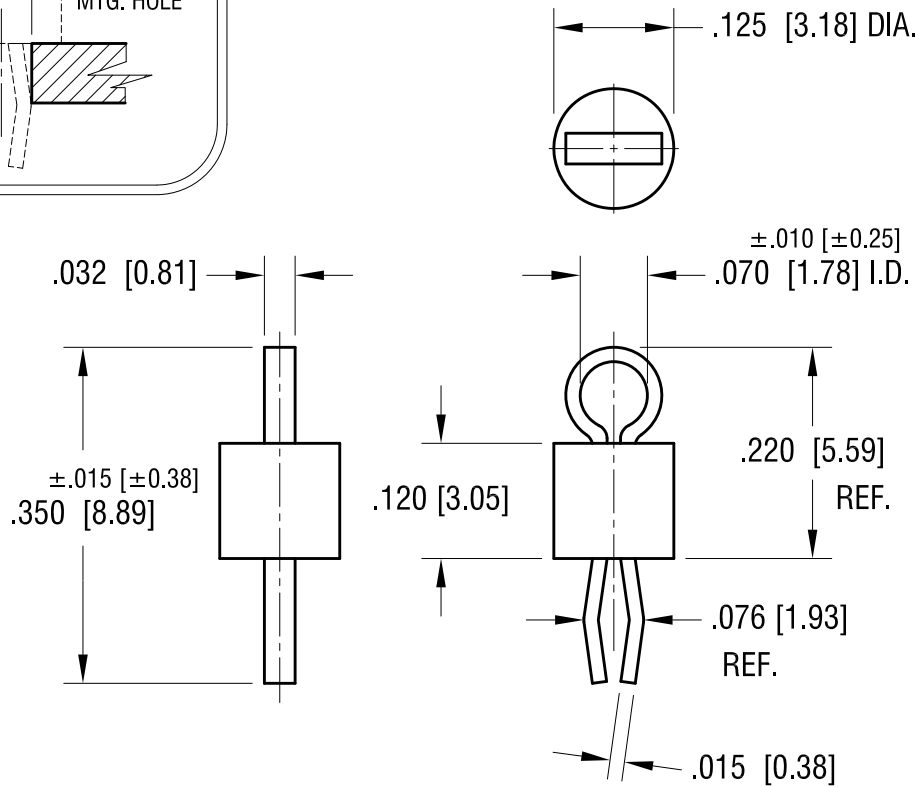

NOTES:

- 1. TERMINAL:  
MAT'L - PHOSPHOR BRONZE WIRE
- 2. BASE:  
MAT'S - HEAT RESISTANT NYLON 46

PART NO.	BASE COLOR
5005	RED
5006	BLACK
5007	WHITE
5008	ORANGE
5009	YELLOW

DATE	DESCRIPTION	REV.
12.30.13	CHANGE AS PER ECN 13-120	F
12.04.08	CHANGE AS PER ECN 08-190	E

<b>KEYSTONE ELECTRONICS CORP.</b>			
www.keyelco.com • ASTORIA, N.Y. 11105-2017 • Tel (718) 956-8900			
PART NAME		PC TEST POINT - COMPACT	
MATERIAL		AS NOTED	
FINISH		DRN BY	DATE
SILVER PLATE		NT	12.09.08
		APP'D	SCALE
		LN	5X
TOLERANCES	INCH [MM]	CODE	DWG NO.
DECIMAL	± .005 [± 0.15]	C	<b>5005-5009</b>
ANGULAR	± 1°		
UNLESS OTHERWISE SPECIFIED			

# Mouser Electronics

Authorized Distributor

Click to View Pricing, Inventory, Delivery & Lifecycle Information:

[Keystone Electronics:](#)

[5005](#)