

DRILL BITS

HEAVY DUTY MAGNUM PREMIUM

Jobbers length



- 135° split point for fast penetration and accurate starting without a center punch.
- Special **HI-MOLYBDENUM** drills are heat treated at 2185 F and then nitro-carburize finished at 950 F to be measurably **HARDER THAN HIGH-SPEED STEEL**.
- Recommended for use in work hardening grades of stainless steel and other hard metal drilling applications. **FLATS ON SHANK.**
- Body and clearance are gold surface treated for **MAXIMUM LUBRICITY**.

PREVENTS . . .

CENTER
PUNCHING

DRILL
WALKING

FREQUENT
REPLACEMENT

FREQUENT
RESHARPENING



J&B #	DRILL DIA.	DECIMAL EQUIV. INCHES	OVERALL LENGTH
22388	1/16	.0625	1-7/8
22389	5/64	.0781	2
22390	3/32	.0938	2-1/4
22391	7/64	.1094	2-5/8
22392	1/8	.1250	2-3/4
22393	9/64	.1406	2-7/8
22394	5/32	.1562	3-1/8
22395	11/64	.1719	3-1/4
22396	3/16	.1875	3-1/2
22397	13/64	.2031	3-5/8
22398	7/32	.2188	3-3/4
22399	15/64	.2344	3-7/8
22400	1/4	.2500	4
22401	17/64	.2656	4-1/8
22402	9/32	.2812	4-1/4

J&B #	DRILL DIA.	DECIMAL EQUIV. INCHES	OVERALL LENGTH
22403	19/64	.2969	4-3/8
22442	5/16	.3125	4-1/2
22443	21/64	.3281	4-5/8
22444	11/32	.3438	4-3/4
22445	23/64	.3594	4-7/8
22446	3/8	.3750	5
22447	25/64	.3906	5-1/8
22448	13/32	.4062	5-1/4
22449	27/64	.4219	5-3/8
22450	7/16	.4375	5-1/2
22451	29/64	.4531	5-5/8
22452	15/32	.4688	5-3/4
22453	31/64	.4844	5-7/8
22454	1/2	.5000	6

DRILL BITS

MECHANIC'S LENGTH J&B MAGNUM PREMIUM 135° Split Point-Gold Tip



- Special **HI-MOLYBDENUM** tool steel is heat treated at 2185°F and then nitro-carburize finished at 950°F to be measurably **HARDER THAN HIGH SPEED STEEL**.
- 135° split point for fast penetration and **ACCURATE STARTING** without center punch.
- Body and clearance are gold surface treated for **MAXIMUM LUBRICITY**.
- **FLATS ON SHANK** give positive chuck-grip and virtually eliminate drill/chuck slippage.
- Recommended for use in work hardening grades of stainless steel and other hard metal drill applications.
- **MECHANICS LENGTH:** The shorter overall length and reduced flute length results in a stronger more rigid drill with greater breakage resistance.

A MAGNUM DRILL WITH IT'S THIN WEB WILL PENETRATE THE WORK HARDENING STAINLESS FAST ENOUGH TO CONTINUALLY CUT BENEATH THE CHIP WHICH IS HARDENING FROM DEFORMATION. THIS MEANS THE DRILL IS CUTTING SOFTER STEEL.



THE COBALT DRILL, WITH IT'S THICKER WEB, CANNOT BE FED AT A FAST ENOUGH RATE TO CUT BENEATH THE AREA WHICH IS HARDENING. AS A RESULT THE COBALT DRILL IS CONTINUALLY DRILLING INTO HARDENED STEEL.

J&B #	DRILL DIA.	DECIMAL EQUIV. INCHES	OVERALL LENGTH
40720	1/16	.0625	1-7/8
40721	5/64	.0781	2
40722	3/32	.0938	2-1/4
40723	7/64	.1094	2-3/8
40724	1/8	.1250	2-1/2
40725	9/64	.1406	2-5/8
40726	5/32	.1562	2-3/4
40727	11/64	.1719	2-7/8
40728	3/16	.1875	3
40729	13/64	.2031	3-1/8
40730	7/32	.2188	3-1/4
40731	15/64	.2344	3-3/8
40732	1/4	.2500	3-1/2
40733	17/64	.2656	3-5/8
40734	9/32	.2812	3-3/4

J&B #	DRILL DIA.	DECIMAL EQUIV. INCHES	OVERALL LENGTH
40735	19/64	.2969	3-7/8
40736	5/16	.3125	4
40737	21/64	.3281	4-1/16
40738	11/32	.3438	4-1/8
40739	23/64	.3594	4-3/16
40740	3/8	.3750	4-1/4
40741	25/64	.3906	4-5/16
40742	13/32	.4062	4-3/8
40743	27/64	.4219	4-7/16
40744	7/16	.4375	4-1/2
40745	29/64	.4531	4-5/8
40746	15/32	.4688	4-3/4
40747	31/64	.4844	4-7/8
40748	1/2	.5000	5



DRILL BITS

J&B HIGH SPEED COBALT Heavy Duty 135° Split Point, Gold Finish



- For use in drilling hard tough metals, free machining stainless steel, high temperature alloys, titanium and certain plastics.
- High red hardness of cobalt steel permits speeds **30%** higher than regular high speed steel drills.

THE HIGH CONTENT OF COBALT GIVES THE DRILL:

- HIGH ABRASION RESISTANCE
- HIGH PERFORMANCE ON STAINLESS STEEL
- HIGH RESISTANCE TO HIGH TEMPERATURES
- HIGH DRILLING CAPACITY TO HEAT-TREATED STEEL

J&B #	DRILL DIA.	DECIMAL EQUIV. INCHES	OVERALL LENGTH
22765	1/16	.0625	1-7/8
22766	5/64	.0781	2
22767	3/32	.0938	2-1/4
22768	7/64	.1094	2-5/8
22769	1/8	.1250	2-3/4
22770	9/64	.1406	2-7/8
22771	5/32	.1562	3-1/8
22772	11/64	.1719	3-1/4
22773	3/16	.1875	3-1/2
22774	13/64	.2031	3-5/8
22775	7/32	.2188	3-3/4
22776	15/64	.2344	3-7/8
22777	1/4	.2500	4
22778	17/64	.2656	4-1/8
22779	9/32	.2812	4-1/4

J&B #	DRILL DIA.	DECIMAL EQUIV. INCHES	OVERALL LENGTH
22780	19/64	.2969	4-3/8
22781	5/16	.3125	4-1/2
22782	21/64	.3281	4-5/8
22783	11/32	.3438	4-3/4
22784	23/64	.3594	4-7/8
22785	3/8	.3750	5
22786	25/64	.3906	5-1/8
22787	13/32	.4062	5-1/4
22788	27/64	.4219	5-3/8
22789	7/16	.4375	5-1/2
22790	29/64	.4531	5-5/8
22791	15/32	.4688	5-3/4
22792	31/64	.4844	5-7/8
22793	1/2	.5000	6

DRILL BITS

SILVER AND DEMING MAGNUM PREMIUM

1/2" SHANK



- Special **HI-MOLYBDENUM** tool steel is heat treated at 2185°F and then nitro-carburize finished at 950°F to be measurably **HARDER THAN HIGH SPEED STEEL**.
- 135° split point for fast penetration and **ACCURATE STARTING** without center punch. (sizes larger than 3/4" have 118° split point)
- Body and clearance are gold surface treated for **MAXIMUM LUBRICITY**.
- **FLATS ON SHANK** give positive chuck-grip and virtually eliminate drill/chuck slippage.
- Recommended for use in work hardening grades of stainless steel and other hard metal drill applications.

J&B #	DRILL DIA.	OVERALL LENGTH
41439	33/64	6"
41440	17/32	6"
41441	35/64	6"
41442	9/16	6"
41443	37/64	6"
41444	19/32	6"
41446	5/8	6"
41448	21/32	6"
41450	11/16	6"
41451	23/32	6"
41452	47/64	6"
41454	3/4	6"
41455	25/32	6"

J&B #	DRILL DIA.	OVERALL LENGTH
41456	51/64	6"
41457	13/16	6"
41458	53/64	6"
41459	27/32	6"
41461	7/8	6"
41462	29/32	6"
41465	15/16	6"
41469	1"	6"
41470	1-1/32	6"
41471	1-1/16	6"
41474	1-1/8	6"
41472	1-3/16	6"
41473	1-1/4	6"

* Individually packaged in plastic tubes

S & D MAGNUM PREMIUM SET

J&B #	TYPE
41480	MAGNUM

- INCLUDES 1 EACH OF S & D SIZES:
9/16, 5/8, 11/16, 3/4,
13/16, 7/8, 15/16, 1"
- SHIPPED IN AN 8 PIECE CASE

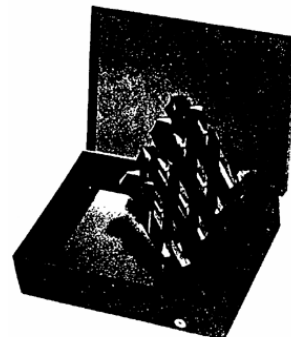

DRILL BITS

SILVER AND DEMING DRILLS 1/2" Shank



- This general purpose 118° point H.S.S. drill is recommended for use in portable air and electric drilling equipment with 1/2" chucks.
- May be used in power applications, such as drill presses, where a short rigid drill is required.

J&B #	DRILL DIA.	OVERALL LENGTH
23164	23/32	6"
23169	13/16	6"

DRILL BITS

STUBBY TWIN END DRILLS

Heavy Duty 135° Split Point



- This twin end drill has wide applications in drilling any thin sheet metal or wood.
- Especially productive for automotive body shops.

J&B #	DIAMETER	OVERALL LENGTH	LENGTH OF TWIST
22534	1/8	1-7/8	7/8
22535	5/32	2-1/16	1
22536	3/16	2-3/16	1-1/8
22537	7/32	2-3/8	1-1/4
22538	1/4	2-1/2	1-3/8

WELDOUT SPOTWELD DRILL BIT

Spur Point

- This rugged high performance bit is designed to effectively cut auto body panel spot welds.
- Eliminates pilot hole. 135 degree self-centered split point.
- Performs best at low RPM. Cuts extremely fast.



J&B #	DIAMETER	APPROX SPOTWELD SIZE, INCHES	OVERALL LENGTH INCHES	TYPE	QTY
V28148	8.0	5/16	2.25	Type 187 Cobalt	EA
IES12085	8.0	5/16	2.875	M7 High Speed Steel	EA
V28149	10.00	3/8	2.25	Type 187 Cobalt	EA
IES12090	10.00	3/8	3.25	M7 High Speed Steel	EA

DRILL BITS

LETTER SIZES MAGNUM PREMIUM



- 135° split point for fast penetration and accurate starting without a center punch.
- Special **HI-MOLYBDENUM** drills are heat treated at 2185 F and then nitro-carburize finished at 950 F to be measurably **HARDER THAN HIGH-SPEED STEEL**.
- Recommended for use in work hardening grades of stainless steel and other hard metal drilling applications.
- Body and clearance are gold surface treated for **MAXIMUM LUBRICITY**.

J&B #	SIZE	FLUTE LENGTH	OVERALL LENGTH
23119	A	2-5/8	3-7/8
23120	B	2-3/4	4
23121	C	2-3/4	4
23122	D	2-3/4	4
23123	E	2-3/4	4
23124	F	2-7/8	4-1/8
23125	G	2-7/8	4-1/8
23126	H	2-7/8	4-1/8
23127	I	2-7/8	4-1/8
23128	J	2-7/8	4-1/8
23129	K	2-15/16	4-1/4
23130	L	2-15/16	4-1/4
23131	M	3-1/16	4-3/8
23132	N	3-1/16	4-3/8
23133	O	3-3/16	4-1/2
23134	P	3-5/16	4-5/8
23135	Q	3-7/16	4-3/4
23136	R	3-7/16	4-3/4
23137	S	3-1/2	4-7/8
23138	T	3-1/2	4-7/8
23139	U	3-5/8	5
23140	V	3-5/8	5
23141	W	3-3/4	5-1/8
23142	X	3-3/4	5-1/8
23143	Y	3-7/8	5-1/4
23144	Z	3-7/8	5-1/4

DRILL BITS

WIRE GAUGE SIZES MAGNUM PREMIUM



- 135° split point for fast penetration and accurate starting without a center punch.
- Special **HI-MOLYBDENUM** drills are heat treated at 2185 F and then nitro-carburize finished at 950 F to be measurably **HARDER THAN HIGH-SPEED STEEL**.
- Recommended for use in work hardening grades of stainless steel and other hard metal drilling applications.
- Body and clearance are gold surface treated for **MAXIMUM LUBRICITY**.

J&B #	SIZE	FLUTE LENGTH	OVERALL LENGTH
23059	1	2-5/8	3-7/8
23060	2	2-5/8	3-7/8
23061	3	2-1/2	3-3/4
23062	4	2-1/2	3-3/4
23063	5	2-1/2	3-3/4
23064	6	2-1/2	3-3/4
23065	7	2-7/16	3-5/8
23066	8	2-7/16	3-5/8
23067	9	2-7/16	3-5/8
23068	10	2-7/16	3-5/8
23069	11	2-5/16	3-1/2
23070	12	2-5/16	3-1/2
23071	13	2-5/16	3-1/2
23072	14	2-3/16	3-3/8
23073	15	2-3/16	3-3/8
23074	16	2-3/16	3-3/8
23075	17	2-3/16	3-3/8
23076	18	2-1/8	3-1/4
23077	19	2-1/8	3-1/4
23078	20	2-1/8	3-1/4
23079	21	2-1/8	3-1/4
23080	22	2	3-1/8
23081	23	2	3-1/8
23082	24	2	3-1/8
23083	25	1-7/8	3
23084	26	1-7/8	3
23085	27	1-7/8	3
23086	28	1-3/4	2-7/8
23087	29	1-3/4	2-7/8
23088	30	1-5/8	2-3/4

J&B #	SIZE	FLUTE LENGTH	OVERALL LENGTH
23089	31	1-5/8	2-3/4
23090	32	1-5/8	2-3/4
23091	33	1-1/2	2-5/8
23092	34	1-1/2	2-5/8
23093	35	1-1/2	2-5/8
23094	36	1-7/16	2-1/2
23095	37	1-7/16	2-1/2
23096	38	1-7/16	2-1/2
23097	39	1-3/8	2-3/8
23098	40	1-3/8	2-3/8
23099	41	1-3/8	2-3/8
23100	42	1-1/4	2-1/4
23101	43	1-1/4	2-1/4
23102	44	1-1/8	2-1/8
23103	45	1-1/8	2-1/8
23104	46	1-1/8	2-1/8
23105	47	1	2
23106	48	1	2
23107	49	1	2
23108	50	1	2
23109	51	1	2
23110	52	7/8	1-7/8
*23111	53	7/8	1-7/8
*23112	54	7/8	1-7/8
*23113	55	7/8	1-7/8
*23114	56	3/4	1-3/4
*23115	57	3/4	1-3/4
*23116	58	11/16	1-5/8
*23117	59	11/16	1-5/8
*23118	60	11/16	1-5/8

DRILL BITS

METRIC MAGNUM PREMIUM Jobbers length - 135° Split Point



- **135°** split point for fast penetration and accurate starting without a center punch.
- Special **HI-MOLYBDENUM** drills are heat treated at 2185 F and then nitro-carburize finished at 950 F to be measurably **HARDER THAN HIGH-SPEED STEEL**.
- Recommended for use in work hardening grades of stainless steel and other hard metal drilling applications
- Body and clearance are gold surface treated for **MAXIMUM LUBRICITY**.

PREVENTS . . .

CENTER
PUNCHING

DRILL
WALKING

FREQUENT
REPLACEMENT

FREQUENT
RESHARPENING



J&B #	DRILL DIA.	BOLT DIA. SIZE	OVERALL LENGTH
57210	1.60	2-.40	1-7/8
57215	2.50	3-.50	2-23/64
57220	3.30	4-.70	2-7/8
57225	4.20	5-.80	3-1/4
57230	5.00	6-1.00	3-5/8
57235	6.00	7-1.00	4
57240	6.80	8-1.25	4-1/8
57245	8.60	10-1.50	4-3/4
57250	10.50	12-1.75	5-15/64

DRILL BITS

CARBIDE MASONRY DRILLS

Slow Spiral - Heavy Duty



- Carbide tipped, hardened steel bodies.
- The fastest, easiest way to drill holes in brick, tile, cement, asbestos, marble, concrete.
- No special equipment needed. Use them in any regular electric drill.
- Ideal for expansion bolt installation, installation of plumbing, heating, or air conditioning equipment, anchoring partitions, setting tile and wiring buildings.

J&B #	DIAMETER	OVERALL LENGTH	SHANK DIAMETER
22506	1/8	3"	1/8
22507	3/16	4"	3/16
22508	1/4	4"	1/4
22509	5/16	4"	1/4
22510	3/8	4"	5/16
22511	1/2	6"	3/8
22512	5/8	6"	3/8
22513	3/4	6"	1/2
22515	7/8	6"	1/2
22514	1	6"	1/2

AIRCRAFT EXTENSION DRILLS



- This heavy duty 135° split point H.S.S. drill is used for drilling holes in hard to reach places.

J&B #	DIAMETER	TOTAL LENGTH	FLUTE LENGTH
40340	3/16	12"	2-1/4
40342	1/4	12"	2-1/2
39020	5/16	12"	3-1/8
40344	3/8	12"	3-3/4
40346	1/2	12"	4-1/2

DRILL BIT SETS

J&B HEAVY DUTY SPLIT POINT DRILLS

J&B #	SIZE
20580	1/16 - 1/4 BY 64THS
22532	1/16 - 1/2 BY 32NDS
22533	1/16 - 1/2 BY 64THS

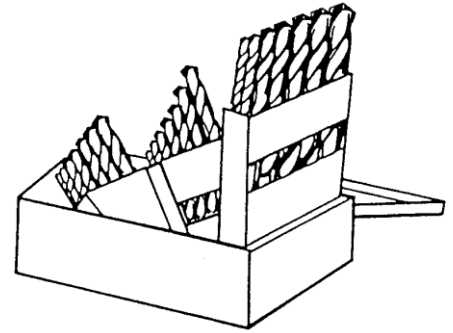

J&B MAGNUM PREMIUM DRILLS

J&B #	SIZE
40749	1/16 - 1/4 BY 64THS
40750	1/16 - 1/2 BY 32NDS
40751	1/16 - 1/2 BY 64THS

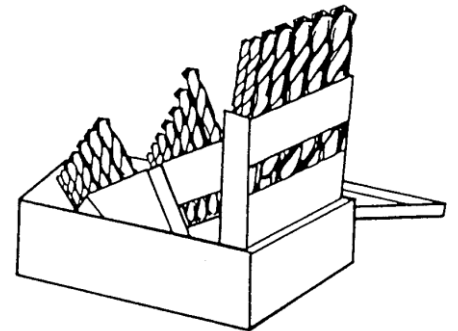

J&B HIGH SPEED COBALT DRILLS

J&B #	SIZE
22795	1/16 - 1/4 BY 64THS
22796	1/16 - 1/2 BY 32NDS
22797	1/16 - 1/2 BY 64THS

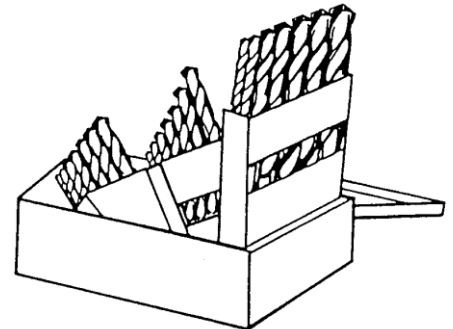

STRAIGHT SHANK DRILLS

J&B #	SIZE
20578	A - Z
20579	#1 - 60

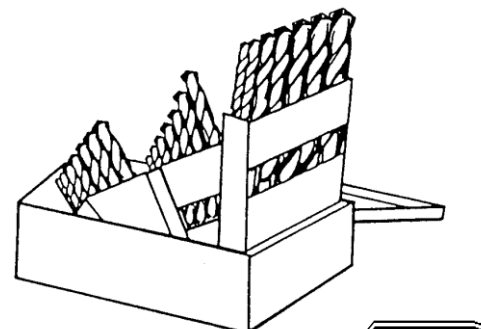

DRILL BIT SETS

ULTRA-DEX DRILL SETS

J&B #	SIZE	TYPE
40767	1/16 – 1/2 BY 64THS	H/D SPLIT POINT
40772	1/16 – 1/2 BY 32NDS	H/D SPLIT POINT
40768	1/16 – 1/2 BY 64THS	COBALT
40774	1/16 – 1/2 BY 32NDS	COBALT
40769	1/16 – 1/2 BY 64THS	MAGNUM
40773	1/16 – 1/2 BY 32NDS	MAGNUM



- Weather – tight / waterproof - indstructable

8 PIECE STARTER SET

J&B #	TYPE
40754	H/D SPLIT POINT
40756	COBALT
40758	MAGNUM

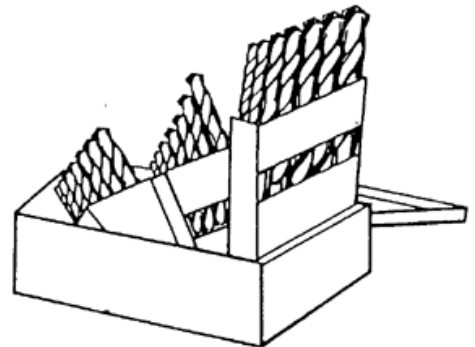

- INCLUDES 1 EACH OF DRILL SIZES:
1/8, 3/16, 7/32, 1/4, 5/16, 3/8, 7/16, 1/2
- SHIPPED IN A 29 PIECE CASE

29 PIECE STARTER SET

J&B #	TYPE
40762	H/D SPLIT POINT
40764	COBALT
40766	MAGNUM



- INCLUDES 4 EACH OF DRILL SIZES:
1/16, 3/32, 1/8, 5/32
- INCLUDES 3 EACH OF DRILL SIZES:
3/16, 7/32, 1/4
- INCLUDES 1 EACH OF DRILL SIZES:
9/32, 5/16, 3/8, 1/2

- SHIPPED IN A 3 DRAWER H/D DRILL CASE
(J&B #38690)

EMPTY DRILL INDEX BOXES

(SEE PAGE 2009)

CUTTING TOOLS

CARBIDE BURS

- Solid carbide burs are manufactured in the USA from high performance, Industrial grade carbide.
- Different shapes give access to hard-to-reach areas.



57016



57001, 57002, 57003



57004, 57005



57015



57018



57014



57017



57006, 57007, 57008



57009, 57010



57011, 57012



57013

J&B #	IND #	SHAPE	CUT	DIA.	LOF	SHANK	QTY
57001	SC-3	CYLINDRICAL RADIUS	SINGLE	3/8	3/4	1/4	EA
57002	SC-5	CYLINDRICAL RADIUS	SINGLE	1/2	1"	1/4	EA
57003	SC-7	CYLINDRICAL RADIUS	SINGLE	3/4	1"	1/4	EA
57004	SF-3	ROUND TREE	SINGLE	3/8	3/4	1/4	EA
57005	SF-5	ROUND TREE	SINGLE	1/2	1"	1/4	EA
57006	SC-3/FM	CYLINDRICAL RADIUS	ALUMINUM	3/8	3/4	1/4	EA
57007	SC-5/FM	CYLINDRICAL RADIUS	ALUMINUM	1/2	1"	1/4	EA
57008	SC-7/FM	CYLINDRICAL RADIUS	ALUMINUM	3/4	1"	1/4	EA
57009	SD-3/FM	BALL	ALUMINUM	3/8	3/8	1/4	EA
57010	SD-5/FM	BALL	ALUMINUM	1/2	1/2	1/4	EA
57011	SF-3/FM	ROUND TREE	ALUMINUM	3/8	3/4	1/4	EA
57012	SF-5/FM	ROUND TREE	ALUMINUM	1/2	1"	1/4	EA
57013	SA-5/FM	CYLINDRICAL	ALUMINUM	1/2	1"	1/4	EA
57014	SC-42	CYLINDRICAL RADIUS	MINI SINGLE	1/8	9/16	1/8	EA
57015	SG-5	POINTED TREE	SINGLE	1/2	1"	1/4	EA
57016	SA-5	CYLINDRICAL	SINGLE	1/2	1"	1/4	EA
57017	SF-42	ROUND TREE	MINI SINGLE	1/8	1/2	1/8	EA
57018	SM-5	CONE	SINGLE	1/2	7/8	1/4	EA

CUTTING TOOLS

RAPID REAMER



- Drill truck frames in **MINUTES INSTEAD OF HOURS**. Specially engineered incline plane makes the difference.
- Reduces time, drill breakage, extreme pressure required on large diameter drills.
- Reamers start with only small, easy to drill pilot hole - then go into action to quickly enlarge the hole to size.
- Use heavy-duty 1/2" or larger drill with at least 4.5 amps; best results obtained if motor is 6 to 15 amps. High amps provide constant torque with even speed. For best cutting results, apply a medium amount of feed pressure at a maximum of 200-400 RPM.

J&B #	SIZE	SHANK SIZE	OVERALL LENGTH
38629	3/8	3/8	5-7/8
38630	7/16	7/16	5-3/8
38632	1/2	1/2	5-7/8
38633	9/16	1/2	5-7/8
38634	5/8	1/2	6-1/2
38636	3/4	1/2	6-3/4
38638	1	1/2	7

USE RAPID REAMER FOR:

5th Wheel Mounting * Spring Hangers * Fuel Tank Mounting * Tool Box Mounting * Accessory Mounting * Enlarging Spring Center Bolt Holes * Tow Hook Mounting * Weighted Bumper Mounting on Cranes * Installing Teeth on Front Ends * Loader Buckets * Enlarging Misaligned Holes

TYPICAL APPLICATIONS

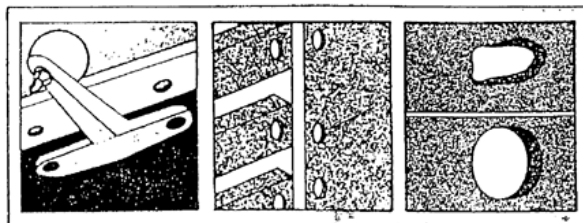

Bumper Hitch Installation Panel Hole Alignment Re-size Elongated Holes

CUTTING TOOLS

STEP DRILL



- 3 flatted shank
- Laser-marked for easy size identification.
- Made of industrial grade **high-speed** molybdenum steel.
- Drill up to 1/8" thick material.
- The single radial concave flute design means smooth, even cutting and truly round holes.
- **Self-starting** tip won't skid like standard twist drill bits.

J&B #	STEPS	RANGE	INCREMENTS	SHANK SIZE
41885	9	1/4" - 3/4"	1/16"	3/8
41883	10	1/4" - 1-3/8"	1/8"	1/2
41884	12	3/16" - 7/8"	1/16"	3/8

APPLICATIONS:

Ferrous & Non-Ferrous Sheet Metal * Wood * Plastic Laminates * Sink Grade Stainless Steel * Maintenance * Electrical Contracting * Plumbing * Auto Body Repair * Heating * Rust Proofing * Air Conditioning * Steel * Copper * Brass * Aluminum

DRILL BITS

LEFT HAND DRILLS J&B Magnum Premium



- Special Hi-Molybdenum tool steel.
- 135° split point for fast penetration and **ACCURATE STARTING** without center punch.
- Precision ground point, flutes, body, clearance and drill diameter for the ultimate in accuracy and performance.
- Body and clearance are gold surface treated for maximum lubricity.
- Ideal for drilling broken studs.
- Left hand spiral drill will often loosen the bolt stud, thereby eliminating the need for use of a bolt extractor.

J&B #	DRILL DIAMETER	DECIMAL EQUIVAL.	OVERALL LENGTH
40890	1/16	.0625	1-7/8
40891	3/32	.0938	2-1/4
40892	1/8	.1250	2-3/4
40894	3/16	.1875	3-1/2
40896	1/4	.2500	4
40898	5/16	.3125	4-1/2
40900	3/8	.3780	5
40901	7/16	.4375	5-12
40903	1/2	.5000	6

LEFT HAND DRILL BIT SET

- Contains 1 each of sizes 1/16, 3/32, 1/8, 3/16, 1/4, 5/16, 3/8, 7/16 & 1/2.

J&B #	QTY
40670	EA

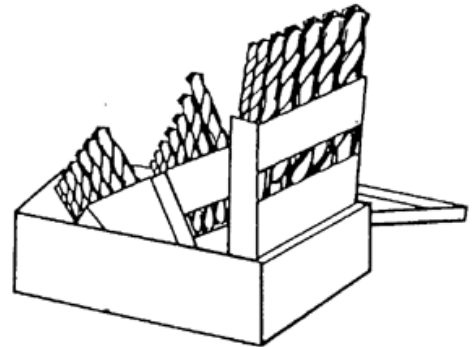

EXTRACTORS

SCREW AND PIPE EXTRACTORS

Hi-Carbon Steel



- For removing broken screws, bolts and threaded parts.
- A hole is drilled in the broken part and the extractor inserted. Turned to the left the spiral flutes grip and remove the broken part without damaging the threads in the hole.

J&B #	EXTRAC NO	TO REMOVE DIAMETER SCREW	DIAMETER SMALL END IN	DIAMETER LARGE END IN	LENGTH OVERALL INCHES	SIZE DRILL TO USE
28131	1	3/32 to 5/32	.054	5/32	2	3/32
28132	2	5/32 to 7/32	.080	3/16	2-1/2	1/8
28133	3	7/32 to 9/32	1/8	1/4	3	3/16
28134	4	9/32 to 3/8 & 1/8 pipe	3/16	11/32	3	1/4
28135	5	3/8 to 5/8 & 1/4 pipe	15/64	7/16	3-3/8	17/64
28136	6	5/8 to 7/8 & 3/8 pipe	3/8	19/32	3-3/4	13/32

BOLT REMOVER SET

- **FAST** and **EASY** stud removal.
- Left hand spiral drills often eliminate the need for bolt and screw extractors.
- Drill may loosen bolt stud with counter clockwise rotation.

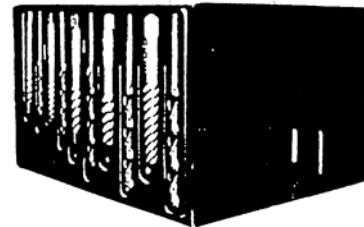

CONTAINS:

- 4 Left hand Super Premium drill bits with 135° split point.
 Sizes 3/32, 1/8, 3/16, and 1/4
- 4 screw and bolt extractors
 Sizes 1, 2, 3 and 4

J&B #	QTY
40760	EA

EXTRACTOR SET

J&B #	QTY
28140	EA

CONTAINS:

- 1 each #1 thru #5 extractor

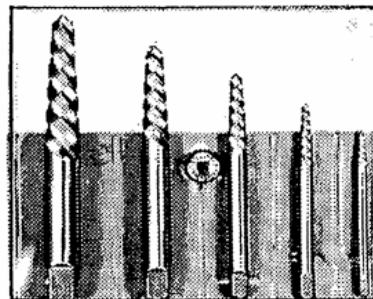

EXTRACTORS

SCREW, STUD & PIPE EXTRACTORS

Forged Hi-Carbon



- The square shape of these extractors gives the tools the ability to remove broken bolts, screws and pipes with minimum deformation of the broken part.
- These forged extractors will not chew up or expand the object being removed.

J&B #	EXTRACTOR #	TO REMOVE DIAMETER OF SCREW	SIZE OF SCREW EXTRACTOR		DRILL SIZE	QTY
			SHANK	POINT		
28141	1	3/16 to 9/32	3/16	1/8	1/8	EA
28142	2	9/32 to 11/32	1/4	11/64	3/16	EA
28143	3	11/32 to 1/2	5/16	7/32	1/4	EA
28144	4	1/2 to 3/4	3/8	9/32	5/16	EA
28145	5	5/8 to 7/8	7/16	21/64	3/8	EA

How to use:

To remove the broken threaded part: Drill a hole in the end of the broken part (left hand spiral heavy duty drills are recommended for this drilling operation) , insert extractor and turn counter clockwise using a wrench on the exposed end of the extractor. The broken part should unscrew without damage to the threads.

HACKSAW BLADES

BI-FLEX BI-METAL Welded Edge - Shatter-proof



- The distinctive, high speed steel cutting edge is an electron beam welded to a separate alloy back for **EXTRA STRENGTH . . . EXTRA CUTTING POWER.**
- Bi-metal blade combines tougher teeth with flexibility for a safer, **SHATTER-PROOF BLADE.**
- Heat treated cutting edge for faster and easier cutting.
- Shatter-proof bi-metal blade exceeds the cutting life of ordinary steel blades.

J&B #	TEETH/ IN.	LENGTH	WIDTH	BRAND	QTY
21328	14	12"	1/2"	MORSE	1
21338	14	12"	1/2"	MORSE	10
40576	18	12"	1/2"	MORSE	1
40577	18	12"	1/2"	MORSE	10
38976	24	12"	1/2"	MORSE	1
38977	24	12"	1/2"	MORSE	10
39351	24	12"	1/2"	LENOX	1
39352	24	12"	1/2"	LENOX	10
40578	32	12"	1/2"	MORSE	1
40579	32	12"	1/2"	MORSE	10

J&B #	TEETH/ IN.	LENGTH	WIDTH	BRAND	QTY
21341	24	10"	1/2"	MORSE	1
21342	24	10"	1/2"	MORSE	10

HACKSAW FRAME

- Precision-cast aluminum and steel frame.
- Unique lever tensions the 12" J&B blade to 30,000 psi (about twice that of ordinary frames).
- Blade doesn't twist when you bear down, doesn't bind in tough materials or structurals.

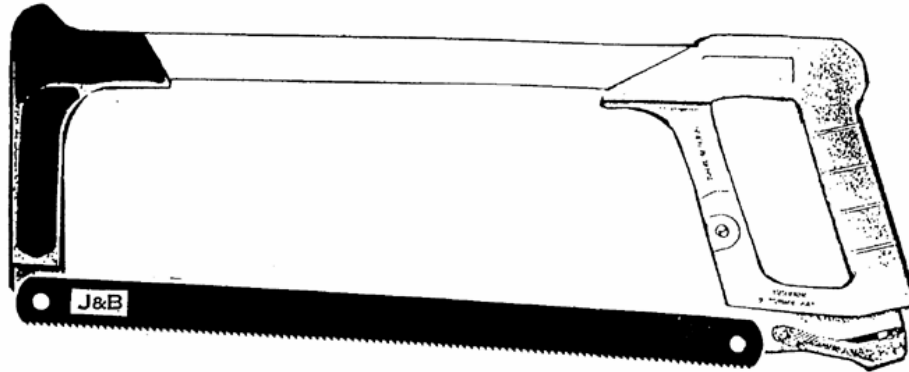

J&B #	QTY
38975	EA

FEATURES FOR PROFESSIONAL TOOL USERS

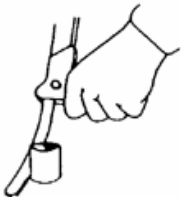

Use as job saw
(set screw holds
blade in position).

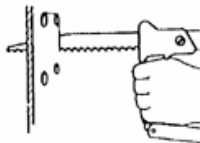

Use as compass
saw with reciprocating
blade in position.

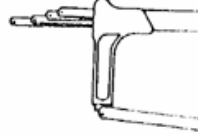

Store spare blades
inside back.

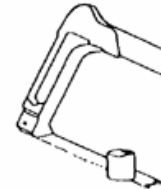

Mount blade at 45°
for flush cutting.

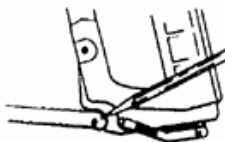

Permanently inserted
pins.

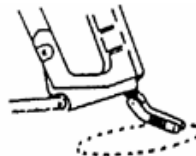

Lever turns tensioning
screw. Eight turns max.
Tighten blade up to
28,000 PSI.



Solid front end grip.

SAW BLADES

DRIVE PIN PUNCHES Extra Long 8"



- For driving out and removing already loosened pins and keys after initial movement by starter or solid punch.
- Made of centerless ground hardened tool steel.

J&B #	QTY
38925	SET

SET COMES IN PLASTIC CASE
AND INCLUDES:

1/8", 3/16", 1/4", 5/16", 3/8"

SAW BLADES

JIG / SABRE SAW BLADES

- Durable, high performance bi-metal jig/sabre saw blades outlast all other types of carbon and high speed steel blades.
- **SHATTER-PROOF**; wood and metal cutting.



J&B #	TEETH	LENGTH	QTY	RECOMMENDED USES
39214	24	3-1/8"	10	1/16" Steel and under, Thin wall tubing, Formica
39216	14	4"	10	1/8" to 1/4" Steel, nonferrous aluminum, fiberglass, plastic

JIG / SABRE SAW BLADES

For Bayonet machines



J&B #	TEETH	LENGTH	QTY	RECOMMENDED USES
41888	24	1-3/4"	10	Thin sheet steel, thin wall tubing, suitable for scroll work.
41889	14	3"	10	1/16" - 1/8" Steel, conduit, plastic, tubing, etc.

SLIK-KOTE JIG SAW BLADE

For Bosch machines

- A special treatment & coating results in a hard, abrasion resistant surface that adds to the cutting life of the blade.



J&B #	TEETH	LENGTH	QTY	RECOMMENDED USES
41974	12	3"	100	Especially fiberglass & other abasive materials. Also, metals including stainless.

SAW BLADES

BI-METAL RECIPROCATING BLADES

Universal 1/2" Shank

- Tough **SHATTER-PROOF** bi-metal reciprocating blades fit all popular machines.
- The teeth retain their hardness and stay sharper longer.

BI-FLEX METAL CUTTING



J&B # 39224, # 42030, # 42032,
42034, # 42158

BI-FLEX METAL CUTTING - SCROLL



J&B # 39220, # 42157

BI-FLEX WOOD CUTTING



J&B # 42037, # 42038

BI-FLEX WOOD CUTTING



J&B # 42036, # 41978

J&B #	TEETH	LENGTH	QTY	RECOMMENDED USES
42158	14	6"	5	For metals heavier than 1/8", bar stock, angles, etc. Also rubber, Masonite, fiberglass, etc.
42030	14/10	8"	5	Heavy guage metals, Compostions, Masonite, Wood, etc.
42032	14/10	12"	5	
39224	18	6"	5	Heavy guage sheet metal, Conduit pipe, Tubing, Thin fiberglass
42034	18	8"	5	
39220	18	3"	10	Thin sheet metal, scroll cutting
42157	14	3-5/8"	10	Heavy gauge metal, fiberglass, masonite scroll cutting.
41978	6	6"	50	Slik-Kote-Special Treatment & coating results in a hard, abrasion resistant surface adding to the cutting life of the blade. Especially recommended for fiberglass & other abrasive applications. Also metals, including stainless.
42036	6	6"	5	For wood and nail-embedded woods, all composition material. Also non-ferrous metals
42037	6	9"	5	General roughing-in work in wood and nail-embedded woods. Fast cutting.
42038	6	12"	5	

HOLE SAWS

BI-METAL - VARIED PITCH

- **“FOLLOW THROUGH” DESIGN** permits cutting through single pieces, successive partitions, or stacked material.
- **HIGH SPEED STEEL**; welded edge; shatter-proof.
- Cuts all machinable materials quickly and accurately.

J&B #	SIZE
39238	5/8
39240	3/4
39242	7/8
39244	1
39245	1-1/16
39246	1-1/8
39248	1-1/4
39249	1-5/16
39250	1-3/8
39252	1-1/2
39253	1-5/8
39254	1-3/4
39255	1-7/8

J&B #	SIZE
39256	2
39257	2-1/8
39258	2-1/4
39259	2-3/8
39260	2-1/2
39265	2-5/8
39261	2-3/4
39267	2-7/8
39262	3
39271	3-1/8
39273	3-1/4
39263	3-1/2
39234	4
39236	4-1/2



ARBORS WITH

PILOT BIT

J&B #	SHANK	FITS HOLE SAWS
39264	1/4" Round	9/16 - 1-3/16
39266	7/16" Hex	9/16 - 1-3/16
39268	7/16" Hex	1-1/4 - 6"
39269	Replacement Pilot Drill Bit	



INDUSTRIAL HOLE SAW KIT

INCLUDES:

- 1 - 3/4" hole saw
- 1 - 7/8" hole saw
- 1 - 1-1/8" hole saw
- 1 - 1-3/8" hole saw
- 1 - 1-1/2" hole saw
- 1 - 1-3/4" hole saw
- 1 - 2" hole saw

- 1 - 2-1/4" hole saw
- 1 - 2-1/2" hole saw
- 1 - 1/4" round arbor
- 1 - 7/16" hex arbor
- 1 - 1/4 pilot drill for arbor
- 1 - Tool box
- 1 - Arbor adapter

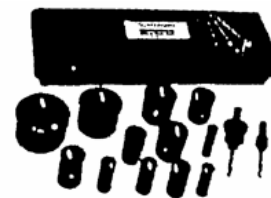

J&B #	QTY
39210	EA



TAPS

MACHINE SCREW TAPS

High Speed Steel



- **Tough carbon steel**, manufactured to exact, precise specifications.
- Heat treated and tempered to insure long life, and clean, accurate threading.

J&B #	SIZE
38147	4-40 P
38148	5-40 P
38150	6-32 T
38151	6-32 P
38152	6-32 B

J&B #	SIZE
38153	8-32 T
38154	8-32 P
38155	8-32 B
38156	10-24 T
38157	10-24 P
38158	10-24 B

J&B #	SIZE
38159	10-32 T
38160	10-32 P
38161	10-32 B
38162	12-24 T
38163	12-24 P
38164	12-24 B

STANDARD HAND TAPS

High Speed Steel

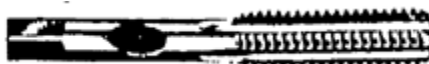

J&B #	SIZE
24778	1/4-20 T
24779	1/4-20 P
24780	1/4-20 B
24781	1/4-28 T
24782	1/4-28 P
24783	1/4-28 B
24784	5/16-18 T
24785	5/16-18 P
24786	5/16-18 B
24787	5/16-24 T
24788	5/16-24 P
24789	5/16-24 B
24790	3/8-16 T
24791	3/8-16 P
24792	3/8-16 B
24793	3/8-24 T
24794	3/8-24 P
24795	3/8-24 B

J&B #	SIZE
24796	7/16-14 T
24797	7/16-14 P
24798	7/16-14 B
24799	7/16-20 T
24800	7/16-20 P
24801	7/16-20 B
24802	1/2-13 T
24803	1/2-13 P
24804	1/2-13 B
24805	1/2-20 T
24806	1/2-20 P
24807	1/2-20 B
38334	9/16-12 T
38335	9/16-12 P
38336	9/16-12 B
38337	9/16-18 T
38338	9/16-18 P
38339	9/16-18 B

J&B #	SIZE
24808	5/8-11 T
24809	5/8-11 P
24810	5/8-11 B
38340	5/8-18 T
38341	5/8-18 P
38342	5/8-18 B
24811	3/4-10 T
24812	3/4-10 P
24813	3/4-10 B
38343	3/4-16 T
38344	3/4-16 P
38345	3/4-16 B
38332	7/8-9 T
38326	7/8-14 T
38333	1-8 T
38329	1-14 T

ILLUSTRATION SHOWING 3 STYLES OF TAPS

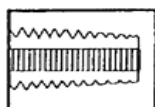

TAPER:

8 to 10 threads chamfered for easy thread starting in tough materials.

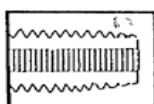

PLUG:

3 to 5 threads chamfered-general use when tapping to bottom of hole is not critical. (This is the most widely used type of tap.)

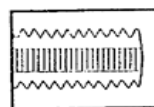

BOTTOMING:

1-1/2 threads chamfered - use after threads have been started for tapping to bottom of hole.

TAPS

3 PIECE TAP SETS

- Each tap set contains one each of the **taper**, **plug** and **bottoming** style taps.
- In blind holes tapped by hand to the very bottom, all three taps (i.e. taper, plug and bottoming) should be used in the order named.

Machine Screw

J&B #	SIZE
38304	6-32
38305	8-32
38306	10-24
38307	10-32
38303	12-24

Coarse

J&B #	SIZE
38308	1/4-20
38309	5/16-18
38310	3/8-16
38311	7/16-14
38312	1/2-13
38313	9/16-12
38314	5/8-11
38315	3/4-10

Fine

J&B #	SIZE
38316	1/4-28
38317	5/16-24
38318	3/8-24
38319	7/16-20
38320	1/2-20
38321	9/16-18
38322	5/8-18
38323	3/4-16



Taper



Plug



Bottoming

TAPER PIPE TAPS - NPT

High Speed Steel



J&B #	SIZE
38327	1/16
38168	1/8
38169	1/4
38170	3/8
38171	1/2
38640	3/4
38641	1

EMPTY TAP INDEX BOXES

(SEE PAGE 2012)

TAPS

METRIC HAND TAPS High Speed Steel - Plugs

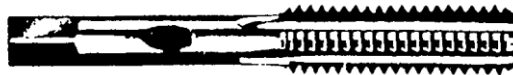

J&B #	SIZE
22484	3 - .50
22486	4 - .70
22485	5 - .80
22475	5 - .90
22487	6 - 1.0
22476	7 - 1.00
22503	8 - 1.00
22488	8 - 1.25
22477	9 - 1.00
22478	9 - 1.25
22504	10 - 1.00
22489	10 - 1.25
22490	10 - 1.50

J&B #	SIZE
22479	11 - 1.50
22483	12 - 1.25
22480	12 - 1.50
22491	12 - 1.75
22492	14 - 1.25
22472	14 - 1.50
22493	14 - 2.00
22474	16 - 1.50
22473	16 - 2.00
22481	18 - 2.50
22482	20 - 2.50

T-TYPE TAP WRENCH

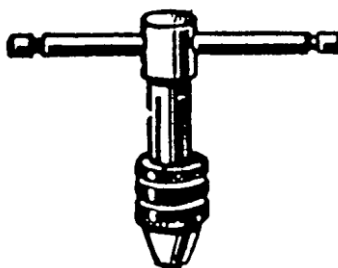

- Sliding T-handle with spring tension to hold handle in place. Self-equalizing jaws.

J&B #	FITS STANDARD TAPS	FITS MACHINE SCREW TAPS
22500	1/16 to 1/4	#0 to 14
22501	7/32 to 1/2	#12 to 14

EMPTY TAP INDEX BOXES

(SEE PAGE 2012)

TAP & DRILL SET

- J&B introduces the 19 piece combination set of quicktwist drill bits and matching taps.
- This unique set offers both the **drill** and **matching tap**, so you will never have to guess again.
- Quicktwist drill bits have a 135° split point for fast, accurate drilling. Their surface is coated with an alkali-nitrite bath to reduce adhesion.
- Taps are ground from super high speed steel.

SET INCLUDES ONE EACH . . .

<u>TAP</u>	<u>DRILL</u>
6-32	#36
8-32	#29
10-24	#25
10-32	#21
1/4-20	# 7
5/16-18	F
3/8-16	5/16
7/16-14	U
1/2	27/64
Heavy Duty Metal Case	

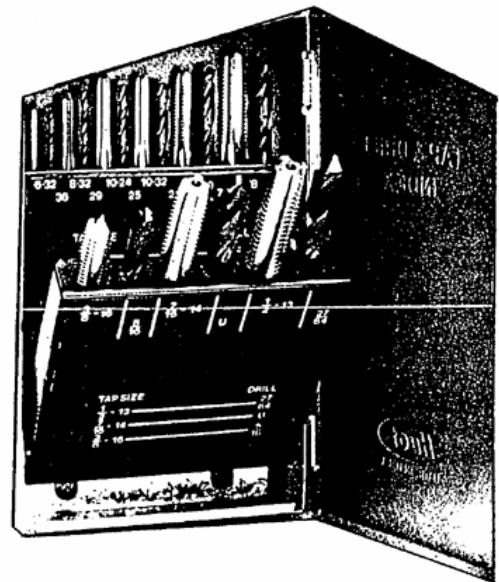

J&B #	QTY
20576	EA

DIES

HEX DIES

- These dies are precision made of high quality carbon tool steel and meet the highest industry standards.

J&B #	SIZE	WIDTH ACROSS FLATS	QTY
41003	6-32	1"	EA
41004	8-32	1"	EA
41005	10-24	1"	EA
41006	10-32	1"	EA
41009	1/4-20	1"	EA
41010	1/4-28	1"	EA
41011	5/16-18	1"	EA
41012	5/16-24	1"	EA
41013	3/8-16	1"	EA
41014	3/8-24	1"	EA
41015	7/16-14	1"	EA
41016	7/16-20	1"	EA
41017	1/2-13	1"	EA
41022	1/2-20	1"	EA
41021	5/8-11	1-1/2"	EA
41023	3/4-10	1-1/2"	EA

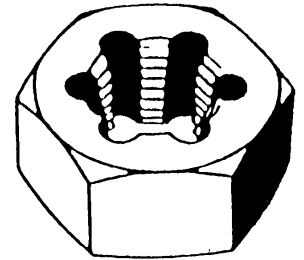

PIPE DIES - NPT

J&B #	SIZE	WIDTH ACROSS FLATS	QTY
41025	4 - .70	1"	EA
41026	5 - .80	1"	EA
41027	6 - 1.00	1"	EA
41029	8 - 1.25	1"	EA
41031	10 - 1.50	1"	EA
41033	12 - 1.75	1"	EA

J&B #	SIZE	WIDTH ACROSS FLATS	QTY
22380	1/8	1"	EA
22381	1/4	1-1/2"	EA
22382	3/8	1-1/4"	EA
22383	1/2	1-7/16"	EA

HEX DIE HOLDERS

- 3-jaw **SELF-CENTERING** adjustable guides assure straight threads and easy starting.

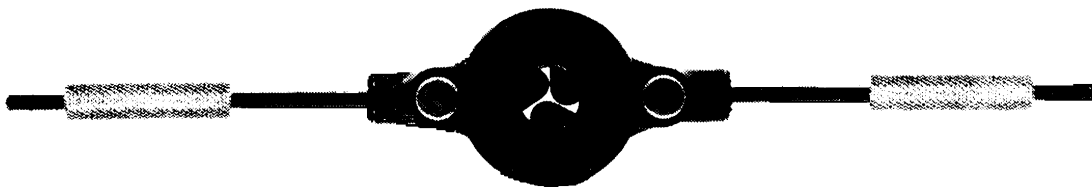

J&B #	FITS J&B DIE SIZES	WIDTH ACROSS FLATS	QTY
41040	6-32 to 1/2	UP TO 1"	EA
41042	5/8 to 3/4	UP TO 1-1/2"	EA

KEENSERTS

- Easy to install; **NO SPECIAL TOOLS NEEDED.**
- Provides permanent threads that refuse failure, even under excessive loading; won't strip, rotate or pull out.
- Exclusive locking feature provides a positive, **mechanical lock** against rotation.
- Carbon steel inserts.



1. DRILL OUT OLD THREADS, USING STANDARD DRILL



2. TAP NEW THREADS, USING STANDARD TAP.



3. SCREW IN INSERT UNTIL SLIGHTLY BELOW SURFACE.

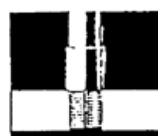

4. DRIVE "KEES" DOWN WITH SEVERAL TAPS ON INSTALLATION TOOL.



5. INSTALLED INSERT.

THINWALL

INSERTS					INSTALLATION DATA					REMOVAL DATA	
INTERNAL THREAD SIZE	EXTERNAL THREAD SIZE	J&B #	QTY	LENGTH	TAP DRILL DIAM	C' SINK DIAM	TAP SIZE	INSTALLATION TOOL		DRILL	
								SIZE	J&B #	SIZE	DEPTH
10-24 10-32	5/16-18	21700 21701	5	.31	"I"	.32	5/16-18				
1/4-20 1/4-28	3/8-16	21702 21703	5	.37	"Q"	.38	3/8-16	1/4	21721	9/32	3/16
5/16-18 5/16-24	7/16-14	21704 21705	5	.43	"X"	.44	7/16-14	5/16	21722	11/32	3/16
3/8-16 3/8-24	1/2-13	21706 21707	5	.50	29/64	.51	1/2-13	3/8	21723	13/32	3/16
7/16-14 7/16-20	9/16-12	21708 21709	3	.56	33/64	.57	9/16-12	7/16	21724	15/32	3/16
1/2-13 1/2-20	5/8-11	21710 21711	3	.62	37/64	.63	5/8-11	1/2		17/32	3/16

HEAVY DUTY

5/8-11 5/8-18	7/8-14	21712 21713	1	.87	53/64	.88	7/8-14	5/8	21726	25/32	3/16
------------------	--------	----------------	---	-----	-------	-----	--------	-----	-------	-------	------

Quick, easy to remove
if necessary
with standard tools . . .

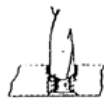

1. USE STANDARD DRILL to remove insert material between KEES.



2. Deflect KEES inward and break off.

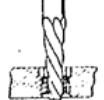

3. Remove insert with E-Z OUT type tool.



4. An identical insert can now be installed in the original hole.

THREAD REPAIR INSERTS

HELI-COIL PERMA-THREAD

- Made of stainless steel wire; rolled to a carefully controlled thread form.
- Inserts adjust to tapped hole with a strength **exceeding** the original threads.
- Used on aluminum, aluminum alloys, steel, and cast iron.
- **Repair kits** restore stripped, worn, damaged threads easily to a permanent stronger than original condition.



Heli-Coils

Repair kits

J&B #	SIZE	REACH	QTY	J&B #	SIZE	QTY
40104	1/4-20		12	40148	1/4-20	1
40105	5/16-18		12	40149	5/16-18	1
40106	3/8-16		12	40150	3/8-16	1
40107	7/16-14		6	40151	7/16-14	1
40108	1/2-13		6	40152	1/2-13	1
40109	9/16-12		6			
40110	5/8-11		6	40154	5/8-11	1
40111	3/4-10		4			
40112	7/8-9		1			
40113	1-8		1			
40117	7/16-20		6			
40081	5MM - .80		12	40091	5MM - .80	1
40119	6MM - 1.00		12	40156	6MM - 1.00	1
40121	8MM - 1.25		12	40157	8MM - 1.25	1
40095	10MM - 1.00	1/2"	6	40101	10MM - 1.00	1
40145	10MM - 1.25		12	40146	10MM - 1.25	1
40122	10MM - 1.50		12	40158	10MM - 1.50	1
40096	12MM - 1.25	1/2"	6	40102	12MM - 1.25	1
40123	12MM - 1.75		6	40159	12MM - 1.75	1
40097	14MM - 1.25	1/2"	6	40144	14MM - 1.25	1
40124	14MM - 2.00		6			
40099	18MM - 1.50	1/2"	6	40147	18MM - 1.50	1

Repair kits include:

- one pack of stainless steel inserts
- one high speed steel tap
- one installation tool



*** Part#'s 40095, 40096, 40097 & 40099 are Spark Plug Series and have a shorter reach. Repair kit part#'s 40101, 40102 and 40144 do not come with inserts.

INSTRUCTIONS:

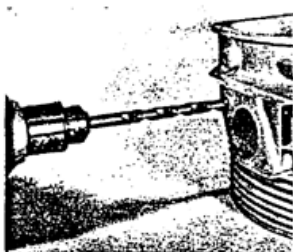

1. Drill out damaged threads.

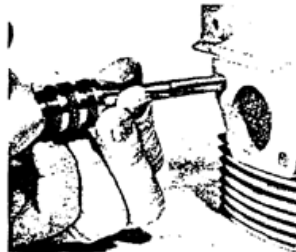

2. Tap new threads.

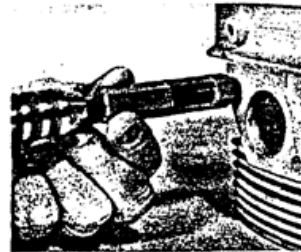

3. Install new Perma-Thread insert. (Prewinding tool shown is used for fine thread applications only.)

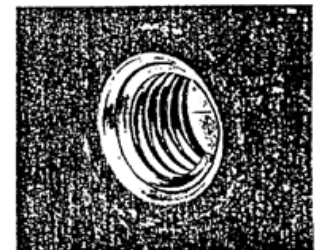

4. Remove tangs from insert. You now have a permanently repaired thread.

NUTSERTS

THINSHEET INSERTS

- Secures threads from one side of work in materials too thin to support them.
- Steel - Zinc Plated. **Exceeds** strength of matching bolt or screw.
- Heavier upper lip provides extra pressure relief on thin sheet metals and soft aluminum, brass, copper, and plastics.

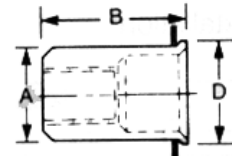

(Before Crimping)

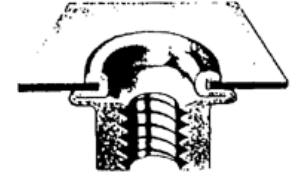

(After Crimping)

J&B #	SIZE	RECOMMENDED GRIP RANGE	A MAX.	B MAX.	D MAX.	DRILL SIZE	QTY
11307	6-32	.020 - .080	.249	.410	.287	1/4"	20
11308	8-32	.020 - .080	.249	.410	.287	1/4"	20
11309	10-32	.020 - .130	.280	.465	.320	9/32"	20
11312	10-24	.020 - .130	.280	.465	.320	9/32"	20
11313	1/4-20	.030 - .165	.347	.610	.415	3/8"	10
11314	5/16-18	.040 - .200	.499	.720	.540	1/2"	10
11804	3/8-16	.040 - .200	.499	.720	.540	1/2"	10
11800	M4-.70	.020 - .080	.249	.410	.287	1/4"	20
11801	M5-.80	.020 - .130	.280	.465	.320	9/32"	20
11802	M6-1.00	.030 - .165	.374	.610	.415	3/8"	10
11803	M8-1.25	.040 - .200	.499	.720	.540	1/2"	10

HOW IT WORKS:

1. The Thin Sheet Nutsert, held securely by the tool, is placed into a prepared hole.
2. Upon the tool's actuation, the threaded portion is pulled until the fastener's wall collapses radially outward, clinching it tight against the sheet.
3. The tool is withdrawn, leaving the Thin Sheet Nutsert ready to receive a bolt or screw.

LARGE FLANGE THINSHEET INSERTS

- Provides captive threads in materials too thin to independently support threads, or where costly tapping operations are to be eliminated.
- Can be used as a rivet to join materials that will ultimately have a separate component attached.
- Aluminum Alloy, Plain Finish.



J&B #	SIZE	RECOMMENDED GRIP RANGE	HOLE SIZE	DRILL SIZE	QTY
41965	8-32 U.S.S.	.010 - .075	.221-.226"	7/32	50

NUTSERTS

NUTSERT HAND TOOL



J&B #	QTY
11805	EA

(Hand Tool only)

NUTSERT KIT WITH TOOL

CONTAINS:

Hand Tool, Wrench,
and the following Conversion Kits:
6-32, 8-32, 10-24,
1/4-20, 5/16-18,
and a Mandrel only for size 10-32.
(Complete in Metal Case)



J&B #	QTY
11806	EA

CONVERSION KITS

J&B #	SIZE	QTY
11790	3/8-16	EA
11791	M4-.70	EA
11792	M5-.80	EA
11793	M6-1.00	EA
11794	M8-1.25	EA



FILES

ALL FILES ARE AMERICAN PATTERN (ENGINEERING)

FLAT FILES



SHAPE: Tapered in width and thickness. Double cut on both sides and single cut on edges.

USE: Favored for use in factories, machine shops, and garages because of its ability to work on iron, steel, etc. . . . and quick removal of stock from plain surfaces.

J&B #	LENGTH	CUT	QTY
39810	8"	BAST	EA
39811	10"	BAST	EA
39812	12"	BAST	EA
39813	12"	SMOOTH	EA

HALF ROUND FILES

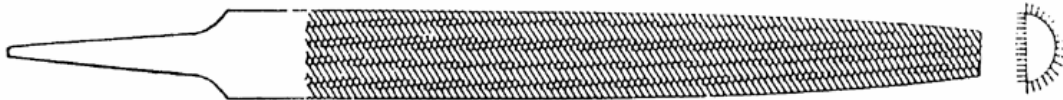

SHAPE: Round on one side and flat on the other. Both sides are double cut. The file tapers toward the point in both width and thickness.

USE: The half round side (front) makes this file ideal for getting into rounded holes, concave corners, crevices, etc. Also can be used on flat surfaces.

J&B #	LENGTH	CUT	QTY
39825	8"	BAST	EA
39826	10"	BAST	EA

MILL FILES



SHAPE: Tapers slightly in width. Sides and edges are single cut.

USE: This is the most commonly used file in the USA. It is suitable for workshops and sharpening mill or circular saws, hoes, axes, spades, shovels, etc. Also for draw filing and finishing metals.

J&B #	LENGTH	CUT	QTY
39835	8"	BAST	EA
39836	10"	BAST	EA
39837	12"	BAST	EA

FILES

ALL FILES ARE AMERICAN PATTERN (ENGINEERING)

ROUND FILES

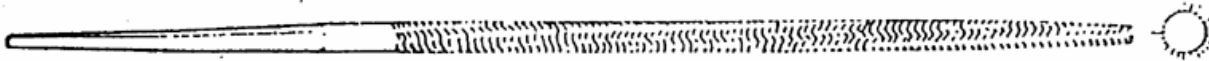

SHAPE: Shape tapers slightly toward point.

USE: Designed for enlarging circular holes, mouldings, concave surfaces, and rounded grooves.

J&B #	LENGTH	SIZE	CUT	QTY
39817	8"	5/16	BAST	EA
39818	10"	3/8	BAST	EA

THREE SQUARE FILES



SHAPE: Triangular as the Taper files, but double cut with sharp corners slightly set and single cut edges. Angles are 60° and tapers toward the point.

USE: For cleaning out corners, filing angles, taps and cutters. Also used on flat surfaces.

J&B #	LENGTH	SIZE	CUT	QTY
39831	10"	3/4	BAST	EA
39832	12"	27/32	BAST	EA

HANDY FILES



SHAPE: One side double cut for fast stock removal and one side single cut for smoother finishing. One edge single cut and one edge safe (uncut).

USE: Has many purposes such as sharpening hoes, lawn mower blades, sharpening metals and smoothing plastics.

J&B #	LENGTH	CUT	QTY
39805	8"	BAST	EA
39806	10"	BAST	EA

FILES

INDUSTRIAL HANDLES



- A handle for all “**tanged**” files.
- Made of durable plastic; these handles are long-lasting, hand comfortable, and no slip.

J&B #	DESCRIP	QTY
39840	6” & 8”	EA
39841	10” & 12”	EA

FILE BRUSH AND CARD

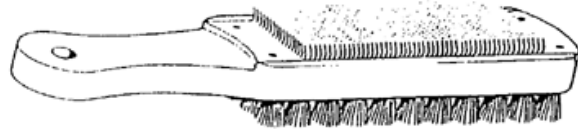

- Proper cleaning helps to prolong the life of a file.
- Use the brush side for general cleaning and the card side for stubborn clogging.

J&B #	QTY
39849	EA

CUTTING TOOLS

BRAKE LATHE BITS

- Replaceable carbide inserts maintain sharp cutting tools for optimum performance.
- For brake drum and disc lathes.
- Triangle brake lathe bits for Ammco and other machines.
- **Each box** comes with 10 screws and 10 triangular bits.

J&B #	A	B	C	QTY
39001	3/8"	7/64"	9/64"	10

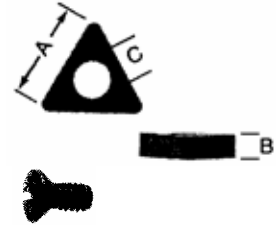

LET US HELP YOU MAKE THE CONNECTION

PART #3089

CARBIDE BURRS



J & B FLEET-INDUSTRIAL SUPPLY
PHONE: 330-821-6342
WWW.JBFLEET.COM

57016



57015



57012



57007



57005



57004



57002



57001



57018



57017



57014



57013



LET US HELP YOU MAKE THE CONNECTION

PART # 3083



EASY OUT / LEFT HAND DRILLS

J & B FLEET-INDUSTRIAL SUPPLY
PHONE: 330-821-6342

40891	40892	40894	40896	40898	40900
3/32"	1/8"	3/16"	1/4"	5/16"	3/8"
28131	28132	28133	28134	28135	28136
#1	#2	#3	#4	#5	#6

LET US HELP YOU MAKE THE CONNECTION

PART # 3044

SPIRAL & SQUARE SCREW EXTRACTORS



J & B FLEET-INDUSTRIAL SUPPLY
PHONE: 330-821-6342

28131 (# 1)	28132 (# 2)	28133 (# 3)	28134 (#4)	28135 (# 5)	28136 (# 6)
40722 (3/32 Bit)	40724 (1/8 Bit)	40728 (3/16 Bit)	40732 (1/4 Bit)	40733 (17/64 Bit)	40742 (13/32 Bit)
28141 (# 1)	28142 (# 2)	28143 (# 3)	28144 (# 4)	28145 (# 5)	11 EXTRATORS
40724 (1/8 Bit)	40728 (3/16 Bit)	40732 (1/4 Bit)	40736 (5/16 Bit)	40740 (3/8 Bit)	11 DRILL BITS



J&B Fleet - Industrial Supply











22428 Harrisburg-Westville Rd. Alliance, Ohio 44601 Phone: (330) 821-6342 Fax: (330) 821-0411

www.jbfleet.com

PART # 2236

RECIPROCATING BLADES



<p>3</p> <p style="text-align: center;">42158</p>  <p style="text-align: center;">6" 14 TPI METAL CUTTING</p>	<p>2</p> <p style="text-align: center;">42030</p>  <p style="text-align: center;">8" 14/10 TPI METAL CUTTING</p>	
<p>2</p> <p style="text-align: center;">42032</p>  <p style="text-align: center;">12" 14/10 METAL CUTTING</p>		
<p>2</p> <p style="text-align: center;">39224</p>  <p style="text-align: center;">6" 18 TPI METAL CUTTING</p>	<p>2</p> <p style="text-align: center;">42034</p>  <p style="text-align: center;">8" 18 TPI METAL CUTTING</p>	
<p>3</p> <p style="text-align: center;">39220</p>  <p style="text-align: center;">3" 24 TPI METAL CUTTING</p>	<p>3</p> <p style="text-align: center;">42157</p>  <p style="text-align: center;">3-5/8" 14 TPI METAL CUTTING</p>	<p>3</p> <p style="text-align: center;">ZZNS266</p>  <p style="text-align: center;">6" 6 TPI FIBERGLASS CUTTING</p>
<p>2</p> <p style="text-align: center;">42036</p>  <p style="text-align: center;">6" 6TPI WOOD CUTTING</p>	<p>2</p> <p style="text-align: center;">42037</p>  <p style="text-align: center;">9" 6 TPI WOOD CUTTING</p>	
<p>2</p> <p style="text-align: center;">42038</p>  <p style="text-align: center;">12" 6 TPI WOOD CUTTING</p>		



LET US HELP YOU MAKE THE CONNECTION

PART # 3042

RECIPROCATING BLADES



J & B FLEET-INDUSTRIAL SUPPLY
PHONE: 330-821-6342

<p>42158</p> <p>6" LENGTH 14 TEETH</p> <p>BI-METAL</p> <p>For metals heavier than 1/8, bar stock, angles, etc. Also rubber, Masonite, wood, etc.</p> <p>4</p>	<p>39224</p> <p>6" LENGTH 18 TEETH</p> <p>BI-METAL</p> <p>Heavy gauge sheet metal, conduit pipe, tubing, thin fiberglass.</p> <p>4</p>	<p>39220</p> <p>3" LENGTH 24 TEETH</p> <p>BI-METAL</p> <p>Thin sheet metal, scroll cutting.</p> <p>4</p>	<p>42157</p> <p>3-5/8 LENGTH 14 TEETH</p> <p>BI-METAL</p> <p>Heavy gauge metals, fiberglass, Masonite scroll cutting</p> <p>4</p>	<p>42036</p> <p>6" LENGTH 6 TEETH</p> <p>BI-METAL</p> <p>For wood and nail-embedded woods, all composition material. Also non-ferrous metals.</p> <p>4</p>	
----------------------------------------------------------------------------------------------------------------------------------------------------------------------------------------	-----------------------------------------------------------------------------------------------------------------------------------------------------------------	-----------------------------------------------------------------------------------------------------------------------------------	------------------------------------------------------------------------------------------------------------------------------------------------------------	-------------------------------------------------------------------------------------------------------------------------------------------------------------------------------------	--



J&B Fleet - Industrial Supply

www.jbfleet.com

22428 Harrisburg-Westville Rd. Alliance, Ohio 44601 Phone: (330) 821-6342 Fax: (330) 821-0411

PART # 2176

HOLE SAWS

<p>39264 1/4 ROUND ARBOR</p>  <p>39269 REPLACEMENT PILOT BIT</p>  <p>1 EA</p>	<p>39266 2</p>  <p>7/16 HEX ARBOR</p> <p>1 (FOR 1" TO 1-1/8" HOLE SAWS)</p>	<p>39268 3</p>  <p>7/16 HEX ARBOR</p> <p>1 (FOR 1-1/4" TO 3" HOLE SAWS)</p>	<p>39240 4</p>  <p>3/4"</p> <p>1</p>
<p>39242 5</p>  <p>7/8"</p> <p>1</p>	<p>39244 6</p>  <p>1"</p> <p>1</p>	<p>39246 7</p>  <p>1-1/8"</p> <p>1</p>	<p>39248 8</p>  <p>1-1/4"</p> <p>1</p>
<p>39250 9</p>  <p>1-3/8"</p> <p>1</p>	<p>39252 10</p>  <p>1-1/2"</p> <p>1</p>	<p>39254 11</p>  <p>1-3/4"</p> <p>1</p>	<p>39256 12</p>  <p>2"</p> <p>1</p>
<p>39257 13</p>  <p>2-1/8"</p> <p>1</p>	<p>39258 14</p>  <p>2-1/4"</p> <p>1</p>	<p>39260 15</p>  <p>2-1/2"</p> <p>1</p>	<p>39262 16</p>  <p>3"</p> <p>1</p>

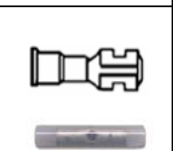



J&B Fleet - Industrial Supply

22428 Harrisburg-Westville Rd. Alliance, Ohio 44601 Phone: (330) 821-6342 Fax: (330) 821-0411

www.jbfleet.com

PART # 2194

HOLE SAWS

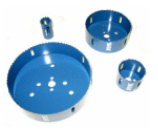

39264
1/4" ROUND ARBOR
FOR 9/16" TO 1-3/16' HOLE SAWS



39266
7/16" HEX ARBOR
FOR 9/16" TO 1-3/16' HOLE SAWS



39268
7/16" HEX ARBOR
FOR 1-1/4" TO 6" HOLE SAWS



39269
REPLACEMENT PILOT BIT
(1 OF EACH)



39238
5/8"



39240
3/4"



39242
7/8"



39244
1"



39246
1-1/8"



39248
1-1/4"



39249
1-5/16"



39250
1-3/8"



39252
1-1/2"



39253
1-5/8"



39254
1-3/4"



39255
1-7/8"



39256
2"

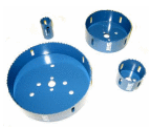



J&B Fleet - Industrial Supply









www.jbfleet.com

22428 Harrisburg-Westville Rd. Alliance, Ohio 44601 Phone: (330) 821-6342 Fax: (330) 821-0411

PART # 2195

HOLE SAWS



<p>1</p> <p>39257</p>  <p>2-1/8</p>	<p>1</p> <p>39261</p>  <p>2-3/4</p>	<p>1</p> <p>39263</p>  <p>3-1/2</p>	
<p>1</p> <p>39258</p>  <p>2-1/4</p>	<p>1</p> <p>39262</p>  <p>3"</p>	<p>1</p> <p>39234</p>  <p>4"</p>	
<p>1</p> <p>39259</p>  <p>2-3/8</p>			
<p>1</p> <p>39260</p>  <p>2-1/2</p>			



J&B Fleet - Industrial Supply























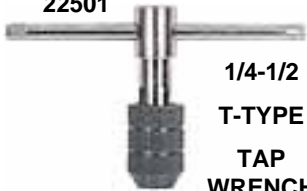

22428 Harrisburg-Westville Rd. Alliance, Ohio 44601 Phone: (330) 821-6342 Fax: (330) 821-0411

www.jbfleet.com

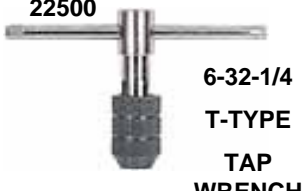
PART # 2148

TAP & DIE SET



38168 1 	38169 2 	38170 3 	38171 4 	5	41040 21 
1/8 PIPE TAP	1/4 PIPE TAP	3/8 PIPE TAP	1/2 PIPE TAP		6-32-1/2 HEX DIE STOCK
24790 TAP 6 	41015 7 	41017 8 	9	10	
41013 HEX DIE 	7/16-14 HEX DIE	1/2-13 HEX DIE			
3/8-16					
24784 TAP 11 	24796 TAP 12 	24802 TAP 13 	14	15	22501 
41011 HEX DIE 	7/16-14 TAP	1/2-13 TAP			1/4-1/2 T-TYPE TAP WRENCH
5/16-18					
38150 TAP 16 	38153 TAP 17 	38156 TAP 18 	38159 TAP 19 	24778 TAP 20 	22500 
41003 HEX DIE 	41004 HEX DIE 	41005 HEX DIE 	41006 HEX DIE 	41009 HEX DIE 	6-32-1/4 T-TYPE TAP WRENCH
6-32	8-32	10-24	10-32	1/4-20	

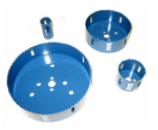



J&B Fleet - Industrial Supply

www.jbfleet.com

22428 Harrisburg-Westville Rd. Alliance, Ohio 44601 Phone: (330) 821-6342 Fax: (330) 821-0411

PART # 2150

TAP & DIE SET

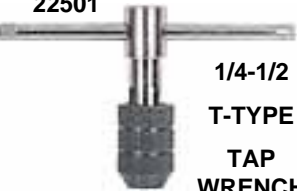
<p>38168 ¹</p> 	<p>38169 ²</p> 	<p>38170 ³</p> 	<p>38171 ⁴</p> 	<p>38640 ⁵</p> 	<p>41042</p>  <p>9/16-3/4 HEX DIE STOCK</p>	<p>41040 ²¹</p>  <p>6-32-1/2 HEX DIE STOCK</p>
<p>1/8 PIPE TAP</p>	<p>1/4 PIPE TAP</p>	<p>3/8 PIPE TAP</p>	<p>1/2 PIPE TAP</p>	<p>3/4 PIPE TAP</p>		
<p>24790 TAP ⁶</p> 	<p>41015 ⁷</p> 	<p>41017 ⁸</p> 	<p>41021 ⁹</p> 	<p>41023 ¹⁰</p> 		
<p>41013 HEX DIE</p> <p>3/8-16</p>	<p>7/16-14 HEX DIE</p>	<p>1/2-13 HEX DIE</p>	<p>5/8-11 HEX DIE</p>	<p>3/4-10 HEX DIE</p>		
<p>24784 TAP ¹¹</p> 	<p>24796 ¹²</p> 	<p>24802 ¹³</p> 	<p>24808 ¹⁴</p> 	<p>24811 ¹⁵</p> 		
<p>41011 HEX DIE</p> <p>5/16-18</p>	<p>7/16-14 TAP</p>	<p>1/2-13 TAP</p>	<p>5/8-11 TAP</p>	<p>3/4-10 TAP</p>		
<p>38150 TAP ¹⁶</p> 	<p>38153 TAP ¹⁷</p> 	<p>38156 TAP ¹⁸</p> 	<p>38159 TAP ¹⁹</p> 	<p>24778 TAP ²⁰</p> 	<p>22501</p>  <p>1/4-1/2 T-TYPE TAP WRENCH</p>	
<p>41003 HEX DIE</p> <p>6-32</p>	<p>41004 HEX DIE</p> <p>8-32</p>	<p>41005 HEX DIE</p> <p>10-24</p>	<p>41006 HEX DIE</p> <p>10-32</p>	<p>41009 HEX DIE</p> <p>1/4-20</p>	<p>22500</p>  <p>6-32-1/4 T-TYPE TAP WRENCH</p>	

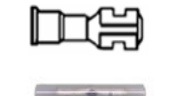

LET US HELP YOU MAKE THE CONNECTION

PART # 3043



PIPE TAPS



J & B FLEET-INDUSTRIAL SUPPLY
PHONE: 330-821-6342

38168

38169

38170

38171

38640

38641

1/8

1/4

3/8

1/2

3/4

1"

1

1

1

1

1

1

















J&B Fleet - Industrial Supply

22428 Harrisburg-Westville Rd. Alliance, Ohio 44601 Phone: (330) 821-6342 Fax: (330) 821-0411

www.jbfleet.com

PART # 2055

KEENSERTS

<p>21706 1</p>  <p>3/8-16 29/64 DRILL 4 1/2-13 TAP</p>	<p>21707 2</p>  <p>3/8-24 29/64 DRILL 4 1/2-13 TAP</p>	<p>21712 3</p>  <p>5/8-11 53/64 DRILL 2 7/8-14 TAP</p>	<p>21713 4</p>  <p>5/8-18 53/64 DRILL 2 7/8-14 TAP</p>	<p>5</p>
<p>21704 7</p>  <p>5/16-18 X DRILL 4 7/16-14 TAP</p>	<p>21705 8</p>  <p>5/16-24 X DRILL 3 7/16-14 TAP</p>	<p>9</p>	<p>10</p>	<p>11</p>
<p>21702 13</p>  <p>1/4-20 Q DRILL 4 3/8-16 TAP</p>	<p>21703 14</p>  <p>1/4-28 Q DRILL 3 3/8-16 TAP</p>	<p>21710 15</p>  <p>1/2-13 37/64 DRILL 3 5/8-11 TAP</p>	<p>21711 16</p>  <p>1/2-20 37/64 DRILL 3 5/8-11 TAP</p>	<p>17</p>
<p>21700 19</p>  <p>10-24 I DRILL 5 5/16-18 TAP</p>	<p>21701 20</p>  <p>10-32 I DRILL 5 5/16-18 TAP</p>	<p>21708 21</p>  <p>7/16-14 33/64 DRILL 3 9/16-12 TAP</p>	<p>21709 22</p>  <p>7/16-20 33/64 DRILL 3 9/16-12 TAP</p>	<p>23</p>



1
DRILL OUT OLD THREADS, USING STANDARD DRILL.

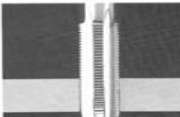

2
TAP NEW THREADS, USING STANDARD TAP.

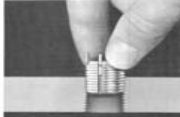

3
SCREW IN INSERT UNTIL SLIGHTLY BELOW SURFACE.



4
DRIVE "KEES" DOWN W/SEVERAL TAPS ON INSTALLATION TOOL.



5
INSTALLED INSERT.



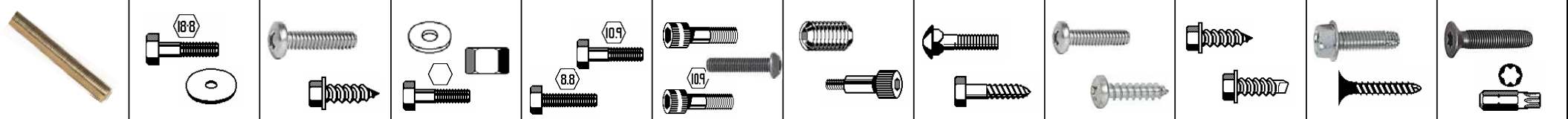

















J&B Fleet - Industrial Supply

22428 Harrisburg-Westville Rd. Alliance, Ohio 44601 Phone: (330) 821-6342 Fax: (330) 821-0411

www.jbfleet.com

PART # 2053

HELI-COILS

1	40104  1/4-20 4	40105  5/16-18 4	40106  3/8-16 4	40107  7/16-14 3	40108  1/2-13 3
7	40109  9/16-12 2	40110  5/8-11 2	40111  3/4-10 2	40112  7/8-9 1	40113  1-8 1
13	14	15	16	40117  7/16-20 2	18
19	40119  6MM X 1.00 4	40121  8MM X 1.25 3	40122  10MM X 1.50 3	40123  12MM X 1.75 2	40124  14MM X 2.00 1

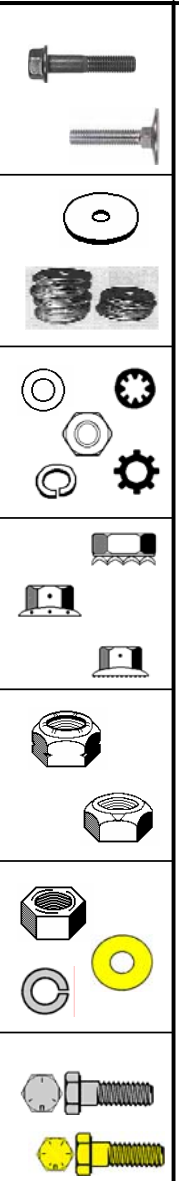

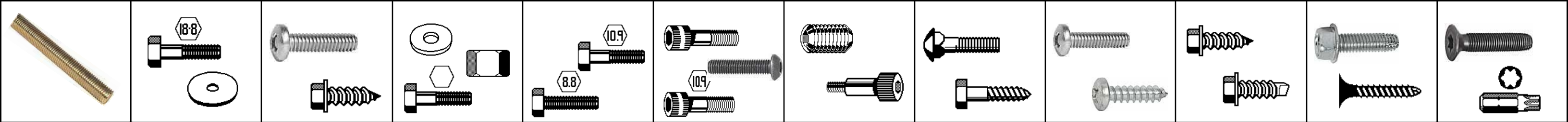









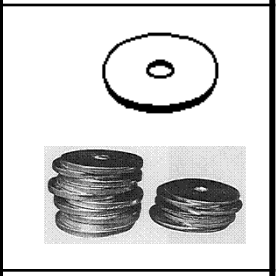
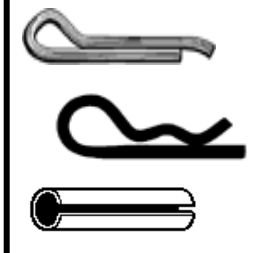



J&B Fleet - Industrial Supply
 22428 Harrisburg-Westville Rd. Alliance, Ohio 44601 Phone: (330) 821-6342 Fax: (330) 821-0411

www.jbfleet.com

PART # 2822

NUTSERTS



<p>11791 1</p> <p>4 MM x .70 CONVERSION KIT</p> <p>1</p>	<p>11792 2</p> <p>5MM-.80 CONVERSION KIT</p> <p>1</p>	<p>11793 3</p> <p>6MM-1.00 CONVERSION KIT</p> <p>1</p>	<p>11794 4</p> <p>8MM-1.25 CONVERSION KIT</p> <p>1</p>	<p>5</p>	<p>11806 21</p>  <p>NUTSERT TOOL KIT</p>
<p>11800 6</p>  <p>4 MM x .70</p> <p>10</p>	<p>11801 7</p>  <p>5 MM x .80</p> <p>10</p>	<p>11802 8</p>  <p>6 MM x 1.00</p> <p>10</p>	<p>11803 9</p>  <p>8 MM x 1.25</p> <p>10</p>	<p>10</p>	
<p>11314 11</p>  <p>5/16-18</p> <p>10</p>	<p>11804 12</p>  <p>3/8-16</p> <p>10</p>	<p>11790 13</p> <p>3/8-16 CONVERSION KIT</p> <p>1</p>	<p>14</p>	<p>15</p>	
<p>11307 16</p>  <p>6-32</p> <p>10</p>	<p>11308 17</p>  <p>8-32</p> <p>10</p>	<p>11312 18</p>  <p>10-24</p> <p>10</p>	<p>11309 19</p>  <p>10-32</p> <p>10</p>	<p>11313 20</p>  <p>1/4-20</p> <p>10</p>	

