

POLY #2 WATER COOLED CABINET

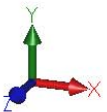

FRONT

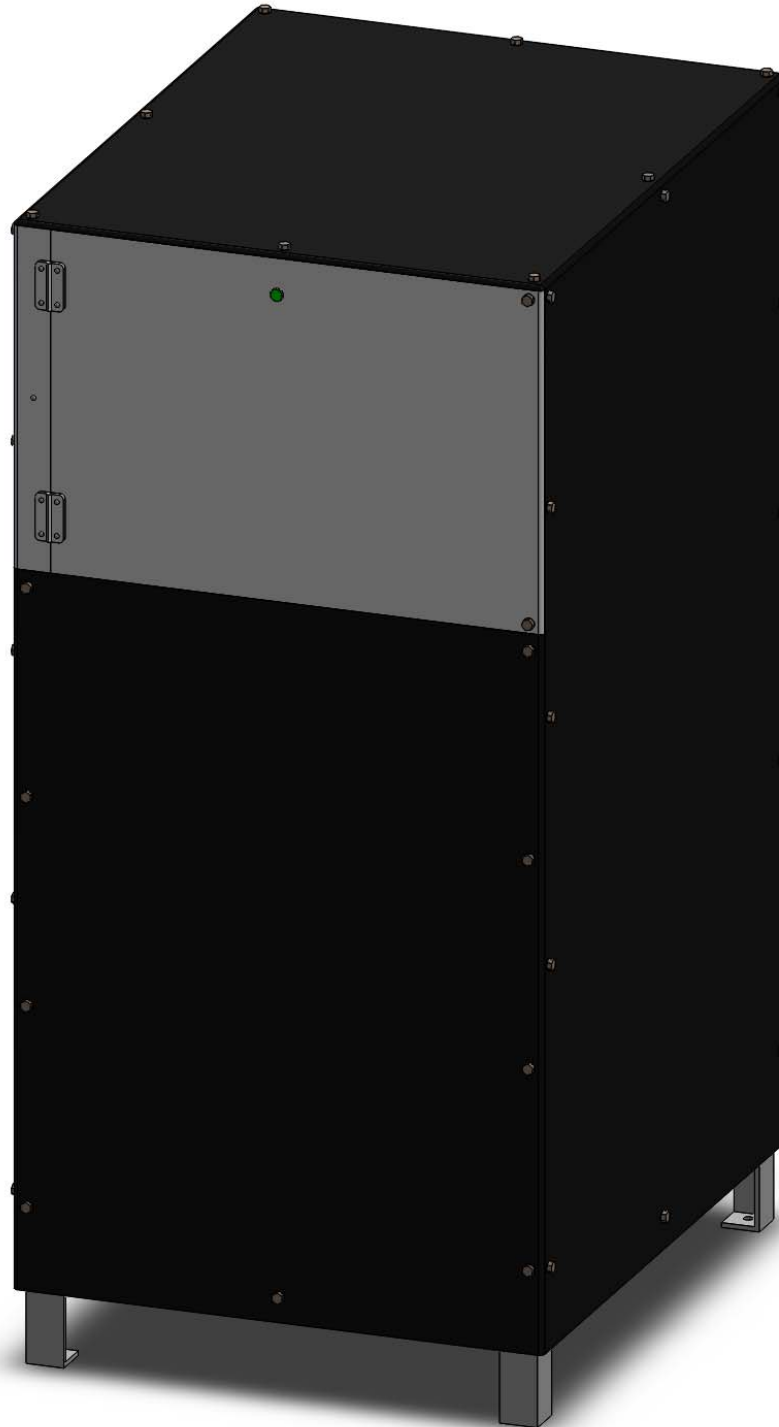
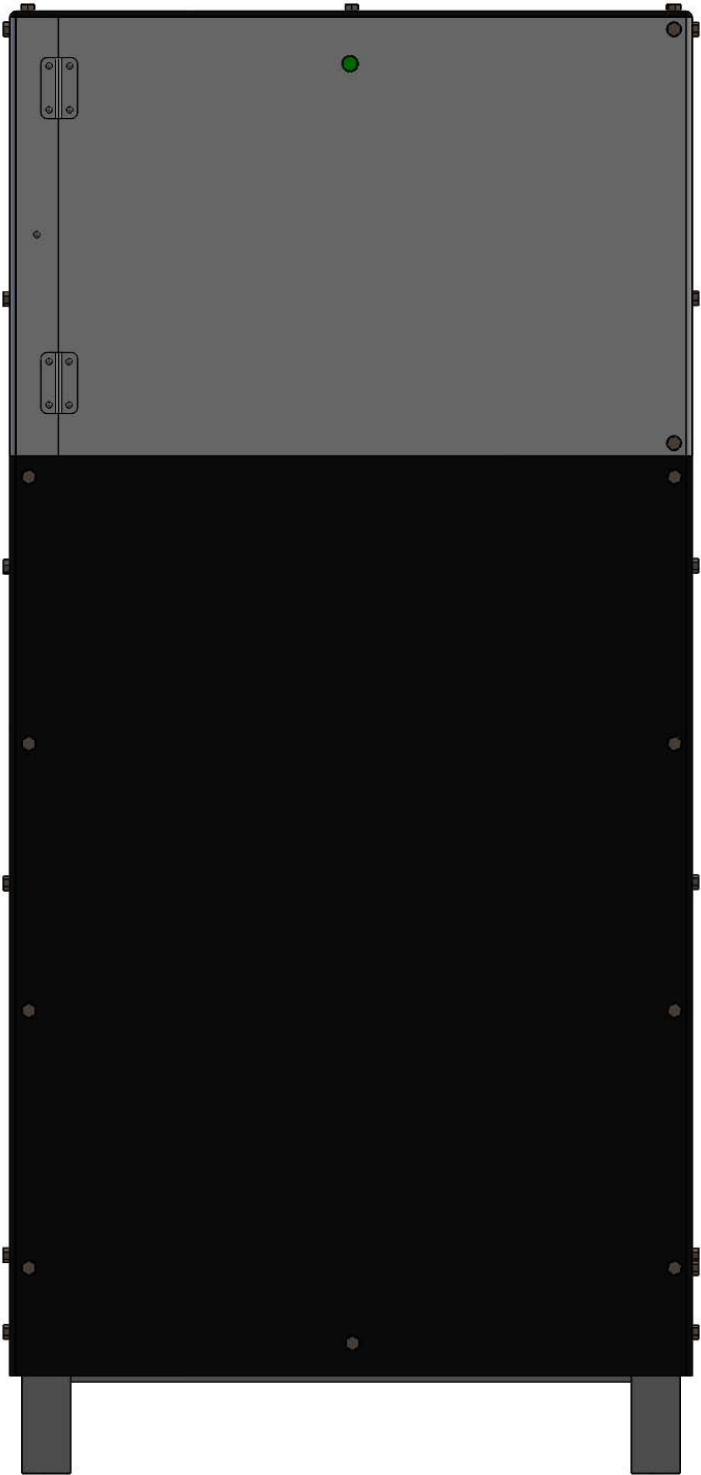

RIGHT

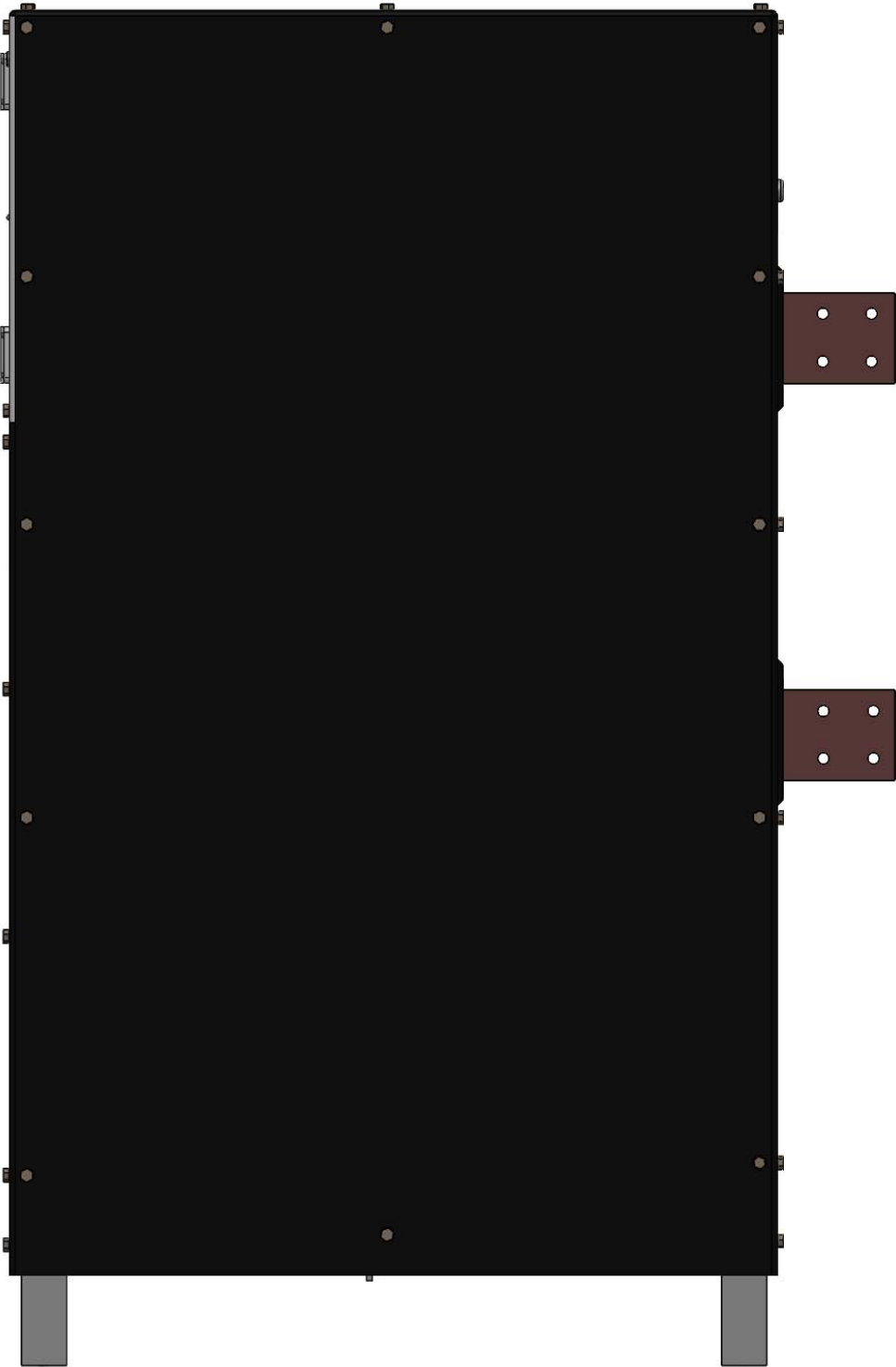

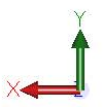
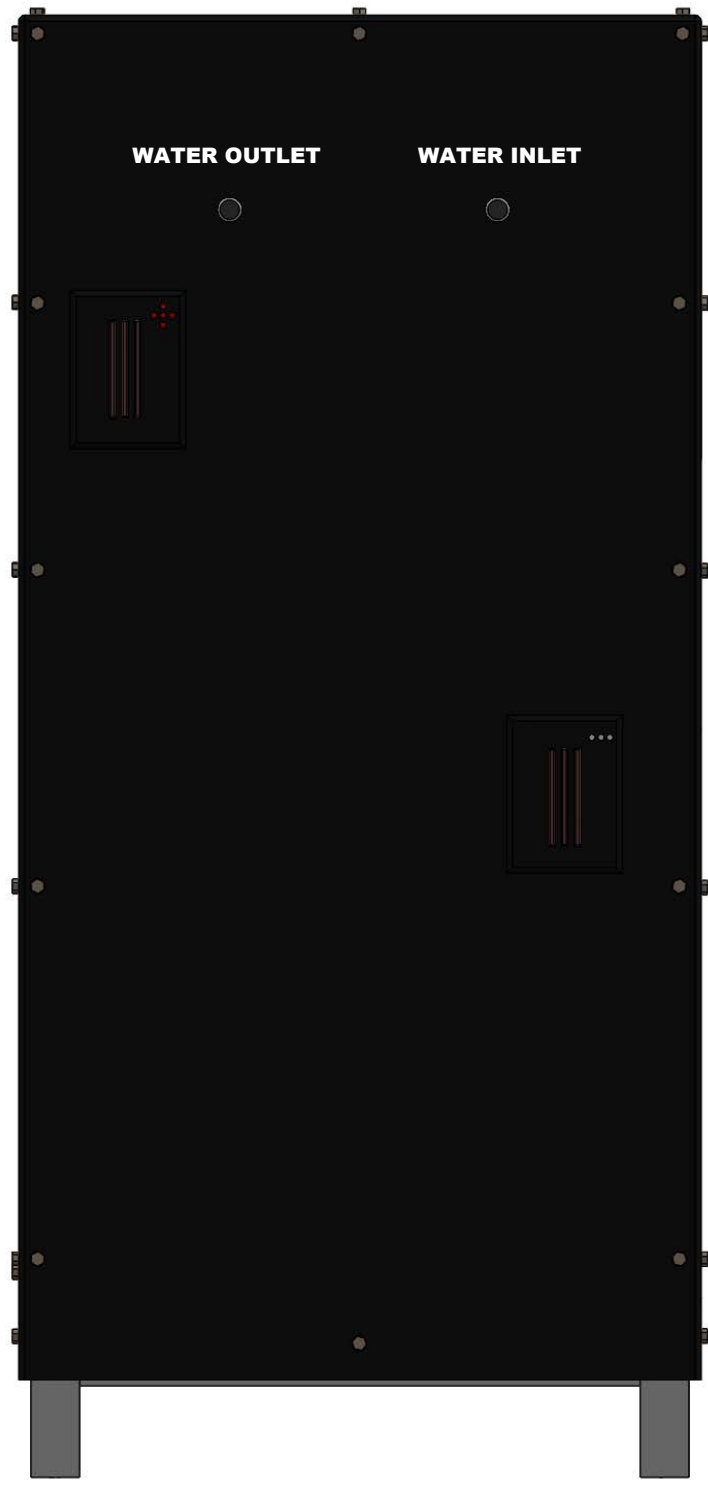

LEFT

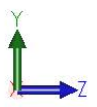
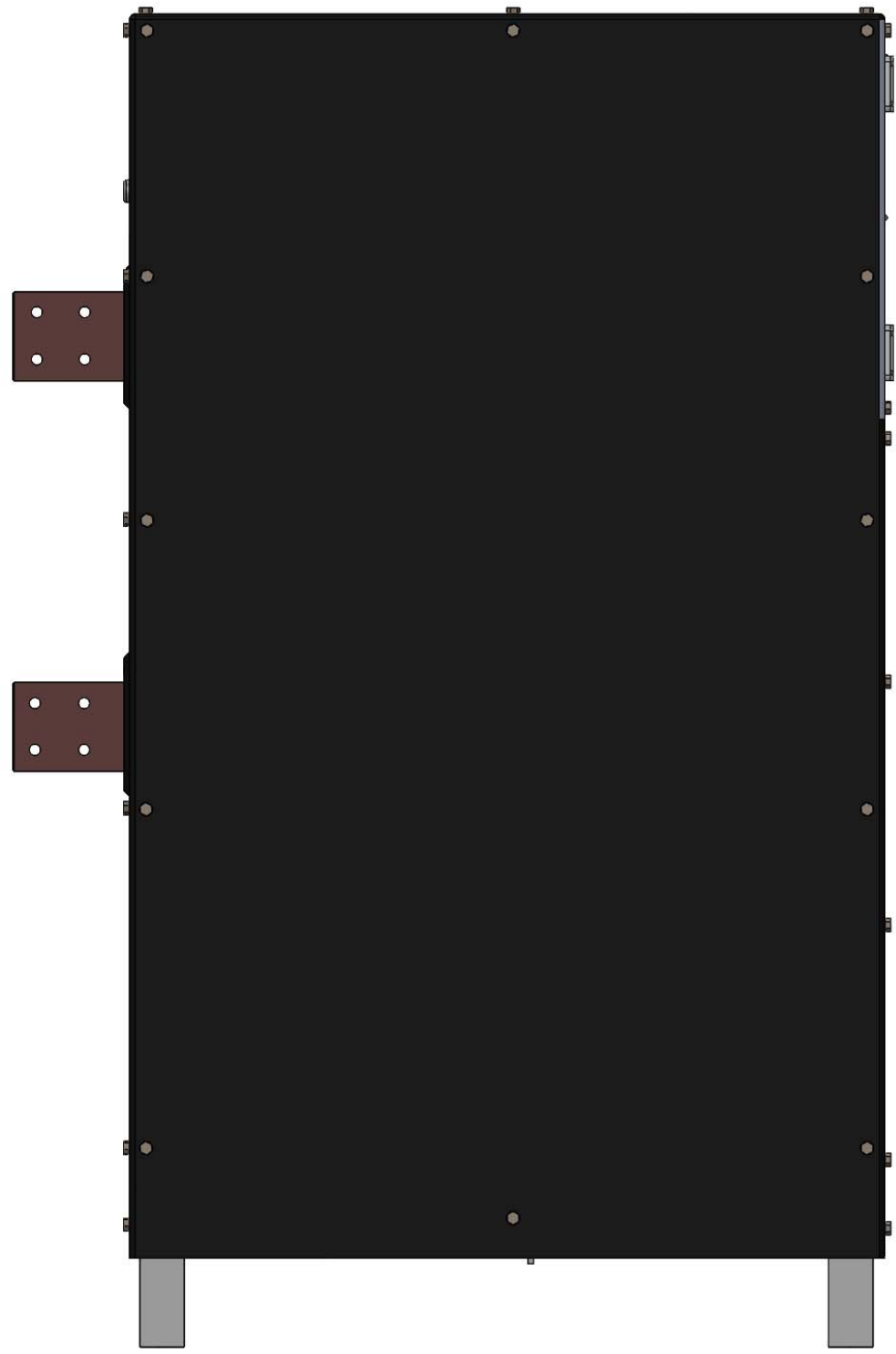

TOP

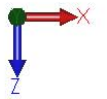
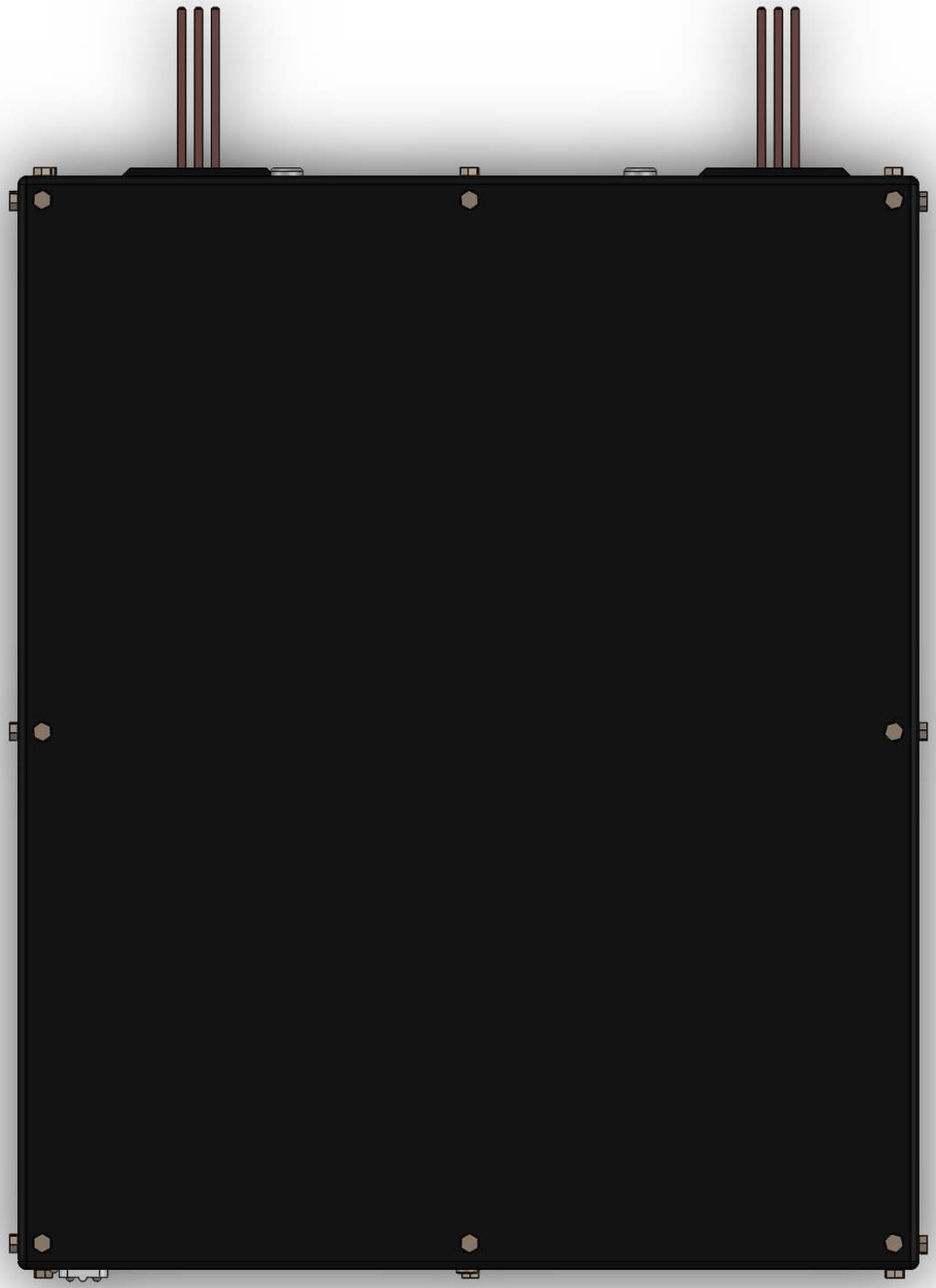

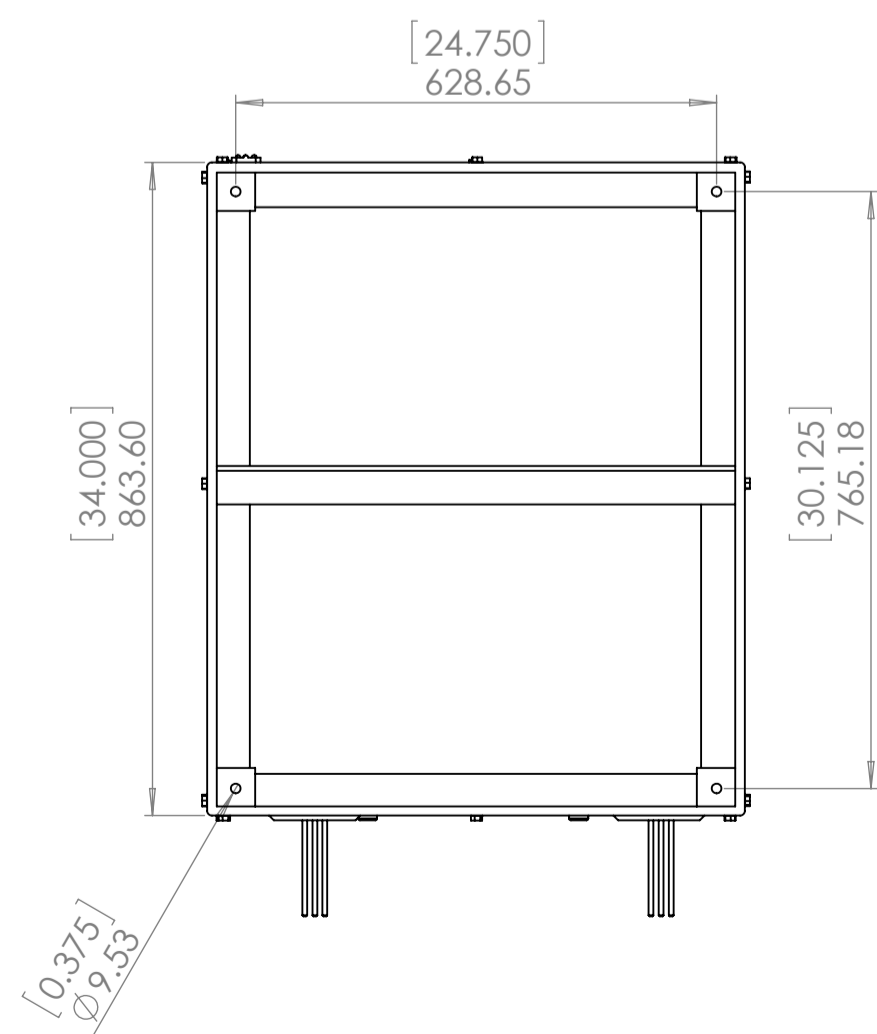
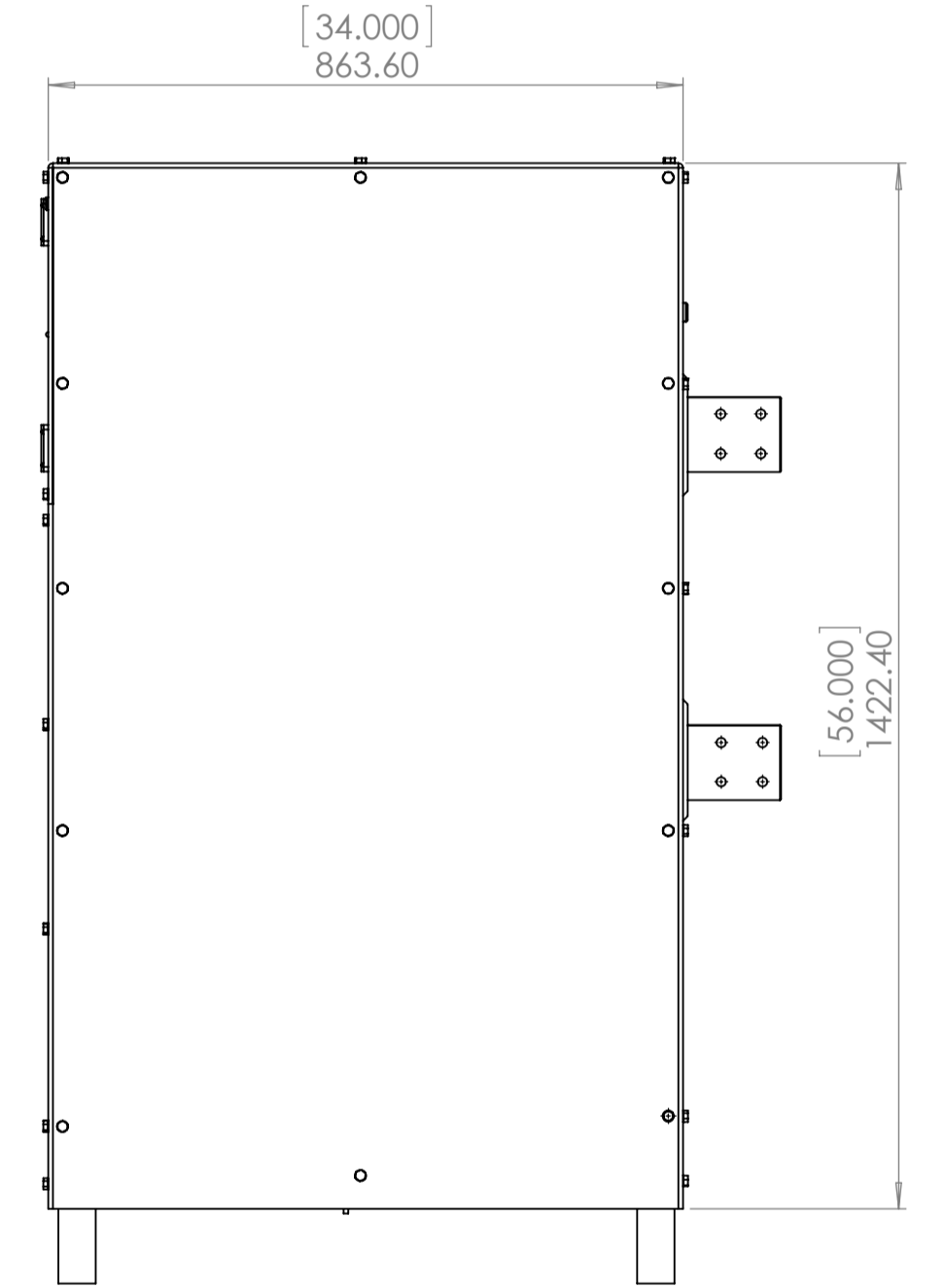
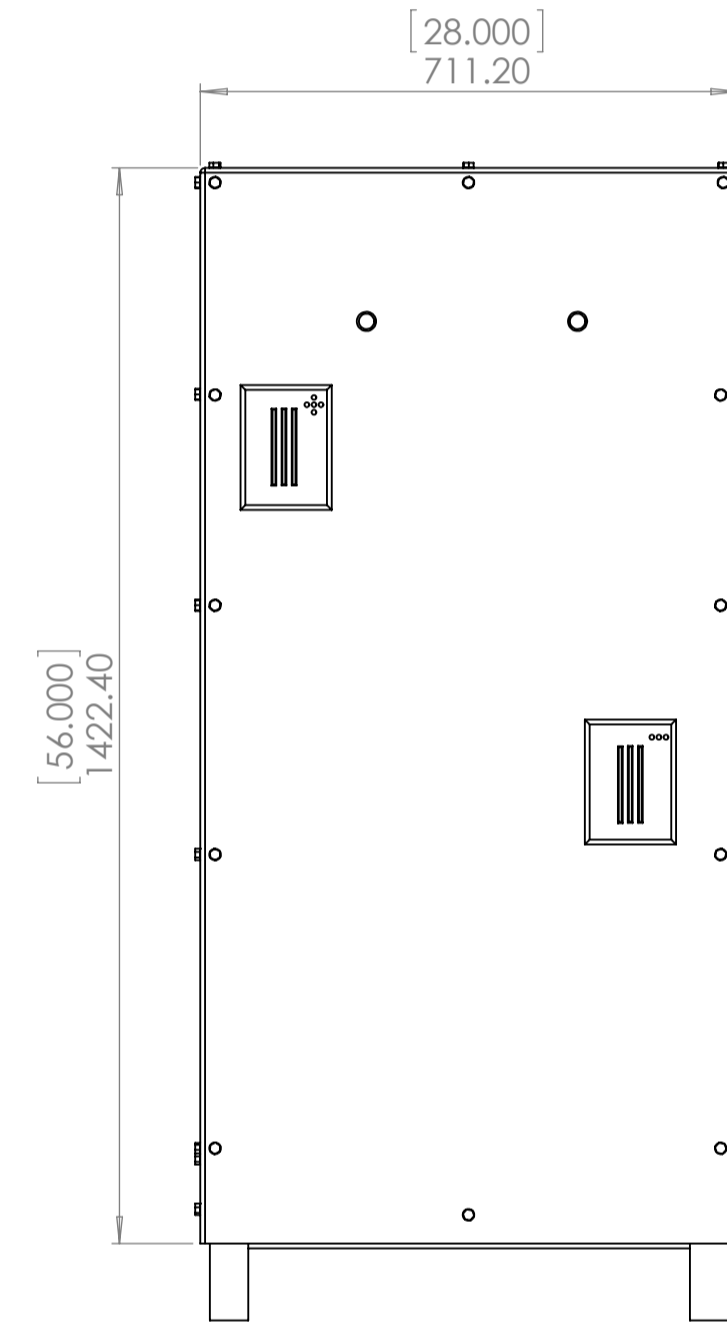
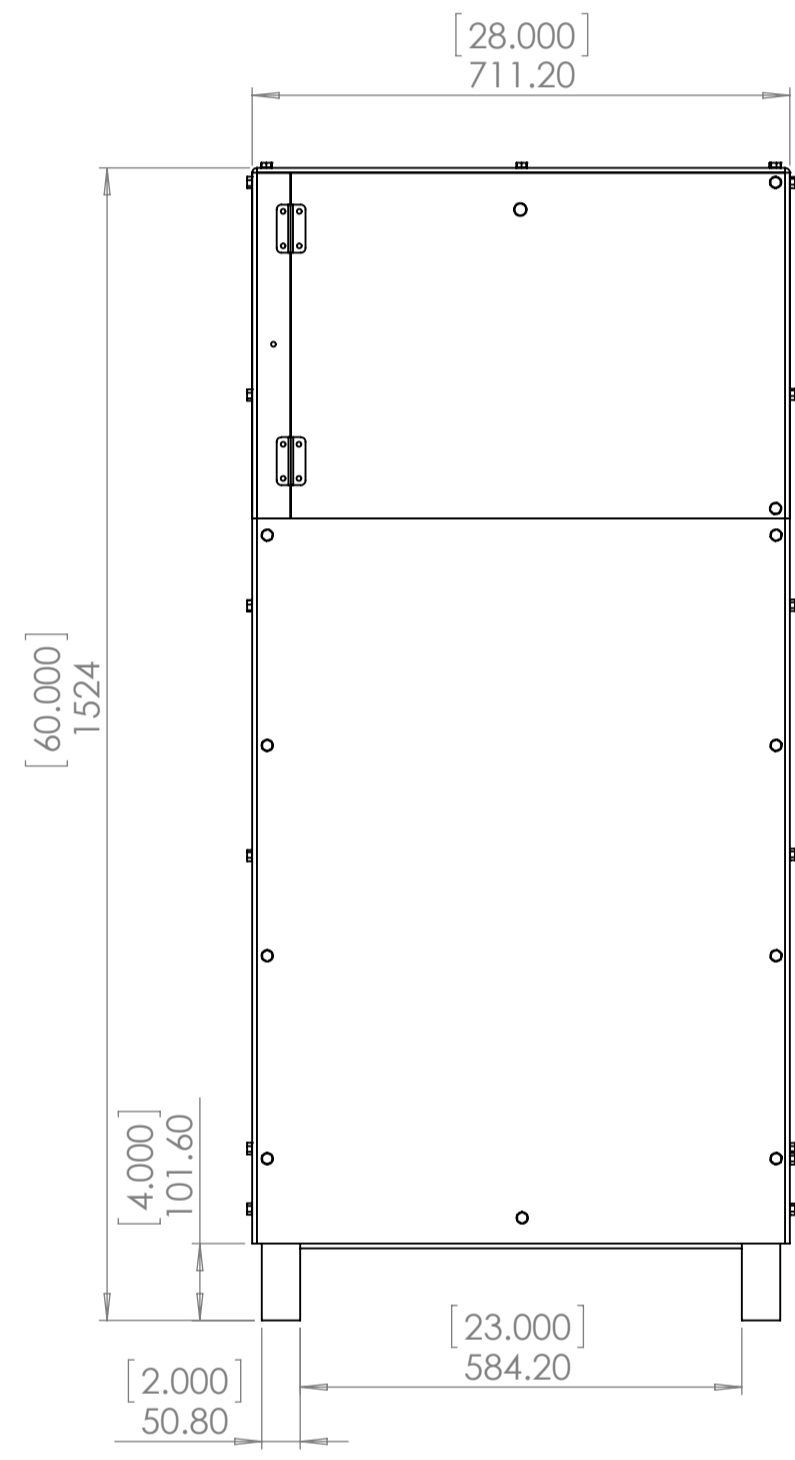
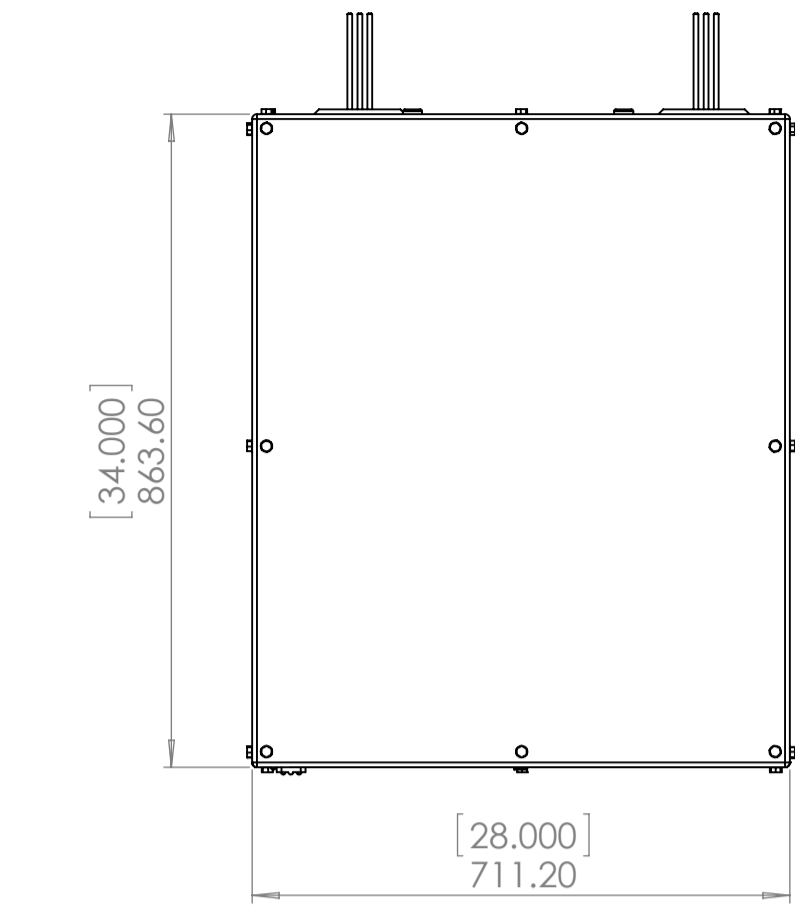
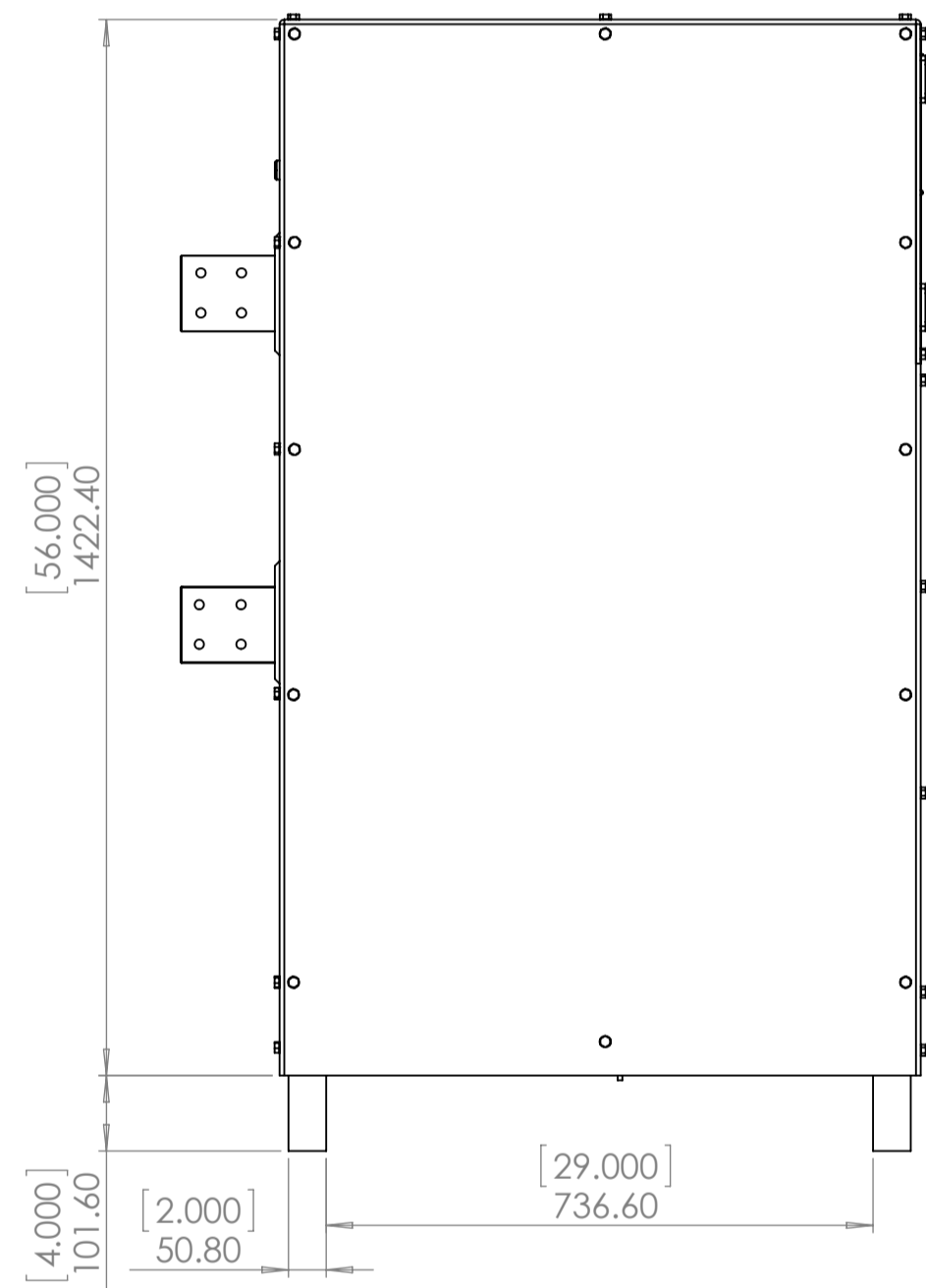

UNLESS OTHERWISE SPECIFIED: DIMENSIONS ARE IN MILLIMETERS			FINISH:	DEBUR AND BREAK SHARP EDGES	DO NOT SCALE DRAWING	REVISION
SURFACE FINISH:					ALDONEX, INC.	
TOLERANCES:					TITLE: ENCLOSURE	
LINEAR:						
ANGULAR:						
DRAWN	NAME	SIGNATURE	DATE			
CHK'D	SO		6-12-19			
APP'VD:						
MFG						
Q.A.				MATERIAL: POLY	DWG NO. P-2W CABINET	A1
				WEIGHT:	SCALE: 1:10	SHEET 1 OF 1