

Description

Q-Tech's 5x7mm high temperature clock oscillators consist of an IC operating at various supply voltages from 1.8V, 2.5V, 3.3V, and 5.0Vdc and a miniature strip quartz crystal for operating temperatures from -55°C to +250°C. The series is offered in various ceramic package configurations from true Surface-Mount SMT to straight leads and formed leads. This is the smallest package offered with a four-point crystal mount for high shock and high reliability down-hole and avionics applications. All high temperature parts will be assigned with a Q-Tech custom MCM part number unique for each application.

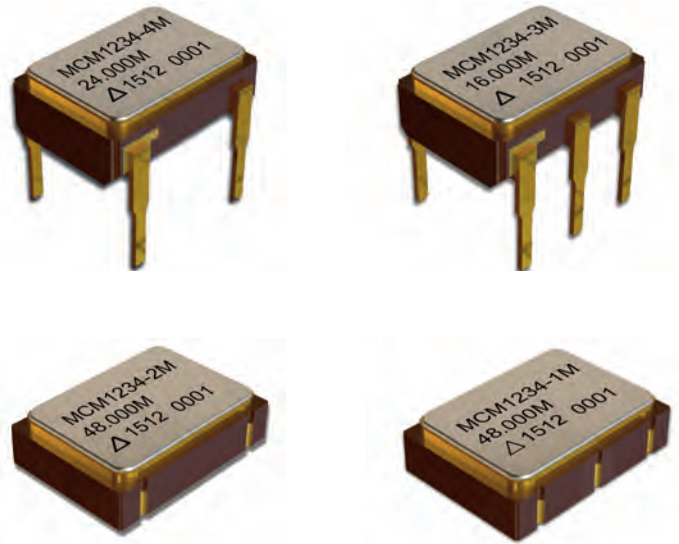

Features

- Made in the USA
- ECCN: EAR99
- Innovative Four Point Mount Strip Crystal Resonator
- Broad Frequency Range, 250kHz to 100MHz
- Small Footprint
- CMOS, LVHCMOS, TTL Logic
- Various Supply Voltages, 1.8Vdc to 5.0Vdc
- Wide Operating Temperature Range, -55°C to +250°C
- Tri-State Output (Option D)
- Hermetically sealed package
- Fundamental and 3rd Overtone Designs
- Full or Partial Screening per MIL-PRF-55310, Level B
- High Shock Resistant Tested Up to 20,000g Mechanical Shock, Half-Sine, 0.3ms, All Axes
- Tape and Reel or tubing Packaging
- Optional Hot Solder Dip, Sn60Pb40 or SAC305
- RoHS Compliant

Applications

- Designed to Meet High Shock Requirements
- High temperature Avionics
- Measurement while drilling, data-logging tools
- Oil service industry

Ordering Information

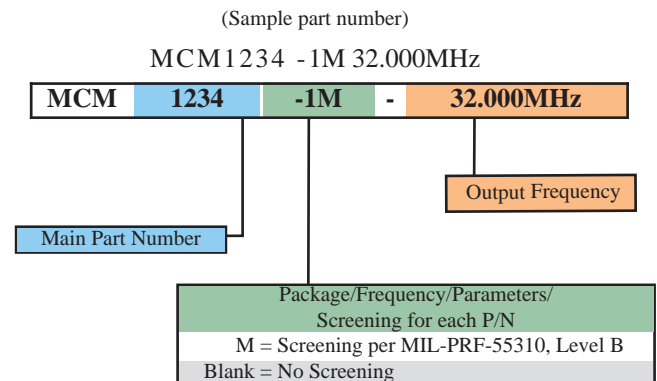

HIGH TEMPERATURE CLOCK OSCILLATORS SUPPLY VOLTAGE OFFERINGS:

SUPPLY VOLTAGE (VDD)	FREQUENCY RANGE	SUPPLY CURRENT (mA)	OPERATING TEMPERATURE (°C)	COMMENTS
1.8V ± 10%	250kHz – 40MHz	3mA max.	-55°C to +175°C	Please contact for higher temperature up to +200°C
2.5V ± 10%	250kHz – 40MHz	3mA max.	-55°C to +175°C	Please contact for higher temperature up to +200°C
3.3V ± 10%	250kHz – 100MHz	1mA to 10mA max. (Frequency dependent)	-55°C to +225°C	Please contact for higher temperature up to +250°C
5.0V ± 10%	250kHz – 66MHz	3mA to 20mA max. (Frequency dependent)	-55°C to +225°C	Please contact for higher temperature up to +250°C

HIGH TEMPERATURE CLOCK OSCILLATORS LOW POWER OFFERINGS:

SUPPLY VOLTAGE (VDD)	FREQUENCY RANGE	SUPPLY CURRENT (mA)	OPERATING TEMPERATURE (°C)	COMMENTS
1.8V ± 10%	16MHz – 48MHz	0.8mA typ., 1.4mA max.	-55°C to +175°C	Please contact for higher temperature up to +200°C
2.5V ± 10%	16MHz – 60MHz	2mA typ., 4mA max.	-55°C to +175°C	Please contact for higher temperature up to +200°C
3.3V ± 10%	16MHz – 70MHz	2mA to 5mA max. (Frequency dependent)	-55°C to +200°C	

HIGH TEMPERATURE CLOCK OSCILLATORS HIGH SHOCK OFFERINGS (4-POINT MOUNT):

MOUNTING METHOD	DESCRIPTION	GENERIC P/N	COMMENTS
2-POINT	STANDARD	QTXX (See package numbering)	Tested up 10,000g mechanical shock, half-sine 0.1ms, tested on 24MHz and 32MHz 5x7mm
4-POINT	OPTION	QTXXF (See package numbering)	Tested up 20,000g mechanical shock, half-sine 0.1ms tested on a 32.000MHz 5x7mm
Please consult factory for high frequencies with high shock resistant			

HIGH TEMPERATURE CLOCK OSCILLATORS FREQUENCY STABILITY OFFERINGS:

FREQUENCY STABILITY	OPERATING TEMPERATURE	COMMENTS	OPERATING TEMP. EXTENSION
±250ppm max.	0°C to +200°C or lower	STANDARD	-55°C to +200°C
±200ppm max.	0°C to +200°C or lower	CUSTOM	-55°C to +200°C
±450ppm max.	0°C to +225°C or lower	STANDARD	-55°C to +225°C
±350ppm max.	0°C to +225°C or lower	CUSTOM	-55°C to +225°C
±185ppm max.	0°C to +185°C or lower	CUSTOM	-20°C to +185°C
±175ppm max.	0°C to +175°C or lower	CUSTOM	-20°C to +185°C
Please consult factory for high frequencies with high shock resistant			

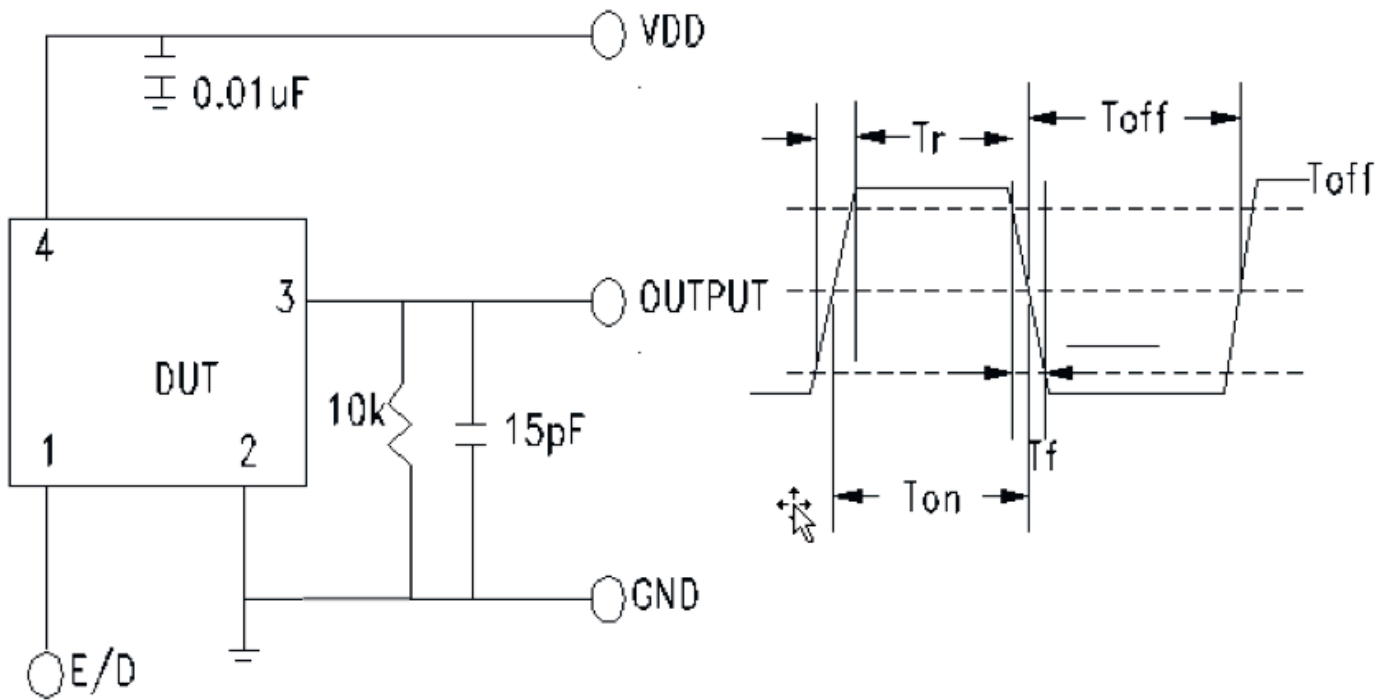
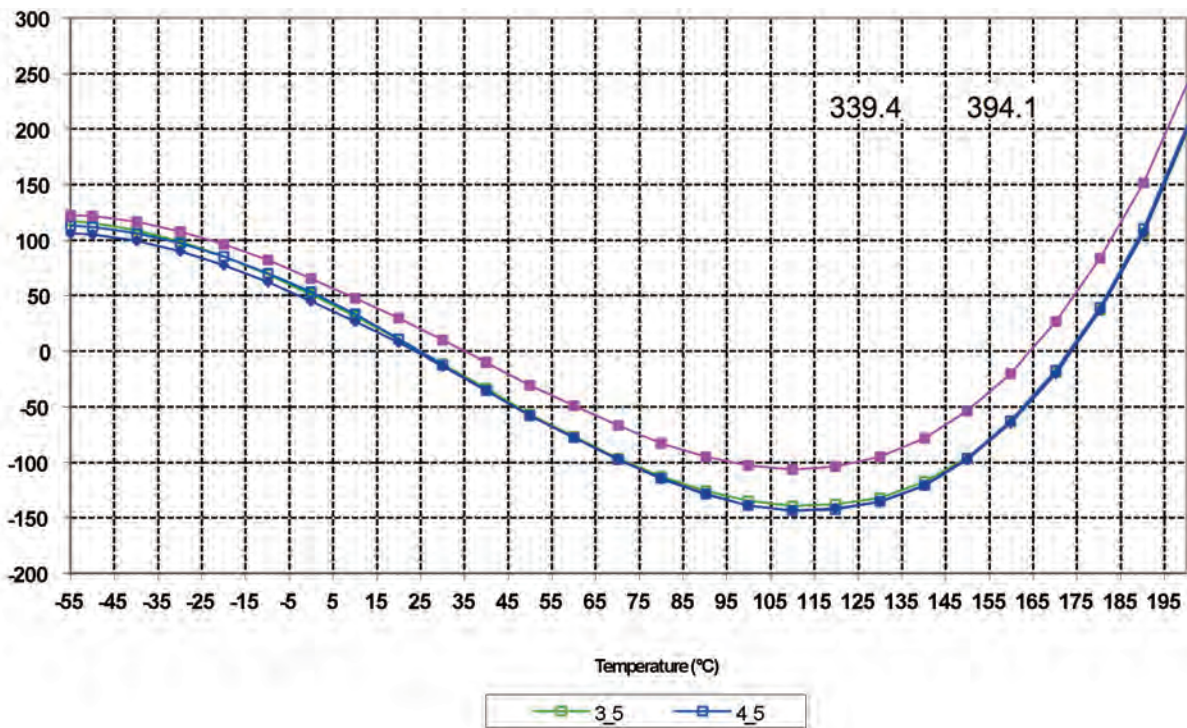

Figure 1 - Test set-up and output waveform



FREQUENCY VERSUS TEMPERATURE OF A 32MHz 5x7mm 200°C HIGH TEMPERATURE

TYPICAL NO LOAD CURRENT OF +225°C 5x7mm OSCILLATORS

Freq. (MHz)	3.3Vdc	5.0Vdc
1	1.8	3
3	2	3.5
4	2.5	4
8	3	5
12	3.5	6
16	4	7
20	4.5	7.5
24	5	8
25	5.5	9
27	6	9.5
30	6.5	10
32.768	7	11
40	8	12

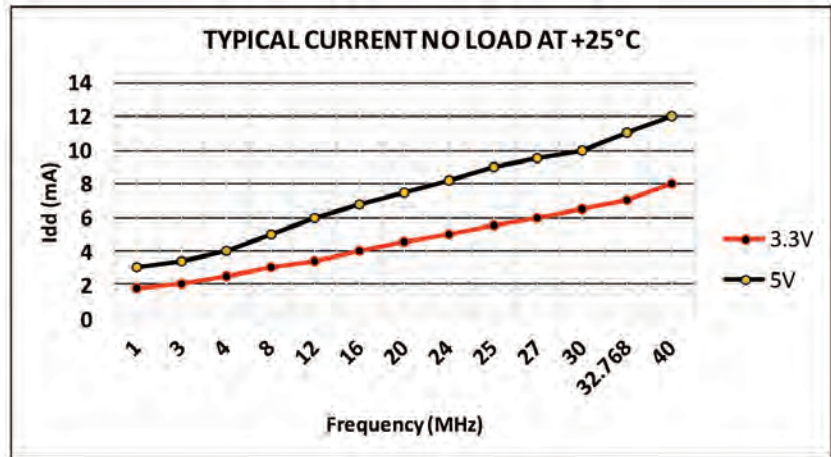

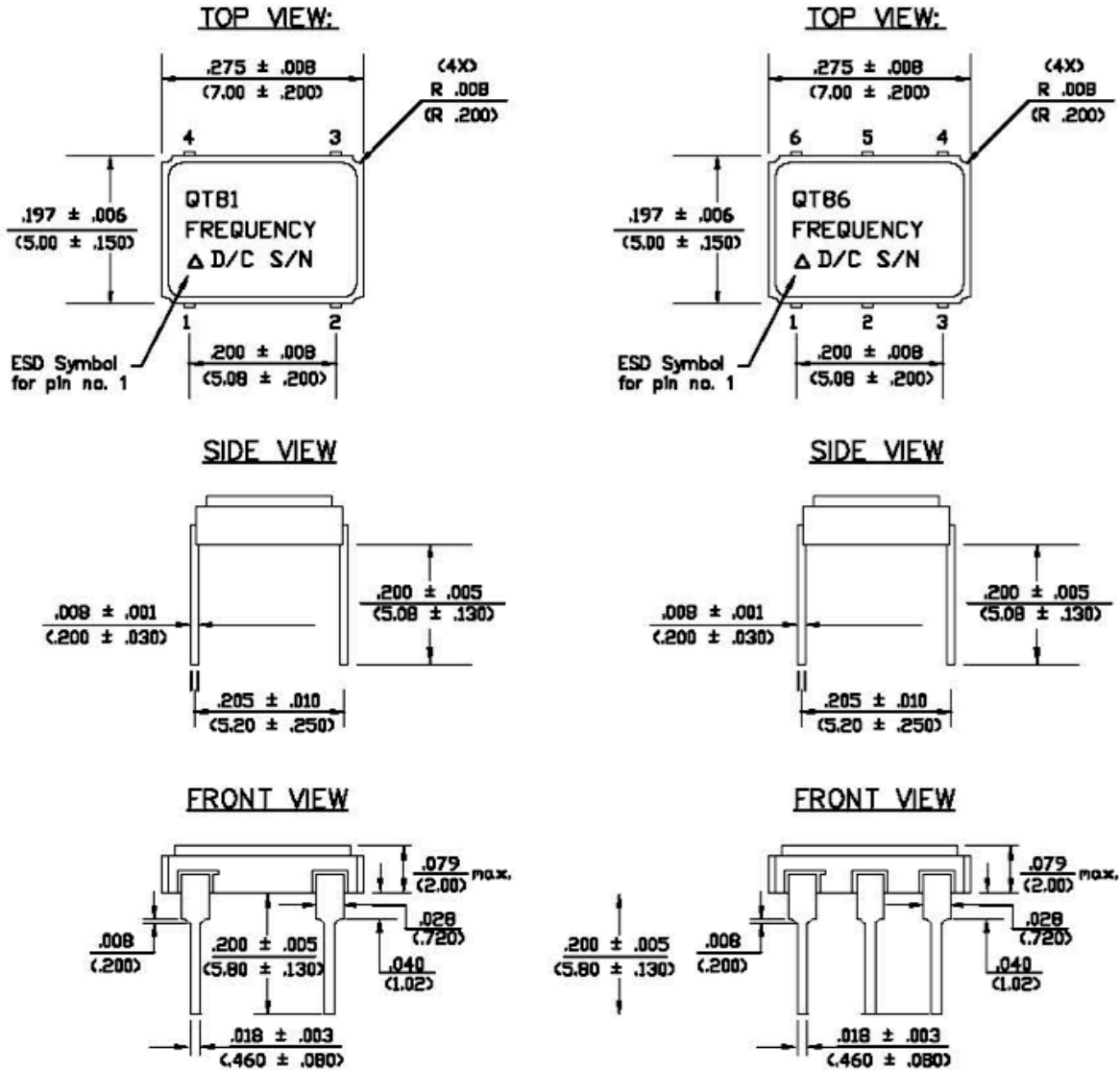

QT84 (SMT 4 Pads)	
Pin No.	Function
1	NC or ED
2	GND/CASE
3	OUTPUT
4	VDD

QT85 (SMT 6 Pads)	
Pin No.	Function
1	NC or ED
2	NC
3	GND/CASE
4	OUTPUT
5	NC
6	VDD

Figure 4 – QT81 and QT86 Form Drawing and Pin Outputs

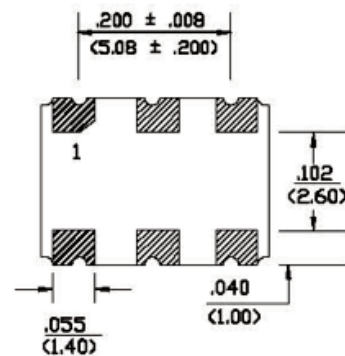
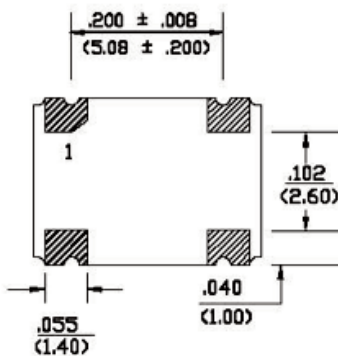
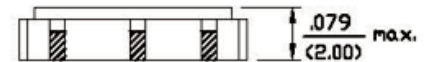
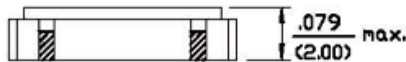
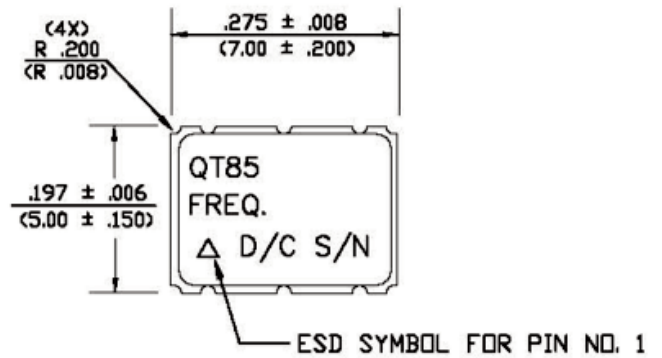
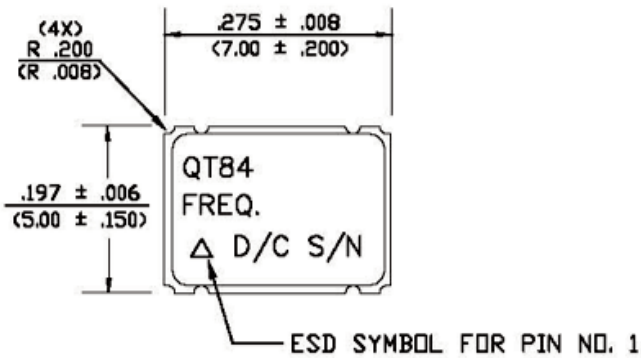

QT84 (SMT 4 Pads)	
Pin No.	Function
1	NC or ED
2	GND/CASE
3	OUTPUT
4	VDD

QT85 (SMT 6 Pads)	
Pin No.	Function
1	NC or ED
2	NC
3	GND/CASE
4	OUTPUT
5	NC
6	VDD

Figure 5 – QT84 and QT85 Form Drawing and Pin Outputs

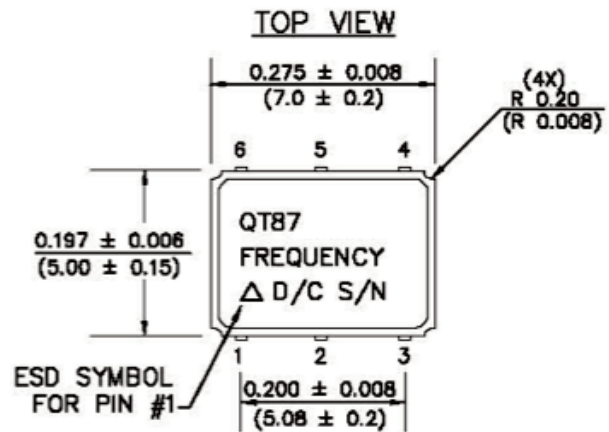
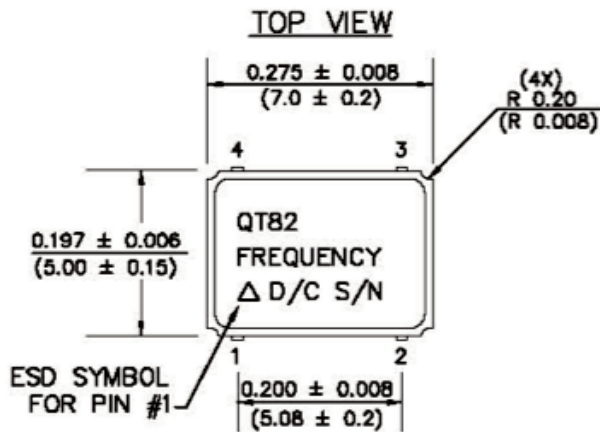

ESD Symbol
for pin no. 1

ESD Symbol
for pin no. 1

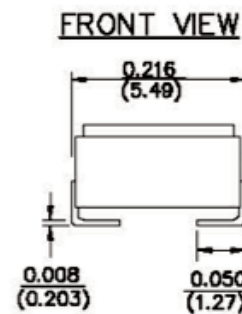
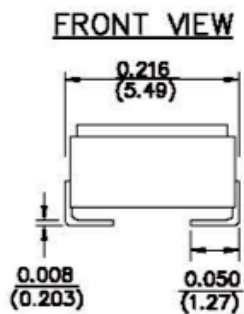
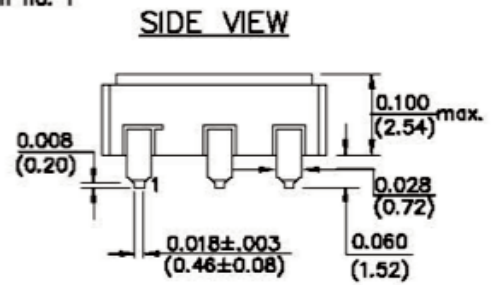
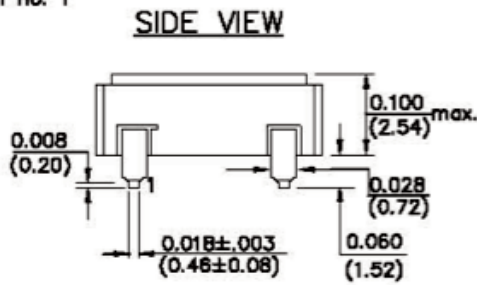

QT82 (Lead Formed, 4 Leads)	
Pin No.	Function
1	NC or ED
2	GND/CASE
3	OUTPUT
4	VDD

QT87 (Lead Formed, 6 Leads)	
Pin No.	Function
1	NC or ED
2	NC
3	GND/CASE
4	OUTPUT
5	NC
6	VDD

Figure 6 – QT82 and QT87 Form Drawing and Pin Outputs

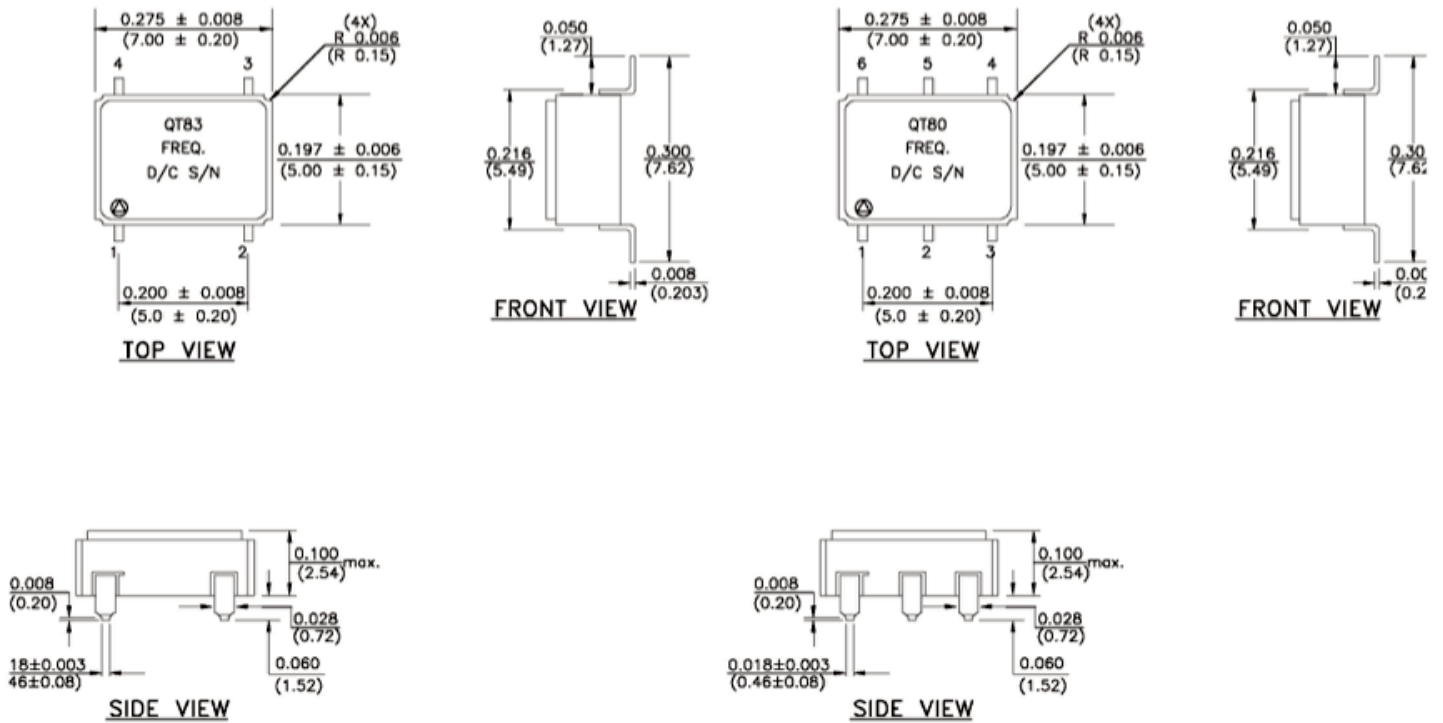

QT83 (Lead Formed, 4 Leads)	
Pin No.	Function
1	NC or ED
2	GND/CASE
3	OUTPUT
4	VDD

QT80 (Lead Formed, 6 Leads)	
Pin No.	Function
1	NC or ED
2	NC
3	GND/CASE
4	OUTPUT
5	NC
6	VDD

Figure 7 – QT83 and QT80 Form Drawing and Pin Outputs

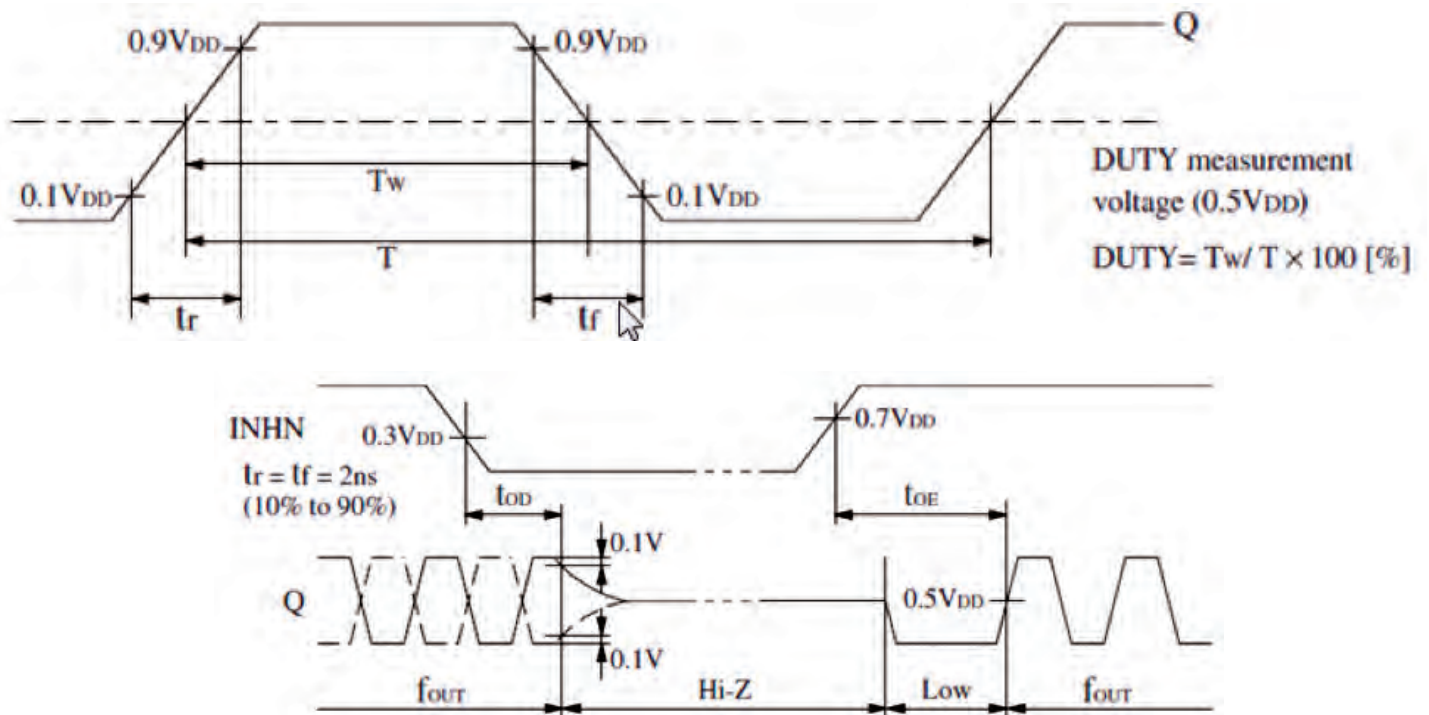

Figure 8 – Output Switching Waveform (Top) and Output Disable Timing Chart (Bottom)

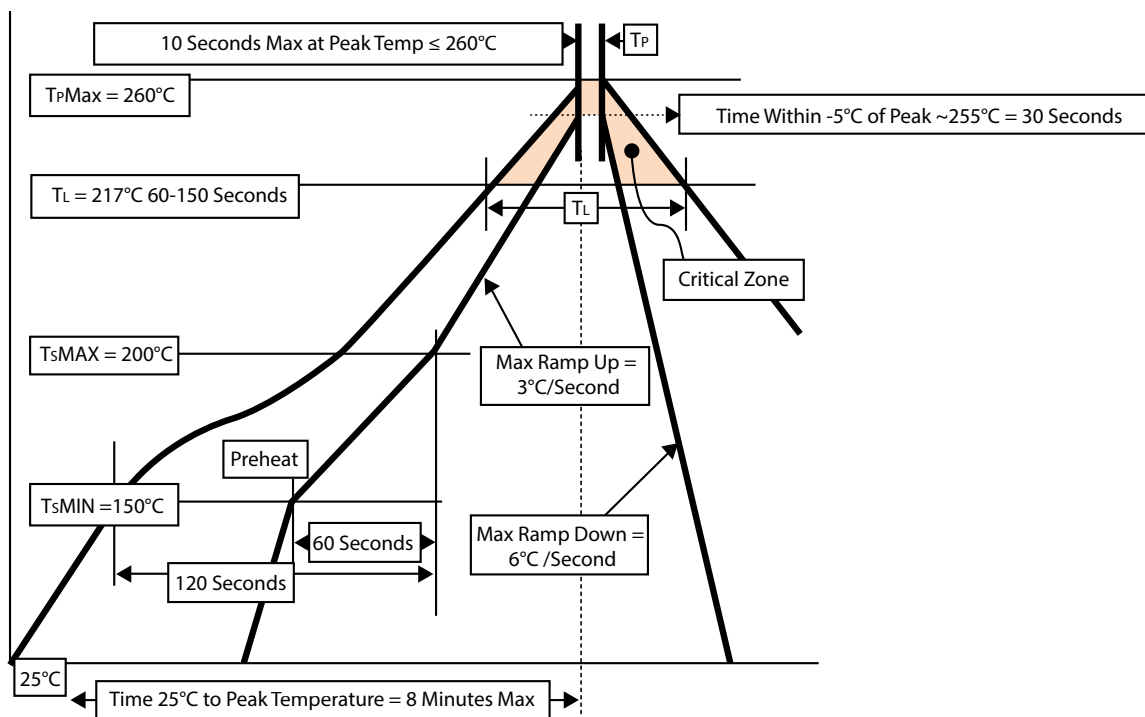

Figure 9 – Solder Reflow Profile Reflow Profile per IPC/JEDEC J-STD-020D.1, $240^{\circ}C$ Reflow Profile Also Acceptable



5x7mm High Temperature PRODUCT OFFERINGS

5x7mm High Temperature Crystal Oscillators
1.8V, 2.5V, 3.3V, 5Vdc | 250kHz to 100MHz

ENVIRONMENTAL AND MECHANICAL TEST SPECIFICATIONS

TEST	SPECIFICATION
Temperature Cycling	MIL-STD-883, Method 1010, Condition B
Thermal Shock	MIL-STD-883, Method 1011, Condition A
Moisture Resistance	MIL-STD-883, Method 1004
Terminal Strength	MIL-STD-883, Method 2004, Test Condition D
Solderability	MIL-STD-883, Method 2003
Resistance to Soldering Heat	MIL-STD-202, Method 210, Condition B
Mechanical Shock	MIL-STD-883, Method 2002, Condition B
Mechanical Vibration	MIL-STD-883, Method 2007, Condition A
Gross Leak	MIL-STD-883, Method 1014, Condition C
Fine Leak	MIL-STD-883, Method 1014, Condition A1
Solvent Resistance	MIL-STD-202, Method 215
Moisture Sensitivity Level	MSL = 1
Contact Pads	Gold (Au 60µin) Over Nickel (Ni 100-250µin) or Solder Dip Sn60Pb40/SAC305 Lead Free
ESD	Proper ESD Precautions Should be Taken When Handling and Mounting Crystal Oscillators. Built in ESD Protection Circuitry Ratings are as Follows: HBM Class 1C 1,999V per MIL-STD-883, Method 3015.7

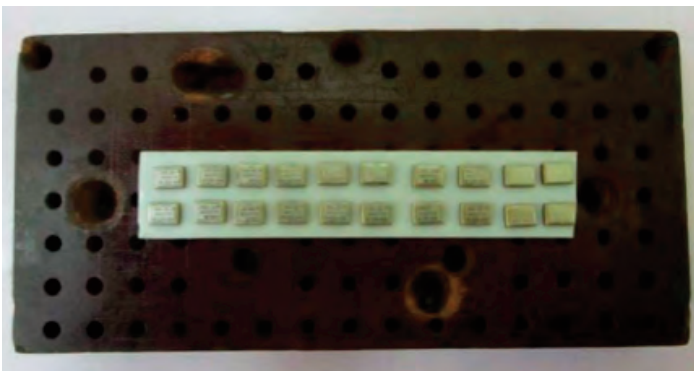

Figure 10 – Units to be Tested

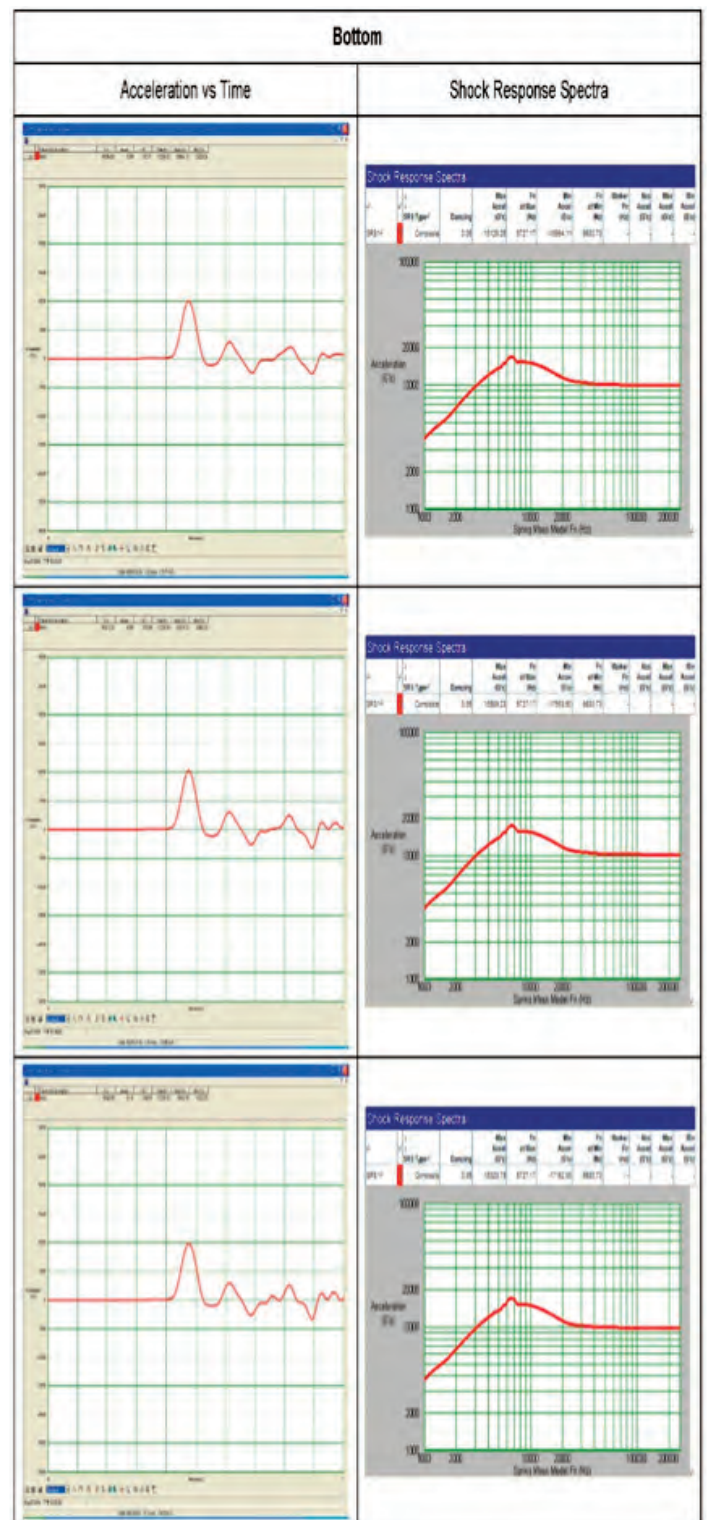

Figure 11 – Mechanical Shock Test Set Up

Figure 12 – Graph of Mechanical Shock Test



5x7mm High Temperature **PRODUCT OFFERINGS**

5x7mm High Temperature Crystal Oscillators
1.8V, 2.5V, 3.3V, 5Vdc | 250kHz to 100MHz

Revision History

ECO	REV	REVISION SUMMARY	PAGE	DATE
	-	Initial Release		06/08/15