

# 2022 BC-5 (HD) SW & DW

BY BCROASTERS.COM

THE 2021 BC-5 COMES IN YOUR CHOICE OF SINGLE OR DOUBLE WALL DRUM MODELS. THE BIGGEST ADVANTAGE OF THE DW MODELS IS ITS ABILITY TO DO SMALLER BATCHES FOR SAMPLES. THE BC-5 IS OUR BEST SELLING ROASTER GREAT FOR A COFFEE SHOP OR A HOME STARTUP BUSINESS. IT CAN ROAST FROM 8OZ. TO 5LB. PER ROAST ON THE DOUBLE WALL UNIT (16OZ.-5LB. ON SW) AND UP TO 5 ROASTS PER HOUR ON THE GAS MODELS. MANY ARE ROASTING OVER 5LB. PER ROAST IN THE GAS MODELS. IT HAS ALL THE FEATURES MOST COMPANIES CHARGE EXTRA FOR BUILT INTO THE BASE PRICE. PRECISE AIRFLOW CONTROL VIA THE MDDS (MANUAL DAMPER) SYSTEM. SOLID HEAVY-DUTY STAINLESS STEEL DRUM AND BUILT IN PROFILING SYSTEM VIA ARTISAN OR CROPSTER FOR BT & ET. DIRECT-CONNECT CHAFF UNIT FOR GREATER EFFICIENCY & REDUCED FOOTPRINT. COMES IN CHOICE OF GAS OR ALL ELECTRIC. NOW IN BLACK, RED & WHITE BODY COLORS! THE NEW HD 2022 SERIES ARE ARRIVING AHEAD OF ITS TIME IN MARCH 2021 TO OFFER ALL THE GREAT FEATURES THE BC'S ARE KNOWN FOR PLUS A NEW HEAVY DUTY CHAFF FAN & GAS GAUGE SYSTEM! BRING ON 2022!



BC-5MD	GAS TYPE	ELECTRIC
Batch Size	8oz-5lb.	8oz-4.4lb
Roasting Time	9-14 minutes	15min.
Production	20-25lb.hr	20lb. hr.
Heat Source	NG/LPG	electric
Voltage	220V	220V
Wattage	295W	5295W
Drum Motor	90W	60W
Chaff Fan Motor	45W	45W
Cooling Fan Motor	90W	90W
MIXING ARM	15W	15W
BTU	45,000	
NG PRESSURE	7-12WC	
LPG PRESSURE	MAX. 16-20WC	
Gas Consumption	0.4kg/hr	
Roaster Dim.	42x27x39	42x27x39
Roaster Weight	353lb.	353lb.
Package Dimensions	48x32x44 408lb.	48x32x44 408lb.

**NEW 3MM THERMOCOUPLES FOR 2021 MODELS  
LOOK FOR THE 2022 HD SERIES IN SPRING 2021!**

**NEW 2022 HD LINEUP FEATURES A NEW HD CHAFF FAN & HD GAS GAUGE**

## FEATURES

DRUM TYPE  
DATA LOGGING  
THERMOCOUPLES  
CONTROL PANEL  
WARRANTY  
PARTS AVAILABLE  
110V CONVERTER

Single Wall 4mm or Double 8mm  
2 OMRON CONTROLS  
K-TYPE for BT (3mm thick)  
BT&ET VEIW ON PANEL  
1 YEAR PARTS & INSTRUCTION  
10 Year Parts Available Guarantee  
110V Voltage Converter included.

**NEW HD LINE FEATURES 60W  
CHAFF FAN= 310W TOTAL ON GAS  
MODELS & 5310W ON ELECTRIC**

**BC ROASTER COLORS**

**BC ROASTERS NOW COME IN 3 BODY COLORS:  
BLACK, RED & WHITE**



**BLACK BODY WITH BLACK  
CHECKERED HOUSING**



**RED BODY WITH GOLD  
CHECKERED HOUSING**



**WHITE BODY WITH  
ROSE GOLD HOUSING**

**TWO NEW TEXTURED  
HOUSINGS AVAILABLE  
FOR 2021 & 2022  
MODELS:**

**HOUSING COLORS INCLUDE 3 SOLID COLORS:  
ROSE GOLD, BLACK TITANIUM, STAINLESS  
(COLORS MAY VARY FROM PICTURES SLIGHTLY)**



**ROSE GOLD**



**STAINLESS**



**BLACK TITANIUM**



**ALSO HOUSING COLORS IN TEXTURED CHECKERED COLORS:  
CHECKERED BLACK, SILVER OR GOLD:**

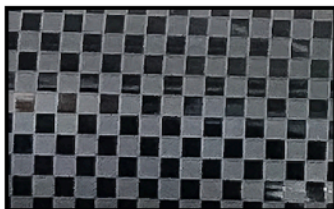

**CHECKERED BLACK**

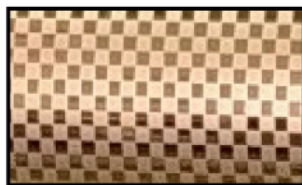

**CHECKERED GOLD**

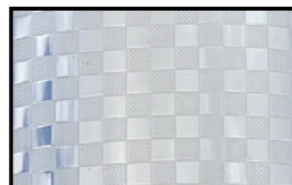

**CHECKERED SILVER**



**BODY COLORS:  
BLACK, RED OR WHITE**

**SOLID HOUSING COLORS: ROSE GOLD, BLACK  
TITANIUM, STAINLESS**

**TEXTURE HOUSINGS: CHECKERED GOLD,  
CHECKERED BLACK OR CHECKERED SILVER**

## **NEW FOR THE HD LINEUP:**

THE NEW 2022 HD LINE FEATURES A NEW HEAVY DUTY CHAFF FAN. THIS FAN REQUIRES A 120MM (5") EXHAUST CONNECTION. (OLDER BC MODELS & EARLY 2021 MODELS THAT WERE NOT HD USED A 3" EXHAUST)  
THE SAME SIZE 4" EXHAUST COMES OFF THE COOLING TRAY

## **NEW 2021 & 2022 FEATURES & OPTIONS:**

- + COOLING TRAY FAN IS VERTICAL FOR EASY VENTING
- + **NEW 3MM THICK THERMOCOUPLES**
- + OPTIONAL COOLING TRAY COVER NEW FOR 2021!
- + 2022 HD SERIES AVAILABLE IN MARCH 2021
- + NEW **HD** LINE FEATURE A HD CHAFF FAN W/5" EXHAUST
- + **HD** LINE FEATURE A HD GAS GAUGE

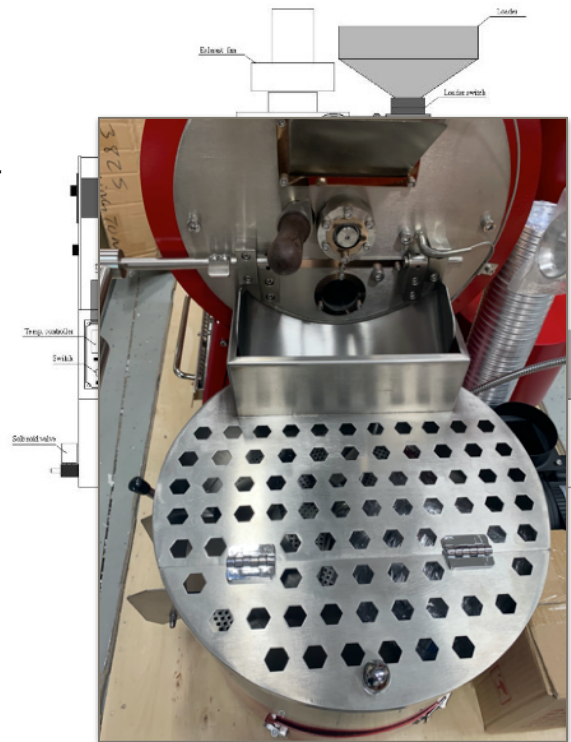

## **2021 & 2022 MODELS HAVE COOLING TRAY FANS THAT ARE VERTICAL FOR EASY VENTING**

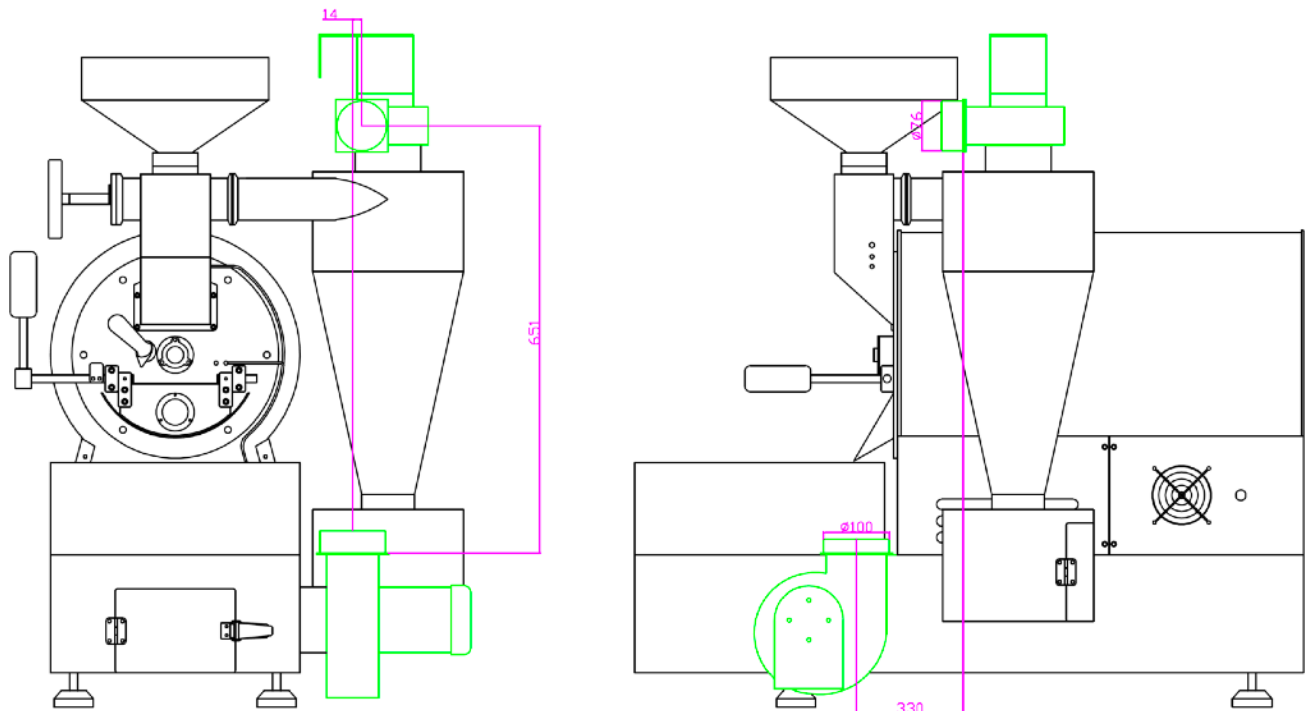

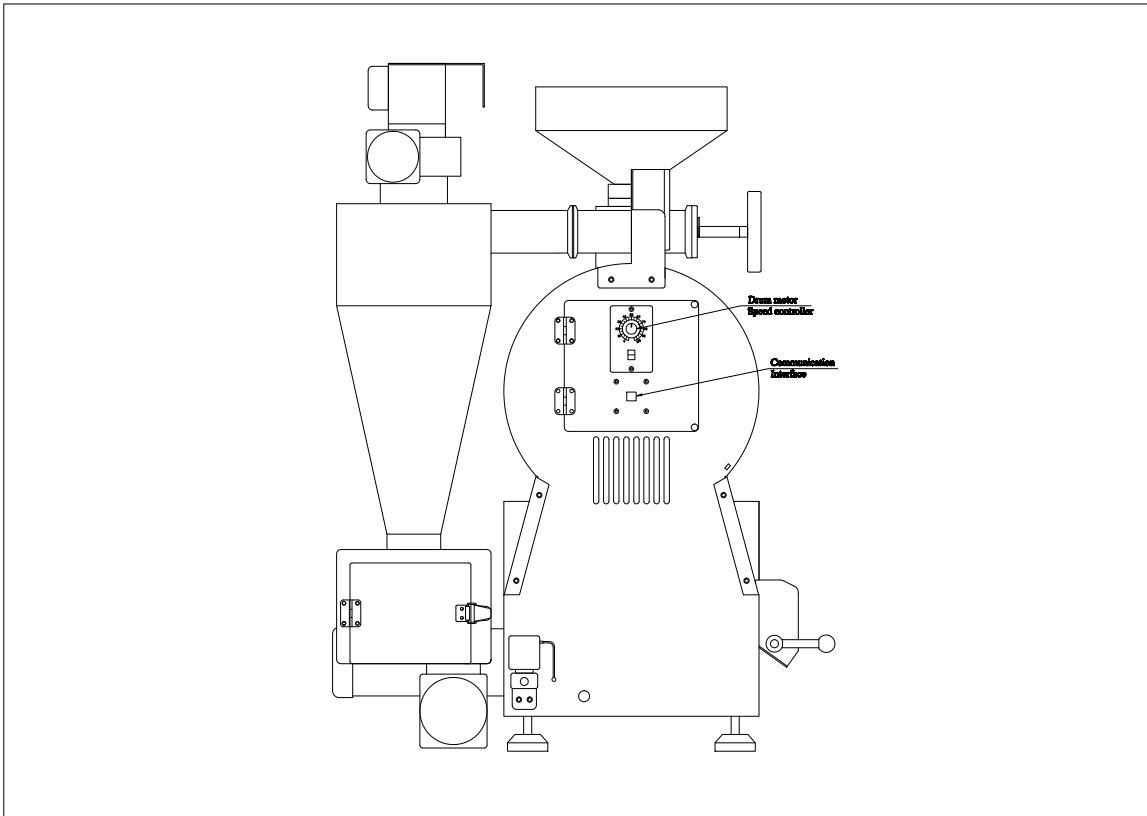
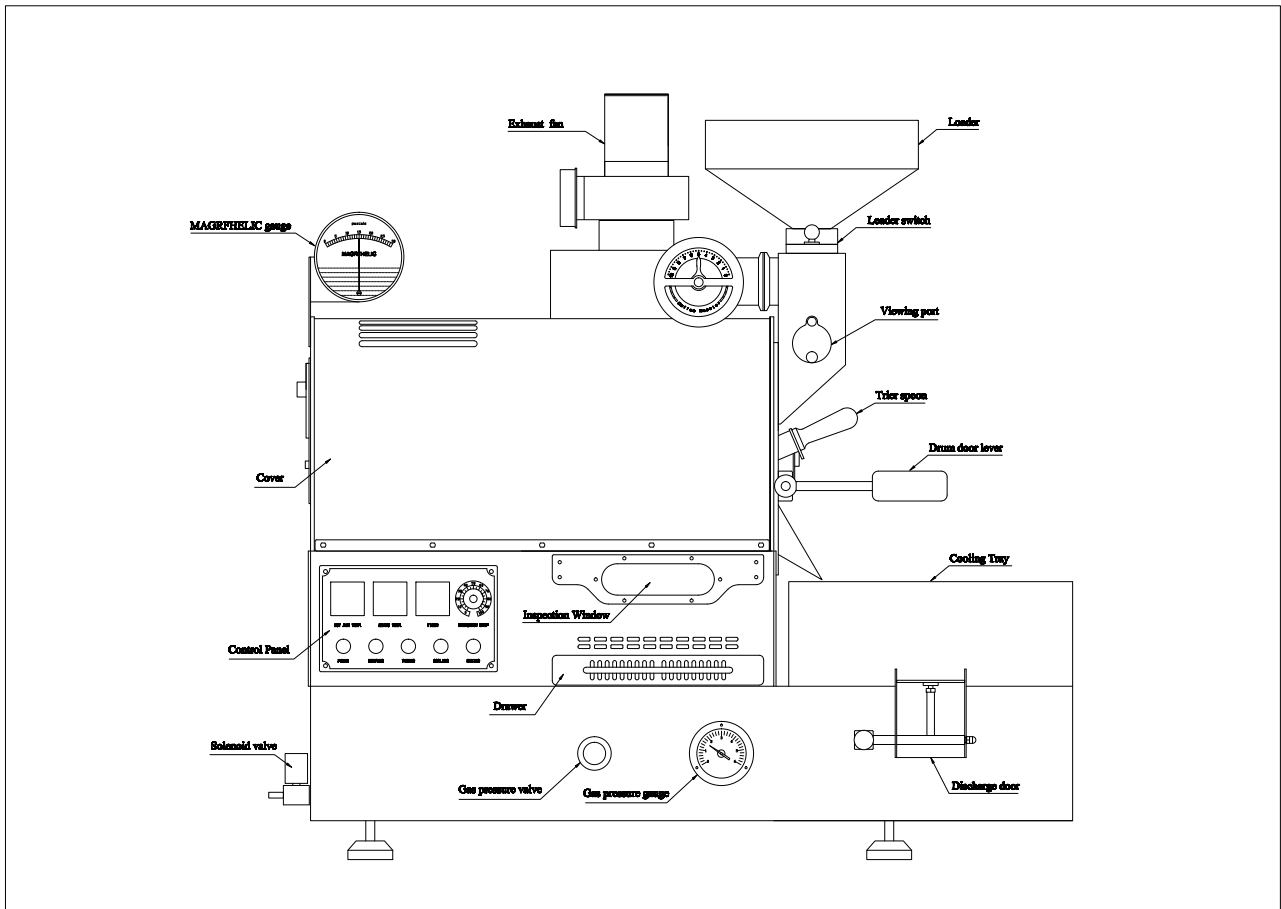

## BC-5 COMMERCIAL COFFEE ROASTER

\*TABLETOP OR STAND MODEL (18-24" STAND SUGGESTED)  
\*DIRECT CONNECT CHAFF UNIT FOR SMALLER FOOTPRINT  
\*CHOICE OF ALL ELECTRIC OR GAS MODELS

<b>SIZE SETUP (LxWxH)</b>	42x27x39" (INCLUDES DIRECT CONNECT CHAFF UNIT IN MEASUREMENT)
<b>WEIGHT</b>	353LB
<b>MINIMUM CLEARANCE FROM COMBUSTABLE MATERIALS</b>	18-24"
<b>ROASTING CAPACITY</b>	1-5LB SINGLE WALL 8OZ TO 5LB DOUBLE WALL
<b>ROAST TIME &amp; ROASTS PER HOUR</b>	9-14 MINUTES (5 ROASTS PER HOUR GAS. 3.5 PER HOUR ELECTRIC)
<b>DRUM INFORMATION</b>	<b>SW DRUM:</b> 4MM SUPERIOR 304SS CONTAINS 18% CHROMIUM AND 8% NICKEL <b>DW DRUM:</b> HAS TWO LAYERS OF 2MM 304SS WITH 4MM OF AIR CUSHION. SS WELDING
<b>ELECTRIC STATS:</b>	<b>GAS MODEL:</b> SINGLE PHASE 220V 50/60HZ 295W REQUIRES STANDARD 15A BREAKER <b>ALL ELECTRIC MODELS:</b> SINGLE PHASE 220V 50/60HZ 5295W REQUIRES 30A DEDICATED BREAKER
<b>ELECTRICAL PLUG TYPE</b>	<b>GAS MODELS:</b> 20A 250V 3 WIRE NEMA 6-20P <b>ELECTRIC TYPE:</b> LOCKING PLUG 250V 30A NEMA L6-30P
<b>FUEL CHOICES ON GAS MODELS</b>	LPG GAS STANDARD WITH MODELS. NATURAL GAS CONVERSION KITS OFFERED FOR CUSTOMER INSTALLATION ONLY.
<b>BURNER INFORMATION ON GAS MODELS</b>	<b>SW BURNERS:</b> 8 STANDARD HD BURNERS <b>DW BURNERS:</b> 10 STANDARD HD BURNERS
<b>BTU REQUIRMENTS</b>	40,000 BTU MINIMUM REQUIRED FOR NG LINE
<b>GAS PRESSURE</b>	<b>LPG:</b> 12-16WC (3-4KPA) MARSHALL 1912/197 REGULATOR RECOMMENDED <b>NG:</b> 7-14WC

### IMPORTANT NOTE ON EXHAUST SETUP OF THE NEW HD LINE OF ROASTERS:

THE NEW 2022 HD LINE OF ROASTERS INTRODUCED IN 2021 FEATURE A NEW HEAVY DUTY CHAFF FAN. THIS FAN HAS AN EXHAUST PIPE OF 120MM. THEREFORE IT REQUIRES A 5" PIPE TO ATTACH TO THE CHAFF EXHAUST (OTHER MODELS THAT ARE NOT THE NEW HD LINE USE A 3" PIPE) YOU MAY CHOOSE TO GET A 5 TO 6 IN. REDUCER PIPE TO RUN A 6" LINE AS MAIN EXHAUST OFF CHAFF UNIT.

<b>EXHAUST SETUP</b>	
<b>EXHAUST PIPE REQUIREMENTS</b>	<b>POSITIVE PRESSURE EXHAUST VENTING WITH MINIMUM CLEARANCE 18-24" FROM COMBUSTABLE MATERIALS</b>
<b>MAXIMUM VENTING LENGTHS</b>	<b>20-25' FROM CHAFF UNIT. DEDUCT 3-5' FOR 45-90 DEGREE PIPE ELBOWS. IF YOU MUST VENT AT LONGER LENGTHS CONSULT A LOCAL TECHNICIAN ON USE OF POSSIBLE BOOSTER FANS</b>
<b>MAXIMUM EXHAUST TEMPERATURES</b>	<b>425-475F</b>
<b>CHAFF UNIT HIGH TEMP.</b>	<b>300-350F</b>
<b>COOLING TRAY HIGH TEMP.</b>	<b>200F</b>
<b>DATA LOGGING VIA ARTISAN OR CROPSTER</b>	<b>BUILT IN DATA LOGGER ATTACHES TO COMPUTER (PC OR MAC) VIA USB OR BLUETOOTH</b>
<b>K TYPE THERMOCOUPLES</b>	<b>BT &amp; ET WITH TWO ADDITIONAL PREDRILLED CAPPED THREADED HOLES TO ADD OR ADJUST LOCATION OF PROBES</b>
<b>MANUFACTURED IN CHINA FOR BC ROASTERS</b>	<b>CUSTOM BUILT FOR BC SPECS IN USA AND OVER 200 LANDS</b>

**FOR MORE INFORMATION SEE:**

**BCROASTERS.COM**

**HTTP://WWW.BUCKEYECOFFEE.COM/BC-COFFEE-ROASTERS.HTML**

**BC ROASTERS  
BUCKEYE, ARIZONA 85326  
TONOPAH, ARIZONA 85354**

**TOLL FREE: 844.522.6333  
INFO@BUCKEYECOFFEE.COM  
**INFO@BCROASTERS.COM****

**BCROASTERS.COM INFO@BUCKEYECOFFEE.COM 844.522.6333**