

McGAUGHYS

S U S P E N S I O N P A R T S

LIFTING • LOWERING • CLASSIC



2016 CATALOG

MCGAUGHY'S HISTORY & AWARDS

We've been leading the lowering suspension market for over 32 years (since 1984)! Our engineering capabilities are endless and we continue to release high quality parts that the public demands. We are always challenging ourselves with producing suspension parts that haven't been done before in the world and doing it right the first time. We ride on our reputation for our parts being a bolt-on installation and making sure the entire lowering kit works hand-in-hand with the necessary factory components. Our kits are made so the average guy in his garage can do the installation without any major modifications. We manufacture our spindles and don't buy them like some of our competitors do. Our "Classic Drop" spindles are made in the USA with the highest quality components. Our machining is done in-house on one of our state-of-the-art CNC machines. All of our spindles spuds are made from 4140 chromoly and machined in our CNC turning centers. Since we do our own engineering, prototyping, and machining, we are able to have suspension kits for vehicles as soon as they hit the dealerships! We are actually a manufacturer and don't just claim to be one!



Before we released our spindles for the 1999-2006 GM Trucks, 2001-2006 SUV's, and the 2007+ spindle, we patented our design to ensure that our product would remain the best on the market. At the 2003 SEMA show, GM presented us with "The Most Innovative Product of the Year" Award for our drop spindle. We patented the upper bearing stud so that our spindle's upper ball joint height would keep the same dimensions as the stock GM spindle (This ensures the correct ball joint angles are maintained). In order for our competitors to avoid our patent, they had to raise the upper ball joint boss 1.5" which creates horrendous bump steer, severe ball joint angles, and premature ball joint wear. In some cases, our competitor's spindles require that the upper A-Frame be flipped upside down, which is the complete opposite of how GM intended the front suspension parts to be installed and function.

TABLE OF CONTENTS



2014 GMC 1500, 7" Black SS Premium Lift Kit (4WD)



2014 RAM 3500, 6" Premium Lift Kit (4WD)



2015 F-150, 6.5" Premium Lift Kit (4WD)

LIFTING

Lifting Application Guide.....1-4

GM Truck 1500

99-06.....5
 07-13.....6-7
 14-16.....8

GM 1500 SUV

01-06.....9
 07-13.....10
 14-16.....10

GM Truck 2500/3500

02-10 2500HD/3500.....11-12
 11-15 2500/3500.....13-14

Ford F-150

09-14.....15
 2015.....16

Ford F-250 / F-350

05-07.....17-18
 08-10.....17-18
 11-15.....17-18

Dodge 2500/3500

03-08 2500/3500.....19
 09-13 2500.....19
 09-12 3500.....19
 14-16 2500.....20
 13-16 3500.....21

**Lowering & Classic
 continued on next page**
 →



TABLE OF CONTENTS (CONT.)

LOWERING

Lowering Application Guide.....23-32

GM 1500 Trucks

60-72.....	33-38
73-87.....	39-40
88-98.....	41
99-06.....	42-44
07-13.....	45-48
14-16.....	49

GM SUV 1500

01-06.....	50-51
07-13.....	52-53
14-16.....	54

S-10 (82-02).....55-56

COLORADO (04-14).....56

TRAILBLAZER (02-09).....57

GM HD 2500/3500

99-00 2500.....	58-59
01-03 1500HD.....	58-59
04 2500.....	58-59
02-10 2500HD/3500.....	58-59

FORD F-150

97-03.....	60
04-08.....	61
09-14.....	62
2015.....	62

DODGE RAM 1500

02-05.....	63
06-08.....	64
09-15.....	65

TOYOTA TUNDRA (2003-2014).....66

NISSAN TITAN (04-13).....67



67 Chevy (1/2 ton, 2WD) C-10, 6"/7" Drop



2014 GMC 1500 2WD, 4"/6" Drop



2014 Chevy 1500 SUV 2WD, 3"/5" Drop



TABLE OF CONTENTS (CONT.)



57 Chevy 3"/3.5" Drop



69 Camaro 2"/2" Drop



72 Chevelle 2"/2" Drop

CLASSIC CAR

Classic Application Guide.....69-71

Fullsize Chevy Car

55-57.....72-73

58-64.....74-75

65-70.....75

Chevy Nova

62-67.....76

68-74.....76

Chevy Camaro

67-69.....76

70-81.....77

A-Body (Chevelle, 442, GTO, ETC.)

64-72.....78

BIG BRAKE QUICK GUIDE

Big Brake Quick Guide.....79

SHOCK QUICK GUIDE

Shock Guide.....80

NEWER CAR LOWERING

Chevy Camaro

2010-15.....81

Dodge Magnum, Challenger, Chrysler 300, & Charger

2004-13.....81

Terms and Conditions / Footnotes.....82



GM LIFT KITS & PARTS

PART #	MODEL	YEAR	APPLICATION	LIFT	KIT	PAGE #
50100	TRUCK 1/2TON	99-06	4WD	2"	Leveling Kit (Lift Keys)	5
50000	TRUCK 1/2TON	99-06	4WD	7"	PREMIUM Lift Kit (Silver Powder Coat)	5
50005	TRUCK 1/2TON	99-06	2WD / 4WD		Add - A - Leaf w/ Center Pins	5
50018	TRUCK 1/2TON	99-06	2WD / 4WD		60" Traction Bar Kit w/ Hardware	5
50115	TRUCK 1/2TON	99-06	4WD	6"	Compression Struts (pr.) w/ Bushings	5
50705	TRUCK 1/2TON	99-06	2WD / 4WD	1.25"	6" Fabricated Block	5
50710	TRUCK 1/2TON	07-13	2WD / 4WD	1.5"	Leveling Lift Kit (Upper/Lower Strut Spacers)	6
50703	TRUCK 1/2TON	07-13	2WD	7"	Basic Lift Kit (Silver Powder Coat)	6
50700	TRUCK 1/2TON	07-13	2WD	7"	PREMIUM Lift Kit (Silver Powder Coat)	6
50701	TRUCK 1/2TON	07-13	2WD	7"	PREMIUM Black SS Lift Kit (Black Powder Coat)	6
50720	TRUCK 1/2TON	07-13	4WD	7"	PREMIUM Lift Kit (Silver Powder Coat)	6
50721	TRUCK 1/2TON	07-13	4WD	7"	PREMIUM Black SS Lift Kit (Black Powder Coat)	6
50723	TRUCK 1/2TON	07-13	4WD	7"	Basic Lift Kit (Silver Powder Coat)	6
50005	TRUCK 1/2TON	07-13	2WD / 4WD	1.25"	Add - A - Leaf w/ Center Pins	7
50018	TRUCK 1/2TON	07-13	2WD / 4WD		60" Traction Bar Kit w/ Hardware	7
50715	TRUCK 1/2TON	07-13	2WD / 4WD		Compression Struts (pr.) w/ Bushings	7
50705	TRUCK 1/2TON	07-13	2WD / 4WD	6"	6" Fabricated Block	7
50764	TRUCK 1/2TON	2014	2WD	7"	Basic Lift Kit (Black Powder Coat)	8
50765	TRUCK 1/2TON	2014	4WD	7"	Basic Lift Kit (Black Powder Coat)	8
50766-SSB	TRUCK 1/2TON	2014	2WD	7"	PREMIUM Black SS Lift Kit (Black Powder Coat)	8
50766-SSS	TRUCK 1/2TON	2014	2WD	7"	PREMIUM Silver SS Lift Kit (Silver Powder Coat)	8
50767-SSB	TRUCK 1/2TON	2014	4WD	7"	PREMIUM Black SS Lift Kit (Black Powder Coat)	8
50767-SSS	TRUCK 1/2TON	2014	4WD	7"	PREMIUM Silver SS Lift Kit (Silver Powder Coat)	8
50768	TRUCK 1/2TON	2014	2WD	7"	PREMIUM Lift Kit (Silver Powder Coat)	8
50769	TRUCK 1/2TON	2014	4WD	7"	PREMIUM Lift Kit (Silver Powder Coat)	8
50005	TRUCK 1/2TON	14-15	2WD / 4WD	1.25"	Add - A - Leaf w/ Center Pins	8
50018	TRUCK 1/2TON	14-15	2WD / 4WD		60" Traction Bar Kit w/ Hardware	8
50770	TRUCK 1/2TON	14-15	2WD / 4WD	6"	6" Rear Fabricated Lift Block w/ U-Bolts	8
50100	SUV 1/2TON	01-06	2WD / 4WD	2"	Leveling Kit (Lift Keys)	9
50125	SUV 1/2TON	01-06	2WD	7"	Lift Kit (Silver Powder Coat) - Auto Leveling	9
50128	SUV 1/2TON	01-06	2WD	7"	Lift Kit (Silver Powder Coat) - Not Auto Leveling	9
50135	SUV 1/2TON	01-06	4WD	7"	Lift Kit (Silver Powder Coat) - Auto Leveling	9
50138	SUV 1/2TON	01-06	4WD	7"	Lift Kit (Silver Powder Coat) - Not Auto Leveling	9
50710	SUV 1/2TON	07-13	2WD / 4WD	1.5"	Leveling Kit (Upper/Lower Strut Spacers)	10
50725	SUV 1/2TON	07-13	2WD	7"	Lift Kit (Silver Powder Coat) - Auto Leveling	10
50728	SUV 1/2TON	07-13	2WD	7"	Lift Kit (Silver Powder Coat) - Not Auto Leveling	10
50735	SUV 1/2TON	07-13	4WD	7"	Lift Kit (Silver Powder Coat) - Auto Leveling	10
50738	SUV 1/2TON	07-13	4WD	7"	Lift Kit (Silver Powder Coat) - Not Auto Leveling	10
50800	SUV 1/2TON	14-15	2WD	7"	Lift Kit (Silver Powder Coat) - Not Auto Leveling	10
50803	SUV 1/2TON	14-15	2WD	7"	Black SS Lift Kit (Black Powder Coat) - Not Auto Leveling	10
50804	SUV 1/2TON	14-15	2WD	7"	Black SS Lift Kit (Black Powder Coat) - Not Auto Leveling	10
50805	SUV 1/2TON	14-15	4WD	7"	Lift Kit (Silver Powder Coat) - Not Auto Leveling	10
50806	SUV 1/2TON	14-15	4WD	7"	Lift Kit (Silver Powder Coat) - Auto Leveling	10
50808	SUV 1/2TON	14-15	4WD	7"	Black SS Lift Kit (Black Powder Coat) - Not Auto Leveling	10
52100	2500/3500	02-10	2WD / 4WD	2"	Leveling Kit (Leveling Keys & Shock Extenders)	11
52000	2500/3500	02-10	2WD DIESEL	7"	PREMIUM Lift Kit (Silver Powder Coat)	11
52003	2500/3500	02-10	2WD GAS MOTOR	7"	PREMIUM Lift Kit (Silver Powder Coat)	11
52050	2500/3500	02-10	4WD DIESEL	7"	PREMIUM Lift Kit (Silver Powder Coat)	11
52053	2500/3500	02-10	4WD GAS MOTOR	7"	PREMIUM Lift Kit (Silver Powder Coat)	11
52018	2500/3500	02-10	2WD / 4WD 8-LUG		60" Traction Bar Kit w/ Hardware	11
52115	2500/3500	02-10	2WD / 4WD 8-LUG		Compression Struts (pr.) w/ Bushings	12

GM LIFT KITS & PARTS

PART #	MODEL	YEAR	APPLICATION	LIFT	KIT	PAGE #
52150	2500/3500	02-10	2WD / 4WD 8-LUG		Double Shock Hoop, Upper A-Frames w/ Bushing & Ball Joints	12
52151	2500/3500	02-10	2WD / 4WD 8-LUG		Upper A-Arms w/ Bushings & Ball Joints	12
52160	2500/3500	02-10	4WD, 8-LUG		Bolt-On Bracket for Stock Differential	12
52001	3500	02-10	2WD DIESEL	7"	PREMIUM Lift Kit (Silver Powder Coat)	11
52004	3500	02-10	2WD GAS MOTOR	7"	PREMIUM Lift Kit (Silver Powder Coat)	11
52051	3500	02-10	4WD DIESEL	7"	PREMIUM Lift Kit (Silver Powder Coat)	11
52054	3500	02-10	4WD GAS MOTOR	7"	PREMIUM Lift Kit (Silver Powder Coat)	11
52310	2500/3500	11-15	2WD / 4WD	2"	Leveling Kit (Keys, Shock Spacers, & Shock Nuts)	14
52300	2500/3500	11-15	2WD	7"	PREMIUM Lift Kit (Silver Powder Coat)	13
52350	2500/3500	11-15	4WD	7"	PREMIUM Lift Kit (Silver Powder Coat)	13
52305	2500/3500	11-15	4WD	7"	PREMIUM Lift Kit (Silver Powder Coat) - No Torsion Drop	14
52353	2500/3500	11-15	4WD GAS MOTOR	7"	PREMIUM Lift Kit (Silver Powder Coat)	13
52355	2500/3500	11-15	2WD	7"	PREMIUM Black SS Lift Kit (Black Powder Coat)	13
52356	2500/3500	11-15	4WD	7"	PREMIUM Black SS Lift Kit (Black Powder Coat)	13
52306	2500/3500	11-15	4WD	7"	PREMIUM Lift Kit (Silver Powder Coat) - No Torsion Drop	14
52301	3500	11-15	2WD	7"	PREMIUM Lift Kit (Silver Powder Coat)	13
52303	3500	11-15	2WD GAS MOTOR	7"	PREMIUM Lift Kit (Silver Powder Coat)	13
52314	2500/3500	11-15	2WD / 4WD 8-LUG		Upper A-Arms w/ Bushings & Ball Joints	14
52315	2500/3500	11-15	2WD / 4WD 8-LUG		Compression Struts (pr.) w/ Bushings	14
52318	2500/3500	11-15	2WD / 4WD 8-LUG		60" Traction Bar Kit w/ Hardware	14
52357	2500/3500	11-15	2WD / 4WD 8-LUG		Shock Reservoir Upper Mount	14
52301	3500	11-15	2WD	7"	PREMIUM Lift Kit (Silver Powder Coat)	13
52304	3500	11-15	2WD GAS MOTOR	7"	PREMIUM Lift Kit (Silver Powder Coat)	13
52351	3500	11-15	4WD	7"	PREMIUM Lift Kit (Silver Powder Coat)	13
52354	3500	11-15	4WD GAS MOTOR	7"	PREMIUM Lift Kit (Silver Powder Coat)	13



FORD LIFT KITS & PARTS

PART #	MODEL	YEAR	APPLICATION	LIFT	KIT	PAGE #
57810	F-150	04-08	2WD / 4WD	2.25"	Front Leveling Lift Kit (Strut Spacers)	15
57000	F-150	09-14	2WD	6.5"	PREMIUM Lift Kit (Silver Powder Coat)	15
57050	F-150	09-14	4WD	6.5"	PREMIUM Lift Kit (Silver Powder Coat)	15
57015	F-150	09-14	2WD / 4WD		Upgraded Compression Struts (pr.)	15
57010	F-150	09-14	2WD / 4WD	2.25"	Front Leveling Kit	15
57100	F-150	2015	4WD Only	6.5"	PREMIUM Lift Kit (Silver Powder Coat)	16
57210	F-250 / F-350	05-07	2WD / 4WD	2.5"	Front Leveling Lift Kit (Coil Spacers & Shock Extenders)	18
57231	F-250	05-07	4WD	6"	Lift Kit - Phase 1 (Silver Powder Coat)	17
57232	F-250	05-07	4WD	6"	Lift Kit - Phase 2 (Silver Powder Coat)	17
57233	F-250	05-07	4WD	6"	Lift Kit - Phase 3 (Silver Powder Coat)	17
57331	F-350	05-07	4WD	6"	Lift Kit - Phase 1 (Silver Powder Coat)	17
57332	F-350	05-07	4WD	6"	Lift Kit - Phase 2 (Silver Powder Coat)	17
57333	F-350	05-07	4WD	6"	Lift Kit - Phase 3 (Silver Powder Coat)	17
57236	F-250	05-07	4WD	8"	Lift Kit - Phase 1 (Silver Powder Coat)	17
57237	F-250	05-07	4WD	8"	Lift Kit - Phase 2 (Silver Powder Coat)	17
57238	F-250	05-07	4WD	8"	Lift Kit - Phase 3 (Silver Powder Coat)	17
57336	F-350	05-07	4WD	8"	Lift Kit - Phase 1 (Silver Powder Coat)	17
57337	F-350	05-07	4WD	8"	Lift Kit - Phase 2 (Silver Powder Coat)	17
57338	F-350	05-07	4WD	8"	Lift Kit - Phase 3 (Silver Powder Coat)	17
57210	F-250 / F-350	08-10	2WD / 4WD	2.5"	Front Leveling Lift Kit (Coil Spacers & Shock Extenders)	18
57241	F-250	08-10	4WD	6"	Lift Kit - Phase 1 (Silver Powder Coat)	17
57242	F-250	08-10	4WD	6"	Lift Kit - Phase 2 (Silver Powder Coat)	17
57243	F-250	08-10	4WD	6"	Lift Kit - Phase 3 (Silver Powder Coat)	17
57341	F-350	08-10	4WD	6"	Lift Kit - Phase 1 (Silver Powder Coat)	17
57342	F-350	08-10	4WD	6"	Lift Kit - Phase 2 (Silver Powder Coat)	17
57343	F-350	08-10	4WD	6"	Lift Kit - Phase 3 (Silver Powder Coat)	17
57246	F-250	08-10	4WD	8"	Lift Kit - Phase 1 (Silver Powder Coat)	17
57247	F-250	08-10	4WD	8"	Lift Kit - Phase 2 (Silver Powder Coat)	17
57248	F-250	08-10	4WD	8"	Lift Kit - Phase 3 (Silver Powder Coat)	17
57346	F-350	08-10	4WD	8"	Lift Kit - Phase 1 (Silver Powder Coat)	17
57347	F-350	08-10	4WD	8"	Lift Kit - Phase 2 (Silver Powder Coat)	17
57348	F-350	08-10	4WD	8"	Lift Kit - Phase 3 (Silver Powder Coat)	17
57210	F-250 / F-350	11-15	2WD / 4WD	2.5"	Front Leveling Lift Kit (Coil Spacers & Shock Extenders)	18
57261	F-250	11-15	4WD	6"	Lift Kit - Phase 1 (Silver Powder Coat)	17
57262	F-250	11-15	4WD	6"	Lift Kit - Phase 2 (Silver Powder Coat)	17
57263	F-250	11-15	4WD	6"	Lift Kit - Phase 3 (Silver Powder Coat)	17
57361	F-350	11-15	4WD	6"	Lift Kit - Phase 1 (Silver Powder Coat)	17
57362	F-350	11-15	4WD	6"	Lift Kit - Phase 2 (Silver Powder Coat)	17
57363	F-350	11-15	4WD	6"	Lift Kit - Phase 3 (Silver Powder Coat)	17
57281	F-250	11-15	4WD	8"	Lift Kit - Phase 1 (Silver Powder Coat)	17
57282	F-250	11-15	4WD	8"	Lift Kit - Phase 2 (Silver Powder Coat)	17
57283	F-250	11-15	4WD	8"	Lift Kit - Phase 3 (Silver Powder Coat)	17
57381	F-350	11-15	4WD	8"	Lift Kit - Phase 1 (Silver Powder Coat)	17
57382	F-350	11-15	4WD	8"	Lift Kit - Phase 2 (Silver Powder Coat)	17
57383	F-350	11-15	4WD	8"	Lift Kit - Phase 3 (Silver Powder Coat)	17
57218	F-250 / F-350	05-13	4WD ONLY		60" Traction Bar Kit w/ Hardware	18

DODGE RAM LIFT KITS & PARTS

PART #	MODEL	YEAR	APPLICATION	LIFT	KIT	PAGE #
54310	2500/3500	03-13	2WD / 4WD	2.5"	Front Leveling Kit (Coil Spacers & Shock Extenders)	19
54300	2500/3500	03-08	4WD GAS MOTOR	8"	PREMIUM Lift Kit (Silver Powder Coat)	19
54350	2500/3500	03-08	4WD DIESEL	8"	PREMIUM Lift Kit (Silver Powder Coat)	19
54310	2500/3500	03-13	2WD / 4WD	2.5"	Front Leveling Kit (Coil Spacers & Shock Extenders)	19
54900	2500/3500	09-13	4WD GAS MOTOR	8"	PREMIUM Lift Kit (Silver Powder Coat)	19
54950	2500/3500	09-13	4WD DIESEL	8"	PREMIUM Lift Kit (Silver Powder Coat)	19
54314	2500/3500	2014	2WD / 4WD	2.5"	Front Leveling Kit (Coil Spacers & Shock Extenders)	19
54341	2500	14-16	4WD Coil Spring Rear	4"	Basic Lift Kit (Silver Powder Coat)	20
54340	2500	14-16	4WD Coil Spring Rear	4"	PREMIUM Lift Kit (Silver Powder Coat)	20
54327	2500	14-16	4WD Coil Spring Rear	6"	Basic Lift Kit (Silver Powder Coat)	20
54326	2500	14-16	4WD Coil Spring Rear	6"	PREMIUM Lift Kit (Silver Powder Coat)	20
54320	2500	14-16	4WD Coil Spring Rear	8"	PREMIUM Lift Kit (Silver Powder Coat)	20
54328	2500	14-16	4WD		Dual Steering Stabilizer Mount (Shock not included)	19
54346	3500	13-16	4WD, Leaf Spring Rear	4"	Basic Lift Kit (Silver Powder Coat)	21
54345	3500	13-16	4WD, Leaf Spring Rear	4"	PREMIUM Lift Kit (Silver Powder Coat)	21
54329	3500	13-16	4WD, Leaf Spring Rear	6"	PREMIUM Lift Kit (Silver Powder Coat)	21
54324	3500	13-16	4WD, Leaf Spring Rear	8"	PREMIUM Lift Kit (Silver Powder Coat)	21
54318	3500	02-15	4WD ONLY		60" Traction Bar Kit w/ Hardware	19
54328	3500	14-15	4WD		Dual Steering Stabilizer Mount (Shock not included)	19





WE MANUFACTURE DIFFERENT LIFT KITS AND OPTIONS. WHEREVER YOU SEE THIS SYMBOL, THIS IS OUR RECOMMENDATION FOR OUR BEST COMPLETE SUSPENSION KIT FOR YOUR VEHICLE.

7" PREMIUM LIFT KIT
W/ FRONT & REAR SHOCKS
PART# 50000 (4WD)

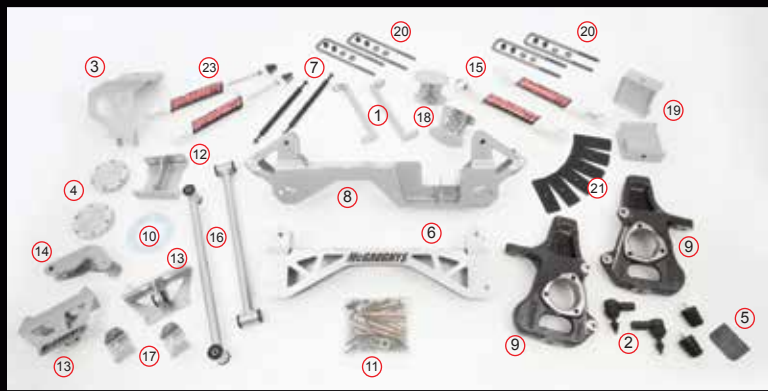

- 1. Lower A-Frame Support Rods
- 2. Tie Rods
- 3. Skid Plate
- 4. CV Axle Spacers
- 5. Frame Support Weld-in Bracket
- 6. Front Crossmember
- 7. Sway Bar End Links
- 8. Rear Crossmember
- 9. Lift Spindles
- 10. Spare Tire Spacer
- 11. Hardware Pack
- 12. Pass. Diff. Drop Bracket
- 13. Torsion Bar Drops
- 14. Driver Diff. Drop Bracket
- 15. Rear Shocks
- 16. Compression Struts
- 17. Compression Strut Brackets
- 18. Rear Bump Stop Ext.
- 19. Rear Lift Blocks
- 20. U-Bolts
- 21. Lift Block Spacers
- 23. Front Shocks



2" FRONT LEVELING LIFT KIT:
- LIFT KEYS
PART# 50100 (4WD)



TRACTION BAR KIT
W/ SHACKLES, UPPER FRAME BRACKETS, LOWER AXLE MOUNTS & HARDWARE (COMES IN RAW)
PART #50018 (2WD / 4WD)



7"

1.25" Add a Leaf w/ Center Pins - 2WD/4WD (#50005)

6" Fabricated Blocks (#50705)

Compression Struts (#50115)

McGaughy's Front Lift Shock (#2350B)

(Included in 7" kit)

McGaughy's Rear Lift Shock (#2950)

(Included in 7" kit)

7" BASIC Lift Kit (#50723 Pictured)



7" BASIC LIFT KIT

W/ FRONT & REAR SHOCKS

PART#50703 (2WD) PART# 50723 (4WD)

- | | | |
|------------------------|----------------------------------|--------------------------------|
| 1. U-Bolts w/ Hardware | 7. Hardware Pack | 12. Compression Strut Brackets |
| 2. Lift Blocks | 8. Front Brake Line Bracket Ext. | 13. Sway Bar Drops |
| 3. Rear Shocks | 9. Compression Struts | 14. Sway Bar Ext. |
| 4. Rear Crossmember | 10. CV Axle Spacers | 15. Differential Drops |
| 5. Outer Tie-Rod Ends | 11. Front Crossmember | 16. Adj. Front Struts |
| 6. Front Lift Spindles | | |

7" PREMIUM LIFT KIT



(PART# 50720 shown)



7" PREMIUM LIFT KIT

W/ ADJ. FRONT & REAR STRUTS

- | | |
|--|--------------------------------|
| 2. Adj. Lift Struts | 13. CV Axle Spacers |
| 3. U-Bolts w/ Hardware | 15. Compression Struts |
| 4. Lift Blocks | 16. Low. A-Frame Support Rods |
| 5. Rear Shocks | 17. Front Crossmember |
| 6. Rear Crossmember | 18. Compression Strut Brackets |
| 7. Rear Bump Stop Extenders | 19. Sway Bar Drops |
| 9. Front Lift Spindles | 20. Sway Bar Extenders |
| 10. Hardware Pack | 22. Skid Plate |
| 12. Front Brake Line Bracket Extenders | 24. Differential Drops |

7" BLACK SS LIFT KIT



(PART# 50721 shown)

7" PREMIUM LIFT KIT (SILVER POWDER COAT):

PART# 50700 (2WD) PART# 50720 (4WD)

7" PREMIUM BLACK SS LIFT KIT (BLACK POWDER COAT):

Kit comes w/ Black Powder Coat, Polished Stainless Steel Inserts, and Polished Allen Bolts (As shown in picture to the left)

PART# 50701 (2WD) PART# 50721 (4WD)



1.5" FRONT LEVELING LIFT KIT:

Kit includes Upper & Lower Strut Spacers

PART# 50710 (2WD / 4WD)



7"



7"



**TRACTION
BAR KIT**
 W/ SHACKLES, UPPER FRAME
 BRACKETS, LOWER AXLE MOUNTS &
 HARDWARE (COMES IN RAW)
PART #50018 (2WD / 4WD)



7"



7"

**6" Fabricated
Blocks (#50705)**

Compression Struts (#50715)

**McGaughy's Rear Lift
Shock (#2950)**

(Included in 7" kit)

**McGaughy's Front Lift
Struts (7" - 9") (#3507)**

(Included in 7" kit)

Add-a-Leaf (#50005)



7"

7" BASIC Black Lift Kit (#50765 Pictured)



7" BASIC LIFT KIT

W/ FRONT & REAR SHOCKS

PART#50764 (2WD)

PART# 50765 (4WD)

- | | |
|----------------------------------|--------------------------------|
| 1. U-Bolts w/ Hardware | 9. Compression Struts |
| 2. Lift Blocks | 10. CV Axle Spacers |
| 3. Rear Shocks | 11. Front Crossmember |
| 4. Rear Crossmember | 12. Compression Strut Brackets |
| 5. Outer Tie-Rod Ends | 13. Sway Bar Drops |
| 6. Front Lift Spindles | 14. Sway Bar Extenders |
| 7. Hardware Pack | 15. Differential Drops |
| 8. Front Brake Line Bracket Ext. | 16. Adj. Front Struts |

7" PREMIUM LIFT KIT



(PART# 50769 shown)



7" PREMIUM LIFT KIT

W/ FRONT & REAR SHOCKS

- | | | |
|----------------------------------|-----------------------------------|--------------------------------|
| 1. Spare Tire Spacer | 11. Weld-in Filler Plate | 19. Sway Bar Drops |
| 2. Outer Tie-Rod Ends | 12. Front Brake Line Bracket Ext. | 20. Sway Bar Ext. |
| 3. U-Bolts w/ Hardware | 13. CV Axle Spacers | 21. Lower Strut Ext. |
| 4. Lift Blocks | 14. Hardware Pack | 22. Skid Plate |
| 5. Rear Shocks | 15. Compression Struts | 23. Upp. Clam Shell Strut Ext. |
| 6. Rear Crossmember | 16. Low. A-Frame Support Rods | 24. Driver Diff. Drop |
| 7. Rear Bump Stop Ext. | 17. Front Crossmember | 25. Pass. Diff. Drop |
| 8. Factory Strut Bushing Spacers | 18. Compression Strut Brackets | 26. Adj. Lift Struts |
| 9. Front Lift Spindles | | |
| 10. Hardware Pack | | |

7" BLACK SS LIFT KIT



(PART# 50767-SSB shown)

7" PREMIUM LIFT KIT (SILVER POWDER COAT):

PART# 50768 (2WD)

PART# 50769 (4WD)

7" PREMIUM BLACK SS LIFT KIT

(BLACK POWDER COAT):

Kit comes w/ Black Powder Coat, Polished Stainless Steel Inserts, and Polished Allen Bolts (As shown in picture to the left)

PART# 50766-SSB (2WD)

PART# 50767-SSB (4WD)

7" PREMIUM SILVER SS LIFT KIT

(SILVER POWDER COAT):

Kit comes w/ Silver Powder Coat, Polished Stainless Steel Inserts, and Polished Allen Bolts

PART# 50766-SSS (2WD)

PART# 50767-SSS (4WD)



TRACTION BAR KIT

W/ SHACKLES, UPPER FRAME BRACKETS & LOWER AXLE MOUNTS

PART #5001B (2WD / 4WD)

Add-a-Leaf (#50005)



6" Fabricated Blocks (#50770)



7"



4"

7" Lift Kit for Factory Auto Leveling (#50125 Pictured)



7" LIFT KIT - AUTO LEVELING
W/ FRONT & REAR SHOCK EXTENDERS
PART#50125 (2WD) PART# 50135 (4WD)

- | | | |
|--------------------------------|----------------------------------|---------------------------------|
| 1. Rear Crossmember | 13. Hardware Pack | 20. Coil Springs |
| 2. Front Crossmember | 14. Weld-in Filler Plate | 21. Front Shocks |
| 4. Outer Tie-Rod Ends | 15. Hardware Pack | 22. Rear Tailing Arm Relocators |
| 7. Lift Spindles | 16. Low. A-Frame Support Rods | 23. Rear Brake Line Ext. |
| 8. Sway Bar End Links | 17. Track Bar Relocation Bracket | 24. Rear Bump Stop Ext. |
| 9. Compression Struts | 18. Track Bar Bracket Support | 25. Shock Extenders |
| 10. Compression Strut Brackets | 19. Skid Plate | 26. Torsion Bar Drop |
| 11. Bump Stops | | 27. Track Bar Brackets |
| 12. Spare Tire Spacer | | |



WE MANUFACTURE DIFFERENT LIFT KITS AND OPTIONS. WHEREVER YOU SEE THIS SYMBOL, THIS IS OUR RECOMMENDATION FOR OUR BEST COMPLETE SUSPENSION KIT FOR YOUR VEHICLE.

7" LIFT KIT - NOT AUTO LEVELING
W/ FRONT & REAR SHOCK EXTENDERS

- | | | |
|------------------------------|--------------------------------|-------------------------------|
| 1. Rear Crossmember | 9. Compression Struts | Relocation Bracket |
| 2. Front Crossmember | 10. Compression Strut Brackets | 18. Track Bar Bracket Support |
| 3. CV Axle Spacers | 11. Bump Stops | 19. Skid Plate |
| 4. Outer Tie-Rod Ends | 12. Spare Tire Spacer | 20. Coil Springs |
| 5. Driver Diff. Drop Bracket | 13. Hardware Pack | 21. Front Shocks |
| 6. Pass. Diff. Drop Bracket | 14. Weld-in Filler Plate | 23. Rear Brake Line Ext. |
| 7. Lift Spindles | 15. Hardware Pack | 24. Rear Bump Stop Ext. |
| 8. Sway Bar End Links | 16. Low. A-Frame Support Rods | 25. Shock Extenders |
| | 17. Track Bar | 26. Torsion Bar Drop |
| | | 27. Track Bar Brackets |



7" LIFT KIT (SILVER POWDER COAT):
PART# 50128 (2WD) PART# 50138 (4WD)

7" LIFT KIT AUTO LEVELING

(PART# 50138 shown)



2" FRONT LEVELING LIFT KIT
- LIFT KEYS

PART# 50100 (2WD/4WD)

McGaughy's Front Lift Shock (#2350B)



(Included in 7" kit)

McGaughy's Rear Lift Shock (#2950)



MCGAUGHY'S SHOCKS

MCGAUGHY'S FRONT LIFT SHOCK
PART#2350B

MCGAUGHY'S REAR LIFT SHOCK
PART# 2950



7"

7" LIFT KIT



(PART# 50738 shown)

7" LIFT KIT AUTO LEVELING (SILVER POWDER COAT):

PART# 50725 (2WD) PART# 50735 (4WD)

7" LIFT KIT NOT AUTO LEVELING (SILVER POWDER COAT):

PART# 50728 (2WD) PART# 50738 (4WD)



07-13 7" LIFT KIT W/ REAR SHOCK EXTENDERS & FRONT STRUTS

- | | | |
|--------------------------------|---|---------------------------------|
| 1. Lift Spindles | 13. CV Axle Spacers | 20. Rear Brake Line Ext. |
| 2. Front Brake Line Ext. | 14. Hardware Pack | 21. Track Bar Relocator Bracket |
| 3. Skid Plate | 15. Diff. Drop Brackets | 22. Sway Bar End Links |
| 7. Front Crossmember | 16. Driver Side Rear Trailing Arm Relocator | 23. Track Bar Relocator Bracket |
| 9. Low. A-Frame Support Rods | 17. Rear Coil Springs | 24. Rear Bump Stop Ext. |
| 10. Compression Strut Brackets | 18. Pass. Side Rear Trailing Arm Relocator | 25. Hardware Pack |
| 11. Rear Crossmember | 19. Rear Shock Ext. | 28. Front Lift Struts |



1.5" FRONT LEVELING LIFT KIT:

Kit includes Upper & Lower Strut Spacers
PART# 50710 (2WD / 4WD)



7" LIFT KIT



(PART# 50805 shown)

- | | | |
|-------------------------------|---|---------------------------------|
| 1. Rear Crossmember | 9. CV Axle Spacers | 15. Coil Springs |
| 2. Front Crossmember | 10. Rear Shock Extenders | 16. Differential Drops |
| 3. Compression Strut Brackets | 11. Sway Bar End Links | 17. Sway Bar Drops |
| 4. Spindles | 12. Rear Bump Stop Extenders | 18. Track Bar Relocator Bracket |
| 5. Front Brake Line Extenders | 13. Rear Trailing Arm Relocator | 19. Compression Struts |
| 6. Outer Tie Rod Ends | 14. Track Bar Relocator Bracket Support | 20. Low. A-Frame Support Rods |
| 7. Hardware | | 21. Front Struts |
| 8. Spare Tire Spacer | | 22. Skid Plate |



14-15 7" LIFT KIT W/ REAR SHOCK EXTENDERS & FRONT STRUTS

7" LIFT KIT - (SILVER POWDER COAT):

PART# 50800 (2WD, No Auto Leveling)

PART# 50805 (4WD, No Auto Leveling)

PART# 50801 (2WD, Auto Leveling)

PART# 50806 (4WD, Auto Leveling)

7" BLACK SS LIFT KIT - (BLACK POWDER COAT):

Kits come w/ Black Powder Coat, Polished Stainless Steel Inserts, and Polished Allen Bolts (As shown in picture to the left)

PART# 50803 (2WD, No Auto Leveling)

PART# 50808 (4WD, No Auto Leveling)

PART# 50804 (2WD, Auto Leveling)

PART# 50809 (4WD, Auto Leveling)

(AUTO LEVELING KITS INCLUDE FRONT CLAM SHELLS INSTEAD OF STRUTS)



7" PREMIUM LIFT KIT



7" PREMIUM 2500 LIFT KIT

(SILVER POWDER COAT):

PART# 52000 (2WD, Diesel)

PART# 52050 (4WD, Diesel)

PART# 52003 (2WD, Gas Motor)

PART# 52053 (4WD, Gas Motor)

7" PREMIUM 3500 LIFT KIT

(SILVER POWDER COAT): W/ UPPER CONTACT OVERLOAD

PART# 52001 (2WD, Diesel)

PART# 52051 (4WD, Diesel)

PART# 52004 (2WD, Gas Motor)

PART# 52054 (4WD, Gas Motor)



7" PREMIUM LIFT KIT
W/ FRONT & REAR SHOCKS

- | | |
|------------------------------|-------------------------------------|
| 1. Compression Struts | 12. Pass. Diff. Drop |
| 2. CV Axle Spacers | 13. Rear Brake Line Extender |
| 3. Front Shocks | 14. Driver Upper Diff. Drop Bracket |
| 4. Rear Shocks | 15. Rear Crossmember |
| 5. Skid Plate | 16. Front Crossmember |
| 6. U-Bolts | 17. Front Bump Stop Extenders |
| 7. Lift Blocks | 18. Compression Strut Brackets |
| 8. Low. A-Frame Support Rods | 19. Torsion Bar Drop Brackets |
| 9. Lift Spindles | |
| 10. Hardware Pack | |
| 11. Rear Bump Stop Ext. | |



2" FRONT LEVELING LIFT KIT:

- LEVELING KEYS & SHOCK EXTENDERS

PART# 52100
(2WD/4WD, 8-LUG)



TRACTION BAR KIT

W/ SHACKLES, UPPER FRAME BRACKETS, LOWER AXLE MOUNTS & HARDWARE (COMES IN RAW)

PART #52018 (2WD / 4WD)



7"



Replacement Factory Differential Bushing Bracket

- The bracket is used if you already cut-off your factory diff. bushing. You can put the diff. back to stock. All of our kits need this if your bushing is cut and/or missing. 4WD (#52160)



Compression Struts 2WD/4WD (#52115)



Boxed Upper A-Frames w/ Bushings & Ball Joints- 2WD/4WD (#52151)



Double Shock Hoop & Upper A-Frames Color May Vary (#52150)



McGaughy's Front Lift Shock (#2350)



McGaughy's Rear Lift Shock (#3250)



7"





WE MANUFACTURE DIFFERENT LIFT KITS AND OPTIONS. WHEREVER YOU SEE THIS SYMBOL, THIS IS OUR RECOMMENDATION FOR OUR BEST COMPLETE SUSPENSION KIT FOR YOUR VEHICLE.

7" PREMIUM LIFT KIT



(PART# 52350 shown)



**7" PREMIUM LIFT KIT
W/ FRONT & REAR SHOCKS**

- | | |
|---------------------------------------|---|
| 1. Rear Crossmember | 12. Hardware Pack |
| 2. Torsion Bar Drops | 13. Compression Struts |
| 3. Skid Plate | 14. Rear Bump Stops |
| 4. Front Crossmember | 15. Lift Spindles |
| 5. Outer Front Bump Stop Brackets | 16. Lower A-Frame Support Rods |
| 6. Bump Stops | 17. Front Bump Stops |
| 7. Differential Drop | 18. Brake Cable Extension |
| 8. Sway Bar End Links | 19. Rear Brake Bracket Ext. |
| 9. Compression Strut Brackets | 20. Rear Compression Strut Bracket Retainer |
| 10. CV Axle Spacer | 21. Front Brake Line Bracket Ext. |
| 11. U-Bolts w/ Hardware & Lift Blocks | |

**7" PREMIUM 2500 LIFT KIT
(SILVER POWDER COAT):**

- | | |
|------------------------------------|------------------------------------|
| PART# 52300 (2WD) | PART# 52350 (4WD) |
| PART# 52303 (2WD Gas Motor) | PART# 52353 (4WD Gas Motor) |

**7" PREMIUM 3500 LIFT KIT
(SILVER POWDER COAT):**

- | | |
|------------------------------------|------------------------------------|
| PART# 52301 (2WD) | PART# 52351 (4WD) |
| PART# 52304 (2WD Gas Motor) | PART# 52354 (4WD Gas Motor) |



7"



7"

7" PREMIUM BLACK SS LIFT KIT

(PART# 52356 shown)



7" PREMIUM 2500 LIFT KIT

- | | |
|--------------------------|--------------------------|
| PART# 52355 (2WD) | PART# 52356 (4WD) |
|--------------------------|--------------------------|

7" PREMIUM 3500 LIFT KIT

- | | |
|--------------------------|--------------------------|
| PART# 52358 (2WD) | PART# 52359 (4WD) |
|--------------------------|--------------------------|



**7" PREMIUM BLACK SS LIFT KIT
W/ FRONT & REAR SHOCKS**

Kits come w/ Black Powder Coat, Polished Stainless Steel Inserts, and Polished Allen Bolts (As shown in picture to the left)

- | | |
|---------------------------------------|---|
| 1. Rear Crossmember | 12. Hardware Pack |
| 2. Torsion Bar Drops | 13. Compression Struts |
| 3. Skid Plate | 14. Rear Bump Stops |
| 4. Front Crossmember | 15. Lift Spindles |
| 5. Outer Front Bump Stop Brackets | 16. Lower A-Frame Support Rods |
| 6. Bump Stops | 17. Front Bump Stops |
| 7. Differential Drop | 18. Brake Cable Extension |
| 8. Sway Bar End Links | 19. Rear Brake Bracket Ext. |
| 9. Compression Strut Brackets | 20. Rear Compression Strut Bracket Retainer |
| 10. CV Axle Spacer | 21. Front Brake Line Bracket Ext. |
| 11. U-Bolts w/ Hardware & Lift Blocks | |

7" PREMIUM LIFT KIT

(PART# 52306 shown)



7" PREMIUM NTD LIFT KIT - 4WD (SILVER POWDER COAT)

PART# 52305 (No Dually)
PART# 52306 (Dually Only)



7" PREMIUM LIFT KIT W/ FRONT & REAR SHOCKS

- | | |
|---------------------------------------|---|
| 1. Rear Crossmember | 12. Hardware Pack |
| 3. Skid Plate | 13. Compression Struts |
| 4. Front Crossmember | 14. Rear Bump Stops |
| 5. Outer Front Bump Stop Brackets | 15. Lift Spindles |
| 6. Bump Stops | 16. Lower A-Frame Support Rods |
| 7. Differential Drop | 17. Front Bump Stops |
| 8. Sway Bar End Links | 18. Brake Cable Extension |
| 9. Compression Strut Brackets | 19. Rear Brake Bracket Ext. |
| 10. CV Axle Spacer | 20. Rear Compression Strut Bracket Retainer |
| 11. U-Bolts w/ Hardware & Lift Blocks | 21. Front Brake Line Bracket Ext. |
| | 22. NTD Lift Kit |



2" FRONT LEVELING LIFT KIT:
- KEYS, FRONT SHOCK SPACER, & FRONT SHOCK NUTS
PART# 52310
(2WD/4WD, 8-LUG)



TRACTION BAR KIT
W/ SHACKLES, UPPER FRAME BRACKETS, LOWER AXLE MOUNTS & HARDWARE (COMES IN RAW)
PART #52318 (2WD / 4WD)



Boxed Upper A-Frames w/ Ball Joints & Bushings (2WD/4WD) (#52314)



McGaughy's Front Lift Shock (#2600)



Compression Struts 2WD/4WD (#52315)



McGaughy's Rear Lift Shock (#3250)



Shock Reservoir Upper Mount (Comes Raw) (#52357)





WE MANUFACTURE DIFFERENT LIFT KITS AND OPTIONS. WHEREVER YOU SEE THIS SYMBOL, THIS IS OUR RECOMMENDATION FOR OUR BEST COMPLETE SUSPENSION KIT FOR YOUR VEHICLE.

09-14 6.5" PREMIUM LIFT KIT

(PART# 57000 shown)

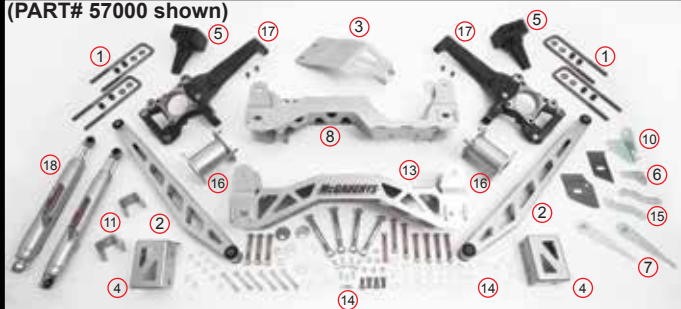

6.5" PREMIUM LIFT KIT

W/ REAR SHOCKS (2009-2014)

- | | |
|-----------------------------------|--------------------------------|
| 1. U-Bolts w/ Hardware | Brake Bracket |
| 2. Compression Struts | 11. Compression Strut Brackets |
| 3. Skid Plate | 13. Front Crossmember |
| 4. Sway Bar Drops | 14. Hardware Pack |
| 5. Lift Blocks | 15. Front Brake Line Brackets |
| 6. Rear Brake Line Bracket | 16. Strut Spacers |
| 7. Compression Strut Bracket Nuts | 17. Spindles |
| 8. Rear Crossmember | 18. Rear Shocks |
| 10. Rear Emergency | |

2009-14 6.5" PREMIUM LIFT KIT (SILVER POWDER COAT):

PART# 57000 (2WD) PART# 57050 (4WD)



2.5" FRONT LEVELING LIFT KIT:

- STRUT SPACERS (04-08)
PART# 57810
(2WD/4WD)



2.25" FRONT LEVELING LIFT KIT:

- STRUT SPACERS (09-14)
PART# 57010
(2WD/4WD)



ADDITIONAL OPTIONS:

UPGRADED COMPRESSION STRUTS
PART# 57015 (2009-2014)



6.5"

2015

6.5" PREMIUM LIFT KIT W/ REAR SHOCKS (2015) # 57100 (4WD ONLY)

6.5" PREMIUM LIFT KIT



(PART# 57100 shown)

- | | |
|--------------------------------|-------------------------------|
| 1. U-Bolts w/ Hardware | 12. Pass. Diff. Brace |
| 2. Compression Struts | 13. Front Crossmember |
| 3. Skid Plate | 14. Hardware Pack |
| 4. Sway Bar Drops | 15. Front Brake Line Brackets |
| 5. Lift Blocks | 16. Strut Spacers |
| 6. Rear Brake Line Bracket | 17. Spindles |
| 7. Compression Strut Hardware | 18. Rear Shocks |
| 8. Rear Crossmember | 19. Drive Line Spacer |
| 9. Differential Drops | |
| 11. Compression Strut Brackets | |





8"



6" Lift Kit Phase 1

6" LIFT KIT PHASE 1- 4WD
LIFT KIT W/ FACTORY RADIUS ARM DROP DOWN BRACKETS, FRONT & REAR SHOCKS

- | | |
|--|--|
| PART# 57231 (F-250) - 2005-2007 | PART# 57331 (F-350) - 2005-2007 |
| PART# 57241 (F-250) - 2008-2010 | PART# 57341 (F-350) - 2008-2010 |
| PART# 57261 (F-250) - 2011-2015 | PART# 57361 (F-350) - 2011-2015 |

- 6" LIFT KIT PHASE 2 - 4WD**
LIFT KIT W/ RADIUS ARMS, FRONT & REAR SHOCKS
- | | |
|--|--|
| PART# 57232 (F-250) - 2005-2007 | PART# 57332 (F-350) - 2005-2007 |
| PART# 57242 (F-250) - 2008-2010 | PART# 57342 (F-350) - 2008-2010 |
| PART# 57262 (F-250) - 2011-2015 | PART# 57362 (F-350) - 2011-2015 |



6" Lift Kit Phase 2



6" LIFT KIT PHASE 3

6" LIFT KIT PHASE 3 - 4WD
LIFT KIT W/ 4-LINK DROP DOWN BRACKETS, UPPER 4-LINK BARS, LOWER 4-LINK BARS, FRONT & REAR SHOCKS

- | | |
|--|--|
| PART# 57233 (F-250) - 2005-2007 | PART# 57333 (F-350) - 2005-2007 |
| PART# 57243 (F-250) - 2008-2010 | PART# 57343 (F-350) - 2008-2010 |
| PART# 57263 (F-250) - 2011-2015 | PART# 57363 (F-350) - 2011-2015 |



6" LIFT KIT PHASE 3

- | | |
|-----------------------------|-------------------------------|
| 1. Front Shocks | 11. Front Bump Stops |
| 2. Hardware Pack | 12. Steering Shock Drop |
| 3. Coil Springs | 14. Rear Shocks |
| 4. U-Bolt Retainers | 15. Front Brake Line Brackets |
| 5. U-Bolts | 16. Rear Brake Line Bracket |
| 6. Hardware Pack | |
| 7. Lift Blocks | |
| 8. Sway Bar Drops | |
| 10. Track Bar Drop Brackets | |



8" LIFT KIT PHASE 3

8" LIFT KIT PHASE 3 - 4WD
LIFT KIT W/ 4-LINK DROP DOWN BRACKETS, UPPER BOXED 4-LINK BARS, LOWER BOXED 4-LINK BARS, FRONT & REAR SHOCKS

- | | |
|--|--|
| PART# 57238 (F-250) - 2005-2007 | PART# 57338 (F-350) - 2005-2007 |
| PART# 57248 (F-250) - 2008-2010 | PART# 57348 (F-350) - 2008-2010 |
| PART# 57283 (F-250) - 2011-2015 | PART# 57383 (F-350) - 2011-2015 |



2.5" FRONT LEVELING LIFT KIT:
- COIL SPACERS & SHOCK EXTENDERS
PART# 57210 (2WD/4WD, 8-LUG)

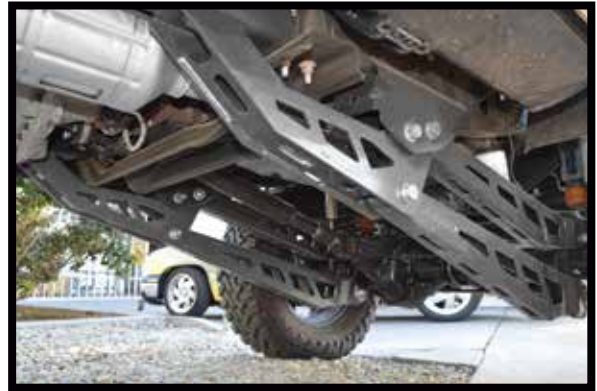

TRACTION BAR KIT
W/ SHACKLES, UPPER FRAME BRACKETS, LOWER AXLE MOUNTS & HARDWARE (COMES IN RAW)
PART# 57218 (2WD / 4WD)



DUAL STEERING STABILIZER MOUNT
(1) CENTER MOUNT THAT BOLTS TO THE AXLE TO HOLD THE SHOCKS ON ONE END & (2) OUTER SHOCK MOUNT BRACKETS W/ HARDWARE
PART#57230 (2WD / 4WD)



8"



6"



8"



8"

8" PREMIUM LIFT KIT (2003-2008)



8" PREMIUM LIFT KIT W/ REAR SHOCKS

- 1. Hardware Pack
- 15. Radius Arm Drop Brackets w/ Frame Support Tubes
- 17. Long Arm brackets
- 18. Shock U-Brackets
- 19. Sway Bar End Link Brackets
- 20. Shocks
- 21. Coils Springs
- 23. Track Bar Bracket
- 25. Pitman Arm
- 28. Sway Bar Drop Brackets
- 33. Rear Brake Line Brackets
- 35. Lift Blocks
- 39. Bump Stop Ext.
- 40. Shocks
- 41. Brake Line
- 42. Re-locking Ring
- 43. Billet Seal Adapter
- 44. Seal
- 46. Carrier Bearing Spacers

8" PREMIUM LIFT KIT (09-13 2500/09-12 3500)



8" PREMIUM LIFT KIT

(SILVER POWDER COAT): 03-08 2500/3500
PART# 54300 (4WD, Gas Motor)
PART# 54350 (4WD, Diesel Motor)

8" PREMIUM LIFT KIT

(SILVER POWDER COAT): 09-13 2500 / 09-12 3500
PART# 54900 (4WD, Gas Motor)
PART# 54950 (4WD, Diesel Motor)



2.5" FRONT LEVELING LIFT KIT:
 - COIL SPACERS & SHOCK EXTENDERS (2WD/4WD, 8-LUG)
PART# 54310 (03-13 2500 / 03-12 3500)
PART# 54314 (14-15 2500 / 13-15 3500)



TRACTION BAR KIT
 W/ SHACKLES, UPPER FRAME BRACKETS, LOWER AXLE MOUNTS & HARDWARE
 [COMES IN RAW]
PART #54318 (4WD)



DUAL STEERING STABILIZER MOUNT:
 INNER SHOCK MOUNT W/ CLAMP OUTER SHOCK MOUNTS
 (SHOCKS NOT INCLUDED)
PART# 54328 (13-15 2500) (14-15 3500)



4" BASIC Lift Kit (PART# 54341 shown)

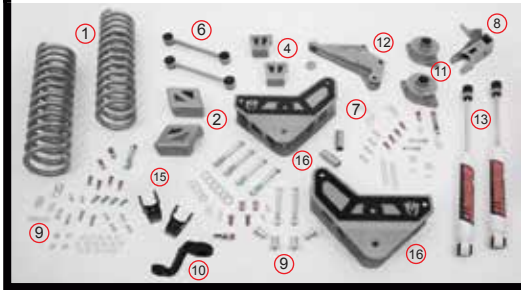

4" BASIC LIFT KIT W/ FRONT & REAR SHOCKS

PART#54341 (4WD, Coil Spring Rear)

- | | |
|---------------------------------|----------------------------------|
| 1. Coil Springs | 10. Pitman Arm |
| 4. Bump Stop Extension Brackets | 11. Coil Spring Spacers |
| 6. Track Bar Brackets | 12. Track Bar Relocation Bracket |
| 7. Brake Line Brackets | 13. Front Shocks |
| 8. Panhard Extension Bracket | 15. Rear Shock Extenders |
| 9. Hardware Pack | 16. Radius Arm Drop Downs |

4" PREMIUM LIFT KIT

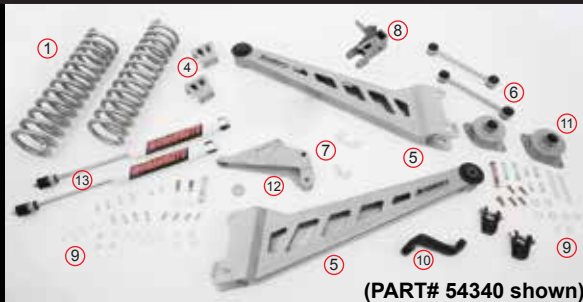

(PART# 54340 shown)



4" PREMIUM LIFT KIT W/ FRONT SHOCKS & REAR SHOCK EXTENDERS

- | | |
|---------------------------------|----------------------------------|
| 1. Coils Springs | 9. Hardware Pack |
| 3. Rear Bump Stop Extenders | 10. Pitman Arm |
| 4. Bump Stop Extension Brackets | 11. Coil Spring Spacers |
| 5. Radius Arms | 12. Track Bar Relocation Bracket |
| 6. Track Bar Brackets | 13. Front Shocks |
| 7. Brake Line Brackets | 15. Rear Shock Extenders |
| 8. Panhard Extension Bracket | |

**4" PREMIUM LIFT KIT (SILVER POWDER COAT):
PART# 54340** (4WD, Coil Spring Rear)

6" BASIC Lift Kit (PART# 54327 shown)

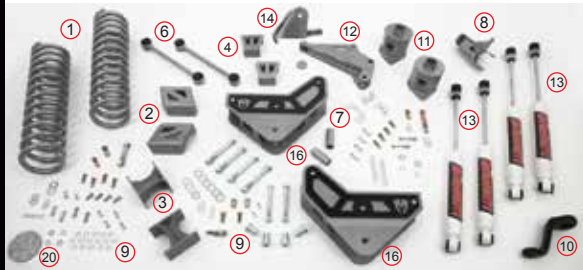

6" BASIC LIFT KIT W/ FRONT & REAR SHOCKS

PART#54327 (4WD, Coil Spring Rear)

- | | | |
|---------------------------------------|----------------------------------|-----------------------------------|
| 1. Coil Springs | 8. Panhard Extension Bracket | 14. Track Bar Reinforcement Brace |
| 2. Sway Bar End Links | 9. Hardware Pack | 16. Radius Arm Drop Downs |
| 3. Rear Bump Stop Extenders | 10. Pitman Arm | 20. Front Drive Line Spacer |
| 4. Front Bump Stop Extension Brackets | 11. Coil Spring Spacers | |
| 6. Track Bar Brackets | 12. Track Bar Relocation Bracket | |
| 7. Brake Line Brackets | 13. Front & Rear Shocks | |

6" PREMIUM LIFT KIT

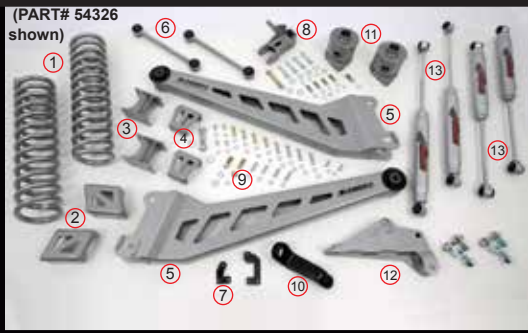

(PART# 54326 shown)



6" & 8" PREMIUM LIFT KIT W/ ADJ. FRONT & REAR STRUTS

(Parts included in both 6" & 8" Kits)

- | | |
|---------------------------------|-----------------------------------|
| 1. Coil Springs | 12. Track Bar Relocation Bracket |
| 2. Sway Bar End Links | 13. Shocks |
| 3. Rear Bump Stop Extenders | 14. Track Bar Reinforcement Brace |
| 4. Bump Stop Extension Brackets | 20. Front Drive Line Spacer |
| 5. Radius Arms | |
| 6. Track Bar Brackets | 8" KIT ONLY |
| 7. Brake Line Brackets | Includes the following: |
| 8. Panhard Extension Bracket | 16. Radius Arm Drop Downs |
| 9. Hardware Pack | 17. Coil Springs |
| 10. Pitman Arm | 18. Panhard Extension Bracket |
| 11. Rear Coil Spring Spacers | 19. Sway Bar Endlinks |

6" PREMIUM LIFT KIT

(SILVER POWDER COAT):

Kits come w/ Front Shocks & Rear Shock Extenders
PART# 54326 (4WD, Coil Spring Rear)

8" PREMIUM LIFT KIT

(SILVER POWDER COAT):

Kits come w/ Front & Rear Shocks
(Must specify which factory transmission will be used with the kit)
PART# 54320 (4WD, Coil Spring Rear)

8" PREMIUM LIFT KIT

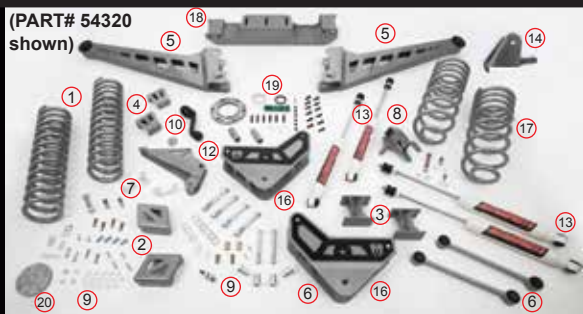

(PART# 54320 shown)

4" BASIC Lift Kit (PART# 54346 shown)



4" BASIC LIFT KIT

W/ FRONT & REAR SHOCK EXTENDERS
PART#54346 (4WD, Leaf Spring Rear)

- | | |
|---------------------------------------|----------------------------------|
| 1. Front Coil Springs | 9. Lift Blocks |
| 2. Sway Bar End Links | 10. Pitman Arm |
| 4. Front Bump Stop Extension Brackets | 11. Track Bar Relocation Bracket |
| 6. U-Bolts w/ Hardware | 12. Front Shocks |
| 7. Hardware Pack | 15. Rear Shock Extenders |
| 8. Brake Line Brackets | 16. Radius Arm Drop Downs |

4" PREMIUM LIFT KIT

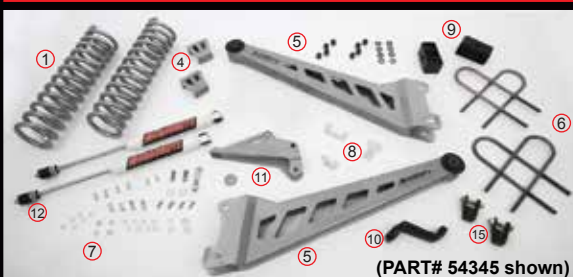

4" PREMIUM LIFT KIT

W/ FRONT SHOCKS & REAR SHOCK EXTENDERS

- | | | |
|---------------------------------|------------------------|----------------------------------|
| 1. Front Coil Springs | 7. Hardware Pack | 11. Track Bar Relocation Bracket |
| 4. Bump Stop Extension Brackets | 8. Brake Line Brackets | 12. Shocks |
| 5. Radius Arms | 9. Lift Blocks | 15. Shock Extenders |
| 6. U-Bolts | 10. Pitman Arm | |

4" PREMIUM LIFT KIT (SILVER POWDER COAT):
PART# 54345 (4WD, Leaf Spring Rear)

6" BASIC Lift Kit (PART# 54330 shown)



6" BASIC LIFT KIT

W/ FRONT & REAR SHOCKS
PART# 54330 (4WD, Leaf Spring Rear)

- | | |
|---------------------------------------|----------------------------------|
| 1. Front Coil Springs | 10. Pitman Arm |
| 2. Sway Bar End Links | 11. Track Bar Relocation Bracket |
| 4. Front Bump Stop Extension Brackets | 12. Front Shocks |
| 6. U-Bolts w/ Hardware | 13. Front Drive Line Spacer |
| 7. Hardware Pack | 16. Radius Arm Drop Downs |
| 8. Brake Line Brackets | 20. Rear Shock Extenders |
| 9. Lift Blocks | |

6" PREMIUM LIFT KIT

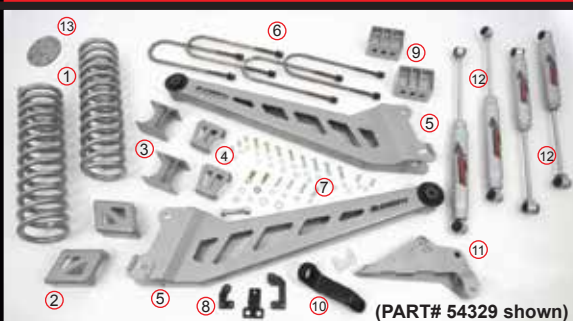

6" & 8" PREMIUM LIFT KIT

W/ ADJ. FRONT & REAR STRUTS

(Parts included in both 6" & 8" Kits)

- | | |
|---------------------------------|----------------------------------|
| 1. Front Coil Springs | 10. Pitman Arm |
| 2. Sway Bar End Links | 11. Track Bar Relocation Bracket |
| 3. Rear Bump Stop Extenders | 12. Shocks |
| 4. Bump Stop Extension Brackets | <u>8" KIT ONLY</u> |
| 5. Radius Arms | Includes the following: |
| 6. U-Bolts | 13. Front Drive Line Spacer |
| 7. Hardware Pack | 14. Rear Drive Line Spacer |
| 8. Brake Line Brackets | 16. Radius Arm Drop Downs |
| 9. Lift Blocks | 17. Crossmember |
| | 18. Re-Clocking Kit |

8" PREMIUM LIFT KIT

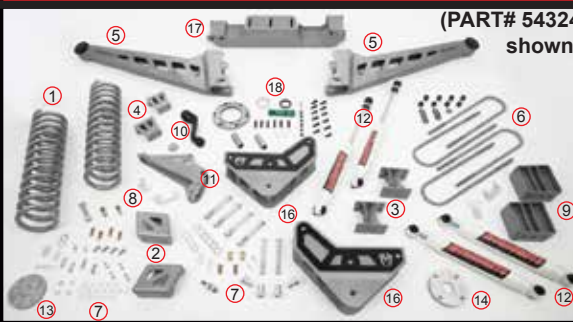

6" PREMIUM LIFT KIT

(SILVER POWDER COAT):

Kit comes w/ Front & Rear Shocks, & Fabricated Radius Arms
PART# 54329 (4WD, Leaf Spring Rear)

8" PREMIUM LIFT KIT

(SILVER POWDER COAT):

Kit comes w/ Front & Rear Shocks
PART# 54324 (4WD, Leaf Spring Rear)

LOWERING

GM TRUCK LOWERING KITS & PARTS

PART #	MODEL	YEAR	APPLICA-TION	FRONT DROP	REAR DROP	KIT	PAGE #
63120	GM 1/2TON	60-72				Trailing Arm Cross-Member (Built in Drive-Line Loop for Ground Clearance - Allows 3" Exhaust to go through center of Cross-Member)	33-34
63156	GM 1/2TON	60-72				5-Lug Disc Brake Kit w/ Rotors, Calipers, Bearings, Seals, Hoses, Dust Caps, Spindle Nuts, Spindles Washers, & Cotter Pins	33-34
63157	GM 1/2TON	60-72				6-Lug Disc Brake Kit w/ Rotors, Calipers, Bearings, Seals, Hoses, Dust Caps, Spindle Nuts, Spindles Washers, & Cotter Pins	33-34
63163	GM 1/2TON	60-72				Adj. Proportioning Valve w/ Lines & Bracket	33-34
63164	GM 1/2TON	60-62		2.5"		2.5" Drop Spindles - Converts to Disc Brakes	33-34
63165	GM 1/2TON	60-64				Adjustable Rear Track Bar	33-34
63167	GM 1/2TON	60-72				Rear C-Notch	33-34
63173	GM 1/2TON	63-70		2.5"		2.5" Drop Spindles - Converts to Disc Brakes	33-34
63174	GM 1/2TON	63-70		STOCK		Stock Height Spindles - Converts to Disc Brakes	33-34
63175	GM 1/2TON	65-72				Adjustable Rear Track Bar	33-34
63177	GM 1/2TON	60-66				7" Booster w/ Master Cyl. & Bracket for Front Disc Brakes	33-34
63178	GM 1/2TON	60-66				7" Booster w/ Master Cyl. & Bracket for Front Drum Brakes	33-34
63181	GM 1/2TON	60-66				9" Booster w/ Master Cyl. & Bracket for Front Disc Brakes	33-34
63182	GM 1/2TON	60-66				9" Booster w/ Master Cyl. & Bracket for Front Drum Brakes	33-34
63203	GM 1/2TON	60-66	2WD			Non-Power Master Cylinder (Dual Reservoir)	33-34
64090	GM 1/2TON	60-66	2WD			Non-Adj. Proportioning Valve w/ Lines & Bracket	33-34
63115	GM 1/2TON	63-72	2WD	2"		2" Drop Front Crossmember Kit	36
63117	GM 1/2TON	63-72	2WD			6" Over-Stock Rear C-Notch Kit	37
63122	GM 1/2TON	63-72	2WD		0	Adjustable Trailing Arm Crossmember w/ Integrated Drive-Line Loop, Transmission Crossmember & Center Supports	37
63123	GM 1/2TON	63-72		3.5"		3.5" Adjustable Trailing Arms w/ 1.25" Johnny Joints	37
63125	GM 1/2TON	63-72				Side Exit Exhaust Mounts	38
63126	GM 1/2TON	63-72				Rear Bolt-On Frame Support w/ Hardware	38
63127	GM 1/2TON	63-72				6" Overstock Rear C-Notch (Weld-In) Only	37
63129	GM 1/2TON	63-72	2WD			Battery Mount (Battery Not Included)	38
63130	GM 1/2TON	63-72				Power Rack & Pinion w/ Billet Adapters	38
63131	GM 1/2TON	63-72				CNC Laser Cut & Formed Boxed Upper Control Arms	36
63132	GM 1/2TON	63-72				L.S. Motor Mounts w/ Bushings & Spacers	38
63133	GM 1/2TON	63-72		0-3"		Front Coils Overs	38
63134	GM 1/2TON	63-72			2-5"	Rear Coils Overs	38
63140	GM 1/2TON	63-87	2WD, 6-LUG (6 x 5)			Passenger Side 13" Brake Rotor - Cross-Drilled	40
63141	GM 1/2TON	63-87	2WD, 6-LUG (6 x 5)			Driver Side 13" Brake Rotor - Cross-Drilled	40
63142	GM 1/2TON	63-87	2WD, 6-LUG (6 x 5)			Passenger Side 13" Brake Rotor	40
63143	GM 1/2TON	63-87	2WD, 6-LUG (6 x 5)			Driver Side 13" Brake Rotor	40
63148	GM 1/2TON	63-70	2WD Cross-Drill (5 x 5)	2.5"		13" Front Kit w/ 2.5" Drop Spindles (Brake Kit)	35
63149	GM 1/2TON	63-70	2WD Smooth (5 x 4.75)	2.5"		13" Front Kit w/ 2.5" Drop Spindles (Brake Kit)	35
63150	GM 1/2TON	63-70	2WD Cross-Drill (5 x 4.75)	2.5"		13" Front Kit w/ 2.5" Drop Spindles (Brake Kit)	35
63151	GM 1/2TON	63-70	2WD Smooth (5 X 5)	2.5"		13" Front Kit w/ 2.5" Drop Spindles (Brake Kit)	35

GM TRUCK LOWERING KITS & PARTS

PART #	MODEL	YEAR	APPLICA-TION	FRONT DROP	REAR DROP	KIT	PAGE #
63152	GM 1/2TON	71-72	2WD Smooth (5 x 4.75)	2.5"		13" Front Kit w/ 2.5" Drop Spindles (Brake Kit)	35
63153	GM 1/2TON	71-72	2WD Smooth (5 X 5)	2.5"		13" Front Kit w/ 2.5" Drop Spindles (Brake Kit)	35
63154	GM 1/2TON	71-72	2WD Cross-Drill (5 x 4.75)	2.5"		13" Front Kit w/ 2.5" Drop Spindles (Brake Kit)	35
63155	GM 1/2TON	71-72	2WD Cross-Drill (5 x 5)	2.5"		13" Front Kit w/ 2.5" Drop Spindles (Brake Kit)	35
63168	GM 1/2TON	63-72	2WD	1"		Lowering Front Coil Springs	33-34
63169	GM 1/2TON	63-72	2WD	2"		Lowering Front Coil Springs	33-34
63170	GM 1/2TON	63-72	2WD		3"	Lowering Rear Coil Springs	33-34
63171	GM 1/2TON	63-72	2WD	4"		Lowering Front Coil Springs	33-34
63172	GM 1/2TON	63-72	2WD	5"		Lowering Front Coil Springs	33-34
63175	GM 1/2TON	65-72	2WD			Adjustable Rear Track Bar	33-34
63176	GM 1/2TON	71-72	2WD	2.5"		2.5" Drop Spindles (Uses HD Disc Brakes, 1.25" Thick Rotors)	33-34
63179	GM 1/2TON	67-72	2WD			7" Booster w/ Master CYL. & Bracket for Front Disc Brakes	33-34
63183	GM 1/2TON	67-72	2WD			9" Booster w/ Master CYL. & Bracket for Front Disc Brakes	33-34
63180	GM 1/2TON	67-72	2WD			7" Booster w/ Master CYL. & Bracket for Front Drum Brakes	33-34
63184	GM 1/2TON	67-72	2WD			9" Booster w/ Master CYL. & Bracket for Front Drum Brakes	33-34
63310	GM 1/2TON	63-70	2WD, 6-LUG SMOOTH	2.5"		13" Front Kit w/ 2.5" Drop Spindles (Brake Kit)	35
63311	GM 1/2TON	63-70	2WD, 6-LUG Cross-Drill	2.5"		13" Front Kit w/ 2.5" Drop Spindles (Brake Kit)	35
63312	GM 1/2TON	71-72	2WD, 6-LUG Smooth	2.5"		13" Front Kit w/ 2.5" Drop Spindles (Brake Kit)	35
63313	GM 1/2TON	71-72	2WD, 6-LUG Cross-Drill	2.5"		13" Front Kit w/ 2.5" Drop Spindles (Brake Kit)	35
33149	GM 1/2TON	73-87	2WD	2"	4"	Front Coils, Rear Shackles, & Hangers	39
93129	GM 1/2TON	73-87	2WD 1.25" Thick	2.5"	4"	HD Front Drop Spindles, Rear Shackles, & Hangers	39
93130	GM 1/2TON	73-87	2WD 1" Thick	2.5"	4"	LD Front Drop Spindles, Rear Shackles, & Hangers	39
93150	GM 1/2TON	73-87	2WD 1.25" Thick	4.5"	6"	HD Front Drop Spindles, Coils, Rear Flip Kit, & C-Notch	39
93151	GM 1/2TON	73-87	2WD 1" Thick	4.5"	6"	LD Front Drop Spindles, Coils, Rear Flip Kit, & C-Notch	39
33127	GM 1/2TON	73-87	2WD	1"		Lowering Front Coils	39
33128	GM 1/2TON	73-87	2WD	2"		Lowering Front Coils	39
33131	GM 1/2TON	73-87	2WD		1" or 2"	Rear Lowering Shackles	39
33153	GM 1/2TON	73-87	2WD	2.5"		Front Drop Spindles (HD Brakes, 1.25" Thick Rotors)	39
33154	GM 1/2TON	73-87	2WD	2.5"		Front Drop Spindles (LD Brakes, 1" Thick Rotors)	39
33156	GM 1/2TON	73-87	2WD		6"	6" Rear Flip Kit	39
33152	GM 1/2TON	73-87	2WD			Rear C-Notch	39
33155	GM 1/2TON	73-87	2WD		3" or 4"	Rear Lowering Hangers (Must use w/ Shackles for 3" or 4" Rear Drop)	39
33157	GM 1/2TON	73-87	2WD Cross-Drill (5 x 5)	2.5"		13" Front Kit w/ 2.5" Drop Spindles (Brake Kit)	40
33158	GM 1/2TON	73-87	2WD, Smooth (5 x 5)	2.5"		13" Front Kit w/ 2.5" Drop Spindles (Brake Kit)	40
33159	GM 1/2TON	73-87	2WD, Smooth (5 x 4.75)	2.5"		13" Front Kit w/ 2.5" Drop Spindles (Brake Kit)	40
33160	GM 1/2TON	73-87	2WD, Cross-Drill (5x4.75)	2.5"		13" Front Kit w/ 2.5" Drop Spindles (Brake Kit)	40
33300	GM 1/2TON	73-87	2WD, 6-LUG	2.5"		13" Front Kit w/ 2.5" Drop Spindles - Smooth (Brake Kit)	40
33301	GM 1/2TON	73-87	2WD, 6-LUG	2.5"		13" Front Kit w/ 2.5" Drop Spindles - Cross-Drilled (Brake Kit)	40
63116	GM 1/2TON	73-87	2WD	2"		2" Drop Front Crossmember Kit	36

GM TRUCK LOWERING KITS & PARTS

PART #	MODEL	YEAR	APPLICA-TION	FRONT DROP	REAR DROP	KIT	PAGE #
63118	GM 1/2TON	73-87	2WD			6" Over-Stock Rear C-Notch Kit	37
63121	GM 1/2TON	73-87	2WD		0	Adjustable Trailing Arm Crossmember w/ Integrated Drive-Line Loop, Transmission Crossmember & Center Supports	37
63124	GM 1/2TON	73-87		3.5"		3.5" Adjustable Trailing Arms w/ 1.25" Johnny Joints	37
63125	GM 1/2TON	73-87				Side Exit Exhaust Mounts	38
63126	GM 1/2TON	73-87				Rear Bolt-On Frame Support w/ Hardware	38
63128	GM 1/2TON	73-87				6" Overstock Rear C-Notch (Weld-In) Only	37
63129	GM 1/2TON	73-87	2WD			Battery Mount (Battery Not Included)	38
63130	GM 1/2TON	73-87				Power Rack & Pinion w/ Billet Adapters	38
63131	GM 1/2TON	73-87				CNC Laser Cut & Formed Boxed Upper Control Arms	36
63132	GM 1/2TON	73-87				L.S. Motor Mounts w/ Bushings & Spacers	38
63133	GM 1/2TON	63-87		0-3"		Front Coils Overs	38
63134	GM 1/2TON	63-87			2-5"	Rear Coils Overs	38
63140	GM 1/2TON	73-87	2WD, 6-LUG (6 x 5)			Passenger Side 13" Brake Rotor - Cross-Drilled	40
63141	GM 1/2TON	73-87	2WD, 6-LUG (6 x 5)			Driver Side 13" Brake Rotor - Cross-Drilled	40
63142	GM 1/2TON	73-87	2WD, 6-LUG (6 x 5)			Passenger Side 13" Brake Rotor	40
63143	GM 1/2TON	73-87	2WD, 6-LUG (6 x 5)			Driver Side 13" Brake Rotor	40
63156	GM 1/2TON	73-87	2WD, 5-LUG			Disc Brake Kit w/ Rotor, Loaded Caliper, Bearing, Seal, Hose, Dust Caps, ETC.	40
63157	GM 1/2TON	73-87	2WD, 6-LUG			Disc Brake Kit w/ Rotor, Loaded Caliper, Bearing, Seal, Hose, Dust Caps, ETC.	40
63158	GM 1/2TON	73-87	2WD, 6-LUG			6-LUG Rotor	40
33134	GM 1/2TON	88-98	2WD, HD Brakes, 1.25" Thick Rotors	2"	4"	Spindles, Rear Shackles, & Hangers	41
33135	GM 1/2TON	88-91	2WD STD Cab, LD Brakes, 1" Thick Rotors	2"	4"	Front Drop Spindles, Rear Shackles & Hangers	41
33136	GM 1/2TON	88-98	2WD, HD Brakes, 1.25" Thick Rotors	2"	4"	Front Coils, Rear Shackles & Hangers	41
33137	GM 1/2TON	88-98	2WD, HD Brakes, 1.25" Thick Rotors	4"	6"	Spindles, Coils, Flip Kit, & C-Notch	41
33138	GM 1/2TON	88-91	2WD STD Cab	4"	6"	Spindles, Coils, Flip Kit, & C-Notch	41
33037	GM 1/2TON	88-98	2WD/4WD ALL CABS		2"	Rear Shackles	41
33132	GM 1/2TON	88-98	2WD	1"		Lowering Front Coil Springs	41
33133	GM 1/2TON	88-98	2WD	2"		Lowering Front Coil Springs	41
33139	GM 1/2TON	88-98	2WD			Carrier Bearing Relocator	41
33140	GM 1/2TON	88-98	2WD			Rear C-Notch	41
33141	GM 1/2TON	88-98	2WD	2"		2" Drop Spindles (HD Brakes, 1.25" Thick Rotors)	41
33142	GM 1/2TON	88-91	2WD STD Cab Only	2"		2" Drop Spindles (LD Brakes, 1" Thick Rotors)	41
33143	GM 1/2TON	88-98	2WD	3" or 4"		Leaf Spring Hangers (Must use w/ Shackles for 3" or 4" Rear Drop)	41
33144	GM 1/2TON	88-98	2WD		6"	Rear Flip Kit (Must use w/ C-Notch)	41
11001	GM 1/2TON	99-06	2WD S-Cab	2"	4"	Coils, Shackles, & Hangers	42
11003	GM 1/2TON	99-06	2WD / 4WD	2"	4"	Spindles, Shackles, & Hangers (16"+ Rims)	42
11004	GM 1/2TON	99-06	2WD / 4WD	2"	4"	Spindles, Shackles, & Hangers (17"+ Rims)	42
33015	GM 1/2TON	99-06	4WD X/Quad	2"	4"	Torsion Keys, Shackles, & Hangers	42
33034	GM 1/2TON	99-06	2WD		6"	Rear Flip Kit (Need a C-Notch)	42
33040	GM 1/2TON	99-06	2WD X/Quad	2"	4"	Coils, Shackles, & Hangers	42
93042	GM 1/2TON	99-06	2WD / 4WD (Coil Front)	2"	4"	Leaf Springs, Spindles, & Shackles (16"+ Rims)	43
93043	GM 1/2TON	99-06	2WD / 4WD	2"	4"	Leaf Springs, Spindles, & Shackles (17"+ Rims)	43
93044	GM 1/2TON	99-06	2WD (Coil Front)	2"	4"	Coils, Shackles, & Leaf Springs	43

GM TRUCK LOWERING KITS & PARTS

PART #	MODEL	YEAR	APPLICA-TION	FRONT DROP	REAR DROP	KIT	PAGE #
93045	GM 1/2TON	99-06	4WD (Torsion Drop)	2"	4"	Torsion Keys, Shackles, & Leaf Springs	43
93046	GM 1/2TON	99-06	2WD (Coil Front)	2"	4"	Coils, Rear Hanger, Flip Kit, & Bump Stops	42
93048	GM 1/2TON	99-06	2WD / 4WD	2"	4"	Spindles, Rear Hangers, Flip Kit, & Bump Stops	42
93016	GM 1/2TON	01-06	2WD S-Cab	4"		Spindles, Coils, Flip Kit, & C-Notch (16"+ Rims)	43
93047	GM 1/2TON	99-06	2WD / 4WD		4" or 5"	Flip Kit, Rear Hangers, & Bump Stops	42
93017	GM 1/2TON	01-06	2WD X/Quad	4"	6"	Spindles, Coils, Flip Kit, & C-Notch (16"+ Rims)	43
93018	GM 1/2TON	99-00	2WD S-Cab	4"	6"	Spindles, Coils, Flip Kit, & C-Notch (16"+ Rims)	43
93019	GM 1/2TON	99-00	2WD X/Quad	4"	6"	Spindles, Coils, Flip Kit, & C-Notch (16"+ Rims)	43
93020	GM 1/2TON	01-06	2WD S-Cab	4"	6"	Spindles, Coils, Flip Kit, & C-Notch (17"+ Rims)	43
93021	GM 1/2TON	01-06	2WD X/Quad	4"	6"	Spindles, Coils, Flip Kit, & C-Notch (17"+ Rims)	43
93022	GM 1/2TON	99-00	2WD S-Cab	4"	6"	Spindles, Coils, Flip Kit, & C-Notch (17"+ Rims)	43
93023	GM 1/2TON	99-00	2WD X/Quad	4"	6"	Spindles, Coils, Flip Kit, & C-Notch (17"+ Rims)	43
93025	GM 1/2TON	01-06	2WD S-Cab	5"	7"	Spindles, Coils, Flip, C-Notch & Shackles (16"+ Rims)	43
93026	GM 1/2TON	01-06	2WD X/Quad	5"	7"	Spindles, Coils, Flip Kit, C-Notch, & Shackles (16"+ Rims)	43
93027	GM 1/2TON	99-00	2WD S-Cab	5"	7"	Spindles, Coils, Flip Kit, C-Notch, & Shackles (16"+ Rims)	43
93028	GM 1/2TON	99-00	2WD X/Quad	5"	7"	Spindles, Coils, Flip Kit, C-Notch, & Shackles (16"+ Rims)	43
93029	GM 1/2TON	01-06	2WD S-Cab	5"	7"	Spindles, Coils, Flip, C-Notch & Shackles (17"+ Rims)	43
93030	GM 1/2TON	01-06	2WD X/Quad	5"	7"	Spindles, Coils, Flip Kit, C-Notch, & Shackles (17"+ Rims)	43
93031	GM 1/2TON	99-00	2WD S-Cab	5"	7"	Spindles, Coils, Flip Kit, C-Notch, & Shackles (17"+ Rims)	43
93032	GM 1/2TON	99-00	2WD X/Quad	5"	7"	Spindles, Coils, Flip Kit, C-Notch, & Shackles (17"+ Rims)	43
33002	GM 1/2TON	99-06	2WD ONLY	2"		Drop Spindles	44
33003	GM 1/2TON	01-06	2WD / 4WD			Rear C-Notch	44
33004	GM 1/2TON	99-06	2WD/4WD/AWD	2"		Drop Spindles-Must use 17" or Larger Rims	44
33005	GM 1/2TON	99-06	4WD			Torsion Keys (Adjustable)	44
33006	GM 1/2TON	99-06	2WD, X/QUAD			Carrier Bearing Relocator	44
33007	GM 1/2TON	99-00	2WD / 4WD			Rear C-Notch	44
33008	GM 1/2TON	99-06	2WD, S-CAB	2"		Front Coil Springs	44
33008	GM 1/2TON	99-06	2WD, QUAD	3"		Front Coil Springs	44
33009	GM 1/2TON	99-06	2WD, X/QUAD	1"		Front Coil Springs	44
33010	GM 1/2TON	99-06	2WD, S-CAB	1"		Front Coil Springs	44
33010	GM 1/2TON	99-06	2WD, QUAD	2"		Front Coil Springs	44
33011	GM 1/2TON	99-06	2WD, S-CAB	3"		Front Coil Springs	44
33024	GM 1/2TON	99-06	2WD			Air Bag Helper Kit for our 5", 6" or 7" Drop	44
33033	GM 1/2TON	99-06	2WD / 4WD			Air Bag Helper Kit for 2", 3" or 4" Drop	44
33034	GM 1/2TON	99-06	2WD		6"	Rear Flip Kit (Need a C-Notch)	44
33035	GM 1/2TON	99-06	2WD / 4WD		3" or 4"	Hangers (w/ Shackles - 3" or 4") - Can't use if Factory Hangers are WELDED	44
33036	GM 1/2TON	99-06	2WD			Rear Shock Extenders	44
33037	GM 1/2TON	99-06			1-2"	Rear Shackles	44
33039	GM 1/2TON	99-09	2WD/4WD ALL CABS			Foam Bump Stops	44
33046	GM 1/2TON	99-06			2"	Rear Leaf	44
34042	GM 1/2TON	99-06	2WD, S-CAB	2"		Lowering Front Coil Springs	44
93049	GM 1/2TON	99-16	2WD		5" or 6"	Rear Lift Hangers - Raise rear to 5" or 6" (Use w/ #33034 Flip Kit)	44
34000	GM 1/2TON	07-13	2WD Quad	2"	4"	Spindles, Leafs, & Shackles	45
34001	GM 1/2TON	07-13	2WD Quad	2"	4"	Coils, Flip Kit, & Lift Hangers	45
34021	GM 1/2TON	07-13	2WD S-Cab	2"	4"	Coils, Flip Kit, & Lift Hangers	45
34034	GM 1/2TON	07-13	2WD S-Cab	2"	4"	Spindles, Rear Hangers, Flip Kit, & Bump Stops	45
34055	GM 1/2TON	07-13	2WD All Cabs	2"	4"	Adjustable Strut Rings, Flip Kit, Adjustable Rear Hangers	45
34002	GM 1/2TON	07-13	2WD X/Quad	3"	5"	Spindles, Coils, Leafs, Shackles, & Bump Stops	46
34005	GM 1/2TON	07-13	2WD Quad	3"	5"	Spindles, Coils, Rear Hangers, Flip Kit, Bump Stops	46
34007	GM 1/2TON	07-13	2WD Quad	3"	5"	Spindles, Coils, C-Notch, Rear Hangers, Flip Kit, Shock Extenders, & Bump Stops	46
34022	GM 1/2TON	07-13	2WD S-Cab	3"	5"	Spindles, Coils, Leafs, Shackles, & Bump Stops	46
34025	GM 1/2TON	07-13	2WD S-Cab	3"	5"	Spindles, Coils, Rear Hangers, Flip Kit, Bump Stops	46
34027	GM 1/2TON	07-13	2WD S-Cab	3"	5"	Spindles, Coils, C-Notch, Rear Hangers, Flip Kit, Shock Extenders, & Bump Stops	46

GM TRUCK LOWERING KITS & PARTS

PART #	MODEL	YEAR	APPLICA-TION	FRONT DROP	REAR DROP	KIT	PAGE #
34060	GM 1/2TON	07-13	2WD All Cabs	3" or 4"	5" or 6"	Adj. Lowering Front Strut Rings, Spindles, Flip Kit, Lift Hangers, & Bump Stops	47
34070	GM 1/2TON	07-13	2WD	3" or 4"	5" or 6"	Spindles, Adj. Front Struts, Rear Shocks, Flip Kit, Adj. Rear Hangers, Rear Shock Extenders, Bump Stops	47
34004	GM 1/2TON	07-13	2WD Quad	4"	6"	Spindles, Coils, Bump Stops, & Flip Kit	47
34015	GM 1/2TON	07-13	2WD Quad	4"	6"	Spindles, Coils, Rear Hangers, Short Shackles, Flip Kit & Bump Stops	47
34016	GM 1/2TON	07-13	2WD Quad	4"	6"	Spindles, Coils, Rear Hangers, Short Shackles, C-Notch, Flip Kit & Bump Stops	47
34024	GM 1/2TON	07-13	2WD S/Quad	4"	6"	Spindles, Coils, Bump Stops, & Flip Kit	47
34035	GM 1/2TON	07-13	2WD Quad	4"	6"	Spindles, Coils, C-Notch, Rear Hangers, Short Shackles, Flip Kit, Shock Extenders, & Bump Stops	47
34036	GM 1/2TON	07-13	2WD S/Quad	4"	6"	Spindles, Coils, Rear Hangers, Short Shackles, Flip Kit & Bump Stops	47
34003	GM 1/2TON	07-13	2WD X/Quad	4"	7"	Spindles, Coils, C-Notch, Flip Kit, Shock Extenders, & Bump Stops	48
34023	GM 1/2TON	07-13	2WD S-Cab	4"	7"	Spindles, Coils, C-Notch, Flip Kit, Shock Extenders, & Bump Stops	48
33037	GM 1/2TON	07-13	2WD/4WD ALL CABS		1-2"	Rear Shackles	49
34037	GM 1/2TON	07-13	2WD/4WD ALL CABS	2"		2" Drop Spindles	48
34038	GM 1/2TON	07-13	2WD, QUAD	2"		Lowering Front Coil Springs	49
34039	GM 1/2TON	07-13	2WD, QUAD	1"		Lowering Front Coil Springs	49
34040	GM 1/2TON	07-13	2WD ALL CABS		1"	Shackles	48
34041	GM 1/2TON	07-13	S-CAB	1"		Lowering Front Coil Springs	49
34042	GM 1/2TON	07-13	S-CAB	2"		Lowering Front Coil Springs	49
34044	GM 1/2TON	07-13	2WD/4WD ALL CABS			Shock Extenders	48
34045	GM 1/2TON	07-13	2WD/4WD ALL CABS			C-Notch Kit	48
34047	GM 1/2TON	07-13	2WD ALL CABS		7"	Rear Flip Kit	48
34049	GM 1/2TON	07-13	2WD ALL CABS			Air Bag Helper Kit for 6" & 7" Rear Kit	48
34050	GM 1/2TON	07-15	2WD	2"		Drop Spindles (Must be used w/ drop coils)	48
93049	GM 1/2TON	99-16	2WD		5" or 6"	Rear Lift Hangers - Raise rear to 5" or 6" (Use w/ #33034 Flip Kit)	48
34100	GM 1/2TON	14-16	2WD All Cabs	2"	4"	Spindles, Leafs, & Shackles	49
34155	GM 1/2TON	14-16	2WD All Cabs	2"	4"	Adjustable Strut Rinds, Flip Kit, & Adjustable Rear Hangers	49
34160	GM 1/2TON	14-16	2WD All Cabs	3" or 4"	5" or 6"	Adjustable Front Struts, Flip Kit & Adjustable Rear Hangers	49
34170	GM 1/2TON	14-16	2WD	3" or 4"	5" or 6"	Adjustable Front Struts, Rear Shocks, Flip Kit, Adjustable Rear Hangers, & Rear Shock Extenders	49
33037	GM 1/2TON	14-16	2WD/4WD ALL CABS		1-2"	Rear Shackles	49
33046	GM 1/2TON	14-16			2"	Rear Leaf	49
34039	GM 1/2TON	14-16	QUAD	1"		Lowering Front Coil Springs	49
34038	GM 1/2TON	14-16	QUAD	2"		Lowering Front Coil Springs	49
34041	GM 1/2TON	14-16	S-CAB	1"		Lowering Front Coil Springs	49
34042	GM 1/2TON	14-16	S-CAB	2"		Lowering Front Coil Springs	49
34050	GM 1/2TON	14-16	2WD	2"		Drop Spindles	49
34147	GM 1/2TON	14-16			7"	Flip Kit - Use Factory U-Bolts	49
93049	GM 1/2TON	99-16	2WD		5" or 6"	Rear Lift Hangers - Raise rear to 5" or 6" (Use w/ #33034 Flip Kit)	48

GM SUV LOWERING KITS & PARTS

PART #	YEAR	APPLICATION	FRONT DROP	REAR DROP	KIT	PAGE #
11008	01-06	2WD / 4WD	2"	3"	Keys, Coils, & Shock Extenders (LD Shocks)	50
11010	01-06	2WD / 4WD	2"	3"	Spindles, Coils, & Shock Extenders (LD Shocks)	50
11016	01-06	2WD / 4WD	2"	3"	Keys, Coils, & Shock Extenders (LD Shocks, No Bilstein)	50
11018	01-06	2WD / 4WD	2"	3"	Spindles, Coils, & Shock Extenders (LD Shocks, No Bilstein)	50
33047	01-06	2WD / 4WD Auto Ride	2"	3"	Spindles, Coils, & Shock Extenders (HD Shocks)	50
33048	01-06	2WD / 4WD	2"	3"	Keys, Coils, & Shock Extenders (HD / Air Shocks)	50
33049	01-06	2WD ONLY	3"	5"	Spindles, Keys, Coils, Axle Relocators, & Sway Bar Struts (LD Shocks)	50
33051	01-06	2WD / 4WD		2"	Coils & Shock Extenders for Factory HD / Air Shock	50
33073	01-06	2WD ONLY		5"	Leveling Kit (Coils, Axle Relocator, Sway Bar Struts)	50
33004	01-06	2WD / 4WD / AWD	2"		Drop Spindles (17"+ Rims)	51
33005	99-06	2WD / 4WD / AWD	1" or 2"		Adjustable Torsion Keys	51
33050	01-06	2WD / 4WD / AWD		3"	Coils for Light Duty Factory Rear Shocks AVALANCHE ONLY	51
33052	01-06	2WD / 4WD / AWD		3"	Coils for Light Duty Factory Rear Shocks TAHOE & SUBURBAN ONLY (No Bilsteins)	51
33062	01-06	2WD / 4WD / AWD		3"	Rear Coils for Heavy Duty Factory / Air Shocks	51
33069	01-06	2WD / 4WD / AWD	2"		Air Bag Helper Kit for 3" & 5" Drop Kits	51
33070	01-06	2WD / 4WD / AWD			Shock Extenders for 3" Rear - Use w/ Factory Shocks	51
30008	07-13	2WD	2"	3"	Spindles, Rear Coils, & Shock Extenders - Factory Non-Air Shocks	52
30009	07-13	2WD	2"	3"	Spindles, Rear Coils, & Shock Extenders Factory Air Shocks	52
30010	07-13	2WD ONLY	2"	3"	Front & Rear Coils, & Shock Extenders - No Auto Leveling Factory Shocks	52
30012	07-13	2WD	3"	5"	Spindles, Front & Rear Coils, Axle Relocators, Sway Bar Struts (Non-Air Factory Shocks)	52
30013	07-13	2WD	4"	5"	Spindles, Front & Rear Coils, Axle Relocators, Sway Bar Struts (Non-Air Factory Shocks)	52
30014	07-13	2WD / 4WD		2"	Leveling Kit (Coils & Shock Extenders) (Non-Air Factory Shocks)	52
30016	07-13	2WD / 4WD	2"	3"	Spindles, Coils, Shocks Extenders (NON-AIR)	52
30017	07-13	2WD / 4WD	2"	3"	Spindles, Coils, Shocks Extenders (HD / AIR)	52
34065	07-13	2WD	2"	3"	Adjustable Strut Rings & Spacers, Rear Coils, & Shock Extenders (NON-Air Factory Shocks)	52
34066	07-13	2WD	2"	3"	Adjustable Strut Rings & Spacers, Rear Coils, & Shock Extenders (Air/Auto Leveling Factory Shocks)	52
34037	07-13	2WD/4WD All Cabs	2"		Drop Spindles	53
34061	07-13	2WD All Cabs	2"		Adj. Lowering Front Strut Rings (Front Kit Only) - Non Air Factory Shocks	53
34062	07-13	2WD All Cabs	2"		Adj. Lowering Front Strut Rings (Front Kit Only) - Air/Auto Leveling Shocks	53
34065	2015	2WD	2"	3"	Adjustable Strut Rings & Spacers, Rear Coils, & Shock Extenders (NON-Air Factory Shocks)	52
34213	14-16	2WD ONLY - Auto Ride	2"	3"	Spindles, Rear Coils, & Shock Extenders	54
34214	14-16	2WD ONLY - Not Auto Ride	2"	3"	Spindles, Rear Coils, & Shock Extenders	54
34215	14-16	2WD ONLY - Not Auto Ride	3" or 4"	5"	Spindles, Adj. Front Struts, Rear Coils, Trailing Arm Relocators, Sway Bar End Links, Shock Extenders, & Shock Extenders	54
34216	14-16	2WD ONLY - Not Auto Ride	3" or 4"	5"	Spindles, Adj. Front Strut Cups, & 5" Rear Coils	54
34200	14-16	2WD ONLY	2"		Drop Spindles	54

S-10/SONOMA/BLAZER/COLORADO/CANYON

PART #	MODEL	YEAR	APPLICATION	FRONT DROP	REAR DROP	KIT	PAGE #
11004	SS-TRUCK	04-06	AWD / 4WD	2"	3.5"	Spindles, Shackles, & Hangers (17"+ Rims)	42
33041	SS-TRUCK	04-06	AWD / 4WD	2"	3.5"	Torsion Keys, Shackles, & Hangers	42
33103	S-10 Truck Blazer	82-03 84-97	2WD X-Cab	2"	2"	Front Coils & Rear Lowering Block Kit	55
33125	S-10 Truck Blazer	82-03 84-97	2WD All Cabs	2"	2"	Front Spindles, & Rear Lowering Block Kit	55
33126	S-10/BLAZER	82-05	2WD S-Cab	2"	2"	Front Coils & Rear Lowering Block Kit	55
33104	S-10 Truck Blazer	82-03 84-97	2WD All Cabs	2"	3"	Front Spindles, & Rear Lowering Block Kit	55
33106	S-10 Truck Blazer	82-03 84-97	2WD S-Cab	2"	3"	Front Coils & Rear Lowering Block Kit	55
33107	S-10 Truck Blazer	84-00 84-97	2WD X-Cab	2"	3"	Front Coils & Rear Lowering Block Kit	55
93105	S-10/BLAZER	82-03	2WD S/X/Quad	2"	3"	2" Spindles, & 3" Rear Lowering Leaf Springs	55
93108	S-10/BLAZER	82-03	2WD S/X-Cab	2"	4"	Spindles, 3" Rear Lowering Leaf Springs, & 1" Block	55
93110	S-10 Truck	82-03	2WD S-Cab	2"	4"	Front Coils, 3" Rear Lowering Leaf Springs, & 1" Block	55
93111	S-10 Truck	82-03	2WD X-Cab	2"	4"	Front Coils, 3" Rear Lowering Leaf Springs, & 1" Block	55
93114	S-10 Truck	82-03	2WD S-Cab	4"	4"	Spindles, Coils, 3" Rear Leaf Springs & 1" Block	55
93115	S-10 Truck	82-03	2WD X-Cab	4"	4"	Spindles, Coils, 3" Rear Leaf Springs & 1" Block	55
93116	S-10 Truck	82-03	2WD S-Cab	4"	5"	Spindles, Coils, 3" Rear Leaf Springs, & 2" Block	55
93117	S-10 Truck	82-03	2WD X-Cab	4"	5"	Spindles, Coils, 3" Rear Leaf Springs, & 2" Block	55
93118	S-10 Truck	82-03	2WD S-Cab	4"	6"	Spindles, Coils, 3" Rear Leaf Springs, & 3" Block	55
93119	S-10 Truck	82-03	2WD X-Cab	4"	6"	Spindles, Coils, 3" Rear Leaf Springs, & 3" Block	55
33112	S-10 Truck	82-03	2WD		3"	3" Lowering Rear Leaf Springs	55
33119	S-10 Truck Blazer	82-03 84-97	2WD		1"	Lowering Block Kit	55
33120	S-10	82-03	2WD S-Cab	1"		Front Coil Springs	56
33120	BLAZER	84-97	2WD X-Cab	2"		Front Coil Springs	56
33121	S-10	82-03	2WD S-Cab	2"		Front Coil Springs	56
33121	BLAZER	84-97	2WD X-Cab	3"		Front Coil Springs	56
33122	S-10 Truck Blazer	82-03 84-97	2WD	2"		Front Drop Spindles	56
33123	S-10 Truck Blazer	82-03 84-97	2WD		2"	Lowering Block Kit	56
33124	S-10 Truck Blazer	82-03 84-97	2WD		3"	Lowering Block Kit	56
93124	S-10 Truck	82-03	2WD, Smooth	2"		13" Front Big Brake Kit (5 x 4.75")	55
93125	S-10 Truck	82-03	2WD Cross-Drill	2"		13" Front Big Brake Kit (5 x 4.75")	55
33100	COLORADO	04-11	2WD S-Cab	2"	3"	Coils, Lowering Blocks & U-Bolts	56
33101	COLORADO	04-11	2WD X/Quad	2"	3"	Coils, Lowering Blocks & U-Bolts	56
35100	COLORADO	04-11	2WD S-Cab	2"		Front Coils (No Factory Lowered Extremes)	56
35101	COLORADO	04-11	2WD X/Quad	2"		Front Coils (No Factory Lowered Extremes)	56
33100	CANYON	04-11	2WD S-Cab	2"	3"	Coils, Lowering Blocks & U-Bolts	56
33101	CANYON	04-11	2WD X/Quad	2"	3"	Coils, Lowering Blocks & U-Bolts	56
35100	CANYON	04-11	2WD S-Cab	2"		Front Coils (No Factory Lowered Extremes)	56
35101	CANYON	04-11	2WD X/Quad	2"		Front Coils (No Factory Lowered Extremes)	56

TAHOE 4-DR / TRAILBLAZER/ENVOY

PART #	MODEL	YEAR	APPLICATION	FRONT DROP	REAR DROP	KIT	PAGE #
33145	TAHOE	95-00 4-DR	2WD	2"	4"	Front Drop Spindles, Rear Shackles, & Hangers	57
33146	TAHOE	95-00 4-DR	2WD	2"	4"	Front Coils, Rear Shackles, & Hangers	57
33147	TAHOE	95-00 4-DR	4WD	2"	4"	Torsion Keys, Shackles, & Hangers	57
33148	TAHOE	95-00 4-DR	2WD / 4WD		3" or 4"	Hangers (Must use w/ Shackle - Raises to 3" or 4")	57
33132	TAHOE	95-00 4-DR	2WD	1"		Front Lowering Coil Springs	57
33133	TAHOE	95-00 4-DR	2WD	2"		Front Lowering Coil Springs	57
33141	TAHOE	92-00 4-DR	2WD	2"		Front 2" Drop Spindles	57
33037	TAHOE	95-00 2-DR or 4-DR	2WD/4WD		1" or 2"	Rear Lowering Shackles	57
33005	TAHOE	95-00 2-DR or 4-DR	4WD	1" or 2"		Front Lowering Torsion Keys	57
30015	TRAILBLAZER/ ENVOY	06-09	SS Trailblazer	1.5"	2"	Front Coils, Rear Instructions	57
33102	TRAILBLAZER/ ENVOY	02-09	2WD No SS	1.5"	3"	Front Coils, Rear Coils	57

GM TRUCK HD COMPLETE LOWERING KITS

PART #	APPLICATION	YEAR	FRONT DROP	REAR DROP	KIT	PAGE #
8-LUG RIMS, 6-HOLE FACTORY HANGER						
33083	2WD / 4WD	02-10	2"	3" or 4"	Keys, Hangers, & Shackles	58
33082	2WD / 4WD	02-10	2"	3" or 4"	Spindles, Hangers, & Shackles	58
33084	2WD ONLY	02-10	3"	5"	Spindles, Keys, Hangers & Shackles	58
33087	2WD / 4WD	02-10		3" or 4"	Hangers (3" or 4" Total Drop w/ Shackles)	59
8-LUG RIMS, 8-HOLE FACTORY HANGER						
33080	2WD / 4WD	02-10	2"	4" or 5"	Keys, Hangers, & Shackles	58
33079	2WD / 4WD	02-10	2"	4" or 5"	Spindles, Hangers, & Shackles	58
33081	2WD ONLY	02-10	3"	5"	Spindles, Keys, Hangers & Shackles	58
33086	2WD / 4WD	02-10		4" or 5"	Hangers (4" or 5" Total Drop w/ Shackles) - Replaces Factory 8-Hole Hangers	59
8-LUG RIMS, 10-HOLE FACTORY HANGER						
33076	2WD / 4WD	02-10	2"	4" or 5"	Keys, Hangers, & Shackles	58
33075	2WD / 4WD	02-10	2"	4" or 5"	Spindles, Hangers, & Shackles	58
33077	2WD ONLY	02-10	3"	5"	Spindles, Keys, Hangers & Shackles	58
33085	2WD / 4WD	02-10		4" or 5"	Hangers (4" or 5" Total Drop w/ Shackles) - Replaces Factory 10-Hole Hangers	59
GM TRUCK HD - INDIVIDUAL PARTS						
8-LUG RIMS, 6-HOLE / 8-HOLE / 10-HOLE FACTORY HANGERS						
33078	2WD / 4WD	02-10	2"		Drop Spindles	59
33089	2WD / 4WD	02-10		2"	Shackles	59
33087	2WD / 4WD	02-10		3" or 4"	Hangers (3" or 4" Total Drop w/ Shackles)	59
33088	2WD / 4WD	02-10	2"		Torsion Keys	59
33086	2WD / 4WD	02-10		4" or 5"	Hangers (4" or 5" Total Drop w/ Shackles) - Replaces Factory 8-Hole Hangers	59
33085	2WD / 4WD	02-10		4" or 5"	Hangers (4" or 5" Total Drop w/ Shackles) - Replaces Factory 10-Hole Hangers	59
33200	2500/3500 2WD / 4WD	11-15	1" or 2"		Lowering Shackles	59

FORD LOWERING KITS & PARTS

PART #	MODEL	YEAR	APPLICATION	FRONT DROP	REAR DROP	KIT	PAGE #
70000	F-150 Lightning	97-03	2WD All Cabs	1"	2"	Front Coils & Rear Shackles	60
70001	F-150	97-03	2WD All Cabs	2"	4"	Coils, Shackles, Hangers	60
70020	F-150	97-03				Lowering Hangers	60
70021	F-150	97-03		2"		Lowering Front Coils	60
33037	F-150	97-03	2WD/4WD ALL CABS		2"	Rear Shackles	49
70007	F-150	04-08	2WD All Cabs		4"	Flip Kit, Front Hanger Brackets, & Shocks Extenders	61
70003	F-150	04-08	4WD S-Cab	2"	4"	Strut Spring Pocket Relocator, U-Bolt Spacers, Shackles, Shock Extenders, Bump Stops	61
70010	F-150	04-08	4WD All Cabs	2"	4"	Front Strut Relocators, Shackles, U-Bolt Spacers, Shock Extenders, Bump Stops	61
97012	F-150	04-08	2WD All Cabs	2"	4"	Front Coil Relocators, Drop Down Brackets, U-Bolts, Shock Extenders, Bump Stops	61
70009	F-150	04-08	2WD X-Cab	2"	5"	Strut Spring Pocket Relocator, Flip Kit, Shackles, Shock Extenders, Bump Stops	61
70005	F-150	04-08	2WD All Cabs	2"		Front Strut Relocator	61
70008	F-150	04-08	2WD / 4WD All Cabs			Rear Shock Extenders (pr.)	61
70014	F-150	04-08	2WD			Carrier Bearing Relocator	61
70016	F-150	04-14	2WD / 4WD		2"	Drop Shackles	61
70029	F-150	09-14	2WD All Cabs	2"	4"	Front Coil Relocators, Hangers, Flip Kits, Bump Stops, Shock Extenders	62
70030	F-150	09-14	2WD All Cabs		4"	Flip Kit, Front Lift Hanger Brackets, Shock Extenders	62
70016	F-150	09-14	2WD / 4WD		2"	Drop Shackles	62
70039	F-150	2015	2WD ALL CABS	2"	4"	Coil Relocators, Flip Kit, Lift Hangers, U-Bolts w/ Hardware, Carrier Bearing Relocator, Bump Stops, Shock Extenders	62
70040	F-150	2015	2WD ALL CABS			Carrier Bearing Relocator Only	62
70017	Expedition	97-02	2WD	2"	3"	Front Coil Relocators, & Rear Coils	60

DODGE RAM LOWERING KITS & PARTS

PART #	MODEL	YEAR	APPLICATION	FRONT DROP	REAR DROP	KIT	PAGE #
44009	Dodge 1500	02-05	2WD S/X/Quad		4.5"	Flip Kit, Shackles, Shock Extenders, & Bump Stops	63
44003	Dodge 1500	02-05	2WD S-Cab	2"	4.5"	Coils, Flip Kit, Shackles, Shock Extenders, & Bump Stops	63
44004	Dodge 1500	02-05	2WD X/Quad	2"	4.5"	Coils, Flip Kit, Shackles, Shock Extenders, & Bump Stops	63
94002	Dodge 1500	02-05	2WD S/X/Quad	2"	4.5"	Spindles, Flip Kit, Shackles, Shock Extenders	63
44010	Dodge 1500	02-05	2WD S/X/Quad		6"	Flip Kit, C-Notch, Shock Extenders, & Bump Stops	63
94005	Dodge 1500	02-05	2WD S-Cab	4"	6"	Spindles, Coils, Flip Kit, C-Notch, Shock Extenders	63
94006	Dodge 1500	02-05	2WD X/Quad	4"	6"	Spindles, Coils, Flip Kit, C-Notch, Shock Extenders	63
44000	Dodge 1500	02-08	2WD S/X/Quad			Rear Shock Extenders (pr.)	63
44001	Dodge 1500	02-12	2WD ONLY		2"	Drop Spindles	63
44002	Dodge 1500	02-08	2WD		2"	Rear Leveling Shackles	63
44005	Dodge 1500	02-05	2WD		4.5"	Lift Shackle - Raises rear from 6" drop to 4.5" drop	63
44007	Dodge 1500	02-05	2WD X/Quad	2"		Front Coil Springs	63
44008	Dodge 1500	02-05	2WD S-Cab	2"		Front Coil Springs	63
44012	Dodge 1500	02-08	2WD			Rear Air Bag Helper Kit - Works on 4.5" or 6" Rear Drop	63
44013	Dodge 1500	02-08	2WD S/X/Quad			Rear C-Notch	63
44011	Dodge 1500	04-05	SRT, S-Cab	1.5"	2"	Coils & Rear Lowering Block Kit	63
44017	Dodge 1500	06-08	SRT, S-Cab	1.5"	2"	Coils & Rear Lowering Block Kit	64
44014	Dodge 1500	06-08	2WD ONLY S/X/Quad	2"	4.5"	Spindles, Flip Kit, Shock Extenders, & Bump Stops	64
44015	Dodge 1500	06-08	2WD Quad / SRT Quad	2"	4.5"	Coils, Flip Kit, Lift Shackles, Shock Extenders, & Bump Stops	64
44016	Dodge 1500	06-08	2WD S-Cab	2"	4.5"	Coils, Flip Kit, Lift Shackles, Shock Extenders, & Bump Stops	64

DODGE RAM LOWERING KITS & PARTS

PART #	MODEL	YEAR	APPLICATION	FRONT DROP	REAR DROP	KIT	PAGE #
44019	Dodge 1500	06-08	2WD ONLY S-Cab	4"	6"	Coils, Flip Kit, C-Notch, Shock Extenders, Bump Stops	64
44024	Dodge 1500	06-08	2WD ONLY Quad	4"	6"	Spindles, Coils, Flip Kit, C-Notch, Shock Extenders, & Bump Stops	64
44000	Dodge 1500	02-08	2WD S/X/Quad			Rear Shock Extenders (pr.)	64
44001	Dodge 1500	02-15	2WD ONLY		2"	Drop Spindles	64
44002	Dodge 1500	02-08	2WD		2"	Rear Leveling Shackles	64
44012	Dodge 1500	02-08	2WD			Rear Air Bag Helper Kit - Works on 4.5" or 6" Rear Drop	64
44013	Dodge 1500	02-08	2WD S/X/Quad			Rear C-Notch	64
44021	Dodge 1500	06-08	2WD S-Cab	2"		Front Coil Springs	64
44022	Dodge 1500	06-08	2WD X/Quad	2"		Front Coil Springs	64
44026	Dodge 1500	06-08	2WD		4.5"	Lift Shackle - Raises Rear from 6" Drop back up to 4.5" Drop	64
44050	Dodge 1500	09-15	2WD ONLY All Cabs	2"	4"	Spindles & Rear Coils, Sway Bar End Links, Track Bar Relocators, & Bump Stops	65
44051	Dodge 1500	09-15	2WD S-Cab	2"	4"	Front & Rear Coils, Sway Bar End Links, Track Bar Relocators, & Bump Stops	65
44052	Dodge 1500	09-15	2WD X/Quad	2"	4"	Front & Rear Coils, Sway Bar End Links, Track Bar Relocators, & Bump Stops	65
44001	Dodge 1500	02-15	2WD ONLY		2"	Drop Spindles	65
44055	Dodge 1500	09-15	2WD ONLY		2"	Leveling Rear Coil Springs	65
44060	Dodge 1500	09-15	2WD S-Cab	2"		Front Coil Springs (pr.)	65
44061	Dodge 1500	09-15	2WD X/Quad	2"		Front Coil Springs (pr.)	65

TOYOTA LOWERING KITS & PARTS

PART #	MODEL	YEAR	APPLICATION	FRONT DROP	REAR DROP	KIT	PAGE #
98000	TUNDRA	07-14	S-Cab	2"	4"	Front Coils, Flip Kit w/ U-bolts, shackles, bump stops	66
98004	TUNDRA	07-14	All Cabs	2"	4"	Deluxe Kit w/ Spindles, Flip Kit, & Lift Shackles	66
98010	TUNDRA	07-14	X/Crew	2"	4"	Front Coils, Flip Kit w/ U-bolts, shackles, bump stops	66
98016	TUNDRA	07-14	X/Crew	4"	6"	Spindles, Coils, Flip Kit, & C-Notch	66
98020	TUNDRA	07-14	2WD, No S-Cab	4"	6"	Upgrade Kit (Converts 2"/4" Econ to 4"/6" Deluxe)	66
98001	TUNDRA	07-14	S-Cab	2"		Front Coils (NO. 6 CYL.)	66
98002	TUNDRA	07-14	X/Crew	2"		Front Coils (NO. 6 CYL.)	66
98003	TUNDRA	07-14	All Cabs	2"		Drop Spindles	66
98021	TUNDRA	07-14	All Cabs	1"- 2"		Lift Shackles (pr.)	66

NISSAN COMPLETE LOWERING KIT

MODEL	YEAR	APPLICATION	FRONT DROP	REAR DROP	KIT	PART #	PAGE #
Titan	04-13	2WD	2"	3"	Coils & Leafs - No Long Beds	22222	67

1960-1972 CHEVY TRUCK 1/2 TON

PART #	YEAR	FRONT DROP	REAR DROP	DESCRIPTION	FOOT NOTES (On Pg. 82)
63165	60-64			Adjustable Rear Track Bar	
63175	65-72			Adjustable Rear Track Bar	
63120	60-72			Trailing Arm Cross-Member (Built in Drive-Line Loop for Ground Clearance - Allows 3" Exhaust to go through center of Cross-Member)	
63167	60-72			Rear C-Notch	
63168	63-72	1"		Lowering Front Coil Springs	
63169	63-72	2"		Lowering Front Coil Springs	
63170	60-72		3"	Lowering Rear Coil Springs	
63171	60-72		4"	Lowering Rear Coil Springs	
63172	60-72		5"	Lowering Rear Coil Springs	
63177	60-66			7" Booster w/ Master Cyl. & Bracket for Front Disc Brakes	
63178	60-66			7" Booster w/ Master Cyl. & Bracket for Front Drum Brakes	
63179	67-72			7" Booster w/ Master Cyl. & Bracket for Front Disc Brakes	
63180	67-72			7" Booster w/ Master Cyl. & Bracket for Front Drum Brakes	
63181	60-66			9" Booster w/ Master Cyl. & Bracket for Front Disc Brakes	
63182	60-66			9" Booster w/ Master Cyl. & Bracket for Front Drum Brakes	
63183	67-72			9" Booster w/ Master Cyl. & Bracket for Front Disc Brakes	
63184	67-72			9" Booster w/ Master Cyl. & Bracket for Front Drum Brakes	
63174	63-70	STOCK		Stock Height Spindles - Converts to Disc Brakes	
63164	60-62	2.5"		2.5" Drop Spindles - Converts to Disc Brakes	DB, HD, BJ, TR
63173	63-70	2.5"		2.5" Drop Spindles - Converts to Disc Brakes	
63176	71-72	2.5"		2.5" Drop Spindles (Uses HD Disc Brakes, 1.25" Thick Rotors)	HD, BJ, TR
63203				Non-Power 1" Bore Master Cyl.	
63156	60-87			5-Lug Disc Brake Kit w/ Rotors, Calipers, Bearings, Seals, Hoses, Dust Caps, Spindle Nuts, Spindles Washers, & Cotter Pins	
63157	60-87			6-Lug Disc Brake Kit w/ Rotors, Calipers, Bearings, Seals, Hoses, Dust Caps, Spindle Nuts, Spindles Washers, & Cotter Pins	
63163				Adj. Proportioning Valve w/ Lines & Bracket	
64090				Non-Adj. Proportioning Valve w/ Lines & Bracket	







13" Front Disc Kit (#63310 shown)



13" Front Disc Kit (Cross-Drilled) (#63311 shown)



13" Front Disc Kit (#63151 shown)



13" Front Disc Kit (Cross-Drilled) (#63148 shown)

1963-1970 BIG BRAKE KITS

PART #	YEAR	APPLICATION	FRONT DROP	DESCRIPTION	FOOT NOTES (On Pg. 82)
63310	63-70	2WD, 6-LUG SMOOTH	2.5"	13" Front Kit w/ 2.5" Drop Spindles hubs, rotors, calipers, rubber brake hoses, bearings, seals, dust caps, spindle nuts/washers, cotter pins	T
63311	63-70	2WD, 6-LUG CROSS-DRILLED	2.5"	13" Front Kit w/ 2.5" Drop Spindles hubs, rotors, calipers, rubber brake hoses, bearings, seals, dust caps, spindle nuts/washers, cotter pins	T
63150	63-70	2WD CROSS-DRILLED (5 x 4.75)	2.5"	13" Front Kit w/ 2.5" Drop Spindles hubs, rotors, calipers, rubber brake hoses, bearings, seals, dust caps, spindle nuts/washers, cotter pins	T
63148	63-70	2WD CROSS-DRILLED (5 x 5)	2.5"	13" Front Kit w/ 2.5" Drop Spindles hubs, rotors, calipers, rubber brake hoses, bearings, seals, dust caps, spindle nuts/washers, cotter pins	T
63149	63-70	2WD SMOOTH (5 x 4.75)	2.5"	13" Front Kit w/ 2.5" Drop Spindles hubs, rotors, calipers, rubber brake hoses, bearings, seals, dust caps, spindle nuts/washers, cotter pins	T
63151	63-70	2WD SMOOTH (5 X 5)	2.5"	13" Front Kit w/ 2.5" Drop Spindles hubs, rotors, calipers, rubber brake hoses, bearings, seals, dust caps, spindle nuts/washers, cotter pins	T

1971-1972 BIG BRAKE KITS

PART #	YEAR	APPLICATION	FRONT DROP	DESCRIPTION	FOOT NOTES (On Pg. 82)
63312	71-72	2WD, 6-LUG SMOOTH	2.5"	13" Front Kit w/ 2.5" Drop Spindles hubs, rotors, calipers, rubber brake hoses, bearings, seals, dust caps, spindle nuts/washers, cotter pins	T
63313	71-72	2WD, 6-LUG CROSS-DRILLED	2.5"	13" Front Kit w/ 2.5" Drop Spindles hubs, rotors, calipers, rubber brake hoses, bearings, seals, dust caps, spindle nuts/washers, cotter pins	T
63152	71-72	2WD SMOOTH (5 x 4.75)	2.5"	13" Front Kit w/ 2.5" Drop Spindles hubs, rotors, calipers, rubber brake hoses, bearings, seals, dust caps, spindle nuts/washers, cotter pins	T
63153	71-72	2WD SMOOTH (5 X 5)	2.5"	13" Front Kit w/ 2.5" Drop Spindles hubs, rotors, calipers, rubber brake hoses, bearings, seals, dust caps, spindle nuts/washers, cotter pins	T
63154	71-72	2WD CROSS-DRILLED (5 x 4.75)	2.5"	13" Front Kit w/ 2.5" Drop Spindles hubs, rotors, calipers, rubber brake hoses, bearings, seals, dust caps, spindle nuts/washers, cotter pins	T
63155	71-72	2WD CROSS-DRILLED (5 X 5)	2.5"	13" Front Kit w/ 2.5" Drop Spindles hubs, rotors, calipers, rubber brake hoses, bearings, seals, dust caps, spindle nuts/washers, cotter pins	T



2" Drop Front Crossmember Kit w/ 1" Narrowed A-Arms (#63115 shown)



1" Narrowed Boxed Upper Control Arms w/ Poly Bushings, Sleeves & Stainless Steel Badges (Come Raw) (#63131)

1963-1987 CHEVY TRUCK C-10

PART #	YEAR	FRONT DROP	DESCRIPTION
63115	63-72	2"	2" Drop Front Crossmember Kit w/ Upper & Lower A-Arms, Motor Mount Brackets, Upper A-Arm Mounts, Lower Coil-Over Mounts, Inner Frame Supports, & Heim Joint Steering Adapters
63116	73-87	2"	2" Drop Front Crossmember Kit w/ Upper & Lower A-Arms, Motor Mount Brackets, Upper A-Arm Mounts, Lower Coil-Over Mounts, Inner Frame Supports, & Heim Joint Steering Adapters
63131	63-87		CNC Laser Cut & Formed Boxed Upper Control Arms w/ Stainless Steel Badges, Poly Bushings & Sleeves

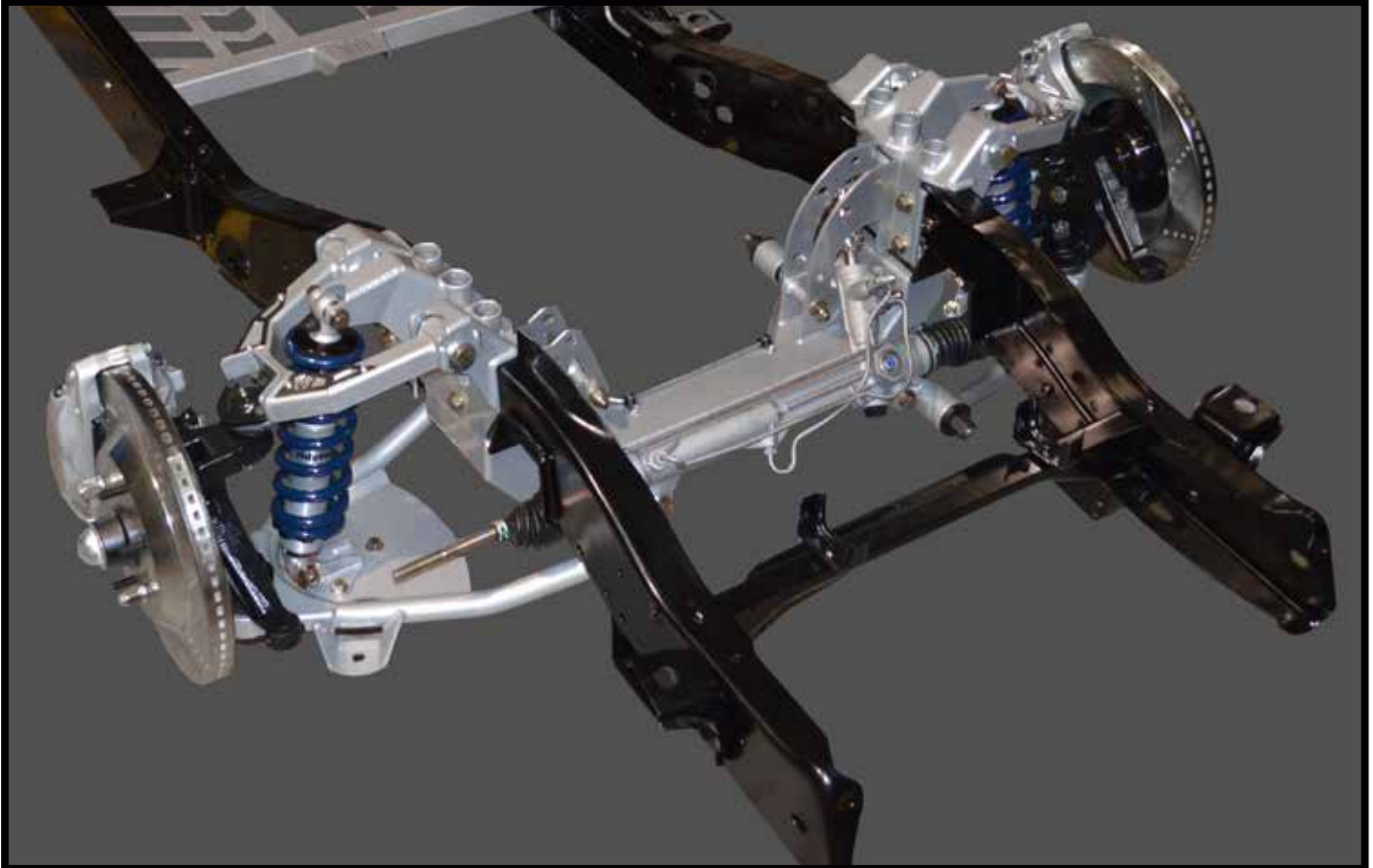



6" Over Stock Rear C-Notch Kit (#63117 shown)



Adjustable Rear Trailing Arm Crossmember w/ Integrated Drive-Line Loop, Transmission Crossmember & Center Supports (#63121 shown)

1963-1987 CHEVY TRUCK C-10

PART #	YEAR	REAR DROP	DESCRIPTION
63117	63-72		6" Over Stock Rear C-Notch Kit w/ Trailing Arms, Weld-in Over Stock C-Notches, U-Bolts, Panhard Bar, Rear C-Notch Brace, Johnny Joints, Shock Mounts, & Track Bar Bracket
63118	73-87		6" Over Stock Rear C-Notch Kit w/ Trailing Arms, Weld-in Over Stock C-Notches, U-Bolts, Panhard Bar, Rear C-Notch Brace, Johnny Joints, Shock Mounts, & Track Bar Bracket
63127	63-72		6" Overstock Rear C-Notch (Weld-In) Only w/ CNC Laser Cut & Formed C-Notch Center Support
63128	73-87		6" Overstock Rear C-Notch (Weld-In) Only w/ CNC Laser Cut & Formed C-Notch Center Support
63123	63-72	3.5"	3.5" Adjustable Trailing Arms w/ 1.25" Johnny Joints
63124	73-87	3.5"	3.5" Adjustable Trailing Arms w/ 1.25" Johnny Joints
63122	63-72	0	Adjustable Trailing Arm Crossmember w/ Integrated Drive-Line Loop, Transmission Crossmember, & Center Supports
63121	73-87	0	Adjustable Trailing Arm Crossmember w/ Integrated Drive-Line Loop, Transmission Crossmember, & Center Supports



Lowered 6"/8"

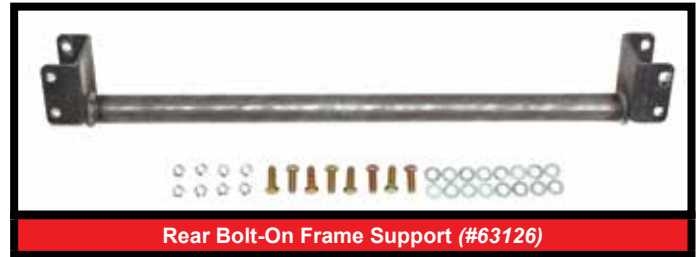
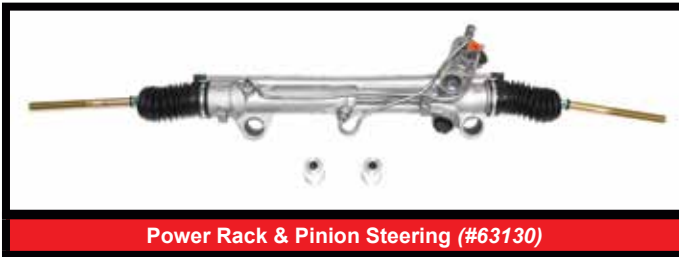

ADDITIONAL OPTIONS (1963-1987 CHEVY C-10)

PART #	YEAR	FRONT DROP	REAR DROP	DESCRIPTION
63133	63-87	0-3"		Front Coils Overs
63134	63-87		2-5"	Rear Coils Overs
63132	63-87			L.S. Motor Mounts w/ Bushings & Spacers
63130	63-87			Power Rack & Pinion Steering w/ Billet Adapters
63126	63-87			Rear Bolt-On Frame Support w/ Hardware
63125	63-87			Bolt-On Side Exit Exhaust Mounts
63129	63-87			Battery Mount w/ Hardware (Battery Not Included)





2 1/4" ECONOMY Kit (#33149 shown)



2.5" Drop Kit (#93129 shown)



4.5" Drop Kit (#93151 shown)

1973-1987 GM TRUCK 1500 KITS

PART #	APPLICATION	FRONT DROP	REAR DROP	DESCRIPTION	FRONT SHOCKS	REAR SHOCKS	FOOT NOTES (On Pg. 82)
33149	2WD	2"	4"	Front Coils, Rear Shackles, & Hangers	1350	1850	
93129	2WD	2.5"	4"	Front Drop Spindles, Rear Shackles, & Hangers (HD Brakes, 1.25" Thick Rotors)	1350	1850	HD
93130	2WD	2.5"	4"	Front Drop Spindles, Rear Shackles, & Hangers (LD Brakes, 1" Thick Rotors)	1350	1850	LD
93150	2WD	4.5"	6"	Front Drop Spindles, Coils, Rear Flip Kit & C-Notch (HD Brakes, 1.25" Thick Rotors)	1350	1850	HD
93151	2WD	4.5"	6"	Front Drop Spindles, Coils, Rear Flip Kit & C-Notch (LD Brakes, 1" Thick Rotors)	1350	1850	LD



INDIVIDUAL PARTS (1973-1987 GM TRUCK 1500)

PART #	APPLICATION	FRONT DROP	REAR DROP	DESCRIPTION	FOOT NOTES (On Pg. 82)
33153	2WD	2.5"		Front Drop Spindles (HD Brakes, 1.25" Thick Rotors)	HD
33154	2WD	2.5"		Front Drop Spindles (LD Brakes, 1" Thick Rotors)	LD
33156	2WD		6"	6" Rear Flip Kit	
33127	2WD	1"		Lowering Front Coils	
33128	2WD	2"		Lowering Front Coils	
33131	2WD		1" or 2"	Rear Lowering Shackles	
33152	2WD			Rear C-Notch	
33155	2WD		3" or 4"	Rear Lowering Hangers (Must use w/ Shackles for 3" or 4" Rear Drop)	



2.5" Drop Spindles (#33153 shown)



6" Rear Flip Kit (#33156)



Lowering Front Coils (#33127)



Rear C-Notch (#33152)



1" or 2" Lowering Rear Shackles (#33131)



Hangers (#33155)





5-LUG Disc Brake Kit (#63156)



6-LUG Disc Brake Kit (#63157)



Rotor 6-LUG (#63158)



13" Brake Rotor (Cross-Drilled) (#63141)



13" Brake Rotor (Smooth) (#63142)



13" Front Disc Kit (#33158)



13" Front Disc Kit (Cross-Drilled) (#33157)



13" Front Disc Kit (6-LUG Smooth) (#33300)



13" Front Disc Kit - 6-LUG (Cross-Drilled) (#33301)

1973-1987 GM TRUCK 1500 BIG BRAKE KITS

PART #	APPLICATION / YEAR	FRONT DROP	DESCRIPTION	FOOT NOTES (On Pg. 82)
63158	2WD, 6-LUG		6-LUG Rotor	T
63140	2WD, 6-LUG (6 x 5)		Passenger Side 13" Brake Rotor - Cross-Drilled	T
63141	2WD, 6-LUG (6 x 5)		Driver Side 13" Brake Rotor - Cross-Drilled	T
63142	2WD, 6-LUG (6 x 5)		Passenger Side 13" Brake Rotor	T
63143	2WD, 6-LUG (6 x 5)		Front Drop Spindles (HD Brakes, 1.25" Thick Rotors)	T
63156	2WD, 60-87		5-Lug Disc Brake Kit w/ Rotors, Calipers, Bearings, Seals, Hoses, Dust Caps, Spindle Nuts & Washers, & Cotter Pins	HD
63157	2WD, 60-87		6-Lug Disc Brake Kit w/ Rotors, Calipers, Bearings, Seals, Hoses, Dust Caps, Spindle Nuts & Washers, & Cotter Pins	
33158	2WD, Smooth (5 x 5)	2.5"	13" Front Kit w/ 2.5" Drop Spindles w/ Brackets, Rotors, Calipers, Bearings, Seals, Hoses, Hubs, Spindle Nuts & Washers, & Cotter Pins	T
33159	2WD, Smooth (5 x 4.75)	2.5"	13" Front Kit w/ 2.5" Drop Spindles w/ Brackets, Rotors, Calipers, Bearings, Seals, Hoses, Hubs, Spindle Nuts & Washers, & Cotter Pins	T
33157	2WD (5 x 5)	2.5"	13" Front Kit w/ 2.5" Drop Spindles w/ Brackets, Rotors, Calipers, Bearings, Seals, Hoses, Hubs, Spindle Nuts & Washers, & Cotter Pins	T
33160	2WD, Cross-Drilled (5x4.75)	2.5"	13" Front Kit w/ 2.5" Drop Spindles w/ Brackets, Rotors, Calipers, Bearings, Seals, Hoses, Hubs, Spindle Nuts & Washers, & Cotter Pins	T
33300	2WD, Smooth	2.5"	13" Front Kit w/ 2.5" Drop Spindles w/ Brackets, Rotors, Calipers, Bearings, Seals, Hoses, Hubs, Spindle Nuts & Washers, & Cotter Pins	T
33301	2WD, Cross-Drilled	2.5"	13" Front Kit w/ 2.5" Drop Spindles	T



2\"/>



2\"/>



4\"/>



**Lowering Front Coils
(#33132 shown)**



**Carrier Bearing Relocator
(#33139 shown)**



1\"/>



**C-Notch
(#33140 shown)**



2\"/>



**Front Leaf Spring Hanger
(#33143 shown)**



6\"/>

1988-1998 KITS

PART #	APPLICATION	FRONT DROP	REAR DROP	DESCRIPTION	FRONT SHOCKS	REAR SHOCKS	FOOT NOTES (On Pg. 82)
33136	2WD, HD Brakes, 1.25" Thick Rotors	2"	4"	Front Coils, Rear Shackles, & Hangers	1451	2050	
33135	2WD, LD Brakes, 1" Thick Rotors	2"	4"	Front Drop Spindles, Rear Shackles, & Hangers	1451	2050	LD
33134	2WD, HD Brakes, 1.25" Thick Rotors	2"	4"	Front Drop Spindles, Rear Shackles, & Hangers	1451	2050	HD
33138	2WD, LD Brakes, 1" Thick Rotors	4"	6"	Spindles, Coils, Flip Kit, C-Notch	1451	2050	LD
33137	2WD, HD Brakes, 1.25" Thick Rotors	4"	6"	Spindles, Coils, Flip Kit, C-Notch	1451	2050	HD



Lowered 4\"/>

INDIVIDUAL PARTS

PART #	APPLICATION/ YEAR	FRONT DROP	REAR DROP	DESCRIPTION	FOOT NOTES (On Pg. 82)
33132	2WD	1"		Lowering Front Coil Springs	
33133	2WD	2"		Lowering Front Coil Springs	
33139	2WD			Carrier Bearing Relocator	
33140	2WD			Rear C-Notch	
33141	2WD	2"		2" Drop Spindles (HD Brakes, 1.25" Thick Rotors)	HD
33142	2WD (88-91)	2"		2" Drop Spindles (LD Brakes, 1" Thick Rotors)	LD
33143	2WD		3" or 4"	Leaf Spring Hangers (Must use w/ Shackles for 3" or 4" Rear Drop)	
33144	2WD		6"	Rear Flip Kit (Must use w/ C-Notch)	
33037	2WD		1" or 2"	Rear Shackles	



Before we released our spindles for the 1999-2006 GM Trucks, 2001-2006 SUV's, and the 2007+ spindle, we **patented** our design to ensure that our product would remain the best on the market. At the 2003 SEMA show, **GM** presented us with "The Most Innovative Product of the Year" Award for our drop spindle. We patented the upper bearing stud so that **our spindle's upper ball joint height would keep the same dimensions as the stock GM spindle** (This ensures the correct ball joint angles are maintained). In order for our **competitors to avoid our patent**, they had to **raise the upper ball joint boss 1.5"** which creates horrendous bump steer, severe **ball joint angles**, and premature **ball joint wear**. In some cases, our competitor's spindles **require** that the upper **A-Frame** be **flipped** upside down, which is the complete opposite of how GM intended the front suspension parts to be installed and function.



2WD
2 1/4" DELUXE Drop Kit (#11003)



4WD
2 1/4" Economy Kit for Torsion Front End (#33015)



2WD
2 1/4" Drop (Coil Front-End) ECONOMY Kit (#11001)



2WD
2 1/4" ECONOMY Kit (#93046)



2WD/4WD
2 1/4" Deluxe Kit (#93048)

CHEVY 1500 TRUCK

PART #	APPLICATION	FRONT DROP	REAR DROP	DESCRIPTION	FRONT SHOCKS	REAR SHOCKS	FOOT NOTES (On Pg. 82)
11003	2WD (16" Rims)	2"	4"	Deluxe Kit - Spindles, Shackles, Hangers		2050	C, WH
11004	2WD / 4WD (17"+ Rims)	2"	4"	Deluxe Kit - Spindles, Shackles, Hangers		2050	T, WH
33015	4WD, X/Quad	2"	4"	Torsion Keys, Shackles, Hangers		2050	WH
11001	2WD, S-Cab	2"	4"	Coils, Shackles & Hangers	1451	2050	V8, WH
33040	2WD, X/Quad	2"	4"	Coils, Shackles & Hangers	1451	2050	V8, WH
33034	2WD		6"	Rear Flip Kit (Need A C-Notch)			S
93046	2WD (Coil Front)	2"	4"	Coils, Rear Hangers, Flip Kit, Bump Stops	1451	2050	C, V8
93048	2WD / 4WD	2"	4"	Spindles, Rear Hangers, Flip Kit, Bump Stops		2050	T
93047	2WD / 4WD		4" or 5"	Flip Kit, Rear Hangers, Bump Stops		2050	



DELUXE Drop Kit - SS Truck (#11004)



ECONOMY Kit SS Truck (#33041)

CHEVY SS-TRUCK

PART #	APPLICATION	FRONT DROP	REAR DROP	DESCRIPTION	REAR SHOCKS	FOOTNOTES
11004	AWD / 4WD	2"	3.5"	Deluxe Kit - Spindles, Shackles, Hangers (17"+ Rims)	2050	T
33041	AWD / 4WD	2"	3.5"	Torsion Keys, Shackles, Hangers	2050	



1999-2006 CHEVY 1500 1/2 TON (2\"/>

PART #	APPLICATION	FRONT DROP	REAR DROP	DESCRIPTION	FRONT SHOCKS	REAR SHOCKS	FOOT NOTES (On Pg. 82)
93042	2WD	2"	4"	Leaf Springs, Spindles, Shackles (Coil-Front End)		2050	C
93043	2WD/ 4WD	2"	4"	Leaf Springs, Spindles, Shackles (17"+ Rims)		2050	T
93044	2WD	2"	4"	Coils, Shackles, Leaf Springs (Coil-Front)	1451	2050	V8
93045	4WD (Torsion Front)	2"	4"	Torsion Keys, Shackles, Leaf Springs		2050	T, V8



1999-2006 CHEVY 1500 1/2 TON (4\"/>

PART #	YEAR	APPLICATION	FRONT DROP	REAR DROP	DESCRIPTION	FRONT SHOCKS	REAR SHOCKS	FOOT NOTES (On Pg. 82)
93018	99-00	2WD S-Cab	4"	6"	Spindles, Coils, Flip & C-Notch (16"+ Rims)	1451	2050	SE, C, V8
93019	99-00	2WD X/Quad	4"	6"	Spindles, Coils, Flip & C-Notch (16"+ Rims)	1451	2050	SE,C, CB,V8
93022	99-00	2WD S-Cab	4"	6"	Spindles, Coils, Flip & C-Notch (17"+ Rims)	1451	2050	SE, T, V8
93023	99-00	2WD X/Quad	4"	6"	Spindles, Coils, Flip & C-Notch (17"+ Rims)	1451	2050	SE,T, CB,V8
93016	01-06	2WD S-Cab	4"	6"	Spindles, Coils, Flip & C-Notch (16"+ Rims)	1451	2050	SE, C, V8
93017	01-06	2WD X/Quad	4"	6"	Spindles, Coils, Flip & C-Notch (16"+ Rims)	1451	2050	SE,C, CB,V8
93020	01-06	2WD S-Cab	4"	6"	Spindles, Coils, Flip & C-Notch (17"+ Rims)	1451	2050	SE, T, V8
93021	01-06	2WD X/Quad	4"	6"	Spindles, Coils, Flip & C-Notch (17"+ Rims)	1451	2050	SE,T, CB,V8

1999-2006 CHEVY 1500 1/2 TON (5\"/>

PART #	YEAR	APPLICATION	FRONT DROP	REAR DROP	DESCRIPTION	FRONT SHOCKS	REAR SHOCKS	FOOT NOTES (On Pg. 82)
93027	99-00	2WD S-Cab	5"	7"	Spindles, Coils, Flip, C-Notch & Shackles (16"+ Rims)	1451	1850	SE, C, V8
93028	99-00	2WD X/Quad	5"	7"	Spindles, Coils, Flip, C-Notch & Shackles (16"+ Rims)	1451	1850	SE, C, CB, V8
93031	99-00	2WD S-Cab	5"	7"	Spindles, Coils, Flip, C-Notch & Shackles (17"+ Rims)	1451	1850	SE, T, V8
93032	99-00	2WD X/Quad	5"	7"	Spindles, Coils, Flip, C-Notch & Shackles (17"+ Rims)	1451	1850	SE, T, CB, V8
93025	01-06	2WD S-Cab	5"	7"	Spindles, Coils, Flip, C-Notch & Shackles (16"+ Rims)	1451	1850	SE, C, V8
93026	01-06	2WD X/Quad	5"	7"	Spindles, Coils, Flip, C-Notch & Shackles (16"+ Rims)	1451	1850	SE, C, CB, V8
93029	01-06	2WD S-Cab	5"	7"	Spindles, Coils, Flip, C-Notch & Shackles (17"+ Rims)	1451	1850	SE, T, V8
93030	01-06	2WD X/Quad	5"	7"	Spindles, Coils, Flip, C-Notch & Shackles (17"+ Rims)	1451	1850	SE, T, CB, V8

1999-2006 CHEVY TRUCK 1500



2WD ONLY

99-06 2" Drop Spindles (#33002)

US Patent #6,860,498
Works w/ Factory 16" wheels or larger. You can only use these spindles on a coil spring front end, 2WD, 1/2 TON CHEVY or GMC Trucks



2WD OR 4WD

01-06 2" Spindles Must use 17" or Larger Rims (#33004)
US Patent #6,860,498



2WD

Front Coils (#33008)



2WD

Front Coils (#33010)



2WD

6" Rear Axle Flip Kit (#33034)



2WD OR 4WD

3" or 4" Hangers (#33035)
If your truck has a factory welded hanger, you must use a lowering rear lift hanger/flip kit combo



2WD OR 4WD

Rear Lift Hangers (#93049)

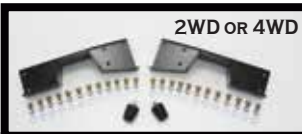

2WD OR 4WD

C-Notch w/ Bump Stops (#33003)



2WD OR 4WD

1" or 2" Shackles (Adjustable) (#33037)



99-15 Foam Bump Stops (#33039)



99-15 2" Rear Leaf (#33046)



2WD OR 4WD

Air Bag Helper Kit for 3" or 4" Rear Drop - No C-Notches (#33033)



2WD

Air Bag Helper Kit for 5", 6", or 7" Rear Drop (#33024)

PART #	APPLICATION / YEAR	FRONT DROP	REAR DROP	DESCRIPTION	FOOT NOTES (On Pg. 82)
33002	2WD ONLY	2"		Drop Spindles Coil-Front End, 16"+ Wheels (Can only use these spindles on Coil Spring Front-End, 2WD, 1/2-TON CHEVY or GMC Trucks)	
33004	2WD/4WD/AWD	2"		Drop Spindles-Must use 17" or Larger Rims	
33008	2WD, S-CAB	2"		Front Coil Springs	V8
33008	2WD, QUAD	3"		Front Coil Springs	V8
33009	2WD, X/QUAD	1"		Front Coil Springs	V8
33010	2WD, S-CAB	1"		Front Coil Springs	V8
33010	2WD, QUAD	2"		Front Coil Springs	V8
33011	2WD, S-CAB	3"		Front Coil Springs	V8
33034	2WD		6"	Rear Flip Kit (Need a C-Notch)	
33035	2WD / 4WD		3" or 4"	Hangers (w/ Shackles - 3" or 4") - Can't use if Factory Hangers are WELDED	WH
93049	2WD			Rear Lift Hangers - Raise rear to 5" or 6" (Use w/ #33034 Flip Kit)	
33037	2WD / 4WD		1" or 2"	Shackles (Adjustable)	
33007	2WD / 4WD (99-00)			Rear C-Notch	S
33003	2WD / 4WD (01-06)			Rear C-Notch	S
33039				Foam Bump Stops	
33046			2"	Rear Leaf	
33033	2WD / 4WD			Air Bag Helper Kit for 3" or 4" Rear Drop - No C-Notches	
33024	2WD			Air Bag Helper Kit for our 5", 6" or 7" Rear Drop	
33006	2WD, X/QUAD			Carrier Bearing Relocator	
33005	4WD	1" or 2"		Torsion Keys (Adjustable)	
33036	2WD			Rear Shock Extenders	



2WD

Carrier Bearing Relocator (#33006)



2WD

1" or 2" Drop Torsion Keys (#33005)



2WD

Rear Shock Extenders (#33036)



**GM AWARD
WINNING
SUSPENSION
PARTS
& KITS**



**ALL OF OUR 2"/4"
KITS WORK WITH
THE FACTORY FRONT
& REAR SHOCKS**



2WD

2"/4" DELUXE Kit (#34000)



2WD

**2"/4" ECONOMY Kit
(#34021)**



2WD

2"/4" Deluxe Kit (#34034)



2WD

2"/4" Economy Kit (#34055)

2"/4" DROP KITS

PART #	APPLICATION	FRONT DROP	REAR DROP	DESCRIPTION	REAR SHOCKS	FOOT NOTES (On Pg. 82)
34000	QUAD	2"	4"	Spindles, Leafs, Shackles	2050	T
34021	2WD, S-CAB	2"	4"	Coils, Flip Kit, Lift Hanger	2050	V8
34001	2WD, QUAD	2"	4"	Coils, Flip Kit, Lift Hanger	2050	V8
34034	2WD, S-CAB	2"	4"	Spindles, Rear Hangers, Flip Kit, Bump Stops	2050 or Stock Shocks	T
34055	2WD, ALL CABS	2"	4"	Adj. Strut Rings, Flip Kit, Adj. Rear Hangers, Bump Stops	2050 or Stock Shocks	



Lowered 5"/7"



3" / 5" Kit (#34027)



3" / 5" Kit (#34002)



3" / 5" Kit (#34005)

3" / 5" DROP KITS						
PART #	APPLICATION	FRONT DROP	REAR DROP	DESCRIPTION	REAR SHOCKS	FOOT NOTES (On Pg. 82)
34007	2WD X/QUAD	3"	5"	Spindles, Coils, C-Notch, Rear Hangers, Flip Kit, Shock Extenders, Bump Stops	2050	V8, S, T
34027	2WD S-CAB	3"	5"	Spindles, Coils, C-Notch, Rear Hangers, Flip Kit, Shock Extenders, Bump Stops	2050	V8, S, T
34002	2WD, X/QUAD	3"	5"	Spindles, Coils, Leafs, Shackles, Bump Stops, Shackles	2050	V8, S, T
34022	2WD, S-CAB	3"	5"	Spindles, Coils, Leafs, Shackles, Bump Stops, Shackles	2050	V8, S, T
34005	2WD, QUAD	3"	5"	Spindles, Coils, Rear Hangers, Flip Kit, Bump Stops	2050	V8, S, T
34025	2WD, S-CAB	3"	5"	Spindles, Coils, Rear Hangers, Flip Kit, Bump Stops	2050	V8, S, T



Lowered 5" / 7"



3"/5" or 4"/6" Deluxe Spindle Kit w/ Adj. Lowering Front Strut Rings - Need shorter Rear Shackle (#34060)



3"/5" or 4"/6" Deluxe Spindle Kit w/ Adj. Front Struts & Rear Shocks (#34070)



4" / 6" Deluxe Kit (#34004 shown)



4" / 6" Deluxe Kit (#34015 shown)



4" / 6" Deluxe Kit (#34035 shown)

3" / 5" OR 4" / 6" DROP KITS

PART #	YEAR	APPLICATION	FRONT DROP	REAR DROP	DESCRIPTION	FOOT NOTES
34060	07-13	2WD, ALL CABS	3" or 4"	5" or 6"	Spindles, Adj. Lowering Front Strut Rings, Flip Kit, Lift Hangers, Shock Extenders & Bump Stops	T
34070 OUR CHOICE	07-13	2WD, ALL CABS	3" or 4"	5" or 6"	Spindles, Adj. Lowering Front Struts, Rear Shocks, Flip Kit, Adj. Rear Hangers, Rear Shock Extenders, Bump Stops	T



4" / 6" DROP KITS

PART #	APPLICATION	FRONT DROP	REAR DROP	DESCRIPTION	REAR SHOCKS	FOOT NOTES (On Pg. 82)
34004	2WD, QUAD	4"	6"	Spindles, Coils, Bump Stops, Flip Kit, & Shock Extenders	2050	V8, S, T
34024	2WD, S-CAB	4"	6"	Spindles, Coils, Bump Stops, Flip Kit, & Shock Extenders	2050	V8, S, T
34015	2WD, QUAD	4"	6"	Spindles, Coils, Rear Hangers, Short Shackle, Flip Kit, Shock Extenders & Bump Stops	2050	V8, S, T
34036	2WD, S-CAB	4"	6"	Spindles, Coils, Rear Hangers, Short Shackle, Flip Kit, Shock Extenders & Bump Stops	2050	V8, S, T
34016	2WD, QUAD	4"	6"	Spindles, Coils, C-Notch, Rear Hangers, Flip Kit, Shock Extenders, Bump Stops	2050	V8, S, T
34035	2WD, S-CAB	4"	6"	Spindles, Coils, C-Notch, Rear Hangers, Short Shackle, Flip Kit, Shock Extenders, Bump Stops	2050	V8, S, T





4" / 7" Deluxe Kit (#34003)

4" / 7" DROP KITS

PART #	APPLICATION	FRONT DROP	REAR DROP	DESCRIPTION	REAR SHOCKS	FOOT NOTES (On Pg. 82)
34003	2WD, X/QUAD	4"	7"	Spindles, Coils, C-Notch, Flip Kit, Shock Extenders, Bump Stops	2050	V8, S, T
34023	2WD, S-CAB	4"	7"	Spindles, Coils, C-Notch, Flip Kit, Shock Extenders, Bump Stops	2050	V8, S, T



2" Drop Spindles - Must use 17" or Larger Rims, Torsion Front-End Only (#34037) US Patent #6,860,498



2" Drop Spindles - Has 2" of extra camber built in for trucks that need extra alignment. Must use 17" or Larger Rims, Torsion Front-End Only (#34050) US Patent #6,860,498



Rear Lift Hangers (w/ Flip Kit raises the Back to 5" or 6") (#93049)



C-Notch Kit (#34045)



Short Shackle (#34040)



Flip Kit (#34047)

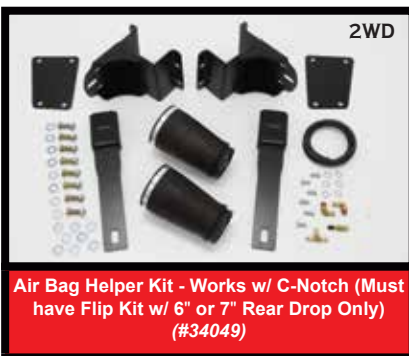

Air Bag Helper Kit - Works w/ C-Notch (Must have Flip Kit w/ 6" or 7" Rear Drop Only) (#34049)

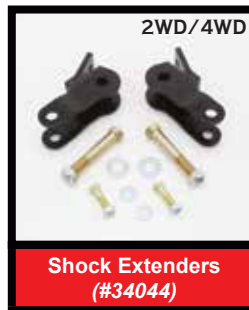

Shock Extenders (#34044)



Lowered 4 1/2"

INDIVIDUAL PARTS (2007-2013 CHEVY 1500)

PART #	APPLICATION	FRONT DROP	REAR DROP	DESCRIPTION
34037	2WD/4WD ALL CABS	2"		2" Drop Spindles
34050	2WD/4WD ALL CABS	2"		2" Drop Spindles (Must be used w/ drop coils)
93049	2WD		5" or 6"	Rear Lift Hangers - Raises rear to 5" or 6" (Use w/ #33034)
34045	2WD/4WD ALL CABS			C-Notch Kit
34040	2WD ALL CABS		1"	Shackles
34047	2WD ALL CABS		7"	Rear Flip Kit
34049	2WD ALL CABS			Air Bag Helper Kit for 6" & 7" Rear Kit
34044	2WD/4WD ALL CABS			Shock Extenders



2014-2016 GM TRUCK KITS

PART #	APPLICATION	FRONT DROP	REAR DROP	DESCRIPTION
34155	2WD, ALL CABS	2"	4"	Adjustable Strut Rings, Flip Kit, & Adjustable Rear Hangers
34100	2WD, ALL CABS	2"	4"	Spindles, Leafs, Shackles
34160	2WD, ALL CABS	3" or 4"	5" or 6"	Spindles, Adjustable Front Struts, Flip Kit, & Adjustable Rear Hangers
34170	2WD	3" or 4"	5" or 6"	Spindles, Adjustable Front Struts, Rear Shocks, Flip Kit, Adjustable Rear Hangers & Rear Shock Extenders



INDIVIDUAL PARTS

PART #	YEAR	APPLICATION	FRONT DROP	REAR DROP	DESCRIPTION
33037	88-16	2WD/4WD ALL CABS		1-2"	Rear Shackles
34041	07-16	2WD/4WD S-CAB	1"		Lowering Front Coil Springs
34042	07-16	2WD/4WD S-CAB	2"		Lowering Front Coil Springs
34039	99-16	2WD/4WD QUAD	1"		Lowering Front Coil Springs
34038	99-16	2WD/4WD QUAD	2"		Lowering Front Coil Springs
34050	14-16	2WD	2"		Drop Spindles
34204	14-16	4WD	2"		Drop Spindles
34147	14-16	2WD/4WD ALL CABS		7"	Flip Kit - Use Factory U-Bolts





Before we released our spindles for the 1999-2006 GM Trucks, 2001-2006 SUV's, and the 2007+ spindle, we **patented** our design to ensure that our product would remain the best on the market. At the 2003 SEMA show, **GM** presented us with "The Most Innovative Product of the Year" Award for our drop spindle. We patented the upper bearing stud so that our spindle's upper ball joint height would keep the same dimensions as the stock GM spindle (This ensures the correct ball joint angles are maintained). In order for our competitors to avoid our patent, they had to raise the upper ball joint boss 1.5" which creates horrendous bump steer, severe ball joint angles, and premature ball joint wear. In some cases, our competitor's spindles require that the upper A-Frame be flipped upside down, which is the complete opposite of how GM intended the front suspension parts to be installed and function.



2WD/
4WD

TAHOE / SUBURBAN
Rear 2" Leveling Kit (#33051)



2WD/
4WD

2" / 3" ECONOMY Kit (#11016)



2WD/
4WD

2" / 3" DELUXE Drop Kit
(#11018)



2WD

SUBURBAN / AVALANCHE
5" Rear Kit w/ Coils (#33073)



2WD ONLY

TAHOE / SUBURBAN / AVALANCHE
3"/5" DELUXE Drop Kit (#33049)

TAHOE & YUKON (1/2TON)

PART #	APPLICATION	FRONT DROP	REAR DROP	DESCRIPTION	REAR SHOCKS	FOOT NOTES (On Pg. 82)
33051	2WD / 4WD		2"	Coils & Shock Extenders (Factory HD / AIR Shock)		
33048	2WD / 4WD	2"	3"	Keys, Coils, Shock Extenders		HS, B
11010	2WD / 4WD	2"	3"	Spindles, Coils, Shock Extenders		LS, T
33047	2WD / 4WD	2"	3"	Spindles, Coils, Shock Extenders		HS, T, B
33049	2WD ONLY	3"	5"	Spindles, Keys, Coils, Axle Relocators, Sway Bar Struts	2050	S, T

ESCALADE, DENALI, ESV, EXT.

PART #	APPLICATION	FRONT DROP	REAR DROP	DESCRIPTION	REAR SHOCKS	FOOT NOTES (On Pg. 82)
11008	2WD / 4WD	2"	3"	Keys, Coils, Shock Extenders		LS
33048	2WD / 4WD	2"	3"	Keys, Coils, Shock Extenders		HS, B
33047	2WD / 4WD	2"	3"	Spindles, Coils, Shock Extenders		HS, T, B
33049	2WD ONLY	3"	5"	Spindles, Keys, Coils, Axle Relocators, Sway Bar Struts	2050	S, T

SUBURBAN, YUKON XL (1/2TON)

PART #	APPLICATION	FRONT DROP	REAR DROP	DESCRIPTION	REAR SHOCKS	FOOT NOTES (On Pg. 82)
33051	2WD / 4WD		2"	Coils & Shock Extenders (Factory HD / AIR Shock)		
11008	2WD / 4WD	2"	3"	Keys, Coils, Shock Extenders		LS
33048	2WD / 4WD	2"	3"	Keys, Coils, Shock Extenders		HS, B
11010	2WD / 4WD	2"	3"	Spindles, Coils, Shock Extenders		LS, T
33047	2WD / 4WD	2"	3"	Spindles, Coils, Shock Extenders		HS, T, B
33049	2WD ONLY	3"	5"	Spindles, Keys, Coils, Axle Relocators, Sway Bar Struts	2050	S, T
33073	2WD ONLY		5"	Coils, Axle Relocator, Sway Bar Struts	2050	S

AVALANCHE (1/2TON)

PART #	APPLICATION	FRONT DROP	REAR DROP	DESCRIPTION	REAR SHOCKS	FOOT NOTES (On Pg. 82)
33048	2WD / 4WD	2"	3"	Keys, Coils, Shock Extenders		HS, B
33047	2WD / 4WD	2"	3"	Spindles, Coils, Shock Extenders		HS, T, B
11016	2WD / 4WD	2"	3"	Keys, Coils, Shock Extenders		LS, B
11018	2WD / 4WD	2"	3"	Spindles, Coils, Shock Extenders		LS, T, B
33049	2WD ONLY	3"	5"	Spindles, Keys, Coils, Axle Relocators, Sway Bar Struts	2050	S, T
33073	2WD ONLY		5"	Coils, Axle Relocator, Sway Bar Struts	2050	S



GM AWARD WINNING SUSPENSION PARTS & KITS

ALL OF OUR 2"/3" KITS WORK WITH THE FACTORY FRONT & REAR SHOCKS



Lowered 3"/5"



**2" Spindles (#33004)
Must use 17" or Larger Rims
US Patent #6,860,498**

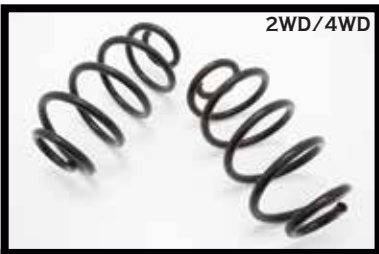

3" Rear Coils (#33052)



Drop Torsion Keys (#33005)



Air Bag Helper Kit For Shock, 3" or 5" Rear (#33069)



Rear Shock Extenders (#33070)

INDIVIDUAL PARTS
(TAHOE, YUKON, SUBURBAN, AVALANCHE, YUKON XL, DENALI, ESCALADE, ESV EXT 1/2 TON)

PART #	APPLICATION	FRONT DROP	REAR DROP	DESCRIPTION	REAR SHOCKS	FOOT NOTES (On Pg. 82)
33004	2WD / 4WD / AWD	2"		Drop Spindles, Must use 17" or Larger Rims		LS
33050	2WD / 4WD / AWD		3"	Avalanche Coils for Light Duty Factory Rear Shocks		B
33052	2WD / 4WD / AWD		3"	Suburban Coils for Light Duty Factory Rear Shocks		
33062	2WD / 4WD / AWD		3"	Rear Coils for Factory Heavy Duty or Air Shocks		
33052	2WD / 4WD / AWD		3"	Tahoe Coils for Light Duty Factory Rear Shocks		
33005	2WD / 4WD / AWD	1" or 2"		Torsion Keys (Adjustable)		
33069	2WD / 4WD / AWD			Air Bag Helper Kit for 3" & 5" Drop Kits		
33070	2WD / 4WD / AWD			Shock Extenders for 3" Rear - Use w/ Factory Shocks		B
33073	2WD ONLY		5"	Coils, Axle Relocator, Sway Bar Struts	2050	S



Lowered 2"/3"



2" Leveling Kit (#30014)

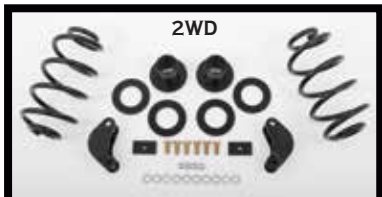

2" / 3" Kit (#34065)



2" / 3" DELUXE Kit (#30008)



2" / 3" ECONOMY Kit (#30010)



3" / 5" DELUXE Kit (#30012)

2007-2013 GM SUV 1500 KITS

(TAHOE, YUKON, SUBURBAN, AVALANCHE, YUKON XL, DENALI, ESCALADE, ESV EXT 1/2TON)

PART #	APPLICATION	FRONT DROP	REAR DROP	DESCRIPTION	REAR SHOCKS	FOOT NOTES (On Pg. 82)
30014	2WD / 4WD		2"	Leveling Kit (Coils & Shock Extenders) - Non-Air Factory Shocks		
30008	2WD	2"	3"	Spindles, Rear Coils, Shock Extenders (Factory Shocks-Not Air)		
30010	2WD ONLY	2"	3"	Front Coils, Rear Coils, Shock Extenders (Factory Shocks-Not Air)		
34065	2WD	2"	3"	Adjustable Strut Rings & Spacers, Rear Coils, Shock Extenders (NON-AIR FACTORY SHOCKS)		
34066	2WD	2"	3"	Adjustable Strut Rings & Spacers, Rear Coils, Shock Extenders (AIR / AUTO LEVELING FACTORY SHOCKS)		
30012	2WD	3"	5"	Spindles, Front & Rear Coils, Axle Relocator, Sway Bar Struts (Factory Shocks - Not Air)	2050	LS, S
30013	2WD	4"	5"	Spindles, Front & Rear Coils, Axle Relocator, Sway Bar Struts (Factory Shocks - Not Air)	2050	LS, S



INDIVIDUAL PARTS:

TAHOE, YUKON, SUBURBAN, AVALANCHE, YUKON XL, DENALI, ESCALADE, ESV EXT 1/2TON



2WD/
4WD

**2" Drop Spindles (#34037)
US Patent #6,860,498**

PART #	APPLICATION	FRONT DROP	DESCRIPTION	FOOT NOTES (On Pg. 82)
34037	2WD/4WD, ALL CABS	2"	Drop Spindles (Must use 17"+ Rims)	
34061	2WD, ALL CABS	2"	Adj. Lowering Front Strut Rings - No Auto Ride (Front Kit Only)	S
34062	2WD, ALL CABS	2"	Adj. Lowering Front Strut Rings - Auto Ride (Front Kit Only)	S



2WD

**TAHOE/AVALANCHE/SUBURBAN/
ETC. 2" Front Adjustable Rings &
Spacers (#34061)**



2 2/3"



Lowered 3 1/5"



2" Drop Spindles - Must use 17"+ Rims (#34200)



2" / 3" Deluxe Kit (#34212)







3" / 5" & 4" / 5" Kit w/ Adj. Struts (#34215)



3" / 5" & 4" / 5" Kit w/ Adj. Strut Rings for Factory Shocks (#34216)

2014-2016 GM SUV 1500 KITS

(TAHOE, YUKON, SUBURBAN, YUKON XL, DENALI, ESCALADE, ESV 1/2TON)

PART #	APPLICATION	FRONT DROP	REAR DROP	DESCRIPTION	REAR SHOCKS
34200	2WD ONLY	2"		Drop Spindles	
34213	2WD ONLY  AUTO RIDE	2"	3"	Spindles, Rear Coils, Shock Extenders	
34214	2WD ONLY  NOT AUTO RIDE	2"	3"	Spindles, Rear Coils, Shock Extenders	
34215	2WD ONLY  NOT AUTO RIDE	3" or 4"	5"	Spindles, Rear Coils, Adjustable Struts, Trailing Arm Relocators, Sway Bar End Links	2050
34216	2WD ONLY  NOT AUTO RIDE	3" or 4"	5"	Spindles, Rear Coils, Adjustable Strut Cups, Trailing Arm Relocators, Sway Bar End Links - Must use Shorter Rear Shocks	2050



Lowered 4 1/2"



2 1/2" ECONOMY Kit (#33103)



2 1/3" DELUXE KIT (#33104)



2 1/3" Deluxe Kit - 2" Spindles & 3" Leafs (#93105)



Spindles, Coils, 3" Leafs, & 1", 2", or 3" Block Kit (#93114 shown)



2 1/4" Spindles, 3" Leafs, 1" Block Kit (#93108)



2 1/4" Kit - Coils, 3" Leafs, 1" Block Kit (#93110)



13" Front Big Brake Kit (5 x 4.75") - SMOOTH (#93124)



13" Front Big Brake Kit (5 x 4.75") - CROSS-DRILLED (#93125)

1982-2002 CHEVY S-10 / GMC SONOMA & 1984-1997 S-10 BLAZER

PART #	APPLICATION	FRONT DROP	REAR DROP	DESCRIPTION	REAR SHOCKS	FOOT NOTES (On Pg. 82)
33103	2WD, X-Cab	2"	2"	Front Coils, Rear Lowering Block Kit	Factory	BL
33126	2WD, S-Cab	2"	2"	Front Coils, Rear Lowering Block Kit	Factory	
33125	2WD, ALL CABS	2"	2"	Front Spindles, Rear Lowering Block Kit	Factory	BL
33104	2WD, ALL CABS	2"	3"	Front Spindles, Rear Lowering Block Kit	Factory	BL
33106	2WD, S-Cab	2"	3"	Front Coils, Rear Lowering Block Kit	Factory	
33107	2WD, X-Cab	2"	3"	Front Coils, Rear Lowering Block Kit	Factory	BL
93105	2WD, S/X/ QUAD	2"	3"	Spindles, 3" Rear Lowering Leaf Springs	Factory	
93108	2WD S/X-Cab	2"	4"	Spindles, Rear Leaf Springs, 1" Block	2050	
93110	2WD, S-Cab	2"	4"	Front Coils, Rear Leaf Springs, 1" Block	2050	
93111	2WD, X-Cab	2"	4"	Front Coils, Rear Leaf Springs, 1" Block	2050	
93114	2WD, S-Cab	4"	4"	Spindles, Coils, Rear Leaf Springs, 1" Block	2050	
93115	2WD, X-Cab	4"	4"	Spindles, Coils, Rear Leaf Springs, 1" Block	2050	
93116	2WD, S-Cab	4"	5"	Spindles, Coils, Rear Leaf Springs, 2" Block	2050	
93117	2WD, X-Cab	4"	5"	Spindles, Coils, Rear Leaf Springs, 2" Block	2050	
93118	2WD, S-Cab	4"	6"	Spindles, Coils, Rear Leaf Springs, 3" Block	2050	
93119	2WD, X-Cab	4"	6"	Spindles, Coils, Rear Leaf Springs, 3" Block	2050	
93124	2WD, Smooth	2"		13" Front Big Brake Kit (5 x 4.75")		T
93125	2WD, Cross-Drilled	2"		13" Front Big Brake Kit (5 x 4.75")		T



2" Drop Spindles (#33122)



3" Rear Leafs (#33112)



Front Coil Springs
(#33120 shown)



Lowering Block Kit
(#33119 shown)

1982-2002 CHEVY S-10 / GMC SONOMA & 1984-1997 S-10 BLAZER

PART #	APPLICATION	FRONT DROP	REAR DROP	DESCRIPTION
33122	2WD	2"		Front Drop Spindles
33112	2WD		3"	Lowering Rear Leaf Springs
33120	2WD, S-CAB	1"		Front Coil Springs
33120	2WD, X-CAB	2"		Front Coil Springs
33121	2WD, S-CAB	2"		Front Coil Springs
33121	2WD, X-CAB	3"		Front Coil Springs
33119	2WD		1"	Lowering Block Kit
33123	2WD		2"	Lowering Block Kit
33124	2WD		3"	Lowering Block Kit



Lowered 2"/3"



2"/3" ECONOMY Kit (#33100)



2" Front Coils (#35100 shown)

2004-14 CHEVY COLORADO / GMC CANYON

PART #	APPLICATION	FRONT DROP	REAR DROP	DESCRIPTION	REAR SHOCKS	FOOT NOTES (On Pg. 82)
33100	2WD, S-CAB	2"	3"	Coils, Lowering Blocks, U-Bolts	Factory	FL
33101	2WD, X/QUAD	2"	3"	Coils, Lowering Blocks, U-Bolts	Factory	FL
35100	2WD, S-CAB	2"		Front Coils - No Factory Lowered Extremes	Factory	FL
35101	2WD, X/QUAD	2"		Front Coils - No Factory Lowered Extremes	Factory	FL



**2006 TRAILBLAZER SS
1.5" / 2" Front Coil
(#30015)**



**2002-09
TRAILBLAZER / ENVOY
1.5"/3" Kit (#33102)**

**2002-09 CHEVY
TRAILBLAZER / GMC ENVOY**

PART #	YEAR	APPLICATION	FRONT DROP	REAR DROP	DESCRIPTION	REAR SHOCKS	FOOT NOTES (On Pg. 82)
30015	06-09	SS TRAILBLAZER	1.5"	2"	Front Coils, Rear Instructions	Factory	XL
33102	02-09	2WD - NO SS	1.5"	3"	Front Coils, Rear Coils	Factory	XL



Lowered 1.5"/2"



**1" or 2" Drop Torsion Keys
(#33005)**



**1" or 2" Shackles
(Adjustable) (#33037)**



**Lowering Front
Coils (#33132 shown)**



2" Drop Spindles (#33141)

**1995-2000 TAHOE 4-DOOR,
TAHOE 2-DOOR & SUBURBAN**

PART #	APPLICATION	FRONT DROP	REAR DROP	DESCRIPTION	FOOT NOTES (On Pg. 82)
33005	4WD	1" or 2"		Front Lowering Torsion Keys	
33037	2WD/4WD		1" or 2"	Rear Lowering Shackles	
33132	2WD	1"		Front Lowering Coil Springs	
33133	2WD	2"		Front Lowering Coil Springs	
33141	2WD	2"		Front 2" Drop Spindles	HD



**Hangers 3" or 4"
Rear Drop (#33148)**



2"/4" ECONOMY KIT (#33147)



2"/4" ECONOMY Kit (#33146)



2"/4" DELUXE Kit (#33145)

1995-2000 TAHOE 4-DOOR

PART #	APPLICATION	FRONT DROP	REAR DROP	DESCRIPTION	FRONT SHOCKS	REAR SHOCKS	FOOT NOTES (On Pg. 82)
33148	2WD / 4WD 4-DOOR		3" or 4"	Hangers (Must use w/ Shackles - Raises to 3" or 4")			
33147	4WD 4-DOOR	2"	4"	Torsion Keys, Shackles, Hangers		2050	
33146	2WD 4-DOOR	2"	4"	Front Coils, Rear Shackles, Hangers	1451	2050	
33145	2WD 4-DOOR	2"	4"	Front Drop Spindles, Rear Shackles, Hangers	1451	2050	HD

Within the different years and models, GM has interchanged the truck leaf spring hangers. Use the pictures of the factory hangers (Right) as a guide to aid in which parts to order.

Factory Hangers

		
OUR DROP HANGER #33087 FOR THIS FACTORY HANGER 99-00 2500 01-03 1500 HD 2004 2500	OUR DROP HANGER #33086 FOR THIS FACTORY HANGER 02-10 3/4-TON 2500HD 02-10 DUALY X-CAB	OUR DROP HANGER #33085 FOR THIS FACTORY HANGER 02-10 1-TON DUALY CREW CAB



2WD/
4WD

2" / 4" or 5" DELUXE 6-Hole KIT (#33082)



2WD/4WD

2" / 3" Economy 6-Hole KIT (#33083)



2WD/4WD

3" / 5" DELUXE KIT (#33084)

8-LUG RIMS, 6-HOLE FACTORY HANGER

PART #	APPLICATION	FRONT DROP	REAR DROP	DESCRIPTION	REAR SHOCKS	FOOT NOTES (On Pg. 82)
33082	2WD / 4WD	2"	3" or 4"	Spindles, Hangers, & Shackles (17"+ Rims)	Factory	T
33083	2WD / 4WD	2"	3" or 4"	Keys, Hangers, & Shackles	Factory	
33084	2WD / 4WD	3"	3", 4" or 5"	Spindles, Keys, Hangers, & Shackles (17"+ Rims)	Factory	T



2WD/
4WD

2" / 4" or 5" ECONOMY Kit (#33080)



2WD/
4WD

2" / 4" or 5" DELUXE Kit (#33079)



2WD/4WD

3" / 5" DELUXE Kit (#33081)

8-LUG RIMS, 8-HOLE FACTORY HANGER

PART #	APPLICATION	FRONT DROP	REAR DROP	DESCRIPTION	REAR SHOCKS	FOOT NOTES (On Pg. 82)
33080	2WD / 4WD	2"	4" or 5"	Keys, Hangers, Shackles	Factory	
33079	2WD / 4WD	2"	4" or 5"	Spindles, Hangers, Shackles (17"+ Rims)	Factory	T, OL
33081	2WD / 4WD	3"	4" or 5"	Spindles, Keys, Hangers, Shackles (17"+ Rims)	Factory	T, OL



2WD/
4WD

2" / 3" DELUXE Kit (#33075)



2WD/
4WD

2" / 3" ECONOMY Kit (#33076)



2WD/4WD

3" / 5" DELUXE Kit (#33077)

8-LUG RIMS, 10-HOLE FACTORY HANGER

PART #	APPLICATION	FRONT DROP	REAR DROP	DESCRIPTION	REAR SHOCKS	FOOT NOTES (On Pg. 82)
33075	2WD / 4WD	2"	4" or 5"	Spindles, Hangers, Shackles (17"+ Rims)	Factory	T, OL
33076	2WD / 4WD	2"	4" or 5"	Keys, Hangers, Shackles	Factory	OL
33077	2WD / 4WD	3"	4" or 5"	Spindles, Keys, Hangers, Shackles (17"+ Rims)	Factory	T, OL

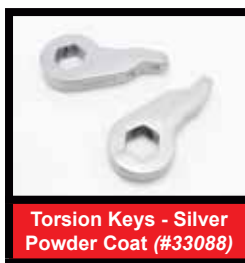

1999-00 CHEVY 2500, 01-03 1500HD, 2004 CHEVY 2500, 02-14 2500HD/3500

PART #	APPLICATION	FRONT DROP	REAR DROP	DESCRIPTION
33078	2WD / 4WD	2"		2" Drop Spindles (Must use 17" or Larger Rims)
33088	2WD / 4WD	2"		Lowering Torsion Keys
33089	2WD / 4WD		1" or 2"	Drop Shackles
33087	2WD / 4WD		3", 4" or 5"	Hangers (3", 4" or 5" Total Drop w/ Shackles)
33086	2WD / 4WD		4" or 5"	Hangers (4" or 5" Total Drop w/ Shackles) - Replaces Factory 8- Hole Hangers
33085	2WD / 4WD		4" or 5"	Hangers (4" or 5" Total Drop w/ Shackles) - Replace 10-Hole hangers



2011+ GM 2500 / 3500				
PART #	APPLICATION	REAR DROP	DESCRIPTION	REAR SHOCKS
33200	2WD / 4WD	1" or 2"	Lowering Shackle	Factory



1997-2003 FORD F-150
LIGHTNING 1" / 2" Drop Kit
(#70000)



1997-03 FORD EXPEDITION
2\"/>

1997-2003 FORD F-150 LIGHTNING

PART #	APPLICATION	FRONT DROP	REAR DROP	DESCRIPTION
70000	2WD, All Cabs	1"	2"	Front Coils & Rear Shackles

1997-2003 FORD F-150 EXPEDITION

PART #	APPLICATION	FRONT DROP	REAR DROP	DESCRIPTION
70017	2WD	2"	3"	Front Coils & Rear Coils



1997-2003 FORD F-150 2\"/>

1997-2003 FORD F-150

PART #	APPLICATION	FRONT DROP	REAR DROP	DESCRIPTION
70001	2WD, All Cabs	2"	4"	Front Coils, Shackles, Hangers



4" Drop Lowering Hangers w/
Shackles (#70020)



2" Lowering
Front Coils (#70021)

ADDITIONAL OPTIONS

(1997-2003 FORD F-150)

PART #	FRONT DROP	DESCRIPTION
70020	4"	Lowering Hangers (pr.)
70021	2"	Lowering Front Coils



Lowered 2\"/>



2004-2008 FORD F-150 DROP KITS

PART #	APPLICATION	FRONT DROP	REAR DROP	DESCRIPTION	OTHER PARTS REQUIRED	FOOT NOTES (On Pg. 82)
70003	4WD, S-Cab	2"	4"	Front Strut Relocators, Shackles, Spacers, & Shock Extenders		BS
70010	4WD, X/Crew	2"	4"	Front Strut Relocators, Shackles, Spacers, & Shock Extenders		BS
97012	2WD, All Cabs	2"	4"	Front Strut Relocators, Flip Kit, Lift Hanger, & Shock Extenders	#70014 (Carrier)	BS, C2
70007	2WD, All Cabs		4"	Flip Kit, Front Hanger Brackets, & Shock Extenders		



2009 Lowered 2 1/4"



INDIVIDUAL PARTS

PART #	APPLICATION	FRONT DROP	REAR DROP	DESCRIPTION
70008	2WD / 4WD All Cabs			Rear Shock Extenders (pr.)
70014	2WD			Carrier Bearing Relocator
70005	2WD All Cabs	2"		Drop Strut Spring Pocket Relocator (V-8, V-6)
70016	2WD / 4WD		2"	Rear Leveling Shackles



2" / 4" Drop Kit (#70029)



ALL OF OUR 2"/4"
KITS WORK WITH
THE FACTORY FRONT
& REAR SHOCKS



4" Drop Rear Kit (#70030)

2009-14 FORD F-150

PART #	APPLICATION	FRONT DROP	REAR DROP	DESCRIPTION
70029	2WD, All Cabs	2"	4"	Coil Relocator, Hanger, Flip, Bump Stops, Shock Extenders
70030	2WD, All Cabs		4"	Rear Kit Only - Flip Kit, Front Lift Hanger Brackets & Shock Extenders



2015 Lowered 2"/4"



2" / 4" Drop Kit (#70039)



Carrier Bearing Relocator (#70040)

2015 FORD F-150

PART #	APPLICATION	FRONT DROP	REAR DROP	DESCRIPTION
70039	2WD ALL CABS	2"	4"	Coil Relocators, Flip Kit, Lift Hangers, U-Bolts w/ Hardware, Carrier Bearing Relocator, Bump Stops, Shock Extenders
70040	2WD ALL CABS			Carrier Bearing Relocator Only



SRT 1.5"/2"



SRT 2"/4"



2"/4.5" ECONOMY Kit (#44003)



4.5" Rear Kit (#44009)



2"/4.5" DELUXE (#94002)



4"/6" DELUXE Kit (#94005)



6" Rear Kit (#44010)



2004-05 DODGE SRT 1.5"/2" Kit
STD Cab (#44011)



4"/6"

2002-2005 DODGE RAM 1500						
PART #	YEAR	APPLICATION	FRONT DROP	REAR DROP	DESCRIPTION	FOOT NOTES (On Pg. 82)
44003	02-05	2WD, S-Cab	2"	4.5"	Coils, Flip Kit, Shackles, Shock Extenders	BS
44004	02-05	2WD, X/Quad/SRT	2"	4.5"	Coils, Flip Kit, Shackles, Shock Extenders	BS
94002	02-05	2WD, S/X/Quad	2"	4.5"	Spindles, Flip Kit, Shackles, Shock Extenders	BS, SR
44009	02-05	2WD, S/X/Quad	4"		Rear Lowering Kit (Shackles, Flip, Shock Extenders, Bump Stops)	
44010	02-05	2WD, S/X/Quad		6"	Rear Lowering Kit (Shackles, Flip, Shock Extenders, Bump Stops)	
94005	02-05	2WD, S-Cab	4"	6"	Spindles, Coils, Flip Kit, C-Notch, Shock Extenders	BS, E
94006	02-05	2WD, X/Quad	4"	6"	Spindles, Coils, Flip Kit, C-Notch, Shock Extenders	BS, E
44011	04-06	SRT, S-Cab	1.5"	2"	Coils, Lowering Block Kit w/ U-Bolts	



2" Front Coils
(#44007)



Lift Shackle Raises rear from 6" to 4.5" Drop (#44005)

ADDITIONAL OPTIONS					
PART #	YEAR	APPLICATION	FRONT DROP	REAR DROP	DESCRIPTION
44007	02-05	2WD, X/Quad/SRT	2"		2" Front Lowering Coil Springs
44008	02-05	2WD, S-Cab	2"		2" Front Lowering Coil Springs
44005	02-05	2WD		4.5"	Rear Lift Shackle



DODGE SRT 1.5"/2" Kit (#44017)



2"/4.5" DELUXE Kit (#44014)



2"/4.5" ECONOMY Kit (#44015)



4"/6" Kit (#44019)

2006-2008 DODGE RAM 1500					
PART #	APPLICATION	FRONT DROP	REAR DROP	DESCRIPTION	FOOT NOTES (On Pg. 82)
44017	SRT, S-Cab	1.5"	2"	Coils, Lowering Block Kit w/ U-Bolts	BS
44014	2WD ONLY, S/X/Quad	2"	4.5"	Spindles, Flip, Shackles, Shock Extenders	BS
44015	2WD, Quad / SRT Quad	2"	4.5"	Coils, Flip Kit, Shackle, Shock Extenders	BS
44016	2WD, S-Cab	2"	4.5"	Coils, Flip Kit, Shackle, Shock Extenders	BS
44019	2WD, S-Cab	4"	6"	Spindles, Coils, C-Notch, Flip, Shock Extenders	BS
44024	2WD ONLY, Quad Cab	4"	6"	Spindles, Coils, C-Notch, Flip, Shock Extenders	BS



2002-08 DODGE RAM 1500 Rear Air Bag Helper Kit (#44012)



2006-08 DODGE 2" Front Coils (#44021)



2002-08 DODGE RAM 1500 2" Leveling Shackle (#44002)



2006-08 DODGE RAM 1500 Lift Shackles (#44026)



2002-08 DODGE RAM 1500 Rear Shock Extenders Rear C-Notch (#44013)



2001-08 DODGE RAM 1500 Rear Shock Extenders (#44000)

ADDITIONAL PARTS						
PART #	YEAR	APPLICATION	FRONT DROP	REAR DROP	DESCRIPTION	FOOT NOTES (On Pg. 82)
44000	02-08	2WD, S/X/Quad			Rear Shock Extenders (pr.)	
44002	02-08	2WD		2"	Rear Leveling Shackles	
44026	06-08	2WD			Rear Lift Shackle - Raises rear from 6" to 4.5" Drop	
44013	02-08	2WD S/X/Quad			Rear C-Notch	E
44021	06-08	2WD, S-Cab	2"		Front Lowering Coil Springs	
44022	06-08	2WD, X/Quad	2"		Front Lowering Coil Springs	
44012	02-08	2WD ALL CABS			Rear Air Bag Helper Kit (Works on 4.5" or 6" Rear Drop)	



2" / 4" ECONOMY Kit (#44051)



2" / 4" DELUXE Kit (#44050)



2"/4"

2009-2014 DODGE RAM 1500

PART #	APPLICATION	FRONT DROP	REAR DROP	DESCRIPTION	SHOCKS	FOOT NOTES (On Pg. 82)
44050	2WD, S/X/Quad	2"	4"	Spindles, Rear Coils, Sway Bar End Links, Track Bar Relocator, Bump Stops	Factory	WT
44051	2WD, S-Cab	2"	4"	Front & Rear Coils, Sway Bar End Links, Track Bar Relocator, Bump Stops-Uses Stock Shocks	Factory	
44052	2WD, X/Quad	2"	4"	Front & Rear Coils, Sway Bar End Links, Track Bar Relocator, Bump Stops-Uses Stock Shocks	Factory	



Lowered 2"/4"



2" Drop Spindles (#44001)
US Patent #D504,363S & #D504,363



2" Lowering Rear Coils (#44055)



2" Front Coils (#44060)

ADDITIONAL OPTIONS
(2009-2014 DODGE 1500)

PART #	APPLICATION	FRONT DROP	REAR DROP	DESCRIPTION	FOOT NOTES (On Pg. 82)
44001	2WD ONLY		2"	Drop Spindles (US Patent #D504, 363S & #D504,363)	WT
44055	2WD ONLY		2"	Lowering Rear Coil Springs (Leveling Coils)	
44060	2WD DODGE-2S S-Cab	2"		Lowering Front Coil Springs	
44061	2WD DODGE-2X X/Quad Cab Car	2"		Lowering Front Coil Springs	

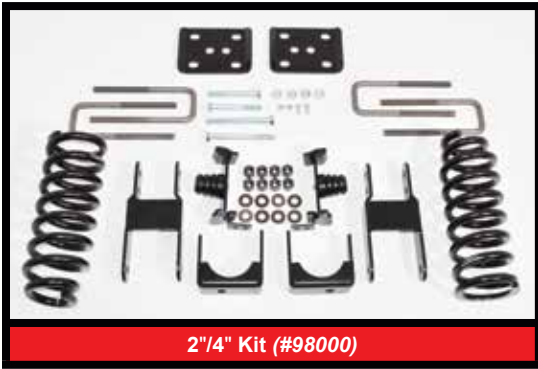

2"1/4" Kit (#98000)

2007-2014 TOYOTA TUNDRA KITS

PART #	APPLICATION	FRONT DROP	REAR DROP	DESCRIPTION	REAR SHOCKS
98000	2WD S-CAB	2"	4"	Front Coils, Flip Kit w/ U-Bolts, Shackles, Bump Stops	2150
98010	2WD, C-Max, D-Cab	2"	4"	Front Coils, Flip Kit w/ U-Bolts, Shackles, Bump Stops	2150
98004	2WD, All Cabs	2"	4"	Spindles, Flip Kit, Lift Shackle	2150
98020	2WD, No S-Cab	4"	6"	Spindles, C-Notch - Use Stock Shackles (Upgrade for 2"1/4" Kit)	2150
98016	2WD, C-Max, D-Cab	4"	6"	Spindles, Coils, Flip Kit, C-Notch	2150



2"1/4" DELUXE Kit (#98004)



UPGRADE Kit (Converts 2"1/4" ECONOMY to 4"1/6" DELUXE) (#98020)

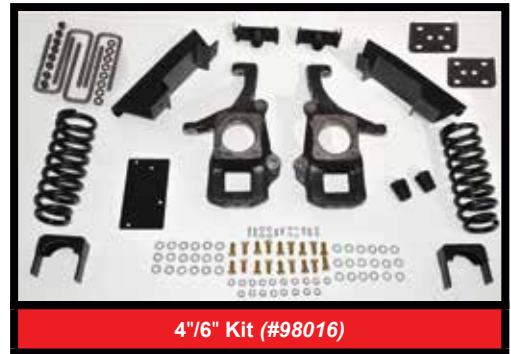

4"1/6" Kit (#98016)

ALL OF OUR 2"1/4" KITS WORK WITH THE FACTORY FRONT & REAR SHOCKS



Lowered 4"1/6"



2" Drop Spindles (#98003)

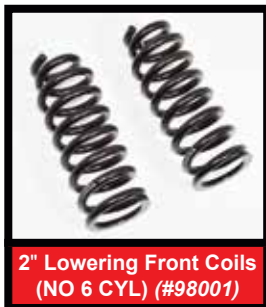

2" Lowering Front Coils (NO 6 CYL) (#98001)

INDIVIDUAL PARTS (2007-2014 TOYOTA TUNDRA)

PART #	APPLICATION	FRONT DROP	DESCRIPTION
98003	2WD, C-Max, D-Cab	2"	Front Drop Spindles
98001	2WD, S-Cab	2"	Front Coils (NO. 6 CYL.)
98002	2WD, C-Max, D-Cab	2"	Front Coils (NO. 6 CYL.)
98021	All Cabs		Lift Shackles



1"-2" Lift Shackles (#98021)

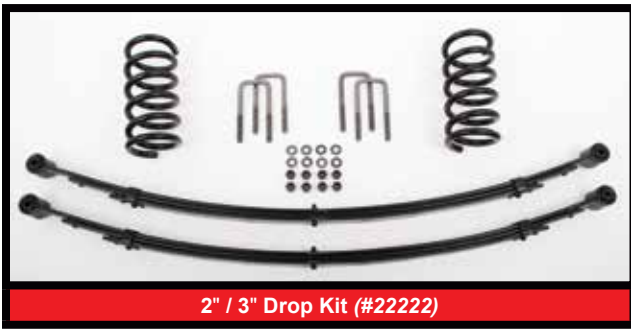

2004-2013 NISSAN TITAN					
PART #	APPLICATION	FRONT DROP	REAR DROP	DESCRIPTION	REAR SHOCKS
22222	2WD, QUAD	2"	3"	Front Coils & Rear Leaf Springs - No Long Beds	Factory

NOTES

Classic Car

55-70 FULLSIZE CHEVY CAR

PART #	YEAR	APPLICATION	FRONT DROP	REAR DROP	KIT	PAGE #
1451	55-57		Stock - 4"		Front Lowering Shock	73
2051	55-57				Rear Lowering Shock	73
5557	55-57		2"		Drop Spindles (Must use #63205 Disc Brake Kit)	73
33119	55-57			1"	Lowering Block Kit (U-Bolts, Blocks, Hardware)	73
33123	55-57			2"	Lowering Block Kit (U-Bolts, Blocks, Hardware)	73
33124	55-57			3"	Lowering Block Kit (U-Bolts, Blocks, Hardware)	73
63159	55-57				Power Steering Hose Kit for 605 Box (Flare Fittings, QTY 2)	72
63160	55-57				P/S Pump Bracket for Side Motor Mounts (Small Block)	72
63161	55-57				P/S Pump Bracket for Side Motor Mounts (Big Block)	72
63163	55-57				Adj. Proportioning Valve	73
63191	55-57				P/S Pump Bracket (for Original Front Motor Mounts)	72
63192	55-57				Side Motor Mounts (Stock Location) - 2-PC Seamed Frame	72
63193	55-57				Side Motor Mounts (Stock Location) - Seamless Frame	72
63194	55-57				Side Motor Mounts (3/4" Forward) - 2-PC Seamed Frame	72
63195	55-57				Side Motor Mounts (3/4" Forward) - Seamless Frame	72
63196	55-57				Rear Transmission Crossmember W/ Mounting Hardware	72
63197	55-57				Rear Stock Mount w/ Hardware	72
63198	55-57				Upper A-Frames w/ Bushings (Use Original Cross-Shafts & Ball Joints) - Adds 5° Of Positive Caster	72
63199	55-57				Lower A-Frames w/ Bushings (Use Original Cross-Shafts & Ball-Joints)	72
63200	55-57				Front Disc Brackets (Converts Stock 55-58 Chevy Car Spindles to Disc Brakes)	72
63201	55-57				Stock Rotor Kit w/ Rotors, Calipers, Bearings, Seals, Hoses, Banjo Bolts, Dust Caps, Spindle Nuts, Spindle Washers & Cotter Pins. - Works on Stock Front Disc Brake Brackets. Moves the wheels out 3/4" on each side. Will not work w/ Factory 14" wheels.	72
63202	55-57				7" Booster w/ Mounting Bracket & Master Cylinder	72
63203	55-57				Non-Power Master Cylinder (Dual Reservoir)	72
63205	55-57				Rotor Kit for Drop Spindles (Rotors, Calipers, Bearings, Seals, Hoses, Dust Caps, Spindle Nuts & Washers, & Cotter Pins)	72
63208	55-57			2.5"	Lowering Leaf Springs (4-Leaf) - No convertible/hardtop/5-Leaf cars	73
63209	55-57				Turbo Mounts (for the Bell-Housing w/ Front Motor Mounts)	73
63210	55-57				Shift Linkage (350/400 Transmissions)	73
63211	55-57				Shift Linkage (700R4 Transmissions)	73
63212	55-57				Rear Traction Bar Kit	73
63214	55-57		1"		1" Lowering Front Coils	73
63215	55-57				Stock Height Front Coils	73
63216	55-57				Rear Pocket Kit (Can't Use w/ #63208 Lowering Leafs)	73
63220	55-57				Rear Disc Brackets for Rear Disc Conversion	73
63255	55-57	5 x 4.75"	2"		13" Front Kit w/ 2" Drop Spindles (Cross-Drilled)	73
63257	55-57	5 x 4.75"	2"		13" Front Kit w/ 2" Drop Spindles (Smooth)	73
64090	55-57				Non-Adj. Proportioning Valve w/ Lines & Bracket	73
64095	55-57				11" Rotor Kit (5 on 4.75")	75
64096	55-57				13" Rotor Kit (5 on 4.75") - SMOOTH	75
64097	55-57				13" Rotor Kit (5 on 4.75") - CROSS-DRILLED	72
63159	58-64				Power Steering Hose Kit for 605 Box (Flare Fittings, QTY 2)	74
63160	58-64				P/S Pump Bracket for Side Motor Mounts (SMALL BLOCK)	74
63161	58-64				P/S Pump Bracket for Side Motor Mounts (BIG BLOCK)	74
63162	58-64				Drop Spindles (Must use #63205 Disc Brake Kit)	74
63163	58-64				Adjustable Proportioning Valve	74
63200	55-58				Front Disc Brake Brackets (Converts Stock Chevy Car Spindles to Disc Brakes)	74
63201	58-64				Stock Rotor Kit w/ Rotors, Calipers, Bearings, Seals, Hoses, Banjo Bolts, Dust Caps, Spindle Nuts, Spindle Washers & Cotter Pins. - Works on Stock Front Disc Brake Brackets. Moves the wheels out 3/4" on each side. Will not work w/ Factory 14" wheels.	74

55-70 FULLSIZE CHEVY CAR

PART #	YEAR	APPLICATION	FRONT DROP	REAR DROP	KIT	PAGE #
63202	58-64				Booster / Master Cylinder (for Floor Shift)	74
63203	58-64				Non-Power Master Cylinder (Dual Reservoir)	74
63205	58-64				Rotor Kit for Drop Spindles (Rotors, Calipers, Bearings, Seals, Hoses, Dust Caps, Spindle Nuts & Washers, & Cotter Pins)	74
63220	58-64				Rear Disc Brackets for Rear Disc Conversion	74
63222	58-64				Upper A-Frames w/ Bushings	74
63223	58-64				Lower A-Frames w/ Bushings	74
63224	59-64				Front Disc Brake Brackets (Converts Stock Chevy Car Spindles to Disc Brakes)	74
63225	58-64				Booster / Master Cylinder (for Column Shift)	74
63226	58-64		1"		Front Lowering Coil Springs	74
63227	58-64			2.5"	Rear Lowering Coil Springs	74
63258	58-64		2"		13" Front Kit w/ 2" Drop Spindles - Cross-Drilled (5 x 4.75")	75
63259	58-64		2"		13" Front Kit w/ 2" Drop Spindles - Smooth (5 x 4.75")	75
64090	58-64				Non-Adj. Proportioning Valve w/ Lines & Bracket	74
64095	58-64				11" Rotor Kit (5 on 4.75")	75
64096	58-64				13" Rotor Kit (5 on 4.75") - SMOOTH	75
64097	58-64				13" Rotor Kit (5 on 4.75") - CROSS-DRILLED	75
6570	65-70		2"		Drop Spindles (Must use #63205 Disc Brake Kit)	75
63163	65-70				Adj. Proportioning Valve	75
63201	65-70				Stock Rotor Kit w/ Rotors, Calipers, Bearings, Seals, Hoses, Banjo Bolts, Dust Caps, Spindle Nuts, Spindle Washers & Cotter Pins. - Works on Stock Front Disc Brake Brackets. Moves the wheels out 3/4" on each side. Will not work w/ Factory 14" wheels.	75
63205	65-70				Rotor Kit for Drop Spindles (Rotors, Calipers, Bearings, Seals, Hoses, Dust Caps, Spindle Nuts & Washers, & Cotter Pins)	75
63228	65-68				Front Disc Brake Brackets for Stock Height Disc Brakes	75
64090	65-70				Non-Adj. Proportioning Valve w/ Lines & Bracket	75

62-74 CHEVY NOVA

PART #	YEAR	APPLICATION	FRONT DROP	REAR DROP	KIT	PAGE #
6267	62-67		2"		Drop Spindles (must use #63205 Disc Brake Kit)	76
63235	62-67				Booster w/ Mounting Bracket & Master Cylinder	76
6874	68-74		2"		Drop Spindles	76
63163	68-74				Adjustable Proportioning Valve	76
63203	68-74				Non-Power Master Cylinder (Dual Reservoir)	76
63205	68-74				Rotor Kit for Drop Spindles (Rotors, Calipers, Bearings, Seals, Hoses, Dust Caps, Spindle Nuts & Washers, & Cotter Pins)	76
63229	68-74				Upper A-Frames w/ Bushings	76
63230	68-74				Booster w/ Mounting Bracket & Master Cylinder	76
63236	68-74	5 x 4.75			13" Front Kit w/ 2" Drop Spindles - Use Stock Steering Arms (Cross-Drilled)	76
63237	68-74	5 x 4.75			13" Front Kit w/ 2" Drop Spindles - Use Stock Steering Arms (Smooth)	76
63251	68-74				Lower A-Frames w/ Bushings	76
64090	68-74				Non-Adj. Proportioning Valve w/ Lines & Bracket	76

67-81 CHEVY CAMARO

PART #	YEAR	FRONT DROP	KIT	PAGE #
6769	67-69	2"	Drop Spindles	76
63163	67-69		Adjustable Proportioning Valve	76
63203	67-69		Non-Power Master Cylinder (Dual Reservoir)	76
63205	67-69		Rotor Kit for Drop Spindles (Rotors, Calipers, Bearings, Seals, Hoses, Dust Caps, Spindle Nuts & Washers, & Cotter Pins)	76
63229	67-69		Upper A-Frames w/ Bushings	76
63230	67-69		Booster w/ Mounting Bracket & Master Cylinder	76
63236	67-69		13" Front Kit w/ 2" Drop Spindles (5 x 4.75) - Use Stock Steering Arms (Cross-Drilled)	76
63237	67-69		13" Front Kit w/ 2" Drop Spindles (5 x 4.75) - Use Stock Steering Arms (Smooth)	76
63251	67-69		Lower A-Frames w/ Bushings	76
64090	67-69		Non-Adj. Proportioning Valve w/ Lines & Bracket	76
7078	70-78	2"	Drop Spindles (Must use original Disc Brakes)	77
64077	70-78	2"	13" Front Disc Kit w/ 2" Drop Spindles Smooth	77
64078	70-78	2"	13" Front Disc Kit w/ 2" Drop Spindles (5 x 4.75") Cross-Drilled	77
64090	70-78		Non-Adj. Proportioning Valve w/ Lines & Bracket	77
7981	79-81	2"	Drop Spindles (Must use original Disc Brakes)	77
64079	79-81	2"	13" Front Disc Kit w/ 2" Drop Spindles (5 x 4.75")	77
64080	79-81	2"	13" Front Disc Kit w/ 2" Drop Spindles (5 x 4.75")	77
64090	79-81		Non-Adj. Proportioning Valve w/ Lines & Bracket	77

64-72 A-BODY: CHEVELLE, EL CAMINO, OLDS 442, GTO, LE MANS, & MONTE CARLO

PART #	YEAR	FRONT DROP	KIT	PAGE #
6472	64-72	2"	Drop Spindles (Must use #63205 Brake Kit)	78
63163	64-72		Adjustable Proportioning Valve	78
63201	64-72		Stock Rotor Kit w/ Rotors, Calipers, Bearings, Seals, Hoses, Banjo Bolts, Dust Caps, Spindle Nuts, Spindle Washers & Cotter Pins. - Works on Stock Front Disc Brake Brackets. Moves the wheels out 3/4" on each side. Will not work w/ Factory 14" wheels.	78
63203	64-72		Non-Power Master Cylinder (Dual Reservoir)	78
63205	64-72		Rotor Kit for Drop Spindles (Rotors, Calipers, Bearings, Seals, Hoses, Dust Caps, Spindle Nuts & Washers, & Cotter Pins)	78
63230	64-72		Booster w/ Mounting Bracket & Master Cylinder	78
63231	64-72		Upper A-Frames w/ Bushings	78
63236	64-72	2"	13" Front Kit w/ 2" Drop Spindles (5 x 4.75") Cross-Drilled	78
63237	64-72	2"	13" Front Kit w/ 2" Drop Spindles (5 x 4.75") Smooth	78
63242	64-69	2"	Rear Coil Springs (64-68 CHEVELLE, 1969 CHEVELLE 2-DR, 67-68 OLD CUTLASS)	78
63245	64-67		Upper & Lower Rear Trailing Arms. (Keep rear-end from shifting, bolt-on, adj. pinion angle on uppers, added sway bar brace, powder coated silver)	78
63246	64-67		Upper & Lower Rear Trailing Arms. (Keep rear-end from shifting, bolt-on, adj. pinion angle on uppers, added sway bar brace, powder coated silver)	78
63250	64-72		Lower A-Frames w/ Bushings	78
64090	64-72		Non-Adj. Proportioning Valve w/ Lines & Bracket	78



**Power Steering Hose Kit
For 605 Box - Flare Fittings
(#63159)**



**Pump Bracket -
Original Front Motor
Mounts (#63191)**



**Power Steering Pump Bracket
for Side Motor Mounts
Small Block (#63160) shown
Big Block (#63161)**



**Side Motor Mounts
(#63192)**

1955-1957 FULLSIZE CHEVY CAR

PART #	DESCRIPTION	FOOT NOTES (On Pg. 82)
63159	Power Steering Hose Kit for 605 Box (Flare Fittings, QTY 2)	
63160	P/S Pump Bracket for Side Motor Mounts (Small Block)	
63161	P/S Pump Bracket for Side Motor Mounts (Big Block)	
63191	P/S Pump Bracket (for Original Front Motor Mounts)	
63192	Side Motor Mounts (Stock Location) - 2-PC Seamed Frame	
63193	Side Motor Mounts (Stock Location) - Seamless Frame	
63194	Side Motor Mounts (3/4" Forward) - 2-PC Seamed Frame	
63195	Side Motor Mounts (3/4" Forward) - Seamless Frame	
63196	Rear Transmission Crossmember W/ Mounting Hardware	
63197	Rear Shock Mount w/ Hardware	
63198	Upper A-Frames w/ Bushings (Use Original Cross-Shafts & Ball Joints) - Adds 5° Of Positive Caster	BJ, CS
63199	Lower A-Frames w/ Bushings (Use Original Cross-Shafts & Ball-Joints)	BJ, CS
63200	Front Disc Brackets (Converts Stock 55-58 Chevy Car Spindles to Disc Brakes)	DB, SW
63201	Stock Rotor Kit w/ Rotors, Calipers, Bearings, Seals, Hoses, Banjo Bolts, Dust Caps, Spindle Nuts, Spindle Washers & Cotter Pins. - Works on Stock Front Disc Brake Brackets. Moves the wheels out 3/4" on each side. Will not work w/ Factory 14" wheels.	
63202	7" Booster w/ Mounting Bracket & Master Cylinder	
63203	Non-Power Master Cylinder (Dual Reservoir)	



**Rear Transmission Cross-Member
w/ Mounting Hardware (#63196)**



Rear Shock Mount w/ Hardware (#63197)



**Non-Power
1" Bore Master
Cylinder
(#63203)**



**Upper A-Frames w/ Bushings
(#63198)**



**Lower A-Frames
w/ Bushings
(#63199)**



**55-58 Front Disc Bracket
(Converts Stock Chevy
Car Spindles to Disc
Brakes) (#63200)**



**Floor Shift Booster / Master
Cylinder (#63202)**



Stock Rotor Kit (#63201)



Adj. Proportioning Valve - Use in-line to the Rear Drum Brakes (#63163)



Drop Rotor Kit - Use w/ our 2" Drop Spindles (#63205)



2" Drop Spindles -Must use Rotor Kit #63205 (#5557)



Sedan 4-Leaf 2.5" Lowering Leaf Spring - No Convertibles or Hard Tops (#63208)



Lowering Block Kit 2" (#33123) - shown 3" (#33124)



Turbo Mounts (#63209)



Shift Linkage 350/400 (#63210) 700R (#63211)



Rear Traction Bars (#63212)



Front Coils (#63214)



Rear Pocket Kit - Can't use w/ #63208 Lowering Leafs (#63216)



Non-Adjustable Proportioning Valve (#64090)



Rear Lowering Shock (#2051)



Front Lowering Shock (Stock - 4" Drop) (#1451)



Rear Disc Brackets for Disc Conversion on Stock 55-64 Fullsize Car Rear-End (#63220)



13" Front Disc Kit - Cross-Drilled (#63255)



13" Front Disc Kit-Smooth (#63257)

1955-1957 FULLSIZE CHEVY CAR

PART #	APPLICATION / YEAR	FRONT DROP	REAR DROP	DESCRIPTION	FOOT NOTES (On Pg. 82)
1451		Stock - 4"		Front Lowering Shock	
2051				Rear Lowering Shock	
5557		2"		Drop Spindles (Must use #63205 Disc Brake Kit)	
33119			1"	Lowering Block Kit (U-Bolts, Blocks, Hardware)	
33123			2"	Lowering Block Kit (U-Bolts, Blocks, Hardware)	
33124			3"	Lowering Block Kit (U-Bolts, Blocks, Hardware)	
63163				Adj. Proportioning Valve	
63205				Rotor Kit for Drop Spindles (Rotors, Calipers, Bearings, Seals, Hoses, Dust Caps, Spindle Nuts & Washers, & Cotter Pins)	
63208			2.5"	Lowering Leaf Springs (4-Leaf) - No convertible/hardtop/5-Leaf cars	
63209				Turbo Mounts (for the Bell-Housing w/ Front Motor Mounts)	
63210				Shift Linkage (350/400 Transmissions)	
63211				Shift Linkage (700R4 Transmissions)	
63212				Rear Traction Bar Kit	
63214			1"	1" Lowering Front Coils	
63215				Stock Height Front Coils	
63216				Rear Pocket Kit (Can't Use w/ #63208 Lowering Leafs)	
63220	59-64			Rear Disc Brackets for Rear Disc Conversion	SW
63255	5x4.75"	2"		13" Front Kit w/ 2" Drop Spindles	
63257	5x4.75"	2"		13" Front Kit w/ 2" Drop Spindles	
64090				Non-Adj. Proportioning Valve w/ Lines & Bracket	

1958-1964 CHEVY FULLSIZE CAR



Power Steering Hose Kit For 605 Box - Flare Fittings (#63159)



Power Steering Pump Bracket for Side Motor Mounts (#63160)



Upper A-Frames w/ Bushings - Use Original Cross-Shafts & Ball Joints (#63222)



Lower A-Frames w/ Bushings - Use Original Cross-Shafts & Ball Joints (#63223)



Adj. Proportioning Valve (#63163)



59-64 Front Disc Brake Brackets (#63224)



55-58 Front Disc Bracket (#63200)



Stock Rotor Kit (#63201)



Booster w/ Bracket & Master CYL. Shift (#63225)



Floor Shift Cars Booster / Master (#63202)



Non-Power 1" Bore Master Cylinder (#63203)



2" Drop Spindles (#63162)

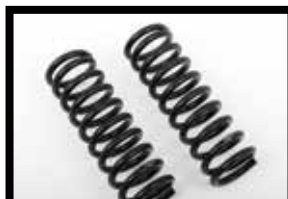

Front 1" Lowering Coils (#63226)



Non-Adjustable Proportioning Valve (#64090)



Drop Rotor Kit (#63205)

PART #	YEAR	FRONT DROP	REAR DROP	DESCRIPTION	FOOT NOTES (On Pg. 82)
63159				Power Steering Hose Kit for 605 Box (Flare Fittings, QTY 2)	
63160				P/S Pump Bracket for Side Motor Mounts (SMALL BLOCK)	
63161				P/S Pump Bracket for Side Motor Mounts (BIG BLOCK)	
63162		2"		Drop Spindles (Must use #63205 Disc Brake Kit)	
63163				Adjustable Proportioning Valve	
63200	55-58			Front Disc Brake Brackets (Converts Stock Chevy Car Spindles to Disc Brakes)	DB, SW
63201				Stock Rotor Kit w/ Rotors, Calipers, Bearings, Seals, Hoses, Banjo Bolts, Dust Caps, Spindle Nuts, Spindle Washers & Cotter Pins. - Works on Stock Front Disc Brake Brackets. Moves the wheels out 3/4" on each side. Will not work w/ Factory 14" wheels.	
63202				Booster / Master Cylinder (for Floor Shift)	
63203				Non-Power Master Cylinder (Dual Reservoir)	
63205				Rotor Kit for Drop Spindles (Rotors, Calipers, Bearings, Seals, Hoses, Dust Caps, Spindle Nuts & Washers, & Cotter Pins)	
63222	58-64			Upper A-Frames w/ Bushings	BJ, CS
63223	58-64			Lower A-Frames w/ Bushings	BJ, CS
63224	59-64			Front Disc Brake Brackets (Converts Stock Chevy Car Spindles to Disc Brakes)	SW
63225	58-64			Booster / Master Cylinder (for Column Shift)	
63226	58-64	1"		Front Lowering Coil Springs	
63227	58-64		2.5"	Rear Lowering Coil Springs	
64090				Non-Adj. Proportioning Valve w/ Lines & Bracket	



11" Stock Rear-End Rotor Kit (#63095)



13" (Stock Rear-End) Rear Disc Kit - Smooth (#64096)



13" (Stock Rear-End) Rear Disc Kit - Cross-Drilled (#64097)

1955-1964 CHEVY FULLSIZE CAR (BIG BRAKE KITS)

PART #	APPLICATION	FRONT DROP	DESCRIPTION	FOOT NOTES (On Pg. 82)
64095	2WD		11" Rotor Kit (5 on 4.75")	
64096	2WD		13" Rotor Kit (5 on 4.75") - SMOOTH	T
64097	2WD		13" Rotor Kit (5 on 4.75") - CROSS-DRILLED	T
63259	2WD	2"	13" Front Kit w/ 2" Drop Spindles - Smooth (5 x 4.75")	T
63258	2WD	2"	13" Front Kit w/ 2" Drop Spindles - Cross-Drilled (5 x 4.75")	T



13" Front Disc Kit w/ 2" Drop Spindles - Smooth (#63259)



13" Front Disc Kit w/ 2" Drop Spindles - Cross-Drilled (#63258)



2" Drop Spindles (#6570)



Drop Rotor Kit (#63205)



Front Disc Brake Brackets - Use Rotor Kit #63201. Moves wheels out 3/4" on each side. Will not work w/ Factory 14" wheels. (#63228)

1965-1970 CHEVY FULLSIZE CAR

PART #	YEAR	FRONT DROP	DESCRIPTION	FOOT NOTES (On Pg. 82)
6570	65-70	2"	Drop Spindles (Must use #63205 Disc Brake Kit)	DB
63205			Rotor Kit for Drop Spindles (Description on Pg. 73)	
63228	65-68		Front Disc Brake Brackets for Stock Height Disc Brakes	
63201			Stock Rotor Kit w/ Disc Brakes, Rotors, Calipers, Bearings, Seals, Hoses, ETC. (Description on Pg. 74)	
63163			Adj. Proportioning Valve	
64090			Non-Adj. Proportioning Valve w/ Lines & Bracket	



Stock Rotor Kit (#63201)



Adjustable Proportioning Valve (#63163)



Non-Adjustable Proportioning Valve (#64090)



2" Drop Spindles (#6769 / #6874)

1962-1967 CHEVY NOVA				
PART #	YEAR	FRONT DROP	DESCRIPTION	FOOT NOTES (On Pg. 82)
6267	62-67	2"	Drop Spindles (must use #63205 Disc Brake Kit)	DB



68-74 NOVA Upper A-Frames w/ Bushings (#63229)



68-74 NOVA Lower A-Frames w/ Bushings (#63251)

1968-1974 CHEVY NOVA / 67-69 CHEVY CAMARO			
PART #	FRONT DROP	DESCRIPTION	FOOT NOTES (On Pg. 82)
6769	2"	Drop Spindles	DB
63163		Adjustable Proportioning Valve	
63203		Non-Power Master Cylinder (Dual Reservoir)	
63205		Rotor Kit for Drop Spindles (#6769)	
63229		Upper A-Frames w/ Bushings	BJ, CS
63230		Booster w/ Mounting Bracket & Master Cylinder	
63251		Lower A-Frames w/ Bushings	BJ
64090		Non-Adj. Proportioning Valve w/ Lines & Bracket	



67-69 Camaro/68-74 NOVA Booster w/ Bracket & Master CYL. (#63230)



Adjustable Proportioning Valve (#63163)



Non-Adjustable Proportioning Valve (#64090)



Non-Power 1" Bore Master Cylinder (#63203)



Drop Rotor Kit (#63205)



13" Front Disc Kit (Smooth) (#63237)



13" Front Disc Kit (Cross-Drilled) (#63236)

67-69 CAMARO / FIREBIRD, 68-74 NOVA				
PART #	APPLICATION	FRONT DROP	DESCRIPTION	FOOT NOTES (On Pg. 82)
63236	2WD Cross-Drilled	2"	13" Front Kit w/ 2" Drop Spindles (5 x 4.75) - Use Stock Steering Arms (Cross-Drilled)	T
63237	2WD Smooth	2"	13" Front Kit w/ 2" Drop Spindles (5 x 4.75) - Use Stock Steering Arms (Smooth)	T





2" Drop Spindles (#7078)



13" Front Disc Kit (Smooth)
(5 on 4.75") - Must use 17"+ Rims (#64077)



13" Front Disc Kit (Cross-Drilled)
(5 on 4.75") - Must use 17"+ Rims (#64078)

1970-1978 CHEVY CAMARO

PART #	FRONT DROP	DESCRIPTION	FOOT NOTES (On Pg. 82)
7078	2"	Drop Spindles (Must use original Disc Brakes)	
64077	2"	13" Front Disc Kit w/ 2" Drop Spindles (5 x 4.75") Smooth	T
64078	2"	13" Front Disc Kit w/ 2" Drop Spindles (5 x 4.75") Cross-Drilled	T



2" Drop Spindles (#7981)



13" Front Disc Kit (Smooth)
Must use 17"+ Rims (#64079)



13" Front Disc Kit (Cross-Drilled)
Must use 17"+ Rims (#64080)

1979-1981 CHEVY CAMARO

PART #	APPLICATION	FRONT DROP	DESCRIPTION	FOOT NOTES (On Pg. 82)
7981	2WD	2"	Drop Spindles (Must use original Disc Brakes)	
64079	2WD	2"	13" Front Disc Kit w/ 2" Drop Spindles (5 x 4.75")	T
64080	2WD	2"	13" Front Disc Kit w/ 2" Drop Spindles (5 x 4.75")	T



2" Drop Spindles (#6472)



Drop Rotor Kit (#63205)



Adjustable Proportioning Valve (#63163)



Booster w/ Bracket & Master CYL. (#63230)



64-72 Upper A-Frames w/ Bushings (#63231)



64-72 Lower A-Frames w/ Bushings (#63250)



Non-Adjustable Proportioning Valve (#64090)



Non-Power 1" Bore Master Cylinder (#63203)



Upper & Lower Rear Trailing Arms (#63245)



13" Front Disc Kit (Smooth) 5 on 4.75" - Use Stock Steering Arms (#63237)



13" Front Disc Kit (Cross-Drilled) 5 on 4.75" - Use Stock Steering Arms (#63236)

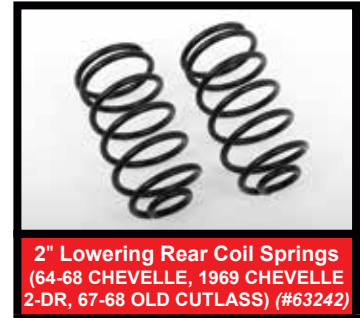

2" Lowering Rear Coil Springs (64-68 CHEVELLE, 1969 CHEVELLE 2-DR, 67-68 OLD CUTLASS) (#63242)

1964-72 A-BODY: CHEVELLE, EL CAMINO, OLDS 442, GTO, LE MANS, & MONTE CARLO

PART #	APPLICATION	FRONT DROP	REAR DROP	DESCRIPTION	FOOT NOTES (On Pg. 82)
6472	2WD	2"		Drop Spindles (Must use #63205 Brake Kit)	DB
63163				Adjustable Proportioning Valve	
63201				Stock Rotor Kit w/ Disc Brakes, Rotors, Calipers, Bearings, Seals, Hoses, ETC.	
63203				Non-Power Master Cylinder (Dual Reservoir)	
63205				Rotor Kit for Drop Spindles (#6769)	
63230				Booster w/ Mounting Bracket & Master Cylinder	
63231				Upper A-Frames w/ Bushings	BJ, CS
63236	Cross-Drilled	2"		13" Front Kit w/ 2" Drop Spindles (5 x 4.75")	T
63237	Smooth	2"		13" Front Kit w/ 2" Drop Spindles (5 x 4.75")	T
63242	64-68 CHEVELLE, 1969 CHEVELLE 2-DR, 67-68 OLD CUTLASS		2"	Rear Coil Springs	
63245	1964-67			Upper & Lower Rear Trailing Arms. (Keep rear-end from shifting, bolt-on, adj. pinion angle on uppers, added sway bar brace, powder coated silver)	
63246	1968-1972			Upper & Lower Rear Trailing Arms. (Keep rear-end from shifting, bolt-on, adj. pinion angle on uppers, added sway bar brace, powder coated silver)	
63250				Lower A-Frames w/ Bushings	BJ
64090				Non-Adj. Proportioning Valve w/ Lines & Bracket	



**13" Rear Disc Brake Kit (Must Use 17"+ Rims)
5 on 4.75" - Smooth (#64098)**



**13" Rear Disc Brake Kit (Must Use 17"+ Rims)
5 on 4.75" - Cross-Drilled (#64099)**



**13" Rear Disc Brake Kit - Smooth (Must Use 17"+ Rims)
6 on 5" - 12 Bolt Truck (#64300)**



**13" Rear Disc Brake Kit - Smooth (Must Use 17"+ Rims)
5 on 5" - 12 Bolt Truck (#64202)**



**13" Rear Disc Brake Kit - Cross-Drilled (Must Use 17"+ Rims)
5 on 5" - 12 Bolt Truck (#64203)**

10 OR 12 BOLT GM CAR REAR-END BRAKE KIT

PART #	APPLICATION	DESCRIPTION	FOOT NOTES (On Pg. 82)
64098	(5 x 4.75)	13" Rear Disc Brake Kit - SMOOTH	T
64099	(5 x 4.75)	13" Rear Disc Brake Kit - CROSS-DRILLED	T
64100	(5 x 5)	13" Rear Disc Brake Kit - SMOOTH	T
64101	(5 x 5)	13" Rear Disc Brake Kit - CROSS-DRILLED	T



**13" Rear Disc Brake Kit - Cross-Drilled (Must Use 17"+ Rims)
5 on 4.75" - 12 Bolt Truck (#64201)**



**13" Rear Disc Brake Kit - Cross-Drilled (Must Use 17"+ Rims)
6 on 5" - 12 Bolt Truck (#64301)**

12 BOLT GM TRUCK REAR-END BRAKE KIT

PART #	APPLICATION	DESCRIPTION	FOOT NOTES (On Pg. 82)
64200	(5 x 4.75)	13" Rear Disc Brake Kit - SMOOTH	T
64201	(5 x 4.75)	13" Rear Disc Brake Kit - CROSS-DRILLED	T
64202	(5 x 5)	13" Rear Disc Brake Kit - SMOOTH	T
64203	(5 x 5)	13" Rear Disc Brake Kit - CROSS-DRILLED	T
64300	(6 on 5)	13" Rear Disc Brake Kit - SMOOTH	T
64301	(6 on 5)	13" Rear Disc Brake Kit - CROSS-DRILLED	T



13" Rotor Front/Rear - Smooth (#63144)



13" Rotor Front/Rear - Cross-Drilled (#63146)

13" ROTOR FRONT/REAR (EACH, 1-PC) 5X4.75 & 5X5

PART #	APPLICATION	DESCRIPTION	FOOT NOTES (On Pg. 82)
63144	5 x 4.75 & 5 x 5	13" Rotor - Driver Side (Smooth)	T
63145	5 x 4.75 & 5 x 5	13" Rotor - Passenger Side (Smooth)	T
63146	5 x 4.75 & 5 x 5	13" Rotor - Driver Side (Cross-Drilled)	T
63147	5 x 4.75 & 5 x 5	13" Rotor - Passenger Side (Cross-Drilled)	T

LIFTING SHOCK APPLICATION GUIDE

MCGAUGHY'S SHOCKS FOR COMPLETE LIFT KITS:

APPLICATION	YEAR	FRONT	REAR	DESCRIPTION	
GM 1500 Truck	99-06	4WD	32350B	2950	For use w/ 7" LIFT Kit
GM 1500 Truck	07-15	2WD	STOCK	2950	For use w/ 7" LIFT Kit
GM 1500 Truck	07-15	4WD	STOCK	2950	For use w/ 7" LIFT Kit
GM 1500 SUV	01-06	4WD	2350B	2850	For use w/ 7" LIFT Kit
GM 1500 SUV	07-13	2WD	STOCK		For use w/ 7" LIFT Kit
GM 1500 SUV	07-13	4WD	STOCK		For use w/ 7" LIFT Kit
GM 2500/3500 Truck	02-10	2WD	2350	2950	For use w/ 7" LIFT Kit
GM 2500/3500 Truck	02-10	4WD	2350	2950	For use w/ 7" LIFT Kit
GM 2500/3500 Truck	11-16	2WD	2600	3250	For use w/ 7" LIFT Kit
GM 2500/3500 Truck	11-16	4WD	2600	3250	For use w/ 7" LIFT Kit
FORD F-150	09-14	4WD	FACTORY	3200	For use w/ 7" LIFT Kit
FORD F-250/F-350	05-15	4WD	9365	9320	For use w/ 6" LIFT Kit
FORD F-250/F-350	05-15	4WD	9275	9340	For use w/ 8" LIFT Kit
DODGE RAM 2500/3500	03-13	4WD	2950	2950	For use w/ 8" LIFT Kit
DODGE RAM 2500	14-16	4WD	9265	9265	For use w/ 4" LIFT Kit
DODGE RAM 2500	14-16	4WD	9265	9295	For use w/ 6" LIFT Kit
DODGE RAM 2500	14-16	4WD	9275	9275	For use w/ 8" LIFT Kit
DODGE RAM 3500	13-16	4WD	9275	9320	For use w/ 4" LIFT Kit
DODGE RAM 3500	13-16	4WD	9295	9295	For use w/ 6" LIFT Kit
DODGE RAM 3500	13-16	4WD	9295	9320	For use w/ 8" LIFT Kit

FOX SHOCK APPLICATION GUIDE (LIFTING)

APPLICATION	YEAR	FRONT	REAR	DESCRIPTION
CHEVY 1500	99-06	5500	1200	Front shocks are 7-9" Lift & Rear shocks are 4-6" Lift
FORD F-250/350	05-15	5652	5653	Front & Rear Shocks are 6"- 8" Lift
CHEVY 2500 ONLY	11-16	5967	5958	Front & Rear Shocks are 7"- 9" Lift
CHEVY 2500/3500	03-12	5023	5024	Front & Rear Shocks are 7"- 9" Lift
DODGE 2500 ONLY	02-10	5962	5958	Front & Rear Shocks are 6"- 8" Lift
DODGE 2500/3500	13-16	5023	5023	Front & Rear Shocks are 6"- 8" Lift

LOWERING SHOCK APPLICATION GUIDE

APPLICATION	YEAR	FRONT	REAR	DESCRIPTION
CHEVY FULLSIZE Car	55-57	1451	2051	Front Shocks are for a STOCK to 3" drop; REAR Shocks are STOCK length
CHEVY Truck 1/2 TON	60-72	1350	1850	Front shocks are for a STOCK to 4.5" drop; REAR shocks are for a 4-5" drop
CHEVY Truck 1/2 TON	73-87	1350	1850	Front shocks are for a 3-5" drop; REAR shocks are for a 4-6" drop
CHEVY Truck 1/2 TON	73-87	1450	1850	Front shocks are for a STOCK to 2" drop; REAR shocks are for a 4-6" drop
CHEVY Truck 1/2 TON	88-06	1451	2050	Front shocks are for a STOCK to 4" drop; REAR shocks are for a 4-6" drop Front shocks will not work on torsion FRONT end trucks
CHEVY Truck 1/2 TON	99-06	3145		Premium Front shocks are for Stock to 2" drop (Silver)
CHEVY Truck 1/2 TON	99-13		3225	Premium Rear shocks are for 4" drop only (Silver)
CHEVY Truck 1/2 TON	99-13		3205	Premium Rear shocks are for 6" & 7" drop (Silver)
TAHOE/SUBURBAN/ AVALANCHE	00-09		2050	Rear shocks are for our 3" Light Duty Coil (#33070) or a 5" Rear Drop
S-10 Truck	84-00	1451	2050	Front shocks are for a STOCK to 3" drop; REAR shocks are for a 4-6" drop
DODGE RAM	02-09	1452	2250	Rear shocks are 6" drop only
TOYOTA TUNDRA	07-14		2150	Rear shocks are for the 4" or 5" REAR drop

NEWER CAR LOWERING



Front & Rear Coils - Hardtop / Convertible
(#83000)

2010-2013 CHEVY CAMARO

PART #	APPLICATION	FRONT DROP	REAR DROP	DESCRIPTION
83000	Hardtop	1.25"	1.5"	(2) Front & (2) Rear Coils
83000	Convertible	1 3/8"	1.75"	(2) Front & (2) Rear Coils



Lowered 1.25"/1.5"



1.4" Drop Front & 1.6" Drop Rear Coils
(#84000)

2004-2013 DODGE MAGNUM, CHALLENGER, CHRYSLER 300, & CHARGER

PART #	FRONT DROP	REAR DROP	DESCRIPTION
84000	1.4"	1.6"	Lowering Front Coil Springs (pr.)



Lowered 1.4"/1.6"

TERMS AND CONDITIONS

ORDERS	TERMS	SHIPPING
<p>Orders can be placed Monday through Friday from 8am. to 4:30 pm. Pacific Standard Time. Please call (559) 226.8196 to ask installation questions and/or fax in your order to (559) 277-0457. If you are a dealer, we require that you fax in all orders, but we will gladly answer any phone questions.</p>	<p>All orders must be prepaid and we do not do COD deliveries. We unfortunately no longer ship third party shipping under any circumstances. We accept VISA, Master card, & Discover, or any debit card/check card that displays a credit card logo mentioned above. If you do not wish to use a credit card you may send a personal check, cashiers check, or money order, however, we do have to wait until the payment clears before we will ship out the order.</p>	<p>We ship UPS ground in most cases unless a faster service option is selected. If it is more economical to ship freight via a trucking company we can do that if you prefer (please request). If for some reason you were shipped a part in error or received something that seems wrong, please call us as soon as you receive your order so we can correct the problem. ALL calls must be made within 10 days of the original order. Please be sure when you receive your parts that you open and inspect all boxes and packing to be sure they are the correct parts and complete (nothing is missing).</p>

WARRANTY

McGaughy's warrants all products manufactured by them against manufacturer's defects in materials or workmanship for a period of one year from the date of original purchase. All McGaughy's spindles carry a lifetime warranty against manufacturer's defects. The warranty will not extend to any piece of merchandise or part there in, that has been improperly installed, abused, or neglected. Warranty is limited to the repair or replacement, at McGaughy's discretion, after their inspection of the defective part, once returned to McGaughy's with proof of purchase, date of purchase, and all shipping costs prepaid. Any cost of labor, freight, incidental or consequential damages are expressly excluded from this warranty. Check fit all products prior to custom painting or any form of fabrication (sanding, drilling, painting, chroming, etc.) McGaughy's will not warranty any products that were modified prior to check fitting those parts on the intended vehicle. Call for technical assistance at (559) 226-8196 prior to modification if you are having any problems with your installation.

NOTE: WE ARE NOT RESPONSIBLE FOR TYPOGRAPHICAL ERRORS.

FOOT NOTES

B	Can't use Bilstein factory shocks - the shocks are too long and the coils will fall out. Our shocks part #2050 must be used with a light duty coil (without the shock extenders) or a heavy duty factory shock must be used with our shock extenders part #33070
BJ	Our part uses your original style ball joints
BL	S10 kit works on the S-10 blazer too
BS	Kit includes new bump stops for the rear.
C	Kit includes ball joint spacers without any flipping so that 16" or larger rims can be used. You can only use these spindles on coil spring front end, 2Wd, 1/2 ton Chevy or GMC Trucks.
C2	If your Ford has a two piece drive-line, you may need a carrier bearing relocater.
CB	If your truck has a two piece drive-line, you may need a carrier bearing relocater
CS	Our A-Frames use your original cross shafts
DB	Must convert from original drum brakes to disc brakes
E	May need to re-route exhaust for more clearance
EX	Must use shock extenders with this kit.
FL	Our lowering kits will not work with factory lowered Colorado or Canyon Trucks
HD	Must use heavy duty disc brakes (1.25" Thick Rotors)
HS	Our coils are meant to be used with the factory heavy duty (3" Diameter) or auto leveling air shocks.
LD	Must use light duty disc brakes (1" Thick Rotors)

FOOT NOTES

LS	Our coils are meant to be used with the factory light duty (2" Diameter) shock or our #2050
OL	You must remove the factory over-load leaf to do this drop.
S	Must use shorter rear shocks.
SE	Our PART #33036 is recommended. They aren't required but they do make a difference in the ride quality. The shock extenders relocate the shock angle to put it back to its original angle.
SR	Deluxe kit will not work on the DODGE SRT models. The ECONOMY kit is recommended for the SRT
SW	Disc Brakes will not work with original 1957-64 14" wheels
T	Must use 17" or larger wheels in order to use the spindles. Factory 17" wheels will work with a slight modification, aftermarket cast 17" wheels likely won't work.
TR	Our part uses the original style tie-rods
WH	The kit / hanger will not work on trucks with a 5' bed (which has a welded front leaf spring hanger) or the 8' bed (long bed). Must use a kit with a leaf spring instead of a hanger.
WT	2009 Ram 1/2 ton Spindles (Part# 44001) increases front wheel track by 3/8" per side
V8	The coil springs were engineered for a truck with a V-8 Engine. If coils are installed on a 6-cyl. truck then the full drop will not be achieved and the rear will sit lower than the front.
XL	Our kit will not work on the "XL" version

MIKE MCGAUGHY'S CLASSIC CHEVY CAR PARTS, INC.
"MCGAUGHY'S SUSPENSION"
5680 W. BARSTOW, FRESNO CA 93722
WWW.MCGAUGHYS.COM
PH: 559.226.8196 FX: 559.277.0457



#MCGAUGHYS



Follow us on Facebook