

## Research Article

### Design and Implementation of CUK Converter

P. Manisankar, N. Sathish Kumar, N. Vimal Bharathi, G. Balasubramanian

Department of Electrical and Electronics Engineering, Arasu Engineering College,  
Kumbakonam – 612 501. India.

Corresponding author's e-mail: [bala.coolmce@gmail.com](mailto:bala.coolmce@gmail.com)

#### Abstract

In this paper presents, design and implementation of CUK converter. The CUK converter topology has often been modified for more functions or better performances. As for performances, the research on the CUK converters is concentrated on lowering switching or conduction loss, reducing component sizes, improving system efficiency, mitigating voltage or current stress, speeding up transient responses, etc. The operation of CUK converter is quite different from operation of PWM converters. The principle motivation behind the development of the CUK converter has been their ability to provide unity power factor at constant duty cycle and reduced switching losses. It has many advantages like easy implementation of the transformer isolation, protection against high inrush current, low current ripple and also less Electromagnetic Interference (EMI). The controller effectiveness is validated by simulating the CUK converter in simpower systems toolbox of MATLAB/SIMULINK.

**Keywords:** DC-DC CUK Converter; Pulse Width Modulation; Total Harmonic Distortion; MATLAB/SIMULINK.

#### Introduction

The CUK converter is a type of DC-DC converter that has an output voltage eminence that is either exceeding or fewer than the input voltage magnitude. It has the capability for both step down and step up operation. This converter consistently works in the continuous conduction mode. The CUK converters capable of operating in either step-up or step-down mode are mainly applied to dc power supplies [1]. CUK converter is also employed in a variety of applications including power supplies for personal computers; space-craft power system, lap-top computers, and telecommunication equipments. The operation of CUK converters is quite different from the operation of PWM converter. The principle motivation behind the development of the CUK converters has been their ability to provide reduced switching losses.

A CUK converter proposed for analyzing the performance of photovoltaic system is only for smooth operation for dc output. In the proposed CUK converter, the conduction losses and switching losses are reduced. The switching techniques are to provide smooth transition of voltage and current at input and output [2]. The PV powered CUK converter connected to the

load. The MPPT Technique used in this study for standalone PV generation system. The diode will reduce the ripple of the solar voltage. The PV array output is adjusted by the CUK converter. The PV array is connected to the CUK converter and the maximum voltage is obtained by varying the duty cycle of the MOSFET switch [3]. They have the demerits of poor power quality in terms of injected current harmonics, caused voltage distortion and poor power factor at input ac mains and slow varying rippled dc output at load end, low efficiency and large size of ac and dc filters. In light of their increased applications, a new breed of rectifiers has been developed self commutating devices [4].

The small signal models of CUK converter and other converters deal with h parameter for buck converter and g parameter for a boost converter [5]. As fuel cell technology continues to improve, much attention is being focused on developing power electronics to convert the variable DC output voltage of the fuel cell to a form compatible with various loads [6]. The buck-boost converter was rejected for the same reason. The CUK converter is capable of stepping down the voltage and its input inductor

would smooth out the current drawn from the fuel cell. The basic CUK converter provides a voltage inversion [7]. CUK converter, based on the buck-boost converter has the advantage of low ripple in input and output currents. An addition of a transformer can eliminate the ripple in the input and output currents, and also give an output voltage with the same polarity as the input [8.9]. The CUK converter can also provide a smooth output-current characteristic due to the presence of an inductor in the output stage. Thus, the CUK configuration is a most suitable converter to be employed in designing the MPPT [10]. The CUK converter has both continuous input and output currents of the converter, the CUK converter seems to be a potential candidate in basic converter topologies [11]. In this paper presents, design and implementation of CUK converter. The CUK converter topology has often been modified for more functions or better performances. As for performances, the research on the CUK converters is concentrated on lowering switching or conduction loss, reducing component sizes, improving system efficiency, mitigating voltage or current stress, speeding up transient responses, etc. The operation of CUK converter is quite different from operation of PWM converters. The principle motivation behind the development of the CUK converter has been their ability to provide unity power factor at constant duty cycle and reduced switching losses.

**Proposed System**

The CUK converter is a step-down/step-up converter based on a switching boost-buck topology. Essentially, the converter is composed of two sections, an input stage and an output stage. The input voltage is fed into the circuit via inductor  $L_1$ . When the switch is on, current  $I_1$  builds the magnetic field of the inductor in the input stage. The diode is reverse biased, and energy dissipates from the storage elements in the output stage. When the switch turns off, inductor  $L_1$  tries to maintain the current flowing through it by reversing polarity and sourcing current as its magnetic field collapses. It thus provides energy to the output stage of the circuit via capacitor  $C_0$ . The inductor currents are the input and output currents, therefore, if the principle of conservation of energy is applied [12].

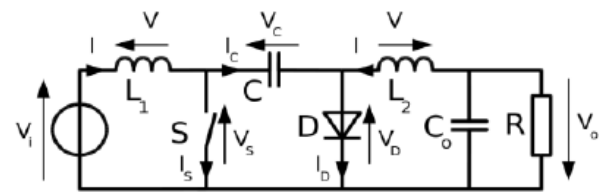

Fig. 1. Circuit Diagram of CUK Converter

The voltage ratio of a CUK converter is the same as that of a buck-boost converter, but its main advantage over other converters is that the input and output inductors result in a filtered current on both sides of the converter, while buck, boost, and buck-boost converters have a pulsating current that occurs on at least one side of the circuit i.e either on input side or output side. This pulsation will increase the ripple in the circuit and due to this ripple, the efficiency of battery gets lowered. To ensure good efficiency ripple should be reduced. By controlling the duty cycle of the switch, the output voltage  $V_o$  can be controlled and can be higher or lower than the input voltage  $V_{in}$  (Fig. 1). By using a controller to vary the duty cycle during operation, the circuit can also be made to reject disturbances ,as second part of circuit consists of parallel resonance circuit and it work as a tank circuit for specific frequency (resonant frequency) , and during resonance current will not be allowed to enter in the circuit.

Table 1. Parameters

S.No	Specifications	Value
1.	Input Voltage ( $V_i$ )	100 V
2.	Output Voltage ( $V_o$ )	-177 V
3.	Output Current ( $I_o$ )	$-1.773e^{-4}$ A
4.	Output Power ( $P_o$ )	0.03144 W
5.	Switching Frequency	50 kHz
6.	Load Resistance (R)	$1e^6 \Omega$
7.	Inductance 1 ( $L_1$ )	$10e^{-3}$ H
8.	Inductance 2 ( $L_2$ )	$0.01e^{-3}$ H
9.	Capacitance 1 (C)	$50e^{-6}$ F
10.	Capacitance 2 ( $C_o$ )	$550e^{-3}$ F

**Simulation Results**

The simulation is performed of CUK converter in matlab/Simulink for investing open loop operation (Fig. 2). Input Voltage of CUK converter, Output voltage of CUK converter, Output current of CUK converter, Output power of CUK converter and load respectively. The

output is presented in table and figures. From the simulink, its figure out that due to the 100 V as input and output voltage of -177 V. The duty cycle is deviated and compatible voltage and

current is analyzed in the CUK converter. It is observed that the operation of CUK converter is better as compare to converter.

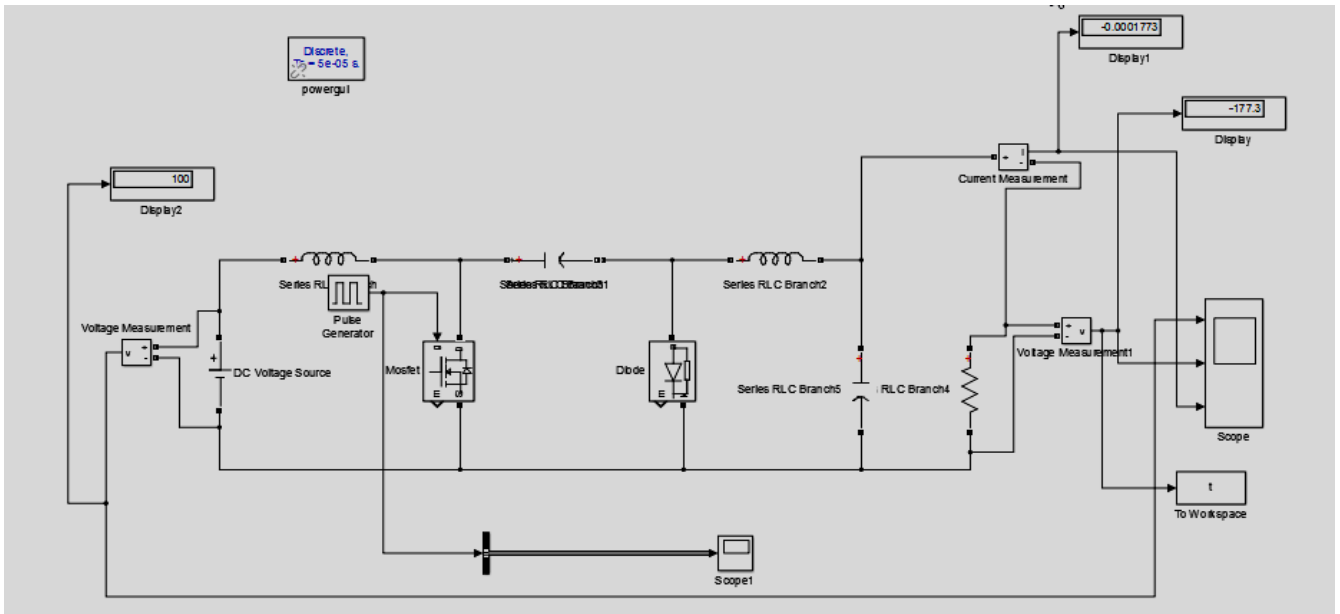

Fig. 2. Simulation diagram of CUK converter

The input voltage of CUK converter is 100 V is done by MATLAB simulation (Fig. 3). The output voltage of CUK converter is -177 V is done by MATLAB simulation (Fig. 4). The output power of CUK converter is 0.03144 W is done by MATLAB simulation (Fig. 5-7). The total harmonic distortion of CUK converter is 58.74 % is done by MATLAB simulation (Fig. 8).

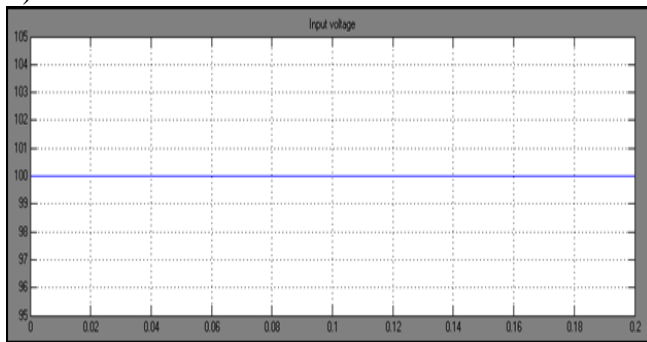

Fig .3. Input Voltage

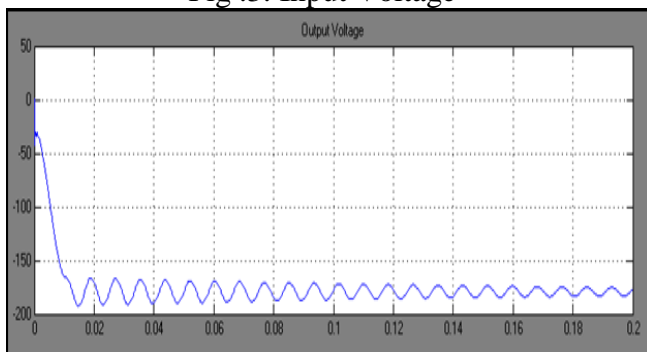

Fig .4. Output Voltage

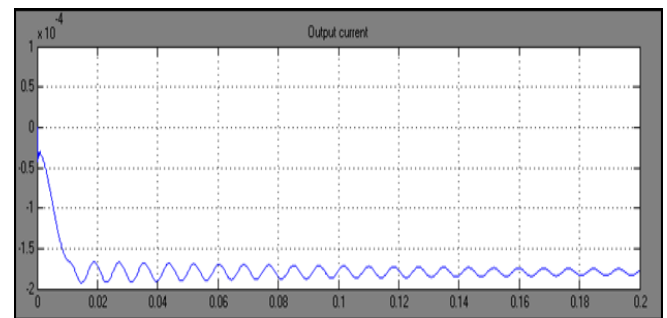

Fig. 5. Output Current

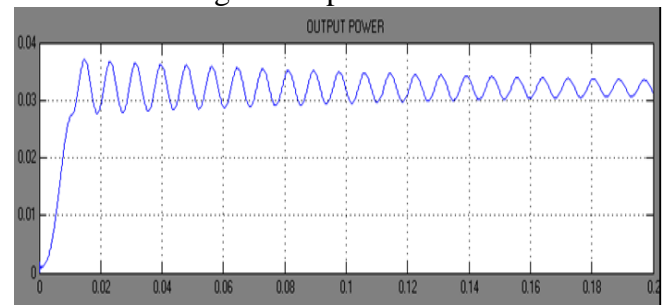

Fig. 6. Output Power

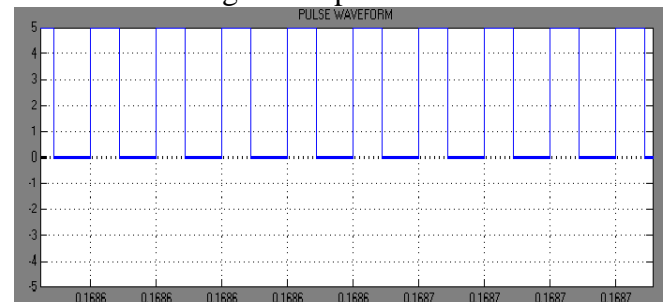

Fig.7. Pulse waveform

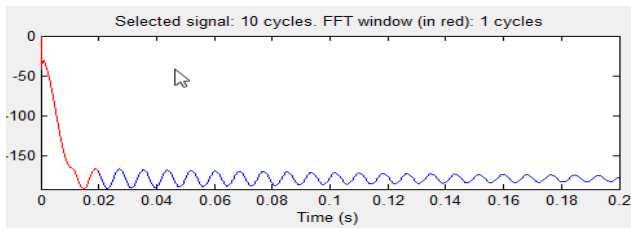

Fig. 8(a). Total Harmonic Distortion (THD)

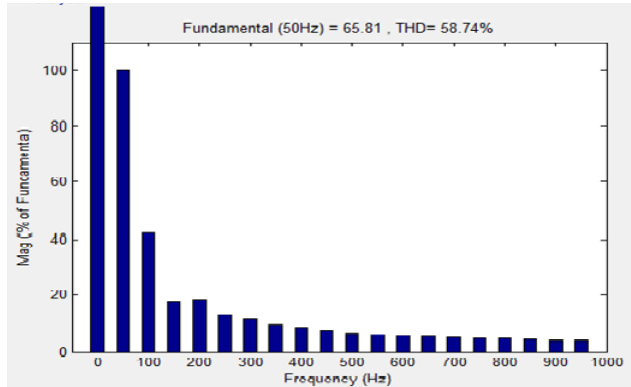

Fig. 8(b) Total Harmonic Distortion (THD)

## Conclusions

The controller design was validated for CUK converter in SimPower Systems R - toolbox of Matlab/Simulink. It was seen that the performance of the controller is quite satisfactory. The results obtained show the effectiveness of the proposed controller and emphasizes its use in switched mode power electronic converter applications with high efficiencies and reduced the Total Harmonic Distortion (THD) value. The CUK converter operation including input voltage variations, reference voltage variation, load resistance variations, noisy parameters and noisy input voltage. The result obtained show the effectiveness of the proposed controller and it will be used for switched mode power electronics converter applications with high efficiencies and very simple control scheme is implemented to achieve the required output. Implementation of the proposed controller with many existing non liner controllers for controlling a CUK converter.

## Conflict of interest

Authors declare there are no conflicts of interest.

## References

[1] Chen Z. PI and sliding mode control of a cuk converter. IEEE Transaction

Transactions on Power Electronics. 2012;27:3695-3703.

- [2] Patel C, Prajapati HN. Design of DC-DC converter based on cuk topology for PV system. International Journal of Conceptions on Electrical and Electronics Engineering. 2014;2(1):33-36.
- [3] Sriranjani R, ShreeBharathi A, Jayalalitha S. Design of cuk converter powered by PV Array. Research Journal of Applied Sciences, Engineering and Technology. 2013;6:793-796.
- [4] Singh S, Singh B. A voltage-controlled pfc cuk converter-based PMBLDCM drive for air conditioners Industry Applications. IEEE Transactions IEEE Transactions on Industry Applications. 2012;48:832-838.
- [5] TF, Chen YK. Modeling PWM DC/DC converters out of basic converter units. IEEE Trans Power Electron. 1998;13:870-881.
- [6] Lesster LE. Fuel cell power electronics, managing a variable-voltage DC source in a fixed-voltage AC. World Fuel cells Bulletin 2009;3:5-9.
- [7] Erickson RW, Maksimovic D. Fundamentals of Power Electronics. Kluwer Academic Publishers, 2001.
- [8] Cuk S. Switching DC-to-DC converter with zero input or output current ripple in proceedings of IEEE Industry Applications conference, 1978. pp.1131-1145.
- [9] Cuk S. A new zero-ripple switching DC-DC converter and integrated magnetics. IEEE Transactions on Magnetics. 1983;19:57-75.
- [10] Mrutyunjay D, Panigrahi CK, Moharana MK. Improvement of the performance of PV system with cuk converter by mppt Technology. International Journal of Computer Applications. 2015;127:33-26.
- [11] Fardoun AA, Ismail EH, Sabzali AJ, Al-Saffar MA. New efficient bridgeless cuk rectifiers for PFC applications Power Electronics. IEEE Transactions on Power Electronics. 2012;27:3292-3301.
- [12] Simonetti DSL, Sebastian J, Uceda J. The discontinuous conduction mode sepic and cuk power factor pre regulators: Analysis and Design. IEEE Transactions on Industrial Electronics 1997;44:630-637.

\*\*\*\*\*