

Canada Patent #2,548,325 (307 claims) 3-13-2012

Low Drag Ship Hull

By Thomas G. Lang and James T. Lang

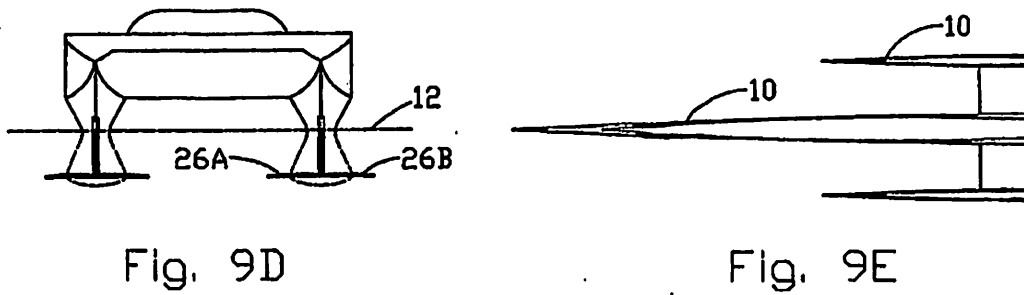

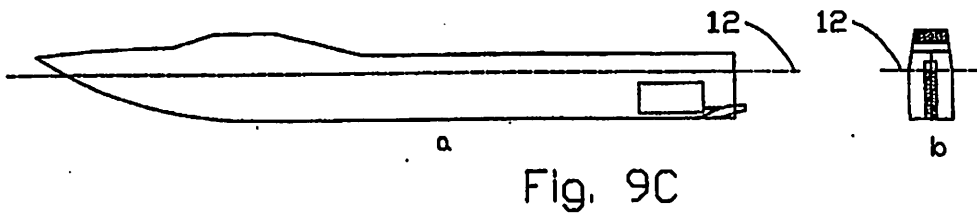
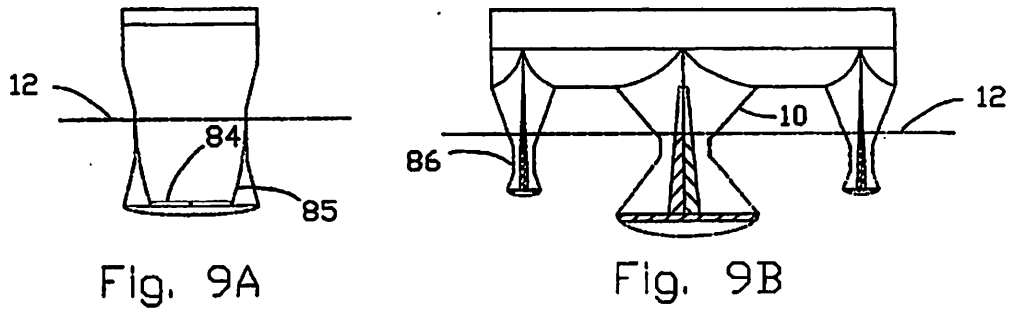
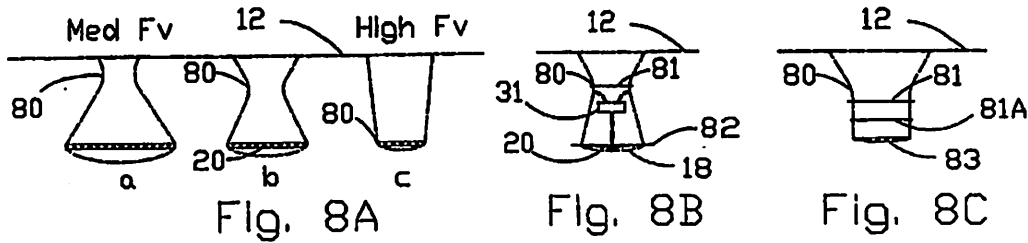
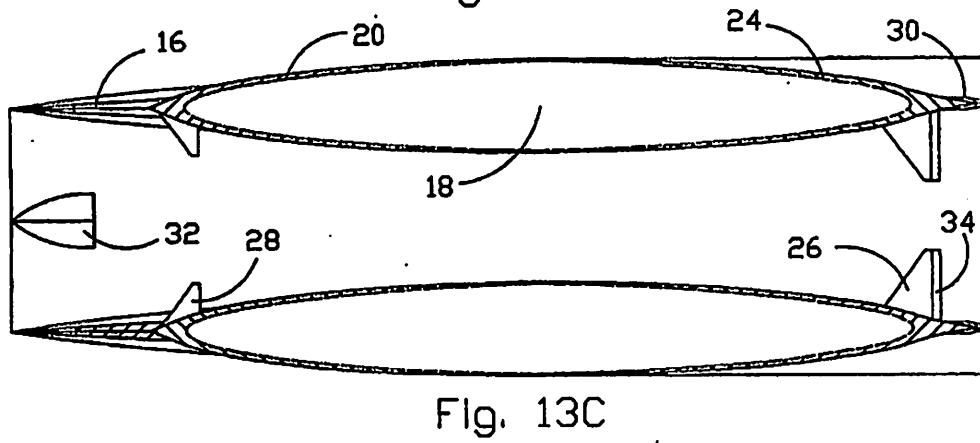
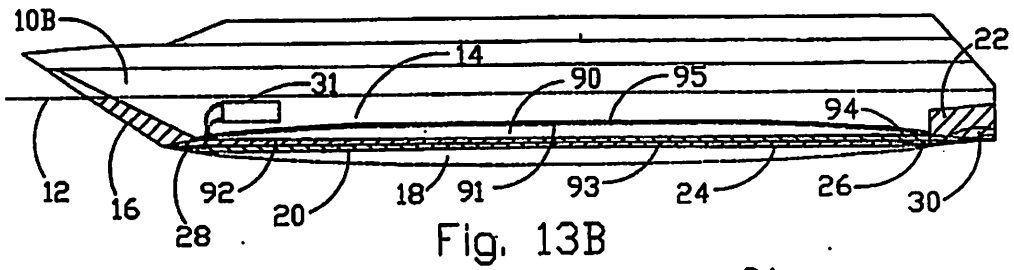
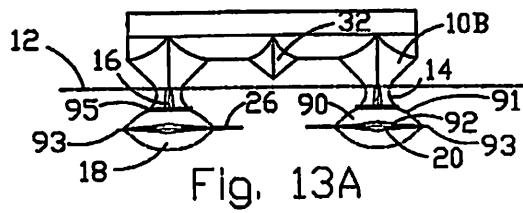
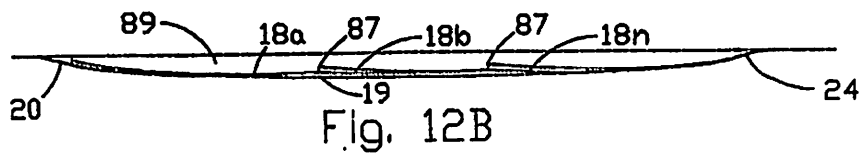
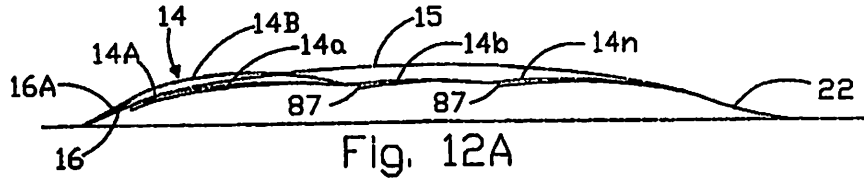

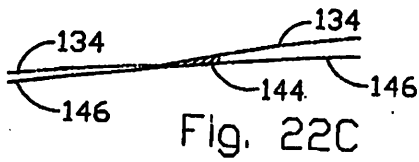
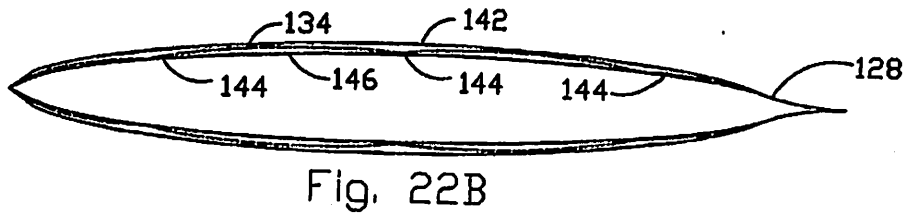
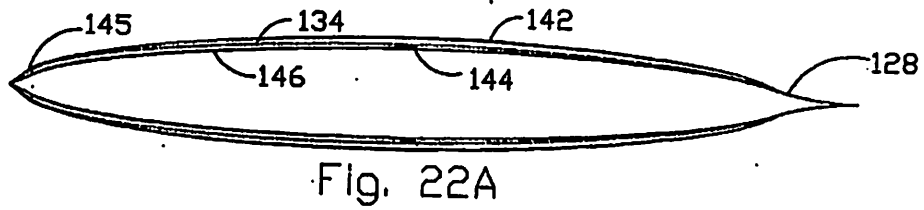
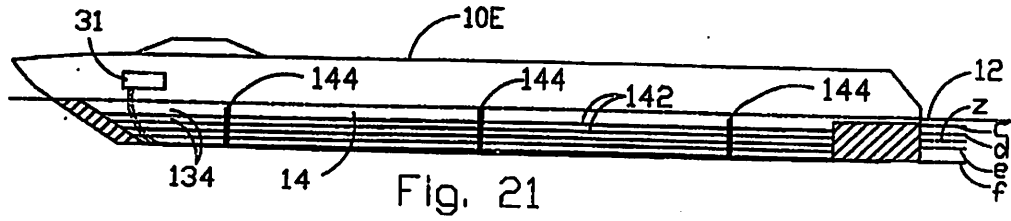
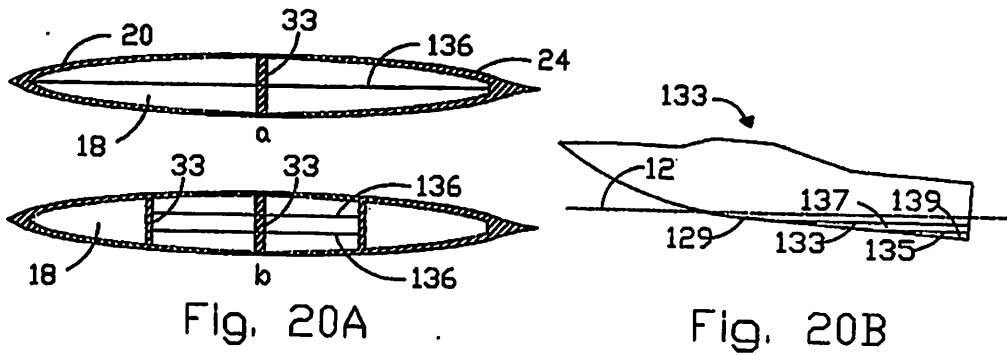

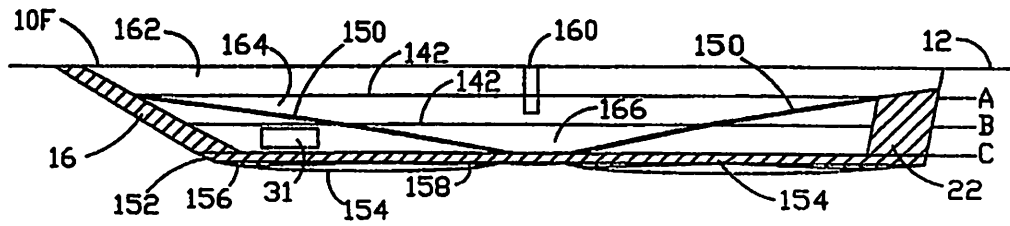

Fig. 23

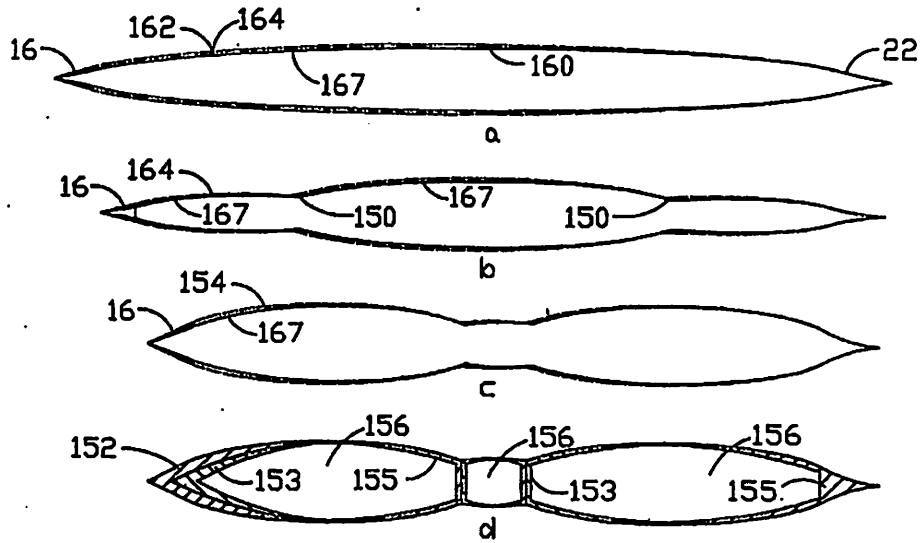

Fig. 24

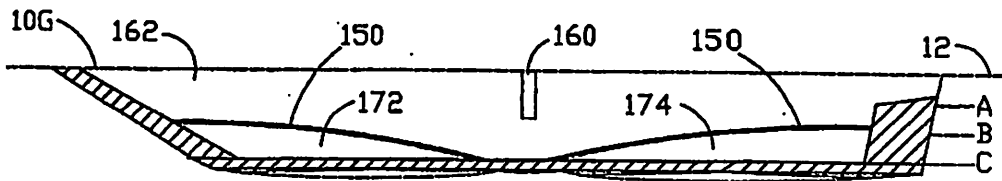

Fig. 25

