

# HOWARD

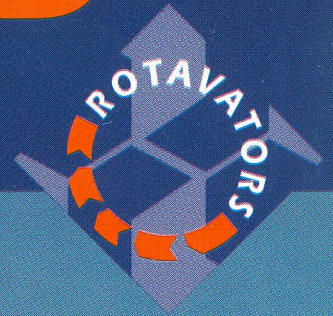

Power range:  
70 to 105 HP.

Side drive gears.

Working width:  
1'80 to 2'50 m.

Modular construction,  
many options to choose.

- HR31 1 speed.
- HR36 4 speeds.

## Rotavators HR31 - HR36



# Rotavators HR31 - HR36

## APPLICATIONS

Reinforced Rotavators for tractors up to 105 HP.

Suitable for crops such as:

- potato
- corn
- cotton
- vegetables

It's modular construction allows to fit it with many optional equipment as wheels, rollers or springs for trailing board, to adapt it to different conditions or applications.

Rotor with "L" blades (3900/01) for a working depth between 5 to 25 cm.

Top mast prepared for combination with seed drills.



HR31-230 with wheels for depth control instead of skids.

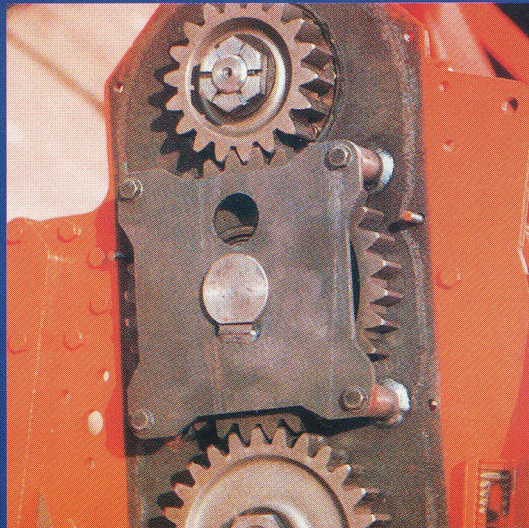

Strong side drive gears. The center gear is fitted with double plate. Totally reliable.



"Selectalith" gearbox (H

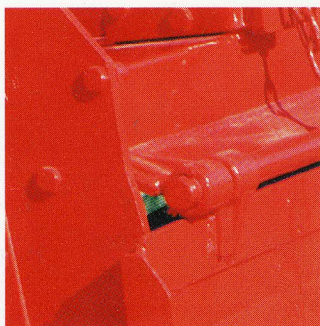

Strong forged hinges for the trailing board.

Rotor flanges welded for each side. Bolt and nut for the blades in 12,9 Kg/mm<sup>2</sup> steel.

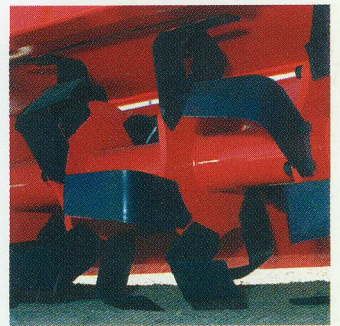



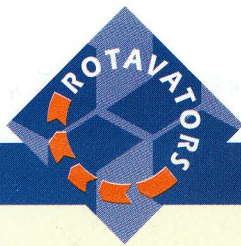

**1** Double plate. Avoids deformations where the mechanical elements are fitted.

**2** Front chassis integrated in the hull.

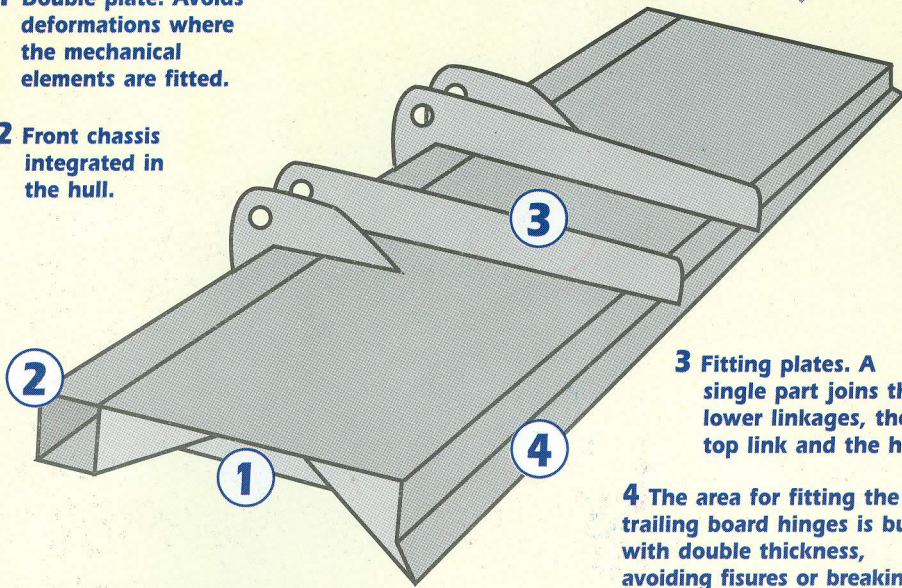

**3** Fitting plates. A single part joins the lower linkages, the top link and the hull.

**4** The area for fitting the trailing board hinges is built with double thickness, avoiding fissures or breakings.

**DOUBLE BLOCK HULL.**

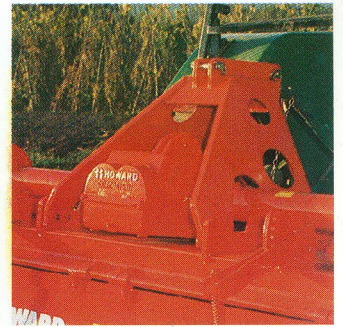

**Strong top-mast. Allows combination with seed-drill.**

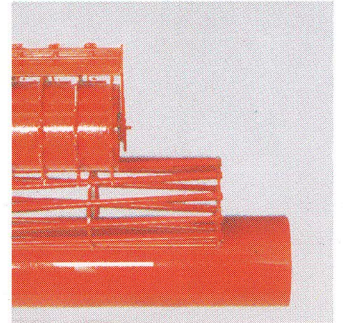

**Optional rollers: cage, packer or toothed packer.**



(HR36) with 4 speeds.

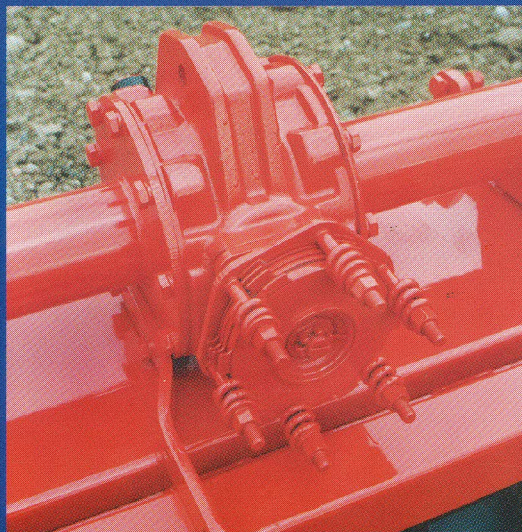

**Single speed gearbox (HR31) for 200 rpm. rotor speed. Original Howard clutch with sintered metallic discs.**



**Wheels instead of skids for depth control.**



**Springs for trailing board (optional).**

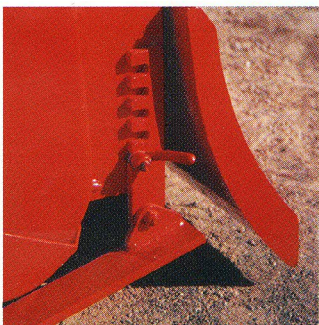

**Adjustable depth control skid.**

**Depth control for wheels or roller, by means of a pin.**

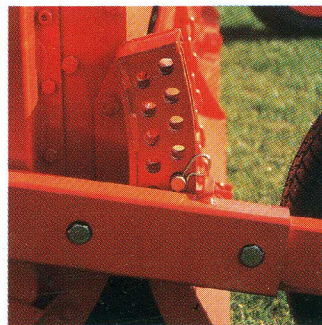



# Rotavators HR31 - HR36

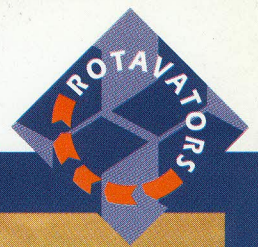

## Standard Equipment

Universal joint at  
540 rpm.

Linkage cat. II.

Side drive gears.

Rotor with blades tipe  
3900/3901.

Adjustable depth  
control skids.

Double tube.

Clutch with sintered  
metallic discs.

HR 31: single speed.

HR 36: four speeds.



HR36 - 250 with cage roller + NS-3025 seed drill.

## Options

Springs for trailing board.

Wheels.

Rollers.

Side tine.

Rotor with double flange.

Rotor with "S" blade and  
double flange.

Quick coupling.

Model	Working width	Number of blades	Overall width	Rotor speed	WT in Lbs	HP
HR31 - 180	72	42	81,5	1	1331	70-85
HR31 - 195	78	45	85,5	1	1386	70-90
HR31 - 205	82	48	91,5	1	1430	70-90
HR31 - 215	86	51	95,5	1	1475	80-95
HR31 - 230	92	54	101,5	1	1530	85-100
HR31 - 250	100	60	112,0	1	1628	85-105

HR36 - 180	72	42	81,5	4	1375	70-85
HR36 - 195	78	45	85,5	4	1425	70-90
HR36 - 205	82	48	91,5	4	1475	75-90
HR36 - 215	86	51	95,5	4	1524	80-95
HR36 - 230	92	54	101,5	4	1573	80-100
HR36 - 250	100	60	112,0	4	1672	85-105



HOWARD ROTAVATOR, S.A.

HOWARD, is committed to constantly improving its products and may modify the characteristics and measures stated herein without prior warning.

P.O. Box 246  
08400 GRANOLLERS - Barcelona - (Spain)  
Phone (93) 849 26 22 - 849 28 78 - 849 23 43  
Fax (93) 849 35 77

Importer / Dealer: