



SPLIT TYPE AIR CONDITIONER INSTRUCTION MANUAL

IWSH12A (IWSHN12A & IWSHO12A)

IWSH18B (IWSHN18B & IWSHO18B)

IWSH24B (IWSHN24B & IWSHO24B)

Important: This user manual contains valuable information in regards to the installation and use of the air conditioner. Please comply with these instructions to obtain the best results for the air conditioner.

CONTENTS

SAFETY PRECAUTIONS	1
NAMES OF PARTS	4
INDOOR UNIT DISPLAY	5
EMERGENCY FUNCTION & AUTO-RESTART FUNCTION	6
REMOTE CONTROLLER	7
OPERATING INSTRUCTIONS	11
PROTECTION	18
INSTALLATION MANUAL.....	19
MAINTENANCE	28
TROUBLESHOOTING	29

In line with the company's policy of continual product improvement, the aesthetic and dimensional characteristics, technical data and accessories of this appliance may be changed without notice.

SAFETY RULES AND RECOMMENDATIONS FOR THE INSTALLER

⚠ **R**ead this user manual before installing and using the air conditioner.

⚠ **D**uring the installation of the indoor and outdoor unit, please keep children away from the work area as unforeseeable accidents may occur.

⚠ **M**ake sure that the base of the outdoor unit is firmly fixed.

⚠ **A**fter installation or relocating the air conditioner, test for refrigerant leaks. There should not be any air entering the system or refrigerant leaks.

⚠ **C**arry out a test cycle after installing the air conditioner and record the operating data.

⚠ **T**he ratings of the fuse installed in the indoor unit are T 5A / 250V .

⚠ **E**nsure that the mains voltage corresponds to the specifications on the rating plate. Keep the switch or power plug clean. Insert the power plug correctly and firmly into the socket, thereby avoiding the risk of electric shock or fire due to insufficient contact.

⚠ **T**he air conditioner power supply must be hardwired from a properly sized circuit breaker. Make sure to size the circuit breaker properly against the unit specifications provided on the ratings plate or the product catalog.

⚠ **T**he air conditioner must be installed by professional or qualified technician (licensed).

⚠ **F**lammable substances and pressurized cans should not be placed within 20 inches of the air conditioner (Indoor/Outdoor).

⚠ **I**f the air conditioner is used in areas without the possibility of ventilation, precautions must be taken to prevent any leaks of refrigerant gas from remaining in the environment and creating a fire hazard.

⚠ **T**he packaging materials are recyclable and should be disposed of properly. Take the air conditioner at the end of its useful life to a special waste collection center for disposal.

⚠ **O**nly use the air conditioner as instructed in this booklet. These instructions are not intended to cover every possible condition and situation. As with any electrical household appliance, common sense and caution are therefore always recommended for installation, operation and maintenance.

⚠ **T**he air conditioner must be installed in accordance with applicable national regulations.

⚠ **B**efore accessing the terminals, all the power circuits must be disconnected from the power supply.

⚠ **T**he appliance shall be installed in accordance with national wiring regulations.

⚠ **T**his air conditioner can be used by children aged from 8 years and above and persons with reduced physical, sensory or mental capabilities or lack of experience and knowledge if they have been given supervision or instruction concerning use of the air conditioner in a safe way and understand the hazards involved. Children shall not play with the air conditioner. Cleaning and user maintenance shall not be performed by children without supervision.

SAFETY RULES AND RECOMMENDATIONS FOR THE USER

⚠ Do not try installing the air conditioner without a qualified technician. Always contact a technician to install/repair and maintain the air conditioner.

⚠ Before carrying out any cleaning or maintenance, make sure to disconnect the power source.

⚠ Ensure that the mains voltage corresponds to the specification on the rating plate. Keep the switch or power plug clean. Insert the power plug correctly and firmly into the socket, thereby avoiding the risk of electric shock or fire due to insufficient contact.

⚠ This air conditioner has been made for air conditioning domestic environments and must not be used for any other purpose, such as for drying clothes, cooling food and etc.

⚠ The packaging materials are recyclable and should be disposed of properly. Take the air conditioner, at the end of its useful life, to a special waste collection center for disposal.

⚠ Always use the air conditioner with the air filter mounted. The use of the conditioner without air filter could cause an excessive accumulation of dust or waste on the inner parts of the device leading to subsequent failures.

⚠ The user is responsible for having the air conditioner installed by a qualified technician, who must check that it is earthed in accordance with current legislation and insert a thermomagnetic circuit breaker.

⚠ The batteries in the remote controller must be recycled or disposed of properly. Disposal of Scrap Batteries --- Please discard the batteries at local waste centers or designated collection sites.

⚠ Never remain directly exposed to the flow of cold air for a long time. The direct and prolonged exposure to cold air could potentially be harmful to your health. Particular care should be taken in the rooms where there are children, old or sick people.

⚠ If any smoke or smell of smoke is detected from the air conditioner, immediately cut off the power supply and contact a qualified technician or the manufacturer.

⚠ The prolonged use of the device in such conditions could cause fire or electrocution.

⚠ Repairs should only be carried out by qualified technicians. Incorrect repair could expose the user to the risk of electric shock and shortened life span of the air conditioner.

⚠ The airflow direction of the indoor unit must be properly adjusted.

⚠ The flaps must be directed downwards in the heating mode and upwards in the cooling mode.

⚠ Only use the air conditioner as instructed in this booklet. These instructions are not intended to cover every possible condition and situation. As with any electrical household appliance, common sense and caution are therefore always recommended for installation, operation and maintenance.

⚠ Ensure that the air conditioner is disconnected from the power supply when it will remain inoperative for a long period and before carrying out any cleaning or maintenance.

⚠ Selecting the most suitable temperature can prevent damage to the appliance, and minimize energy consumption.

SAFETY RULES AND PROHIBITIONS

- ⊖ Do not bend , tug or compress the power cord since this could damage it. Electrical shocks or fire are probably due to a damaged power cord. Damaged power cords must be replaced by qualified technicians.
 - ⊖ Do not use extensions or gang modules.
 - ⊖ Do not touch the appliance when barefoot or parts of the body are wet or damp.
 - ⊖ Do not obstruct the air inlet or outlet of the indoor or the outdoor unit.
The obstruction of these openings cause a reduction in the operative efficiency of the conditioner with possible consequential failures or damages.
 - ⊖ In no way alter the characteristics of the air conditioner.
 - ⊖ Do not install the air conditioner in environments where the air could contain gas , oil , sulphur , near sources of heat.
 - ⊖ This appliance is not intended for use by persons (including children) with reduced physical, sensory or mental capabilities, or lack of experience and knowledge, unless they have been given supervision or instruction concerning use of the air conditioner by a person responsible for their safety.
- ⊖ Do not climb onto or place any heavy or hot objects on top of the appliance.
 - ⊖ Do not leave windows or doors open for long when the air conditioner is operating.
 - ⊖ Do not direct the airflow onto plants or animals.
 - ⊖ Prolonged exposure to the flow of cold air of the conditioner could have negative effects on plants and animals.
 - ⊖ Do not put the conditioner in contact with water.
The electrical insulation could be damaged and thus causing electrocution.
 - ⊖ Do not climb onto or place any objects on the outdoor unit
 - ⊖ Never insert a stick or similar object into the appliance. It could cause injury.
 - ⊖ Children should be supervised to ensure that they do not play with the air conditioner. If the supply cord is damaged, it must be replaced by the manufacturer, its service agent or similarly qualified technicians in order to avoid potential hazard.

NAMES OF PARTS

INDOOR UNIT

No.	Description
1	Front panel
2	Air filter
3	Optional filter (if installed)
4	LED Display
5	Signal receiver
6	Terminal block cover
7	Ionizer generator(if installed)
8	Deflectors
9	Emergency button
10	Indoor unit rating label (Stick position optional)
11	Airflow direction louver
12	Remote controller

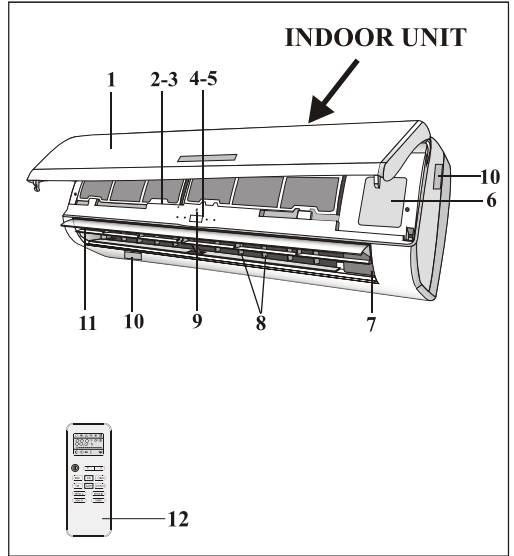

OUTDOOR UNIT



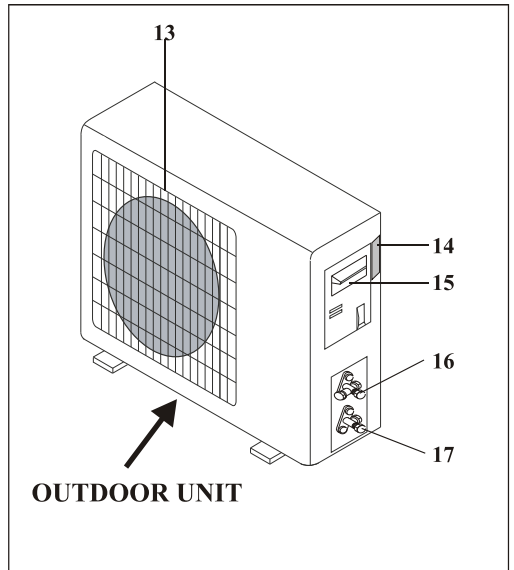

No.	Description
13	Air outlet grille
14	Outdoor unit rating label
15	Terminal block cover
16	gas valve
17	liquid valve



Note: the above figures are only intended to be a simple diagram of the appliance and may not correspond to the appearance of the units that have been purchased.

INDOOR UNIT DISPLAY



No.	Led		Function
1	POWER		This symbol appears when the unit is power on
2	SLEEP		SLEEP mode
3	Temperature display (if present) /Error code	26	(1) Displays room temperature and set temperature. (2) Lights up during Timer operation when the air conditioner is operational (3) Displays the malfunction code when fault occurs.
4	TIMER		Lights up during Timer operation.
5	RUN		The symbol appears when the unit is turned on, and disappear when the unit is turned off.

 The shape and position of switches and indicators may be different according to the model, but their function is the same.

EMERGENCY FUNCTION & AUTO-RESTART FUNCTION

AUTO-RESTART FUNCTION

The auto restart function is preset by the manufacturer. In case of a sudden power failure, the module memorizes the setting conditions before the power failure. when the power restores, the unit restarts automatically with all the previous settings preserved by the memory function.

To deactivate the AUTO-RESTART function ,proceed as follows:

1. Switch the air conditioner off and disconnect the circuit breaker.
 2. Press and hold the emergency button. While holding the emergency button, reconnect the circuit breaker.
 3. Keep pressing the emergency button for more than 10 seconds until you hear four short beeps from the unit. The AUTO-RESTART function has been deactivated.
- To activate the AUTO - RESTART function , follow the same procedure until you hear three short beeps from the unit.

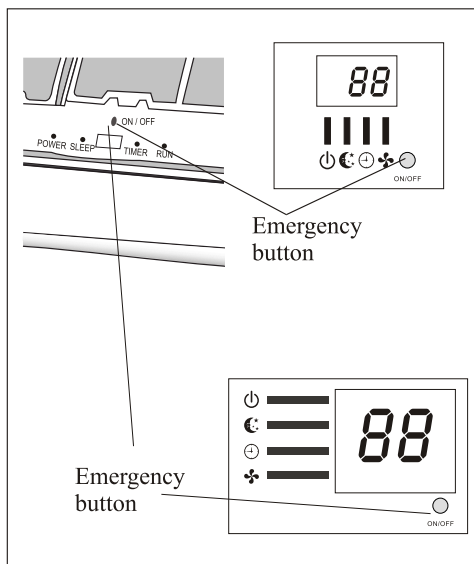

EMERGENCY FUNCTION

If the remote controller fails to work or maintenance is necessary, proceed as follows:

Open and lift the front panel up to an angle to reach the emergency button.

1. One press of the emergency button(one beep) will lead to the forced COOLING operation
2. Two press of the emergency button within 3 sec (two beeps) will lead to the forced HEATING operation.
3. To switch off the unit , you just need to press the button again (a single long beep) .
4. After 30 minutes in forced operation , the air conditioner will automatically start working in 23°C cooling mode, auto fan speed.

* The FEEL function is described in page 15.

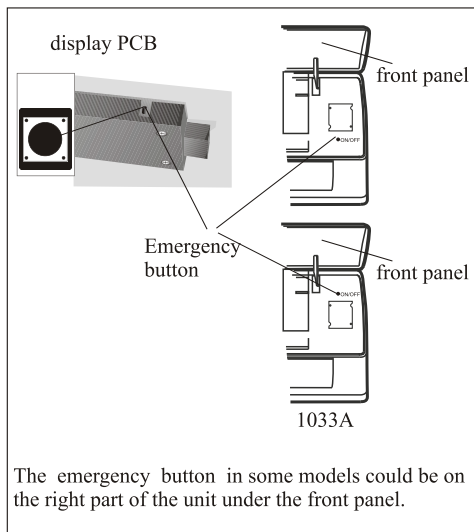

The emergency button in some models could be on the right part of the unit under the front panel.

⚠ The shape and position of the emergency button may be different according to the model, but their function is the same.

Remark: the external static pressure of heat pumps is 0 Pa for all models.

REMOTE CONTROLLER

No.	Button	Function
1	▲ (TEMP UP)	Press it to increase temperature / time setting.
2	▼ (TEMP DN)	Press it to decrease temperature/ time setting.
3	ON/OFF	Press it to start or stop operation.
4	FAN	To select the fan speed of auto/low/mid/high
5	TIMER	Press it to set auto-off timer.
6	SLEEP	To activate the function "SLEEP"
7	ECO	In cooling mode,press this button ,the temperature will increase 3.6°F on the base of setting temperature In heating mode, press this button, the temperature will decrease 3.6°F on the base of setting temperature
8	MODE	To select the mode of operation
9	SUPER or TURBO	Press this button to activate / deactivate the Super function which enables the unit to reach the preset temperature in the shortest time. In COOL mode, the unit will give the maximum cooling temperature with 61°F ,high fan speed. In HEAT mode, the unit will give the maximum heating temperature with 88°F ,high fan speed.
10	SWING	To activate or deactivate of the movement of the deflectors.
11	CLOCK	When you press this button,the time will be flickering;then through"▲"and "▼ ",you can adjust the time(press the button one time to change the time by one minute. Press and hold the button to rapidly change the time.), after adjusting to your required time, please press this button again to fix the time.
12	DISPLAY	To switch on/off the LED display
13	HEALTHY	To switch - on /off HEALTHY funtion.It is a button which controls the ionizer or plasma genera for available model only.
14	3D	When you press "3D", the horizontal and vertical vanes will swing together at the same time.
15	RESET	To restart REMOTE CONTROLLER
16	ANTI-MILDEW or Mute	To activate the function ANTI-MILDEW or To activate the function of Mute

⚠ The design and some function of remote controller may be different.

⚠ The shape, position of buttons and indicators may be different according to the model, but their function is the same.

⚠ The unit confirms the correct reception of each press button with a beep.

REMOTE CONTROLLER

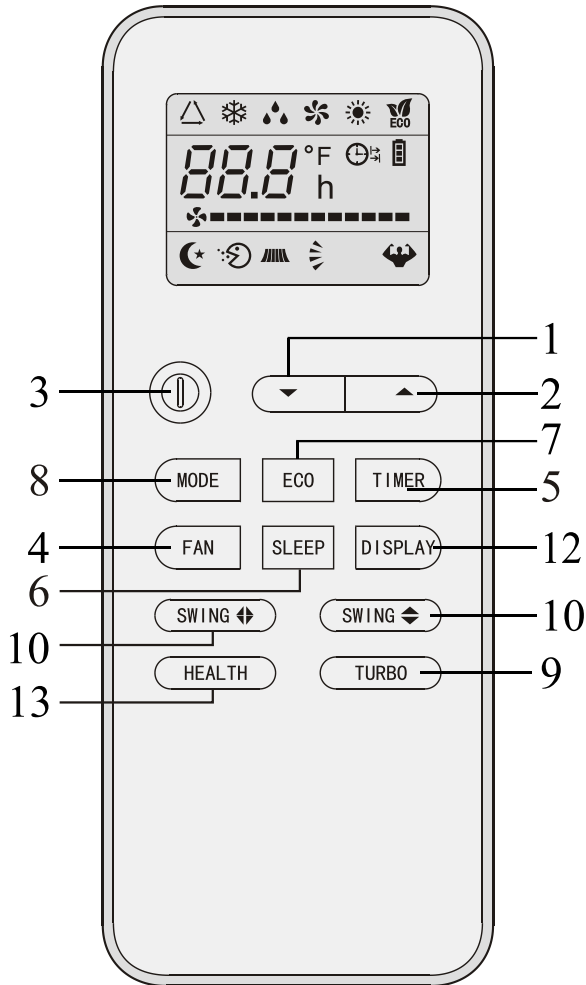















 The design and some function of remote controller may be different.

 The shape, position of buttons and indicators may be different according to the model, but their function is the same.

REMOTE CONTROLLER

Remote controller DISPLAY

Meaning of symbols on the liquid crystal display

No.	Symbols	Meaning
1		FEEL mode indicator
2		COOLING indicator
3		DEHUMIDIFYING indicator
4		FAN ONLY OPERATION indicator
5		HEATING indicator(For cooling only type, fanning function is activated.)
6		ECO indicator
7		CLOCK indicator
8		TIMER ON & TIMER OFF indicator
9		BATTERY indicator
10		LOW/MIDDLE/HIGH FAN SPEED indicator
11		SLEEP indicator
12		HEALTHY indicator
13		FLAP SWING indicator
14		TURBO indicator

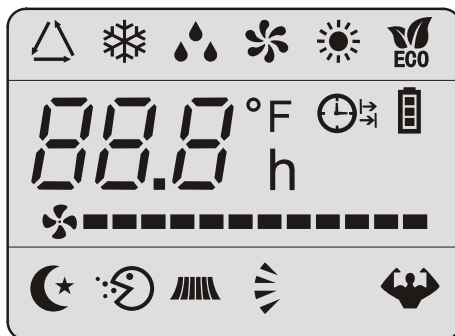

REMOTE CONTROLLER

Replacement of Batteries

Remove the battery cover plate from the rear of the remote controller, by sliding it in the direction of the arrow.

Install the batteries according to the direction (+and -)shown on the Remote Controller.

Reinstall the battery cover by sliding it into place.

⚠ Use 2 LRO 3 AAA (1.5V) batteries . Do not use rechargeable batteries . Replace the old batteries with new ones of the same type when the display is no longer legible.

Do not dispose batteries as unsorted municipal waste. Please discard old batteries at a local waste collection or at designated collection sites.

ii. NOTE:After adjusting the function, you need to take out the batteries and repeat the procedure described above.

⚠ Refer to picture 1 :

When you insert the batteries for the first time in the remote controller or if you change them, you need to program the remote controller of only cooling or cooling and heating.

When you insert the batteries, the symbols ❄ (COOL ■) and ☀ (HEAT ■) start flashing. If you push whatever button when the symbol ❄ (COOL ■) is displayed, the remote controller is adjusted in only cooling mode . If you push whatever button when the symbol ☀ (HEAT ■) is displayed , the remote controller is adjusted in Cooling and heating mode.

⚠ NOTE:If you adjust the remote controller in cooling mode, it will not be possible to activate the heating function in units with heating pump . You need to take out the batteries and repeat the procedure described above.

- ⚠
1. Direct the remote controller toward the Air conditioner.
 2. Check that there are no objects between the remote control and the Signal receptor in the indoor unit.
 3. Never leave the remote controller exposed to the rays of the sun.
 4. Keep the remote controller at a distance of at least 3ft from the television or other electrical appliances.

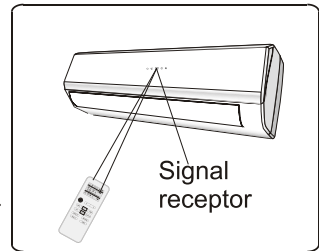
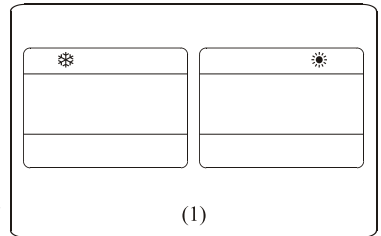

Recommendations for locating and using the remote controller holder (if present)

The remote controller can be kept in a wall-mounted holder

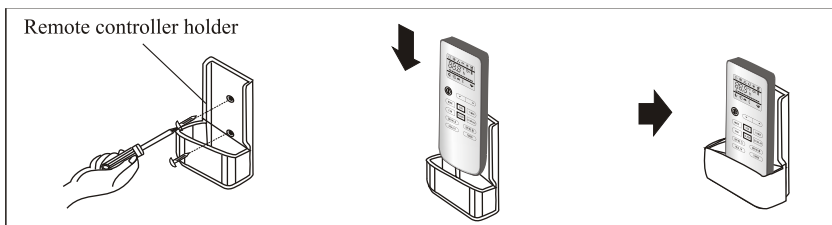

OPERATING INSTRUCTIONS

The air enters through the grill and passes through the filter, then it is cooled/dehumidified or heated through the heat exchanger.

The direction of the air outlet is motorized up and down by flaps, and manually moved right and left by the vertical deflectors, for some models, the vertical deflectors could be controlled by motors as well.

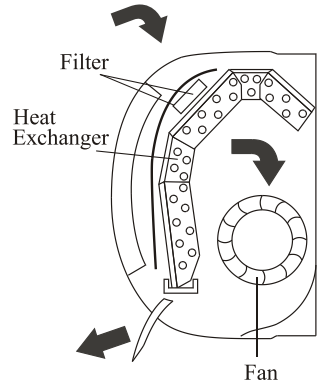

“SWING” CONTROL OF THE AIR FLOW



- The air outlet flow is uniformly distributed in the room.
- Air flow direction can be changed to your preference.

The key **SWING** (↕) activates the “FLAP”, the air flow is directed alternatively from up to down in order to guarantee an even diffusion of the air in the room.

The key **SWING** (↔) activates the motorized “deflectors”, the air flow is directed alternatively from left to right. (Optional function, depends on the models)

- In cooling mode, orient the flaps in horizontal direction;
- In heating mode, orient the flaps downward as the warm air tends to rise.

The deflectors are positioned manually and placed under the flaps. They allow to direct the air flow rightward or leftward.

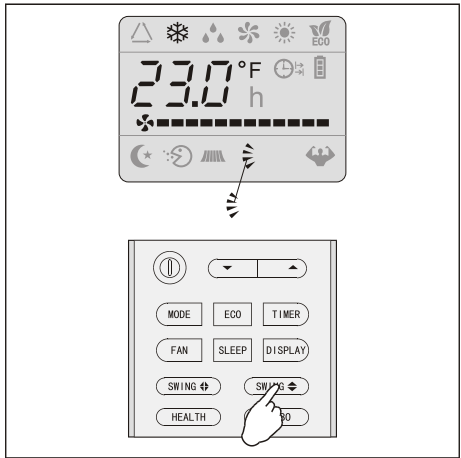

⚠ This adjustment must be done while the appliance is switched off. If the air conditioner you have does not have the optional motorized deflectors.

⚠ Never position “Flaps” manually, the delicate mechanism might get seriously damaged!

⚠ Never poke fingers, sticks or other objects in the air inlet or outlet vents. Such accidental contact with live parts might cause unforeseeable damage or injury.

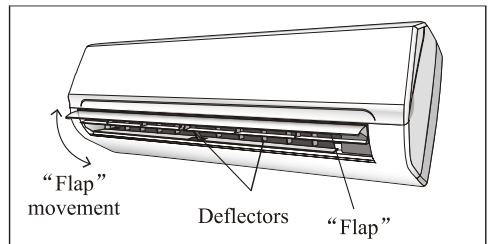

OPERATING INSTRUCTIONS

COOLING MODE



The cooling function allows the air conditioner to cool the room and reduce humidity at the same time.

To activate the cooling function (COOL), press the **MODE** button until the symbol ❄️ (COOL ■) appears on the display.

The cooling function is activated by setting the temperature lower than that of the room.

To optimize the function of the Air conditioner, adjust the temperature (1), the speed (2) and the direction of the air flow (3) by pressing the button indicated.

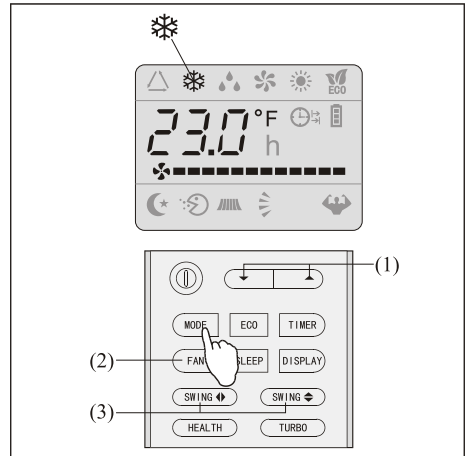

HEATING MODE



The heating function allows the air conditioner to heat the room.

To activate the heating function (HEAT), press the **MODE** button until the symbol ☀️ (HEAT ■) appears on the display.

With the button ▲ or ▼ set a temperature higher than that of the room to activate the heat function.

To optimize the function of the Air conditioner adjust the temperature (1), the speed (2) and the direction of the air flow (3) by pressing the button indicated

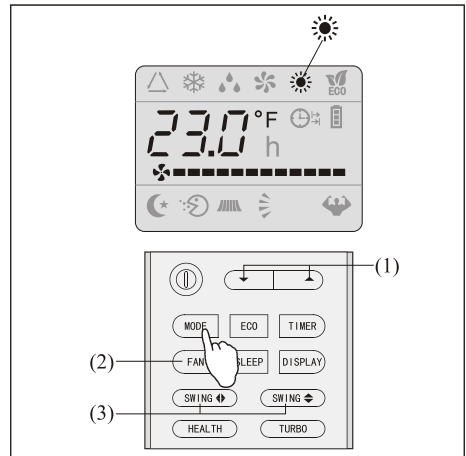

⚠️ If the appliance is fitted with a electrical heater, which delays appliance to startup in a few seconds to ensure an immediate output of hot air (Optional , depends on the model).

⚠️ In HEATING operation, the appliance can automatically activate a defrost cycle, which is essential to clean the frost on the condenser so as to recover its heat exchange function. This procedure usually lasts for 2-10 minutes during defrosting, indoor unit fan stop operation. After defrosting ,it resumes to HEATING mode automatically.

OPERATING INSTRUCTIONS

TIMER MODE----TIMER ON



To turn the unit on with the timer function

Note:

Before proceeding with programming the timer, you need to set up which mode and fan setting you want the unit to start with. Simply change the mode and fan speed while the unit is running. Once you have changed to the desired mode and fan speed, you may proceed with programming the timer.

To program the unit to turn on automatically with the timer, the unit must be off.

Press the timer button once on your remote controller. Set the desired temperature with the up or down button.

Press the timer button again and you can set up the duration of time by 0.5 HR increments by pressing up or down button. Lastly, press the timer button again and confirm your settings. The duration you have set up should display on the LED display of the indoor unit.

Note: To cancel the saved timer setting, press the **TIMER** button again.

Note: If the unit was turned off on accident or by power outage, it is necessary to set **TIMER ON** again.

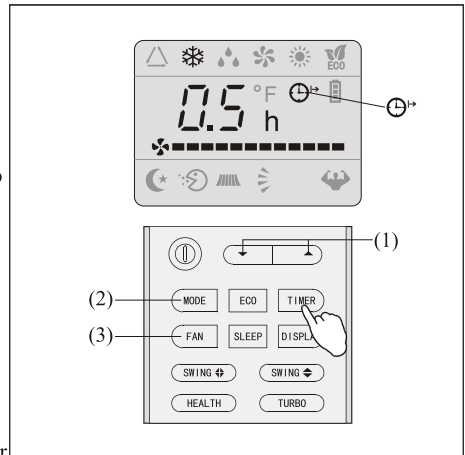

TIMER MODE----TIMER OFF



To turn the unit off with the timer function

The timed stop is programmed by pressing **TIMER**, Set the time duration by pressing the button ▲ or ▼, until the rest time displayed is to your demand then press **TIMER** again.

Note: To cancel the saved the setting, press the **TIMER** button again.

Note: If the unit was turned off on accident or by power outage, it is necessary to set **TIMER OFF** again

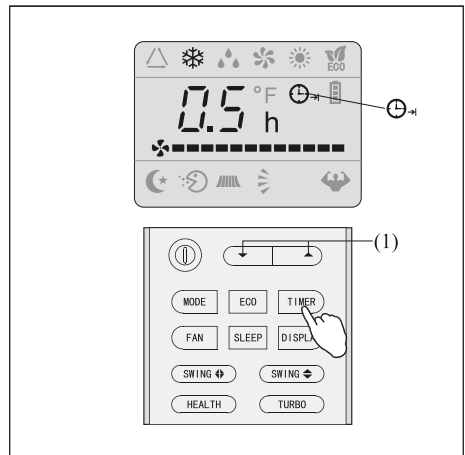

⚠ Note: Timer duration can be set from a minimum half an hour to a maximum of 24 hours. Up to 9.5 hours, you can set in half-hour increments, and from 10 to 24 hours, in 1-hour increments.

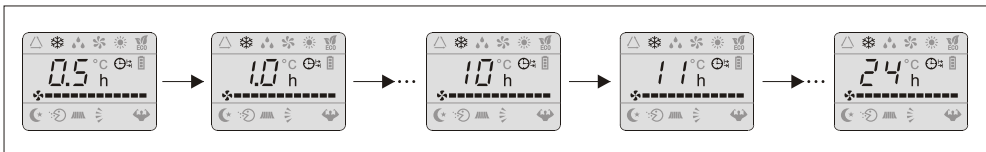



OPERATING INSTRUCTIONS

FAN MODE



The air conditioner will run as a fan.

To set the FAN mode, Press **MODE** until  (FAN ) appears in the display.

Whith pressing **FAN** button the speed changes in the following sequence: LOW/ MEDIUM/HIGH /AUTO in FAN mode.

The remote control also stores the speed that was set in the previous mode of operation.

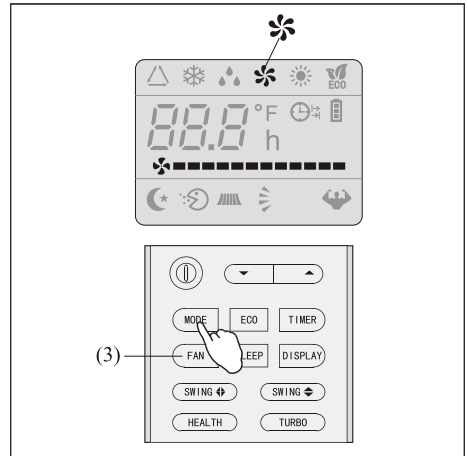

In FEEL mode (automatic) the air conditioner automatically chooses the fan speed and the mode of operation (COOLING or HEATING).



DRY MODE



This function reduces the humidity of the air to make the room more comfortable.

To set the DRY mode, Press **MODE** until  (DRY ) appears in the display. An automatic function of alternating cooling cycles and air fan is activated.

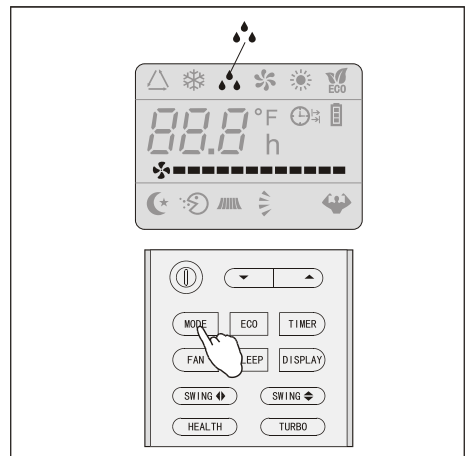

OPERATING INSTRUCTIONS

FEEL MODE



Automatic mode.

To activate the FEEL (automatic) mode of operation, press the **[MODE]** button on the remote controller until the symbol \triangle (FEEL \blacksquare) appears on the display.

In FEEL mode the fan speed and the temperature are set automatically according to the room temperature (tested by the temperature sensor which is incorporated in the indoor unit).

Ambient temp	Operation mode	Auto temp.
< 68°F	HEATING (FOR HEAT PUMP TYPE) FAN (FOR COOL ONLY TYPE)	73°F
68°F ~ 79°F	DRY	64°F
> 79°F	COOL	73°F

To optimize the function of the air conditioner, adjust the temperature (only $\pm 3.6^\circ\text{F}$) (1), the speed (2) and the direction of the air flow (3) by pressing the buttons indicated

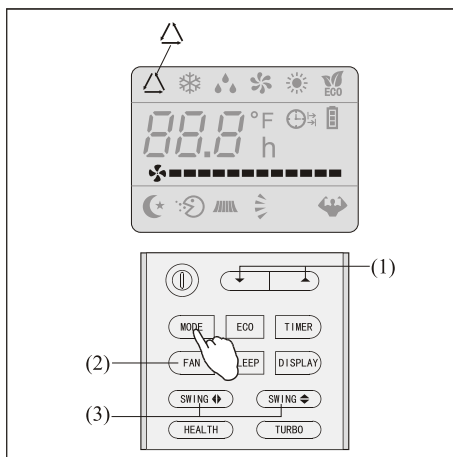

SLEEP MODE



To activate the SLEEP mode of operation, press the **[SLEEP]** button on the remote controller until the symbol ☾ (AUTOQUIET) appears on the display.

The function “SLEEP” automatically adjusts the temperature to make the room more comfortable during the night. In cooling or dry mode, the set temperature will automatically raise by 1°F every 60 minutes, to achieve a total rise of 3.6°F during the first 2 hours of operation.

In heating mode the set temperature is gradually decreased by 3.6°F during the first 2 hours of operation.

After 10 hours running in sleep mode the air conditioner is switched off automatically.

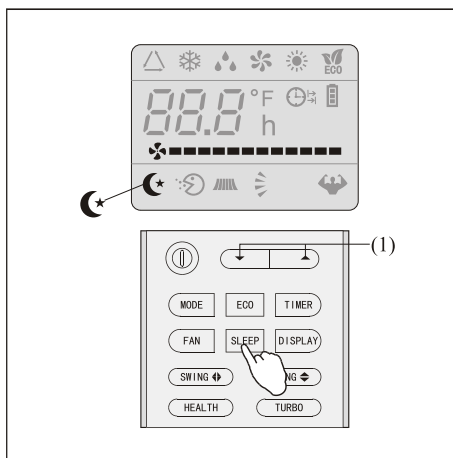

OPERATING INSTRUCTIONS

TURBO MODE



Turbo mode.

To activate the TURBO mode of operation, press the **TURBO** button on the remote control until the symbol  appears in the display.

In cooling mode, press this button, the unit will give the maximum cooling temperature with 61°F

In heating mode, press this button, the unit will give the maximum heating temperature with 88°F

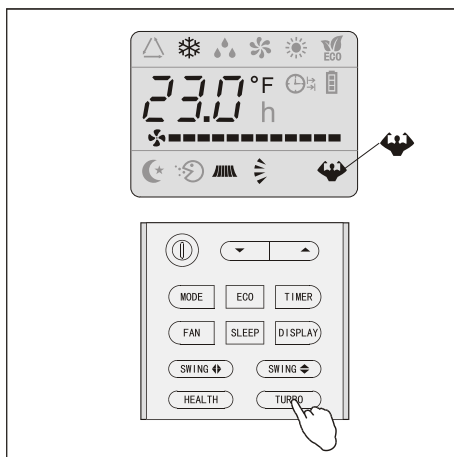

ECO MODE



Eco mode.

To activate the ECO (economic) mode of operation. Press the ECO button on the remote controller until the symbol  appears in the display.

In cooling mode, the temperature will increase 3.6°F on the base of setting temperature, in the heating mode, the temperature will decrease 3.6°F on the base of setting temperature. Press again, the air conditioner switched off ECO mode automatically. The SUPER mode and ECO mode can't work together.

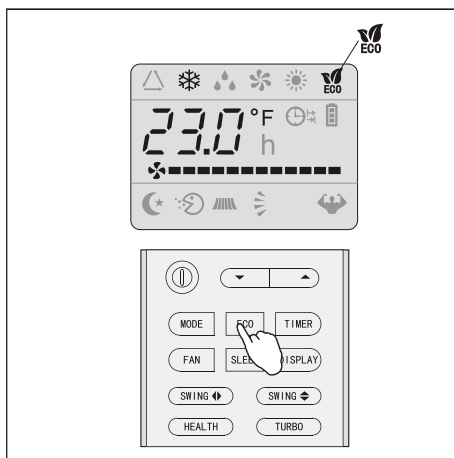

OPERATING INSTRUCTIONS

DISPLAY MODE

Display mode.

To switch on/off the LED display (if present)

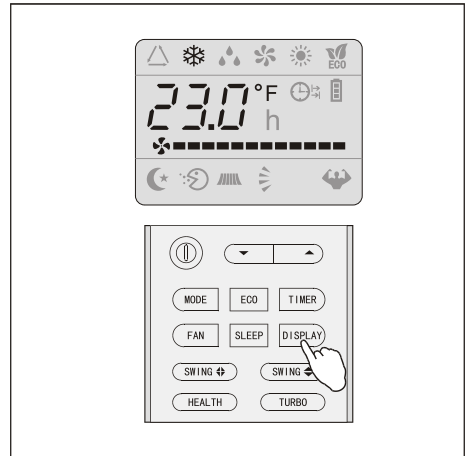

HEALTH MODE



Health mode.

Press the health button on the remote controller until the symbol  appears in the display.

The air conditioner activate anti-bacteria and virus , Ionizer function. (If installed)

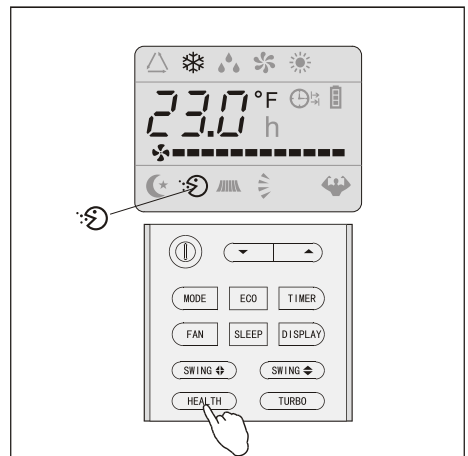



PROTECTION

The air conditioner is programmed for comfortable and suitable living conditions, if it is used in abnormal as below, certain safety protection features might come into effect.

For T1 Climate condition models:

No.	MODE	Ambient temperature
1	Heating	Outdoor temperature is over 75°F
		Outdoor temperature is below 19°F
		Room temperature is over 80°F
2	Cooling	Outdoor temperature is over 109°F
		Outdoor temperature is below 5°F
		Room temperature is below 69°F
3	Dry	Room temperature is below 64°F

 *The unit does not operate immediately if it is turned on after being turned off or after changing the mode during operation. this is a normal self-protection action, you need wait for about 3 minutes.*

 *The capacity and efficiency are according to the test conducted at full-load operation*.
The highest speed of indoor fan motor and the maximum open angle of the flaps and deflectors are requested.

INSTALLATION MANUAL---Selecting the Installation Place

INDOOR UNIT

- Install the indoor unit on a strong wall that is not subject to vibrations.
- The inlet and outlet ports should not be obstructed; the air should be able to blow all over the room.
- Do not install the unit near a source of heat, steam, or flammable gas.
- Install the unit near an electric socket or private circuit.
- Do not install the unit where it will be exposed to direct sunlight.
- Select a site where the condensed water can be easily drained out, and where it is easily connected to outdoor unit.
- Check the machine operation regularly and reserve the necessary spaces as shown in the picture.
- Select a place where the filter can be easily taken out.

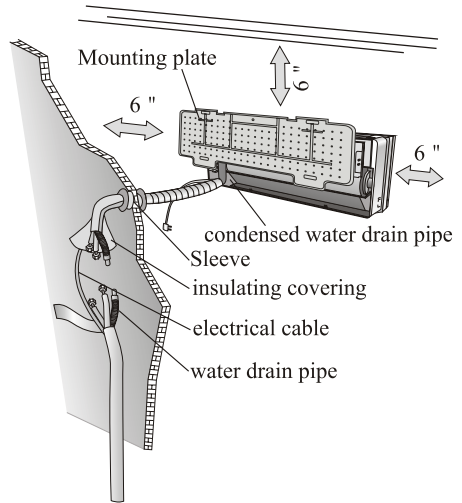

minimum space to be reserved (in) shown in the diagram.

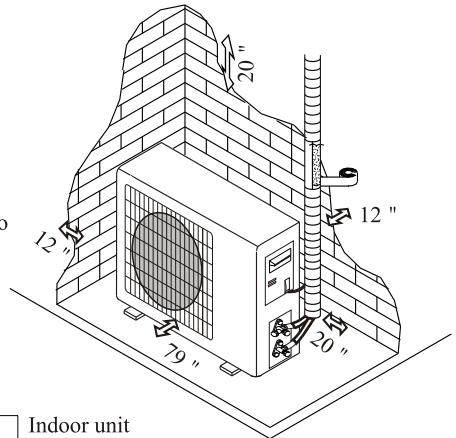

OUTDOOR UNIT

- Do not install the outdoor unit near sources of heat, steam or flammable gas.
- Do not install the unit in too windy or dusty places.
- Do not install the unit where people often pass. Select a place where the air discharge and operating sound will not disturb the neighbours.
- Avoid installing the unit where it will be exposed to direct sunlight (other wise use a protection, if necessary, that should not interfere with the air flow).
- Reserve the spaces as shown in the picture for the air to circulate freely.
- Install the outdoor unit in a safe and solid place.
- If the outdoor unit is subject to vibration, place rubber gaskets onto the feet of the unit..

Installation Diagram

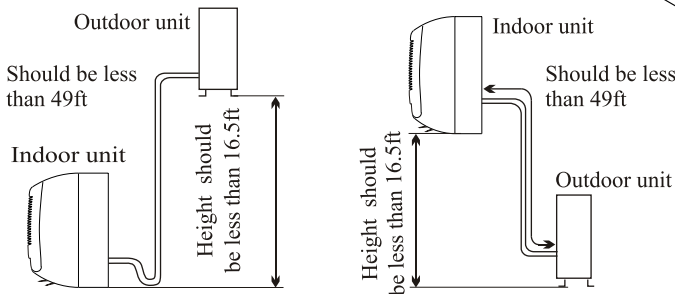

The purchaser must ensure that the person and/or company who is to install, maintain or repair this air conditioner has qualifications and experience in HVAC products.

INSTALLATION MANUAL---Installation of the Indoor unit

Before starting installation, decide on the position of the indoor and outdoor units, taking into account the minimum space reserved around the units

- ⚠ Do not install your air conditioner in a humid room such as a bathroom or laundry etc
- ⚠ The installation site should be 8.2ft or more above the floor.

To install, proceed as follows:

Installation of the mounting plate

- 1 Always mount the rear panel horizontally and vertically
2. Drill 1.25in deep holes in the wall to fix the plate;
3. Insert the plastic anchors into the hole;
4. Fix the rear panel on the wall with provided tapping screws
5. Be sure that the rear panel has been fixed firmly enough to withstand the weight

Note : The shape of the mounting plate may be different from the one above, but installation method is similar .

Drilling a hole in the wall for the piping

1. Make the piping hole (2.2in) in the wall at a slight downward slant to the outdoor side.
2. Insert the piping-hole sleeve into the hole to prevent the connection piping and wiring from being damaged when passing through the hole.

- ⚠ The hole must slope downwards towards the exterior

Note : Keep the drain pipe down towards the direction of the wall hole, otherwise leakage may occur.

Electrical connections---Indoor unit

1. Open the front panel.
 2. Take off the cover as indicated in the picture (by removing a screw or loosening the hooks).
 3. For the electrical connections, see the circuit diagram on the right part of the unit under the front panel.
 4. Connect the cable wires to the screw terminals by following the numbering ,Use wire size suitable to the electric power input (see name plate on the unit) and according to all current national safety code requirements.
- ⚠ The cable connecting the outdoor and indoor units must be suitable for outdoor use.
 - ⚠ An efficient earth connection must be ensured.
 - ⚠ If the power cable is damaged, it must be replaced by a qualified technician.

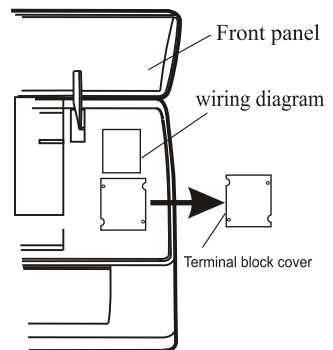
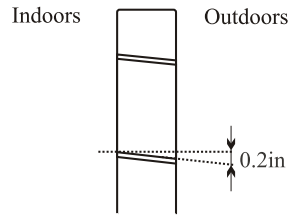
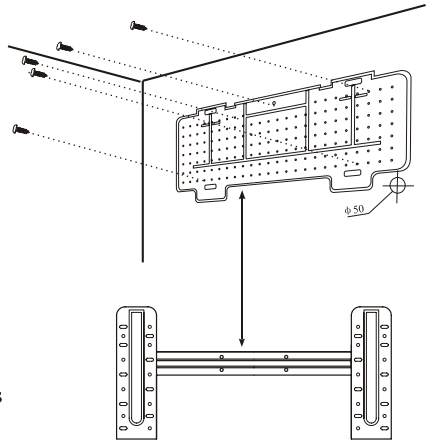

INSTALLATION MANUAL---Installation of the Indoor unit

Refrigerant piping connection

The piping can be run in the 3 directions indicated by numbers in the picture . When the piping is run in direction 1 or 3, cut a notch along the groove on the side of the indoor unit with a cutter.

Run the piping in the direction of the wall hole and bind the copper pipes , the drain pipe and the power cables together with the tape with the drain pipe at the bottom, so that water can flow freely.

- Do not remove the cap from the pipe until connecting it, to avoid dampness or dirt from entering.
- If the pipe is bent or pulled too often , it will become stiff . Do not bend the pipe more than three times at one point.
- When extending the rolled pipe, straighten the pipe by unwinding it gently as shown in the picture.

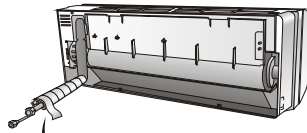
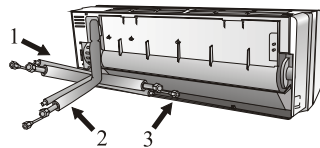

Shape the connection pipe

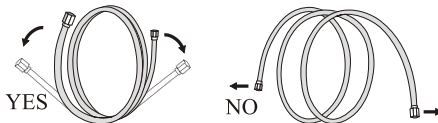

Extending the rolled pipe

Connections to the indoor unit

1. Remove the indoor unit pipe cap (check that there is no debris inside).
2. Insert the flare nut and create a flare at the extreme end of the connection pipe.
3. Tighten the connections by using two wrenches working in opposite directions

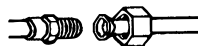

torque wrench

Indoor unit condensed water drainage

The indoor unit condensed water drainage is fundamental for the success of the installation.

1. Place the drain hose below the piping, taking care not to create siphons.
2. The drain hose must slant downwards to aid drainage.
3. Do not bend the drain hose or leave it protruding or twisted and do not put the end of it in water . If an extension is connected to the drain hose , ensure that it is lagged when it passes into the indoor unit.
4. If the piping is installed to the right, the pipes, power cable and drain hose must be lagged and secured onto the rear of the unit with a pipe connection.
 - 1) Insert the pipe connection into the relative slot.
 - 2) Press to join the pipe connection to the base.

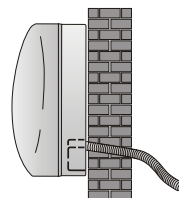

YES

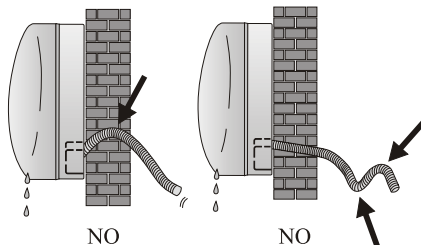

NO

NO

INSTALLATION MANUAL---Installation of the Indoor unit

INSTALLATION OF THE INDOOR UNIT

After having connected the pipe according to the instructions, install the connection cables. Now install the drain pipe. After connection, lag the pipe, cables and drain pipe with the insulating material.

1. Arrange the pipes ,cables and drain hose well.
2. Lag the pipe joints with insulating material , securing it with vinyl tape.
3. Run the bound pipe , Cables and drain pipe through the wall hole and mount the indoor unit onto the upper part of the mounting plate securely.
4. Press and push the lower part of the indoor unit tightly against the mounting plate

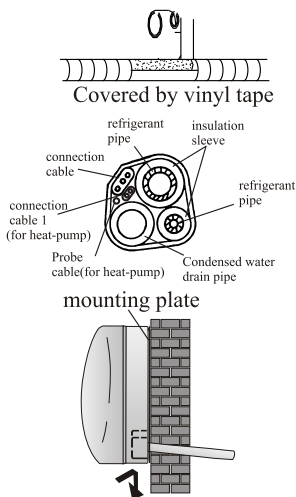

INSTALLATION MANUAL---Installation of the outdoor unit

- The outdoor unit should be installed on a solid wall and fastened securely.
- The following procedure must be observed before connecting the pipes and connecting cables : decide which is the best position on the wall and leave enough space to be able to carry out maintenance easily.
- Fasten the support to the wall using screw anchors which are particularly suited to the type of wall;
- Use a larger quantity of screw anchors than normally required for the weight they have to bear to avoid vibration during operation and remain fastened in the same position for years without the screws becoming loose.
- The unit must be installed following the national regulations.

Outdoor unit condensed water drainage (only for heat pump models)

The condensed water and the ice formed in the outdoor unit during heating operation can be drained away through the drain pipe

1. Fasten the drain port in the 1 in hole placed in the part of the unit as shown in the picture.
2. Connect the drain port and the drain pipe.
Pay attention that water is drained in a suitable place.

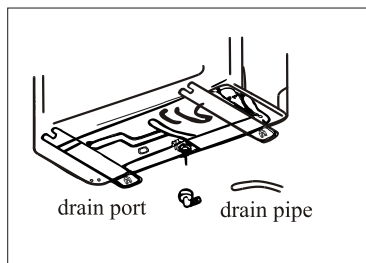

INSTALLATION MANUAL---Installation of the outdoor unit

ELECTRICAL CONNECTIONS

1. Remove the handle on the right side plate of outdoor unit.
2. Connect the power connection cord to the terminal board.
Wiring should fit that of indoor unit.
3. Fix the power connection cord with wire clamp.
4. Confirm if the wire has been fixed properly.
5. An efficient earth connection must be ensured.
6. Recover the handle.

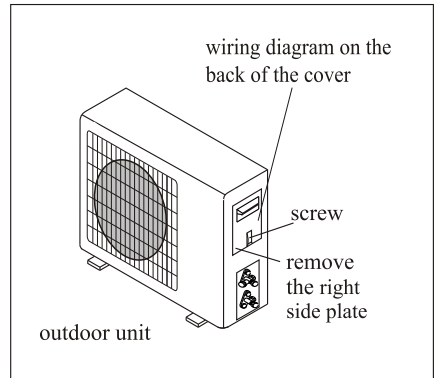

CONNECTING THE PIPES

Screw the flare nuts to the outdoor unit coupling with the same tightening procedures described for the indoor unit.

To avoid leakage, pay attention to the following points:

1. Tighten the flare nuts using two wrenches. Pay attention not to damage the pipes.
2. If the tightening torque is not sufficient, there will probably be some leakage. With excessive tightening torque there will also be some leakage, as the flange could be damaged.
3. The surest system consists in tightening the connection by using a fix wrench and a torque wrench: in this case use the table on page 23.

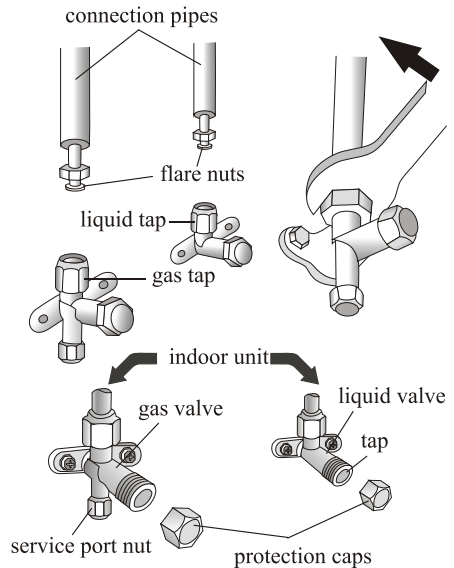

BLEEDING

Air and humidity left inside the refrigerant circuit can cause compressor malfunction. After having connected the indoor and outdoor units, bleed the air and humidity from the refrigerant circuit by using a vacuum pump.

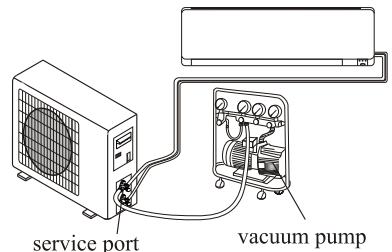

INSTALLATION MANUAL---Installation of the outdoor unit

BLEEDING

The air and humidity left inside the refrigerant circulation can cause compressor malfunction. After having connected the indoor and outdoor units, bleed the air and humidity from the refrigerant circulation using a vacuum pump.

- (1) Unscrew and remove the caps from the 2 - way and 3-way valves.
- (2) Unscrew and remove the cap from the service port.
- (3) Connect the vacuum pump hose to the service port.
- (4) Operate the vacuum pump for 10 - 15 minutes until an absolute vacuum of 200 micron Hg has been reached.
- (5) With the vacuum pump still in operation, close the low - pressure knob on the vacuum pump coupling. Stop the vacuum pump.
- (6) Open the 2 - way valve by 1/4 turn and then close it after 10 seconds. Check all the joints for leaks using liquid soap or an electronic leak device.
- (7) Turn the body of the 2-way and 3-way valves. Disconnect the vacuum pump hose.
- (8) Replace and tighten all the caps on the valves.

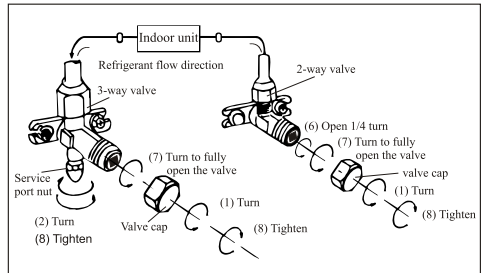
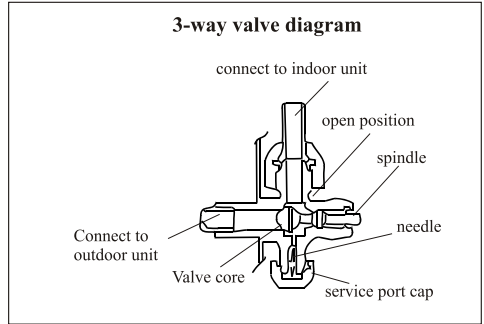

INSTALLATION MANUAL--- operation test

1. Wind insulating covering around the joints of the indoor unit and fix it with insulating tape.
2. Fix the exceeding part of the signal cable to the piping or to the outdoor unit.
3. Fix the piping to the wall (after having coated it with insulating tape) using clamps or insert them into plastic slots.
4. Seal the hole in the wall through which the piping is passed so that no air or water can fill.

Indoor unit test

- Do the ON/OFF and FAN operate normally?
- Does the MODE operate normally?
- Do the set point and TIMER function properly?
- Does each lamp light normally?
- Do the flap for air flow direction operate normally?
- Is the condensed water drained regularly?

Outdoor unit test

- Is there any abnormal noise or vibration during operation?
- Could the noise, the air flow or the condensed water drainage disturb the neighbours?
- Is there any coolant leakage?

Note: the electronic controller allows the compressor to start only three minutes after voltage has reached the system.

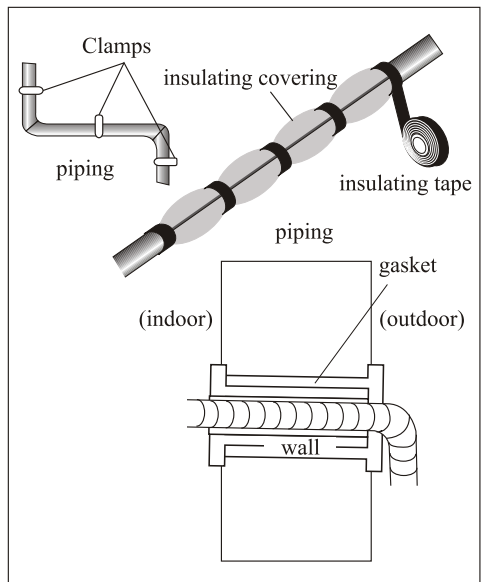

INSTALLATION MANUAL---Information for the installer

INVERTER TYPE MODEL capacity (Btu/h)	9k	12k	18k	22/24k
Liquid pipe diameter	1/4 " (φ 6)	1/4 " (φ 6)	1/4 " (φ 6)	3/8 " (φ 9.52)
Gas pipe diameter	3/8 " (φ 9.52)	1/2 " (φ 12)	1/2 " (φ 12)	5/8 " (φ 15.88)
Length of pipe with standard charge	9.85ft	9.85ft	13.13ft	13.13ft
Maximum distance between indoor and outdoor unit	49.22ft	49.22ft	49.22ft	49.22ft
Additional refrigerant charge	0.22oz/ft	0.22oz/ft	0.33oz/ft	0.33oz/ft
Max. diff. in level between indoor and outdoor unit	16.41ft	16.41ft	16.41ft	16.41ft
Type of refrigerant(1)	R410A	R410A	R410A	R410A

(1) Refer to the data rating label stucked on the outdoor unit.

TIGHTENING TORQUE FOR PROTECTION CAPS AND FLANGE CONNECTION

PIPE	TIGHTENING TORQUE [N x m] / [lbf x Ft]	CORRESPONDING STRESS (using a 20 cm wrench)		TIGHTENING TORQUE [N x m] / [lbf x Ft]
1/4 " (φ 6)	15 - 20 / 11 - 15	wrist strength	Service port nut	7 - 9 / 5 - 7
3/8 " (φ 9.52)	31 - 35 / 23 - 26	arm strength	Protection caps	25 - 30 / 18 - 22
1/2 " (φ 12)	35 - 45 / 26 - 33	arm strength		
5/8 " (φ 15.88)	75 - 80 / 55 - 59	arm strength		

INSTALLATION MANUAL---Information for the installer

WIRING DIAGRAM

For different models, the wiring diagram may be different. Please refer to the wiring diagrams pasted on the indoor unit and outdoor unit respectively.

On indoor unit, the wiring diagram is pasted under the front panel;

On outdoor unit, the wiring diagram is pasted on the backside of the outdoor handle cover.

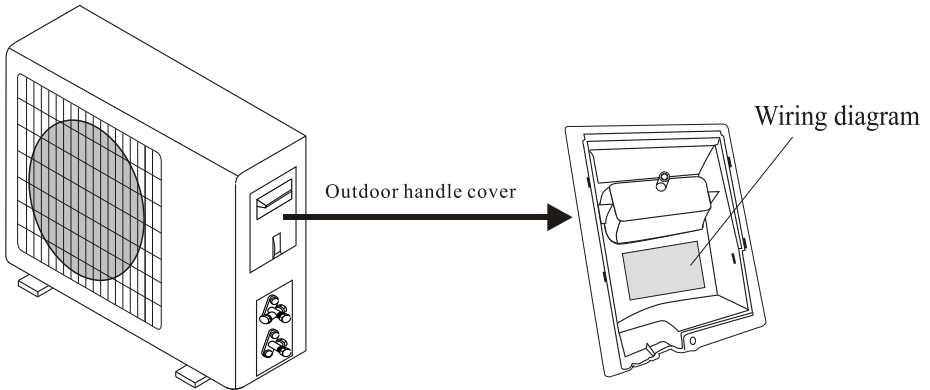
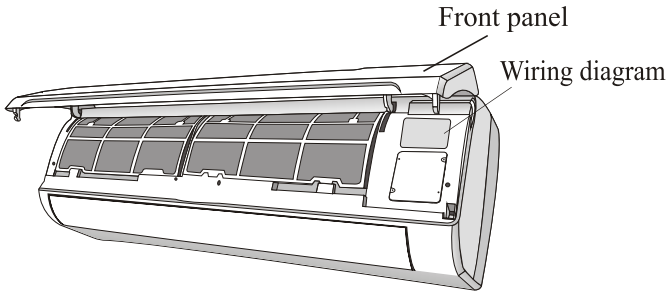

INSTALLATION MANUAL---Information for the installer

CABLE WIRES SPECIFICATION

INVERTER TYPE MODEL capacity (Btu/h)		9k	12k	18/22k
		sectional area		
Power supply cable	N	1.0mm ² (1.5mm ²) AWG18 (AWG16)	1.0mm ² (1.5mm ²) AWG18 (AWG16)	1.5mm ² AWG16
	L	1.0mm ² (1.5mm ²) AWG18 (AWG16)	1.0mm ² (1.5mm ²) AWG18 (AWG16)	1.5mm ² AWG16
	E	1.0mm ² (1.5mm ²) AWG18 (AWG16)	1.0mm ² (1.5mm ²) AWG18 (AWG16)	1.5mm ² AWG16
Connection supply cable	N	1.0mm ² (1.5mm ²)	1.0mm ² (1.5mm ²)	1.5mm ²
	L	1.0mm ² (1.5mm ²)	1.0mm ² (1.5mm ²)	1.5mm ²
	1	1.0mm ² (1.5mm ²)	1.0mm ² (1.5mm ²)	1.5mm ²
		1.0mm ² (1.5mm ²)	1.0mm ² (1.5mm ²)	1.5mm ²

220V 7K , 9K , 12K 15K , 16K , 18K , 22K , 24K , 30K air conditioner indoor unit fuse parameter is 50T, 3.15A
 110V 7K , 9K 12k air conditioner indoor unit fuse parameter is 50T, 3.15A,

MAINTENANCE

Periodic maintenance is essential for keeping your air conditioner efficient.

Before carrying out any maintenance, disconnect the power supply by disconnecting the circuit breaker.

INDOOR UNIT

ANTIDUST FILTERS

1. Open the front panel following the direction of the arrow
2. Keeping the front panel raised with one hand, take out the air filter with the other hand
3. Clean the filter with water; if the filter is soiled with oil, it can be washed with warm water (not exceeding 113F).
Leave to dry in a cool and dry place.
4. Keeping the front panel raised with one hand, insert the air filter with the other hand
5. Close

The electrostatic and the deodorant filter (if installed) cannot be washed or regenerated and must be replaced with new filters after every 6 months.

CLEANING THE HEAT EXCHANGER

1. Open the front panel of the unit and lift it till its greatest stroke and then unhooking it from the hinges to make the cleaning easier.
2. Clean the indoor unit using a cloth with the water (not higher than 104F) and neutral soap. Never use aggressive solvents or detergents.
3. If the outdoor unit is clogged, remove the leaves and the waste and remove the dust with air jet or a bit of water.

END OF SEASON MAINTENANCE

1. Disconnect the automatic switch or the plug.
2. Clean and replace the filters
3. On a sunny day let the conditioner work in ventilation for some hours, so that the inside of the unit can dry completely..

REPLACING THE BATTERIES

When:

- There is no confirmation beep heard from the indoor unit.
- The LCD does not display any symbols.

How:

- Take off the cover at back.
- Place the new batteries respecting the symbols + and - .

N.B: Use only new batteries. Remove the batteries from the remote controller when the conditioner is not in operation

WARNING! Do not throw batteries into common waste bins, they should be disposed of in the special containers situated in the collection points.

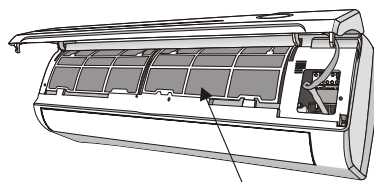
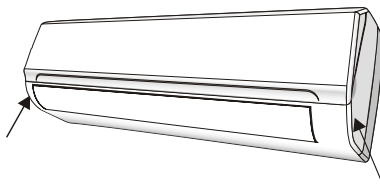

antidust filter

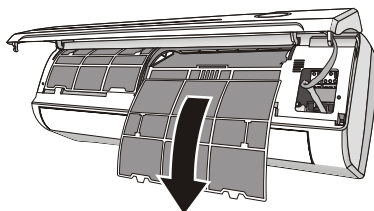

TROUBLESHOOTING

MALFUNCTION	POSSIBLE CAUSES	
The appliance does not operate	Power failure/plug pulled out	
	Damaged indoor/outdoor unit fan motor	
	Faulty compressor thermomagnetic circuit breaker	
	Faulty protective device or fuses.	
	Loose connections or plug pulled out	
	It sometimes stops operating to protect the appliance.	
	Voltage higher or lower than the voltage range	
	Active TIMER-ON function	
Strange odour	Damaged electronic control board	
Strange odour	Air filter dirty	
Noise of running water	Back flow of liquid in the refrigerant circulation	
A fine mist comes from the air outlet	This occurs when the air in the room becomes very cold, for example in the “COOLING” or “DEHUMIDIFYING/DRY” modes.	
A strange noise can be heard	This noise is made by the expansion or contraction of the front panel due to variations in temperature and does not indicate a problem.	
Insufficient airflow, either hot or cold	Inappropriate temperature setting..	
	Air inlet or outlet of indoor or outdoor unit has been blocked.	
	Air filter is blocked.	
	Fan speed set at minimum.	
	Other sources of heat in the room.	
The appliance does not respond to commands	No refrigerant.	
	Remote control is not near enough to indoor unit.	
	Battery in Remote controller may have been exhausted..	
The display is off	Obstacles between remote control and signal receiver in indoor unit.	
	Active LED function	
	Power failure	
Switch off the air conditioner immediately and cut off the power supply in the event of:		
Strange noises during operation.		
Faulty electronic control board		
Faulty fuses or switches.		
Spraying water or objects inside the appliance.		
Overheated cables or plugs.		
Very strong smells coming from the appliance.		
ERROR SIGNALS ON THE DISPLAY		
In case of error, the display on the indoor unit shown the following error codes:		
	RUN lamp	Description of the trouble
E1	flashes once	The fault of indoor temperature sensor
E2	flashes twice	The fault of indoor pipe temperature sensor
E6	flashes 6 times	Malfunction of indoor fan motor.

Note: For more information on error codes, please refer to the service manual of the unit.



I Cool Air Inc.

9419 Ann Street, Santa Fe Springs, CA 90670

Tel: 1-888-328-9050

Fax: 1-562-287-8903

e-mail: sales@anycoolinc.com

www.icoolairinc.com

Design, features and performance specifications related to our product may be changed without notice due to continued development.