



US008492933B2

(12) **United States Patent**
Lanni

(10) **Patent No.:** **US 8,492,933 B2**

(45) **Date of Patent:** **Jul. 23, 2013**

(54) **POWER SUPPLY EQUIPMENT PROVIDING A DATA SIGNAL, IDENTIFICATION INFORMATION AND POWER TO AN ELECTRONIC DEVICE**

(71) Applicant: **Comarco Wireless Technologies, Inc.**,
Lake Forest, CA (US)

(72) Inventor: **Thomas W. Lanni**, Laguna Niguel, CA (US)

(73) Assignee: **Comarco Wireless Technologies, Inc.**,
Lake Forest, CA (US)

(*) Notice: Subject to any disclaimer, the term of this patent is extended or adjusted under 35 U.S.C. 154(b) by 0 days.

(21) Appl. No.: **13/707,119**

(22) Filed: **Dec. 6, 2012**

(65) **Prior Publication Data**

US 2013/0093263 A1 Apr. 18, 2013

Related U.S. Application Data

(63) Continuation of application No. 13/209,636, filed on Aug. 15, 2011, which is a continuation of application No. 12/840,952, filed on Jul. 21, 2010, now Pat. No. 7,999,412, which is a continuation of application No. 11/604,950, filed on Nov. 28, 2006, now Pat. No. 7,868,486, and a continuation-in-part of application No. 10/758,933, filed on Jan. 15, 2004, now Pat. No. 7,453,171.

(51) **Int. Cl.**
G05F 3/06 (2006.01)

(52) **U.S. Cl.**
USPC **307/151**

(58) **Field of Classification Search**
USPC 307/150, 151
See application file for complete search history.

(56) **References Cited**

U.S. PATENT DOCUMENTS

5,164,652 A 11/1992 Johnson et al.
5,254,931 A 10/1993 Martensson
5,333,177 A 7/1994 Braitberg et al.
5,350,993 A 9/1994 Toya et al.
5,369,352 A 11/1994 Toepfer et al.

(Continued)

FOREIGN PATENT DOCUMENTS

WO WO 98/19223 5/1998
WO WO 2006/116298 A1 11/2006

OTHER PUBLICATIONS

“Universal Serial Bus Specification Revision 2.0” Compaq Computer Corporation, et al., Apr. 27, 2000, Cover page, Copyright notice page, Content pages v-xiii, Section 7.2 Power Distribution, pp. 171-178.

(Continued)

Primary Examiner — Daniel Cavallari

(74) *Attorney, Agent, or Firm* — Pillsbury Winthrop Shaw Pittman LLP

(57) **ABSTRACT**

Power supply equipment includes an adapter to convert power from a power source to a DC power for powering an electronic device. The adapter includes circuitry for producing an analog data signal for use by the electronic device to control an amount of power drawn by the device. A cable has an output connector with a plurality of conductors to transfer the DC power and the analog data signal to the electronic device. The connector further includes circuitry to receive a data request from the electronic device and in response transmit a data output which identifies the power supply equipment to the electronic device.

2 Claims, 14 Drawing Sheets

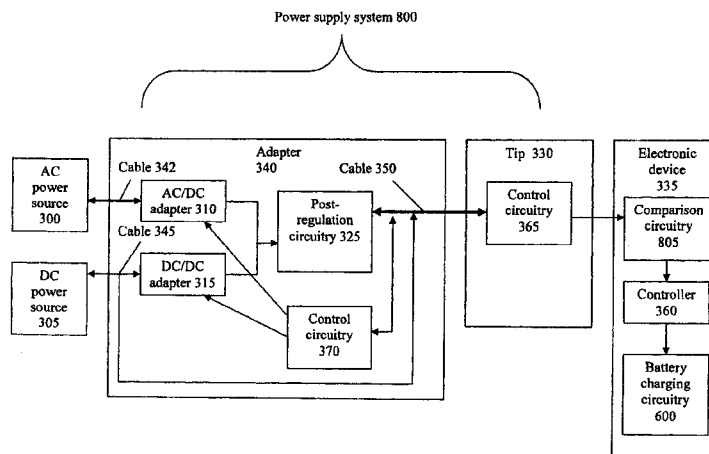

U.S. PATENT DOCUMENTS

5,420,496	A	5/1995	Ishikawa	
5,506,490	A	4/1996	Demuro	
5,534,765	A	7/1996	Kreisinger et al.	
5,570,002	A	10/1996	Castleman	
5,573,425	A	11/1996	Morisawa et al.	
5,593,323	A	1/1997	Dernehl	
5,615,344	A	3/1997	Corder	
5,694,024	A	12/1997	Dias et al.	
5,703,467	A	12/1997	Patino	
5,783,926	A	7/1998	Moon et al.	
5,836,783	A	11/1998	Morisawa et al.	
5,861,729	A	1/1999	Maeda et al.	
5,912,544	A	6/1999	Miyakawa et al.	
5,939,856	A	8/1999	Demuro et al.	
5,955,797	A	9/1999	Kim	
5,969,438	A	10/1999	Odaohara	
6,054,846	A	4/2000	Castleman	
6,288,522	B1	9/2001	Odaohara et al.	
6,358,096	B1	3/2002	Beckman	
6,360,177	B1	3/2002	Curt et al.	
6,368,155	B1	4/2002	Bassler et al.	
6,459,175	B1	10/2002	Potega	
6,528,970	B1	3/2003	Liu et al.	
6,597,565	B1	7/2003	Kluth et al.	
6,628,535	B1	9/2003	Wu	
6,751,109	B2	6/2004	Doss et al.	
6,795,302	B2	9/2004	Kluth et al.	
6,903,950	B2	6/2005	Afzal et al.	
6,999,505	B2	2/2006	Yokoo et al.	
RE39,036	E	3/2006	Castleman	
7,028,202	B2	4/2006	Long et al.	
7,039,821	B1*	5/2006	Potega	713/340
7,127,623	B2	10/2006	Potega	
7,145,312	B2	12/2006	Lanni	
7,392,099	B2*	6/2008	Atkinson et al.	700/22
7,392,410	B2	6/2008	Allen et al.	
7,453,171	B2	11/2008	Lanni	
7,868,486	B2	1/2011	Lanni	
7,937,603	B2	5/2011	Haberle et al.	
7,999,412	B2	8/2011	Lanni	
8,330,303	B2	12/2012	Lanni	
2002/0171980	A1	11/2002	Tsukihashi	

2003/0207603	A1	11/2003	Potega	
2003/0222503	A1	12/2003	Lam et al.	
2004/0075419	A1	4/2004	Massey et al.	
2005/0024030	A1*	2/2005	Lanni	323/274
2005/0127758	A1	6/2005	Atkinson et al.	
2005/0162020	A1	7/2005	Lanni	
2006/0164061	A1	7/2006	Formenti et al.	
2006/0220465	A1	10/2006	Kingsmore, Jr. et al.	

OTHER PUBLICATIONS

European Search Report dated Sep. 28, 2006 for EP Patent Application No. EP05250133.5, 3 pages.

European Search Report dated Feb. 6, 2009 for EP Patent Application No. 07254497.6, 13 pages.

European Patent Office, "Examination Report/Communication Pursuant to Article 94(3) EPC" re: U.S. Appl. No. 05/250,133.5, Date: Jun. 14, 2012, 11 pages.

National Semiconductor Corporation, "Datasheet for LM2601 Adapter Interface Circuit", dated Apr., 2001, 6 pages.

Radio Shack 1990 Catalog, cover page and p. 151, 1990.

Radio Shack 1994 Catalog, cover page and p. 142, 1994.

Radio Shack 1995 Catalog, cover page and p. 150-151, 1995.

Minwa Products, "MW182", Minwa Products Catalog 1993, 1 page.

Power Stream Technology, "High Quality Automobile to Laptop DC/DC Converter" Specification sheet copyright 2000, 2002, 2003, 2004—4 pages.

Acco Brands USA LLC vs. Comarco Wireless Technologies, Inc., Case No. C11-4378 RS, U. S. District Court for the Northern District of California, Plaintiff and Counterdefendant Cco' Invalidation Contentions, pp. 1-3 and Exhibit E, pp. 1-6, Jun. 27, 2012.

Declaration of Thomas W. Lanni Regarding Comarco N19 and N24 Tips, May 14, 2013, 2 pages.

Comarco Wireless Technologies, Inc. Specification Control Drawing No. 1910-0219, "Tip N19", May 14, 2004, 5 pages.

Comarco Wireless Technologies, Inc. Specification Control Drawing No. 1245-0021-T, "EPROMDS2502, TO-92", Jun. 21, 2005, 1 page.

Comarco Wireless Technologies, Inc. Specification Control Drawing No. 1910-0224, "Tip N24", Oct. 23, 2004, 5 pages.

* cited by examiner

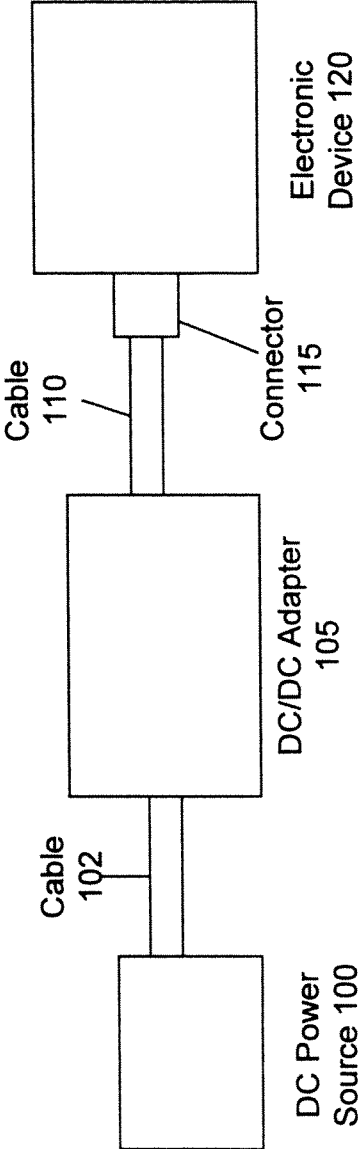

Fig. 1 (Prior Art)

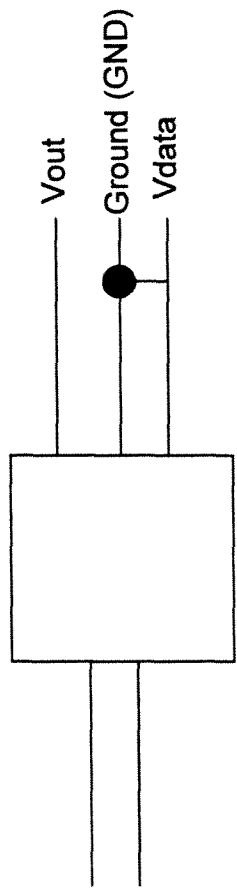

Fig. 2A

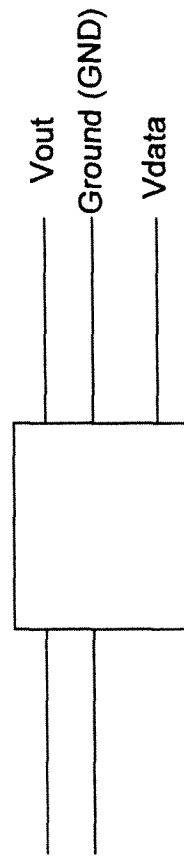

Fig. 2B

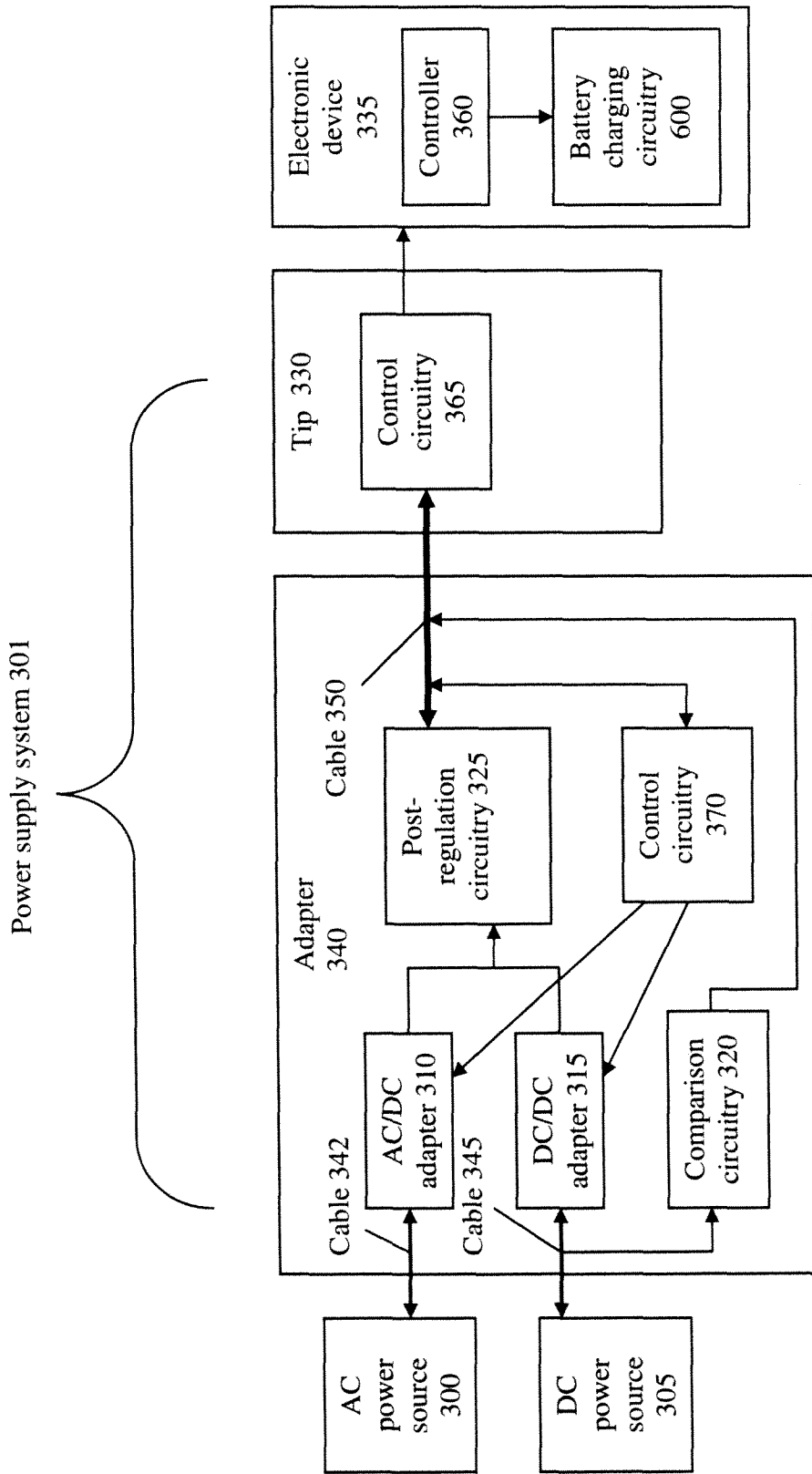

FIG. 3

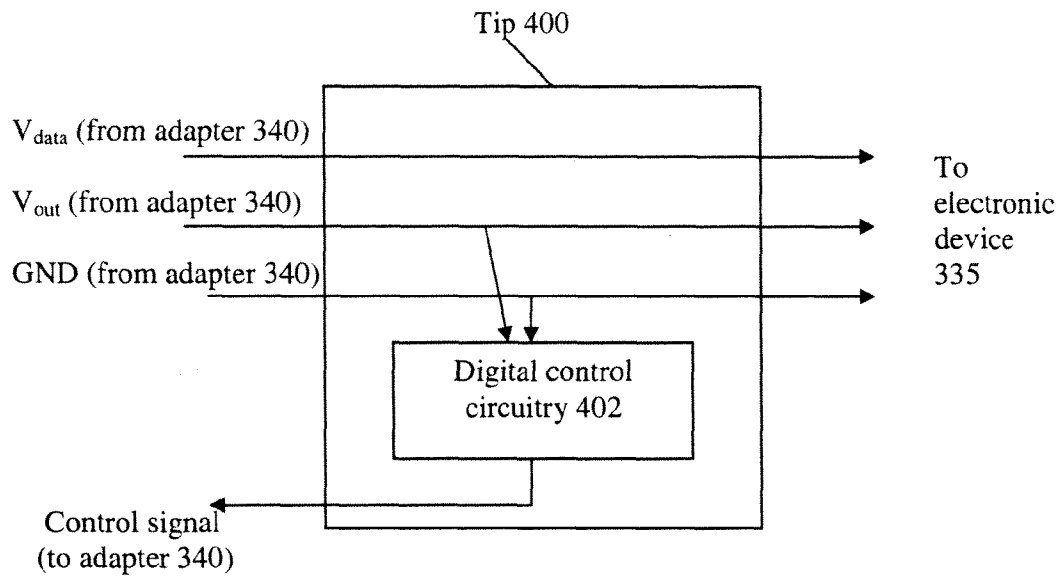

FIG. 4A

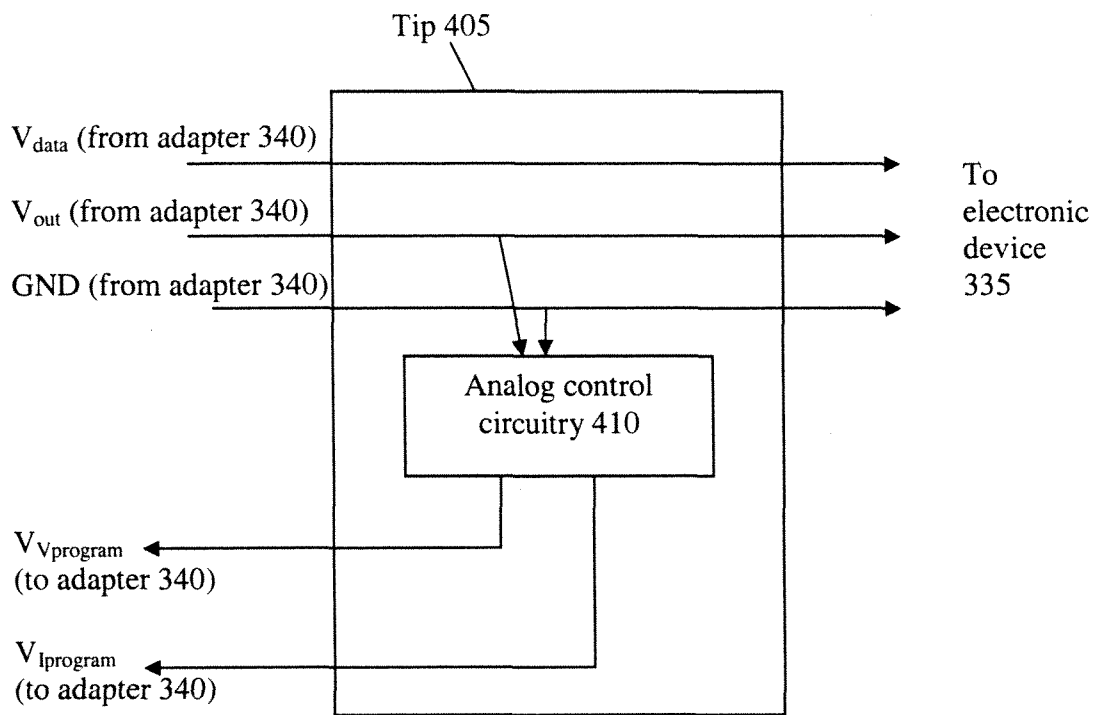

FIG. 4B

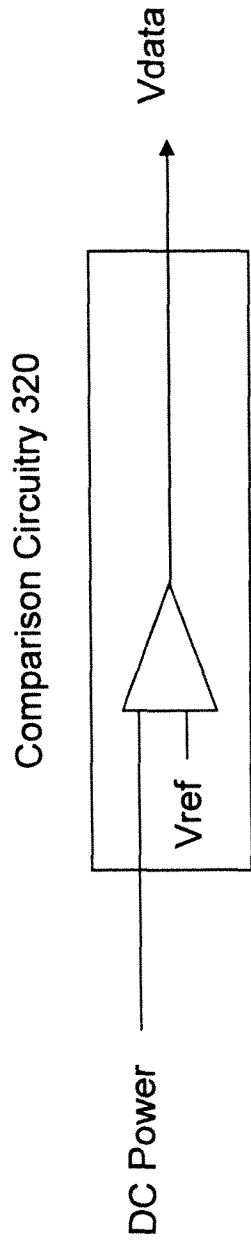

Fig. 5A

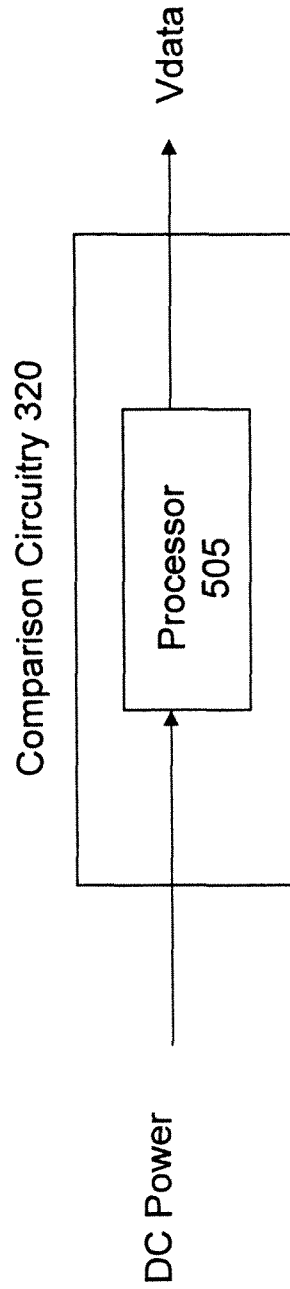

Fig. 5B

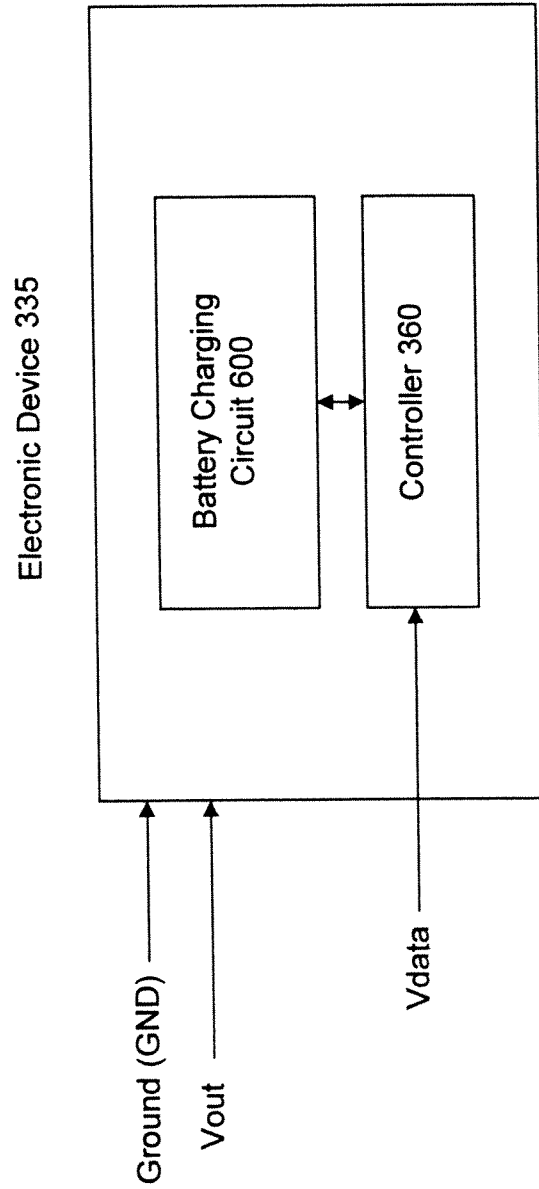

Fig. 6

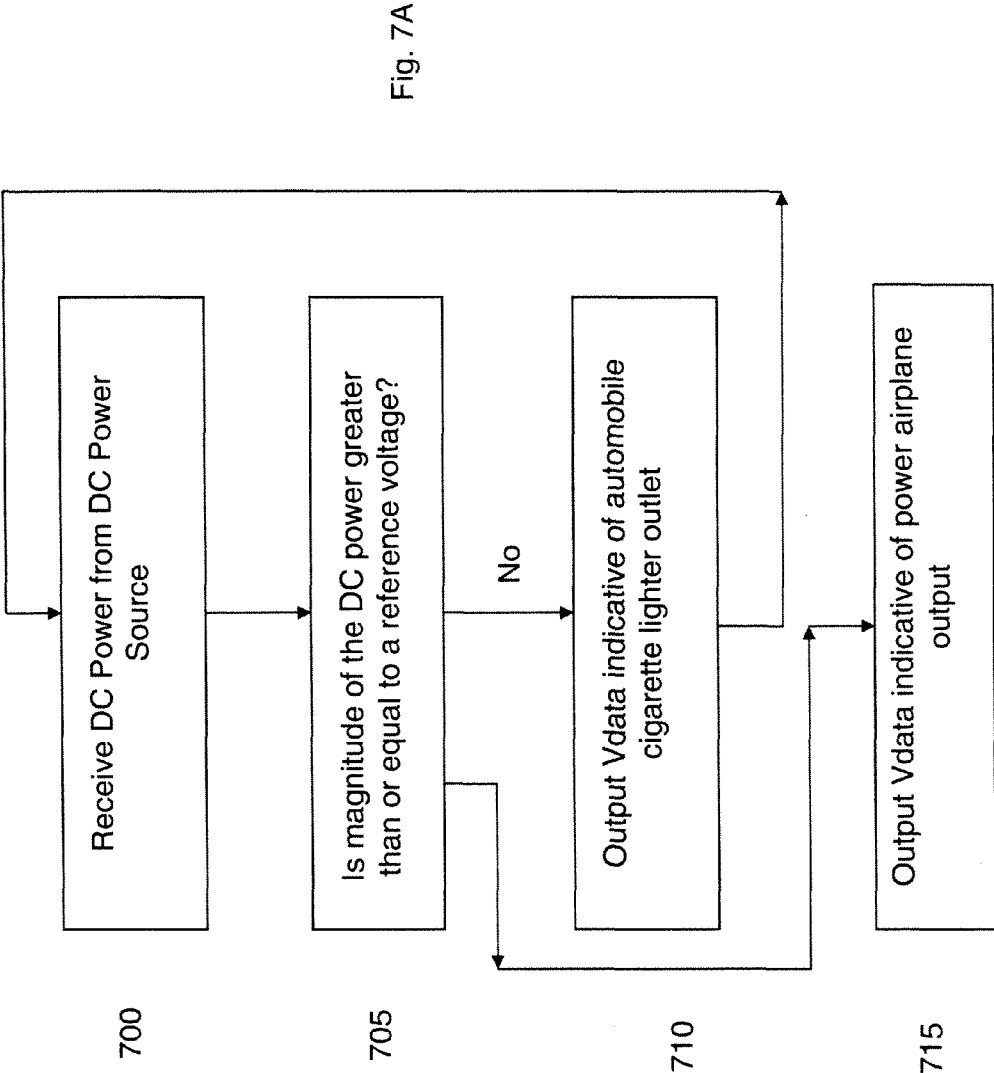

Fig. 7A

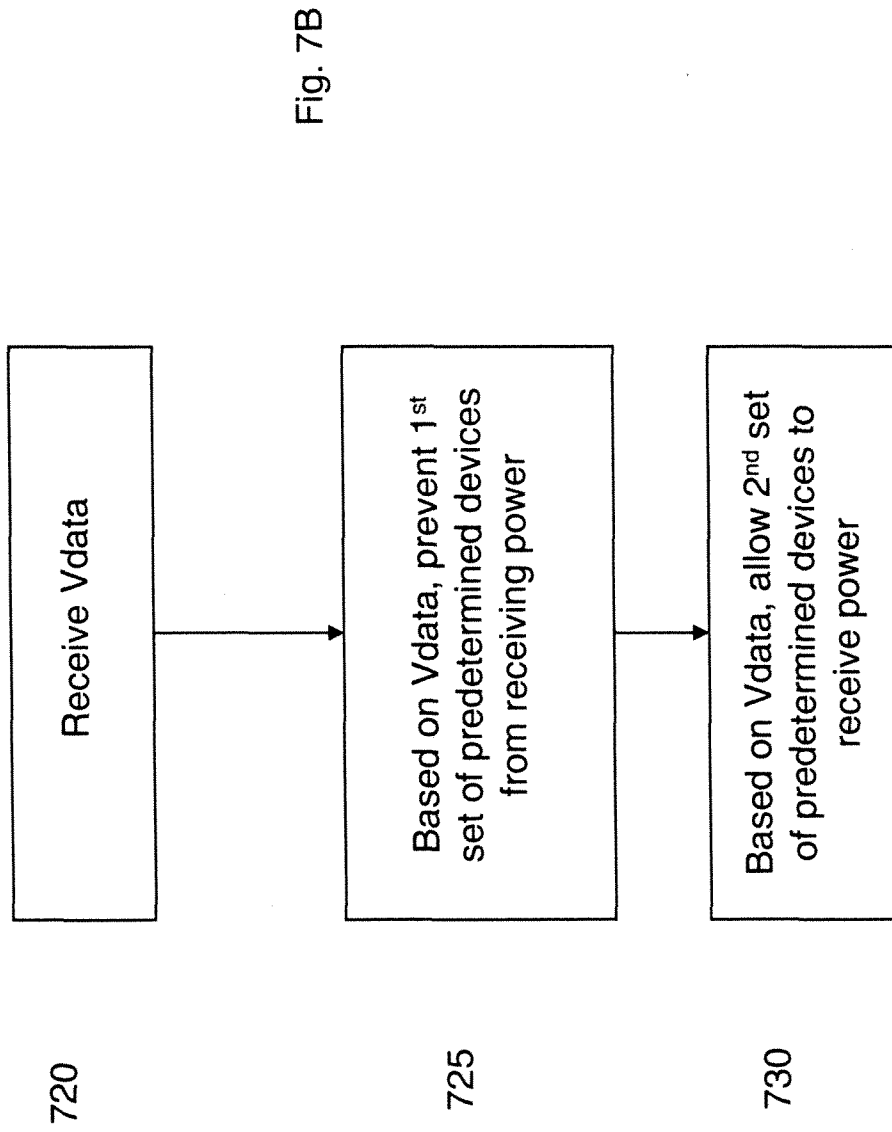

Fig. 7B

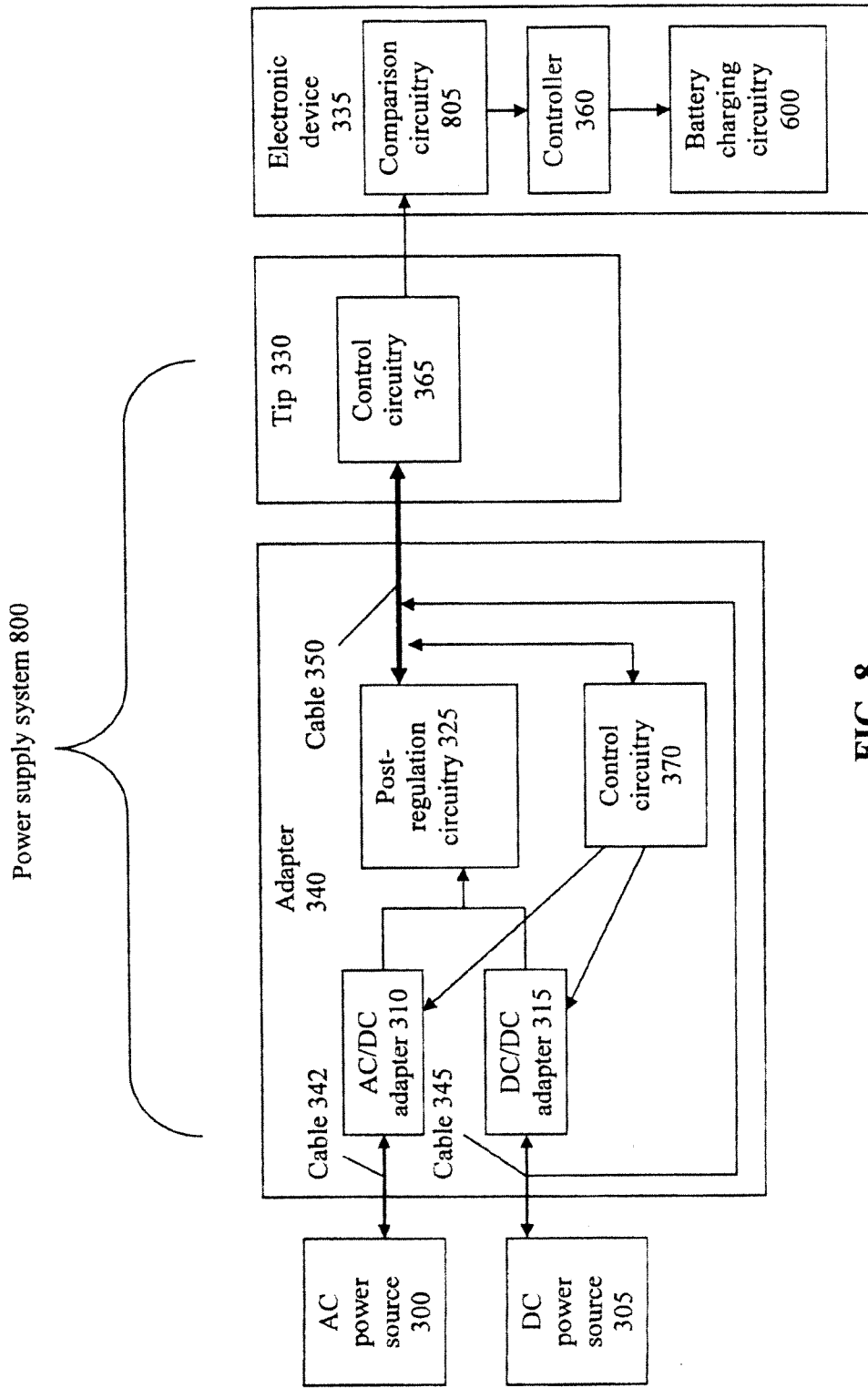

FIG. 8

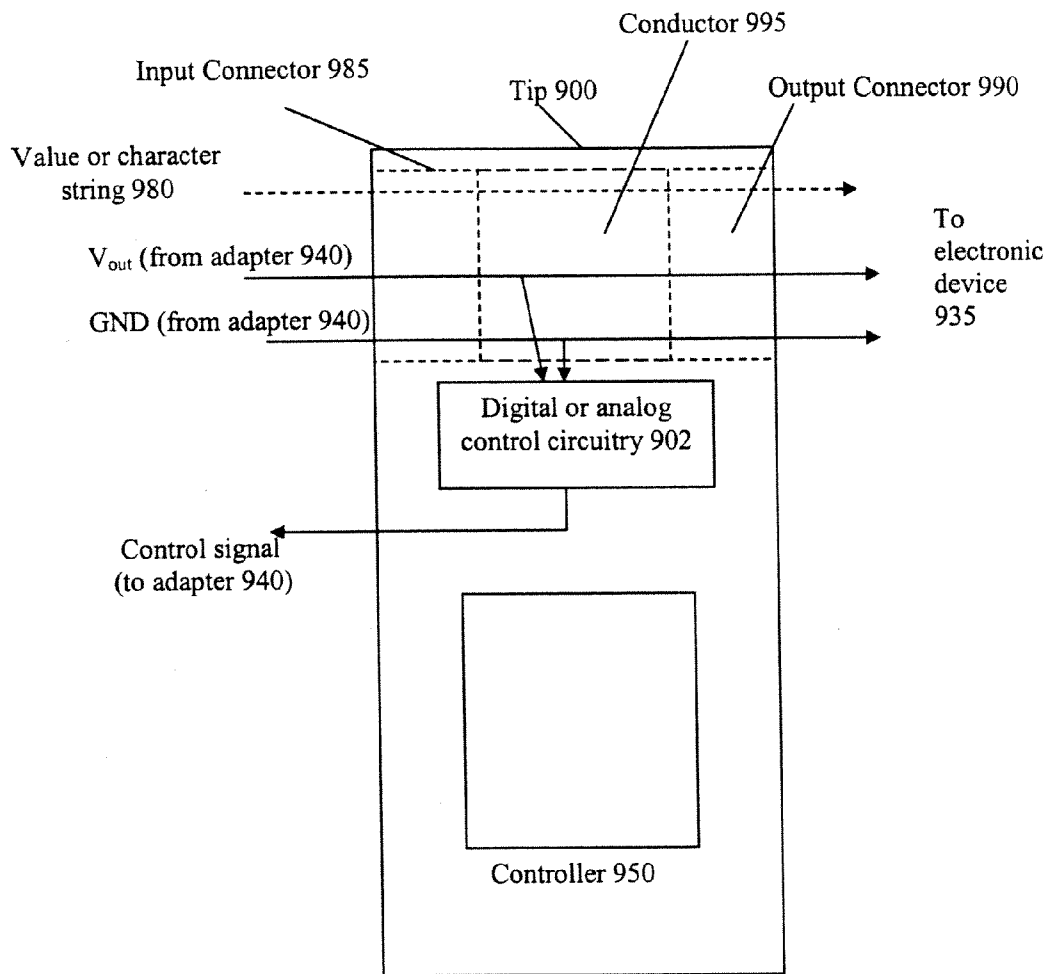

FIG. 9A

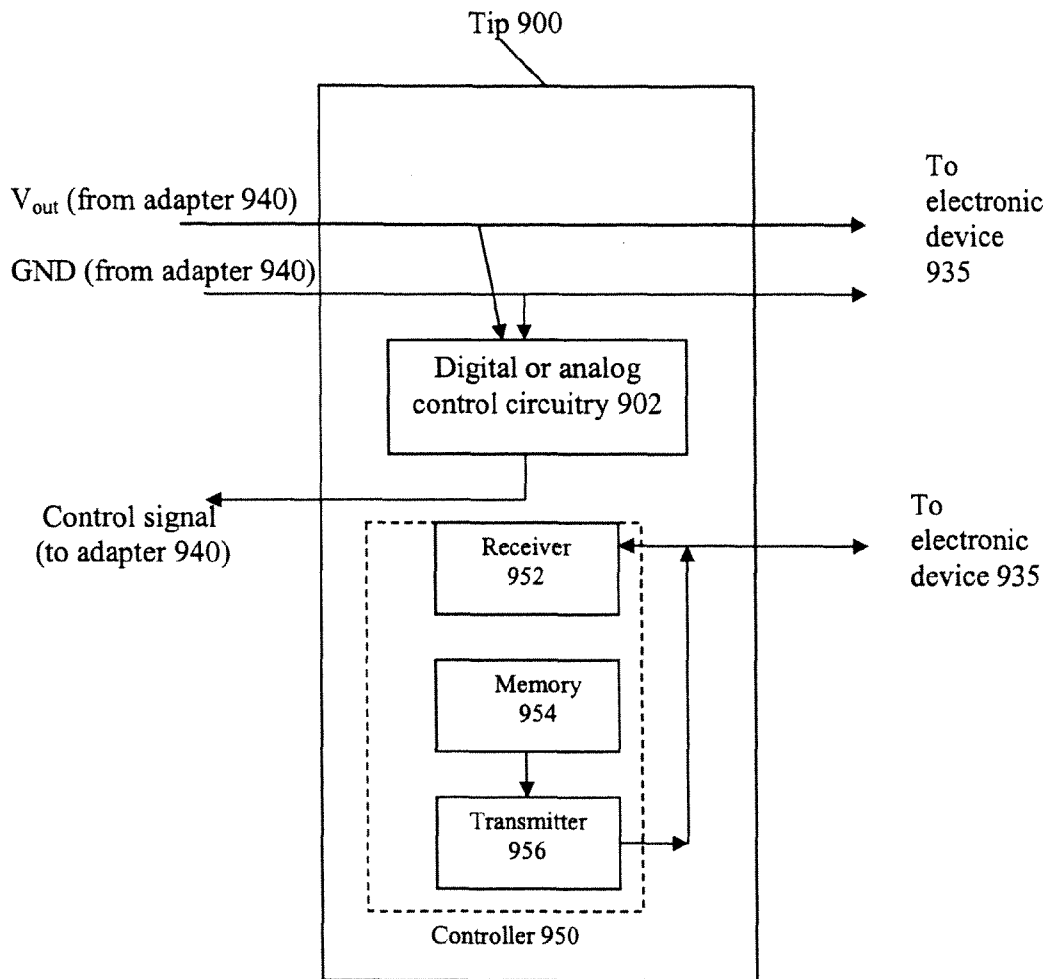

FIG. 9B

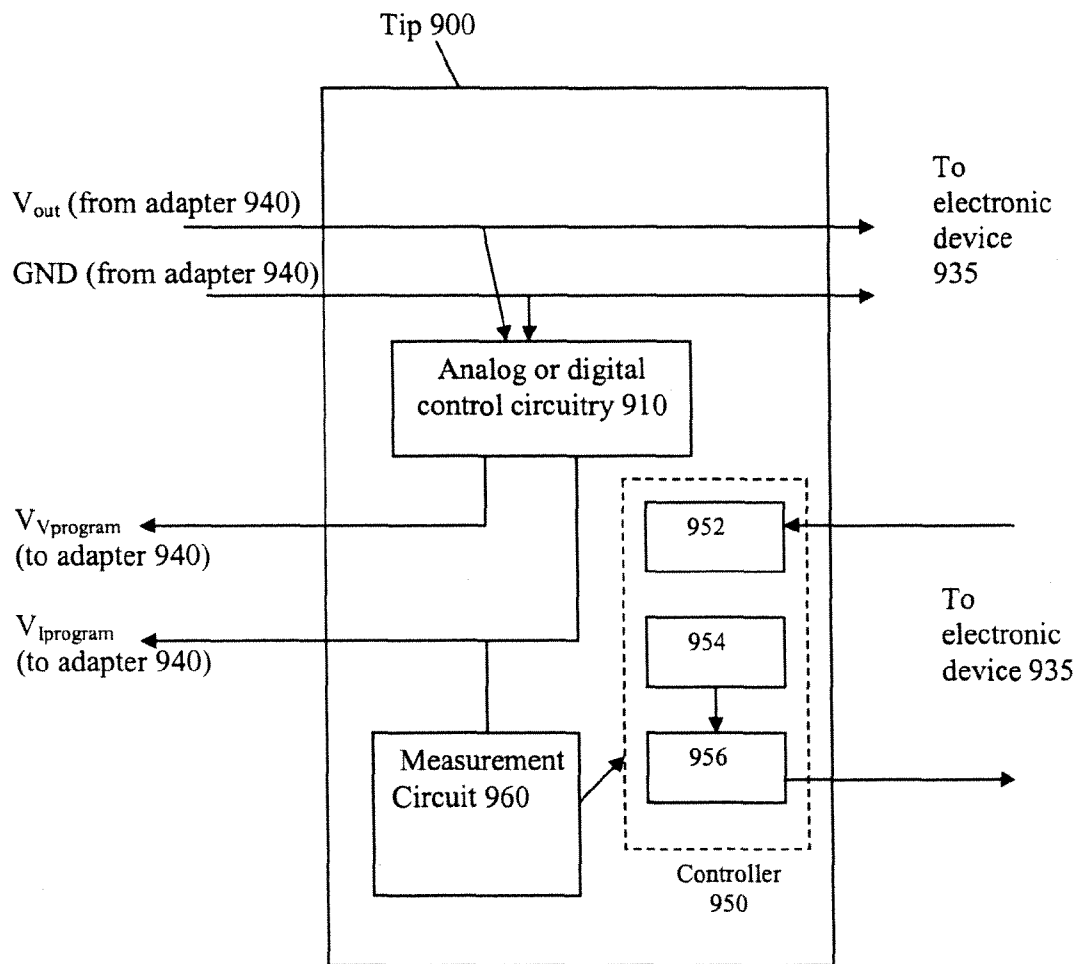

FIG. 10

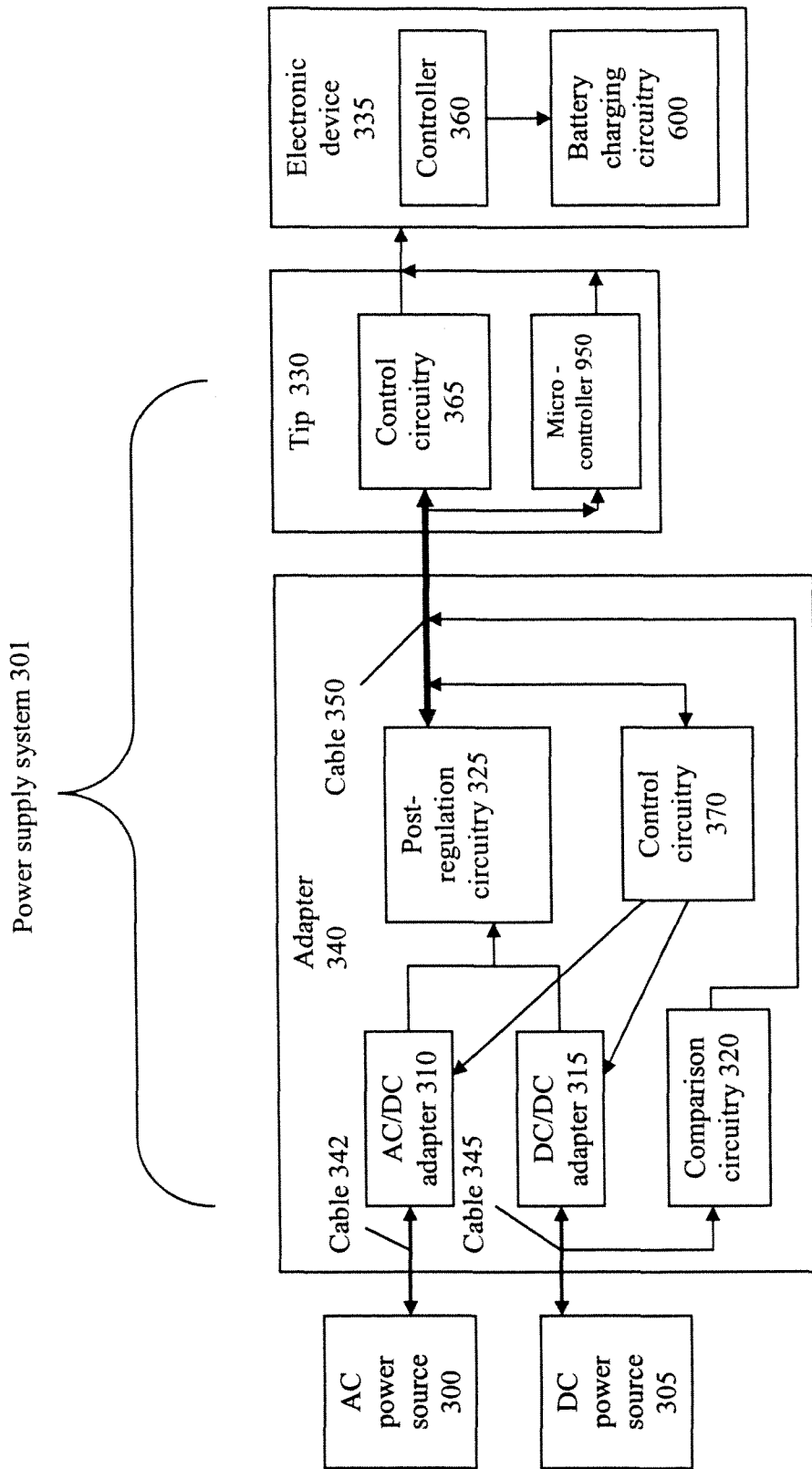

FIG. 11

**POWER SUPPLY EQUIPMENT PROVIDING A
DATA SIGNAL, IDENTIFICATION
INFORMATION AND POWER TO AN
ELECTRONIC DEVICE**

RELATED APPLICATIONS

This application is a continuation of application Ser. No. 13/209,636, filed on Aug. 15, 2011, now U.S. Pat. No. 8,330,303 issued on Dec. 11, 2012, which is a continuation of application Ser. No. 12/840,952, filed on Jul. 21, 2010, now U.S. Pat. No. 7,999,412 issued on Aug. 16, 2011, which is a continuation of application Ser. No. 11/604,950, filed on Nov. 28, 2006, now U.S. Pat. No. 7,868,486 issued on Jan. 11, 2011, which is a continuation-in-part of application Ser. No. 10/758,933, filed on Jan. 15, 2004, now U.S. Pat. No. 7,453,171 issued on Nov. 18, 2008.

BACKGROUND OF THE INVENTION

1. Technical Field

This invention relates to power supply equipment which includes an adapter and interchangeable tips. Via the tips, the power adapter is able to provide a data signal, as well as power, to various electronic devices.

2. Description of the Related Arts

There are power systems in the art which allow a user to hook up a DC/DC adapter to an automobile outlet, to supply regulated DC power to power an electronic device, such as a notebook computer. Automobile outlets typically provide a DC voltage in a range between 11.0 and 14.1 Volts. Some power systems also allow the user to hook up the DC/DC adapter to an airplane output such as the EMPOWER system. EMPOWER typically provides a DC voltage in a range between 14.5 and 15.5 Volts.

Accordingly, some DC/DC adapters can be used with both an automobile outlet and the EMPOWER system to provide a regulated DC power to the electronic device such as the notebook computer. Notebook computers often contain lithium ion batteries. Such batteries can be recharged when the notebook computer is hooked up to the DC/DC adapter. For example, if the user is in a car, the user can couple a DC/DC adapter to the notebook computer and to the cigarette lighter outlet to power the notebook computer. The batteries in the notebook computer will draw some of the DC power supplied to recharge the batteries of the notebook computer if they are low in power. Accordingly, the user can simultaneously use the notebook computer and recharge the batteries therein.

The user can also use the DC/DC adapter while on an airplane, by plugging the DC/DC adapter into the EMPOWER outlet. The EMPOWER outlet and the automobile outlets have different sizes and shapes. Accordingly, the user can directly plug the DC/DC adapter into the EMPOWER outlet, and can place a connector over the EMPOWER plug of the DC/DC adapter and then plug the connector into the automobile cigarette lighter outlet. When the user hooks the DC/DC adapter up to the EMPOWER outlet and then to the electronic device, the electronic device receives the regulated DC power. However, if the charging circuitry in the battery malfunctions, the battery can overheat or even catch on fire when recharging from an EMPOWER DC source. If the battery were to catch on fire while an airplane in which the empower outlet is located is flying, the fire would have the potential to cause the airplane to crash or cause substantial damage.

To address this problem, one system in the art provides a connector to connect between the DC/DC adapter and the notebook computer to inform the notebook computer not to recharge the batteries. FIG. 1 illustrates a power supply system according to the prior art. As shown, a DC power source **100** is coupled to a DC/DC adapter **105** via a cable **102**. The DC/DC adapter **105** receives power from the DC power source **100** and outputs regulated DC power to an electronic device **120**, via a cable **110** and a connector **115** coupled to the end of the cable **110**.

The DC/DC adapter **105** can provide three output pins to the electronic device **120**, as shown in FIGS. 2A and 2B of the prior art. The first pin can provide the output voltage (i.e., V_{out}), the second pin can provide a ground reference (i.e., GND), and the third pin can provide a data line (i.e., V_{data}) to instruct the notebook as to whether the batteries should be recharged or not. For example, as shown in FIG. 2A, V_{data} could be tied to GND to indicate that the DC power source **100** is the EMPOWER system and therefore the battery should not be recharged. Alternatively, as shown in FIG. 2B, V_{data} could also be left open (i.e., to provide a non-grounded floating voltage) when the DC power source **100** in a cigarette lighter outlet of an automobile. Accordingly, when using the DC/DC adapter **105** while in an automobile, the user would use a connector **115** having the V_{data} line floating, and when using the DC/DC adapter **105** with the EMPOWER system of an airplane, the user would use a connector **115** having the V_{data} line tied to GND.

However, problems arise when the user forgets to change the connector **115** for use with the automobile when the user is in an airplane. Accordingly, if the user has the wrong connector **115** attached when using with the EMPOWER system, a battery of an electronic device **120** such as a notebook computer can charge the battery even when used with the EMPOWER system, and if the charging circuitry of the battery malfunctions, overheating or even a fire can occur, resulting in damage to the notebook computer. Also, if the connector **115** is damaged or flawed, then it may not provide the correct V_{data} signal to the notebook computer, allowing the notebook computer to recharge the batteries in an airplane when they shouldn't be allowed to do so.

Accordingly, current DC/DC power adapter systems are deficient because they are incapable of automatically and intelligently informing an electronic device **120** coupled thereto of the DC power source (i.e., the EMPOWER system or an automobile cigarette lighter outlet).

BRIEF DESCRIPTION OF THE DRAWINGS

FIG. 1 illustrates a power supply system according to the prior art;

FIG. 2A illustrates a first connector to coupled a power supply system to an electronic device according to the prior art;

FIG. 2B illustrates a second connector to coupled a power supply system to an electronic device according to the prior art;

FIG. 3 illustrates a power supply system according to an embodiment of the invention;

FIG. 4A illustrates a tip having digital control circuitry according to an embodiment of the invention;

FIG. 4B illustrates a tip having analog control circuitry according to an embodiment of the invention;

FIG. 5A illustrates comparison circuitry according to an embodiment of the invention;

FIG. 5B illustrates comparison circuitry according to an additional embodiment of the invention;

FIG. 6 illustrates an electronic device according to an embodiment of the invention;

FIG. 7A illustrates a method of determining and outputting V_{data} according to an embodiment of the invention;

FIG. 7B illustrates a method of receiving V_{data} and allowing power to flow to devices within the electronic device based on V_{data} according to an embodiment of the invention;

FIG. 8 illustrates a power supply system according to an embodiment of the invention;

FIGS. 9A and 9B illustrate a tip including control circuitry according to embodiments of the invention;

FIG. 10 illustrates a tip including control circuitry and a measurement circuit according to an embodiment of the invention; and

FIG. 11 illustrates a power supply system including a tip according to an embodiment of the invention.

DETAILED DESCRIPTION

An embodiment of the present invention is directed to a power supply system to determine a DC power source (e.g., an automobile cigarette lighter outlet or an EMPOWER airplane outlet) coupled thereto and send a signal indicative of the power source to an electronic device coupled thereto. The electronic device may be a notebook computer or other portable consumer electronic device, for example. Based on the signal sent to the electronic device, the electronic device may control the amount of power drawn to prevent overheating. For example, when a notebook computer is hooked up and the power source is the EMPOWER system, the electronic device may disable charging of the internal batteries of the notebook computer, in order to prevent damage or overheating of the batteries due to malfunction or failure. The DC power source may be determined by voltage comparison circuitry, such as a comparator, or by a voltage comparison device including a processor.

FIG. 3 illustrates a power supply system 301 according to an embodiment of the invention. As shown, the adapter 340 may be used with an AC power source 300 or a DC power source 305. In other embodiments, only a DC power source 305 may be utilized to supply power. The AC power source 300 may be coupled to an AC/DC adapter 310 via a cable 342. The DC power source 305 may be coupled to both a DC/DC adapter 315 and comparison circuitry 320 via a cable 345. The DC power source 305 may be an automobile's cigarette lighter outlet or an airplane's EMPOWER system outlet, for example. AC/DC adapter 310 may convert AC power from the AC power source 300 into regulated DC power, which is supplied to post-regulation circuitry 325. The post-regulation circuitry 325 may provide an output voltage (V_{out}) and a ground reference (GND) to a tip 330 coupled to the adapter 340 via a cable 350, as further explained below with respect to FIGS. 4A and 4B. The tip 330 may be coupled to an electronic device 335 to provide the power thereto from the power supply system 301. The tip 330 may be removable from the cable 350 and may be inserted into a power input opening of the electronic device. Tips 330 may have different shapes and sizes, depending up the shape and sizes of the power input openings of the respective electronic devices 335 being powered. The tip 330 may also include control circuitry 365 to provide a signal to control circuitry 370 of the adapter 340. The signal may be sent to the control circuitry 370 via the cable 350. In one embodiment, the control circuitry 365 of the tip 330 may include digital components to provide a digital signal to the control circuitry 370 of the adapter 340. The digital signal may be utilized to set the magnitude of V_{out} and limit the amount of current which may be drawn from the

adapter 340. The post-regulation circuitry 325 regulates the voltage to what the tip 330 tells it to provide.

Alternatively, the tip 330 may include analog components and may provide voltage programming and current programming voltages ($V_{Vprogram}$ and $V_{Iprogram}$, respectively) to the adapter 340. $V_{Vprogram}$ may be utilized to set the magnitude of V_{out} . For example, there may be a linear relationship between $V_{Vprogram}$ and V_{out} where V_{out} is 3 times as large as $V_{Vprogram}$. Accordingly, if $V_{Vprogram}$ had a magnitude of 3.0 Volts, V_{out} would have a magnitude of 9.0 Volts, and if $V_{Vprogram}$ had a magnitude of 2.0 Volts, V_{out} would have a magnitude of 6.0 Volts. The analog circuitry may contain passive or active components.

Accordingly, regardless of whether the tip 330 has analog or digital control circuitry, a single adapter 340 may be used to supply power to a plurality of different electronic devices 335 having different power requirements.

The adapter 340 may also include comparison circuitry 320. The comparison circuitry 320 may compare a magnitude of a voltage received from the DC power source 305 with a reference voltage to determine whether the DC power source 305 is an automobile cigarette lighter outlet or an EMPOWER airplane outlet. As stated above, automobile cigarette lighter outlets typically provide a DC voltage having a magnitude within the range of 11.0 Volts and 14.1 Volts. An EMPOWER airplane outlet typically provides a DC voltage having a magnitude within the range of 14.5 and 15.5 Volts. Accordingly, the reference voltage may be set at a level between the high end of the automobile cigarette light outlet voltage (i.e., 14.1 Volts) and the low end of the EMPOWER airplane outlet voltage (i.e., 14.5 Volts). For example, the reference voltage may be set at 14.3 Volts. Accordingly, if the magnitude of the DC power source is greater than 14.3 Volts, then the comparison voltage may determine that the received DC voltage has a greater magnitude than the reference voltage and the DC power source 305 is therefore the EMPOWER airplane outlet. However, if the magnitude of the DC power source is less than 14.3 Volts, then the comparison voltage may determine that the received DC voltage has a smaller magnitude than the reference voltage and the DC power source 305 is therefore the automobile cigarette lighter outlet.

The comparison circuitry 320 may output a signal V_{data} based upon whether the DC power source is determined to be the automobile cigarette lighter outlet or the EMPOWER airplane outlet. For example, the comparison may output 5 Volts if the automobile cigarette lighter outlet is detected, and 0.0 Volts if the EMPOWER airplane outlet is detected. In alternative embodiments, different voltages for V_{data} may be used. In additional embodiments, the comparison circuitry 320 may output a digital signal, such as a stream of bits, indicative of the DC power source 305. V_{data} may be sent via cable 350 to the tip 330, and straight over to the electronic device 335. The electronic device 335 may include a controller 360 which is responsive to V_{data} . For example, if the electronic device 335 is a notebook computer and V_{data} is indicative of the EMPOWER airplane outlet system, the controller 360 may disable battery charging circuitry 600, thereby preventing recharging of the batteries. And if the V_{data} is indicative of the automobile cigarette lighter outlet as the DC power source 305, the controller 360 may enable battery charging circuitry to allow the batteries to be recharged.

Although FIG. 3 illustrates an adapter 340 which includes both a AC/DC adapter and a DC/DC adapter, other embodiments may include only a DC/DC adapter, and no AC/DC adapter.

5

FIG. 4A illustrates a tip 400 having digital control circuitry 402 according to an embodiment of the invention. As shown, the tip 400 receives V_{data} , V_{out} and GND from the adapter 340 and allows them to all flow to the electronic device 335. The digital control circuitry 402 may receive the V_{out} and GND signals and may output a control signal to the adapter 340 to set the magnitude of V_{out} and limit the current provided. The control signal may be sent to the adapter 340 via the cable 350 between the tip 400 and the adapter 340. The digital control circuitry 402 may include a processor and a memory device, for example. In some embodiments, the tip 400 may be separable from cable 350, and in other embodiments, the tip 400 may be physically part of the cable 350.

FIG. 4B illustrates a tip 405 having analog control circuitry 410 according to an embodiment of the invention. As shown, the tip 405 receives V_{data} , V_{out} and GND from the adapter 340 and allows them to all flow to the electronic device 335. The analog control circuitry 410 may receive the V_{out} and GND signals and may output $V_{Vprogram}$ and $V_{Iprogram}$ to the adapter 340. $V_{Vprogram}$ and $V_{Iprogram}$ may be sent to the adapter 340 via the cable 350 between the tip 405 and the adapter 340. The analog control circuitry 400 may include passive or active components, for example. In some embodiments, the tip 400 may be separable from cable 350, and in other embodiments, the tip 400 may be physically part of the cable 350.

FIG. 5A illustrates comparison circuitry 320 according to an embodiment of the invention. As shown, the comparison circuitry 320 includes a comparator 500. The comparator 500 receives (a) the DC power signal from the DC power source 305, and (b) a reference voltage, V_{ref} . The comparator outputs V_{data} based on whether the magnitude of the DC power from the DC power source exceeds V_{ref} as described above with respect to FIG. 3.

FIG. 5B illustrates comparison circuitry 320 according to an additional embodiment of the invention. As shown, the comparison circuitry 320 includes a processor 505. The processor 505 receives (a) the DC power signal from the DC power source 305, and (b) value of a reference voltage stored in memory. The processor 505 then outputs V_{data} based on whether the magnitude of the DC power from the DC power source exceeds V_{ref} as described above with respect to FIG. 3. The processor 505 may output a single high or low voltage (e.g., 5.0 Volts or 0.0 Volts) based on the detected DC power source. Alternatively, the processor 505 may output a stream of bits to indicate the DC power source.

FIG. 6 illustrates an electronic device 335 according to an embodiment of the invention. As shown, the electronic device 335 may receive GND, V_{out} and V_{data} from the tip 330. V_{data} may be received by a controller 360. The controller 360 may disable battery charging circuitry 600 of the electronic device 335 from charging batteries when V_{data} is indicative of the EMPOWER outlet. Alternatively, the controller 360 enables battery charging circuitry 600 so that the batteries of the electronic device may be charged based on the value of V_{data} .

FIG. 7A illustrates a method of determining and outputting V_{data} according to an embodiment of the invention. The processing shown in FIG. 7A may be implemented by the adapter 340. First, DC power is received 700 from the DC power source 305. Next, the comparison circuitry determines 705 whether the magnitude of the voltage of the DC power received is greater than V_{ref} . If "no," the comparison circuitry determines the DC power source 305 to be an automobile cigarette lighter outlet, and processing proceeds to operation 710, where V_{data} is output with a signal/voltage magnitude indicating that the DC power source 305 is the automobile cigarette lighter outlet. Processing then returns to operation 700. If "yes," at operation 705, processing proceeds to opera-

6

tion 715, where V_{data} is output with a signal/voltage magnitude indicating that the DC power source 305 is the EMPOWER airplane outlet.

FIG. 7B illustrates a method of receiving V_{data} and allowing power to flow to devices within the electronic device 335 based on V_{data} according to an embodiment of the invention. First, the electronic device 335 receives 720 the V_{data} signal. As discussed above, the V_{data} signal is sent from the adapter 340 through the tip 330 and over to the control circuitry 365 of the electronic device 335. Next, based on the V_{data} signal, a first set of predetermined devices may be prevented 725 from receiving power. For example, if the electronic device 335 is a notebook computer, the control circuitry 365 may prevent batteries from recharging if V_{data} indicates that the DC power source is the EMPOWER airplane outlet. Other devices/components in the electronic device 335 may also be prevented from receiving power or from functioning in a certain way.

At operation 730, a second set of predetermined devices may be allowed to receive power based on the V_{data} signal. For example, if V_{data} indicates that the DC power source is an automobile cigarette lighter outlet, then power may be available to batteries of the electronic device 335 to allow recharging. Other devices/components in the electronic device 335 may also be allowed to receive power or function in a particular way.

In embodiments described above, the V_{data} signal may be used to send a signal to the control circuitry 365 indicating the DC power source. This signaling may be done via a discrete bit, an analog signal, a data signal line, an analog voltage, or via any other suitable manner. The V_{data} signal may be transmitted from the adapter 340 to the tip 330 and electronic device 335 via a single signaling line or multiple signaling lines.

FIG. 8 illustrates a power supply system 800 according to an embodiment of the invention. The power supply system 800 is similar to the power supply system 301 shown in FIG. 3. However, unlike the power supply system 301, in which the adapter 340 itself contains comparison circuitry 370, the adapter 340 of power supply system 800 does not contain the comparison circuitry 805. Instead, a regular adapter 340 may be used and the electronic device 335 itself includes the comparison circuitry 805 for determining the DC power source. The electronic device 335 may be a notebook computer and may implement the methods shown in FIGS. 7A and 7B.

FIG. 9A illustrates a tip according to an embodiment of the present invention. The tip 900 includes control circuitry 902 and a controller 950. The tip 900 is coupled to an adapter 940 and may have a cable disposed between the adapter 940 and the tip 900. The adapter 940 transmits V_{out} and GND to the tip 900. In an embodiment of the invention, digital or analog control circuitry 902 transmits a programming signal or a control signal to the adapter 940. In an embodiment of the invention, digital or analog control circuitry 902 may transmit a plurality of programming signals to the adapter. Illustratively, digital or analog control circuitry 902 may transmit a voltage control signal to regulate the voltage output (V_{out}) from the adapter 940. The digital or analog control circuitry 902 may also transmit a current control signal to limit the current output from the adapter 940. The V_{out} and GND signals are passed through the adapter 940 to the electronic device 935, such as a laptop, PDA, or cellular phone, to provide power to the electronic device.

In an embodiment of the invention, the tip 900 may also receive a value, which is illustrated by reference numeral 980 in FIG. 9A. The value may be representative of whether or not

the power adapter is an approved adapter which can be connected to an electronic device **935**. For example, for safety reasons, certain digital music player or laptop manufacturers only desire to have certain manufacturers' power adapter connected to their system. Accordingly, the power adapter may transmit a value that indicates that the power adapter **940** is approved for powering the electronic device. Alternatively, the value may be representative of a maximum power output that is available at the time from the power adapter. For example, the value may represent that only 70 watts of power are available from the power adapter because the power adapter has been limited to that output power. Instead of receiving a value from the power adapter, the tip **900** may receive a character string. The character string may identify whether or not the power adapter is an approved adapter for powering the electronic device **935**. The value or the character string may be received at input connector **985** of the tip **900**. The input connector **985** may receive the value or character string and may pass through this signal or information to the output connector **990**. Under certain operating conditions, there may be no modification of the value or character string in the tip **900**. The output connector **990** is coupled to the electronic device **935** and passes the value or character string to the electronic device. A conductor **995** may couple the input connector **985** to the output connector **990**.

FIG. 9B illustrates an alternative embodiment of a tip according to an embodiment of the invention. In an embodiment of the invention, the tip **900** may include a controller **950**, wherein the controller **950** includes a receiver **952**, a memory **954**, and a transmitter **956**. In an alternative embodiment of the invention, a programmable Dallas Semiconductor programmable memory (i.e., DS2502) may be substituted for a controller and may include the receiver **952**, memory **954**, and transmitter **956**. The receiver **952** may receive a signal from the electronic device **935**. The signal may be a request from the electronic device **935** to interrogate the tip **900** and identify whether or not an approved power adapter **940** is coupled to the tip **900** and thus the electronic device **935**. Once the controller **950** receives the request from the electronic device **935**, the controller **950** extracts a character string from the memory **954** and utilizes the transmitter **956** to transmit the character string to the electronic device **935**. The character string is representative of the power adapter to which the tip **900** is coupled. In an embodiment of the invention, a microcontroller may be programmed and could be utilized in place of the transmitter **956**, a receiver **952**, and a memory **954**. The character string may represent that the power adapter **940** and/or tip **900** is approved to be connected to the electronic device, e.g., a laptop or a cellular phone. Under certain operating conditions, the character string represents that a rechargeable battery within the electronic device can be charged by the power adapter **940** and tip **900** combination. Under certain operating conditions, the character string is indicative of a maximum power available from the power adapter. Under certain operating conditions, a value can be stored in the memory **954** where the value is indicative for the maximum power available from the power adapter. Illustratively, the value may be a power (or wattage) value or a current value.

The transmitter **956** may communicate with the electronic device **935** via a one-wire interface. The transmitter **956** may communicate with the electronic device **935** via other communication protocols, including serial communication protocols.

FIG. 10 illustrates a second embodiment of a tip according to an embodiment of the invention. The tip **900** may include an analog or digital control circuitry **910**, a controller **950**, and

measurement circuit **960** (e.g., a voltage sense circuit or a current sense circuit). The measurement circuit **960** may measure a magnitude level of a programming or control signal e.g., ($V_{Iprogram}$), that is being transmitted to the power adapter **940**. In an embodiment of the invention, the programming or control signal has a value representative of a maximum current available to be output by the adapter **940**. For example, a voltage magnitude of the programming or control signal identifies a value of current (e.g., in amperes) that the power adapter is available to output. Illustratively, each 0.5 volts in the programming or control signal may represent one amp of current that the power adapter can output. A programming or control signal having a magnitude of 2.5 volts represents that the power adapter is limited to output 5 amperes and the power output is limited to 100 watts (if the fixed voltage output is 20 volts). The measurement circuit **960** may be implemented using a comparator or a number of comparators that compare a voltage level of the control signal to a reference voltage level or a number of reference voltages.

In an alternative embodiment of the invention, the measurement circuit **960** may be implemented by an analog-to-digital converter. The analog-to-digital converter may measure a value of the control signal or the programming signal and identify the value which is representative of the power available to be output from the power adapter. In an embodiment of the invention, the analog-to-digital converter may be used in conjunction with a microcontroller. The analog-to-digital converter may be separate from the microcontroller or the analog-to-digital converter may be incorporated into the microcontroller.

The measurement circuit **960** takes the measured magnitude level of the programming or control signal and sends the information to the controller **950**. A memory **954** may store a plurality of character strings. Alternatively, the memory **954** may store a plurality of values. Each of the plurality of character strings or values may represent a potential power output level of the power adapter **940**. For example, one character string may be represent that the power adapter can output 90 watts while another character string represents that the power adapter can output 140 watts. The controller **950** receives the magnitude level of the programming/control signal from the measurement circuit **960** and selects the corresponding character string stored in the memory **954**. Alternatively, the controller receives the magnitude level of the programming or control signal and selects the corresponding value stored in the memory **954**.

After the corresponding character string or value is selected, the corresponding character string is transmitted to the electronic device **935** through the transmitter **956**. The electronic device receives the character string and acts in response to the received character string or value. For example, the character string may indicate that the power adapter coupled to the tip (which is connected to the electronic device) can output 75 watts. Based on this information, a controller in an electronic device **935** (e.g., a laptop) may prevent the power adapter from charging the rechargeable battery within the electronic device **935** because the electronic device **935** may require all of the 75 watts of power.

The controller **950** may be a microcontroller. The controller **950** including the receiver **952**, transmitter **956**, and memory **954** may be a semiconductor memory chip such as a Dallas Semiconductor DS2502 programmable memory. The receiver **952** and transmitter **956** may communicate with the electronic device via a number of protocols, e.g., the one-wire interface communication protocols, a serial interface communication protocol, etc.

FIG. 11 illustrates an alternative embodiment of a power supply system utilizing DC power source comparison circuitry according to an embodiment of the present invention. FIG. 11 is similar to the power supply system illustrated in FIG. 3 and also includes a microcontroller 950 in the tip 330. In FIG. 11, the microcontroller 950 receives a signal from the power adapter 340 in addition to the V_{out} signal and ground signal. The power source determination signal may be referred to as a V_{data} signal and may be generated by the comparison circuitry 320 in the adapter. The power source determination signal may identify a power capability of the external power source is an external automobile DC power source, an external AC power source, or an external airplane DC power source. For example, the power source determination signal may identify that the power adapter is connected to an external airplane DC power source and is limited to a number of watts of output, e.g., 50 or 60 watts of power. Alternatively, the power source determination signal may identify that the power adapter is connected to an external automobile power source, e.g., 90 watts or 100 watts.

The microcontroller 950 may receive the power source determination signal. Based on the received power source determination signal, the microcontroller 950 may extract a character string corresponding to the received power source determination signal from a memory. The memory 954 (see FIGS. 9A, 9B, and 10), as noted before, may store a number of character strings. Alternatively, the memory 954 may store a number of values and the microcontroller 950 may select one of the number of values. Although FIG. 11 does not illustrate that the microcontroller includes the memory 954, receiver 952, and transmitter 956, the microcontroller 950 may incorporate these components. Alternatively, the memory 954, receiver 952, and transmitter 956 may be located in devices outside of the controller 950 (e.g., not incorporated therein). The number of character strings or values may each represent a different power capability of the power adapters which can be coupled to the tip via a cable. Illustratively, one character string or value may represent a 90 watt power adapter, one character string may represent a 130 watt power adapter, one character string may represent a 70 watt power adapter, and one character string may represent that the power adapter has a limited power supply capability, e.g., less than 70 watts.

In an embodiment of the invention, no character string or value may be transmitted if the power adapter cannot generate a certain wattage of power. This may represent that the power adapter and tip cannot be utilized to charge the battery of the electronic device. The microcontroller 950 may transmit the selected character string to the electronic device. A controller 360 in the electronic device may receive the selected character string and may perform a plurality of actions based on the selected character string. For example, if the selected character string identifies that the power adapter has a limited power

capability, e.g., less than 50 watts or 70 watts, the controller 360 may place the electronic device in a mode of low power consumptions, e.g. turning off display earlier or not allowing charging of the battery in the electronic device. Under other operating conditions, the character string or value may identify that an AC adapter is the external power source and can provide 130 Watts, and the controller 360 may allow the battery in the electronic device to be charged by the power adapter and place the electronic device in a high power consumption mode, e.g., brightness of screen and hard drive.

Under certain operating conditions, rather than a character string, the microcontroller 950 may have a number of current levels that represent different power capabilities of adapters. Illustratively, in other words, a first current level may represent that the power adapter 340 can supply 130 watts, a second current level may represent that the power adapter 340 can supply 90 watts, a third current level represents that the power adapter 340 can supply 70 watts, and a fourth current level may represent the power adapter 340 supplies less than 70 watts.

While the description above refers to particular embodiments of the present invention, it will be understood that many modifications may be made without departing from the spirit thereof. The accompanying claims are intended to cover such modifications as would fall within the true scope and spirit of the present invention. The presently disclosed embodiments are therefore to be considered in all respects as illustrative and not restrictive, the scope of the invention being indicated by the appended claims, rather than the foregoing description, and all changes which come within the meaning and range of equivalency of the claims are therefore intended to be embraced therein.

What is claimed is:

1. Power supply equipment comprising:

an adapter to convert power from a power source, external to the adapter, to DC power for powering an electronic device, the adapter including circuitry for producing an analog data signal for use by the electronic device to control an amount of power drawn by the electronic device; and

a cable having proximal and distal ends, the proximal end being electrically coupled to the adapter and the distal end terminating in an output connector, the output connector including:

a plurality of conductors to transfer the DC power and the analog data signal to the electronic device; and circuitry to receive a data request from the electronic device and in response transmit a data output to the electronic device to identify the power supply equipment to the electronic device.

2. The power supply equipment of claim 1 wherein the output connector can be detached from the cable.

* * * * *