



JACLO®

Confidence from start to finish.™

129 DERMODY STREET
CRANFORD, NJ 07016



T 800.852.3906
F 800.852.4133
E orders@jaclo.com
W jaclo.com

CREATED &
PRINTED IN NJ

CATALOG-2014
\$20.00



Packages shown are representative of Decorative Specialties and our full line of products.

JACLO®

Confidence from start to finish.™

PAGE 4-5 FINISHES + POLICIES

PAGE 6-21 TABLE OF CONTENTS

TAB ① FAUCET COLLECTIONS, ROMAN TUBS + ACCESSORIES

TAB ② SHOWER TRIM, TUB + SHOWER VALVES + SPOUTS

TAB ③ SHOWERHEADS, ARMS + ESCUTCHEONS

TAB ④ HANDSHOWERS, HOSES, BIDET + HANDSHOWER ACCESSORIES

TAB ⑤ GRAB BARS/DOOR PULLS + GRAB BARS FOR HANDSHOWERS

TAB ⑥ DECORATIVE SPECIALTIES (Supply Valves, P Traps, Tub + Shower Drains)

TAB ⑦ CHANNEL DRAINS

TAB ⑧ SPA COLLECTION (Water Features)

TAB ⑨ REPLACEMENT PARTS

TAB ⑩ GENERAL INFORMATION

TAB ⑪ PRICING INDEX + GLOSSARY

TAB ⑫ STEAM VALVE ORIGINAL (Luxury Stainless Steel Kitchen Faucets)

JACLO®

Confidence from start to finish.®

JACLO'S FINISHES BLEND WITH & COMPLEMENT:

- The **JACLO Polished Gold™** finish blends with and complements **Vibrant® Moderne Polished Gold** *
- The **JACLO Satin Gold™** finish blends with and complements **Vibrant® Moderne Brushed Gold** *
- The **JACLO Bronze Umber™** finish blends with and complements **Vibrant® Brushed Bronze** *
- The **JACLO Tristan Brass™** finish blends with and complements **Tuscan Brass®****
- The **JACLO Europa Bronze™** finish blends with and complements **English Bronze®****
- The **JACLO Vintage Bronze™** finish blends with and complements **Venetian Bronze®*****
- The **JACLO Jewelers Gold™** finish blends with and complements **Antique Gold Finishes**
- The **JACLO Caramel Bronze™** finish blends with and complements **Champagne Bronze®******

* **Vibrant®** is a federally registered trademark owned by the Kohler Co. for its brand of finish. There is no affiliation, license, sponsorship, or connection between JACLO and/or its products and the Kohler Co. or its products. JACLO's use of the **Vibrant®** mark is solely for purposes of product comparison.

** **Tuscan Brass®** and **English Bronze®** are federally registered trademarks owned by the Rohl, LLC, for its brand of finish. There is no affiliation, license, sponsorship, or connection between JACLO and/or its products and the Rohl, LLC, or its products. JACLO's use of the **Tuscan Brass®** and **English Bronze®** mark is solely for purposes of product comparison.

*** **Venetian Bronze®** is a federally registered trademark owned by the Masco Corporation for its brand of finish. There is no affiliation, license, sponsorship, or connection between JACLO and/or its products and the Masco Corporation or its products. JACLO's use of the **Venetian Bronze®** mark is solely for purposes of product comparison.

******Champagne Bronze®** is a federally registered trademark owned by the Delta Corporation for its brand of finish. There is no affiliation, license, sponsorship, or connection between JACLO and/or its products and the Delta Corporation or its products. JACLO's use of the **Champagne Bronze®** mark is solely for purposes of product comparison.

JACLO OFFERS THE MOST DIVERSE PRODUCT LINE IN THE INDUSTRY FOR YOUR ENTIRE PROJECT, INCLUDING:



SHOWER SPECIALTIES



FAUCETS



GRAB BARS & HANDLES



DECORATIVE SPECIALTIES™



ACCESSORIES



CHANNEL DRAINS

FINISHES

NOT ALL FINISHES ARE AVAILABLE ON EVERY PRODUCT. CHECK INDIVIDUAL PRODUCT LISTING FOR FINISH AVAILABILITY.

Chrome



Polished Chrome
PCH

Price Group A



Oil-Rubbed Bronze
ORB



Satin Chrome
SC



Satin Nickel
SN



Polished Nickel
PN



Vintage Bronze
VB

Price Group B



Antique Brass
AB



Black Nickel
BKN



Bronze Umber
BU



Caramel Bronze
CB



Matte Black
MBK



Polished Brass
PB



Satin Brass
SB



Sedona Beige
SDB



White
WH

Price Group C



Antique Copper
ACU



Europa Bronze
EB

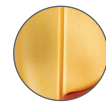

Jewelers Gold
JG

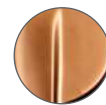

Polished Copper
PCU



Pewter
PEW



Polished Gold
PG



Satin Gold
SG



Tristan Brass
TB

JACLO finishes chart shown for reference only. Finish samples available upon request.

CUSTOM FINISHES



Unlacquered Brass
ULB

JACLO offers custom finish capabilities. Contact factory for availability & pricing.

Over Fifty Years of Excellence Proud to be an American Company



CARE INSTRUCTIONS

In order to maintain the high quality finish of JACLO products, please adhere to the following product care instructions:

Cleaning JACLO products: For routine cleaning, simply use a soft damp cloth and common household soap, then rinse and dry. Proper care of your product is important because most water contains calcium that deposits on surfaces, forming unpleasant spots. This can be avoided by routine cleaning and drying after every use. Use only mild soap based detergents.

Never use abrasive cleaners, bleach, disinfectants or cleaning products containing alcohol, ammonia, hydrochloric or phosphoric acids as they will damage the product finish.

Please note: Your product warranty may not be valid if the above cleaning guidelines are not followed.

The use of water softeners, which are loaded with salt, will destroy any finish in time. Use of water softeners void all warranties.

WARRANTY

Residential Warranty: Your new plumbing fixture is warranted by JACLO INDUSTRIES, 129 Dermody Street, Cranford, NJ 07016. This warranty is extended to original consumer purchasers only. This warranty gives you specific legal rights, and you may also have other rights which vary from state to state.

The product (including the finish on the product but excluding any custom finishes and any installation hardware not supplied by JACLO) is warranted to be free from defects in material or workmanship under normal use and service for the lifetime* of the fixture, so long as the original consumer purchaser owns it. JACLO's sole obligation under this or any other warranty is limited to repairing or replacing at JACLO's option, without labor, any part or parts of the fixture which fall to conform to such warranty.

JACLO WILL NOT BE LIABLE FOR ANY CONSEQUENTIAL OR INCIDENTAL DAMAGES CAUSED BY A BREACH OF THIS OR ANY OTHER WARRANTY.

Some states do not allow the exclusion of limitation of incidental or consequential damages, so the above limitation may not apply to you.

To secure warranty performance, the original consumer purchaser must have the fixture properly and professionally installed in accordance with all codes and installation instructions.

Items and actions that will void the JACLO warranty are:

- Abuse, misuse, neglect and accidental damage
- Improper cleaning care of maintenance of the fixture
- Alteration of the fixture in any way including removal of a flow regulator/restrictor

All warranty claims must be made in accordance with the JACLO return policy (see below).

JACLO does not authorize any distributor, retailer or other person to modify this warranty or assume any liability on its behalf with respect to it. Any question regarding the operation of warranty should be addressed to JACLO's warranty department.

*Due to the unpredictable environment, all kitchen drains, strainers and garbage disposal flanges are warranted for the period of one year from date of purchase from an authorized JACLO dealer

Commercial Warranty: JACLO extends the above warranty for a period of one year from date of purchase to purchasers of products for industrial, commercial, business and all non-private residential uses.

JACLO RETURN, SHIPMENT, DAMAGE, SHORTAGE CLAIM POLICY & CHANGES IN DESIGN

All returns must be accompanied by a JACLO Return Goods Authorization (RGA). Please contact JACLO customer service for instructions on obtaining a return authorization. Once the product(s) are returned they will be subject to inspection by the JACLO returns department. Pending the results of the inspection final disposition may be one of the following:

- Full credit, i.e. Manufacturer defect (see limited lifetime warranty), shipped in error and is in a resell condition
- Credit with 25% restock charge for returned product six months old or less. 50% restock charge for returned product over six months old. Minimum return value \$25 net.
- No credit, product returned cannot be resold in its current condition and does not fall under JACLO's warranty
- A return authorization will not be issued on a product that is discontinued or over one year old from date of sale

Credit for original part is subject to the return and disposition of original item.

All returned items declared "No credit" will be disposed of after 30 days from date of receipt by JACLO.

All custom items are subject to final sale and cannot be returned for credit.

All replacement product will be shipped and invoiced.

All shortage and damage claims must be made within 7 days of receipt of the shipment.

All drop shipments subject to a \$7 charge.

The Company is constantly striving to effect improvements in its products. This may require the changes be made from time to time with respect to the design of its products. Therefore, the Company reserves the right to affect reasonable changes of any kind without notice and to deliver revised products in fulfillment of any accepted order unless this right is specifically waived on the face of the Consumer's Acknowledgment.

JACLO prides itself in striving for design excellence and is a member of these fine industry trade associations:



TAB ① FAUCET COLLECTIONS, ROMAN TUBS + ACCESSORIES

FAUCET COLLECTIONS (HANDLE STYLES BELOW) +



Roaring 20's
Collection



Pages 25-32

Westfield
Collection



Pages 33-42

Cranford
Collection



Pages 43-50

Jaylen
Collection



Pages 51-58

Astor
Collection



Pages 59-68

Contempo
Collection



Pages 69-76

Cubix®
Collection



Pages 77-83

Table of Contents:

TAB ① FAUCET COLLECTIONS, ROMAN TUBS + ACCESSORIES

ROMAN TUBS + ACCESSORIES

PAGES 25-84

Pages 25-32

**Roaring 20's
Collection**



Pages 33-42

**Westfield
Collection**



Pages 43-50

**Cranford
Collection**



Pages 51-58

**Jaylen
Collection**



Pages 59-68

**Astor
Collection**



Pages 69-76

**Contempo
Collection**



Pages 77-83

**Cubix®
Collection**



Components/Accessories for Roman Tubs



Page 84

ROUGH BRASS VALVES FOR TUB & SHOWER



PAGES 87-93

Thermostatic Valves

Part #: J-TH34
Part #: J-TH12



Page 87

Exacto™ Volume Controls

Part #: J-VC34
Part #: J-VC12



Page 87

Diverter

Part #: 20682 (3 way w/ shared functions)
Part #: 20686 (2 way w/ shut off) **CALGreen**
Part #: 20688 (3 way w/ shut off) **CALGreen**



Page 87-88

Thermostatic Valve with Built in Diverter—CALGreen

Part #: J-TH34-686 (Built in 2 way w/ shut off)
Part #: J-TH34-688 (Built in 3 way w/ shut off)



Page 89

Tub & Shower Controls

Part #: J-THVC12 (Thermostatic w/ volume control)
Part #: J-DIV-CSV (Pressure balance valve w/ diverter)



Page 90

Pressure Balance Valve Cycling Valve

Part #: J-CSV



Page 91

Pressure Balancing Valve

Part #: J-PBV

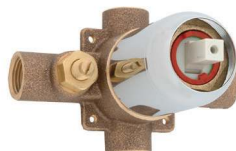

Page 91

Extension Kits & Replacement Cartridges for Valves



Pages 92-93

Table of Contents:

TAB ② SHOWER TRIM, TUB VALVES, TRIM + SPOUTS







BRASS TRIMS FOR TUB & SHOWER ROUGH VALVES		PAGES 94-108
<p>FOR THERMOSTATIC VALVES</p> <p>J-TH34 J-TH12</p>	<p><i>30+ OPTIONS</i></p> 	<p>Pages 94-97</p>
<p>FOR VOLUME CONTROL & DIVERTER VALVES</p> <p>J-VC34 J-VC12 J-20682 J-20686 J-20688</p>	<p><i>20+ OPTIONS</i></p> 	<p>Pages 98-100</p>
<p>FOR THERMOSTATIC VALVE WITH BUILT IN 2 WAY OR 3 WAY DIVERTER VALVE</p> <p>J-TH34-686 J-TH34-688</p>	<p><i>10+ OPTIONS</i></p> 	<p>Page 101</p>
<p>FOR TUB & SHOWER VALVES</p> <p>J-THVC12 J-DIV-CSV</p>	<p><i>20+ OPTIONS</i></p> <p>Thermostatic valves with volume control</p> <p>Pressure balance valves with diverter</p> 	<p>Pages 102-104</p>
<p>FOR PRESSURE BALANCE VALVE CYCLING VALVES</p> <p>J-CSV</p>	<p><i>30+ OPTIONS</i></p> 	<p>Page 105</p>
<p>FOR PRESSURE BALANCE VALVE</p> <p>J-PBV</p>	<p><i>15+ OPTIONS</i></p> 	<p>Page 106</p>

Table of Contents: *CONTINUED* **TAB ② SPOUTS & TAB ③ SHOWERHEADS, ARMS + ESCUTCHEONS**

TUB SPOUTS/TUB FAUCETS

PAGES 109-114

Tub Spouts/
Tub Faucets



Pages 109-114

SHOWERHEADS

40+ OPTIONS



PAGES 117-132

The Rain Machine®
(Performs at any angle)



Pages 117-122

Traditional Rainheads



Pages 123-124

Flood Heads



Page 125

Decorative Multifunction



Pages 126-129

Economy Series



Page 130

Rain Bar/Body Sprays



Pages 131-132

Table of Contents:

TAB ③ SHOWERHEADS, ARMS + ESCUTCHEONS

BRASS SHOWERARMS + DROP NIPPLES

PAGES 133-138

45°, 60°, 90°



Pages 133-135

Custom Capabilities

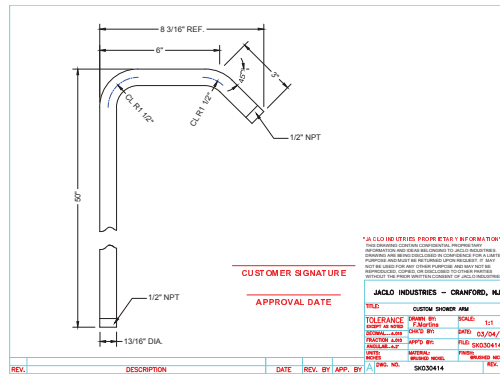

Page 135

Square



Page 136

Deluxe



Page 137

Drop Nipples



Pages 136-138

Fittings

Page 142

Shower Curtain Rod



Page 143

BRASS ESCUTCHEONS

PAGES 139-141

Escutcheons
(Fit All)



Pages 139-141

TAB ④ HANDSHOWERS, HOSES, BIDET + ACCESSORIES

HANDSHOWERS *30+ OPTIONS*



PAGES 147-154

Transitional



Pages 147-149

Contemporary



Pages 150-151

Traditional



Page 152

Economy



Pages 153-154

BIDET SPRAYS & KITS

PAGES 155-158

Handheld & Kits



Pages 155-158

HANDSHOWER HOSES (UNIVERSAL FIT)

PAGES 159-162

Square, Double Spiral, Brass, Stretch Flex, Stainless Steel, Stretch Stainless Steel



Pages 159-162

TAB ④ HANDSHOWERS, HOSES, BIDET + ACCESSORIES

(EXAMPLES SHOWN)

HANDSHOWER ACCESSORIES

PAGES 163-176

Pause Controls & Diverters



Page 164

Showerarm Mounts/Wall Brackets



Pages 165-167

Supply Elbows with
Handshower Mounts



Pages 168-169

Water Supply Elbows



Page 170

Sliderrails for Handshowers



Pages 171-176

Table of Contents:
TAB ⑤ GRAB BARS/DOOR PULLS

GRAB BARS (THESE & MORE)

PAGES 179-202

Luxury Classic Bars 

Page 179



"L" Bars 

Page 180



"T" Bars 

Page 181



Inside Corner Bars 

Pages 182- 183



Grab Bar Handshower Sliders

Page 186-187



Page 193

Page 195

Page 197

Table of Contents:
TAB 5 GRAB BARS/DOOR PULLS

GRAB BARS (CONTINUED)

PAGES 179-202

**Grab Bar with Toilet Paper
 or Towel Holder**



Page 188

Page 194

Page 196

**Luxury Modern &
 Collections**

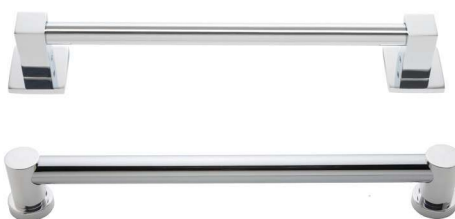

Pages 192-197

Deluxe Bars &



Pages 198-199

Commercial Stainless Steel &



Pages 200-202

Door Pulls



Pages 190-191

Page 193

Page 195

Page 197

Table of Contents:
TAB 6 DECORATIVE SPECIALTIES

TOILET TANK LEVERS

PAGES 206-219

To Fit:

Toto, Kohler, Porcher,
 American Standard, Gerber,
 St. Thomas, Mansfield, Eljer, Icera



Pages 206-219

FAUCET & TOILET SUPPLY VALVES



PAGES 221-232

Quarter Turn Angle Pattern



221-223, 226

Quarter Turn Straight Pattern



224-225, 227

Compression Style Angle Pattern



228-229

Compression Style Straight Pattern



230-232

FAUCET & TOILET SUPPLY TUBES

PAGES 233-235

JACLOflex®

Stainless Steel Braided Supply Line
 with Decorative Covers



PATENT PENDING

Pages 233

Faucet Supply Tubes



Page 234

Toilet Supply Tubes



Page 235

FAUCET SUPPLY KITS



PAGES 236-250

Quarter Turn (Angle & Straight Pattern)



236-240, 246

Compression Style (Angle & Straight Pattern)



248-250

TAB 6 DECORATIVE SPECIALTIES

TOILET SUPPLY KITS



PAGES 241-253

Quarter Turn (Angle & Straight Pattern)



241-245, 247

Compression Style (Angle & Straight Pattern)



251-253

ESCUTCHEONS & ACCESSORIES

PAGES 254-255

Escutcheons & Accessories
(FOR SUPPLY KITS)



254-255

LAVATORY DRAINS



PAGES 256-258

Grid, Finger Touch Plug, Finger Touch Round, Finger Touch Round European



Page 256

Finger Touch Square, Stationary Round, Stationary Round European, Stationary Square, Stationary Square European, Finger Touch Square European



Page 257

Lift & Turn, Tear Drop, Wide 7 Hole Grid



Page 258

LAVATORY BASIN POP-UP DRAINS (P.O. & C.O.)

259

Fully Plated & Standard Pattern, Fully Plated Counterop, Extension



Page 259

Table of Contents:
TAB 6 DECORATIVE SPECIALTIES

TUBULAR BRASS & TRAPS **260-266**

Lavatory Traps,  Extra Long Wall Bends		Pages 260-263
--	--	----------------------

Extension Tubes, Offsets, Cover Tubes, Slip Elbows, Couplings, Brass Nuts		Pages 264-266
--	--	----------------------

BRASS TUB DRAINS & CONVERSION TRIM KITS **267-273**

Trip Lever & Grid Drain		Pages 267-268
-------------------------	--	----------------------

Square & Round Contemporary Toe Control		Pages 267, 269
--	--	-----------------------

Lift & Turn		Page 270
-------------	--	-----------------

Toe Control Style		Page 271
-------------------	--	-----------------

Toe Control Extra Long Threads for Thick Tubs		Pages 272-273
--	--	----------------------

CABLE DRAINS (GEBERIT & JACLO) **274-277**

Brass Trim, PVC Tubular & Schedule 40 PVC & ABS Schedule 40, PVC & ABS Schedule 40 & Brass Tubular, Pivot Overflow		274-277
---	--	----------------

Table of Contents:
TAB ⑥ DECORATIVE SPECIALTIES

ALL BRASS DRAINS & TRIM

278-281

All Brass Tub Drains



Pages **278-281**

SHOWER DRAINS & ACCESSORIES

282-284

Shower Drain Plates



Pages **282-283**

Complete Shower Drains



Page **284**

KITCHEN DRAINS & ACCESSORIES

285-294

Waste Disposal Air Switch



Page **285**

Strainers, Baskets, etc.



Pages **286-292**

Soap & Lotion Dispensers



Page **293**

Table of Contents:
TAB 7 CHANNEL DRAINS

CHANNEL DRAINS (LINEAR DRAINS)  **PAGES 297-306**

Standard
 (SUB DRAIN MODEL)



Page 298

zeroEDGE
 (NO SUB DRAIN MODEL)



Page 299

zeroEDGE Slim
 (NO SUB DRAIN MODEL)



Page 302

Square



Page 303

Grates



Pages 300-301
 Pages 302-303

Sub Drains



PVC ABS CAST IRON

Page 298, 303

Table of Contents: **TAB ⑧ SPA COLLECTION, TAB ⑨ PARTS, TAB ⑩ GENERAL INFO, TAB ⑪ INDEX, TAB ⑫ SVO**

⑧ SPA COLLECTION (WATER FEATURES)

PAGES 309-320



Pages
309-320

⑨ REPLACEMENT PARTS

PAGES 323-331



Pages 323-331

⑩ GENERAL INFORMATION

Page 333

⑪ PRICING INDEX + GLOSSARY

Pages 337-354

⑫ STEAM VALVE ORIGINAL



Page 355

Don't Forget JACLO has:



PAGE 4-5 FINISHES + POLICIES

PAGE 6-21 TABLE OF CONTENTS

TAB ① FAUCET COLLECTIONS, ROMAN TUBS + ACCESSORIES

TAB ② SHOWER TRIM, TUB + SHOWER VALVES + SPOUTS

TAB ③ SHOWERHEADS, ARMS + ESCUTCHEONS

TAB ④ HANDSHOWERS, HOSES, BIDET + HANDSHOWER ACCESSORIES

TAB ⑤ GRAB BARS/DOOR PULLS + GRAB BARS FOR HANDSHOWERS

TAB ⑥ DECORATIVE SPECIALTIES (Supply Valves, P Traps, Tub + Shower Drains)

TAB ⑦ CHANNEL DRAINS

TAB ⑧ SPA COLLECTION (Water Features)

TAB ⑨ REPLACEMENT PARTS

TAB ⑩ GENERAL INFORMATION

TAB ⑪ PRICING INDEX + GLOSSARY

TAB ⑫ STEAM VALVE ORIGINAL (Luxury Stainless Steel Kitchen Faucets)

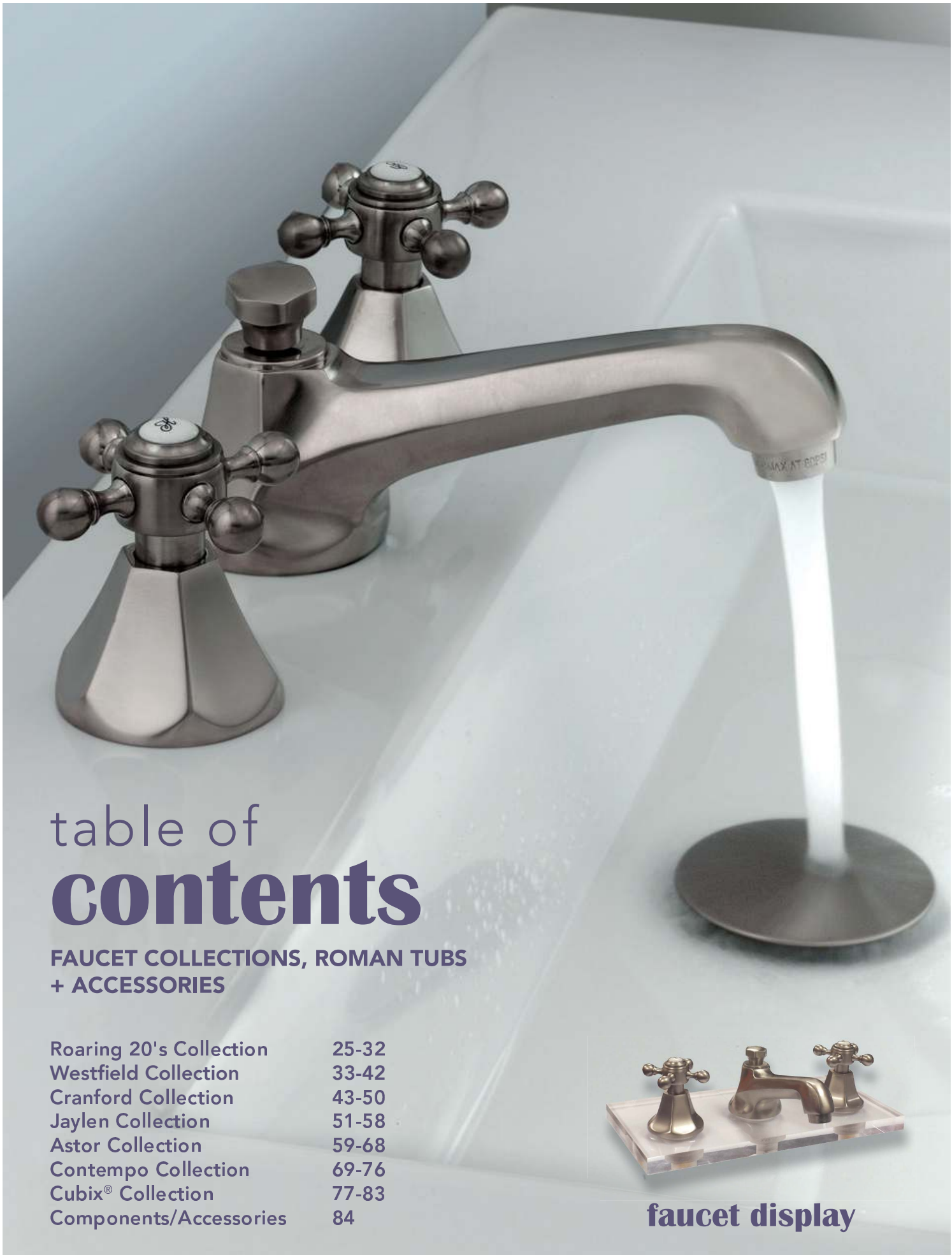

table of contents

FAUCET COLLECTIONS, ROMAN TUBS + ACCESSORIES

Roaring 20's Collection	25-32
Westfield Collection	33-42
Cranford Collection	43-50
Jaylen Collection	51-58
Astor Collection	59-68
Contempo Collection	69-76
Cubix® Collection	77-83
Components/Accessories	84



faucet display

FAUCET COLLECTIONS, ROMAN TUBS + ACCESSORIES



Roaring 20's Collection

Pages 25-32



Westfield Collection

Pages 33-42



Cranford Collection

Pages 43-50



Jaylen Collection

Pages 51-58



Astor Collection

Pages 59-68



Contempo Collection

Pages 69-76



Cubix® Collection

Pages 77-83





Roaring 20's Collection



HANDLE STYLES



T678



T676



T674



T675



T679



T692



T667

ROARING 20'S FAUCETS

8"–12" WIDESPREADS



ITEM	CHROME	GROUP A	GROUP B	GROUP C
7830-T678-	\$595.00	\$645.00	\$745.00	\$875.00

- All brass 8"-12" widespread faucet includes brass pop-up drain
- ¼ turn ceramic valves
- Swivel spout with water saving 1.5 GPM aerator

INCLUDES BOTH:

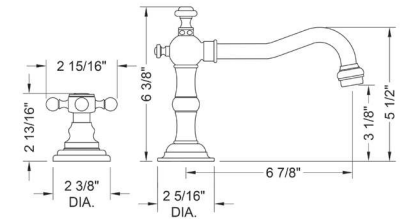
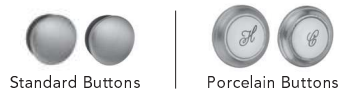

ITEM	CHROME	GROUP A	GROUP B	GROUP C
7830-T674-	\$595.00	\$645.00	\$745.00	\$875.00

- All brass 8"-12" widespread faucet includes brass pop-up drain
- ¼ turn ceramic valves
- Swivel spout with water saving 1.5 GPM aerator
- ADA compliant levers

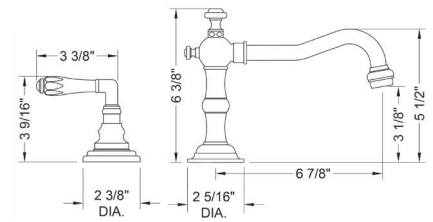

ITEM	CHROME	GROUP A	GROUP B	GROUP C
7830-T692-	\$595.00	\$645.00	\$745.00	\$875.00

- All brass 8"-12" widespread faucet includes brass pop-up drain
- ¼ turn ceramic valves
- Swivel spout with water saving 1.5 GPM aerator
- ADA compliant levers

INCLUDES BOTH:

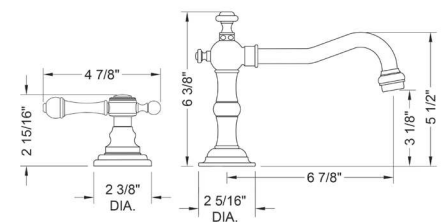
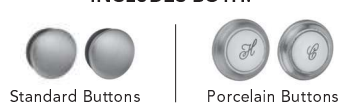

ITEM	CHROME	GROUP A	GROUP B	GROUP C
7830-T676-	\$595.00	\$645.00	\$745.00	\$875.00

- All brass 8"-12" widespread faucet includes brass pop-up drain
- ¼ turn ceramic valves
- Swivel spout with water saving 1.5 GPM aerator

INCLUDES BOTH:

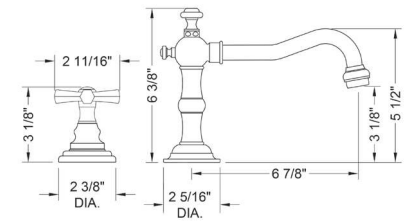
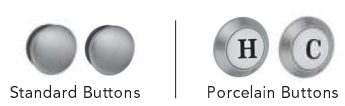

ROARING 20'S FAUCETS

8"-12" WIDESPREADS



JACLO
Confidence from start to finish.™



ITEM	CHROME	GROUP A	GROUP B	GROUP C
7830-T679-	\$595.00	\$645.00	\$745.00	\$875.00

- All brass 8"-12" widespread faucet includes brass pop-up drain
- ¼ turn ceramic valves
- Swivel spout with water saving 1.5 GPM aerator
- ADA compliant levers

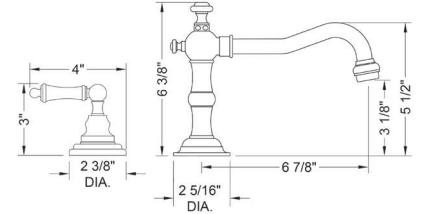

ITEM	CHROME	GROUP A	GROUP B	GROUP C
7830-T675-	\$595.00	\$645.00	\$745.00	\$875.00

- All brass 8"-12" widespread faucet includes brass pop-up drain
- ¼ turn ceramic valves
- Swivel spout with water saving 1.5 GPM aerator
- ADA compliant levers

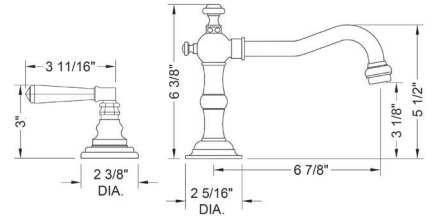

ITEM	CHROME	GROUP A	GROUP B	GROUP C
7830-T667-	\$595.00	\$645.00	\$745.00	\$875.00

- All brass 8"-12" widespread faucet includes brass pop-up drain
- ¼ turn ceramic valves
- Swivel spout with water saving 1.5 GPM aerator
- ADA compliant levers

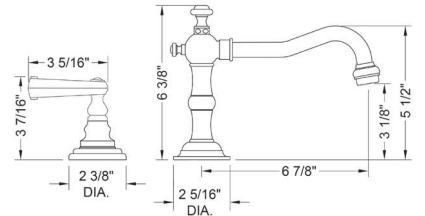

ROARING 20'S ROMAN TUB SET

ROMAN TUB ONLY



TRIM ONLY



Shown: 9930-T674 -TRIM-
Trim only

ITEM	CHROME	GROUP A	GROUP B	GROUP C
9930-T678-TRIM-	\$535.00	\$685.00	\$785.00	\$895.00
9930-T674-TRIM-	\$535.00	\$685.00	\$785.00	\$895.00
9930-T692-TRIM-	\$535.00	\$685.00	\$785.00	\$895.00
9930-T676-TRIM-	\$535.00	\$685.00	\$785.00	\$895.00
9930-T679-TRIM-	\$535.00	\$685.00	\$785.00	\$895.00
9930-T675-TRIM-	\$535.00	\$685.00	\$785.00	\$895.00
9930-T667-TRIM-	\$535.00	\$685.00	\$785.00	\$895.00

- All brass roman deck mount tub set trim
- Quick connect/disconnect spout
- Swivel spout includes full flow aerator
- Requires J-6910 rough in kit below

T678 & T692 INCLUDE BOTH:



T676 INCLUDES BOTH:



Handle Options:

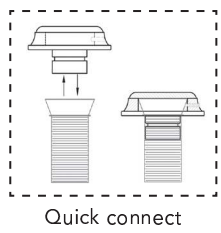
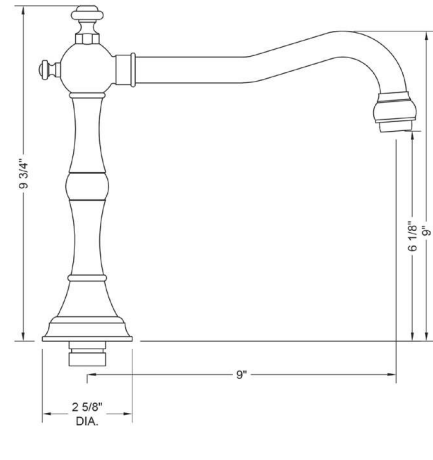

ROMAN TUB ROUGH KIT (REQUIRED)



ITEM	ROUGH
J-6910	\$250.00

- Rough in kit for roman tub
- 3/4" 1/4 turn high flow 12 GPM @ 60 PSI ceramic valves
- Quick connect/disconnect deck nipple for spout
- 3/4" IPS brass tee

ROMAN TUB SPOUT HOOK UP KIT (OPTIONAL)



ITEM	ROUGH
J-RT-KIT	\$120.00

- Kit for connecting roman tub rough kit
- 3/4" IPS connections
- Consists of:
 - (2 each) 3/4" MIP x 3/4" FIP 18" flexible hoses

ROARING 20'S ROMAN TUB SET

ROMAN TUB WITH DIVERTER & HANDSHOWER

TRIM WITH HANDSHOWER ONLY



Shown: 9930-T674-A-240-TRIM-
Trim only with B240 handshower (angle)



Shown: 9930-T674-S-240-TRIM-
Trim only with B240 handshower (straight)

ITEM	CHROME	GROUP A	GROUP B	GROUP C
9930-T678-A-240-TRIM-	\$915.00	\$1235.00	\$1570.00	\$1760.00
9930-T674-A-240-TRIM-	\$915.00	\$1235.00	\$1570.00	\$1760.00
9930-T692-A-240-TRIM-	\$915.00	\$1235.00	\$1570.00	\$1760.00
9930-T676-A-240-TRIM-	\$915.00	\$1235.00	\$1570.00	\$1760.00
9930-T679-A-240-TRIM-	\$915.00	\$1235.00	\$1570.00	\$1760.00
9930-T675-A-240-TRIM-	\$915.00	\$1235.00	\$1570.00	\$1760.00
9930-T667-A-240-TRIM-	\$915.00	\$1235.00	\$1570.00	\$1760.00

9930-T678-S-240-TRIM-	\$915.00	\$1235.00	\$1570.00	\$1760.00
9930-T674-S-240-TRIM-	\$915.00	\$1235.00	\$1570.00	\$1760.00
9930-T692-S-240-TRIM-	\$915.00	\$1235.00	\$1570.00	\$1760.00
9930-T676-S-240-TRIM-	\$915.00	\$1235.00	\$1570.00	\$1760.00
9930-T679-S-240-TRIM-	\$915.00	\$1235.00	\$1570.00	\$1760.00
9930-T675-S-240-TRIM-	\$915.00	\$1235.00	\$1570.00	\$1760.00
9930-T667-S-240-TRIM-	\$915.00	\$1235.00	\$1570.00	\$1760.00

- All brass roman deck mount tub set trim
- Quick connect/disconnect spout
- Cross handle trim & T692-TRIM includes both metal & porcelain buttons
- Swivel spout includes full flow aerator
- Requires J-6910-DIV rough in kit below
- Includes: B240 handshower, 60" double spiral brass hose, 8029 or 8030 handshower mount and 8019 deck mount sleeve
- Contact factory for alternate handshower

Handle Options:



T678



T674 



T692 



T676



T679 



T675 



T667 

ROMAN TUB DIVERTER ROUGH KIT (REQUIRED)



ITEM	ROUGH
J-6910-DIV-RGH	\$495.00

- Rough in kit for roman tub
- 3/4" 1/4 turn high flow 12 GPM @ 60 PSI ceramic valves
- Quick connect/disconnect deck nipple for spout
- 7010-BF double check valve, 1/2" IPS coupling 3024-HP 24" high pressure hose, J-1209 deck diverter valve, 3/4" IPS brass tee

ROMAN TUB SPOUT HOOK UP KIT (OPTIONAL)



ITEM	ROUGH
J-RT-KIT	\$120.00

- Kit for connecting roman tub rough kit
- 3/4" IPS connections
- Consists of:
 - (2 each) 3/4" MIP x 3/4" FIP 18" flexible hoses



WALL MOUNTED ACCESSORIES

ROBE HOOK



ITEM	CHROME	GROUP A	GROUP B	GROUP C
4830-RH-	\$90.00	\$115.00	\$135.00	\$155.00

- All brass robe hook
- Universal mounting hardware included
- 3 7/8" projection

TOWEL RING



ITEM	CHROME	GROUP A	GROUP B	GROUP C
4830-TR-	\$120.00	\$145.00	\$180.00	\$210.00

- All brass 6" towel ring
- Universal mounting hardware included
- 3 7/8" projection

TOWEL BARS



ITEM	SPECIFICS	CHROME	GROUP A	GROUP B	GROUP C
4830-TB-24-	24"	\$185.00	\$245.00	\$295.00	\$385.00
4830-TB-18-	18"	\$175.00	\$235.00	\$305.00	\$375.00

- All brass towel bars
- Universal mounting hardware included
- 3 7/8" projection

TOILET PAPER HOLDER



ITEM	CHROME	GROUP A	GROUP B	GROUP C
4830-TP-	\$185.00	\$245.00	\$305.00	\$385.00

- All brass double post toilet paper holder
- Universal mounting hardware included
- 3 7/8" projection

SOAP DISH



ITEM	CHROME	GROUP A	GROUP B	GROUP C
4830-SD-	\$155.00	\$185.00	\$235.00	\$310.00

- All brass & glass soap dish
- Universal mounting hardware included
- 4 3/4" projection
- 5/8" x 3/8" thick glass dish

TOOTHBRUSH & TUMBLER HOLDER



ITEM	CHROME	GROUP A	GROUP B	GROUP C
4830-TH-	\$155.00	\$185.00	\$235.00	\$310.00

- All brass & glass tooth brush & tumbler holder
- Universal mounting hardware included
- 4 3/4" projection
- Tumbler not included
- 5/8" x 3/8" thick glass dish

GLASS SHELF



ITEM	CHROME	GROUP A	GROUP B	GROUP C
4830-GS-24-	\$275.00	\$350.00	\$400.00	\$495.00

- All brass & glass 24" shelf
- Universal mounting hardware included
- 5 3/8" projection
- 3/8" glass thickness

FREE STANDING ACCESSORIES

CUP HOLDER



ITEM	CHROME	GROUP A	GROUP B	GROUP C
DD-15-	\$95.00	\$140.00	\$160.00	\$195.00

- Brass free standing cup holder
- 4⁵/₈" tall with 3" round base
- Holds 40–3oz paper cups (not included)
- Complements both bathroom & kitchen decor

SOAP/LOTION DISPENSER



ITEM	SPECIFICS	CHROME	GROUP A	GROUP B	GROUP C
LD-10-	Square base	\$195.00	\$265.00	\$295.00	\$350.00
LD-15-	Round base	\$195.00	\$265.00	\$295.00	\$350.00

- All brass free standing soap & lotion dispenser
- 3³/₄" spout
- 5⁵/₈" tall with 3³/₈" square base
- 5⁵/₈" tall with 3" diameter round base
- 4 oz. plastic reservoir
- Complements both bathroom & kitchen decor

TOILET PAPER HOLDERS



ITEM	SPECIFICS	CHROME	GROUP A	GROUP B	GROUP C
TP-10-	Smooth	\$295.00	\$395.00	\$450.00	\$535.00
TP-20-	Reeded	\$295.00	\$395.00	\$450.00	\$535.00

- All brass free standing toilet paper holder
- 26¹/₂" tall with 5¹/₂" weighted base for stability
- Available with both smooth or reeded tubing

SPARE TOILET PAPER HOLDER



ITEM	CHROME	GROUP A	GROUP B	GROUP C
TH-10-	\$275.00	\$350.00	\$395.00	\$450.00

- All brass free standing toilet paper holder
- 17" tall with 5¹/₂" weighted base for stability
- Can also be used as a free standing paper towel holder
- Holds 3-4 rolls of toilet tissue

Don't Forget JACLO has:



PAGE 4-5 FINISHES + POLICIES

PAGE 6-21 TABLE OF CONTENTS

TAB ① FAUCET COLLECTIONS, ROMAN TUBS + ACCESSORIES

TAB ② SHOWER TRIM, TUB + SHOWER VALVES + SPOUTS

TAB ③ SHOWERHEADS, ARMS + ESCUTCHEONS

TAB ④ HANDSHOWERS, HOSES, BIDET + HANDSHOWER ACCESSORIES

TAB ⑤ GRAB BARS/DOOR PULLS + GRAB BARS FOR HANDSHOWERS

TAB ⑥ DECORATIVE SPECIALTIES (Supply Valves, P Traps, Tub + Shower Drains)

TAB ⑦ CHANNEL DRAINS

TAB ⑧ SPA COLLECTION (Water Features)

TAB ⑨ REPLACEMENT PARTS

TAB ⑩ GENERAL INFORMATION

TAB ⑪ PRICING INDEX + GLOSSARY

TAB ⑫ STEAM VALVE ORIGINAL (Luxury Stainless Steel Kitchen Faucets)

Westfield Collection



JACLO
Confidence from start to finish.™



HANDLE STYLES



T678



T674



T676



T675

NOTES



WESTFIELD FAUCETS 8"-12" WIDESPREADS



ITEM	SPECIFICS	CHROME	GROUP A	GROUP B	GROUP C
6870-T678-	8"-12" Widespread	\$495.00	\$525.00	\$615.00	\$695.00

- All brass 8"-12" widespread faucet includes brass pop-up drain
- ¼ turn ceramic valves
- Stationary spout with water saving 1.5 GPM aerator

INCLUDES BOTH:

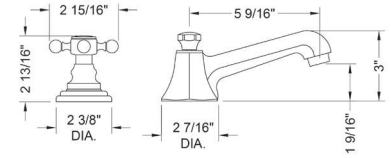

ITEM	SPECIFICS	CHROME	GROUP A	GROUP B	GROUP C
6870-T674-	8"-12" Widespread	\$495.00	\$525.00	\$615.00	\$695.00

- All brass 8"-12" widespread faucet includes brass pop-up drain
- ¼ turn ceramic valves
- Stationary spout with water saving 1.5 GPM aerator
- ADA compliant levers

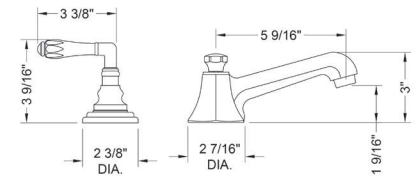

ITEM	SPECIFICS	CHROME	GROUP A	GROUP B	GROUP C
6870-T676-	8"-12" Widespread	\$495.00	\$525.00	\$615.00	\$695.00

- All brass 8"-12" widespread faucet includes brass pop-up drain
- ¼ turn ceramic valves
- Stationary spout with water saving 1.5 GPM aerator

INCLUDES BOTH:

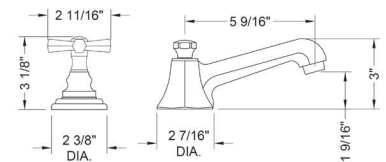
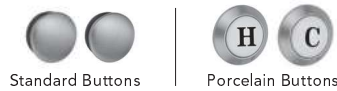

ITEM	SPECIFICS	CHROME	GROUP A	GROUP B	GROUP C
6870-T675-	8"-12" Widespread	\$495.00	\$525.00	\$615.00	\$695.00

- All brass 8"-12" widespread faucet includes brass pop-up drain
- ¼ turn ceramic valves
- Stationary spout with water saving 1.5 GPM aerator
- ADA compliant levers

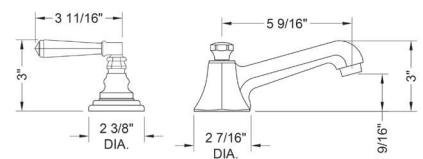

WESTFIELD ROMAN TUB SET—LOW PROFILE SPOUT

ROMAN TUB ONLY



JACLO
Confidence from start to finish.™

TRIM ONLY



Shown: 6970-T674 -TRIM-
Trim only

ITEM	CHROME	GROUP A	GROUP B	GROUP C
6970-T678-TRIM-	\$500.00	\$650.00	\$750.00	\$875.00
6970-T674-TRIM-	\$500.00	\$650.00	\$750.00	\$875.00
6970-T676-TRIM-	\$500.00	\$650.00	\$750.00	\$875.00
6970-T675-TRIM-	\$500.00	\$650.00	\$750.00	\$875.00

- All brass roman deck mount tub set trim
- Quick connect/disconnect spout
- Stationary spout includes full flow aerator
- Requires J-6912 rough in kit below

T678 INCLUDES BOTH:



T676 INCLUDES BOTH:



Handle Options:



T678



T674 ♿



T676



T675 ♿

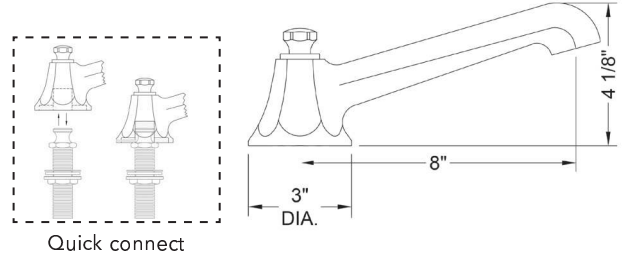

ROMAN TUB ROUGH KIT (REQUIRED)



ITEM	ROUGH
J-6912	\$250.00

- Rough in kit for roman tub
- 3/4" 1/4 turn high flow 12 GPM @ 60 PSI ceramic valves
- Quick connect/disconnect deck nipple for spout
- 3/4" IPS brass tee

ROMAN TUB SPOUT HOOK UP KIT (OPTIONAL)



ITEM	ROUGH
J-RT-KIT	\$120.00

- Kit for connecting roman tub rough kit
- 3/4" IPS connections
- Consists of:
 - (2 each) 3/4" MIP x 3/4" FIP 18" flexible hoses

WESTFIELD ROMAN TUB SET—LOW PROFILE SPOUT

ROMAN TUB WITH DIVERTER & HANDSHOWER



TRIM ONLY WITH HANDSHOWER



Shown: 6970-T674-S-488-TRIM-
Trim only with S488 handshower (straight)

ITEM	CHROME	GROUP A	GROUP B	GROUP C
6970-T678-S-488-TRIM-	\$845.00	\$1180.00	\$1385.00	\$1690.00
6970-T674-S-488-TRIM-	\$845.00	\$1180.00	\$1385.00	\$1690.00
6970-T676-S-488-TRIM-	\$845.00	\$1180.00	\$1385.00	\$1690.00
6970-T675-S-488-TRIM-	\$845.00	\$1180.00	\$1385.00	\$1690.00

- All brass roman deck mount tub set trim
- Quick connect/disconnect spout
- Cross handles trim includes both metal & porcelain buttons
- Stationary spout includes full flow aerator
- Requires J-6910-DIV rough in kit below
- Includes: S488 handshower, 60" double spiral brass hose, 8030 handshower mount & 8019 deck mount sleeve
- Contact factory for alternate handshower

Handle Options:



T678



T674 ♿



T676



T675 ♿

ROMAN TUB DIVERTER ROUGH KIT (REQUIRED)



ITEM	ROUGH
J-6912-DIV-RGH	\$495.00

- Rough in kit for roman tub
- 3/4" 1/4 turn high flow 12 GPM @ 60 PSI ceramic valves
- Quick connect/disconnect deck nipple for spout
- 7010-BF double check valve, 1/2" IPS coupling 3024-HP 24" high pressure hose, J-1209 deck diverter valve, 3/4" IPS brass tee

ROMAN TUB SPOUT HOOK UP KIT (OPTIONAL)



ITEM	ROUGH
J-RT-KIT	\$120.00

- Kit for connecting roman tub rough kit
- 3/4" IPS connections
- Consists of:
 - (2 each) 3/4" MIP x 3/4" FIP 18" flexible hoses

WESTFIELD ROMAN TUB SET—HIGH PROFILE SPOUT

ROMAN TUB ONLY



TRIM ONLY



Shown: 6972-T674 -TRIM-
Trim only

ITEM	CHROME	GROUP A	GROUP B	GROUP C
6972-T678-TRIM-	\$500.00	\$650.00	\$750.00	\$875.00
6972-T674-TRIM-	\$500.00	\$650.00	\$750.00	\$875.00
6972-T676-TRIM-	\$500.00	\$650.00	\$750.00	\$875.00
6972-T675-TRIM-	\$500.00	\$650.00	\$750.00	\$875.00

- All brass roman deck mount tub set trim
- Quick connect/disconnect spout
- Stationary spout includes full flow aerator
- Requires J-6912 rough in kit below

T678 INCLUDES BOTH:

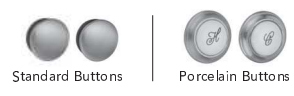

T676 INCLUDES BOTH:



Handle Options:

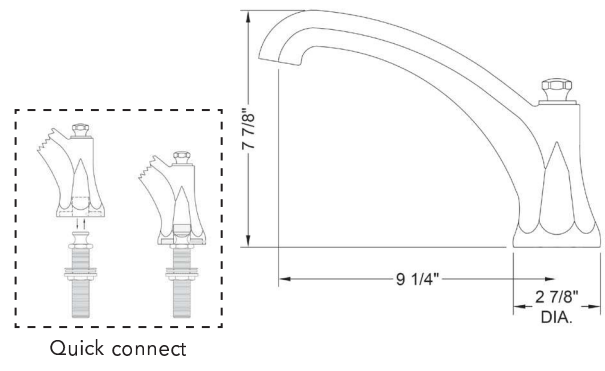

ROMAN TUB ROUGH KIT (REQUIRED)



ITEM	ROUGH
J-6912	\$250.00

- Rough in kit for roman tub
- 3/4" 1/4 turn high flow 12 GPM @ 60 PSI ceramic valves
- Quick connect/disconnect deck nipple for spout
- 3/4" IPS brass tee

ROMAN TUB SPOUT HOOK UP KIT (OPTIONAL)

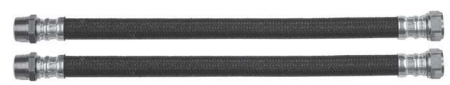

ITEM	SPECIFICS	ROUGH
J-RT-KIT		\$120.00

- Kit for connecting roman tub rough kit
- 3/4" IPS connections
- Consists of:
 - (2 each) 3/4" MIP x 3/4" FIP 18" flexible hoses

WESTFIELD ROMAN TUB SET—HIGH PROFILE SPOUT

ROMAN TUB WITH DIVERTER & HANDSHOWER



TRIM ONLY WITH HANDSHOWER

ITEM	CHROME	GROUP A	GROUP B	GROUP C
6972-T678-S-488-TRIM-	\$845.00	\$1180.00	\$1385.00	\$1690.00
6972-T674-S-488-TRIM-	\$845.00	\$1180.00	\$1385.00	\$1690.00
6972-T676-S-488-TRIM-	\$845.00	\$1180.00	\$1385.00	\$1690.00
6972-T675-S-488-TRIM-	\$845.00	\$1180.00	\$1385.00	\$1690.00



- All brass roman deck mount tub set trim
- Quick connect/disconnect spout
- Cross handles trim includes both metal & porcelain buttons
- Stationary spout includes full flow aerator
- Requires J-6910-DIV rough in kit below
- Includes: S488 handshower, 60" double spiral brass hose, 8030 handshower mount & 8019 deck mount sleeve
- Contact factory for alternate handshower

Shown: 6970-T674-S-488-TRIM-

Trim only with S488 handshower (straight)

Handle Options:



T678



T674 ♿



T676



T675 ♿

ROMAN TUB DIVERTER ROUGH KIT (REQUIRED)

ITEM	ROUGH
J-6912-DIV-RGH	\$495.00



- Rough in kit for roman tub
- 3/4" 1/4 turn high flow 12 GPM @ 60 PSI ceramic valves
- Quick connect/disconnect deck nipple for spout
- 7010-BF double check valve, 1/2" IPS coupling 3024-HP 24" high pressure hose, J-1209 deck diverter valve, 3/4" IPS brass tee



ROMAN TUB SPOUT HOOK UP KIT (OPTIONAL)

ITEM	ROUGH
J-RT-KIT	\$120.00



- Kit for connecting roman tub rough kit
- 3/4" IPS connections
- Consists of:
 - (2 each) 3/4" MIP x 3/4" FIP 18" flexible hoses



WALL MOUNTED ACCESSORIES

ROBE HOOK



ITEM	CHROME	GROUP A	GROUP B	GROUP C
4830-RH-	\$90.00	\$115.00	\$135.00	\$155.00

- All brass robe hook
- Universal mounting hardware included
- 3/8" projection

TOWEL RING



ITEM	CHROME	GROUP A	GROUP B	GROUP C
4830-TR-	\$120.00	\$145.00	\$180.00	\$210.00

- All brass 6" towel ring
- Universal mounting hardware included
- 3/8" projection

TOWEL BARS



ITEM	SPECIFICS	CHROME	GROUP A	GROUP B	GROUP C
4830-TB-24-	24"	\$185.00	\$245.00	\$305.00	\$385.00
4830-TB-18-	18"	\$175.00	\$235.00	\$295.00	\$375.00

- All brass towel bars
- Universal mounting hardware included
- 3/8" projection

TOILET PAPER HOLDER



ITEM	CHROME	GROUP A	GROUP B	GROUP C
4830-TP-	\$185.00	\$245.00	\$305.00	\$385.00

- All brass double post toilet paper holder
- Universal mounting hardware included
- 3/8" projection

SOAP DISH



ITEM	CHROME	GROUP A	GROUP B	GROUP C
4830-SD-	\$155.00	\$185.00	\$235.00	\$310.00

- All brass & glass soap dish
- Universal mounting hardware included
- 4 3/4" projection
- 5/8" x 3/8" thick glass dish

TOOTHBRUSH & TUMBLER HOLDER



ITEM	CHROME	GROUP A	GROUP B	GROUP C
4830-TH-	\$155.00	\$185.00	\$235.00	\$310.00

- All brass & glass tooth brush & tumbler holder
- Universal mounting hardware included
- 4 3/4" projection
- Tumbler not included
- 5/8" x 3/8" thick glass dish

GLASS SHELF



ITEM	CHROME	GROUP A	GROUP B	GROUP C
4830-GS-24-	\$275.00	\$350.00	\$400.00	\$495.00

- All brass & glass 24" shelf
- Universal mounting hardware included
- 5 3/8" projection
- 3/8" glass thickness

FREE STANDING ACCESSORIES

CUP HOLDER



ITEM	CHROME	GROUP A	GROUP B	GROUP C
DD-15-	\$95.00	\$140.00	\$160.00	\$195.00

- Brass free standing cup holder
- 4⁵/₈" tall with 3" round base
- Holds 40–3oz paper cups (not included)
- Complements both bathroom & kitchen decor

SOAP/LOTION DISPENSER



ITEM	SPECIFICS	CHROME	GROUP A	GROUP B	GROUP C
LD-10-	Square base	\$195.00	\$265.00	\$295.00	\$350.00
LD-15-	Round base	\$195.00	\$265.00	\$295.00	\$350.00

- All brass free standing soap & lotion dispenser
- 3³/₄" spout
- 5⁵/₈" tall with 3³/₈" square base
- 5⁵/₈" tall with 3" diameter round base
- 4 oz. plastic reservoir
- Complements both bathroom & kitchen decor

TOILET PAPER HOLDERS



ITEM	SPECIFICS	CHROME	GROUP A	GROUP B	GROUP C
TP-10-	Smooth	\$295.00	\$395.00	\$450.00	\$535.00
TP-20-	Reeded	\$295.00	\$395.00	\$450.00	\$535.00

- All brass free standing toilet paper holder
- 26¹/₂" tall with 5¹/₂" weighted base for stability
- Available with both smooth or reeded tubing

SPARE TOILET PAPER HOLDER



ITEM	CHROME	GROUP A	GROUP B	GROUP C
TH-10-	\$275.00	\$350.00	\$395.00	\$450.00

- All brass free standing toilet paper holder
- 17" tall with 5¹/₂" weighted base for stability
- Can also be used as a free standing paper towel holder
- Holds 3-4 rolls of toilet tissue

Don't Forget JACLO has:



PAGE 4-5 FINISHES + POLICIES

PAGE 6-21 TABLE OF CONTENTS

TAB ① FAUCET COLLECTIONS, ROMAN TUBS + ACCESSORIES

TAB ② SHOWER TRIM, TUB + SHOWER VALVES + SPOUTS

TAB ③ SHOWERHEADS, ARMS + ESCUTCHEONS

TAB ④ HANDSHOWERS, HOSES, BIDET + HANDSHOWER ACCESSORIES

TAB ⑤ GRAB BARS/DOOR PULLS + GRAB BARS FOR HANDSHOWERS

TAB ⑥ DECORATIVE SPECIALTIES (Supply Valves, P Traps, Tub + Shower Drains)

TAB ⑦ CHANNEL DRAINS

TAB ⑧ SPA COLLECTION (Water Features)

TAB ⑨ REPLACEMENT PARTS

TAB ⑩ GENERAL INFORMATION

TAB ⑪ PRICING INDEX + GLOSSARY

TAB ⑫ STEAM VALVE ORIGINAL (Luxury Stainless Steel Kitchen Faucets)



Cranford Collection



HANDLE STYLES



T667



T646



T639



T647

NOTES



CRANFORD FAUCETS 8"–12" WIDESPREADS



ITEM	SPECIFICS	CHROME	GROUP A	GROUP B	GROUP C
5460-T677-	8"-12" Widespread	\$450.00	\$485.00	\$575.00	\$650.00

- All brass 8"-12" widespread faucet includes brass pop-up drain
- ¼ turn ceramic valves
- Stationary spout with water saving 1.5 GPM aerator

INCLUDES BOTH:

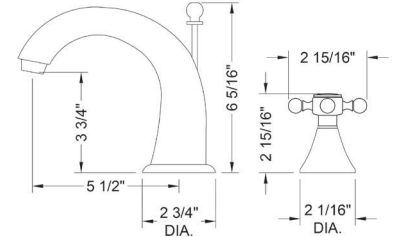

ITEM	SPECIFICS	CHROME	GROUP A	GROUP B	GROUP C
5460-T646-	8"-12" Widespread	\$450.00	\$485.00	\$575.00	\$650.00

- All brass 8"-12" widespread faucet includes brass pop-up drain
- ¼ turn ceramic valves
- Stationary spout with water saving 1.5 GPM aerator
- ADA compliant levers

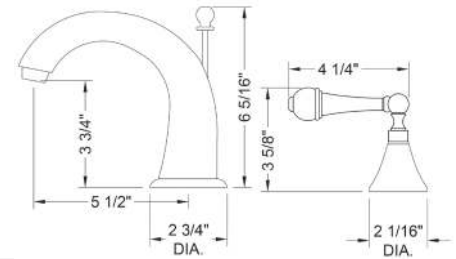

ITEM	SPECIFICS	CHROME	GROUP A	GROUP B	GROUP C
5460-T647-	8"-12" Widespread	\$450.00	\$485.00	\$575.00	\$650.00

- All brass 8"-12" widespread faucet includes brass pop-up drain
- ¼ turn ceramic valves
- Stationary spout with water saving 1.5 GPM aerator
- ADA compliant levers

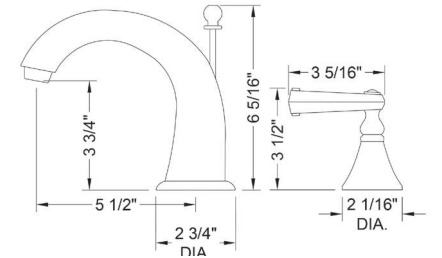

ITEM	SPECIFICS	CHROME	GROUP A	GROUP B	GROUP C
5460-T639-	8"-12" Widespread	\$450.00	\$485.00	\$575.00	\$650.00

- All brass 8"-12" widespread faucet includes brass pop-up drain
- ¼ turn ceramic valves
- Stationary spout with water saving 1.5 GPM aerator
- ADA compliant levers

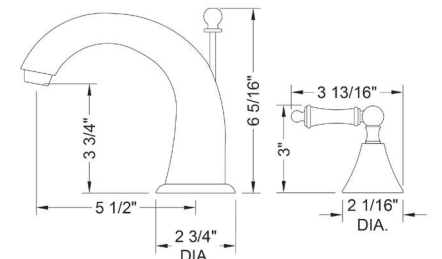

CRANFORD ROMAN TUB SET

ROMAN TUB ONLY



TRIM ONLY



Shown: 6960-T647 -TRIM-
Trim only

ITEM	CHROME	GROUP A	GROUP B	GROUP C
6960-T677-TRIM-	\$450.00	\$600.00	\$700.00	\$825.00
6960-T646-TRIM-	\$450.00	\$600.00	\$700.00	\$825.00
6960-T647-TRIM-	\$450.00	\$600.00	\$700.00	\$825.00
6960-T639-TRIM-	\$450.00	\$600.00	\$700.00	\$825.00

- All brass roman deck mount tub set trim
- Quick connect/disconnect spout
- Stationary spout includes full flow aerator
- Requires J-6912 rough in kit below

T677 INCLUDES BOTH:

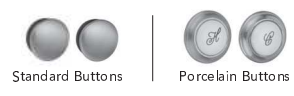

Handle Options:

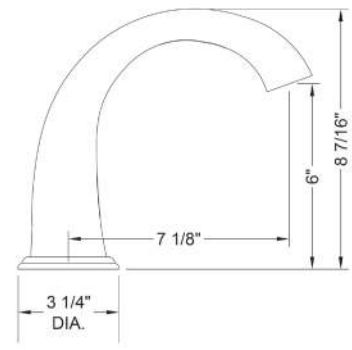
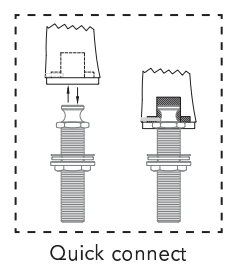

ROMAN TUB ROUGH KIT (REQUIRED)



ITEM	ROUGH
J-6912	\$250.00

- Rough in kit for roman tub
- 3/4" 1/4 turn high flow 12 GPM @ 60 PSI ceramic valves
- Quick connect/disconnect deck nipple for spout
- 3/4" IPS brass tee

ROMAN TUB SPOUT HOOK UP KIT (OPTIONAL)



ITEM	ROUGH
J-RT-KIT	\$120.00

- Kit for connecting roman tub rough kit
- 3/4" IPS connections
- Consists of:
 - (2 each) 3/4" MIP x 3/4" FIP 18" flexible hoses

CRANFORD ROMAN TUB SET

ROMAN TUB WITH DIVERTER & HANDSHOWER



TRIM ONLY WITH HANDSHOWER



ITEM	CHROME	GROUP A	GROUP B	GROUP C
6960-T677-S-423-TRIM-	\$760.00	\$1086.00	\$1285.00	\$1570.00
6960-T646-S-423-TRIM-	\$760.00	\$1086.00	\$1285.00	\$1570.00
6960-T647-S-423-TRIM-	\$760.00	\$1086.00	\$1285.00	\$1570.00
6960-T639-S-423-TRIM-	\$760.00	\$1086.00	\$1285.00	\$1570.00

- All brass roman deck mount tub set trim
- Quick connect/disconnect spout
- Cross handle trim includes both metal & porcelain buttons
- Stationary spout includes full flow aerator
- Requires J-6910-DIV rough in kit below
- Includes: S423 handshower, 60" double spiral brass hose, 8030 handshower mount & 8019 deck mount sleeve
- Contact factory for alternate handshower

Shown: 6960-T647-S-423-TRIM-
Trim only with S423 handshower (straight)

Handle Options:



T677



T646



T647



T639

ROMAN TUB DIVERTER ROUGH KIT (REQUIRED)



ITEM	ROUGH
J-6912-DIV-RGH	\$495.00

- Rough in kit for roman tub
- 3/4" 1/4 turn high flow 12 GPM @ 60 PSI ceramic valves
- Quick connect/disconnect deck nipple for spout
- 7010-BF double check valve, 1/2" IPS coupling 3024-HP 24" high pressure hose, J-1209 deck diverter valve, 3/4" IPS brass tee

ROMAN TUB SPOUT HOOK UP KIT (OPTIONAL)



ITEM	ROUGH
J-RT-KIT	\$120.00

- Kit for connecting roman tub rough kit
- 3/4" IPS connections
- Consists of:
 - (2 each) 3/4" MIP x 3/4" FIP 18" flexible hoses

CRANFORD WALL MOUNTED ACCESSORIES



ROBE HOOK



ITEM	CHROME	GROUP A	GROUP B	GROUP C
4460-RH-	\$55.00	\$65.00	\$75.00	\$105.00

- All brass robe hook
- Universal mounting hardware included
- 3¼" projection

TOWEL RING



ITEM	CHROME	GROUP A	GROUP B	GROUP C
4460-TR-	\$65.00	\$95.00	\$115.00	\$145.00

- All brass 7" towel ring
- Universal mounting hardware included
- 3¼" projection

TOWEL BARS

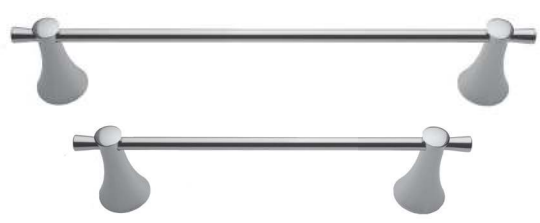

ITEM	SPECIFICS	CHROME	GROUP A	GROUP B	GROUP C
4460-TB-24-	24"	\$105.00	\$135.00	\$175.00	\$205.00
4460-TB-18-	18"	\$95.00	\$125.00	\$155.00	\$185.00

- All brass towel bars
- Universal mounting hardware included
- 3¼" projection

TOILET PAPER HOLDER



ITEM	CHROME	GROUP A	GROUP B	GROUP C
4460-TP-	\$65.00	\$95.00	\$115.00	\$145.00

- All brass single post toilet paper holder
- Universal mounting hardware included
- 3¼" projection

SOAP DISH



ITEM	CHROME	GROUP A	GROUP B	GROUP C
4460-SD-	\$65.00	\$95.00	\$115.00	\$145.00

- All brass & glass soap dish
- Universal mounting hardware included
- 5" projection
- Removable 4⅜" glass dish

TUMBLER



ITEM	CHROME	GROUP A	GROUP B	GROUP C
4460-TH-	\$65.00	\$95.00	\$115.00	\$145.00

- All brass tumbler holder
- Universal mounting hardware included
- Includes glass tumbler
- 4⅞" projection

GLASS SHELF



4460-GS



4460-GSW

ITEM	SPECIFICS	CHROME	GROUP A	GROUP B	GROUP C
4460-GS-	Less rail	\$155.00	\$175.00	\$185.00	\$205.00
4460-GSW-	Wire rail	\$155.00	\$175.00	\$185.00	\$205.00

- All brass & glass 17¾" shelf
- Universal mounting hardware included
- 6⅝" projection
- ⅜" glass thickness

FREE STANDING ACCESSORIES

CUP HOLDER



ITEM	CHROME	GROUP A	GROUP B	GROUP C
DD-15-	\$95.00	\$140.00	\$160.00	\$195.00

- Brass free standing cup holder
- 4⁵/₈" tall with 3" round base
- Holds 40–3oz paper cups (not included)
- Complements both bathroom & kitchen decor

SOAP/LOTION DISPENSER



ITEM	SPECIFICS	CHROME	GROUP A	GROUP B	GROUP C
LD-10-	Square base	\$195.00	\$265.00	\$295.00	\$350.00
LD-15-	Round base	\$195.00	\$265.00	\$295.00	\$350.00

- All brass free standing soap & lotion dispenser
- 3³/₄" spout
- 5⁵/₈" tall with 3³/₈" square base
- 5⁵/₈" tall with 3" diameter round base
- 4 oz. plastic reservoir
- Complements both bathroom & kitchen decor

TOILET PAPER HOLDERS



ITEM	SPECIFICS	CHROME	GROUP A	GROUP B	GROUP C
TP-10-	Smooth	\$295.00	\$395.00	\$450.00	\$535.00
TP-20-	Reeded	\$295.00	\$395.00	\$450.00	\$535.00

- All brass free standing toilet paper holder
- 26¹/₂" tall with 5¹/₂" weighted base for stability
- Available with both smooth or reeded tubing

SPARE TOILET PAPER HOLDER



ITEM	CHROME	GROUP A	GROUP B	GROUP C
TH-10-	\$275.00	\$350.00	\$395.00	\$450.00

- All brass free standing toilet paper holder
- 17" tall with 5¹/₂" weighted base for stability
- Can also be used as a free standing paper towel holder
- Holds 3-4 rolls of toilet tissue

Don't Forget JACLO has:



PAGE 4-5 FINISHES + POLICIES

PAGE 6-21 TABLE OF CONTENTS

TAB ① FAUCET COLLECTIONS, ROMAN TUBS + ACCESSORIES

TAB ② SHOWER TRIM, TUB + SHOWER VALVES + SPOUTS

TAB ③ SHOWERHEADS, ARMS + ESCUTCHEONS

TAB ④ HANDSHOWERS, HOSES, BIDET + HANDSHOWER ACCESSORIES

TAB ⑤ GRAB BARS/DOOR PULLS + GRAB BARS FOR HANDSHOWERS

TAB ⑥ DECORATIVE SPECIALTIES (Supply Valves, P Traps, Tub + Shower Drains)

TAB ⑦ CHANNEL DRAINS

TAB ⑧ SPA COLLECTION (Water Features)

TAB ⑨ REPLACEMENT PARTS

TAB ⑩ GENERAL INFORMATION

TAB ⑪ PRICING INDEX + GLOSSARY

TAB ⑫ STEAM VALVE ORIGINAL (Luxury Stainless Steel Kitchen Faucets)

Jaylen Collection



JACLO
Confidence from start to finish.™



HANDLE STYLES



T634



T636



T637

NOTES



JAYLEN FAUCETS

8"-12" WIDESPREADS



ITEM	SPECIFICS	CHROME	GROUP A	GROUP B	GROUP C
5840-T634-	8"-12" Widespread	\$450.00	\$485.00	\$575.00	\$650.00

- All brass 8"-12" widespread faucet includes brass pop-up drain
- ¼ turn ceramic valves
- Stationary spout with water saving 1.5 GPM aerator

INCLUDES BOTH:

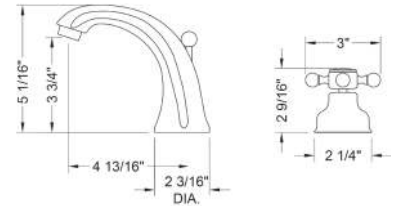
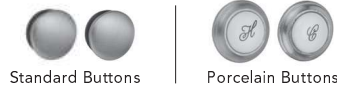

ITEM	SPECIFICS	CHROME	GROUP A	GROUP B	GROUP C
5840-T636-	8"-12" Widespread	\$450.00	\$485.00	\$575.00	\$650.00

- All brass 8"-12" widespread faucet includes brass pop-up drain
- ¼ turn ceramic valves
- Stationary spout with water saving 1.5 GPM aerator
- ADA compliant levers

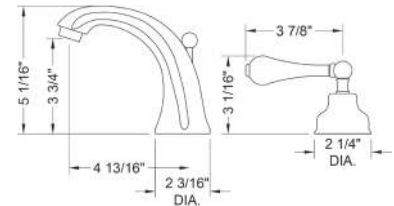

ITEM	SPECIFICS	CHROME	GROUP A	GROUP B	GROUP C
5840-T637-	8"-12" Widespread	\$450.00	\$485.00	\$575.00	\$650.00

- All brass 8"-12" widespread faucet includes brass pop-up drain
- ¼ turn ceramic valves
- Stationary spout with water saving 1.5 GPM aerator
- ADA compliant levers

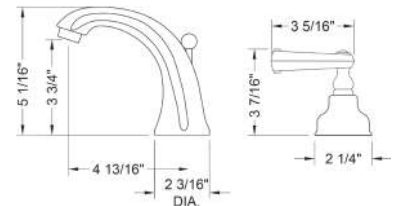

JAYLEN ROMAN TUB SET

ROMAN TUB ONLY



TRIM ONLY



Shown: 6972-T685 -TRIM-
Trim only

ITEM	CHROME	GROUP A	GROUP B	GROUP C
6940-T634-TRIM-	\$450.00	\$600.00	\$700.00	\$825.00
6940-T636-TRIM-	\$450.00	\$600.00	\$700.00	\$825.00
6940-T637-TRIM-	\$450.00	\$600.00	\$700.00	\$825.00

- All brass roman deck mount tub set trim
- Quick connect/disconnect spout
- Stationary spout includes full flow aerator
- Requires J-6910 rough in kit below

T634 INCLUDES BOTH:



Handle Options:



T634



T636 ♿



T637 ♿

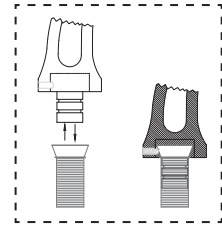

Quick connect

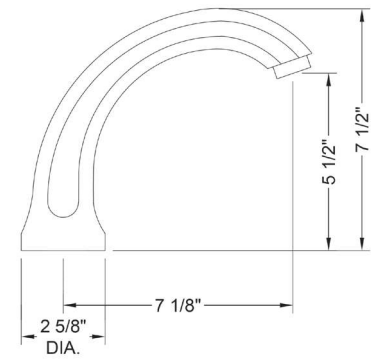

ROMAN TUB ROUGH KIT (REQUIRED)



ITEM	ROUGH
J-6910	\$250.00

- Rough in kit for roman tub
- 3/4" 1/4 turn high flow 12 GPM @ 60 PSI ceramic valves
- Quick connect/disconnect deck nipple for spout
- 3/4" IPS brass tee

ROMAN TUB SPOUT HOOK UP KIT (OPTIONAL)



ITEM	ROUGH
J-RT-KIT	\$120.00

- Kit for connecting roman tub rough kit
- 3/4" IPS connections
- Consists of:
 - (2 each) 3/4" MIP x 3/4" FIP 18" flexible hoses

JAYLEN ROMAN TUB SET

ROMAN TUB WITH DIVERTER & HANDSHOWER



TRIM ONLY WITH HANDSHOWER

ITEM	CHROME	GROUP A	GROUP B	GROUP C
6940-T634-S-423-TRIM-	\$760.00	\$1086.00	\$1285.00	\$1570.00
6940-T636-S-423-TRIM-	\$760.00	\$1086.00	\$1285.00	\$1570.00
6940-T637-S-423-TRIM-	\$760.00	\$1086.00	\$1285.00	\$1570.00



- All brass roman deck mount tub set trim
- Quick connect/disconnect spout
- Cross handle trim includes both metal & porcelain buttons
- Stationary spout includes full flow aerator
- Requires J-6910-DIV rough in kit below
- Includes: S423 handshower, 60" double spiral brass hose, 8030 handshower mount & 8019 deck mount sleeve
- Contact factory for alternate handshower

Shown: 6940-T636-S-423-TRIM-

Trim only with S423 handshower (straight)

Handle Options:



T634



T636



T637

ROMAN TUB DIVERTER ROUGH KIT (REQUIRED)

ITEM	ROUGH
J-6910-DIV-RGH	\$495.00



- Rough in kit for roman tub
- 3/4" 1/4 turn high flow 12 GPM @ 60 PSI ceramic valves
- Quick connect/disconnect deck nipple for spout
- 7010-BF double check valve, 1/2" IPS coupling 3024-HP 24" high pressure hose, J-1209 deck diverter valve, 3/4" IPS brass tee

ROMAN TUB SPOUT HOOK UP KIT (OPTIONAL)

ITEM	ROUGH
J-RT-KIT	\$120.00



- Kit for connecting roman tub rough kit
- 3/4" IPS connections
- Consists of:
 - (2 each) 3/4" MIP x 3/4" FIP 18" flexible hoses

WALL MOUNTED ACCESSORIES



JACLO
Confidence from start to finish.™

ROBE HOOK



ITEM	CHROME	GROUP A	GROUP B	GROUP C
4840-RH-	\$84.00	\$105.00	\$125.00	\$145.00

- All brass robe hook
- Universal mounting hardware included
- 3 $\frac{3}{8}$ " projection

TOWEL RING



ITEM	CHROME	GROUP A	GROUP B	GROUP C
4840-TR-	\$112.00	\$138.00	\$168.00	\$195.00

- All brass 6" towel ring
- Universal mounting hardware included
- 3 $\frac{3}{8}$ " projection

TOWEL BARS

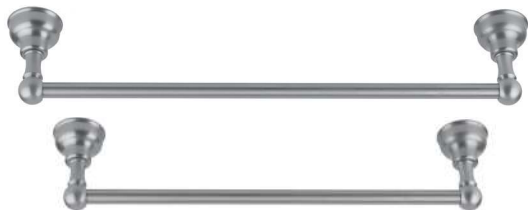

ITEM	SPECIFICS	CHROME	GROUP A	GROUP B	GROUP C
4840-TB-24-	24"	\$175.00	\$245.00	\$295.00	\$375.00
4840-TB-18-	18"	\$165.00	\$220.00	\$280.00	\$360.00

- All brass towel bars
- Universal mounting hardware included
- 3 $\frac{3}{8}$ " projection

TOILET PAPER HOLDER



ITEM	CHROME	GROUP A	GROUP B	GROUP C
4840-TP-	\$175.00	\$245.00	\$295.00	\$375.00

- All brass double post toilet paper holder
- Universal mounting hardware included
- 3 $\frac{3}{8}$ " projection

SOAP DISH



ITEM	CHROME	GROUP A	GROUP B	GROUP C
4840-SD-	\$145.00	\$175.00	\$225.00	\$300.00

- All brass & glass soap dish
- Universal mounting hardware included
- 4 $\frac{3}{4}$ " projection
- 5 $\frac{1}{8}$ " x 3 $\frac{1}{8}$ " thick glass dish

TOOTHBRUSH & TUMBLER HOLDER



ITEM	CHROME	GROUP A	GROUP B	GROUP C
4840-TH-	\$145.00	\$175.00	\$225.00	\$300.00

- All brass & glass tooth brush & tumbler holder
- Universal mounting hardware included
- 4 $\frac{3}{4}$ " projection
- Tumbler not included
- 5 $\frac{1}{8}$ " x 3 $\frac{1}{8}$ " thick glass dish

GLASS SHELF



ITEM	CHROME	GROUP A	GROUP B	GROUP C
4840-GS-24-	\$265.00	\$340.00	\$390.00	\$485.00

- All brass & glass 24" shelf
- Universal mounting hardware included
- 5 $\frac{3}{8}$ " projection
- 3 $\frac{1}{8}$ " glass thickness

FREE STANDING ACCESSORIES

CUP HOLDER



ITEM	CHROME	GROUP A	GROUP B	GROUP C
DD-15-	\$95.00	\$140.00	\$160.00	\$195.00

- Brass free standing cup holder
- 4⁵/₈" tall with 3" round base
- Holds 40–3oz paper cups (not included)
- Complements both bathroom & kitchen decor

SOAP/LOTION DISPENSER



ITEM	SPECIFICS	CHROME	GROUP A	GROUP B	GROUP C
LD-10-	Square base	\$195.00	\$265.00	\$295.00	\$350.00
LD-15-	Round base	\$195.00	\$265.00	\$295.00	\$350.00

- All brass free standing soap & lotion dispenser
- 3³/₄" spout
- 5⁵/₈" tall with 3³/₈" square base
- 5⁵/₈" tall with 3" diameter round base
- 4 oz. plastic reservoir
- Complements both bathroom & kitchen decor

TOILET PAPER HOLDERS



ITEM	SPECIFICS	CHROME	GROUP A	GROUP B	GROUP C
TP-10-	Smooth	\$295.00	\$395.00	\$450.00	\$535.00
TP-20-	Reeded	\$295.00	\$395.00	\$450.00	\$535.00

- All brass free standing toilet paper holder
- 26¹/₂" tall with 5¹/₂" weighted base for stability
- Available with both smooth or reeded tubing

SPARE TOILET PAPER HOLDER



ITEM	CHROME	GROUP A	GROUP B	GROUP C
TH-10-	\$275.00	\$350.00	\$395.00	\$450.00

- All brass free standing toilet paper holder
- 17" tall with 5¹/₂" weighted base for stability
- Can also be used as a free standing paper towel holder
- Holds 3-4 rolls of toilet tissue

Don't Forget JACLO has:



PAGE 4-5 FINISHES + POLICIES

PAGE 6-21 TABLE OF CONTENTS

TAB ① FAUCET COLLECTIONS, ROMAN TUBS + ACCESSORIES

TAB ② SHOWER TRIM, TUB + SHOWER VALVES + SPOUTS

TAB ③ SHOWERHEADS, ARMS + ESCUTCHEONS

TAB ④ HANDSHOWERS, HOSES, BIDET + HANDSHOWER ACCESSORIES

TAB ⑤ GRAB BARS/DOOR PULLS + GRAB BARS FOR HANDSHOWERS

TAB ⑥ DECORATIVE SPECIALTIES (Supply Valves, P Traps, Tub + Shower Drains)

TAB ⑦ CHANNEL DRAINS

TAB ⑧ SPA COLLECTION (Water Features)

TAB ⑨ REPLACEMENT PARTS

TAB ⑩ GENERAL INFORMATION

TAB ⑪ PRICING INDEX + GLOSSARY

TAB ⑫ STEAM VALVE ORIGINAL (Luxury Stainless Steel Kitchen Faucets)

Astor Collection



JACLO
Confidence from start to finish.™



HANDLE STYLES



T686



T685



T688



T684

NOTES



ASTOR FAUCETS

8"-12" WIDESPREADS



ITEM	SPECIFICS	CHROME	GROUP A	GROUP B	GROUP C
6870-T686-	8"-12" Widespread	\$450.00	\$485.00	\$575.00	\$650.00

- All brass 8"-12" widespread faucet includes brass pop-up drain
- ¼ turn ceramic valves
- Stationary spout with water saving 1.5 GPM aerator

INCLUDES BOTH:

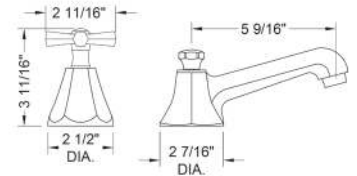

ITEM	SPECIFICS	CHROME	GROUP A	GROUP B	GROUP C
6870-T685-	8"-12" Widespread	\$450.00	\$485.00	\$575.00	\$650.00

- All brass 8"-12" widespread faucet includes brass pop-up drain
- ¼ turn ceramic valves
- Stationary spout with water saving 1.5 GPM aerator
- ADA compliant levers

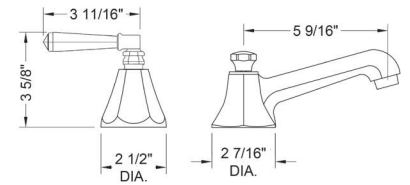

ITEM	SPECIFICS	CHROME	GROUP A	GROUP B	GROUP C
6870-T688-	8"-12" Widespread	\$450.00	\$485.00	\$575.00	\$650.00

- All brass 8"-12" widespread faucet includes brass pop-up drain
- ¼ turn ceramic valves
- Stationary spout with water saving 1.5 GPM aerator

INCLUDES BOTH:

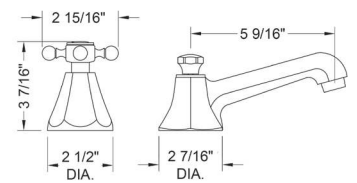
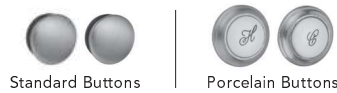

ITEM	SPECIFICS	CHROME	GROUP A	GROUP B	GROUP C
6870-T684-	8"-12" Widespread	\$450.00	\$485.00	\$575.00	\$650.00

- All brass 8"-12" widespread faucet includes brass pop-up drain
- ¼ turn ceramic valves
- Stationary spout with water saving 1.5 GPM aerator
- ADA compliant levers

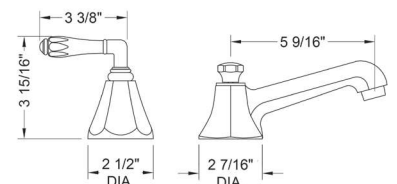

ASTOR ROMAN TUB SET—LOW PROFILE SPOUT

ROMAN TUB ONLY



TRIM ONLY



Shown: 6970-T685 -TRIM-
Trim only

ITEM	CHROME	GROUP A	GROUP B	GROUP C
6970-T686-TRIM-	\$450.00	\$600.00	\$700.00	\$825.00
6970-T685-TRIM-	\$450.00	\$600.00	\$700.00	\$825.00
6970-T688-TRIM-	\$450.00	\$600.00	\$700.00	\$825.00
6970-T684-TRIM-	\$450.00	\$600.00	\$700.00	\$825.00

- All brass roman deck mount tub set trim
- Quick connect/disconnect spout
- Stationary spout includes full flow aerator
- Requires J-6912 rough in kit below

T688 INCLUDES BOTH:



T686 INCLUDES BOTH:



Handle Options:

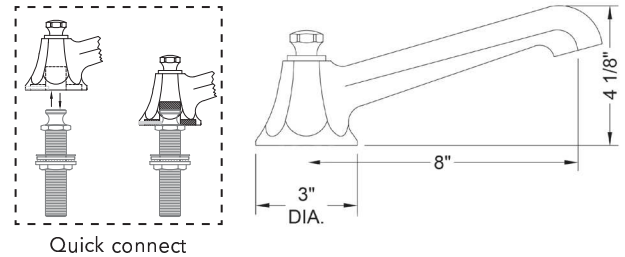

ROMAN TUB ROUGH KIT (REQUIRED)



ITEM	ROUGH
J-6912	\$250.00

- Rough in kit for roman tub
- 3/4" 1/4 turn high flow 12 GPM @ 60 PSI ceramic valves
- Quick connect/disconnect deck nipple for spout
- 3/4" IPS brass tee

ROMAN TUB SPOUT HOOK UP KIT (OPTIONAL)



ITEM	ROUGH
J-RT-KIT	\$120.00

- Kit for connecting roman tub rough kit
- 3/4" IPS connections
- Consists of:
 - (2 each) 3/4" MIP x 3/4" FIP 18" flexible hoses

ASTOR ROMAN TUB SET—LOW PROFILE SPOUT

ROMAN TUB WITH DIVERTER & HANDSHOWER



TRIM ONLY WITH HANDSHOWER



Shown: 6970-T685-S-423-TRIM-
Trim only with S423 handshower (straight)

ITEM	CHROME	GROUP A	GROUP B	GROUP C
6970-T686-S-423-TRIM-	\$760.00	\$1086.00	\$1285.00	\$1570.00
6970-T685-S-423-TRIM-	\$760.00	\$1086.00	\$1285.00	\$1570.00
6970-T688-S-423-TRIM-	\$760.00	\$1086.00	\$1285.00	\$1570.00
6970-T684-S-423-TRIM-	\$760.00	\$1086.00	\$1285.00	\$1570.00

- All brass roman deck mount tub set trim
- Quick connect/disconnect spout
- Cross handles trim includes both metal & porcelain buttons
- Stationary spout includes full flow aerator
- Requires J-6910-DIV rough in kit below
- Includes: S423 handshower, 60" double spiral brass hose, 8030 handshower mount & 8019 deck mount sleeve
- Contact factory for alternate handshower

Handle Options:



T686



T685 ♿



T688



T684 ♿

ROMAN TUB DIVERTER ROUGH KIT (REQUIRED)



ITEM	ROUGH
J-6912-DIV-RGH	\$495.00

- Rough in kit for roman tub
- ¾" 1/4 turn high flow 12 GPM @ 60 PSI ceramic valves
- Quick connect/disconnect deck nipple for spout
- 7010-BF double check valve, ½" IPS coupling 3024-HP 24" high pressure hose, J-1209 deck diverter valve, ¾" IPS brass tee

ROMAN TUB SPOUT HOOK UP KIT (OPTIONAL)



ITEM	ROUGH
J-RT-KIT	\$120.00

- Kit for connecting roman tub rough kit
- ¾" IPS connections
- Consists of:
 - (2 each) ¾" MIP x ¾" FIP 18" flexible hoses

ASTOR ROMAN TUB SET—HIGH PROFILE SPOUT

ROMAN TUB ONLY



TRIM ONLY



Shown: 6972-T685 -TRIM-
Trim only

ITEM	CHROME	GROUP A	GROUP B	GROUP C
6972-T686-TRIM-	\$450.00	\$600.00	\$700.00	\$825.00
6972-T685-TRIM-	\$450.00	\$600.00	\$700.00	\$825.00
6972-T688-TRIM-	\$450.00	\$600.00	\$700.00	\$825.00
6972-T684-TRIM-	\$450.00	\$600.00	\$700.00	\$825.00

- All brass roman deck mount tub set trim
- Quick connect/disconnect spout
- Stationary spout includes full flow aerator
- Requires J-6912 rough in kit below

T688 INCLUDES BOTH:

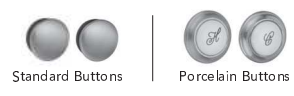

T686 INCLUDES BOTH:



Handle Options:

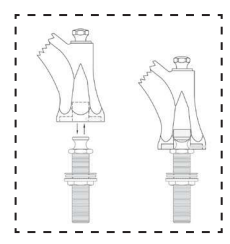

Quick connect

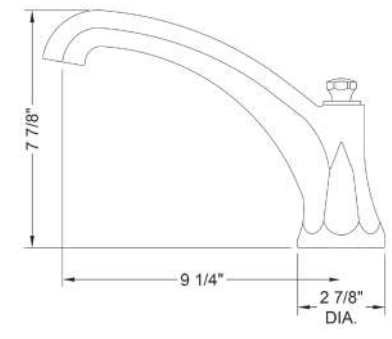

ROMAN TUB ROUGH KIT (REQUIRED)



ITEM	ROUGH
J-6912	\$250.00

- Rough in kit for roman tub
- 3/4" 1/4 turn high flow 12 GPM @ 60 PSI ceramic valves
- Quick connect/disconnect deck nipple for spout
- 3/4" IPS brass tee

ROMAN TUB SPOUT HOOK UP KIT (OPTIONAL)

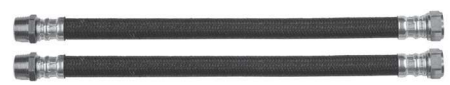

ITEM	ROUGH
J-RT-KIT	\$120.00

- Kit for connecting roman tub rough kit
- 3/4" IPS connections
- Consists of:
 - (2 each) 3/4" MIP x 3/4" FIP 18" flexible hoses

ASTOR ROMAN TUB SET—HIGH PROFILE SPOUT

ROMAN TUB WITH DIVERTER & HANDSHOWER



TRIM ONLY WITH HANDSHOWER



Shown: 6972-T685-S-423-TRIM-
Trim only with S423 handshower (straight)

ITEM	CHROME	GROUP A	GROUP B	GROUP C
6972-T686-S-423-TRIM-	\$760.00	\$1086.00	\$1285.00	\$1570.00
6972-T685-S-423-TRIM-	\$760.00	\$1086.00	\$1285.00	\$1570.00
6972-T688-S-423-TRIM-	\$760.00	\$1086.00	\$1285.00	\$1570.00
6972-T684-S-423-TRIM-	\$760.00	\$1086.00	\$1285.00	\$1570.00

- All brass roman deck mount tub set trim
- Quick connect/disconnect spout
- Cross handles trim includes both metal & porcelain buttons
- Stationary spout includes full flow aerator
- Requires J-6910-DIV rough in kit below
- Includes: S423 handshower, 60" double spiral brass hose, 8030 handshower mount & 8019 deck mount sleeve
- Contact factory for alternate handshower

Handle Options:



T686



T685 ♿



T688



T684 ♿

ROMAN TUB DIVERTER ROUGH KIT (REQUIRED)



ITEM	ROUGH
J-6912-DIV-RGH	\$495.00

- Rough in kit for roman tub
- 3/4" 1/4 turn high flow 12 GPM @ 60 PSI ceramic valves
- Quick connect/disconnect deck nipple for spout
- 7010-BF double check valve, 1/2" IPS coupling 3024-HP 24" high pressure hose, J-1209 deck diverter valve, 3/4" IPS brass tee

ROMAN TUB SPOUT HOOK UP KIT (OPTIONAL)



ITEM	ROUGH
J-RT-KIT	\$120.00

- Kit for connecting roman tub rough kit
- 3/4" IPS connections
- Consists of:
 - (2 each) 3/4" MIP x 3/4" FIP 18" flexible hoses

WALL MOUNTED ACCESSORIES



JACLO
Confidence from start to finish.™

ROBE HOOK



ITEM	CHROME	GROUP A	GROUP B	GROUP C
4870-RH-	\$84.00	\$105.00	\$125.00	\$145.00

- All brass robe hook
- Universal mounting hardware included
- 3/8" projection

TOWEL RING



ITEM	CHROME	GROUP A	GROUP B	GROUP C
4870-TR-	\$112.00	\$138.00	\$168.00	\$195.00

- All brass 6" towel ring
- Universal mounting hardware included
- 3/8" projection

TOWEL BARS



ITEM	SPECIFICS	CHROME	GROUP A	GROUP B	GROUP C
4870-TB-24-	24"	\$175.00	\$245.00	\$295.00	\$375.00
4870-TB-18-	18"	\$165.00	\$220.00	\$280.00	\$360.00

- All brass towel bars
- Universal mounting hardware included
- 3/8" projection

TOILET PAPER HOLDER



ITEM	CHROME	GROUP A	GROUP B	GROUP C
4870-TP-	\$175.00	\$245.00	\$295.00	\$375.00

- All brass double post toilet paper holder
- Universal mounting hardware included
- 3/8" projection

SOAP DISH



ITEM	CHROME	GROUP A	GROUP B	GROUP C
4870-SD-	\$145.00	\$175.00	\$225.00	\$300.00

- All brass & glass soap dish
- Universal mounting hardware included
- 4 3/4" projection
- 5/8" x 3/8" thick glass dish

TOOTHBRUSH & TUMBLER HOLDER



ITEM	CHROME	GROUP A	GROUP B	GROUP C
4870-TH-	\$145.00	\$175.00	\$225.00	\$300.00

- All brass & glass tooth brush & tumbler holder
- Universal mounting hardware included
- 4 3/4" projection
- Tumbler not included
- 5/8" x 3/8" thick glass dish

GLASS SHELF



ITEM	CHROME	GROUP A	GROUP B	GROUP C
4870-GS-24-	\$265.00	\$340.00	\$390.00	\$485.00

- All brass & glass 24" shelf
- Universal mounting hardware included
- 5/8" projection
- 3/8" glass thickness

FREE STANDING ACCESSORIES

CUP HOLDER



ITEM	CHROME	GROUP A	GROUP B	GROUP C
DD-15-	\$95.00	\$140.00	\$160.00	\$195.00

- Brass free standing cup holder
- 4⁵/₈" tall with 3" round base
- Holds 40–3oz paper cups (not included)
- Complements both bathroom & kitchen decor

SOAP/LOTION DISPENSER



ITEM	SPECIFICS	CHROME	GROUP A	GROUP B	GROUP C
LD-10-	Square base	\$195.00	\$265.00	\$295.00	\$350.00
LD-15-	Round base	\$195.00	\$265.00	\$295.00	\$350.00

- All brass free standing soap & lotion dispenser
- 3³/₄" spout
- 5⁵/₈" tall with 3³/₈" square base
- 5⁵/₈" tall with 3" diameter round base
- 4 oz. plastic reservoir
- Complements both bathroom & kitchen decor

TOILET PAPER HOLDERS



ITEM	SPECIFICS	CHROME	GROUP A	GROUP B	GROUP C
TP-10-	Smooth	\$295.00	\$395.00	\$450.00	\$535.00
TP-20-	Reeded	\$295.00	\$395.00	\$450.00	\$535.00

- All brass free standing toilet paper holder
- 26¹/₂" tall with 5¹/₂" weighted base for stability
- Available with both smooth or reeded tubing

SPARE TOILET PAPER HOLDER



ITEM	CHROME	GROUP A	GROUP B	GROUP C
TH-10-	\$275.00	\$350.00	\$395.00	\$450.00

- All brass free standing toilet paper holder
- 17" tall with 5¹/₂" weighted base for stability
- Can also be used as a free standing paper towel holder
- Holds 3-4 rolls of toilet tissue

Don't Forget JACLO has:



PAGE 4-5 FINISHES + POLICIES

PAGE 6-21 TABLE OF CONTENTS

TAB ① FAUCET COLLECTIONS, ROMAN TUBS + ACCESSORIES

TAB ② SHOWER TRIM, TUB + SHOWER VALVES + SPOUTS

TAB ③ SHOWERHEADS, ARMS + ESCUTCHEONS

TAB ④ HANDSHOWERS, HOSES, BIDET + HANDSHOWER ACCESSORIES

TAB ⑤ GRAB BARS/DOOR PULLS + GRAB BARS FOR HANDSHOWERS

TAB ⑥ DECORATIVE SPECIALTIES (Supply Valves, P Traps, Tub + Shower Drains)

TAB ⑦ CHANNEL DRAINS

TAB ⑧ SPA COLLECTION (Water Features)

TAB ⑨ REPLACEMENT PARTS

TAB ⑩ GENERAL INFORMATION

TAB ⑪ PRICING INDEX + GLOSSARY

TAB ⑫ STEAM VALVE ORIGINAL (Luxury Stainless Steel Kitchen Faucets)



Contempo Collection



HANDLE STYLES



C



L



T672



T638

NOTES



CONTEMPO FAUCETS 8"-12" WIDESPREADS



ITEM	SPECIFICS	CHROME	GROUP A	GROUP B	GROUP C
8880-C-	8"-12" Widespread	\$525.00	\$565.00	\$645.00	\$750.00

- All brass 8"-12" widespread faucet includes brass pop-up drain
- ¼ turn ceramic valves
- Swivel spout with water saving 1.5 GPM aerator

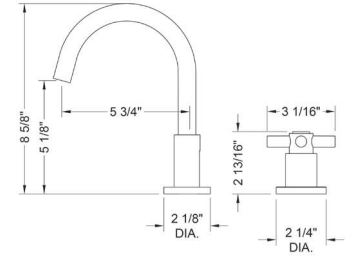

ITEM	SPECIFICS	CHROME	GROUP A	GROUP B	GROUP C
8880-L-	8"-12" Widespread	\$525.00	\$565.00	\$645.00	\$750.00

- All brass 8"-12" widespread faucet includes brass pop-up drain
- ¼ turn ceramic valves
- Swivel spout with water saving 1.5 GPM aerator
- ADA compliant levers

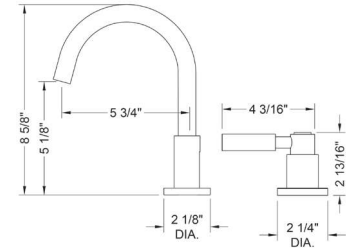

ITEM	SPECIFICS	CHROME	GROUP A	GROUP B	GROUP C
8880-T672-	8"-12" Widespread	\$525.00	\$565.00	\$645.00	\$750.00

- All brass 8"-12" widespread faucet includes brass pop-up drain
- ¼ turn ceramic valves
- Swivel spout with water saving 1.5 GPM aerator

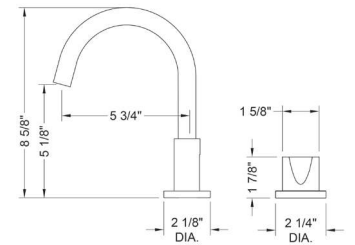

ITEM	SPECIFICS	CHROME	GROUP A	GROUP B	GROUP C
8880-T638-	8"-12" Widespread	\$525.00	\$565.00	\$645.00	\$750.00

- All brass 8"-12" widespread faucet includes brass pop-up drain
- ¼ turn ceramic valves
- Swivel spout with water saving 1.5 GPM aerator
- ADA compliant levers

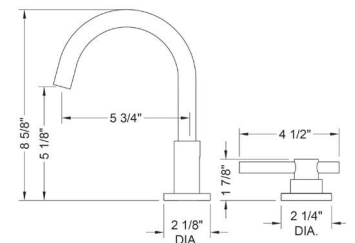

CONTEMPO ROMAN TUB SET

ROMAN TUB ONLY



TRIM ONLY



Shown: 9980-L -TRIM-
Trim only

ITEM	CHROME	GROUP A	GROUP B	GROUP C
9980-C-TRIM-	\$510.00	\$660.00	\$760.00	\$870.00
9980-L-TRIM-	\$510.00	\$660.00	\$760.00	\$870.00
9980-T672-TRIM-	\$510.00	\$660.00	\$760.00	\$870.00
9980-T638-TRIM-	\$510.00	\$660.00	\$760.00	\$870.00

- All brass roman deck mount tub set trim
- Quick connect/disconnect spout
- Swivel spout includes full flow aerator
- Requires J-6910 rough in kit below

Handle Options:

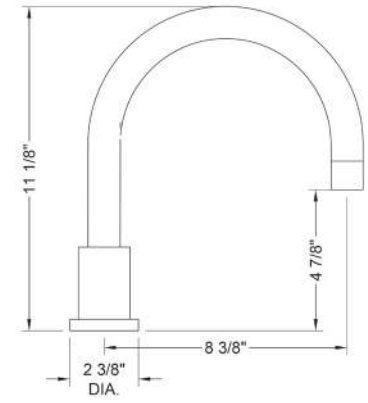
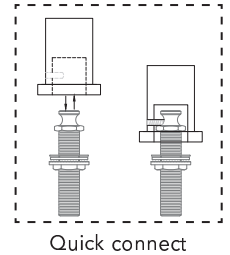

ROMAN TUB ROUGH KIT (REQUIRED)



ITEM	ROUGH
J-6912	\$250.00

- Rough in kit for roman tub
- 3/4" 1/4 turn high flow 12 GPM @ 60 PSI ceramic valves
- Quick connect/disconnect deck nipple for spout
- 3/4" IPS brass tee

ROMAN TUB SPOUT HOOK UP KIT (OPTIONAL)



ITEM	ROUGH
J-RT-KIT	\$120.00

- Kit for connecting roman tub rough kit
- 3/4" IPS connections
- Consists of:
 - (2 each) 3/4" MIP x 3/4" FIP 18" flexible hoses

CONTEMPO ROMAN TUB SET

ROMAN TUB WITH DIVERTER & HANDSHOWER

TRIM ONLY WITH HANDSHOWER



Shown: 9980-L-A-456-TRIM-
Trim only with S456 handshower (angle)



Shown: 9980-L-S-456-TRIM-
Trim only with S456 handshower (straight)

ITEM	CHROME	GROUP A	GROUP B	GROUP C
9980-C-A-456-TRIM-	\$850.00	\$1168.00	\$1380.00	\$1657.00
9980-L-A-456-TRIM-	\$850.00	\$1168.00	\$1380.00	\$1657.00
9980-T672-A-456-TRIM-	\$850.00	\$1168.00	\$1380.00	\$1657.00
9980-T638-A-456-TRIM-	\$850.00	\$1168.00	\$1380.00	\$1657.00
9980-C-S-456-TRIM-	\$850.00	\$1168.00	\$1380.00	\$1657.00
9980-L-S-456-TRIM-	\$850.00	\$1168.00	\$1380.00	\$1657.00
9980-T672-S-456-TRIM-	\$850.00	\$1168.00	\$1380.00	\$1657.00
9980-T638-S-456-TRIM-	\$850.00	\$1168.00	\$1380.00	\$1657.00

- All brass roman deck mount tub set trim
- Quick connect/disconnect spout
- Swivel spout includes full flow aerator
- Requires J-6910-DIV rough in kit below
- Includes: S456 handshower, 60" double spiral brass hose, 8029 or 8030 handshower mount and 8019 deck mount sleeve
- Contact factory for alternate handshower

Handle Options:



C



L 



T672



T638 

ROMAN TUB DIVERTER ROUGH KIT (REQUIRED)



ITEM	ROUGH
J-6912-DIV-RGH	\$495.00

- Rough in kit for roman tub
- 3/4" 1/4 turn high flow 12 GPM @ 60 PSI ceramic valves
- Quick connect/disconnect deck nipple for spout
- 7010-BF double check valve, 1/2" IPS coupling 3024-HP 24" high pressure hose, J-1209 deck diverter valve, 3/4" IPS brass tee

ROMAN TUB SPOUT HOOK UP KIT (OPTIONAL)



ITEM	ROUGH
J-RT-KIT	\$120.00

- Kit for connecting roman tub rough kit
- 3/4" IPS connections
- Consists of:
 - (2 each) 3/4" MIP x 3/4" FIP 18" flexible hoses



CONTEMPO I WALL MOUNTED ACCESSORIES

ROBE HOOK



ITEM	CHROME	GROUP A	GROUP B	GROUP C
4880-RH-	\$70.00	\$85.00	\$95.00	\$120.00

- All brass robe hook
- Universal mounting hardware included
- 2⁵/₈" projection

TOWEL BARS

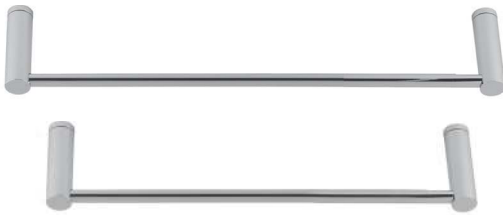

ITEM	SPECIFICS	CHROME	GROUP A	GROUP B	GROUP C
4880-TB-24-	24"	\$140.00	\$165.00	\$220.00	\$265.00
4880-TB-18-	18"	\$130.00	\$155.00	\$210.00	\$255.00

- All brass towel bars
- Universal mounting hardware included
- 2⁵/₈" projection

TOILET PAPER HOLDER



ITEM	CHROME	GROUP A	GROUP B	GROUP C
4880-TP-	\$95.00	\$115.00	\$145.00	\$175.00

- All brass single post toilet paper holder
- Universal mounting hardware included
- 2³/₄" projection

SOAP DISH



ITEM	CHROME	GROUP A	GROUP B	GROUP C
4880-SD-	\$95.00	\$115.00	\$145.00	\$175.00

- All brass & glass soap dish
- Universal mounting hardware included
- 6¹/₄" projection
- Removable 4³/₈" glass dish

GLASS CUP HOLDER



ITEM	CHROME	GROUP A	GROUP B	GROUP C
4880-TH-	\$95.00	\$115.00	\$145.00	\$175.00

- All brass tumbler holder
- Universal mounting hardware included
- Includes glass tumbler
- 5³/₈" projection

CONTEMPO II WALL MOUNTED ACCESSORIES

ROBE HOOK



3501-RH



3501-DRH

ITEM	SPECIFICS	CHROME	GROUP A	GROUP B	GROUP C
3501-RH-	Single	\$45.00	\$55.00	\$65.00	\$95.00
3501-DRH-	Double	\$50.00	\$60.00	\$70.00	\$98.00

- All brass robe hook
- Universal mounting hardware included
- 2¾" projection (3501-RH), 2½" projection (3501-DRH)

TOWEL RING



ITEM	CHROME	GROUP A	GROUP B	GROUP C
3501-TR-	\$55.00	\$85.00	\$105.00	\$135.00

- All brass 7" towel ring
- Universal mounting hardware included
- 1¾" projection

TOWEL BARS



ITEM	SPECIFICS	CHROME	GROUP A	GROUP B	GROUP C
3501-TB-24-	24"	\$95.00	\$125.00	\$165.00	\$195.00
3501-TB-18-	18"	\$85.00	\$115.00	\$145.00	\$175.00

- All brass towel bars
- Universal mounting hardware included
- 2¾" projection

TOILET PAPER HOLDER



3501-LTP



3501-STP

ITEM	SPECIFICS	CHROME	GROUP A	GROUP B	GROUP C
3501-LTP-	Open ring	\$55.00	\$85.00	\$105.00	\$135.00
3501-STP-	Straight	\$55.00	\$85.00	\$105.00	\$135.00

- All brass single post toilet paper holder
- Universal mounting hardware included
- 2" projection (3501-LTP), 2¾" projection (3501-STP)

SOAP DISH



ITEM	CHROME	GROUP A	GROUP B	GROUP C
3501-SD-	\$55.00	\$85.00	\$105.00	\$135.00

- All brass & glass soap dish
- Universal mounting hardware included
- 5¾" projection
- Removable 4⅝" glass dish

GLASS CUP HOLDER



ITEM	CHROME	GROUP A	GROUP B	GROUP C
3501-TH-	\$55.00	\$85.00	\$105.00	\$135.00

- All brass tumbler holder
- Universal mounting hardware included
- Includes glass tumbler
- 4⅞" projection

GLASS SHELF



3501-GS



3501-GSW

ITEM	SPECIFICS	CHROME	GROUP A	GROUP B	GROUP C
3501-GS-	Less rail	\$145.00	\$165.00	\$175.00	\$195.00
3501-GSW-	Wire rail	\$145.00	\$165.00	\$175.00	\$195.00

- All brass & glass 17¾" shelf
- Universal mounting hardware included
- 5¼" projection
- ⅝" glass thickness