

STAKE OUT			
A-C	6'1"	B-C	12'6-3/8"
A-D	12'6-3/8"	B-D	6'1"
A-E	17'1"	B-E	22'3-1/2"
A-F	20'6-1/4"	B-F	23'3-1/4"
A-G	29'4-1/4"	B-G	23'3-1/4"
A-H	30'-1/4"	B-H	22'3-1/2"
A-I	26'	B-I	16'5-3/4"
A-J	21'3-3/4"	B-J	11'4-1/2"

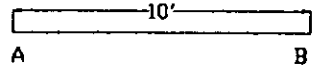

24 BAKER ST, P.O. BOX 100, HASTINGS ON KOL-1Y0
 705-696-2385, 1-800-465-3433, FAX: 705-696-1922

15'X19'X30' R.H. TAMARIN

QTY.	LENGTH	RADIUS	TYPE
1	10'0"	NA	PLAIN
1	8'0"	NA	SKINNER
1	8'0"	NA	PLAIN
2	6'0"	NA	RETURN
7	6'0"	NA	PLAIN
1	6'0"	NA	DOGLEG
9	-	NA	45° OUTSIDE CORNER
3	-	NA	A-FRAME
1	-	NA	N&B PKG
			S.A. 457 sq.ft.
			PER: 86'
1519307M			DATE: 17-11-00

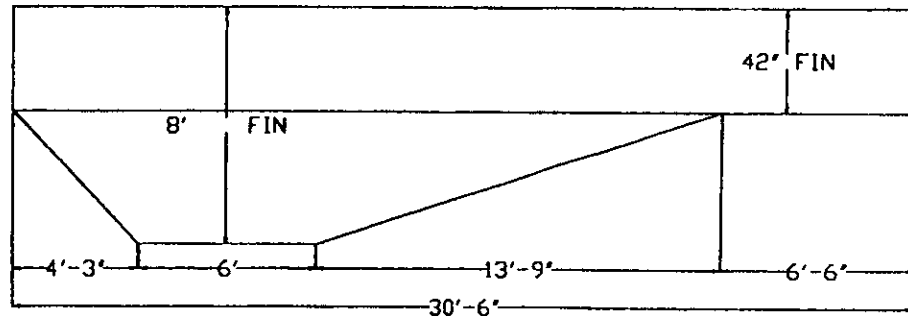

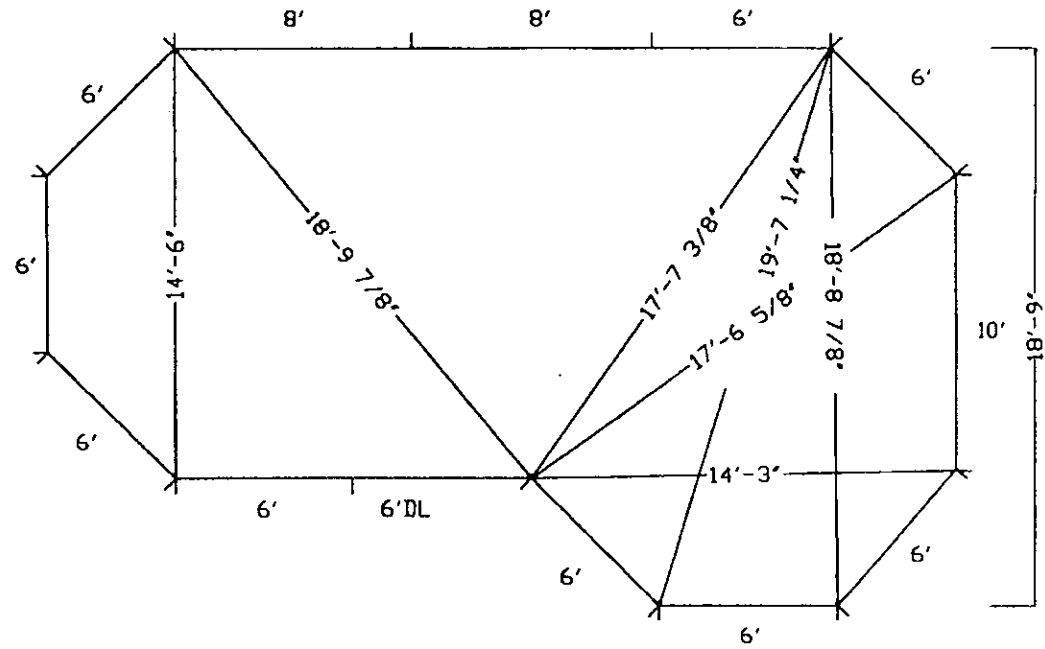
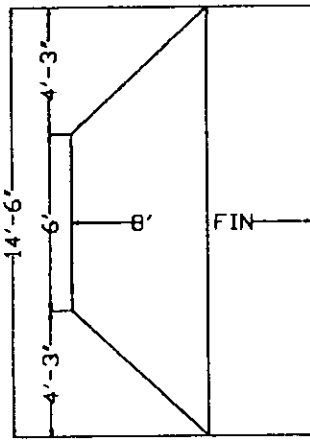

24 BAKER ST., P.O. BOX 100, HASTINGS ON KOL - 1Y0
 705-696-2385, 1-800-465-3433, FAX 705-696-1922

15'X19'X30' R.H. TAMARIN

QTY.	LENGTH	RADIUS	TYPE
1	10'0"	NA	PLAIN
1	8'0"	NA	SKIMMER
1	8'0"	NA	PLAIN
2	6'0"	NA	RETURN
7	6'0"	NA	PLAIN
1	6'0"	NA	DOGLEG
9	-	NA	45° OUTSIDE CORNER
3	-	NA	A-FRAME
1	-	NA	N&B PKG
			S.A.: 457 sq.ft.
			PER: 86'
151930TM			DATE: 17-11-00

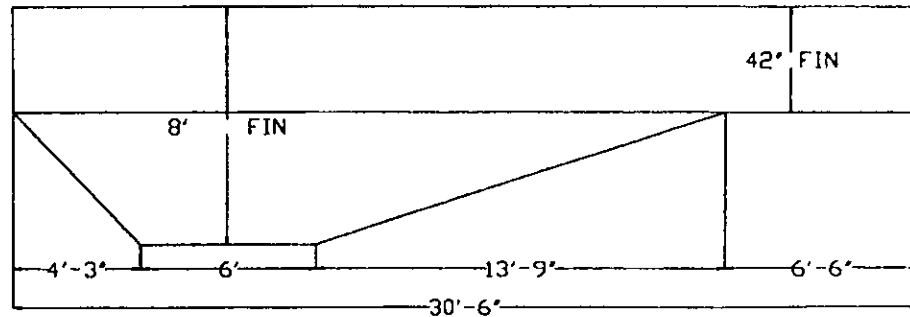

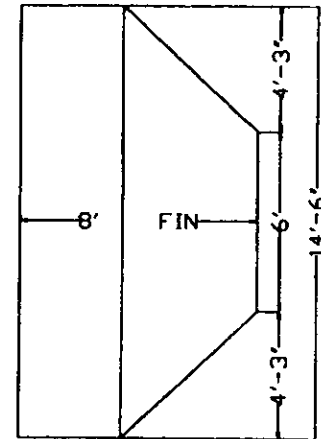
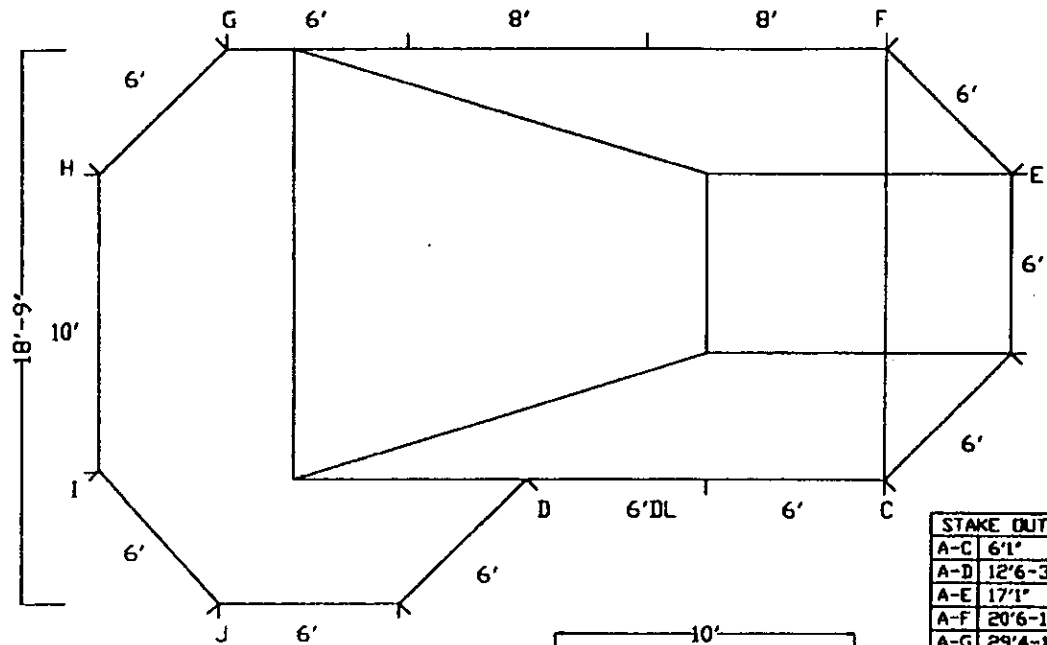

STAKE OUT			
A-C	6'1"	B-C	12'6-3/8"
A-D	12'6-3/8"	B-D	6'1"
A-E	17'1"	B-E	22'3-1/2"
A-F	20'6-1/4"	B-F	23'3-1/4"
A-G	29'4-1/4"	B-G	23'3-1/4"
A-H	30'-1/4"	B-H	22'3-1/2"
A-I	26'	B-I	16'3-3/4"
A-J	21'3-3/4"	B-J	11'4-1/2"

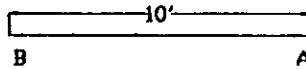

24 BAKER ST, P.O. BOX 100, HASTINGS ON KOL - 1YO
 705-696-2385, 1-800-465-3433, FAX: 705-696-1922

15'X19'X30' L.H. TAMARIN

QTY.	LENGTH	RADIUS	TYPE
1	10'0"	NA	PLAIN
1	8'0"	NA	SKIMMER
1	8'0"	NA	PLAIN
2	6'0"	NA	RETURN
7	6'0"	NA	PLAIN
1	6'0"	NA	DOG LEG
9	-	NA	45° OUTSIDE CORNER
3	-	NA	A-FRAME
1	-	NA	N&B PKG
			S.A.: 457 sq.ft.
			PER: 86'
151930TM			DATE: 17-11-00

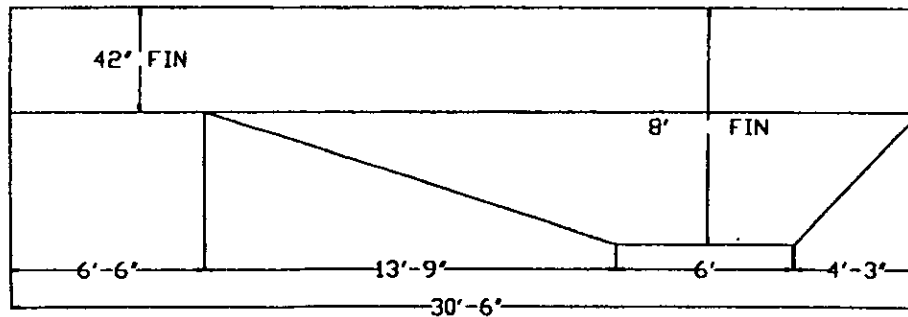

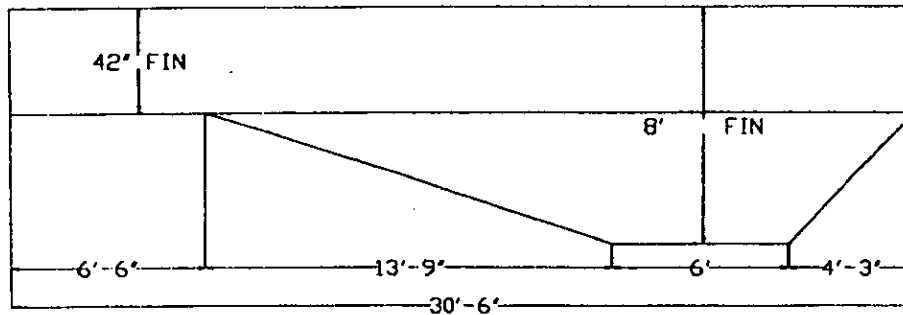
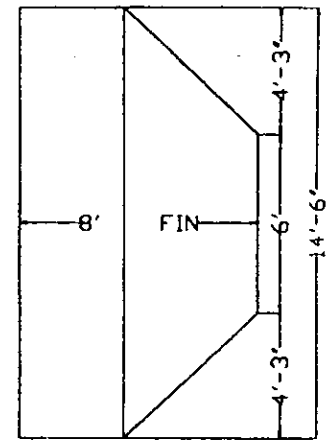
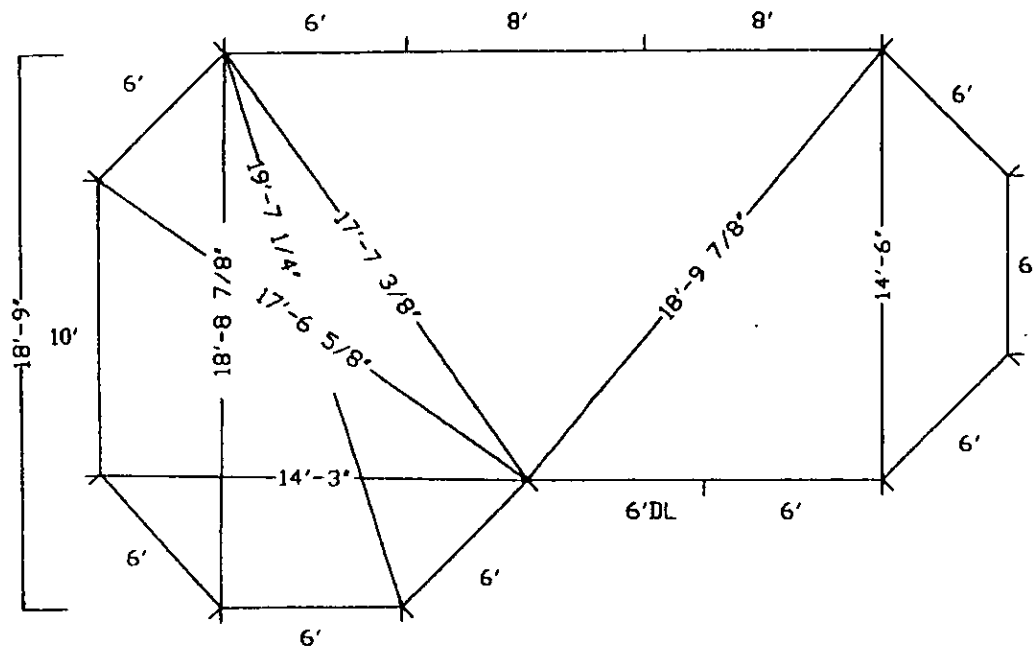

24 BAKER ST. P.O. BOX 100, HASTINGS ON KOL - NY
 705-696-2385, 1-800-465-3433, FAX: 705-696-1922

15'X19'X30' L.H. TAMARIN

QTY.	LENGTH	RADIUS	TYPE
1	10'0"	NA	PLAIN
1	8'0"	NA	SKIMMER
1	8'0"	NA	PLAIN
2	6'0"	NA	RETURN
7	6'0"	NA	PLAIN
1	6'0"	NA	DOGLEG
9	-	NA	45° OUTSIDE CORNER
3	-	NA	A-FRAME
1	-	NA	N&B PKG
			S.A.: 457 sq.ft.
			PER: 86'
151930TM			DATE: 17-11-00

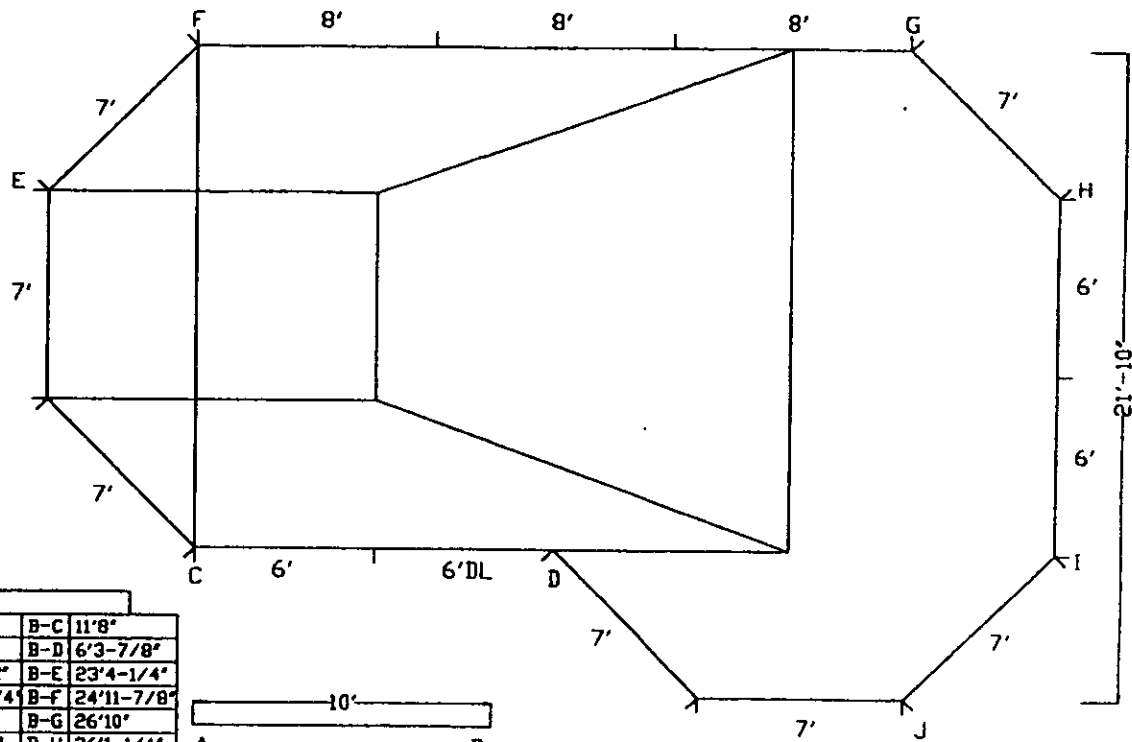
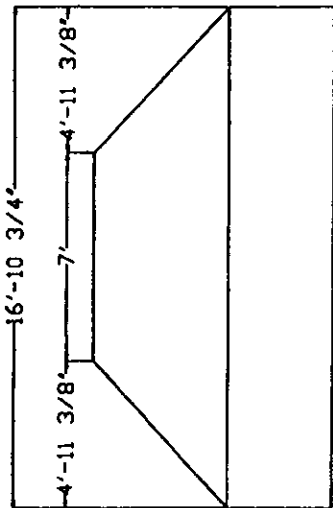

STAKE OUT	
A-C 6'	B-C 11'8"
A-D 13'5"	B-D 6'3-7/8"
A-E 18'7-1/2"	B-E 23'4-1/4"
A-F 22'10-3/4"	B-F 24'11-7/8"
A-G 33'2"	B-G 26'10"
A-H 34'-3/4"	B-H 26'1-1/4"
A-I 29'6-3/4"	B-I 19'10-1/4"
A-J 23'11-3/4"	B-J 13'11-7/8"
A-K	B-K
A-L	B-L
A-M	B-M

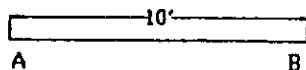

24 BAKER ST. P.O. BOX 100, HASTINGS ON KOL. 110
 705-696-2305, 1-800-465-3433, FAX: 705-696-1922

17'X22'X34' R.H. TAMARIN

QTY.	LENGTH	RADIUS	TYPE
2	8'0"	NA	PLAIN
1	8'0"	NA	SKIMMER
7	7'0"	NA	PLAIN
2	6'0"	NA	RETURN
1	6'0"	NA	PLAIN
1	6'0"	NA	DOGLEG
9	-	NA	45° OUTSIDE CORNER
4	-	NA	A-FRAME
1	-	NA	N&B PKG
			S.A. 596 sq.ft.
			PER: 97'
172234TM			DATE: 17-11-00

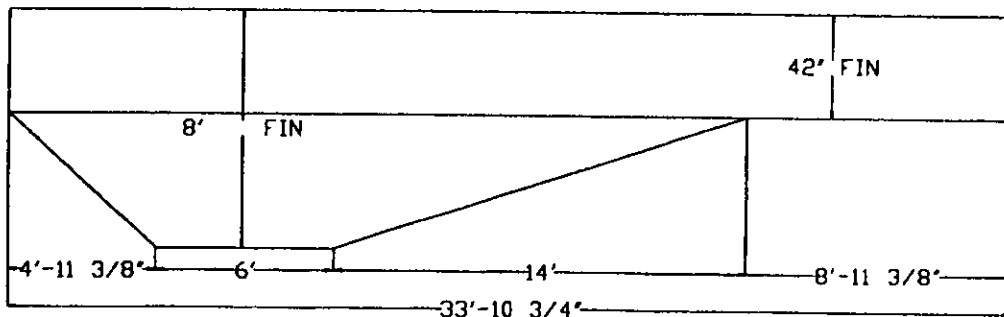

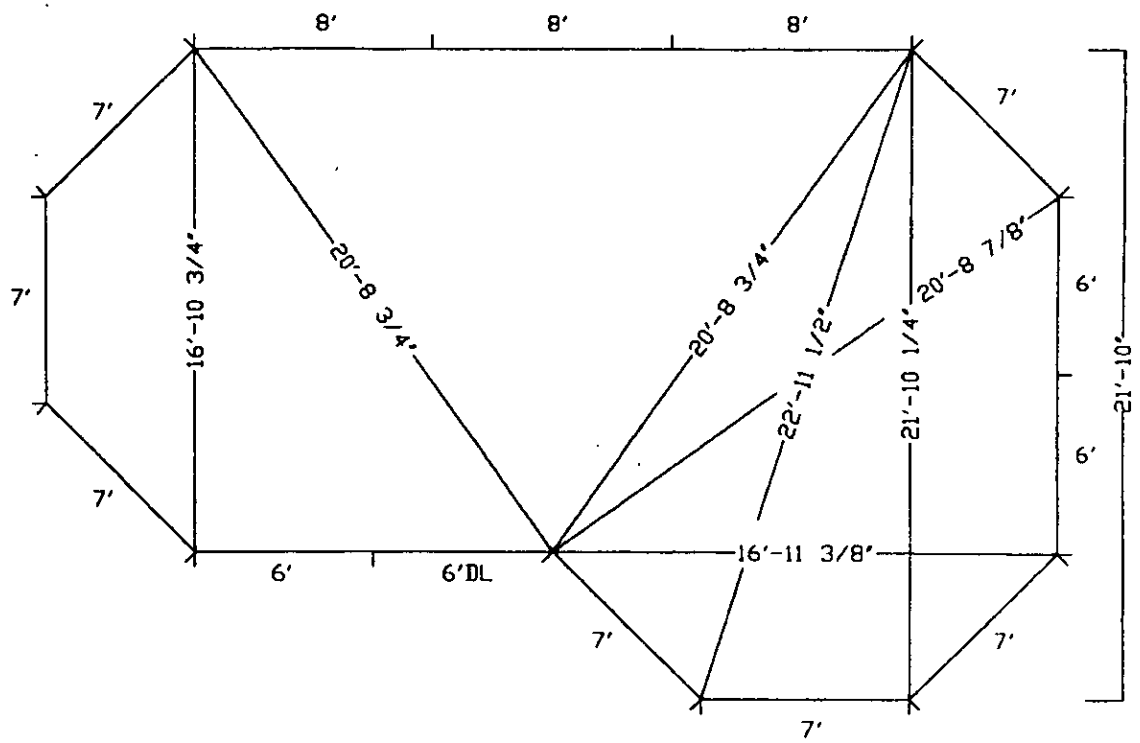
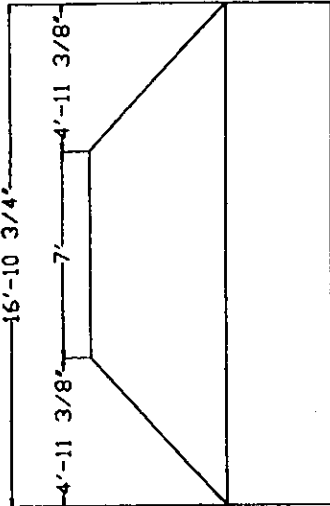

24 BAKER ST. P.O. BOX 100, HASTINGS ON KOL - 1Y0
 705-696-2385 1-800-465-3433 FAX 705-696-1922

17'X22'X34' R.H. TAMARIN

QTY.	LENGTH	RADIUS	TYPE
2	8'0"	NA	PLAIN
1	8'0"	NA	SKIMMER
7	7'0"	NA	PLAIN
2	6'0"	NA	RETURN
1	6'0"	NA	PLAIN
1	6'0"	NA	DOGLEG
9	-	NA	45° OUTSIDE CORNER
4	-	NA	A-FRAME
1	-	NA	N&B PKG
			S.A.: 596 sq.ft.
			PER: 97'
172234TM			DATE: 17-11-00

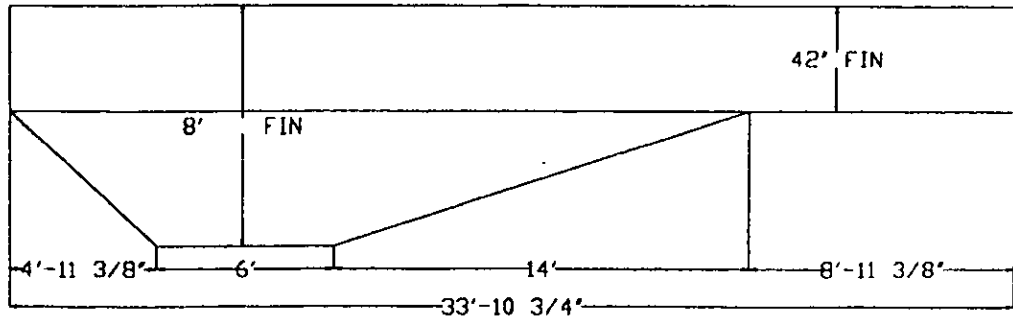

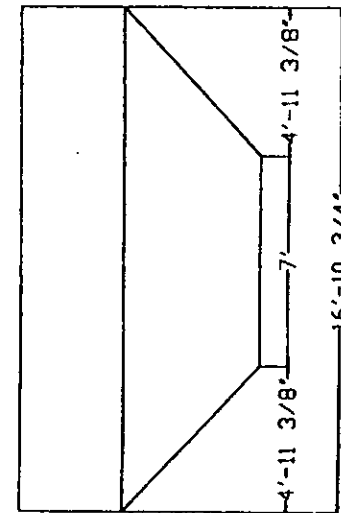
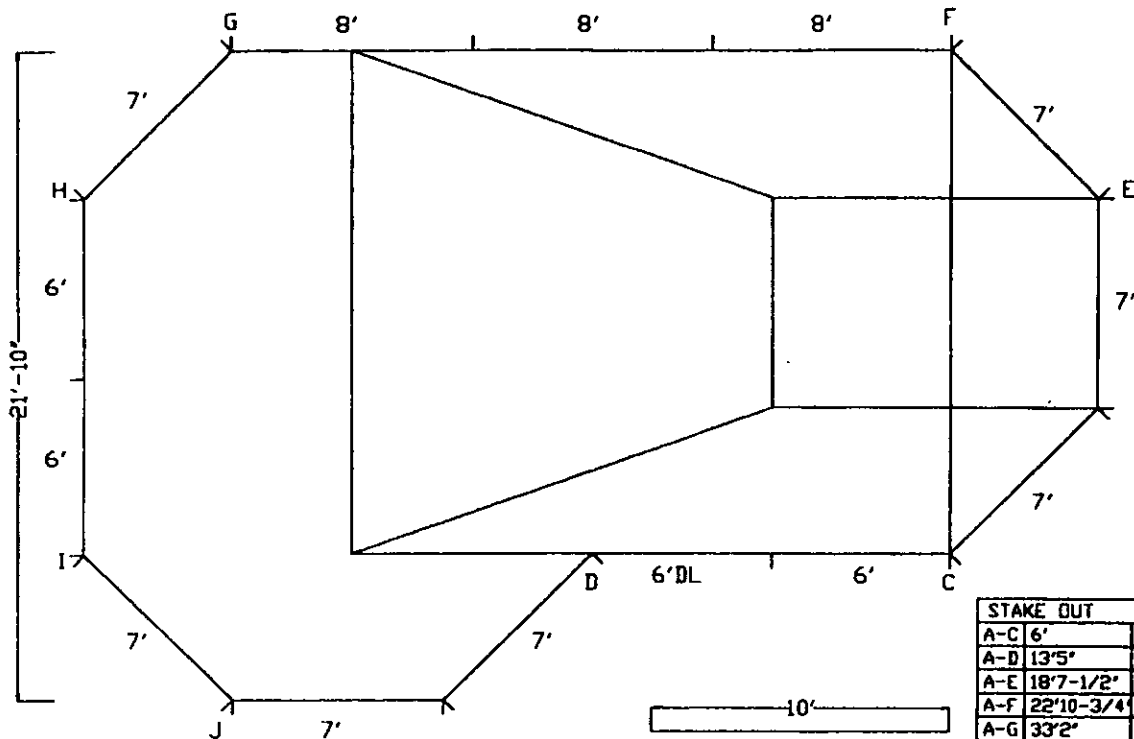

STAKE OUT			
A-C	6'	B-C	11'8"
A-D	13'5"	B-D	6'3-7/8"
A-E	18'7-1/2"	B-E	23'4-1/4"
A-F	22'10-3/4"	B-F	24'11-7/8"
A-G	33'2"	B-G	26'10"
A-H	34'-3/4"	B-H	26'1-1/4"
A-I	29'6-3/4"	B-I	19'10-1/4"
A-J	23'11-3/4"	B-J	13'11-7/8"
A-K		B-K	
A-L		B-L	
A-M		B-M	

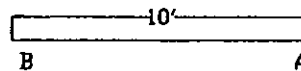

24 BAKER ST, P.O. BOX 100, HASTINGS ON KOL - 1Y0
705-696-2385, 1-800-465-3433, FAX: 705-696-1922

17'X22'X34' L.H. TAMARIN

QTY.	LENGTH	RADIUS	TYPE
2	8'0"	NA	PLAIN
1	8'0"	NA	SKIMMER
7	7'0"	NA	PLAIN
2	6'0"	NA	RETURN
1	6'0"	NA	PLAIN
1	6'0"	NA	DOGLEG
9	-	NA	45° OUTSIDE CORNER
4	-	NA	A-FRAME
1	-	NA	N&B PKG
			S.A. 596 sq.ft.
			PER: 97'
172234TM			DATE: 17-11-00

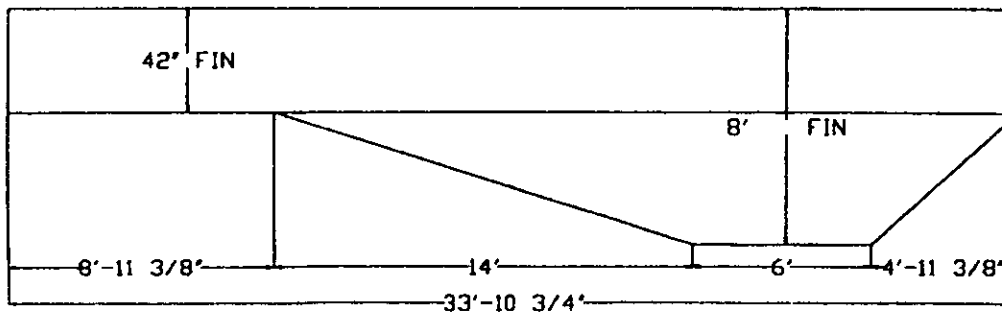

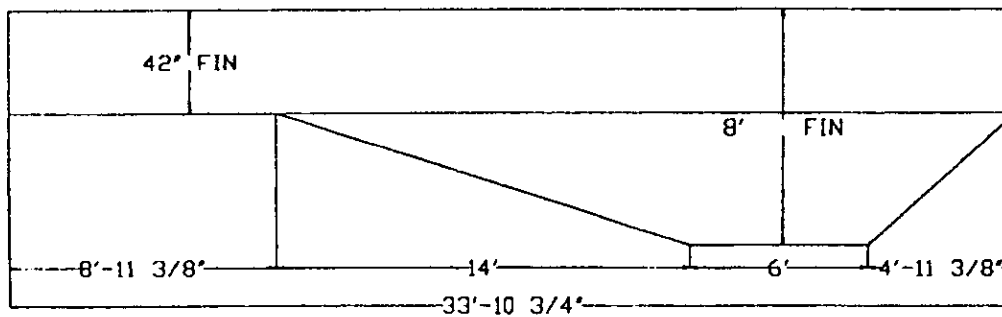
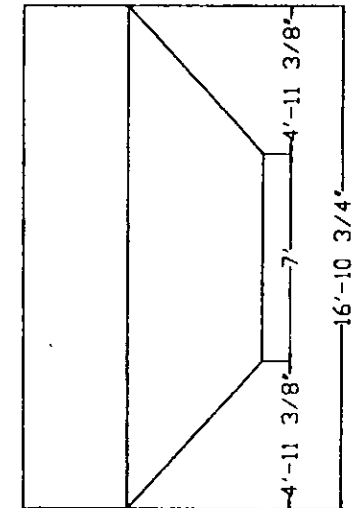
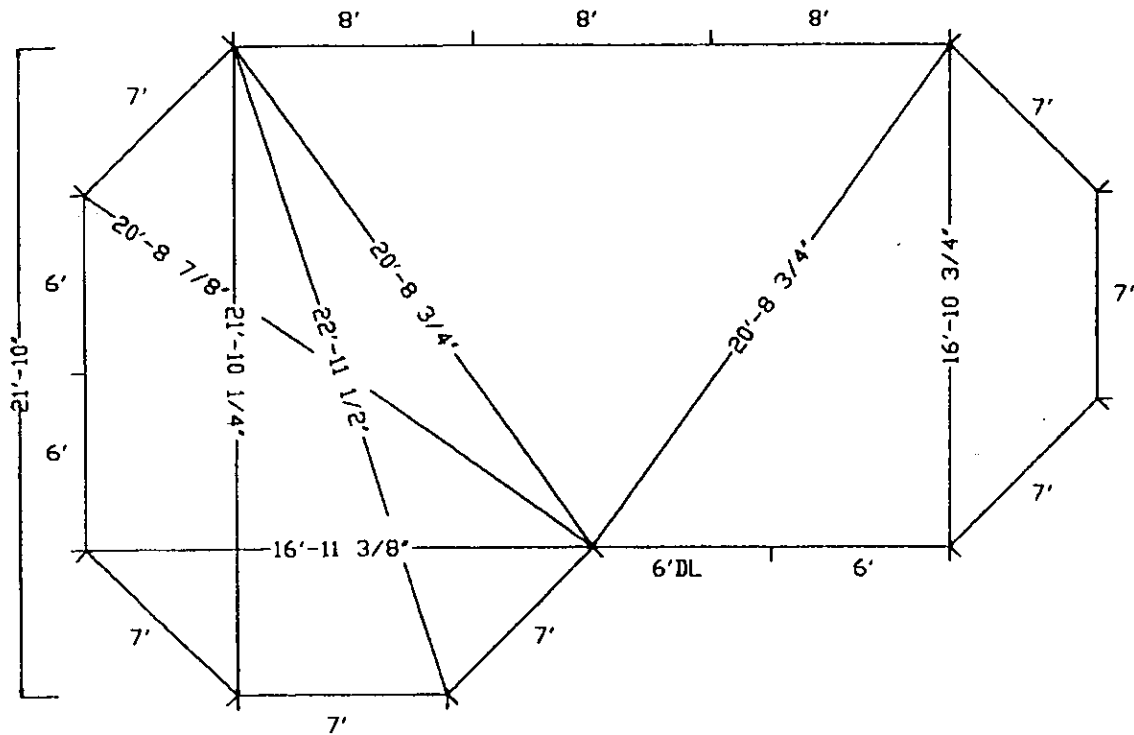

24 BAKER ST. P.O. BOX 100, HASTINGS ON KOL-1Y0
705-696-2385, 1-800-465-3433, FAX 705-696-1922

17'X22'X34' L.H. TAMARIN

QTY.	LENGTH	RADIUS	TYPE
2	8'0"	NA	PLAIN
1	8'0"	NA	SKIMMER
7	7'0"	NA	PLAIN
2	6'0"	NA	RETURN
1	6'0"	NA	PLAIN
1	6'0"	NA	DOGLEG
9	-	NA	45° OUTSIDE CORNER
4	-	NA	A-FRAME
1	-	NA	N&B PKG
			S.A. 596 sq.ft.
			PER: 97'
172234TM			DATE: 17-11-00

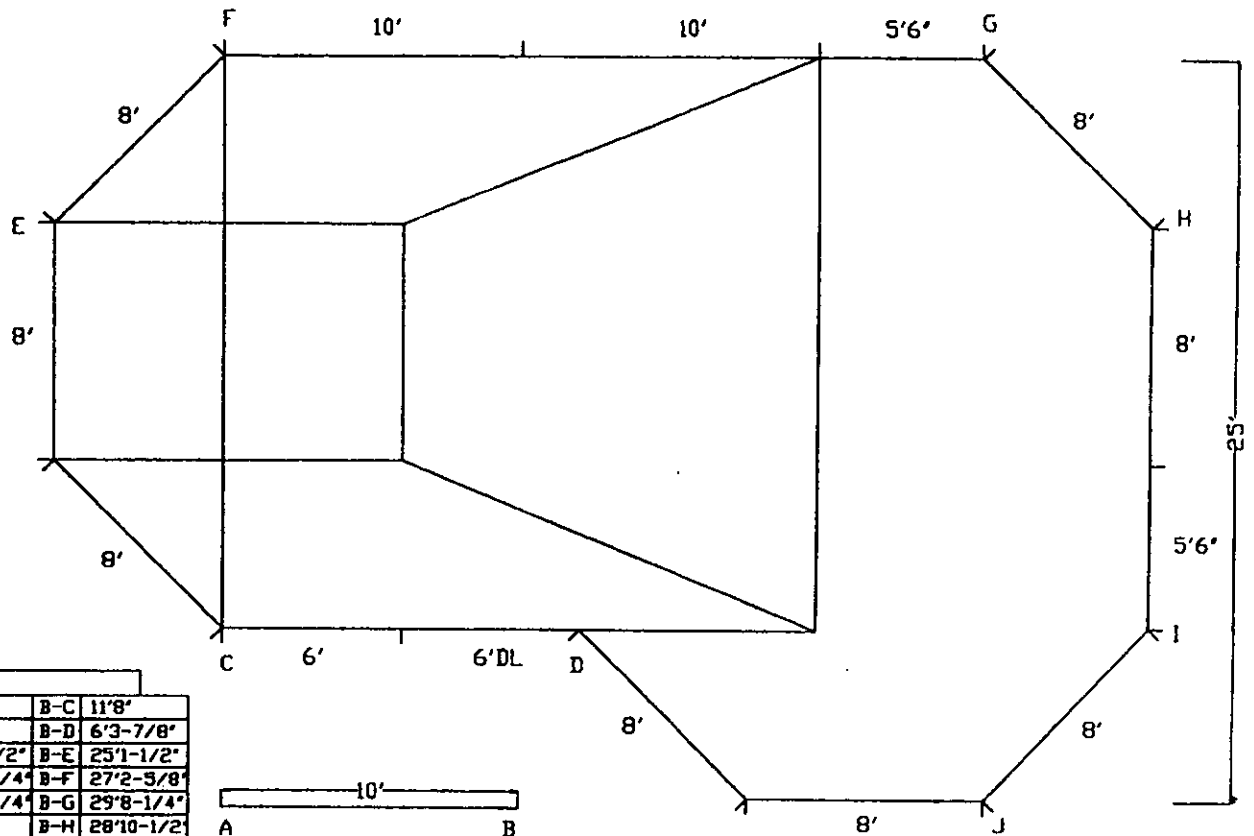
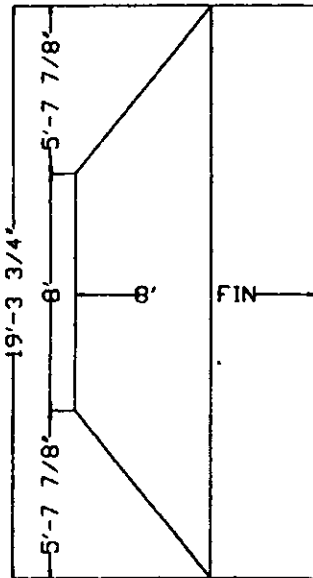

STAKE OUT	
A-C	6'
A-D	13'5"
A-E	20'5-1/2"
A-F	25'3-3/4"
A-G	35'11-1/4"
A-H	36'10"
A-I	31'9"
A-J	25'8"
A-K	
A-L	
A-M	
B-C	11'8"
B-D	6'3-7/8"
B-E	25'1-1/2"
B-F	27'2-5/8"
B-G	29'8-1/4"
B-H	28'10-1/2"
B-I	22'-1/2"
B-J	15'8"
B-K	
B-L	
B-M	



24 BAKER ST. P.O. BOX 100 HASTINGS ON KOL - 1Y0
 705-696-2385 1-800-465-3433 FAX: 705-696-1922

19'X25'X37' R.H. TAMARIN

QTY.	LENGTH	RADIUS	TYPE
1	10'0"	NA	SKIMMER
1	10'0"	NA	PLAIN
1	8'0"	NA	RETURN
7	8'0"	NA	PLAIN
1	6'0"	NA	DOG LEG
1	6'0"	NA	RETURN
2	5'6"	NA	PLAIN
9	-	NA	45° OUTSIDE CORNER
4	-	NA	A-FRAME
1	-	NA	N&B PKG
			S.A. 739 sq.ft.
			PER: 107'
192537TM			DATE: 17-11-00

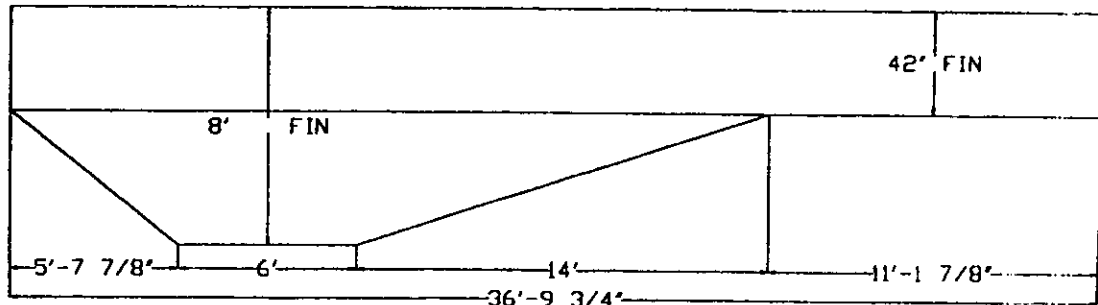

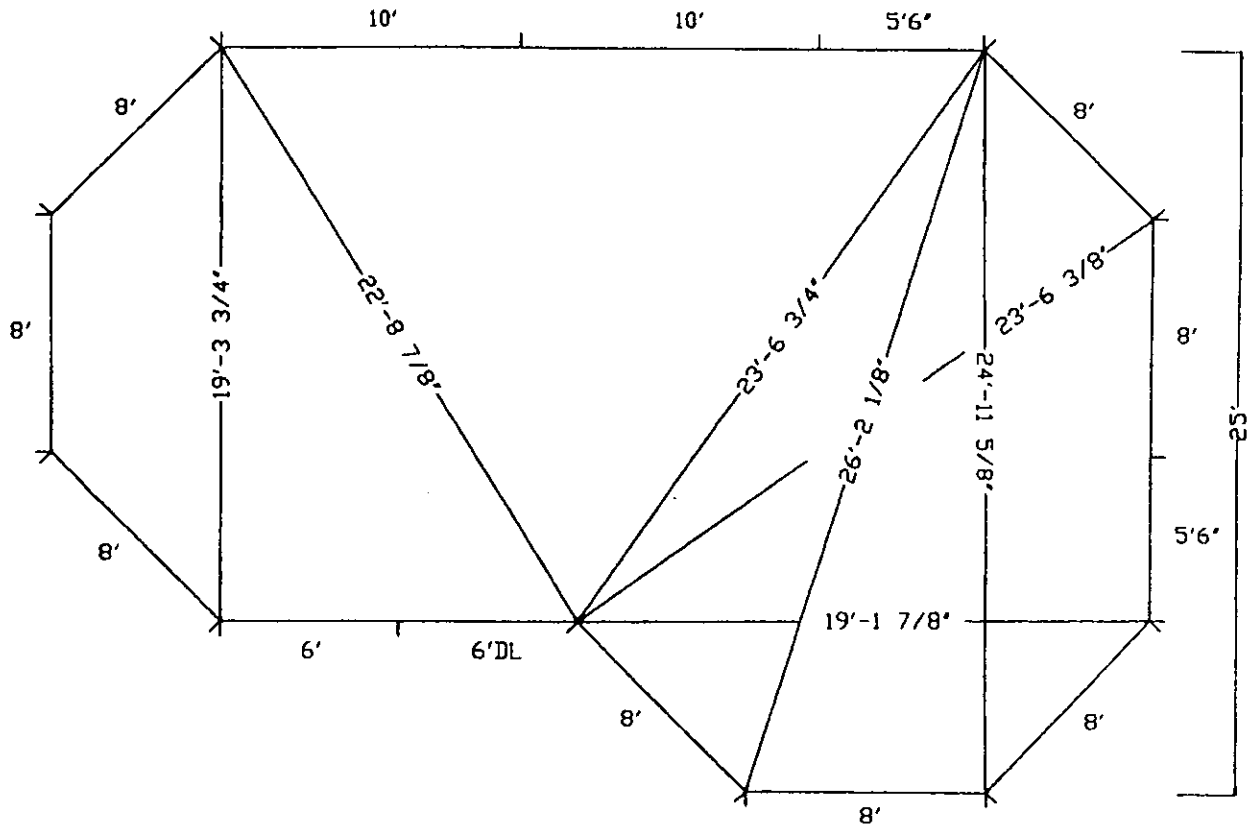
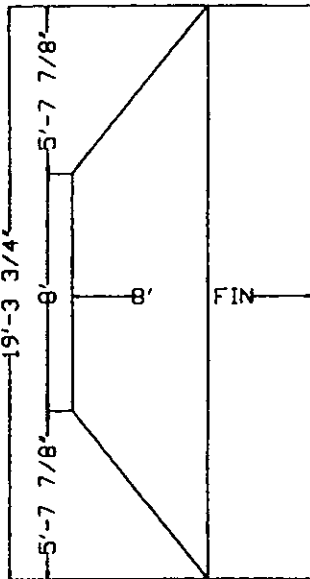

24 BAKER ST. P.O. BOX 100, HASTINGS DN. KQL-1Y0
 705-696-2385, 1-800-465-3433, FAX: 705-696-1922

19'X25'X37' R.H. TAMARIN

QTY.	LENGTH	RADIUS	TYPE
1	10'0"	NA	SKIMMER
1	10'0"	NA	PLAIN
1	8'0"	NA	RETURN
7	8'0"	NA	PLAIN
1	6'0"	NA	DOGLEG
1	6'0"	NA	RETURN
2	5'6"	NA	PLAIN
9	-	NA	45° OUTSIDE CORNER
4	-	NA	A-FRAME
1	-	NA	N&B PKG
			S.A.: 739 sq.ft.
			PER: 107'
192537TM			DATE: 17-11-00

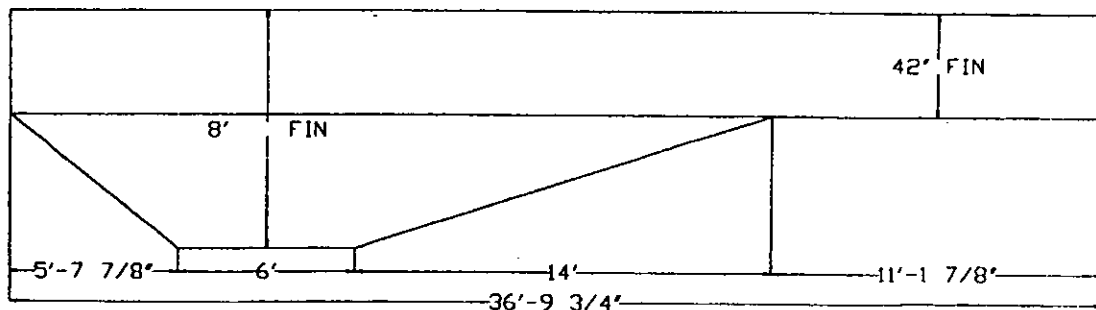

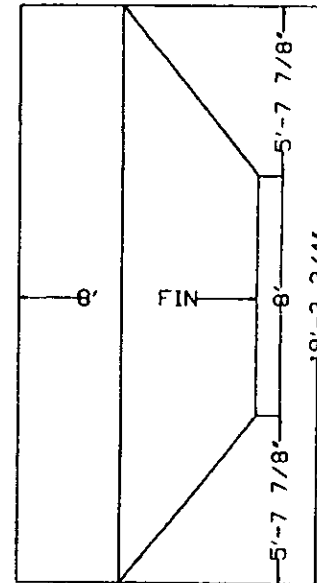
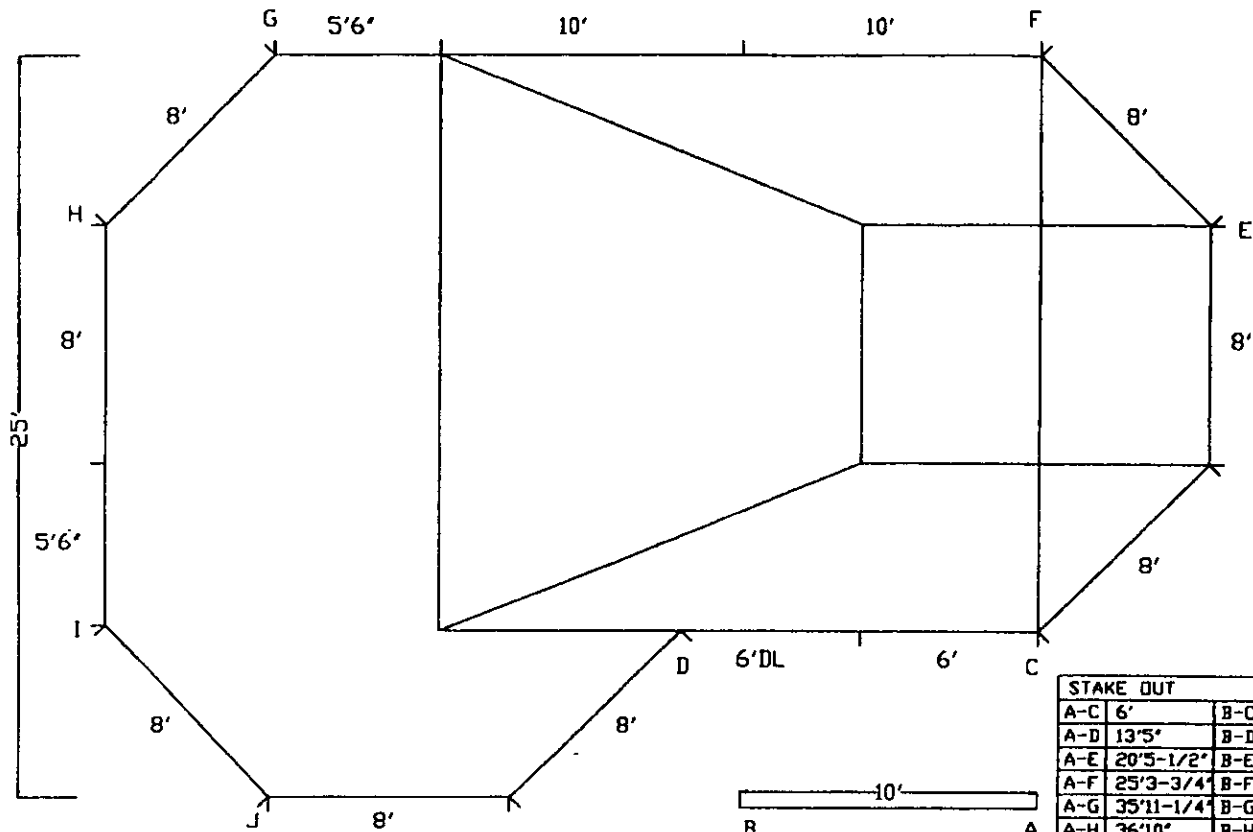

STAKE OUT

A-C	6'	B-C	11'8"
A-D	13'5"	B-D	6'3-7/8"
A-E	20'5-1/2"	B-E	25'1-1/2"
A-F	25'3-3/4"	B-F	27'2-5/8"
A-G	35'11-1/4"	B-G	29'8-1/4"
A-H	36'10"	B-H	28'10-1/2"
A-I	31'9"	B-I	22'-1/2"
A-J	25'8"	B-J	15'8"
A-K		B-K	
A-L		B-L	
A-M		B-M	



24 BAKER ST., P.O. BOX 100, HASTINGS ON KOL - 1Y0
705-696-2385, 1-800-465-3433, FAX: 705-696-1922

19'X25'X37' L.H. TAMARIN

QTY.	LENGTH	RADIUS	TYPE
1	10'0"	NA	SKIMMER
1	10'0"	NA	PLAIN
1	8'0"	NA	RETURN
7	8'0"	NA	PLAIN
1	6'0"	NA	DOGLEG
1	6'0"	NA	RETURN
2	5'6"	NA	PLAIN

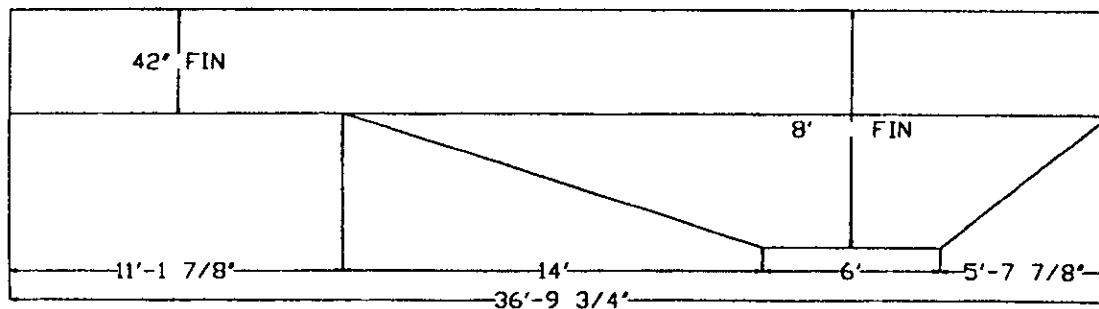

9	-	NA	45° OUTSIDE CORNER
4	-	NA	A-FRAME
1	-	NA	N&B PKG
			S.A. 739 sq.ft.
			PER. 107'
192537TM			DATE: 17-11-00

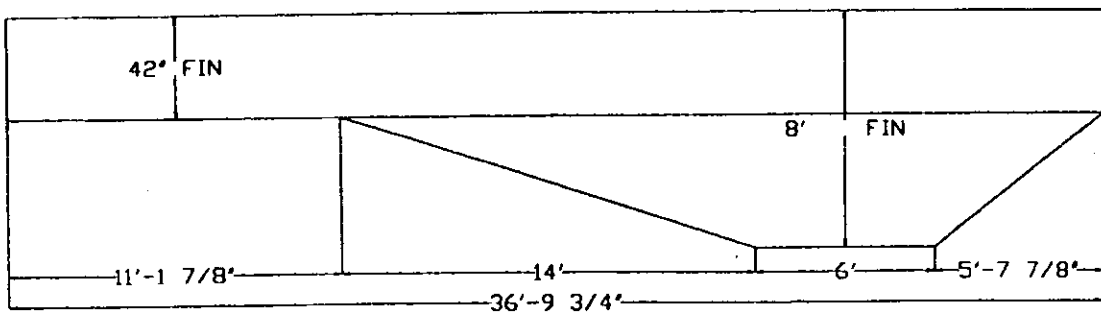
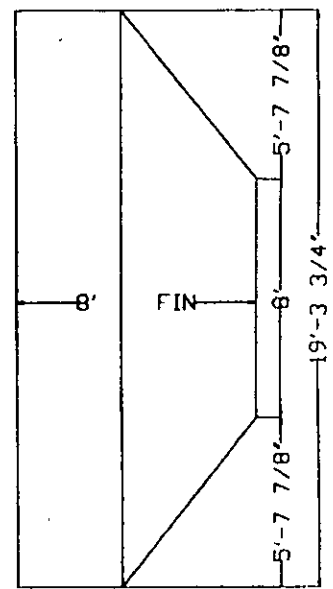
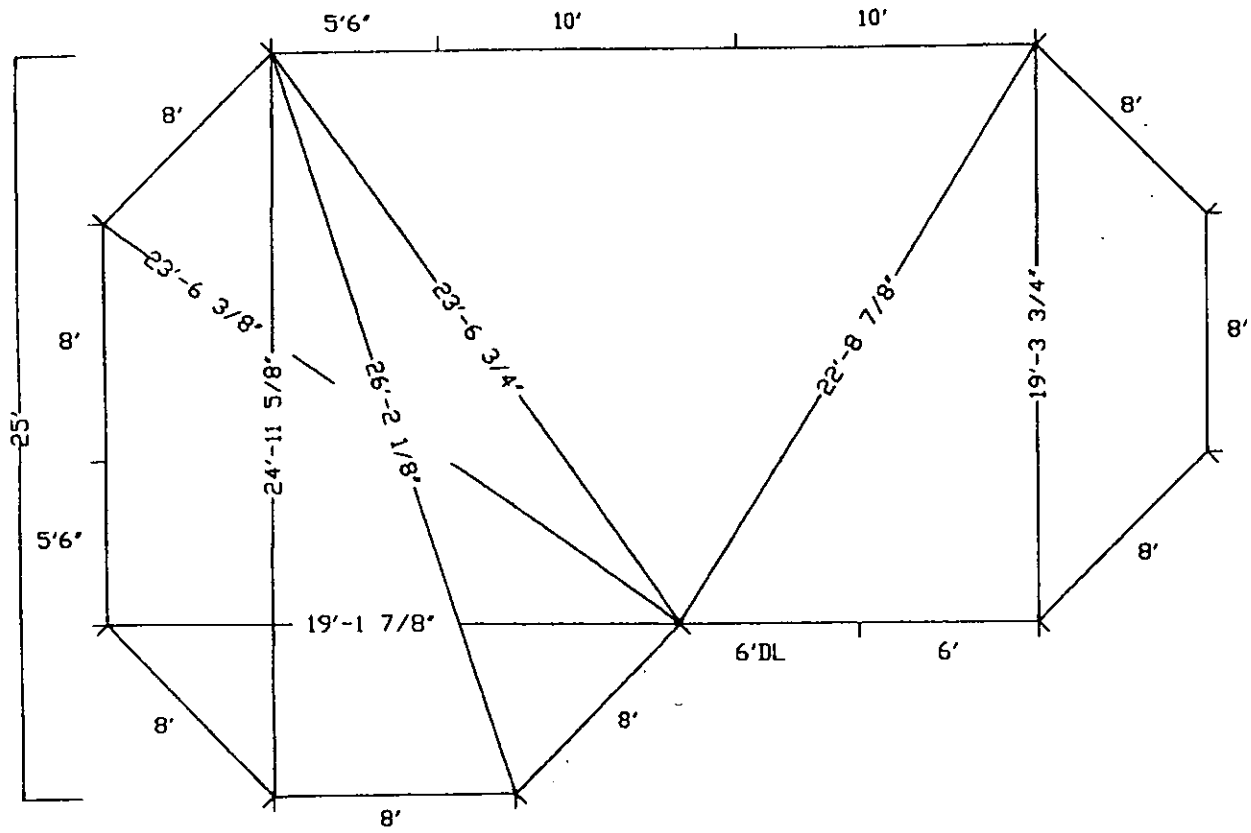

24 BAKER ST., P.O. BOX 100, HASTINGS DN. KOL.-1Y0
 705-696-2385, 1-800-465-3433, FAX: 705-696-1922

19'X25'X37' L.H. TAMARIN

QTY.	LENGTH	RADIUS	TYPE
1	10'0"	NA	SKIMMER
1	10'0"	NA	PLAIN
1	8'0"	NA	RETURN
7	8'0"	NA	PLAIN
1	6'0"	NA	DOGLEG
1	6'0"	NA	RETURN
2	5'6"	NA	PLAIN
9	-	NA	45° OUTSIDE CORNER
4	-	NA	A-FRAME
1	-	NA	N&B PKG
			S.A. 739 sq.ft.
			PER: 107'
192537TM			DATE: 17-11-00