

Implementation Guide
to the
Postsecondary Electronic Standards Council
XML Standards Format
for the
College Academic Record (Transcript)

D R A F T

June 2005

Revision B

Send corrections to:
George Hudachek
Office of Admissions
University of Minnesota—Twin Cities
240 Williamson Hall
231 Pillsbury Drive SE
Minneapolis, MN 55455
Email: g-huda@umn.edu

<u>Page</u>	
v	Introduction
v	Organization and Format
viii	Development History and Acknowledgments
1	College Transcript
2	TransmissionData
4Source
5 --- Organization
8 --- Contacts
9 --- --- Address
11 --- --- CommonAddressDetailsGroup
12 --- --- DomesticAddressDetailsGroup
13 --- --- InternationalAddressDetailsGroup
14 --- --- Phone
15 --- --- Email
16 --- --- URL
17Destination
18 --- Organization
21 --- Contacts
22 --- --- Address
23 --- --- CommonAddressDetailsGroup
24 --- --- DomesticAddressDetailsGroup
25 --- --- InternationalAddressDetailsGroup
26 --- --- Phone
27 --- --- Email
28 --- --- URL
29	Student
31Person
34 --- Birth
35 --- Name
37 --- AlternateName
39 --- HighSchool
41 --- Contacts
43 --- Address
45 --- --- CommonAddressDetailsGroup
46 --- --- DomesticAddressDetailsGroup
47 --- --- InternationalAddressDetailsGroup
48 --- Phone
49 --- Email
50 --- URL
51 --- Gender
52 --- Residency
54 --- Deceased
55AcademicRecord

<u>Page</u>	
57 --- School
60 --- Contacts
61 --- --- Address
63 --- --- CommonAddressDetailsGroup
64 --- --- DomesticAddressDetailsGroup
65 --- --- InternationalAddressDetailsGroup
66 --- --- Phone
67 --- --- Email
68 --- --- URL
69 --- AcademicAward
72 --- AcademicHonors
73 --- AcademicAwardProgram
75 --- --- ProgramSummary
78 --- --- GPA
80 --- --- AcademicHonors
81 --- AcademicDegreeRequirement
82 --- AcademicSummary
84 --- --- GPA
86 --- --- AcademicHonors
87 --- --- AcademicProgram
89 --- AcademicSummary
92 --- GPA
94 --- AcademicHonors
95 --- AcademicProgram
97 --- AcademicSession
99 --- AcademicSessionDetail
101 --- School
104 --- --- Contacts
105 --- --- Address
107 --- --- --- CommonAddressDetailsGroup
108 --- --- --- DomesticAddressDetailsGroup
109 --- --- --- InternationalAddressDetailsGroup
110 --- --- Phone
111 --- --- Email
112 --- --- URL
113 --- StudentLevel
114 --- AcademicProgram
116 --- --- ProgramSummary
119 --- --- GPA
121 --- --- AcademicHonors
122 --- AcademicAward
124 --- --- AcademicHonors
125 --- --- AcademicAwardProgram

<u>Page</u>	
127 ProgramSummary
130 GPA
132 AcademicHonors
133 AcademicDegreeRequirement
134 AcademicSummary
136 GPA
138 AcademicHonors
139 AcademicProgram
141 Course
146 CourseOverrideSchool
149 Contacts
150 Address
152 CommonAddressDetailsGroup
153 DomesticAddressDetailsGroup
154 InternationalAddressDetailsGroup
155 Phone
156 Email
157 URL
158 Requirement
159 Attribute
160 Proficiency
161 Licensure
162 LanguageOfInstruction
163 AcademicSummary
166 GPA
168 AcademicHonors
169 AcademicProgram
171 Course
176 CourseOverrideSchool
179 Contacts
180 Address
182 CommonAddressDetailsGroup
183 DomesticAddressDetailsGroup
184 InternationalAddressDetailsGroup
185 Phone
186 Email
187 URL
188 Requirement
189 Attribute
190 Proficiency
191 Licensure
192 LanguageOfInstruction
193 AdditionalStudentAchievements

<u>Page</u>	
195 ---- Requirement
196 ---- Attribute
197 ---- Proficiency
198 ---- Language
199 ---- Licensure
200 Health
201 ---- Immunizations
202 Tests
204 ---- StudentLevel
205 ---- Subtest
206 ---- TestScores
208	Appendix A – StateProvinceCode
209	Appendix B – CountryCode
211	Appendix C – TestCode and TestName
212	Appendix D – SubtestCode and SubtestName
220	Appendix E – CourseAcademicGradeScaleCode
225	Appendix F – Sample XML College Transcript

Introduction

For the higher education community to achieve the timely, uniform, accurate and secure exchange of the academic records for students who are currently enrolled or have previously enrolled in postsecondary educational institutions, the Postsecondary Electronic Standards Council (PESC) has developed and approved a standard format in eXtensible Markup Language (XML) for the College Transcript. The schema was approved by PESC and this Implementation Guide is to assist the non-technical user in the implementation of the process for the exchange of postsecondary academic student records electronically using the approved format.

It is intended for use by postsecondary educational institutions, by software vendors, and by state and federal education agencies.

The student transcript is used by postsecondary educational institutions to transmit current and historical records of educational accomplishments and other significant information for students who are or have been enrolled at the sending institutions. When a student transfers (or intends to transfer) from one college or university to another, it is essential that the student's prior academic record be made available to the receiving school as quickly as possible so that a possible decision can be made about the admissibility of the student to the new school. In addition, the academic record must be made available to the new school so that an evaluation may be made and the student may be advised how his prior academic record will be used to satisfy course requirements at the new school for the student's program objective there.

The student transcript contains personal history and identifying information about the student, the current academic status, dates of attendance, courses completed with grades earned, degrees, diplomas and certificates awarded and selected test scores.

For the electronic exchange of these student records to be completely automated, it is essential that all users adhere strictly to the requirements of the schema. It is also important for all users to understand and comply with requirements outlined in this Implementation Guide. Although not required in the schema, this Implementation Guide makes recommendations for accepted practice based on the recommendations by the American Association of Collegiate Registrars and Admissions Officers (AACRAO) in its Academic Record and Transcript Guide publication.

This Implementation Guide is based on the PESC XML College Transcript Schema version 1.0.0.

Organization and Format

The schema for the College Transcript is fundamentally made up of four main parts:

1. Transmission Data
2. Student
3. Note Message
4. User Defined Extensions

However, each of these main parts branch to other parts and then subsequently to further branching.

This Guide is organized so that each level of branching is documented in the order as follows:

- Transmission Data Level I
 - Sub-level IA
 - Sub-level IA1
 - Sub-level IA1a
 - Sub-level IA1b
 - Sub-level IA1c
 - Sub-level IA2

Sub-level IA2a
 Sub-level IA2b
 Sub-level IB
 Sub-level IB1
 Sub-level IB1a
 Student Data Level I

 (Etc.)

In the heading for each level and sub-level, the position in the schema diagram about to be discussed is indicated.

The description of each new branching level is introduced with a diagram showing its relationship with the preceding branch. This diagram was copied from a representation of the College Transcript Schema from a software package from Altova Corporation called XMLSpy.

Example:

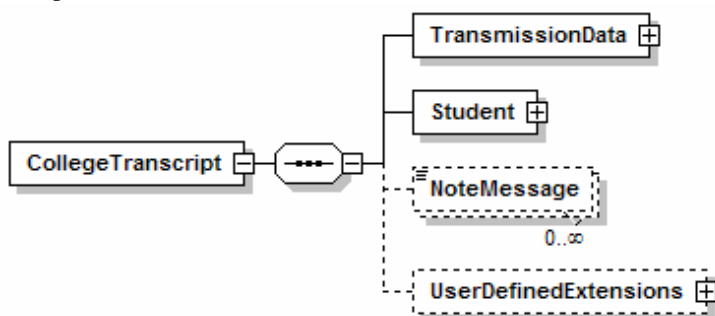

In these diagrams such as the one above, for schema validation purposes, a box with a solid border indicates that data element is a required element. A box with a dotted line indicates an optional data element. Likewise, a solid line indicates required fields and a dotted line indicates optional fields. A plus (+) sign to the right of a box (enclosing a data field) indicates there is further branching from this data field that is not shown on the diagram.

Under each box that indicates a field or data element representing a simple data element of actual data, then a representation of 0..4, for example, indicates that the field is optional and can be repeated an infinite number of times. 1...3 would indicate the field is mandatory (must be used) and may be repeated up to 3 times.

Under each diagram, a table will appear with five columns:

Tag Name: This is the name of data field that will appear in the schema and in the instance document. The instance document is the actual transcript with actual data for an actual student that is being exchanged. The format for the tag name is Upper Camel Case which takes the English name such as Transmission Data and eliminates the space between the two words and retains the capital letters of each word making up the tag name.

Schema Use: This column indicates if the data element or field is required or optional in the instance document (actual transcript for a student). If a field that is indicated as required in this column is not included in the instance document, the transcript will normally be rejected by receiving institution or agency's computer program (XML Parser). There will also usually be an indication in this column if the field can be sent multiple times.

Description: This is a brief description of the data included with that XML tag. This is normally taken from the description in the Core Main Schema for simple data elements.

Recommended Use: This is a recommendation from the developers of the College Transcript Schema and is based on good practice from the AACRAO Transcript Guide and general recommended implementation practices for exchanging electronic transcripts.

Required: If the schema use column indicates Arequired@, then this column will also indicate required. However, it is possible for the schema use column to show 'Optional', yet the developers of this Guide feel it is essential and therefore indicate it is required to include the data in keeping with good practices in the AACRAO community.

Recommended: If the information for a field is available at the sending school, then 'Recommended' indicates that the field should be sent. This notation means that the developers of this Guide strongly feel that the data should be sent if it is available.

Optional: This indicates that it is strictly up to the sender to include the data or not. If it is normally included on a paper transcript, then the user will probably try to include it. There may be cases in specific state exchanges of transcripts that items marked optional may be essential in that state. It may also be the case that all documents for the destination school might be received at a single location; sender may need to provide Optional elements to identify the specific intended recipient.

Not Recommended: This is a recommendation by the developers of this Guide that the data not be sent. In the case of comments or notes, it is normally recommended that they not be included, since notes cannot normally be automatically be processed by the receiving school. An exception may be in a particular state where the note field is standardized for use in that one state and that formatted note (by prior agreement in that state) may be processed automatically by the receiving computer. In other cases, common practice may be to include data that is not recommended by AACRAO.

Format: This gives some parameters of how the data in a field is restricted by number of occurrences or length of the field.

minOcc 1 indicates that this field is required and at least one occurrence must be included in the instance document. MinOcc 0 indicates that the field is optional for schema validation purposes.

maxOcc 1 indicates that this field may only occur once in this position of the instance document; maxOcc 5 would indicate that the field may occur no more than 5 times in this position of the instance document.

maxOcc 4 indicates that there is no limit to the number of occurrences of the field in the instance document.

minLength indicates the minimum number of characters that must be included in this field if the field is included in the instance document.

maxLength indicates the maximum length of the field if it is included in the instance document.

Comments: The Guide may include comments beneath the rows of the table, and also at the end of the last row of the table. These comments are provided to further explain something in the table row immediately above the comment row.

Code Illustration: Below the table of Tag Names, the Guide includes an illustration (snippet) of what that portion (described above) of a possible instance document might include and look like in XML format.

NoteMessage: You will find NoteMessage appearing throughout the schema and this Implementation Guide. This Guide almost always recommends against the routine use of note messages. Unless there is a prior agreed upon format for a note message between the sender and the receiver of the XML College Transcript, the note message cannot be interpreted and automatically processed by the receiver's computer. Therefore, the use of the note message is generally discouraged.

UserDefinedExtensions: The User-Defined Extension Design Pattern is intended to address situations where an XML Schema message specification may have to carry sender-specific data that cannot be defined at the time the message specification is designed. The Schema has to allow for additional elements to be defined and used at a later date. The User-Defined Extensions Pattern serves as a placeholder for these to-be-defined fields. However, it can require that these fields are defined in a Schema by the organization that wants to use the extensions area.

Care should be taken not to use the user-defined extensions as a fall-back for doing appropriate research and design. It should only be used when in actuality, the organization defining the base Schema cannot define the additional elements that other organizations may need, and furthermore, is not interested in the data these other organizations want to exchange in the user-defined area.

The use of User-defined Extensions is beneficial when agreed upon by both the sending and receiving institutions. For best work practice, it is recommended that User-defined Extensions be used in the following scope:

- Mutually defined sub-schemas: For the transmittal and receipt of data agreed upon by both sending and receiving institutions.
- State systems: In California CSU system, this would be the General Education requirements; UC would be the UC requirements.
- Regional requirements

The benefit of using the User-defined Extensions is primarily the open nature of the xml design. Agreements may be designed to accommodate segments of data transmitted, which allows for the following:

- Allows strict standardization within system through design and implementation agreements.
- Users outside of the agreement may ignore the data defined in the User-defined Extensions as non-pertinent.
- No National standards must be agreed upon for use. Only the agreement between sending and receiving institutions.

Example Code:

```
<UserDefinedExtensions>
  <YearTerm>20042</YearTerm>
  <CourseAbbrev>ENG</CourseAbbrev>
  <CourseNumb>0114</CourseNumb>
  <SectNumb>02</SectNumb>
</UserDefinedExtensions>
```

Please reference Excerpt from PESC Guidelines for XML Architecture and Data Modeling page 46 (<http://www.pesc.org/info/policies/PESC-Guidelines-for-XML-Architecture-and-Data-Modeling-v3-0.doc>) for a full explanation on usage of this segment.

Development History and Acknowledgments

The AACRAO Committee on the Standardization of Postsecondary Education Electronic Data Exchange (SPEEDE) began working on a national standard format for the electronic exchange of postsecondary student records in 1989. Initially the work of the committee was funded by AACRAO. At about the same time, the US Department of Education's National Center for Education Statistics (NCES) began developing a national standard format for the electronic exchange of student records for Kindergarten through high school students. The K12 community was primarily represented by the Council of Chief State School Officers (CCSSO). To gain more credibility in the creation and widespread adoption of the standards, the two groups (AACRAO and NCES) approached the American National Standards Institute's (ANSI) Accredited Standards Committee (ASC) X12 for assistance in developing and approving the two standard formats.

ASC X12 reviewed the two proposals and insisted that only one standard be developed and approved. That standard would be the Kindergarten through Postsecondary Education Student Record. At that time, NCES decided to fund the work of the AACRAO SPEEDE Committee as well as those working on the K-12 standard. The ASC X12 standard was approved in the

early 1990's as ANSI ASC X12 Transaction Set 130 for the Student Educational Record (Transcript). This was a standard in the Electronic Data Interchange or EDI format.

During this time period (before the Internet was widely available), an emphasis on the format was to send as much data as possible, using the fewest characters. This was because transmission costs were based on the number of characters or bytes being sent over the Value Added Electronic Networks (VANs).

This standard is now in use by a significant number of postsecondary institutions in the United States and Canada. Approximately 700,000 postsecondary transcripts are exchanged electronically in this EDI format through the University of Texas at Austin Internet Server in the ASC X12 EDI format each year.

Although the number of transcripts exchanged electronically in this ASC X12 EDI format is growing significantly each year, it was felt by the community that an alternative format should be explored.

PESC commissioned this exploration by creating the XML Forum to determine if an XML standard format might result in significantly increased use of an electronic exchange of student educational records.

It was felt that the perceived complexity of the process of implementation of the EDI standards was one of the reasons that the EDI format was not being used by many schools. The wide and inexpensive availability of XML software tools and the already existing and pervasive use of XML by many schools' information technology staffs made the XML process appear to have a much better chance of rapid acceptance and implementation by postsecondary educational institutions.

The early efforts of the XML Forum emphasized the creation of standard core components. Once this work was significantly accomplished, PESC agreed to develop an XML Standard Format for the College Transcript to demonstrate that this could be done.

Bruce Marton from the University of Texas at Austin headed this effort and was largely supported by the AACRAO SPEEDE Committee that had developed the earlier EDI standard.

PESC approved the XML standard for the College Transcript in the summer of 2004.

College Transcript

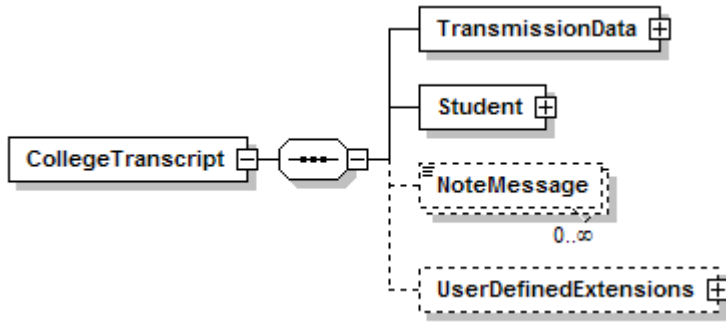

Tag Name	Schema Use	Description	Recommended Use	Format
TransmissionData	Required	Routing and header information	Required	minOcc 1 maxOcc 1
Student	Required	Body of document. One segment per student	Required	minOcc 1 maxOcc 1
NoteMessage	Optional Repeatable	Additional information about transcript	Not recommended	minOcc 0 maxOcc ∞ minLength 1 maxLength 80
UserDefinedExtensions	Optional	Additional structured information. Requires mutually defined XML schema.	Optional	minOcc 0 maxOcc 1

Comment: UserDefinedExtensions are described in the Intorduction, page viii.

Comment:

Code illustration:

```

<ColTrn:CollegeTranscript XMLns:ColTrn="urn:org:pescc:message:CollegeTranscript:v1.0.0"
XMLns:AcRec="urn:org:pescc:sector:AcademicRecord:v1.0.0" XMLns:core="urn:org:pescc:core:CoreMain:v1.0.0"
XMLns:xsi="http://www.w3.org/2001/XMLSchema-instance"
xsi:schemaLocation="urn:org:pescc:message:CollegeTranscript:v1.0.0
/CollegeTranscript_v1.0.0.xsd">
  <TransmissionData>
*
*
  </TransmissionData>
  <Student>
*
*
  </Student>
  <NoteMessage/>
  <UserDefinedExtensions/>
</ColTrn:CollegeTranscript>
  
```

TransmissionData

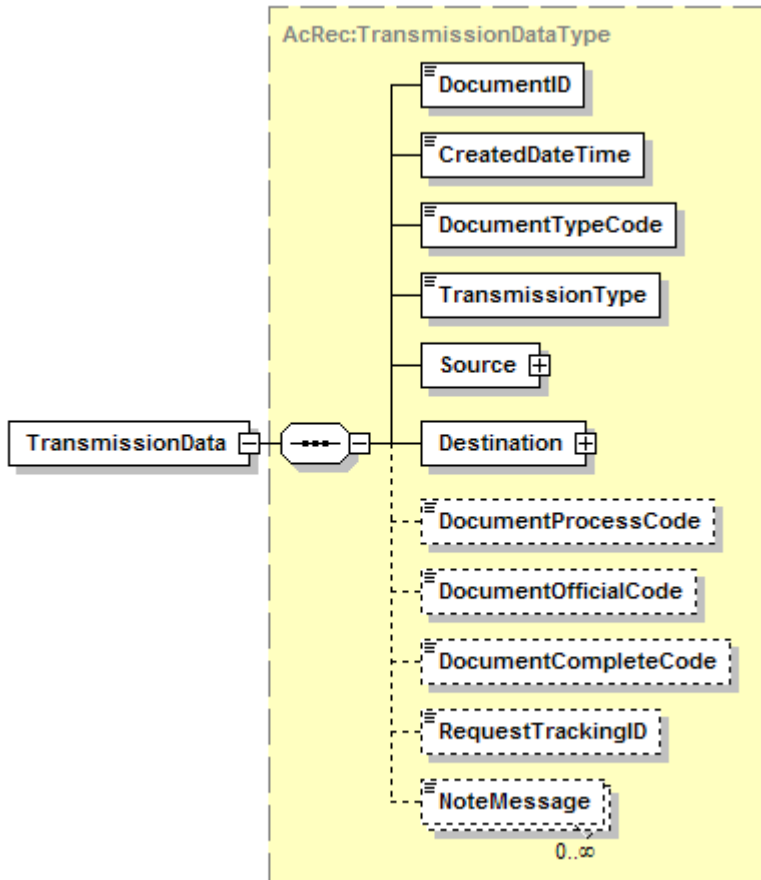

Tag Name	Schema Use	Description	Recommended Use	Format
DocumentID	Required	The File Transmission Date and Time stamp with additional unique qualifying characters	Required	minLength 1 maxLength 35
CreatedDateTime	Required	The Date and Time stamp when the document was created	Required	xs:datetime ccyy-mm-ddThh:ii:ss{+GMT}
DocumentTypeCode	Required	Type and purpose of document being transmitted	Required	Enumeration: Change TermEnroll TermGrade StudentRequest RequestedRecord InstitutionRequest ThirdPartyRequest
TransmissionType	Required	The nature of the Transmission	Required	Enumeration: Original Replace Duplicate Resubmission Reissue MutuallyDefined
Source	Required	This field is required and essential to indicate the source of the transcript being sent. It is normally the sending institution where the student applied or enrolled for courses.	Required	minOcc 1 maxOcc 1

Destination	Required	This field is mandatory and essential to indicate the destination or recipient of the transcript being sent.	Required	minOcc 1 maxOcc 1
DocumentProcessCode	Optional	This element indicates a TEST or PRODUCTION document	Required if "TEST"; "PRODUCTION" implied, not recommended	minOcc 0 maxOcc 1 Enumeration: TEST PRODUCTION
DocumentOfficialCode	Optional	This element indicates if the document is unofficial. Unofficial documents may be produced for reference purpose but may not be binding.	Required if Unofficial; "Official" implied, not recommended	minOcc 0 maxOcc 1 Enumeration: Official Unofficial
Comment: With paper transcripts, it is normal practice for the recipient to decide if the transcript received is to be considered official or unofficial. With electronic transcripts exchanged through a secure process such as the Austin, Texas Internet Server, most recipients would consider them official.				
DocumentCompleteCode	Optional	This element indicates whether document conveys a complete record. Partial documents may be produced for information that is recorded in multiple media or formats. A value of Partial generally means that the remainder will be sent in hard copy.	Required if not complete; "Complete" is implied, not recommended	minOcc 0 maxOcc 1 Enumeration: Partial Complete
RequestTrackingID	Optional	The unique ID associated with a request action that is returned to the requestor for document matching and tracking.	Optional	minOcc 0 maxOcc 1 minLength 1 maxLength 35
NoteMessage	Optional Repeatable	Additional information about transmission	Not recommended	minOcc 0 maxOcc ∞
Comment:				
Comment:				

Code illustration:

```

<TransmissionData>
  <DocumentID>050330001</DocumentID>
  <CreatedDateTime>2005-02-02T10:04:29-05:00</CreatedDateTime>
  <DocumentTypeCode>RequestedRecord</DocumentTypeCode>
  <TransmissionType>Original</TransmissionType>
  <Source>
*
*
    </Source>
    <Destination>
*
*
      </Destination>
      <DocumentProcessCode/>
      <DocumentOfficialCode/>
      <DocumentCompleteCode/>
      <RequestTrackingID/>
      <NoteMessage/>
</TransmissionData>

```

TransmissionData.Source

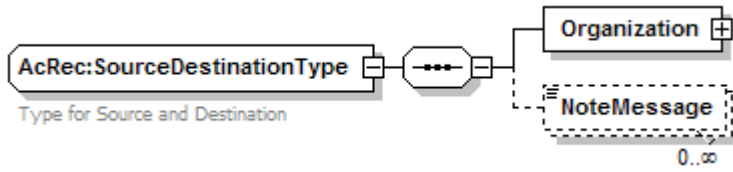

Tag Name	Schema Use	Description	Recommended Use	Format
Organization	Required	Non-person entity such as Organization, Institution, Agency or Business.	Required	minOcc 1 maxOcc 1
NoteMessage	Optional Repeatable	Additional information about Organization	Not recommended	minLength 1 maxLength 80
<i>Comment:</i>				
<i>Comment:</i>				

Code illustration:

```

<Source>
  <Organization>
*
*
  </Organization>
  <NoteMessage/>
</Source>
    
```

TransmissionData.Source.Organization

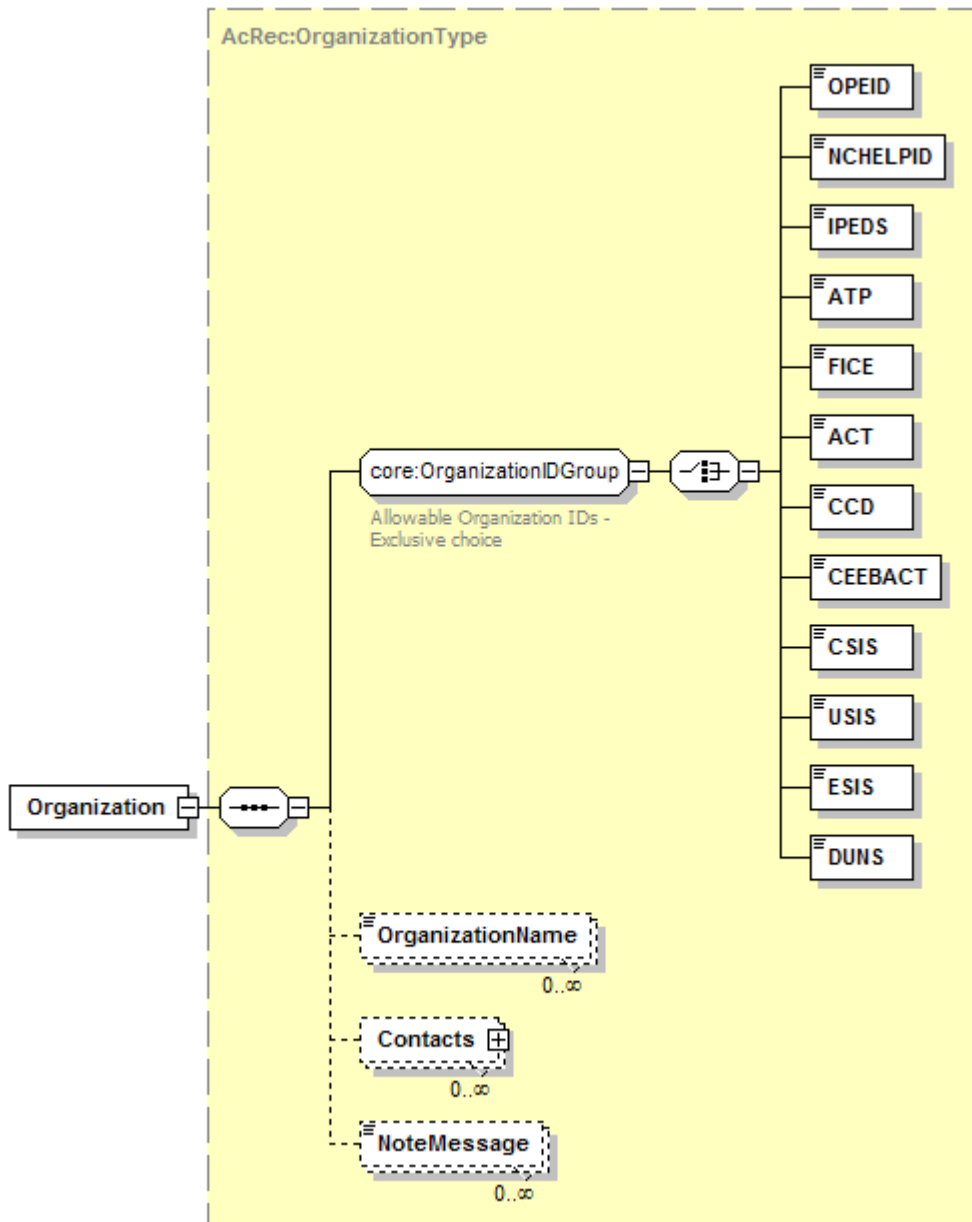

Tag Name	Schema Use	Description	Recommended Use	Format
[OrganizationIDGroup]	Required	Allowable Organization IDs - Exclusive choice	Required	minOcc 1 maxOcc 1
Comment: [OrganizationIDGroup] is not a tag. It requires the choice of one and only one of the following code set tags to identify the institution/organization.				
OPEID	Required choice	The unique identifier assigned by the Office of Postsecondary Education for each data exchange partner.	Required choice	minLength 3 maxLength 8
NCHELPID	Required choice	The unique identifier assigned by National Council on Higher Education Loan Programs for each data exchange partner.	Required choice	minLength 3 maxLength 8

Comment: The NCHELPID would not normally be an appropriate choice in this case since college transcripts are not normally generated by the financial aid world.				
IPEDS	Required choice	The unique identifier for Integrated Postsecondary Education Data System assigned by the National Center for Education Statistics for each postsecondary data exchange partner.	Required choice	minLength 6 maxLength 6
ATP	Required choice	The unique identifier for the Admissions Testing Program assigned by the College Board for each data exchange partner.	Required choice	minLength 6 maxLength 6
FICE	Required choice	The unique identifier once maintained for the Federal Interagency Committee on Education by the National Center for Education Statistics for each postsecondary data exchange partner.	Required choice	minLength 6 maxLength 6
Comment: Although the FICE code set is still widely used by many postsecondary institutions, it has not been maintained by NCES or anyone else since late in the last century. Therefore, codes for new institutions created since then, have been locally assigned and cannot be relied upon.				
ACT	Required choice	The unique identifier for postsecondary educational institutions assigned by American College Testing available at www.act.org	Required choice	minLength 4 maxLength 4
CCD	Required choice	The unique identifier assigned by National Center for Education Statistics as the Common Core of Data for each data exchange partner.	Required choice	minLength 12 maxLength 12
Comment: The CCD was primarily a code set used by K12 and is not common as an option for this choice.				
CEEBACT	Required choice	The unique identifier assigned by the College Entrance Examining Board and ACT for each K-12 data exchange partner.	Required choice	minLength 6 maxLength 6
Comment: The CEEBACT code set primarily includes K12 institutions and would not be a normal choice for this data element.				
CSIS	Required choice	The unique identifier assigned by the Statistics Canada Canadian College Student Information System for each postsecondary data exchange partner.	Required choice	minLength 6 maxLength 6
USIS	Required choice	The unique identifier assigned by the Statistics Canada University Student Information System for each data postsecondary exchange partner.	Required choice	minLength 6 maxLength 6
ESIS	Required choice	The unique identifier assigned by the Statistics Canada Enhanced Student Information System for each data postsecondary exchange partner.	Required choice	minLength 8 maxLength 8
DUNS	Required choice	Data Universal Numbering System (DUNS), unique nine character company identification number issued by Dun and Bradstreet Corporation.	Required choice	minLength 9 maxLength 9
Comment: The DUNS number would not be a normal choice to identify the sending institution that created a College Transcript.				
Comment: End of OrganizationIDGroup choice set tags				

OrganizationName	Optional Repeatable	Name of Non-person entity such as Organization, Institution, Agency or Business.	Recommended	minOcc 0 maxOcc ∞ minLength 1 maxLength 60
Contacts	Optional Repeatable	To identify a person or an office to which administrative communications should be directed	Recommended	minOcc 0 maxOcc ∞
NoteMessage	Optional Repeatable	Additional information about the organization	Not recommended	minLength 1 maxLength 80
Comment:				
Comment:				

Code illustration:

```

<Organization>
  <ATP>006882</ATP>
  <OrganizationName>THE UNIVERSITY OF TEXAS AT AUSTIN</OrganizationName>
  <Contacts>
*
*
    </Contacts>
    <NoteMessage/>
  </Organization>

```

TransmissionData.Source.Organization.Contacts

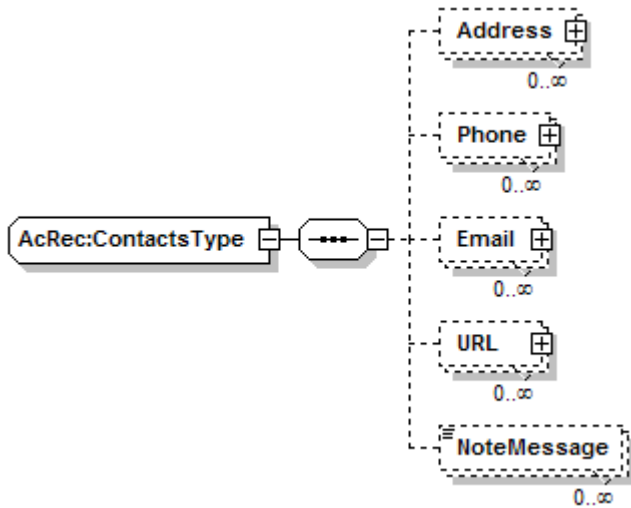

Tag Name	Schema Use	Description	Recommended Use	Format
Address	Optional Repeatable	This is a combined Address Group for a choice between Domestic or International	Recommended	minOcc 0 maxOcc ∞
Phone	Optional Repeatable	Phone number of source institution contact	Recommended	minOcc 0 maxOcc ∞
Email	Optional Repeatable	Email address of source institution contact	Optional	minOcc 0 maxOcc ∞
URL	Optional Repeatable	URL of source institution	Optional	minOcc 0 maxOcc ∞
NoteMessage	Optional Repeatable	Additional information about the contacts at the source institution	Not recommended	minLength 1 maxLength 80
	Comment:			
	Comment:			

Code illustration:

```

<Contacts>
  <Address>
*
*
  </Address>
  <Phone>
*
*
  </Phone>
  <Email>
*
  </Email>
  <URL>
*
  </URL>
  <NoteMessage/>
</Contacts>
    
```

TransmissionData.Source.Organization.Contacts.Address

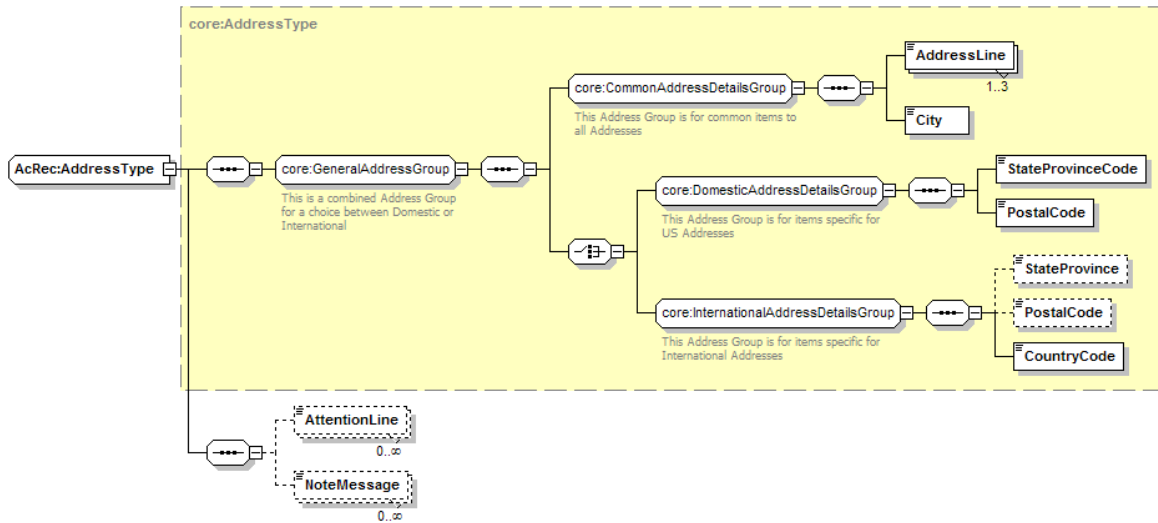

Tag Name	Schema Use	Description	Recommended Use	Format
GeneralAddressGroup	Required	This Address Group is for items common to all Addresses	Required	minOcc 1 maxOcc 1
	Comment: [GeneralAddressGroup] is not a tag and does not appear in the instance document. It requires the use of CommonAddressDetailsGroup and the choice of one of either DomesticAddressDetailsGroup or InternationalAddressDetailsGroup. This group is required in the schema only if you choose to send the address of the contact.			
CommonAddressDetailsGroup	Required	This Address Group is for items common to all Addresses	Required	minOcc 1 maxOcc 1
	Comment: [CommonAddressDetailsGroup] is not a tag and does not appear in the instance document. If the address of a contact is included in the transcript, then this must be sent. It is required and must be paired with one of either DomesticAddressDetailsGroup or InternationalAddressDetailsGroup.			
DomesticAddressDetailsGroup	Required choice	This Address Group is for items specific for US and Canadian Addresses	Required for domestic addresses	minOcc 1 maxOcc 1
	Comment: [DomesticAddressDetailsGroup] is not a tag and does not appear in the instance document. If the address has a United States or Canadian Postal Code and a US State or Canadian Province Code, then this should be the required choice.			
InternationalAddressDetailsGroup	Required choice	This Address Group is for items specific for International Addresses	Required for international addresses	minOcc 1 maxOcc 1
	Comment: [InternationalAddressDetailsGroup] is not a tag and does not appear in the instance document. This choice is for addresses that do not have a US or Canadian postal code.			
AttentionLine	Optional	The individual or office name within the postal address where inquiries should be directed.	Optional	minOcc 0 maxOcc ∞ minLength 1 maxLength 45
	Comment: This might be used to indicate questions about the record should be sent to the Law School, School of Medicine, the Dean of Students, etc.			
NoteMessage	Optional Repeatable	Additional information about the addresses of the contacts at the source institution	Not recommended	minOcc 0 maxOcc ∞
	Comment:			

Comment:

Code illustration:

```
<Address>
  <AddressLine>Office of the Registrar</AddressLine>
  <AddressLine>1 University Station</AddressLine>
  <City>Austin</City>
  <StateProvinceCode>TX</StateProvinceCode>
  <PostalCode>78712</PostalCode>
  <AttentionLine>Jane Shaugness</AttentionLine>
  <NoteMessage/>
</Address>
```

TransmissionData.Source.Organization.Contacts.Address.CommonAddressDetailsGroup

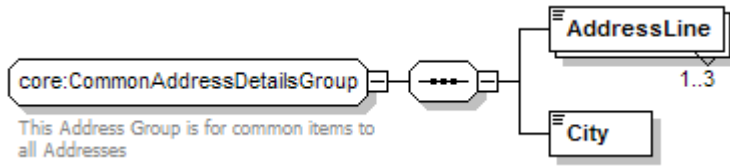

Tag Name	Schema Use	Description	Recommended Use	Format
AddressLine	Required Repeatable	Local delivery information such as street, building number, PO box, or apartment portion of a postal address.	Required	minOcc 1 maxOcc 3 minLength 1 maxLength 40
City	Required	The city portion of the Address.	Required	minOcc 1 maxOcc 1 minLength 2 maxLength 30
	Comment:			
	Comment:			

Code illustration:

```
<AddressLine>University of Oxford</AddressLine>
<AddressLine>Wellington Square</AddressLine>
<City>Oxford</City>
```

TransmissionData.Source.Organization.Contacts.Address.DomesticAddressDetailsGroup

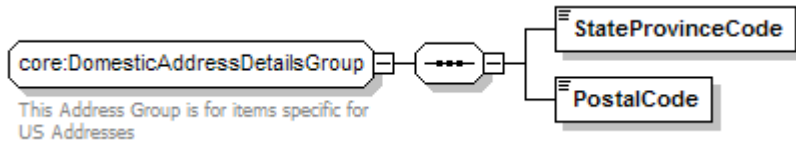

Tag Name	Schema Use	Description	Recommended Use	Format
StateProvinceCode	Required	Code for US states, etc., and Canadian provinces.	Required	See Appendix A
PostalCode	Required	The postal code portion of the Address.	Required	minLength 1 maxLength 17
Comment:				
<i>Comment: If the sending school chooses to send contact information, and also chooses to send an address for that contact in the US or Canada, then both the postal code and the state or province codes must be sent.</i>				

Code illustration:

```
<StateProvinceCode>TX</StateProvinceCode>
<PostalCode>78712</PostalCode>
```

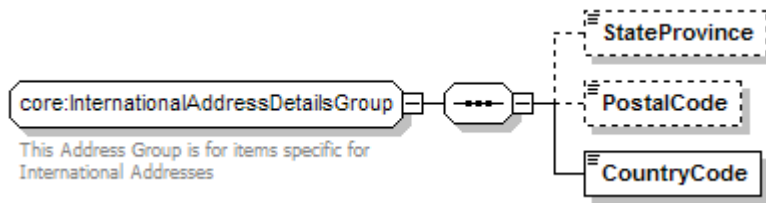
TransmissionData.Source.Organization.Contacts.Address.InternationalAddressDetailsGroup

Tag Name	Schema Use	Description	Recommended Use	Format
StateProvince	Optional	The literal name of the state, province or territory of a postal address of the source of this document. Use for addresses outside US or Canada.	Refer to common postal practices of the source country	minLength 2 maxLength 30
		<i>Comment: For an internet resource of states or other geographical subdivisions in countries other than the US and Canada, you might choose to refer to the website of the Universal Postal Union at http://www.upu.int</i>		
PostalCode	Optional	The postal code portion of the Address.	Refer to common postal practices of the source country	minLength 1
		<i>Comment: For an internet resource of states or other geographical subdivisions in countries other than the US and Canada, you might choose to refer to the website of the Universal Postal Union at http://www.upu.int</i>		
CountryCode	Required	Code indicating Country. Use ISO 3166-1 alpha-2 standard.	Required	See Appendix B
		Comment:		
		Comment:		

Code illustration:

```
<PostalCode>0X1 2JD</PostalCode>
<CountryCode>GB</CountryCode>
```

TransmissionData.Source.Organization.Contacts.Phone

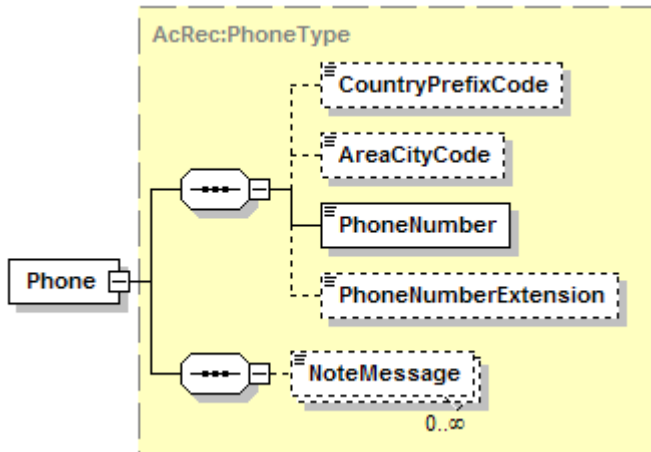

Tag Name	Schema Use	Description	Recommended Use	Format
CountryPrefixCode	Optional	International dialing code.	Recommended	minLength 1 maxLength 3
AreaCityCode	Optional	Regional dialing code.	Recommended	minLength 1 maxLength 5
PhoneNumber	Required	Telephone number.	Required	minLength 1 maxLength 11
PhoneNumberExtension	Optional	The extended telephone addressing information used in addition to phone number such as a PBX extension, a pager PIN, or FAX sub-address.	Optional	minLength 1 maxLength 5
NoteMessage	Optional Repeatable	Additional information about the phone number of the contact at the source institution	Not recommended	minOcc 0 maxOcc ∞
Comment:				
Comment:				

Code illustration:

```

<Phone>
  <CountryPrefixCode/>
  <AreaCityCode>512</AreaCityCode>
  <PhoneNumber>4757638</PhoneNumber>
  <PhoneNumberExtension/>
</Phone>
    
```

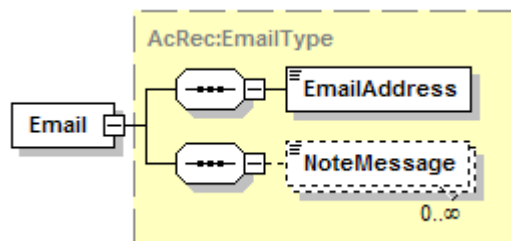
TransmissionData.Source.Organization.Contacts.Email

Tag Name	Schema Use	Description	Recommended Use	Format
EmailAddress	Required	The numbers, letters, and symbols used to identify an electronic mail (Email) user within a network.	Required	minLength 1 maxLength 128
NoteMessage	Optional Repeatable	Additional information about the email address of the contact	Not recommended	minOcc 0 maxOcc ∞
Comment:				
Comment:				

Code illustration:

```

<Email>
  <EmailAddress/>
</Email>

```

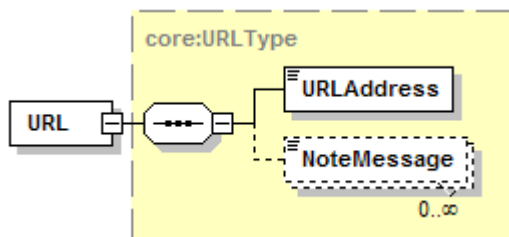
TransmissionData.Source.Organization.Contacts.URL

Tag Name	Schema Use	Description	Recommended Use	Format
URLAddress	Required	The Uniform Resource Locator (URL) address associated with a product, deliverable or contact.	Required	minLength 0 maxLength 512
NoteMessage	Optional Repeatable	Additional information about the URL address of the source institution	Not recommended	minLength 1 maxLength 80
	Comment:			
	Comment:			

Code illustration:

```

<URL>
  <URLAddress/>
</URL>

```

TransmissionData.Destination

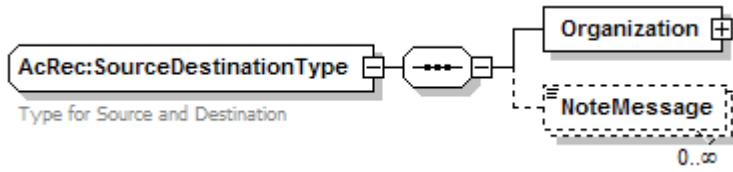

Tag Name	Schema Use	Description	Recommended Use	Format
Organization	Required	Non-person entity such as Organization, Institution, Agency or Business.	Required	minOcc 1 maxOcc 1
NoteMessage	Optional Repeatable	Additional information about destination organization or school.	Not Recommended	minLength 1 maxLength 80
Comment:				
Comment:				

Code illustration:

```

    <Destination>
      <Organization>
*
      </Organization>
      <NoteMessage/>
    </Destination>
    
```

TransmissionData.Destination.Organization

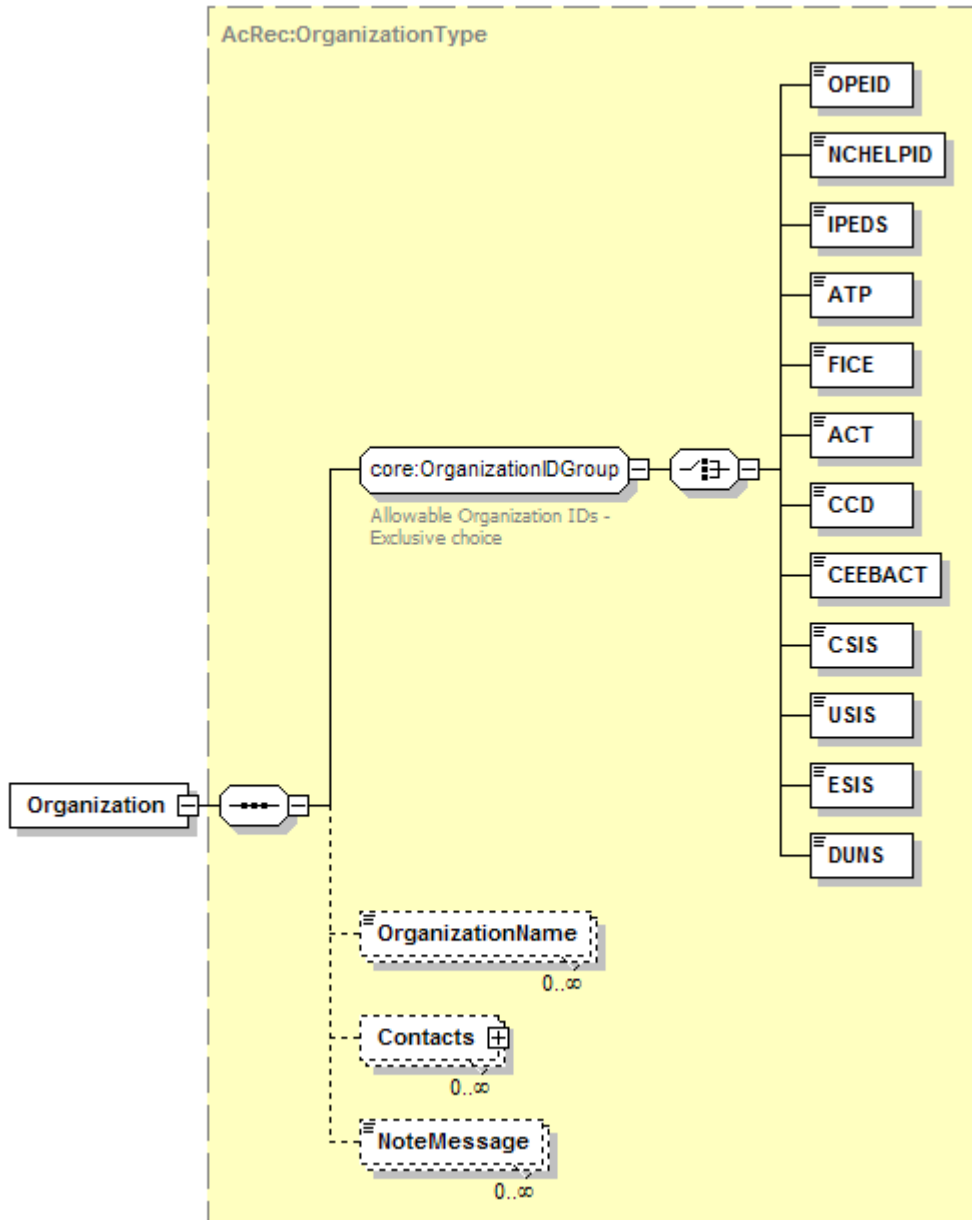

Tag Name	Schema Use	Description	Recommended Use	Format
[OrganizationIDGroup]	Required	Allowable Organization IDs - Exclusive choice	Required	minOcc 1 maxOcc 1
Comment: [OrganizationIDGroup] is not a tag. It requires the choice of one and only one of the following code set tags to identify the institution/organization.				
OPEID	Required choice	The unique identifier assigned by the Office of Postsecondary Education for each data exchange partner.	Required choice	minLength 3 maxLength 8
NCHELPID	Required choice	The unique identifier assigned by National Council on Higher Education Loan Programs for each data exchange partner.	Required choice	minLength 3 maxLength 8

	Comment: The NCHELPID would not normally be an appropriate choice in this case since college transcripts are not normally generated by the financial aid world.			
IPEDS	Required choice	The unique identifier for Integrated Postsecondary Education Data System assigned by the National Center for Education Statistics for each postsecondary data exchange partner.	Required choice	minLength 6 maxLength 6
ATP	Required choice	The unique identifier for the Admissions Testing Program assigned by the College Board for each data exchange partner.	Required choice	minLength 6 maxLength 6
FICE	Required choice	The unique identifier once maintained for the Federal Interagency Committee on Education by the National Center for Education Statistics for each postsecondary data exchange partner.	Required choice	minLength 6 maxLength 6
	Comment: Although the FICE code set is still widely used by many postsecondary institutions, it has not been maintained by NCES or anyone else since late in the last century. Therefore, codes for new institutions created since then, have been locally assigned and cannot be relied upon.			
ACT	Required choice	The unique identifier for postsecondary educational institutions assigned by American College Testing available at www.act.org	Required choice	minLength 4 maxLength 4
CCD	Required choice	The unique identifier assigned by National Center for Education Statistics as the Common Core of Data for each data exchange partner.	Required choice	minLength 12 maxLength 12
	Comment: The CCD was primarily a code set used by K12 and is not common as an option for this choice.			
CEEBACT	Required choice	The unique identifier assigned by the College Entrance Examining Board and ACT for each K-12 data exchange partner.	Required choice	minLength 6 maxLength 6
	Comment: The CEEBACT code set primarily includes K12 institutions and would not be a normal choice for this data element.			
CSIS	Required choice	The unique identifier assigned by the Statistics Canada Canadian College Student Information System for each postsecondary data exchange partner.	Required choice	minLength 6 maxLength 6
USIS	Required choice	The unique identifier assigned by the Statistics Canada University Student Information System for each data postsecondary exchange partner.	Required choice	minLength 6 maxLength 6
ESIS	Required choice	The unique identifier assigned by the Statistics Canada Enhanced Student Information System for each data postsecondary exchange partner.	Required choice	minLength 8 maxLength 8
DUNS	Required choice	Data Universal Numbering System (DUNS), unique nine character company identification number issued by Dun and Bradstreet Corporation.	Required choice	minLength 9 maxLength 9
	Comment: The DUNS number would not be a normal choice to identify the sending institution that created a College Transcript.			
	Comment: End of OrganizationIDGroup choice set tags			

OrganizationName	Optional Repeatable	Name of Non-person entity such as Organization, Institution, Agency or Business.	Recommended	minOcc 0 maxOcc ∞ minLength 1 maxLength 60
Comment: Use repeated OrganizationName to include alternate routing destination (e.g. Human Resources, Graduate School).				
Contacts	Optional Repeatable	To identify a person or an office to which administrative communications should be directed	Optional	minOcc 0 maxOcc ∞
Comment: Use Contacts for additional routing instructions and information.				
NoteMessage	Optional Repeatable	Additional information about the organization	Not recommended	minLength 1 maxLength 80
Comment:				
Comment:				

Code illustration:

```

<Organization>
  <ATP>006882</ATP>
  <OrganizationName>THE UNIVERSITY OF TEXAS AT AUSTIN</OrganizationName>
  <Contacts>
*
*
    </Contacts>
  <NoteMessage/>
</Organization>

```

TransmissionData.Destination.Organization.Contacts

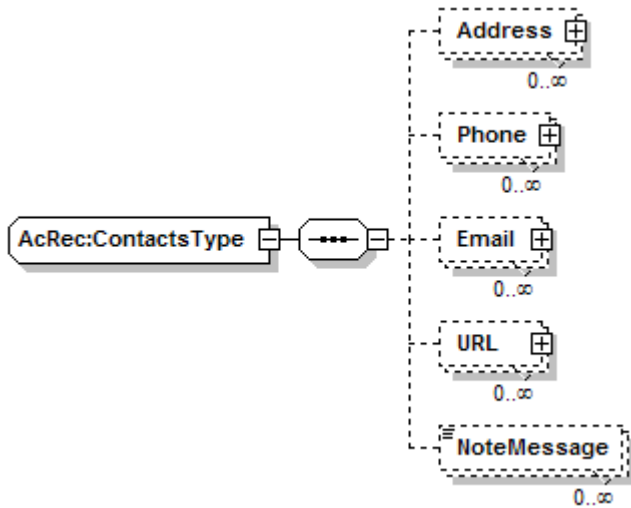

Tag Name	Schema Use	Description	Recommended Use	Format
Address	Optional Repeatable	This is a combined Address Group for a choice between Domestic or International	Optional	minOcc 0 maxOcc ∞
Comment: This element is not often used but may be helpful to identify the specific recipient of the document.				
Phone	Optional Repeatable	This is the phone number of the contact at the destination school or agency.	Optional	minOcc 0 maxOcc ∞
Email	Optional Repeatable	This is the email address of the contact at the destination school or agency.	Optional	minOcc 0 maxOcc ∞
URL	Optional Repeatable	This is the Uniform Resource Locator of the destination school or agency.	Not Recommended	minOcc 0 maxOcc ∞
NoteMessage	Optional Repeatable	Additional information about the contact at the destination school or agency	Not Recommended	minLength 1 maxLength 80
Comment:				
Comment:				

Code illustration:

```

<Contacts>
  <Address>
*
  </Address>
  <Phone>
*
  </Phone>
  <Email>
*
  </Email>
  <URL>
*
  </URL>
  <NoteMessage/>
</Contacts>
    
```

TransmissionData.Destination.Organization.Contacts.Address

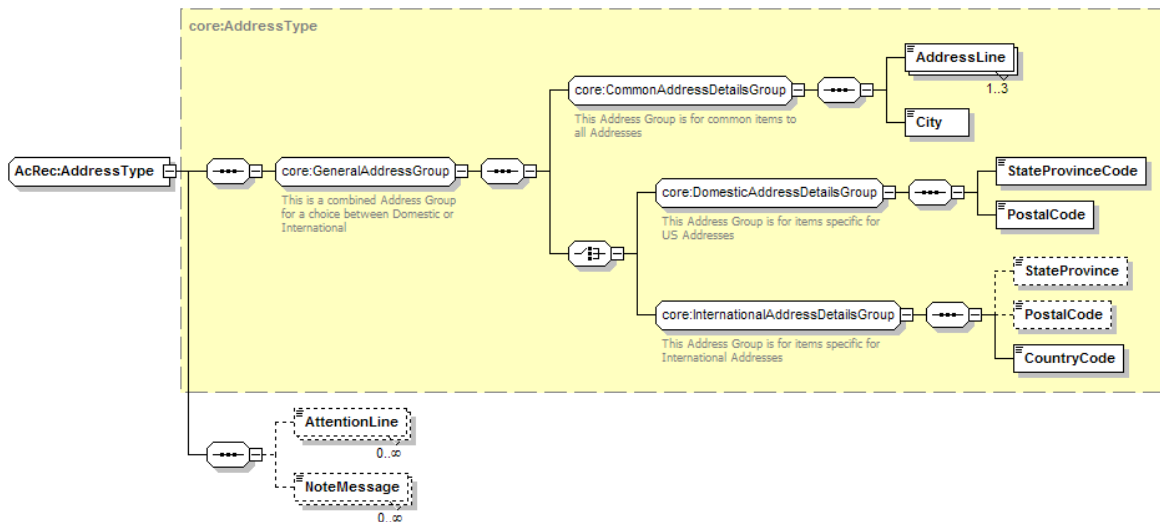

Tag Name	Schema Use	Description	Recommended Use	Format
CommonAddressDetailsGroup	Required	This Address Group is for items common to all Addresses	Required	minOcc 1 maxOcc 1
Comment: [CommonAddressDetailsGroup] is not a tag and does not appear in the instance document. If the address of a contact is included in the transcript, then this must be sent. It is required and must be paired with one of either DomesticAddressDetailsGroup or InternationalAddressDetailsGroup.				
DomesticAddressDetailsGroup	Required choice	This Address Group is for items specific for US and Canadian Addresses	Required for domestic addresses	minOcc 1 maxOcc 1
Comment: [DomesticAddressDetailsGroup] is not a tag and does not appear in the instance document. If the address has a United States or Canadian Postal Code and a US State or Canadian Province Code, then this should be the required choice.				
InternationalAddressDetailsGroup	Required choice	This Address Group is for items specific for International Addresses	Required for international addresses	minOcc 1 maxOcc 1
Comment: [InternationalAddressDetailsGroup] is not a tag and does not appear in the instance document. This choice is for addresses that do not have a US or Canadian postal code.				
AttentionLine	Optional	The individual or office name within the postal address where inquiries should be directed.	Optional	minOcc 0 maxOcc ∞ minLength 1 maxLength 45
NoteMessage	Optional Repeatable	Additional information about the addresses of the contacts at the destination institution	Not recommended	minOcc 0 maxOcc ∞
Comment:				
Comment:				

Code illustration:

```

<Address>
  <AddressLine>Office of the Registrar</AddressLine>
  <City>Austin</City>
  <StateProvinceCode>TX</StateProvinceCode>
  <PostalCode>78712</PostalCode>
  <AttentionLine>Jane Shaugness</AttentionLine>
</Address>
    
```

TransmissionData.Destination.Organization.Contacts.Address.CommonAddressDetailsGroup

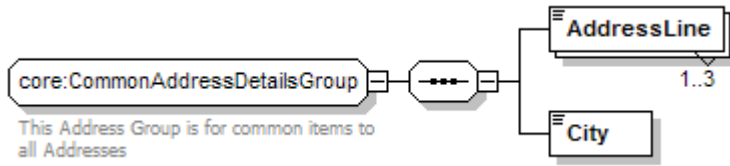

Tag Name	Schema Use	Description	Recommended Use	Format
AddressLine	Required Repeatable	Local delivery information such as street, building number, PO box, or apartment portion of a postal address.	Required	minOcc 1 maxOcc 3 minLength 1 maxLength 40
City	Required	The city portion of the Address.	Required	minOcc 1 maxOcc 1 minLength 2 maxLength 30
	Comment:			
	Comment:			

Code illustration:

```
<AddressLine>Office of the Registrar</AddressLine>
<City>Austin</City>
```

TransmissionData.Destination.Organization.Contacts.Address.DomesticAddressDetailsGroup

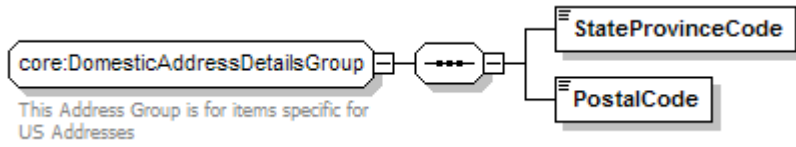

Tag Name	Schema Use	Description	Recommended Use	Format
StateProvinceCode	Required	Code for US states, etc., and Canadian provinces.	Required	See Appendix A
PostalCode	Required	The postal code portion of the Address.	Required	minLength 1 maxLength 17
	Comment:			
	Comment:			

Code illustration:

```
<StateProvinceCode>TX</StateProvinceCode>
<PostalCode>78712</PostalCode>
```

TransmissionData.Destination.Organization.Contacts.Address.InternationalAddressDetailsGroup

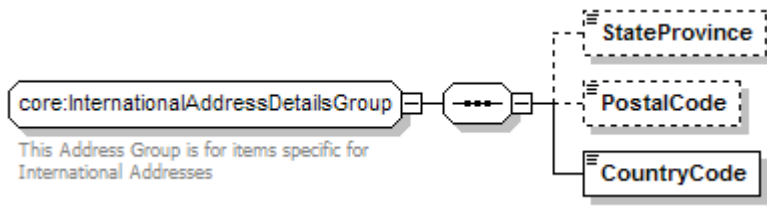

Tag Name	Schema Use	Description	Recommended Use	Format
StateProvince	Optional	The literal name of the state, province or territory of a postal address. Use for addresses outside US or Canada.	Optional	minLength 2 maxLength 30
		Comment: For an internet resource of states or other geographical subdivisions in countries other than the US and Canada, you might choose to refer to the website of the Universal Postal Union at http://www.upu.int		
PostalCode	Optional	The postal code portion of the Address.	Optional	minLength 1
		Comment: For an internet resource of states or other geographical subdivisions in countries other than the US and Canada, you might choose to refer to the website of the Universal Postal Union at http://www.upu.int		
CountryCode	Required	Code indicating Country. Use ISO 3166-1 alpha-2 standard.	Required	See Appendix B
		Comment:		
		Comment:		

Code illustration:

```
<PostalCode>0X1 2JD</PostalCode>
<CountryCode>GB</CountryCode>
```

TransmissionData.Destination.Organization.Contacts.Phone

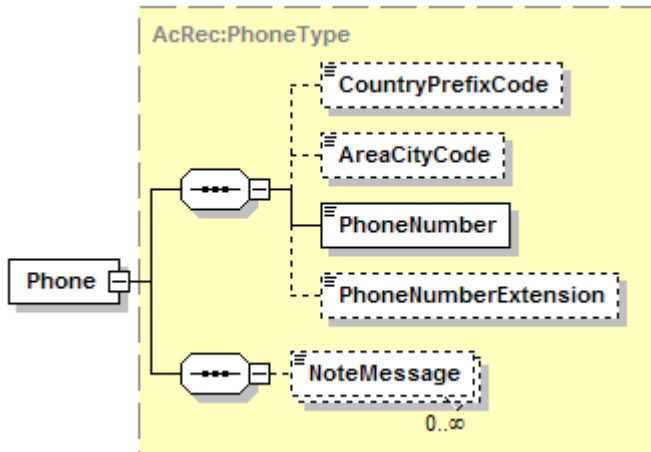

Tag Name	Schema Use	Description	Recommended Use	Format
CountryPrefixCode	Optional	International dialing code.	Optional	minLength 1 maxLength 3
AreaCityCode	Optional	Regional dialing code.	Recommended	minLength 1 maxLength 5
PhoneNumber	Required	Telephone number.	Required	minLength 1 maxLength 11
PhoneNumberExtension	Optional	The extended telephone addressing information used in addition to phone number such as a PBX extension, a pager PIN, or FAX sub-address.	Optional	minLength 1 maxLength 5
NoteMessage	Optional Repeatable	Additional information about the phone number of the contact at the destination school or agency	Not recommended	minOcc 0 maxOcc ∞

Comment:

Comment:

Code illustration:

```

<Phone>
  <CountryPrefixCode/>
  <AreaCityCode>512</AreaCityCode>
  <PhoneNumber>4757638</PhoneNumber>
  <PhoneNumberExtension/>
</Phone>
    
```

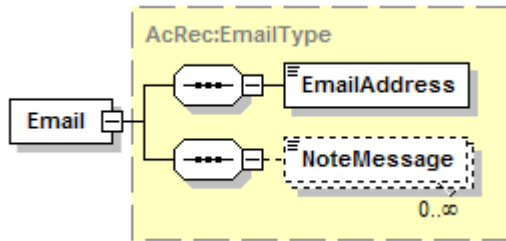
TransmissionData.Destination.Organization.Contacts.Email

Tag Name	Schema Use	Description	Recommended Use	Format
EmailAddress	Required	The numbers, letters, and symbols used to identify an electronic mail (Email) user within a network.	Required	minLength 1 maxLength 128
NoteMessage	Optional Repeatable	Additional information about the email address of the contact at the destination school or agency	Not recommended	minOcc 0 maxOcc ∞
Comment:				
Comment:				

Code illustration:

```

<Email>
  <EmailAddress/>
</Email>

```

TransmissionData.Destination.Organization.Contacts.URL

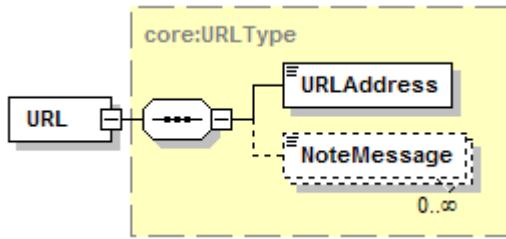

Tag Name	Schema Use	Description	Recommended Use	Format
URLAddress	Required	The Uniform Resource Locator (URL) address associated with a product, deliverable or contact.	Required	minLength 0 maxLength 512
NoteMessage	Optional Repeatable	Additional information about the URL of the contact at the destination school or agency	Not Recommended	minLength 1 maxLength 80
Comment:				
Comment:				

Code illustration:

```
<URL>
  <URLAddress/>
</URL>
```

Student

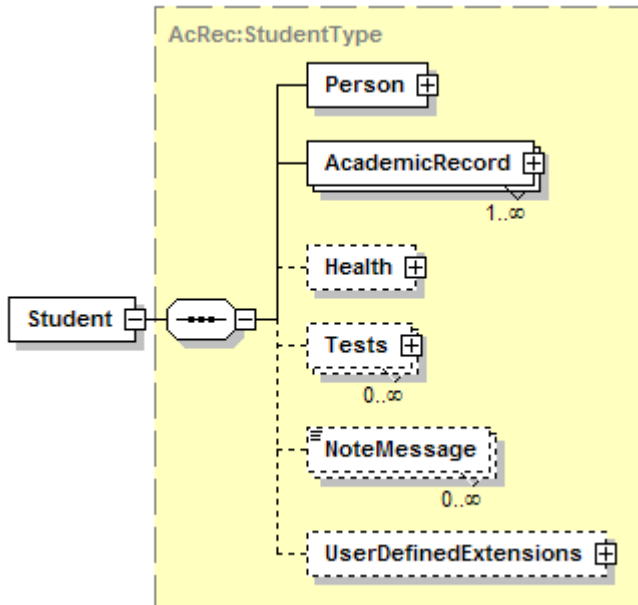

Tag Name	Schema Use	Description	Recommended Use	Format
Person	Required	Biographical and demographic information about the student.	Required	
AcademicRecord	Required Repeatable	Information concerning the academic achievement or status of the student.	Required	
	Comment: AcademicRecord element may be repeated. There must be at least one occurrence which normally represents the record from the sending institution; additional occurrences may be included for transferred work or secondary school data.			
Health	Optional	Immunization, vaccinations and health screenings	Optional	
Tests	Optional Repeatable	Academic and achievement test data	Optional	
	Comment: Tests administered by national testing agencies are recommended to come directly from the agency and should not be listed here. Use this section for state and local test data as required.			
NoteMessage	Optional Repeatable	Additional information about the student	Not Recommended	minLength 1 maxLength 80
UserDefinedExtensions	Optional	Additional structured information. Requires mutually defined XML schema.	Optional	
	Comment:			
	Comment:			

Code illustration:

```
<Student>
  <Person>
*
*
  </Person>
  <AcademicRecord>
*
*
  </AcademicRecord>
  <Health>
*
*
  </Health>
  <Tests>
*
*
  </Tests>
  <NoteMessage/>
  <UserDefinedExtensions/>
</Student>
```

Student.Person

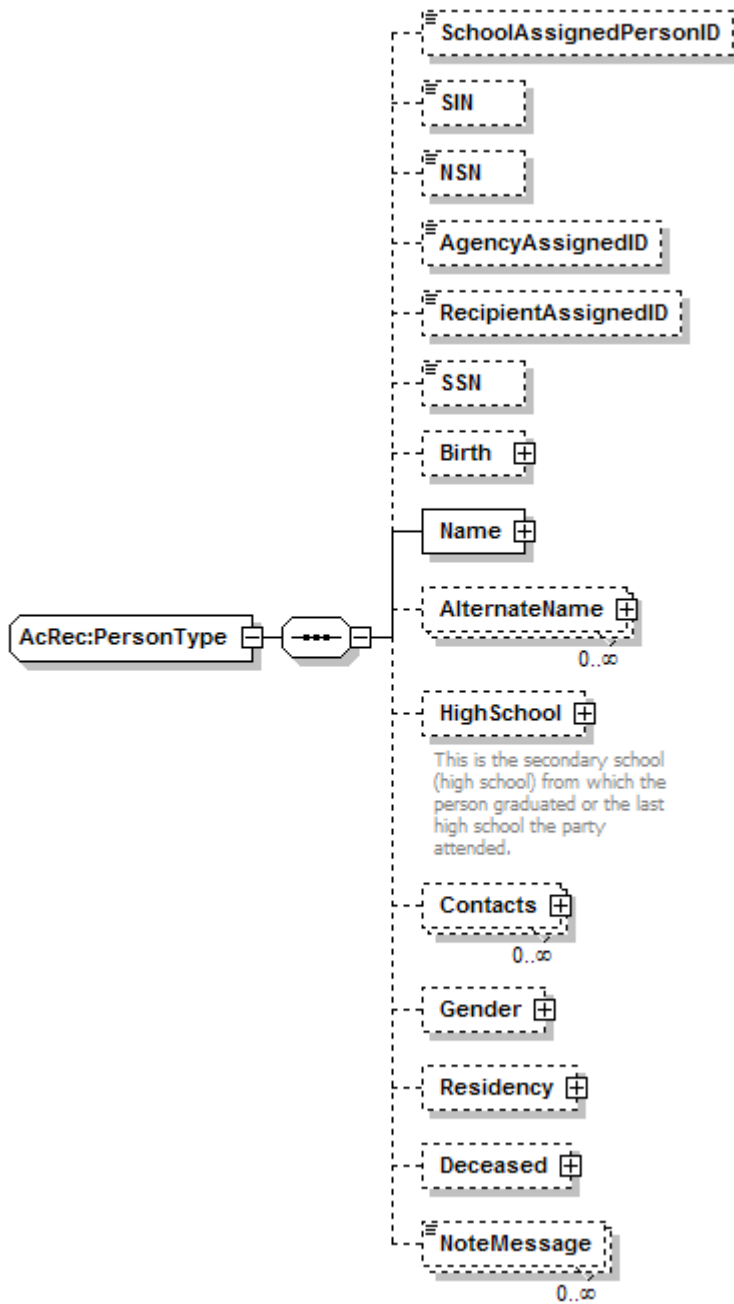

Tag Name	Schema Use	Description	Recommended Use	Format
SchoolAssignedPersonID	Optional	School Assigned Identifier Type	Recommended	minLength 1 maxLength 20
Comment: This is the student's ID at the source or sending school.				
SIN	Optional	The person's Canadian Social Insurance Number	Optional	minLength 9 maxLength 9
NSN	Optional	Canadian National Student Number Identifier Type	Optional	

AgencyAssignedID	Optional	The ID assigned by the state or an agency, to the person (student).	Optional	minLength 1 maxLength 30
RecipientAssignedID	Optional	RecipientAssigned Identifier Type	Optional	minLength 1 maxLength 20
Comment: <i>If this transcript is being sent in response to a request for the transcript from another institution, then this is the student's ID number at the school that requested the record.</i>				
SSN	Optional	The person's U.S. Social Security Number	Recommended	pattern \d{9}
Birth	Optional	Identifying information related to a person's birth	Recommended	
Name	Required	The name of record at the sending institution	Required	
Comment: <i>This should be the full legal name of the student as recorded at the sending institution.</i>				
AlternateName	Optional Repeatable	Any other names by which the person may be known	Optional	
Comment: <i>Includes former name(s) or other names by which the student may be known.</i>				
HighSchool	Optional	This is the secondary school (high school) from which the person graduated or the last high school the person attended.	Recommended	
Comment: <i>Useful for matching; it does not contain any academic information for the student.</i>				
Contacts	Optional Repeatable	Contact information for the student as recorded by the sending institution	Recommended	
Comment: <i>This is helpful for creating a record when the receiving institution has not previously been contacted by the student.</i>				
Gender	Optional	Gender of the student	Recommended	
Comment: <i>Useful for matching. Although AACRAO does not recommend including this information on the paper transcript, it is recommended to be included on the XML electronic transcript if the destination is to another college or university.</i>				
Residency	Optional	The student's official residency classification for fee purposes	Optional	
Comment: <i>May be helpful for receiving institution to make a determination of residency.</i>				
Deceased	Optional	Information related a student's death	Optional	
Comment: <i>Recommended if the student is deceased; useful for fraud prevention.</i>				
NoteMessage	Optional Repeatable	Additional information about the person	Not Recommended	minLength 1 maxLength 80
Comment:				
Comment:				

Code illustration:

```

<Person>
  <SchoolAssignedPersonID/>
  <SIN/>
  <NSN/>
  <AgencyAssignedID/>
  <RecipientAssignedID/>
  <SSN>10000000</SSN>
  <Birth>
*
*
    </Birth>
    <Name>
*
*
    </Name>
    <AlternateName>
*
*
    </AlternateName>
    <HighSchool>
*
*
    </HighSchool>
    <Contacts>
*
*
    </Contacts>
    <Gender>
*
*
    </Gender>
    <Residency>
*
*
    </Residency>
    <Deceased>
*
*
    </Deceased>
    <NoteMessage/>
</Person>

```

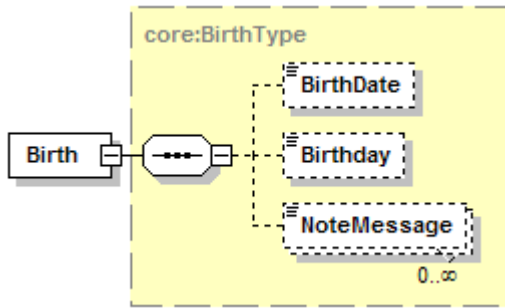
Student.Person.Birth

Tag Name	Schema Use	Description	Recommended Use	Format
BirthDate	Optional	Date of Birth	Recommended	xs:date
Birthday	Optional	Month and day of Birth	Optional	xs:gMonthDay
	Comment: Use instead of BirthDate when it is desirable to withhold the student's age.			
NoteMessage	Optional Repeatable	Additional information about Birth	Not Recommended	minLength 1 maxLength 80
	Comment:			
Comment:				

Code illustration:

```

<Birth>
  <BirthDate>1967-07-14</BirthDate>
  <Birthday/>
  <NoteMessage/>
</Birth>

```

Student.Person.Name

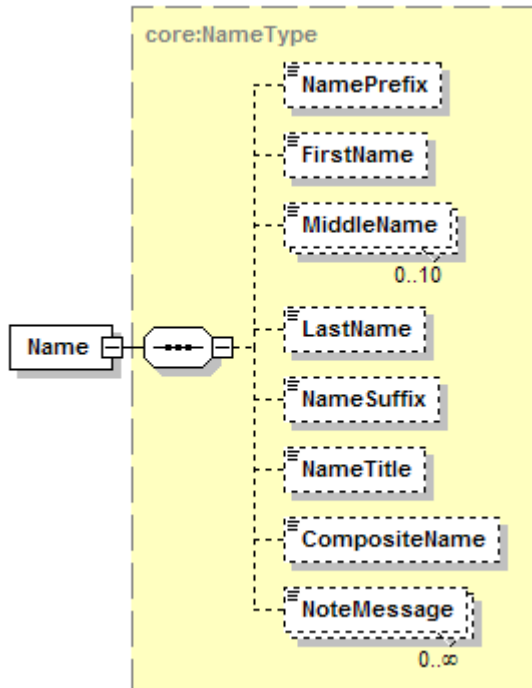

Tag Name	Schema Use	Description	Recommended Use	Format
NamePrefix	Optional	An honorific, title or form of address that precedes the name.	Not Recommended	minLength 1 maxLength 30
FirstName	Optional	The first name of the person, usually given at birth, baptism, or during another ceremony, or through legal change	Recommended	minLength 1 maxLength 35
MiddleName	Optional Repeatable	A secondary Name of the person, usually given at birth, baptism, or during another naming ceremony or through legal change	Recommended	minLength 1 maxLength 35
LastName	Optional	The last name or surname by which a person is legally known	Recommended	minLength 1 maxLength 35
NameSuffix	Optional	The expression of an individual's generation within a family.	Recommended	Enumeration: JR SR I II III IV
NameTitle	Optional	An honorific, title or credential that follows the name.	Not Recommended	minLength 1 maxLength 30
CompositeName	Optional	The full name of the person in Last, First Middle order, comma after last name	Not Recommended	minLength 1 maxLength 45
NoteMessage	Optional Repeatable	Additional information about the student name	Not Recommended	minLength 1 maxLength 80

Comment:

Comment:

Code illustration:

```
<Name>  
  <NamePrefix/>  
  <FirstName>Test</FirstName>  
  <MiddleName>Record</MiddleName>  
  <MiddleName>Test</MiddleName>  
  <LastName>Speede</LastName>  
  <NameSuffix/>  
  <NameTitle/>  
  <CompositeName/>  
  <NoteMessage/>  
</Name>
```

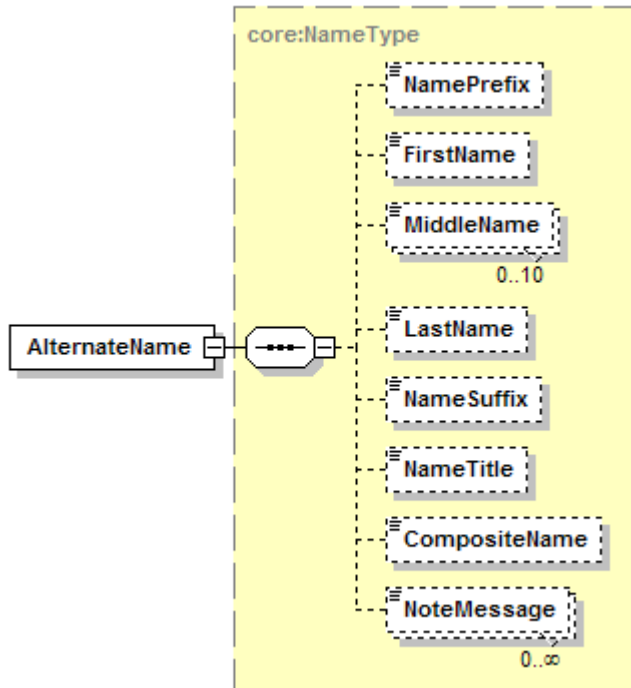
Student.Person.AlternateName

Tag Name	Schema Use	Description	Recommended Use	Format
NamePrefix	Optional	An honorific, title or form of address that precedes the name.	Not Recommended	minLength 1 maxLength 30
FirstName	Optional	The first name of the person, usually given at birth, baptism, or during another ceremony, or through legal change	Recommended	minLength 1 maxLength 35
MiddleName	Optional Repeatable	A secondary Name of the person, usually given at birth, baptism, or during another naming ceremony or through legal change	Recommended	minLength 1 maxLength 35
LastName	Optional	The last name or surname by which a person is legally known	Recommended	minLength 1 maxLength 35
NameSuffix	Optional	The expression of an individual's generation within a family.	Recommended	Enumeration: JR SR I II III IV
NameTitle	Optional	An honorific, title or credential that follows the name.	Not Recommended	minLength 1 maxLength 30
CompositeName	Optional	The full name of the person in Last, First Middle order, comma after last name	Not Recommended	minLength 1 maxLength 45
NoteMessage	Optional Repeatable	Additional information about the alternate name	Not Recommended	minLength 1 maxLength 80
Comment:				

Comment: *Sending of alternate names may sometimes help in the matching of this transcript with the student's record at the receiving institution.*

Code illustration:

```
<AlternateName>
  <NamePrefix/>
  <FirstName>Test</FirstName>
  <MiddleName>Record</MiddleName>
  <MiddleName>Test</MiddleName>
  <LastName>Speede</LastName>
  <NameSuffix/>
  <NameTitle/>
  <CompositeName/>
  <NoteMessage/>
</AlternateName>
```

Student.Person.HighSchool

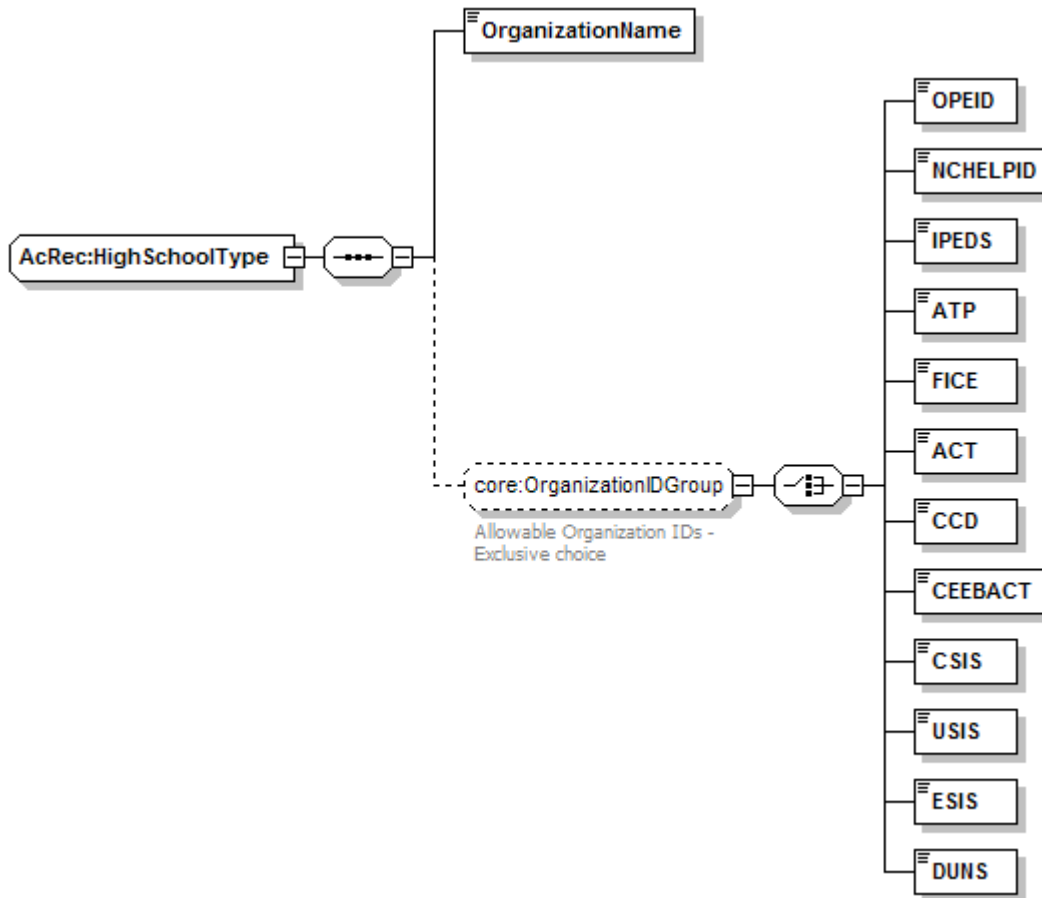

Tag Name	Schema Use	Description	Recommended Use	Format
OrganizationName	Required	Name of Non-person entity such as Organization, Institution, Agency or Business.	Required	minLength 1 maxLength 60
Comment: In the College Transcript, this is the name of high school from which the student graduated or the last high school the student attended.				
OPEID	Optional choice	The unique identifier assigned by the Office of Postsecondary Education for each data exchange partner.	Optional	minLength 3 maxLength 8
Comment: The OPEID code would not normally be used to identify a secondary school.				
NCHELPID	Optional choice	The unique identifier assigned by National Council on Higher Education Loan Programs for each data exchange partner.	Optional	minLength 3 maxLength 8
Comment: The NCHELPID code would not normally be used to identify a secondary school.				
IPEDS	Optional choice	The unique identifier assigned by the National Center for Education Statistics for the Integrated Postsecondary Education Data System for each postsecondary data exchange partner.	Optional	minLength 6 maxLength 6

Comment: The IPEDS code would not normally be used to identify a secondary school.				
ATP	Optional choice	The unique identifier assigned for the Admissions Testing Program by the College Board for each postsecondary data exchange partner.	Optional	minLength 6 maxLength 6
Comment: The ATP code would not normally be used to identify a secondary school.				
FICE	Optional choice	The unique identifier assigned for the Federal Interagency Committee on Education by the US Department of Education's National Center for Education Statistics for each postsecondary data exchange partner	Optional	minLength 6 maxLength 6
Comment: The FICE code would not normally be used to identify a secondary school.				
ACT	Optional choice	The unique identifier assigned by the American College Testing or ACT for each postsecondary data exchange partner. See www.act.org.	Optional	minLength 4 maxLength 4
Comment: The ACT code would not normally be used to identify a secondary school.				
CCD	Optional choice	The unique identifier assigned by the US Department of Education's National Center for Education Statistics as the Common Core of Data for each K12 data exchange partner.	Optional	minLength 12 maxLength 12
CEEBACT	Optional choice	The unique identifier assigned by the College Entrance Examining Board and ACT for each data exchange partner.	Optional	minLength 6 maxLength 6
Comment: The CEEBACT code would normally be the code used to identify a secondary school.				
CSIS	Optional choice	The unique identifier assigned by the Statistics Canada Canadian College Student Information System for each data exchange partner	Optional	minLength 6 maxLength 6
USIS	Optional choice	The unique identifier assigned by the Statistics Canada University Student Information System for each data exchange partner	Optional	minLength 6 maxLength 6
ESIS	Optional choice	The unique identifier assigned by the Statistics Canada Enhanced Student Information System for each data exchange partner.	Optional	minLength 8 maxLength 8
Comment: The ESIS is the preferred code used now in Canada to identify a Canadian secondary school.				
DUNS	Optional choice	Data Universal Numbering System (DUNS), unique nine character company identification number issued by Dun and Bradstreet Corporation.	Optional	minLength 9 maxLength 9
Comment: The DUNS code would not normally be used to identify a secondary school.				
Comment: The inclusion of the secondary school from which the student graduated or the secondary school last attended can be helpful in matching this transcript with the admissions record at the receiving school.				

Code illustration:

```
<HighSchool>
  <OrganizationName>AUSTIN HIGH SCHOOL</OrganizationName>
  <CEEBACT>440320</CEEBACT>
</HighSchool>
```

Student.Person.Contacts

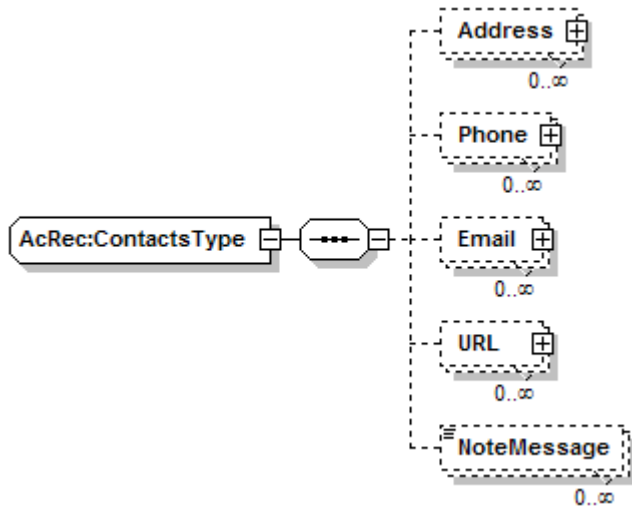

Tag Name	Schema Use	Description	Recommended Use	Format
Address	Optional Repeatable	This is a combined Address Group for a choice between Domestic or International	Recommended	minOcc 0 maxOcc ∞
Phone	Optional Repeatable	Phone number(s) for the student	Recommended	minOcc 0 maxOcc ∞
Email	Optional Repeatable	Email address(es) for the student	Recommended	minOcc 0 maxOcc ∞
URL	Optional Repeatable	Personal URL(s) on record for the student	Not Recommended	minOcc 0 maxOcc ∞
NoteMessage	Optional Repeatable	Additional information about the Contact	Not Recommended	minLength 1 maxLength 80

Comment:

Comment: The inclusion of the contact information about the student whose transcript is being sent can be helpful at the receiving institution for additional matching criteria. It can also be of use at the receiving school (if the student has not yet applied for admission there) to create a skeletal admissions record if that is the procedure at the receiving school, or it may also be used in an attempt to contact the student to encourage the student to submit an application.

Code illustration:

```
<Contacts>
  <Address>
*
*
    </Address>
    <Phone>
*
*
    </Phone>
    <Email>
*
*
    </Email>
    <URL>
*
*
    </URL>
  <NoteMessage/>
</Contacts>
```

Student.Person.Contacts.Address

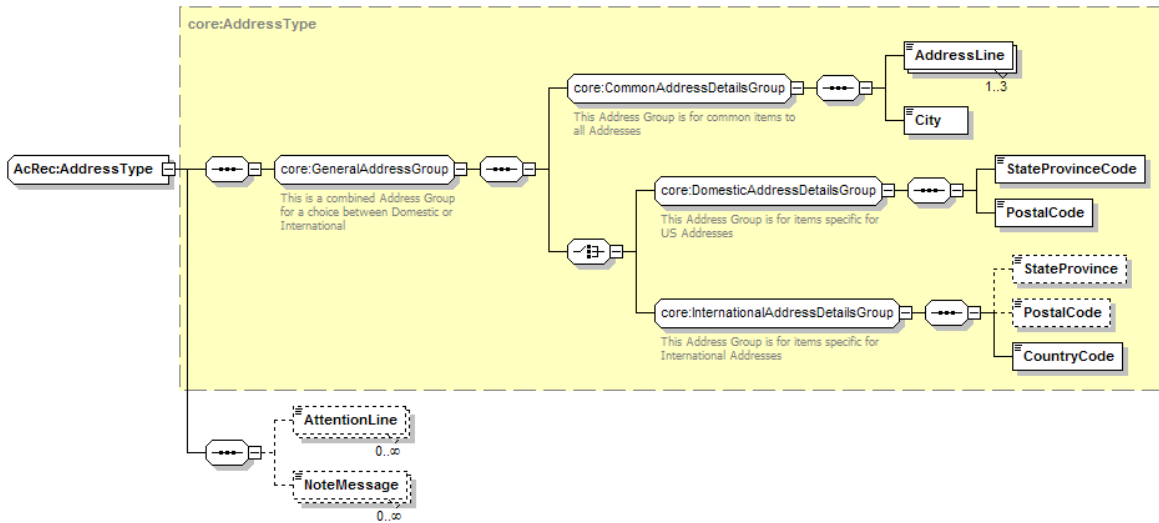

Tag Name	Schema Use	Description	Recommended Use	Format
CommonAddressDetailsGroup	Required	This Address Group is for common items to all Addresses	Required	minOcc 1 maxOcc 1
	Comment: [CommonAddressDetailsGroup] is not a tag and does not appear in the instance document. If the address of a contact is included in the transcript, then this must be sent. It is required and must be paired with one of either DomesticAddressDetailsGroup or InternationalAddressDetailsGroup.			
DomesticAddressDetailsGroup	Required choice	This Address Group is for items specific for US Addresses	Required for domestic addresses	minOcc 1 maxOcc 1
	Comment: [DomesticAddressDetailsGroup] is not a tag and does not appear in the instance document. If the address has a United States or Canadian Postal Code and a US State or Canadian Province Code, then this should be the required choice.			
InternationalAddressDetailsGroup	Required choice	This Address Group is for items specific for International Addresses	Required for international addresses	minOcc 1 maxOcc 1
	Comment: [InternationalAddressDetailsGroup] is not a tag and does not appear in the instance document. This choice is for addresses that do not have a US or Canadian postal code.			
AttentionLine	Optional	The individual or office name within the postal address where the delivery should be directed.	Optional	minOcc 0 maxOcc ∞ minLength 1 maxLength 45
NoteMessage	Optional Repeatable	Additional information about the Address	Not Recommended	minOcc 0 maxOcc ∞
	Comment:			
	Comment:			

Code illustration:

```
<Address>
  <AddressLine>1234 Congress Ave.</AddressLine>
  <AddressLine>Apt. 345</AddressLine>
  <City>Austin</City>
  <StateProvinceCode>TX</StateProvinceCode>
  <PostalCode>78718</PostalCode>
  <AttentionLine/>
  <NoteMessage/>
</Address>
```

Student.Person.Contacts.Address.CommonAddressDetailsGroup

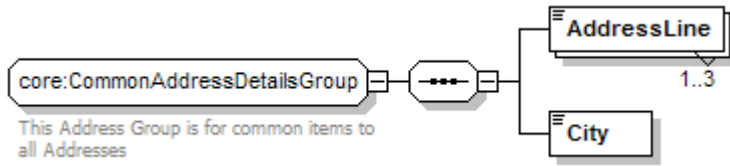

Tag Name	Schema Use	Description	Recommended Use	Format
AddressLine	Required Repeatable	Local delivery information such as street, building number, PO box, or apartment portion of a postal address.		minOcc 1 maxOcc 3 minLength 1 maxLength 40
City	Required	The city portion of the Address.		minOcc 1 maxOcc 1 minLength 2 maxLength 30
	Comment:			
	Comment:			

Code illustration:

```
<AddressLine>23 Calle Ocho</AddressLine>
<AddressLine>Suite D</AddressLine>
<City>Mexico City</City>
```

Student.Person.Contacts.Address.DomesticAddressDetailsGroup

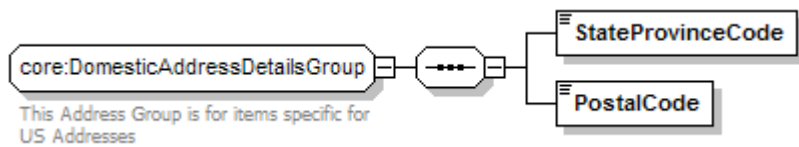

Tag Name	Schema Use	Description	Recommended Use	Format
StateProvinceCode	Required	Code for US states, etc., and Canadian provinces.	Required	See Appendix A
PostalCode	Required	The postal code portion of the Address.	Required	minLength 1 maxLength 17
	Comment:			
	Comment:			

Code illustration:

```
<StateProvinceCode>TX</StateProvinceCode>
<PostalCode>78712</PostalCode>
```

Student.Person.Contacts.Address.InternationalAddressDetailsGroup

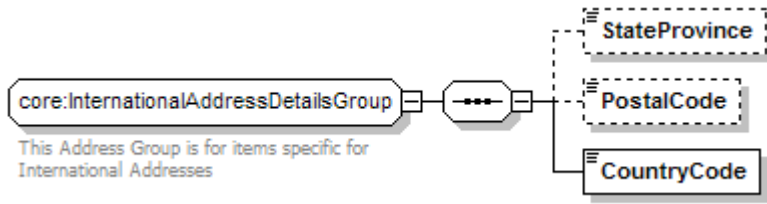

Tag Name	Schema Use	Description	Recommended Use	Format
StateProvince	Optional	The literal name of the state, province or territory of a postal address. Use for addresses outside US or Canada.	Recommended	minLength 2 maxLength 30
PostalCode	Optional	The postal code portion of the Address.	Recommended	minLength 1
CountryCode	Required	Code indicating Country. Use ISO 3166-1 alpha-2 standard.	Required	See Appendix B
	Comment:			
	Comment:			

Code illustration:

```
<StateProvince>Nuevo Leon</StateProvince>
<PostalCode>24 HT 5</PostalCode>
<CountryCode>MX</CountryCode>
```

Student.Person.Contacts.Phone

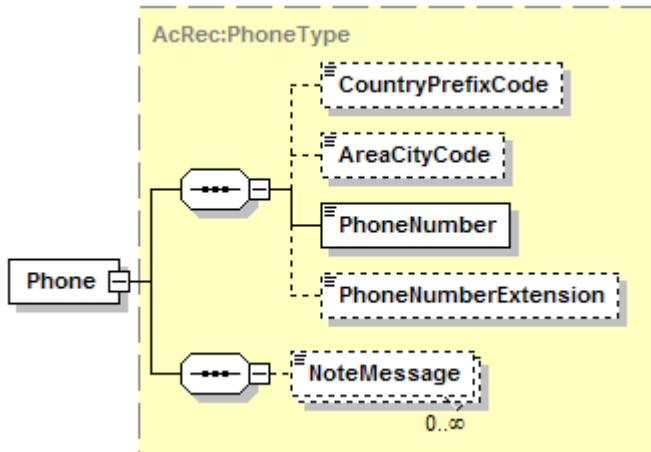

Tag Name	Schema Use	Description	Recommended Use	Format
CountryPrefixCode	Optional	International dialing code.	Optional	minLength 1 maxLength 3
AreaCityCode	Optional	Regional dialing code.	Recommended	minLength 1 maxLength 5
Comment: For phone numbers in the United States and Canada, this is the normal three digit area code.				
PhoneNumber	Required	Telephone number.	Required	minLength 1 maxLength 11
PhoneNumberExtension	Optional	The extended telephone addressing information used in addition to phone number such as a PBX extension, a pager PIN, or FAX sub-address.	Optional	minLength 1 maxLength 5
NoteMessage	Optional Repeatable	Additional information about the phone number	Not Recommended	minOcc 0 maxOcc ∞
Comment:				
Comment:				

Code illustration:

```

<Phone>
  <CountryPrefixCode/>
  <AreaCityCode>512</AreaCityCode>
  <PhoneNumber>4757638</PhoneNumber>
  <PhoneNumberExtension/>
  <NoteMessage/>
</Phone>
    
```

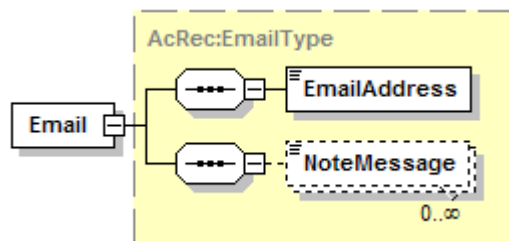
Student.Person.Contacts.Email

Tag Name	Schema Use	Description	Recommended Use	Format
EmailAddress	Required	The numbers, letters, and symbols used to identify an electronic mail (Email) user within a network.	Required	minLength 1 maxLength 128
NoteMessage	Optional Repeatable	Additional information about the email address	Not recommended	minOcc 0 maxOcc ∞
Comment:				
Comment:				

Code illustration:

```

<Email>
  <EmailAddress/>
  <NoteMessage/>
</Email>

```

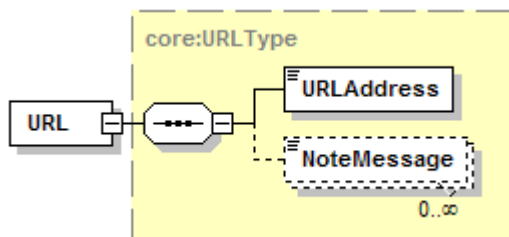
Student.Person.Contacts.URL

Tag Name	Schema Use	Description	Recommended Use	Format
URLAddress	Required	The Uniform Resource Locator (URL) address associated with a student	Required	minLength 0 maxLength 512
NoteMessage	Optional Repeatable	Additional information about the URL	Not recommended	minLength 1 maxLength 80
	Comment:			
	Comment:			

Code illustration:

```

<URL>
  <URLAddress/>
  <NoteMessage/>
</URL>

```

Student.Person.Gender

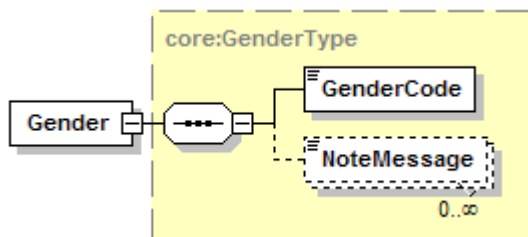

Tag Name	Schema Use	Description	Recommended Use	Format
GenderCode	Required	The gender of the Student	Required	Enumeration: Female Male Unreported
NoteMessage	Optional Repeatable	Additional information about Gender	Not Recommended	minLength 1 maxLength 80
Comment:				
Comment:				

Code illustration:

```
<Gender>
  <GenderCode>Female</GenderCode>
</Gender>
```

Student.Person.Residency

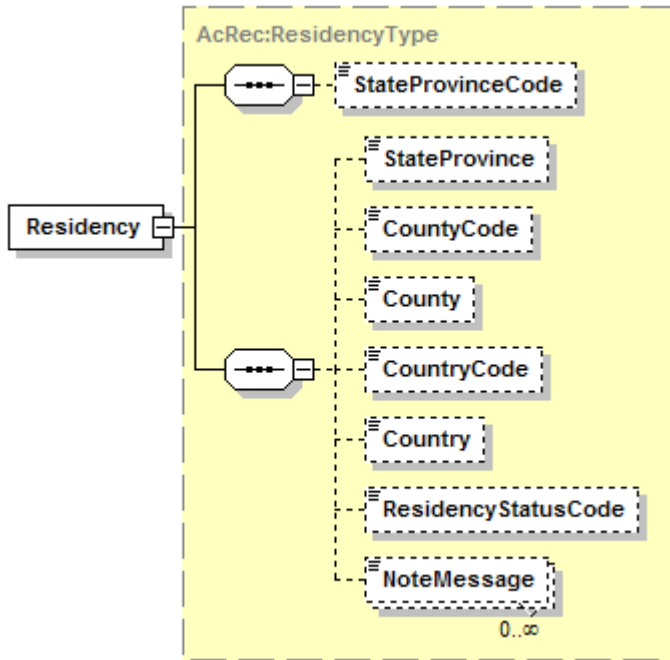

Tag Name	Schema Use	Description	Recommended Use	Format
StateProvinceCode	Optional	Code for US states, etc., and Canadian provinces.	Recommended	See Appendix A
StateProvince	Optional	The literal name of the state, province or territory of a postal address. Use for addresses outside US or Canada.	Optional	minLength 2 maxLength 30
CountyCode	Optional	Code indicating County. Use ISO standard. May need to add code set qualifier	Optional	minLength 2 maxLength 3
Comment: The county code would be of questionable value to a recipient school in another, non adjoining state.				
County	Optional	Freeform name of county	Optional	minLength 1 maxLength 30
Comment: The county name would be of questionable value to a recipient school in another, non adjoining state.				
CountryCode	Optional	Code indicating Country. Use ISO 3166-1 alpha-2 standard.	Optional	See Appendix B
Country	Optional	Freeform name of country	Optional	minLength 1 maxLength 30
ResidencyStatusCode	Optional	Residency Classification within a state used to assess tuition and other changes	Optional	Enumeration: Resident NonResident NotReported
NoteMessage	Optional Repeatable	Additional information about Residency	Not Recommended	minLength 1 maxLength 80
Comment:				
Comment: This set of residency data is optional for the college transcript, but could be helpful as additional information in making a residency determination at a recipient public institution.				

Code illustration:

```
<Residency>  
  <StateProvinceCode/>  
  <StateProvince/>  
  <CountyCode/>  
  <County/>  
  <CountryCode/>  
  <Country/>  
  <ResidencyStatusCode/>  
  <NoteMessage/>  
</Residency>
```

Student.Person.Deceased

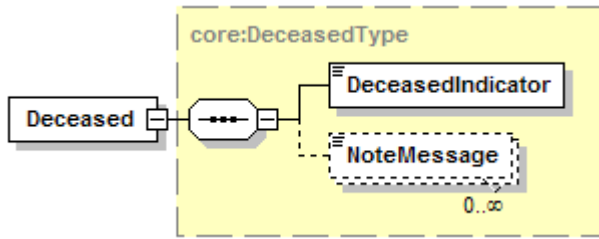

Tag Name	Schema Use	Description	Recommended Use	Format
DeceasedIndicator	Required	Indicates the person is deceased.	Required	true/false
Comment: A value of 'true' indicates the person is deceased.				
NoteMessage	Optional Repeatable	Additional information about the deceased student	Not Recommended	minLength 1 maxLength 80
Comment:				
Comment: If it is known by the sending institution that the student is deceased, then the inclusion of this indicator can be helpful in preventing the fraudulent use of the transcript by another applicant at the recipient school.				

Code illustration:

```
<Deceased>
  <DeceasedIndicator>true</DeceasedIndicator>
</Deceased>
```

Student.AcademicRecord

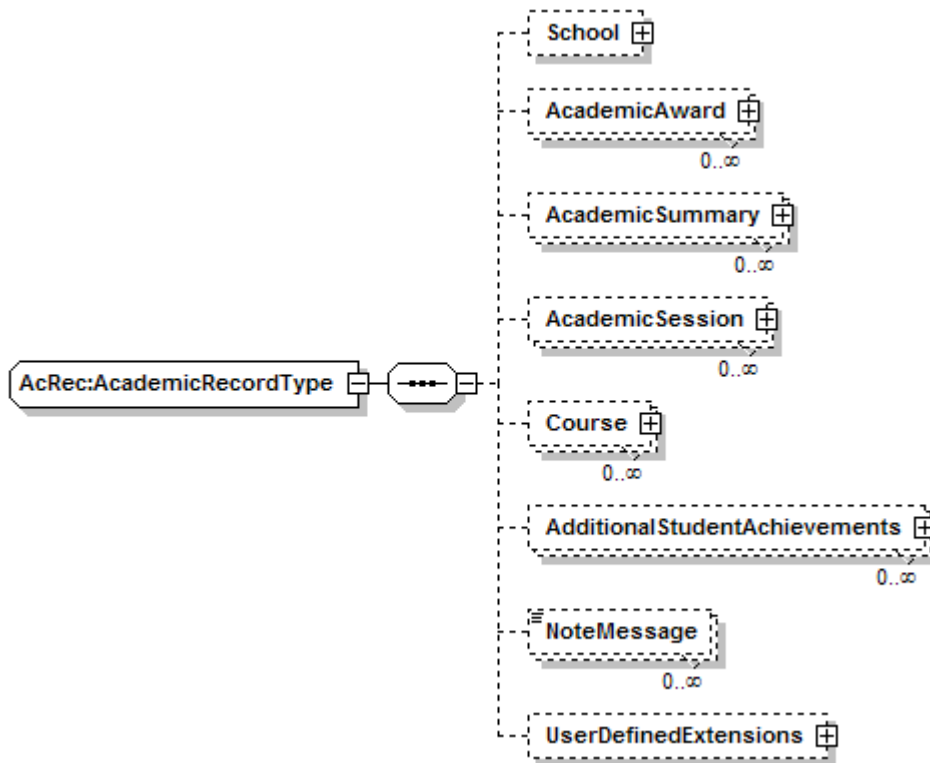

Tag Name	Schema Use	Description	Recommended Use	Format
School	Optional	Override school	Conditional	
	Comment: Recommended when the school for this repetition of AcademicRecord differs from the Sending institution. Not Recommended when this AcademicRecord belongs to the Sending institution.			
AcademicAward	Optional Repeatable	Academic awards, degrees, diplomas, certifications, etc.	Optional	
	Comment: AcademicAward in this position is not tied to an AcademicSession. Some institutions may wish to indicate AcademicAward in the AcademicSession in which it was earned.			
AcademicSummary	Optional Repeatable	Used to send summary totals for all work taken at a certain academic level	Recommended	
	Comment: AcademicSummary in this position is not tied to an AcademicSession. Some institutions may wish to indicate AcademicSummary in the AcademicSession in which it was earned.			
AcademicSession	Optional Repeatable	Course, award and summary information related to a specific time period. Typically arranged into successive quarters or semesters and is the preferred method for conveying academic coursework.	Recommended	
Course	Optional Repeatable	Academic coursework not related to a specific academic session.	Optional	
	Comment: Course in this position is not tied to an AcademicSession. It is appropriate here when session information is not known or course is not related to a specific academic session. It is recommended to include coursework within academic session whenever possible.			

AdditionalStudentAchievements	Optional Repeatable	Achievements not tied to a specific course, session or award.	Optional	
NoteMessage	Optional Repeatable	Additional information about the student's academic record.	Not Recommended	minLength 1 maxLength 80
UserDefinedExtensions	Optional	Additional structured information. Requires mutually defined XML schema.	Optional	
Comment:				
Comment:				

Code illustration:

```

    <AcademicRecord>
      <School>
*
*
        </School>
        <AcademicAward>
*
*
          </AcademicAward>
          <AcademicSummary>
*
*
            </AcademicSummary>
            <AcademicSession>
*
*
              </AcademicSession>
              <Course>
*
*
                </Course>
                <AdditionalStudentAchievements>
*
*
                  </AdditionalStudentAchievements>
                  <NoteMessage/>
                  <UserDefinedExtensions/>
            </AcademicRecord>

```

Student.AcademicRecord.School

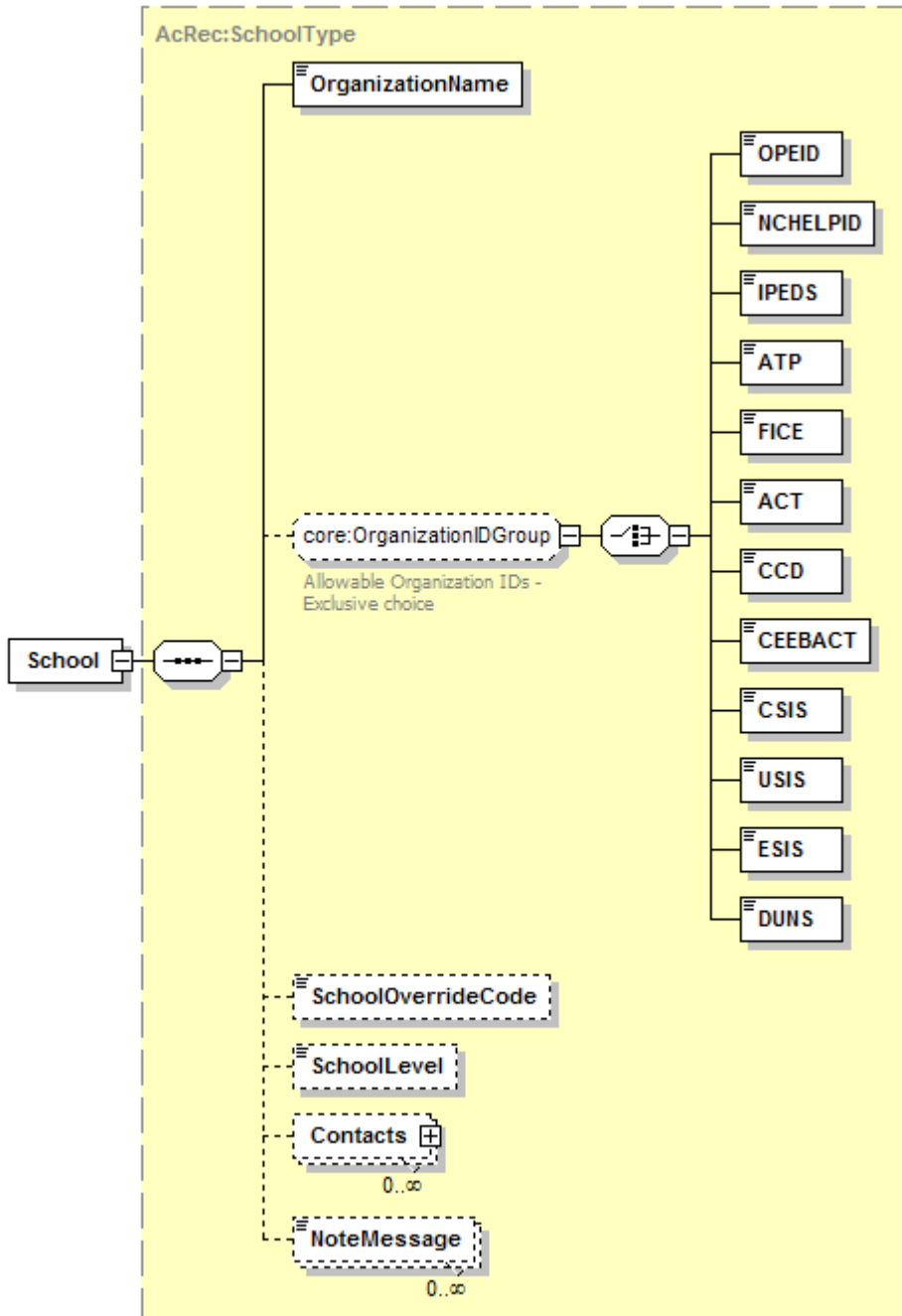

Tag Name	Schema Use	Description	Recommended Use	Format
OrganizationName	Required	Name of Override School.	Required	minLength 1 maxLength 60
OPEID	Optional exclusive choice	The unique identifier assigned by the Office of Postsecondary Education for each data exchange partner.	Recommended (use one)	minLength 3 maxLength 8

NHELPIID	Optional exclusive choice	The unique identifier assigned by National Council on Higher Education Loan Programs for each data exchange partner.	Recommended (use one)	minLength 3 maxLength 8
IPEDS	Optional exclusive choice	The unique identifier assigned by the National Center for Education Statistics for the Integrated Postsecondary Education Data System for each postsecondary data exchange partner.	Recommended (use one)	minLength 6 maxLength 6
ATP	Optional exclusive choice	The unique identifier assigned for the Admissions Testing Program by the College Board for each postsecondary data exchange partner.	Recommended (use one)	minLength 6 maxLength 6
FICE	Optional exclusive choice	The unique identifier assigned for the Federal Interagency Committee on Education by the US Department of Education's National Center for Education Statistics for each postsecondary data exchange partner	Recommended (use one)	minLength 6 maxLength 6
ACT	Optional exclusive choice	The unique identifier assigned by the American College Testing or ACT for each postsecondary data exchange partner. See www.act.org .	Recommended (use one)	minLength 4 maxLength 4
CCD	Optional exclusive choice	The unique identifier assigned by the US Department of Education's National Center for Education Statistics as the Common Core of Data for each K12 data exchange partner.	Recommended (use one)	minLength 12 maxLength 12
CEEBACT	Optional exclusive choice	The unique identifier assigned by the College Entrance Examining Board and ACT for each data exchange partner.	Recommended (use one)	minLength 6 maxLength 6
CSIS	Optional exclusive choice	The unique identifier assigned by the Statistics Canada Canadian College Student Information System for each data exchange partner	Recommended (use one)	minLength 6 maxLength 6
USIS	Optional exclusive choice	The unique identifier assigned by the Statistics Canada University Student Information System for each data exchange partner	Recommended (use one)	minLength 6 maxLength 6
ESIS	Optional exclusive choice	The unique identifier assigned by the Statistics Canada Enhanced Student Information System for each data exchange partner.	Recommended (use one)	minLength 8 maxLength 8
DUNS	Optional exclusive choice	Data Universal Numbering System (DUNS), unique nine character company identification number issued by Dun and Bradstreet Corporation.	Recommended (use one)	minLength 9 maxLength 9

SchoolOverrideCode	Optional	The source of the academic credit if not awarded by the home or parent institution. Institutional – Institutional Agreement Multicampus – Multiple Campus Course Offering Transfer – Transfer Credit StudyAbroad – Study Abroad Coop – Cooperative Program Reciprocal – Reciprocal Exchange Internship – Internship	Recommended	Enumeration: Institutional Multicampus Transfer StudyAbroad Coop Reciprocal Internship
SchoolLevel	Optional	Indicates level of Override School	Recommended	Enumeration: Elementary Secondary Postsecondary
Contacts	Optional Repeatable	Contact info at Override School	Optional	
NoteMessage	Optional Repeatable	Additional information about the Override School	Not Recommended	minLength 1 maxLength 80

Comment:

Comment:

Code illustration:

```

<School>
  <OrganizationName>TEXAS A&M UNIVERSITY COLLEGE STATION</OrganizationName>
  <ATP>006003</ATP>
  <SchoolOverrideCode>Transfer</SchoolOverrideCode>
  <SchoolLevel>Postsecondary</SchoolLevel>
  <Contacts>
*
*
  </Contacts>
</School>
    
```

Student.AcademicRecord.School.Contacts

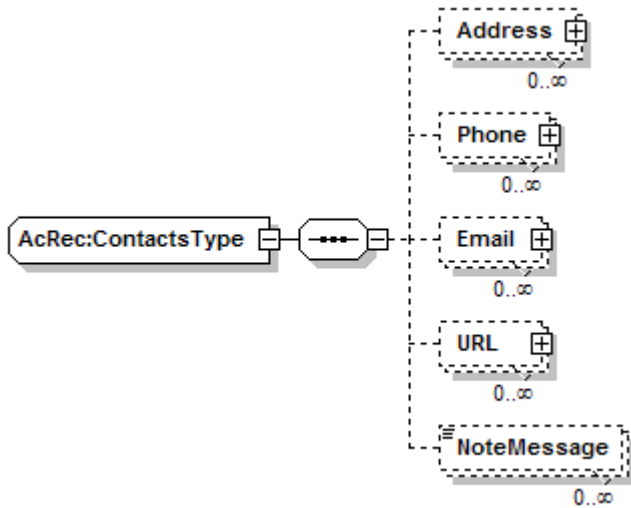

Tag Name	Schema Use	Description	Recommended Use	Format
Address	Optional Repeatable	Address of the Override School	Recommended	minOcc 0 maxOcc ∞
Phone	Optional Repeatable	Phone Number of the Override School	Optional	minOcc 0 maxOcc ∞
Email	Optional Repeatable	Email Address of the Override School	Optional	minOcc 0 maxOcc ∞
URL	Optional Repeatable	Universal Resouce Locator of the Override School	Optional	minOcc 0 maxOcc ∞
NoteMessage	Optional Repeatable	Additional information about the contacts at the Override School	Not Recommended	minLength 1 maxLength 80
	Comment:			
	Comment:			

Code illustration:

```

<Contacts>
  <Address>
*
*
  </Address>
  <Phone>
*
*
  </Phone>
  <Email>
*
  </Email>
  <URL>
*
  </URL>
  <NoteMessage/>
</Contacts>
    
```

Student.AcademicRecord.School.Contacts.Address

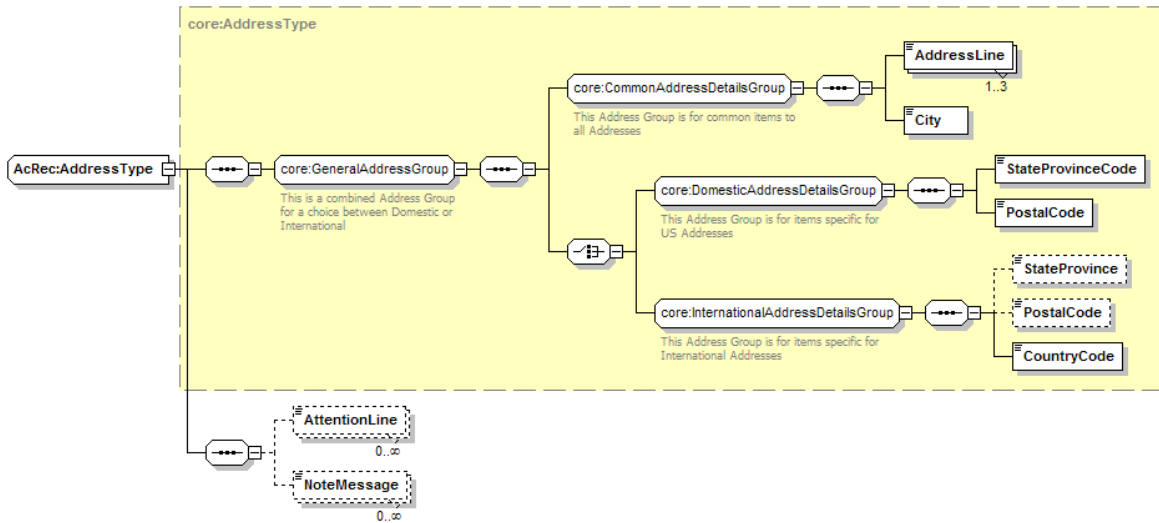

Tag Name	Schema Use	Description	Recommended Use	Format
CommonAddressDetailsGroup	Required	This Address Group is for items common to all Addresses	Required	minOcc 1 maxOcc 1
	Comment: [CommonAddressDetailsGroup] is not a tag and does not appear in the instance document. If the address of a contact is included in the transcript, then this must be sent. It is required and must be paired with one of either DomesticAddressDetailsGroup or InternationalAddressDetailsGroup.			
DomesticAddressDetailsGroup	Required choice	This Address Group is for items specific for US and Canadian Addresses	Required for domestic addresses	minOcc 1 maxOcc 1
	Comment: [DomesticAddressDetailsGroup] is not a tag and does not appear in the instance document. If the address has a United States or Canadian Postal Code and a US State or Canadian Province Code, then this should be the required choice.			
InternationalAddressDetailsGroup	Required choice	This Address Group is for items specific for International Addresses	Required for international addresses	minOcc 1 maxOcc 1
	Comment: [InternationalAddressDetailsGroup] is not a tag and does not appear in the instance document. This choice is for addresses that do not have a US or Canadian postal code.			
AttentionLine	Optional	The individual or office name within the postal address where inquiries should be directed.	Optional	minOcc 0 maxOcc ∞ minLength 1 maxLength 45
NoteMessage	Optional Repeatabe	Additional information about the Address of the Override School	Not Recommended	minOcc 0 maxOcc ∞
	Comment:			
	Comment:			

Code illustration:

```
<Address>  
  <AddressLine>Office of the Registrar</AddressLine>  
  <AddressLine>1 University Station</AddressLine>  
  <City>Austin</City>  
  <StateProvinceCode>TX</StateProvinceCode>  
  <PostalCode>78712</PostalCode>  
  <AttentionLine>Jane Shaugness</AttentionLine>  
  <NoteMessage/>  
</Address>
```

Student.AcademicRecord.School.Contacts.Address.CommonAddressDetailsGroup

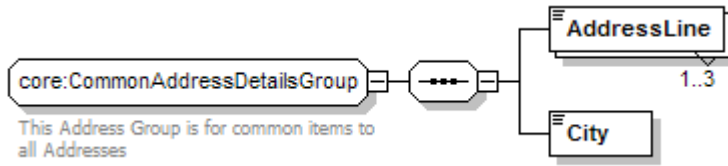

Tag Name	Schema Use	Description	Recommended Use	Format
AddressLine	Required Repeatable	Local delivery information such as street, building number, PO box, or apartment portion of a postal address.	Required	minOcc 1 maxOcc 3 minLength 1 maxLength 40
City	Required	The city portion of the Address.	Required	minOcc 1 maxOcc 1 minLength 2 maxLength 30
Comment:				
Comment:				

Code illustration:

```
<AddressLine>University of Oxford</AddressLine>
<AddressLine>Wellington Square</AddressLine>
<City>Oxford</City>
```

Student.AcademicRecord.School.Contacts.Address.DomesticAddressDetailsGroup

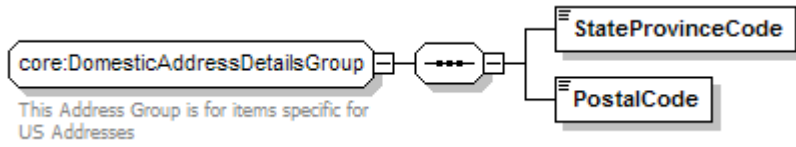

Tag Name	Schema Use	Description	Recommended Use	Format
StateProvinceCode	Required	Code for US states, etc., and Canadian provinces.	Required	See Appendix A
PostalCode	Required	The postal code portion of the Address.	Required	minLength 1 maxLength 17
	Comment:			
	Comment:			

Code illustration:

```
<StateProvinceCode>TX</StateProvinceCode>
<PostalCode>78712</PostalCode>
```

Student.AcademicRecord.School.Contacts.Address.InternationalAddressDetailsGroup

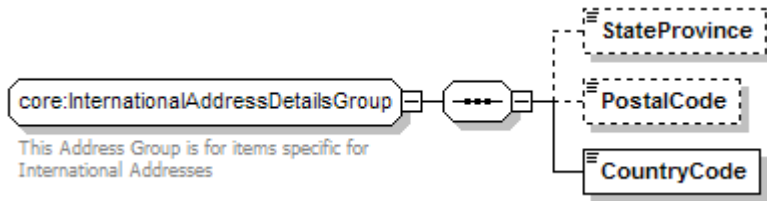

Tag Name	Schema Use	Description	Recommended Use	Format
StateProvince	Optional	The literal name of the state, province or territory of a postal address. Use for addresses outside US or Canada.	Optional	minLength 2 maxLength 30
Comment: For an internet resource of states or other geographical subdivisions in countries other than the US and Canada, you might choose to refer to the website of the Universal Postal Union at http://www.upu.int				
PostalCode	Optional	The postal code portion of the Address.	Optional	minLength 1
Comment: For an internet resource of states or other geographical subdivisions in countries other than the US and Canada, you might choose to refer to the website of the Universal Postal Union at http://www.upu.int				
CountryCode	Required	Code indicating Country. Use ISO 3166-1 alpha-2 standard.	Required	See Appendix B
Comment:				
Comment:				

Code illustration:

```
<PostalCode>0X1 2JD</PostalCode>
<CountryCode>GB</CountryCode>
```

Student.AcademicRecord.School.Contacts.Phone

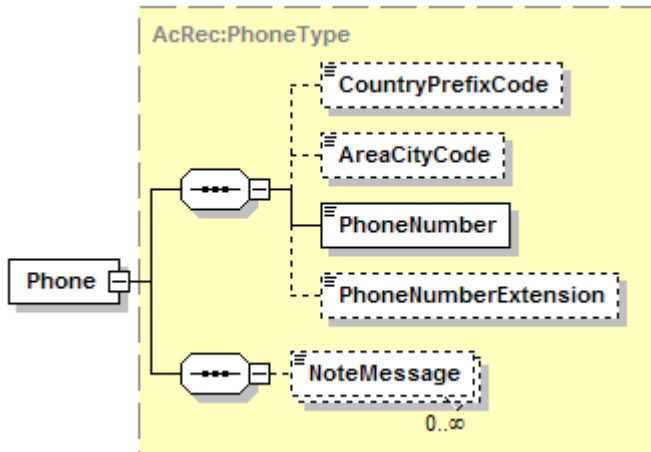

Tag Name	Schema Use	Description	Recommended Use	Format
CountryPrefixCode	Optional	International dialing code.	Optional	minLength 1 maxLength 3
AreaCityCode	Optional	Regional dialing code.	Recommended	minLength 1 maxLength 5
PhoneNumber	Required	Telephone number.	Required	minLength 1 maxLength 11
PhoneNumberExtension	Optional	The extended telephone addressing information used in addition to phone number such as a PBX extension, a pager PIN, or FAX sub-address.	Optional	minLength 1 maxLength 5
NoteMessage	Optional Repeatable	Additional information about the phone number of the Override School	Not recommended	minOcc 0 maxOcc ∞
Comment:				
Comment:				

Code illustration:

```

<Phone>
  <CountryPrefixCode/>
  <AreaCityCode>512</AreaCityCode>
  <PhoneNumber>4757638</PhoneNumber>
  <PhoneNumberExtension/>
  <NoteMessage/>
</Phone>
    
```

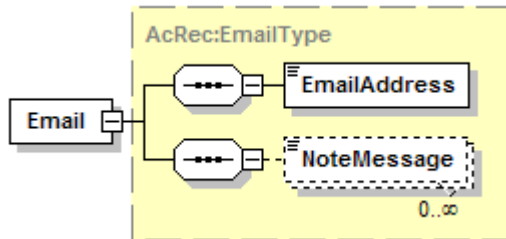
Student.AcademicRecord.School.Contacts.Email

Tag Name	Schema Use	Description	Recommended Use	Format
EmailAddress	Required	The numbers, letters, and symbols used to identify an electronic mail (Email) user within a network.	Required	minLength 1 maxLength 128
NoteMessage	Optional Repeatable	Additional information about the email address of the contact at the Override School	Not recommended	minOcc 0 maxOcc ∞
Comment:				
Comment:				

Code illustration:

```

<Email>
  <EmailAddress/>
  <NoteMessage/>
</Email>

```

Student.AcademicRecord.School.Contacts.URL

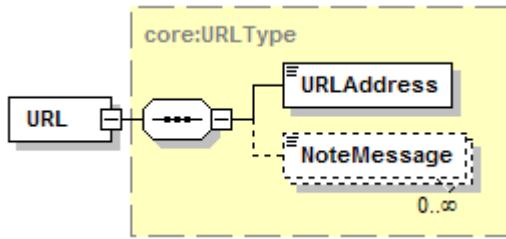

Tag Name	Schema Use	Description	Recommended Use	Format
URLAddress	Required	The Uniform Resource Locator (URL) address associated with a product, deliverable or contact.	Required	minLength 0 maxLength 512
NoteMessage	Optional Repeatable	Additional information about the Uniform Resource Locator address of the contact at the Override School	Not recommended	minLength 1 maxLength 80
	Comment:			
	Comment:			

Code illustration:

```

<URL>
  <URLAddress/>
  <NoteMessage/>
</URL>
    
```

Student.AcademicRecord.AcademicAward

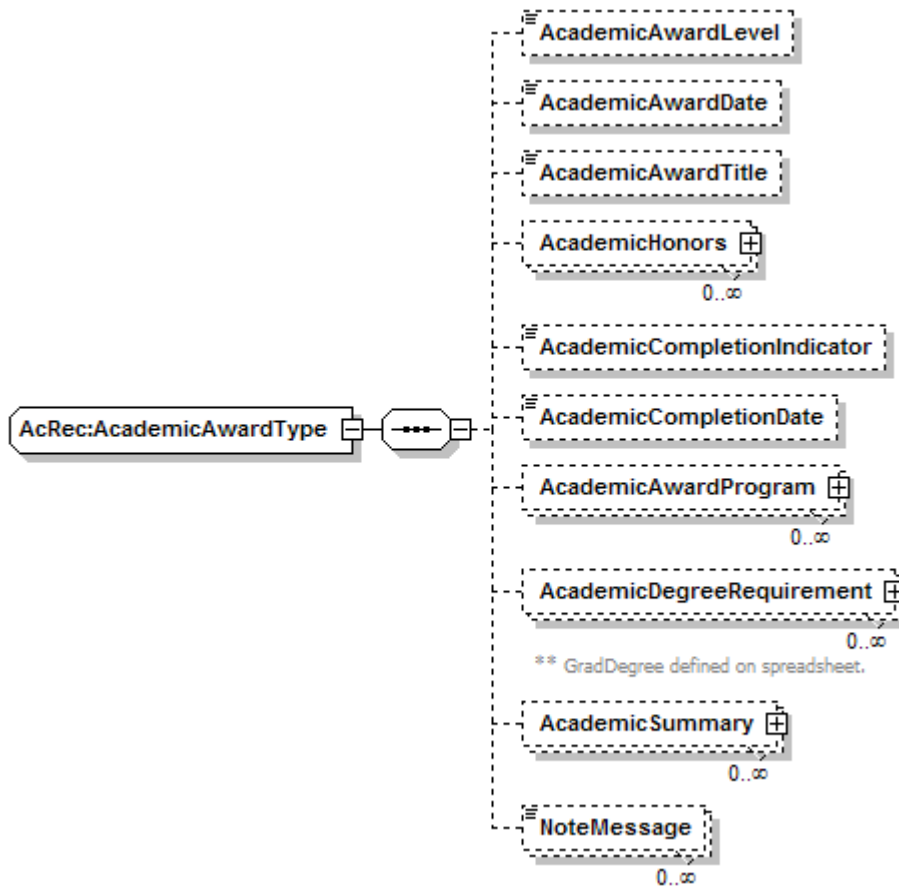

Tag Name	Schema Use	Description	Recommended Use	Format
AcademicAwardLevel	Optional	<p>The level of the degree, certificate, or award granted for the successful completion of requirements of an academic program.</p> <p>1.1 - Certificate of completion, 1.2 - Certificate of proficiency 2.0 - Certificate 2.1 Postsecondary Certificate Or Diploma (less than one year) 2.2 Postsecondary Certificate Or Diploma (one year or more but less than four years) 2.3 Associate Degree (e.g., Associate In Arts, Associate In Science) 2.4 Baccalaureate Degree 2.5 Baccalaureate (Honors) Degree 2.6 Postsecondary Certificate Or Diploma (one year or more but less than two years) 2.7 Postsecondary Certificate Or Diploma (two years or more but less than four years) 3.1 First Professional Degree 3.2 Post-Professional Degree 4.1 Graduate Certificate</p>	Recommended	<p>Enumeration:</p> <p>1.1 1.2 2.0 2.1 2.2 2.3 2.4 2.5 2.6 2.7 3.1 3.2 4.1 4.2 4.3 4.4 4.5</p>

		4.2 Master's Degree 4.3 Intermediate Graduate Degree 4.4 Doctoral Degree 4.5 Post-doctoral Award		
AcademicAwardDate	Optional	The date on which the academic award was conferred.	Recommended	xs:date
	Comment: This is the nominal date when the award was granted. It might not be the same as the actual date of completion of the award requirements.			
AcademicAwardTitle	Optional	The descriptive title for the academic award.	Recommended	minLength 1 maxLength 80
AcademicHonors	Optional Repeatable	Honors information for the academic award.	Recommended	
AcademicCompletionIndicator	Optional	An indication that the degree-seeking student completed all of the requirements for his or her academic program. Not used for Non-Degree programs.	Recommended	true/false
AcademicCompletionDate	Optional	The date on which the student's requirements for the degree were met or completed.	Recommended	xs:date
	Comment: This is the actual date when all requirements for the award were completed. It might not be the same as the nominal date of the award.			
AcademicAwardProgram	Optional Repeatable	Information related to the specific area of study (e.g. major) under which the award was granted.	Recommended	
AcademicDegreeRequirement	Optional Repeatable	Thesis or dissertation information if required for the award.	Recommended	
AcademicSummary	Optional Repeatable	Academic summary information pertaining to the award.	Optional	
NoteMessage	Optional Repeatable	Additional information about the academic award	Not Recommended	minLength 1 maxLength 80
	Comment:			
Comment: While academic award programs and summaries can be communicated in several different elements, it is recommended that they be reported at the highest appropriate level. E.G., use AcademicAward.AcademicAwardProgram to indicate degree major; AcademicAward.AcademicAwardProgram.ProgramSummary for degree major GPA and honors; AcademicAward.AcademicSummary for degree GPA and honors.				

Code illustration:

```
<AcademicAward>
  <AcademicAwardLevel>2.4</AcademicAwardLevel>
  <AcademicAwardDate>1990-05-09</AcademicAwardDate>
  <AcademicAwardTitle>BACHELOR OF ARTS</AcademicAwardTitle>
  <AcademicHonors>
*
*
    </AcademicHonors>
    <AcademicCompletionIndicator/>
    <AcademicCompletionDate/>
    <AcademicAwardProgram>
*
*
    </AcademicAwardProgram>
    <AcademicDegreeRequirement>
*
*
    </AcademicDegreeRequirement>
    <AcademicSummary>
*
*
    </AcademicSummary>
    <NoteMessage/>
  </AcademicAward>
```

Student.AcademicRecord.AcademicAward.AcademicHonors

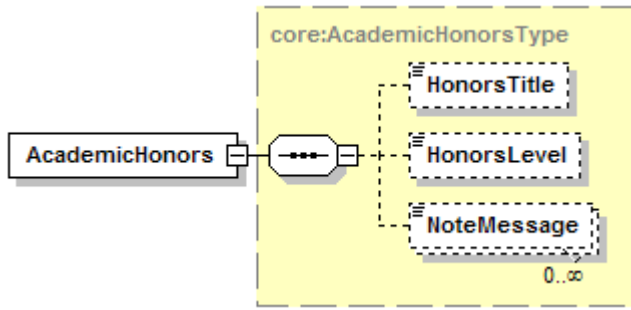

Tag Name	Schema Use	Description	Recommended Use	Format
HonorsTitle	Optional	The descriptive title for the honors received.	Recommended	minLength 1 maxLength 30
HonorsLevel	Optional	A code value representing 1st highest honor, 2nd highest and 3rd highest.	Recommended	Enumeration: FirstHighest SecondHighest ThirdHighest
	Comment: Honors Level is critical to understanding the context of Honors Title.			
NoteMessage	Optional Repeatable	Additional information about the academic honors	Not Recommended	minLength 1 maxLength 80
	Comment:			
Comment:				

Code illustration:

```

<AcademicHonors>
  <HonorsTitle/>
  <HonorsLevel>ThirdHighest</HonorsLevel>
</AcademicHonors>
    
```

Student.AcademicRecord.AcademicAward.AcademicAwardProgram

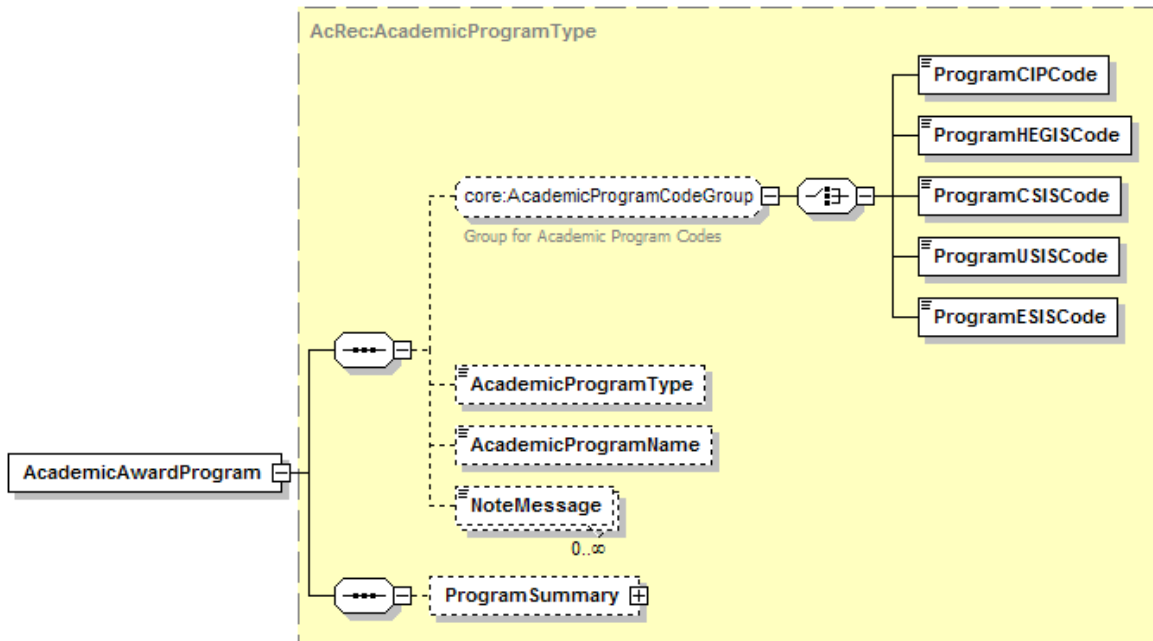

Tag Name	Schema Use	Description	Recommended Use	Format
ProgramCIPCode	Optional exclusive choice	Code indicating a discipline or field of study assigned by the Classification of Instructional Programs	Recommended (use one)	minLength 6 maxLength 20
ProgramHEGISCode	Optional exclusive choice	Code indicating a discipline or field of study assigned by Higher Education General Information Survey	Recommended (use one)	minLength 6 maxLength 20
ProgramCSISCode	Optional exclusive choice	Code indicating a discipline or field of study assigned by Statistics Canada Canadian College Student Information System	Recommended (use one)	minLength 5 maxLength 5
ProgramUSISCode	Optional exclusive choice	Code indicating a discipline or field of study assigned by the Statistics Canada University Student Information System.	Recommended (use one)	minLength 5 maxLength 5
ProgramESISCode	Optional exclusive choice	Code indicating a discipline or field of study assigned by the Statistics Canada Enhanced Student Information System.	Recommended (use one)	minLength 1 maxLength 20
AcademicProgramType	Optional	Indicates whether the academic program is a major, minor, area of concentration or specialization.	Recommended	Enumeration: Concentration Major Minor Specialization
AcademicProgramName	Optional	Literal name of program, major, or field of study.	Recommended	minLength 1 maxLength 60
NoteMessage	Optional Repeatable	Additional information about the Academic Award Program	Not Recommended	minLength 1 maxLength 80
ProgramSummary	Optional	Summary information about the Academic Award Program	Recommended	

Comment: Generally used for major GPA and minor GPA.

Comment:

Code illustration:

```
<AcademicAwardProgram>
  <ProgramCIPCode/>
  <AcademicProgramType>Major</AcademicProgramType>
  <AcademicProgramName>GOVERNMENT</AcademicProgramName>
  <ProgramSummary>
*
*
    </ProgramSummary>
  </AcademicAwardProgram>
```

Student.AcademicRecord.AcademicAward.AcademicAwardProgram.ProgramSummary

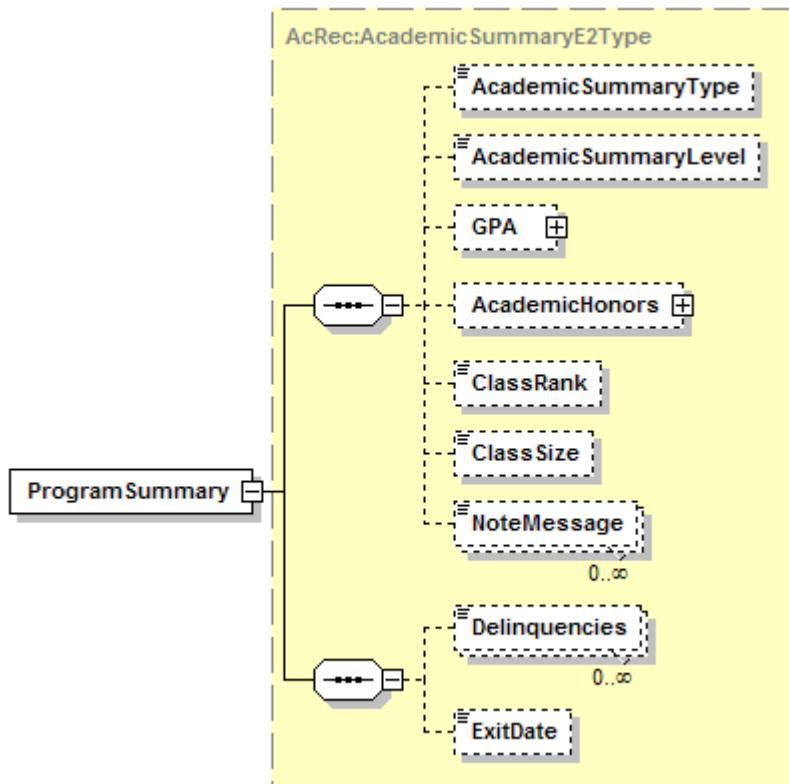

Tag Name	Schema Use	Description	Recommended Use	Format
AcademicSummaryType	Optional	<p>Summary Type is an indication of what is being summarized over what period of time.</p> <p>All – Summary of all courses regardless of institution SenderOnly – Summary of all courses at sending institution (or recorded as if they were taken at the TransferOnly – Summary of transfer work (courses taken at other than the sending institution) AllNotRepeated – Summary of all courses except for repeated or forgiven courses/credits SenderNotRepeated – Summary of all courses at sending institution except for repeated or forgiven courses/credits TransferNotRepeated – Summary of transfer work except for repeated or forgiven courses/credits AcademicRenewal – Subset of forgiven courses CarryoverCredit – Summary from offline records and used as the initial point for cumulatives and averages DegreeApplicable – Summary of course that apply to degree NonDegreeApplicable – Summary of courses that do not apply toward degree</p>	Recommended	Enumeration: All SenderOnly TransferOnly AllNotRepeated SenderNotRepeated TransferNotRepeated AcademicRenewal CarryoverCredit DegreeApplicable NonDegreeApplicable ConvertedFrom ConvertedTo UserDefined

		<p>ConvertedFrom – Summary of credits before an institutional term-basis conversion, such as from quarters to semesters</p> <p>ConvertedTo – Summary of credits after an institutional term-basis conversion, such as from quarters to semesters</p> <p>UserDefined – see NoteMessage for explanation</p>		
<p>Comment: 'DegreeApplicable' seems to be the only appropriate value in this context.</p>				
AcademicSummaryLevel	Optional	<p>The level of credit associated with the credit hours earned for the course.</p> <p>Undergraduate – Undergraduate</p> <p>LowerDivision – Lower division credit (associated with first/second year)</p> <p>UpperDivision – Higher or upper division credit (associated with third or fourth year)</p> <p>Vocational – Vocational/technical credit</p> <p>TechnicalPreparatory – Tech Prep credit</p> <p>Graduate – Graduate level credit</p> <p>Professional – Professional</p> <p>Dual – Dual level (upper division and graduate- may be applicable to a bachelor's degree or graduate degree or both)</p> <p>GraduateProfessional – Dual level (graduate and professional- may be applicable to both)</p>	Not Recommended	<p>Enumeration:</p> <p>Undergraduate</p> <p>LowerDivision</p> <p>UpperDivision</p> <p>Vocational</p> <p>TechnicalPreparatory</p> <p>Graduate</p> <p>Professional</p> <p>Dual</p> <p>GraduateProfessional</p>
GPA	Optional	GPA for the Award Program	Recommended	
AcademicHonors	Optional	Honors for the Award Program	Recommended	
ClassRank	Optional	The student's class rank relative to other students in their academic cohort (e.g. class).	Not Recommended	<p>minInclusive 1</p> <p>maxInclusive 9999</p> <p>totalDigits 4</p>
ClassSize	Optional	The numeric size of the academic cohort (e.g. class).	Not Recommended	<p>minInclusive 1</p> <p>maxInclusive 9999</p> <p>totalDigits 4</p>
NoteMessage	Optional Repeatable	Additional information about the Program Summary	Not Recommended	<p>minLength 1</p> <p>maxLength 80</p>
Delinquencies	Optional Repeatable	<p>The academic standing of the student upon transfer to the institution.</p> <p>GoodStanding - Student was in good standing</p> <p>ProbationGPA - Student was on academic probation (because of low GPA)</p> <p>ProbationHours - Student was on academic probation (deficiency in credit hours)</p> <p>SuspensionGPA - Student was on academic suspension (because of low GPA)</p> <p>SuspensionHours - Student was on academic suspension (deficiency in credit hours)</p> <p>ProbationDiscipline - Student was on disciplinary probation</p> <p>SuspensionDiscipline - Student was on disciplinary suspension</p>	Not Recommended	<p>Enumeration:</p> <p>GoodStanding</p> <p>ProbationGPA</p> <p>ProbationHours</p> <p>SuspensionGPA</p> <p>SuspensionHours</p> <p>ProbationDiscipline</p> <p>SuspensionDiscipline</p> <p>Unknown</p> <p>Other</p>

		Unknown Other		
ExitDate	Optional	The date on which the student officially withdrew or graduated.	Not Recommended	xs:date
	Comment:			
Comment:				

Code illustration:

```

<ProgramSummary>
  <AcademicSummaryType/>
  <AcademicSummaryLevel>Undergraduate</AcademicSummaryLevel>
  <GPA>
*
*
  </GPA>
  <AcademicHonors>
*
*
  </AcademicHonors>
  <ClassRank/>
  <ClassSize/>
  <NoteMessage/>
  <Delinquencies/>
  <ExitDate/>
</ProgramSummary>

```

Student.AcademicRecord.AcademicAward.AcademicAwardProgram.ProgramSummary.GPA

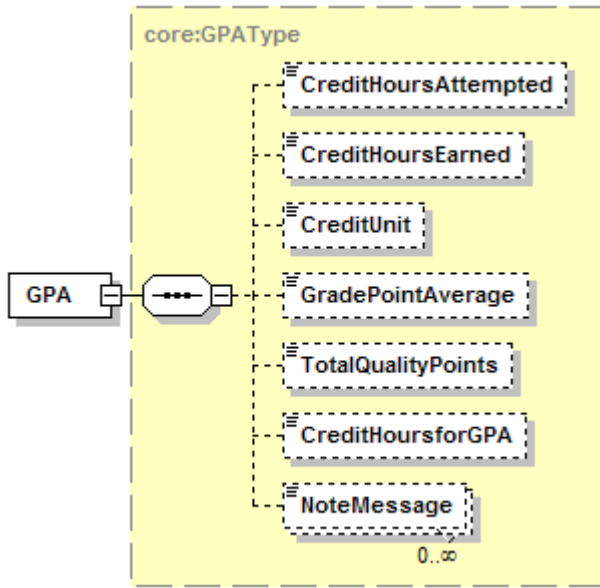

Tag Name	Schema Use	Description	Recommended Use	Format
CreditHoursAttempted	Optional	The total value of credit hours attempted whether or not included in the hours for GPA or hours earned.	Recommended	
CreditHoursEarned	Optional	The total value of credit hours successfully completed or earned.	Recommended	
CreditUnit	Optional	The type of credit (unit, semester, or quarter) associated with the credit hours earned for the course.	Recommended	Enumeration: NoCredit Quarter Semester Units ClockHours CarnegieUnits ContinuingEducationUnits Unreported Other
GradePointAverage	Optional	The value of the total quality points divided by the Credit Hours for Grade Point Average.	Recommended	xs:decimal
TotalQualityPoints	Optional	The total value of quality points used for the calculation of the Grade Point Average.	Recommended	xs:decimal
CreditHoursforGPA	Optional	The total value of credit hours included in the Grade Point Average.	Recommended	xs:decimal
NoteMessage	Optional Repeatable	Additional information about the GPA	Not Recommended	minLength 1 maxLength 80
Comment:				
Comment:				

Code illustration:

```
<GPA>  
  <CreditHoursAttempted>12</CreditHoursAttempted>  
  <CreditHoursEarned>12</CreditHoursEarned>  
  <CreditUnit>Semester </CreditUnit>  
  <GradePointAverage>3.75</GradePointAverage>  
  <TotalQualityPoints/>  
  <CreditHoursforGPA>12</CreditHoursforGPA>  
</GPA>
```

Student.AcademicRecord.AcademicAward.AcademicAwardProgram.ProgramSummary.AcademicHonors

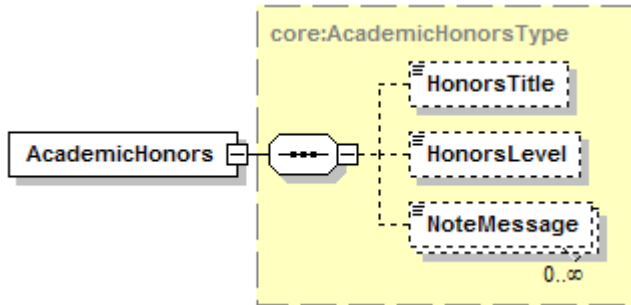

Tag Name	Schema Use	Description	Recommended Use	Format
HonorsTitle	Optional	The descriptive title for the honors received.	Recommended	minLength 1 maxLength 30
HonorsLevel	Optional	A code value representing 1st highest honor, 2nd highest and 3rd highest.	Recommended	Enumeration: FirstHighest SecondHighest ThirdHighest
NoteMessage	Optional Repeatable	Additional information about the Academic Honors	Not Recommended	minLength 1 maxLength 80
<i>Comment:</i>				
<i>Comment:</i>				

Code illustration:

```

<AcademicHonors>
  <HonorsTitle>Cum Laude</HonorsTitle>
  <HonorsLevel>ThirdHighest</HonorsLevel>
</AcademicHonors>
    
```

Student.AcademicRecord.AcademicAward.AcademicDegreeRequirement

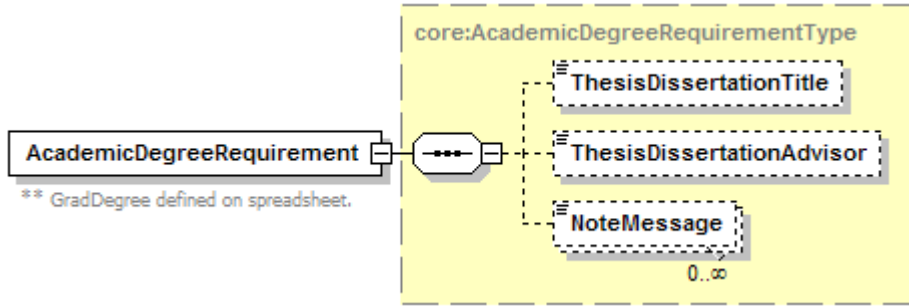

Tag Name	Schema Use	Description	Recommended Use	Format
ThesisDissertationTitle	Optional	The title of the thesis or dissertation.	Recommended	minLength 1
ThesisDissertationAdvisor	Optional	The advisor (Major Professor) supervising the Thesis or Dissertation on behalf of the student earning the degree.	Optional	minLength 1 maxLength 45
NoteMessage	Optional Repeatable	Additional information about the Academic Degree Requirement	Not Recommended	minLength 1 maxLength 80
Comment:				
Comment:				

Code illustration:

```

<AcademicDegreeRequirement>
  <ThesisDissertationTitle>[need example text]</ThesisDissertationTitle>
  <ThesisDissertationAdvisor>[need example test]</ThesisDissertationAdvisor>
</AcademicDegreeRequirement>
    
```

Student.AcademicRecord.AcademicAward.AcademicSummary

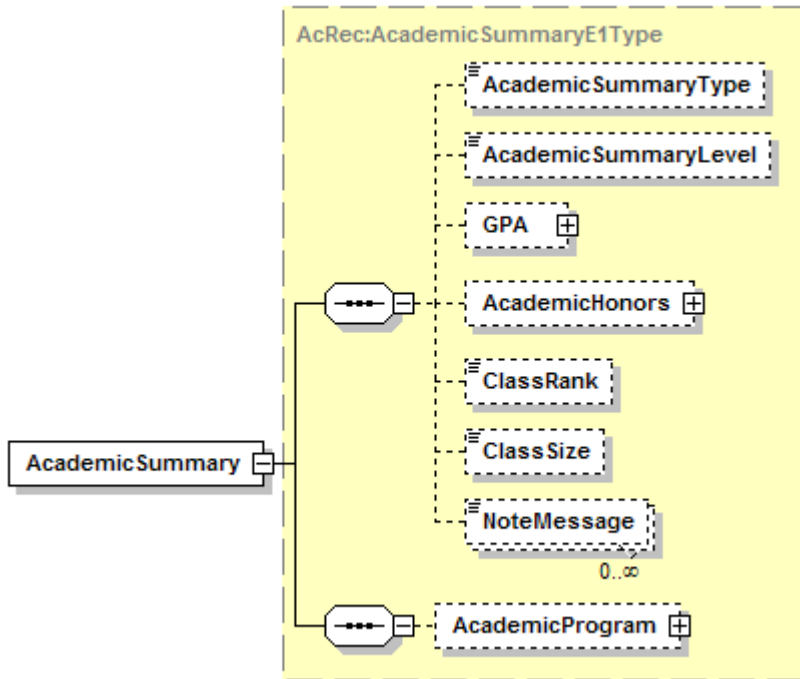

Tag Name	Schema Use	Description	Recommended Use	Format
AcademicSummaryType	Optional	<p>Summary Type is an indication of what is being summarized over what period of time</p> <p>All - Summary of all courses regardless of institution</p> <p>SenderOnly - Summary of all courses at sending institution (or recorded as if they were taken at the</p> <p>TransferOnly - Summary of transfer work (courses taken at other than the sending institution)</p> <p>AllNotRepeated - Summary of all courses except for repeated or forgiven courses/credits</p> <p>SenderNotRepeated - Summary of all courses at sending institution except for repeated or forgiven courses/credits</p> <p>TransferNotRepeated - Summary of transfer work except for repeated or forgiven courses/credits</p> <p>AcademicRenewal - Subset of forgiven courses</p> <p>CarryoverCredit - Summary from offline records and used as the initial point for cumulatives and averages</p> <p>DegreeApplicable - Summary of course that apply to degree</p> <p>NonDegreeApplicable - Summary of courses that do not apply toward degree</p> <p>ConvertedFrom - Summary of credits before an institutional term-basis conversion, such as from quarters to semesters</p> <p>ConvertedTo - Summary of credits</p>	Recommended	<p>Enumeration:</p> <p>All</p> <p>SenderOnly</p> <p>TransferOnly</p> <p>AllNotRepeated</p> <p>SenderNotRepeated</p> <p>TransferNotRepeated</p> <p>AcademicRenewal</p> <p>CarryoverCredit</p> <p>DegreeApplicable</p> <p>NonDegreeApplicable</p> <p>ConvertedFrom</p> <p>ConvertedTo</p> <p>UserDefined</p>

		after an institutional term-basis conversion, such as from quarters to semesters UserDefined - see NoteMessage for explanation		
Comment: 'DegreeApplicable' seems to be the only appropriate value in this context.				
AcademicSummaryLevel	Optional	The level of credit associated with the credit hours earned for the course.	Not Recommended	Enumeration: Undergraduate LowerDivision UpperDivision Vocational TechnicalPreparatory Graduate Professional Dual GraduateProfessional
GPA	Optional	GPA for the Academic Award	Recommended	
AcademicHonors	Optional	Honors for the Academic Award	Recommended	
ClassRank	Optional	The student's class rank relative to other students in their academic cohort (e.g. class).	Not Recommended	minInclusive 1 maxInclusive 9999 totalDigits 4
ClassSize	Optional	The numeric size of the academic cohort (e.g. class).	Not Recommended	minInclusive 1 maxInclusive 9999 totalDigits 4
NoteMessage	Optional Repeatable	Additional information about the Academic Summary	Not Recommended	minLength 1 maxLength 80
AcademicProgram	Optional	Academic Program(s) related to this Academic Summary	Not Recommended	
Comment:				
Comment: While academic award programs and summaries can be communicated in several different elements, it is recommended that they be reported at the highest appropriate level. E.G., use AcademicAward.AcademicAwardProgram to indicate degree major; AcademicAward.AcademicAwardProgram.ProgramSummary for degree major GPA and honors; AcademicAward.AcademicSummary for degree GPA and honors.				

Code illustration:

```

<AcademicSummary>
  <AcademicSummaryType>All</AcademicSummaryType>
  <AcademicSummaryLevel>Undergraduate</AcademicSummaryLevel>
  <GPA>
*
*
  </GPA>
  <AcademicHonors>
*
*
  </AcademicHonors>
  <ClassRank>43</ClassRank>
  <ClassSize>849</ClassSize>
  <AcademicProgram>
*
*
  </AcademicProgram>
</AcademicSummary>

```

Student.AcademicRecord.AcademicAward.AcademicSummary.GPA

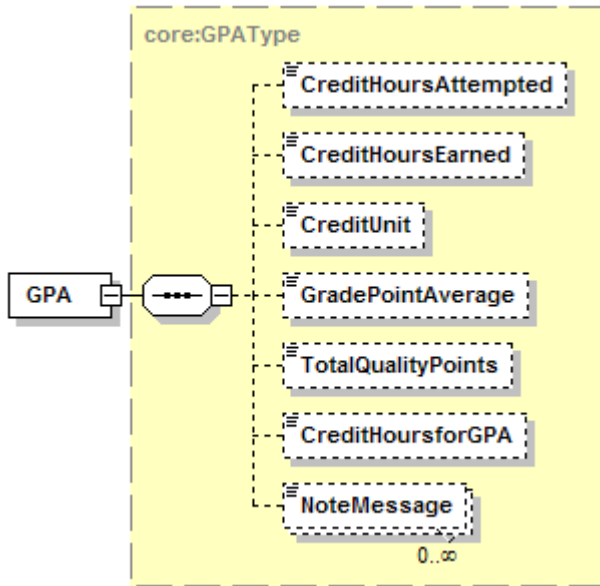

Tag Name	Schema Use	Description	Recommended Use	Format
CreditHoursAttempted	Optional	The total value of credit hours attempted whether or not included in the hours for GPA or hours earned.	Recommended	xs:decimal
CreditHoursEarned	Optional	The total value of credit hours successfully completed or earned.	Recommended	xs:decimal
CreditUnit	Optional	The type of credit (unit, semester, or quarter) associated with the credit hours earned for the course.	Recommended	Enumeration: NoCredit Quarter Semester Units ClockHours CarnegieUnits ContinuingEducationUnits Unreported Other
GradePointAverage	Optional	The value of the total quality points divided by the Credit Hours for Grade Point Average.	Recommended	xs:decimal
TotalQualityPoints	Optional	The total value of quality points used for the calculation of the Grade Point Average.	Recommended	xs:decimal
CreditHoursforGPA	Optional	The total value of credit hours included in the Grade Point Average.	Recommended	xs:decimal
NoteMessage	Optional Repeatable	Additional information about the GPA	Not Recommended	minLength 1 maxLength 80
Comment:				
Comment:				

Code illustration:

```
<GPA>  
  <CreditHoursAttempted>159</CreditHoursAttempted>  
  <CreditHoursEarned>136</CreditHoursEarned>  
  <CreditUnit>Semester</CreditUnit>  
  <GradePointAverage>3.0915</GradePointAverage>  
  <TotalQualityPoints>473</TotalQualityPoints>  
  <CreditHoursforGPA>153</CreditHoursforGPA>  
</GPA>
```

Student.AcademicRecord.AcademicAward.AcademicSummary.AcademicHonors

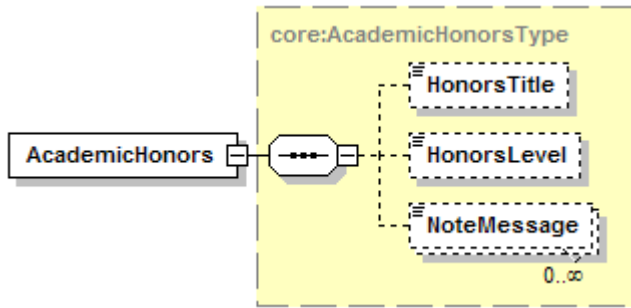

Tag Name	Schema Use	Description	Recommended Use	Format
HonorsTitle	Optional	The descriptive title for the honors received.	Recommended	minLength 1 maxLength 30
HonorsLevel	Optional	A code value representing 1st highest honor, 2nd highest and 3rd highest.	Recommended	Enumeration: FirstHighest SecondHighest ThirdHighest
NoteMessage	Optional Repeatable	Additional information about the Academic Honors	Not Recommended	minLength 1 maxLength 80
Comment:				
Comment:				

Code illustration:

```

<AcademicHonors>
  <HonorsTitle>Cum Laude</HonorsTitle>
  <HonorsLevel>ThirdHighest</HonorsLevel>
</AcademicHonors>
    
```

Student.AcademicRecord.AcademicAward.AcademicSummary.AcademicProgram

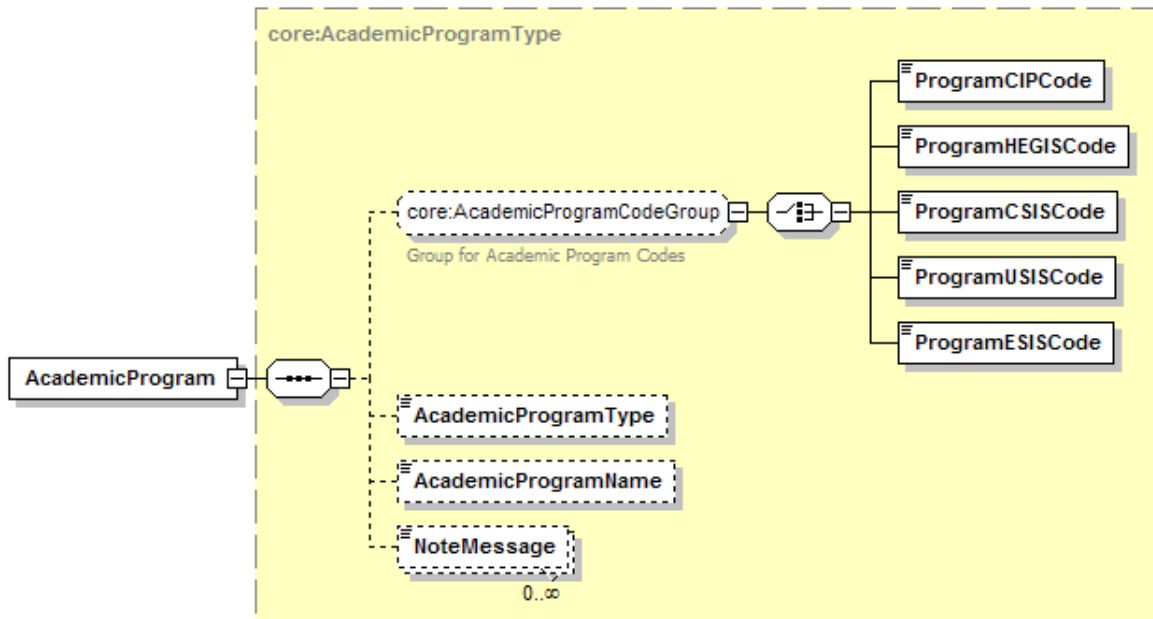

Tag Name	Schema Use	Description	Recommended Use	Format
ProgramCIPCode	Optional exclusive choice	Code indicating a discipline or field of study assigned by the Classification of Instructional Programs	Recommended (use one)	minLength 6 maxLength 20
ProgramHEGISCode	Optional exclusive choice	Code indicating a discipline or field of study assigned by Higher Education General Information Survey	Recommended (use one)	minLength 6 maxLength 20
ProgramCSISCode	Optional exclusive choice	Code indicating a discipline or field of study assigned by Statistics Canada Canadian College Student Information System	Recommended (use one)	minLength 5 maxLength 5
ProgramUSISCode	Optional exclusive choice	Code indicating a discipline or field of study assigned by the Statistics Canada University Student Information System.	Recommended (use one)	minLength 5 maxLength 5
ProgramESISCode	Optional exclusive choice	Code indicating a discipline or field of study assigned by the Statistics Canada Enhanced Student Information System.	Recommended (use one)	minLength 1 maxLength 20
AcademicProgramType	Optional	Indicates whether the academic program is a major, minor, area of concentration or specialization.	Recommended	Enumeration: Concentration Major Minor Specialization
AcademicProgramName	Optional	Literal name of program, major, or field of study.	Recommended	minLength 1 maxLength 60
NoteMessage	Optional Repeatable	Additional information about the Academic Program	Not Recommended	minLength 1 maxLength 80
Comment:				
Comment:				

Code illustration:

```
<AcademicProgram>  
  <ProgramCIPCode>123456</ProgramCIPCode>  
  <AcademicProgramType>Major</AcademicProgramType>  
  <AcademicProgramName>[need text]</AcademicProgramName>  
  <NoteMessage>String</NoteMessage>  
</AcademicProgram>
```

Student.AcademicRecord.AcademicSummary

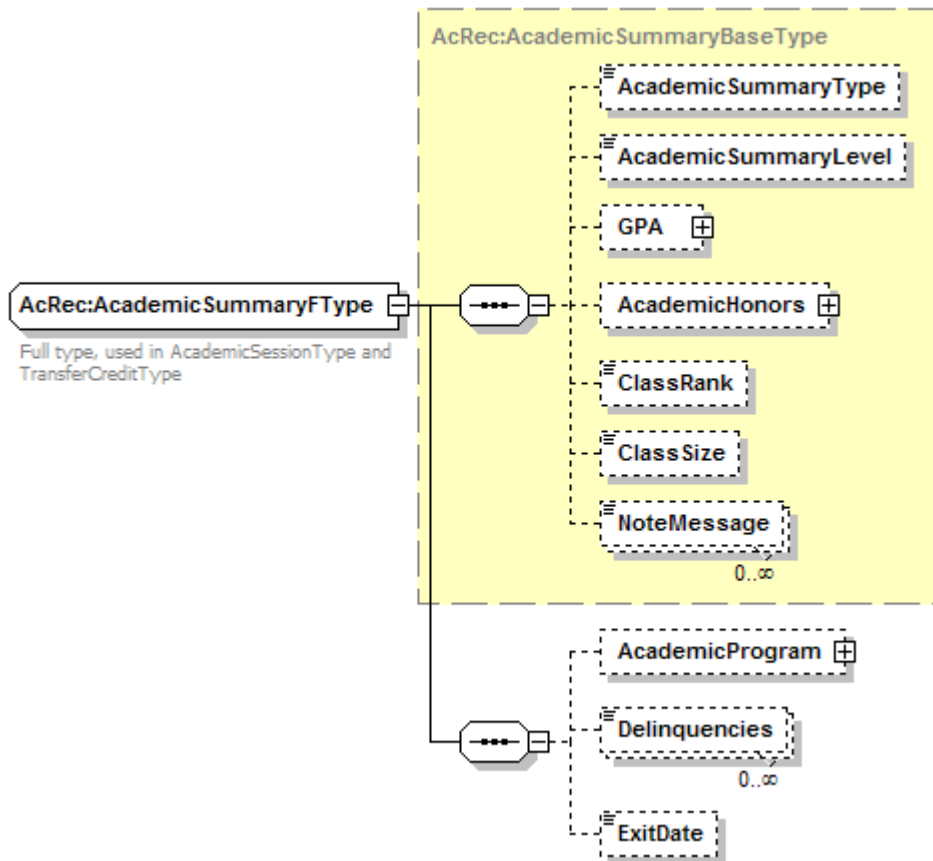

Tag Name	Schema Use	Description	Recommended Use	Format
AcademicSummaryType	Optional	<p>Summary Type is an indication of what is being summarized over what period of time</p> <p>All - Summary of all courses regardless of institution SenderOnly - Summary of all courses at sending institution (or recorded as if they were taken at the TransferOnly - Summary of transfer work (courses taken at other than the sending institution) AllNotRepeated - Summary of all courses except for repeated or forgiven courses/credits SenderNotRepeated - Summary of all courses at sending institution except for repeated or forgiven courses/credits TransferNotRepeated - Summary of transfer work except for repeated or forgiven courses/credits AcademicRenewal - Subset of forgiven courses CarryoverCredit - Summary from offline records and used as the initial point for cumulatives and averages DegreeApplicable - Summary of course that apply to degree</p>	Recommended	<p>Enumeration: All SenderOnly TransferOnly AllNotRepeated SenderNotRepeated TransferNotRepeated AcademicRenewal CarryoverCredit DegreeApplicable NonDegreeApplicable ConvertedFrom ConvertedTo UserDefined</p>

		<p>NonDegreeApplicable - Summary of courses that do not apply toward degree</p> <p>ConvertedFrom - Summary of credits before an institutional term-basis conversion, such as from quarters to semesters</p> <p>ConvertedTo - Summary of credits after an institutional term-basis conversion, such as from quarters to semesters</p> <p>UserDefined - see NoteMessage for explanation</p>		
AcademicSummaryLevel	Optional	The level of credit associated with the credit hours earned for the course.	Recommended	<p>Enumeration:</p> <p>Undergraduate</p> <p>LowerDivision</p> <p>UpperDivision</p> <p>Vocational</p> <p>TechnicalPreparatory</p> <p>Graduate</p> <p>Professional</p> <p>Dual</p> <p>GraduateProfessional</p>
GPA	Optional	GPA for this Academic Summary	Recommended	
AcademicHonors	Optional	Academic Honors for this Academic Summary	Optional	
ClassRank	Optional	The student's class rank relative to other students in their academic cohort (e.g. class).	Not Recommended	<p>minInclusive 1</p> <p>maxInclusive 9999</p> <p>totalDigits 4</p>
ClassSize	Optional	The numeric size of the academic cohort (e.g. class).	Not Recommended	<p>minInclusive 1</p> <p>maxInclusive 9999</p> <p>totalDigits 4</p>
NoteMessage	Optional Repeatable	Additional information about the Academic Summary	Not Recommended	<p>minLength 1</p> <p>maxLength 80</p>
AcademicProgram	Optional	Academic Program (e.g. major) for this Academic Summary	Optional	
	<p>Comment: This is the appropriate place to list the student's current major or degree objective if the award has not yet been granted.</p>			
Delinquencies	Optional Repeatable	<p>The academic standing of the student upon transfer to the institution.</p> <p>GoodStanding - Student was in good standing</p> <p>ProbationGPA - Student was on academic probation (because of low GPA)</p> <p>ProbationHours - Student was on academic probation (deficiency in credit hours)</p> <p>SuspensionGPA - Student was on academic suspension (because of low GPA)</p> <p>SuspensionHours - Student was on academic suspension (deficiency in credit hours)</p> <p>ProbationDiscipline - Student was on disciplinary probation</p> <p>SuspensionDiscipline - Student was on disciplinary suspension</p> <p>Unknown</p> <p>Other</p>	Not Recommended	<p>Enumeration:</p> <p>GoodStanding</p> <p>ProbationGPA</p> <p>ProbationHours</p> <p>SuspensionGPA</p> <p>SuspensionHours</p> <p>ProbationDiscipline</p> <p>SuspensionDiscipline</p> <p>Unknown</p> <p>Other</p>

	Comment: <i>It is recommended that probation not be included on the transcript and that other Delinquencies be included at the Session level.</i>		
ExitDate	Optional	The date on which the student officially withdrew or graduated	Not Recommended
	Comment:		
Comment:			

Code illustration:

```

<AcademicSummary>
  <AcademicSummaryType>All</AcademicSummaryType>
  <AcademicSummaryLevel>Undergraduate</AcademicSummaryLevel>
  <GPA>
*
*
    </GPA>
    <AcademicHonors>
*
*
      </AcademicHonors>
      <ClassRank>43</ClassRank>
      <ClassSize>849</ClassSize>
      <AcademicProgram>
*
*
        </AcademicProgram>
        <Delinquencies>GoodStanding</Delinquencies>
        <ExitDate>2003-05-13</ExitDate>
</AcademicSummary>

```

Student.AcademicRecord.AcademicSummary.GPA

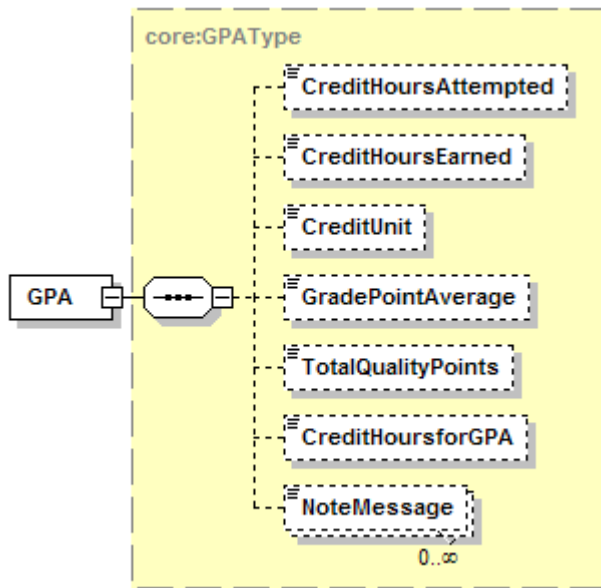

Tag Name	Schema Use	Description	Recommended Use	Format
CreditHoursAttempted	Optional	The total value of credit hours attempted whether or not included in the hours for GPA or hours earned	Recommended	xs:decimal
CreditHoursEarned	Optional	The total value of credit hours successfully completed or earned	Recommended	xs:decimal
CreditUnit	Optional	The type of credit (unit, semester, or quarter) associated with the credit hours earned for the course	Recommended	Enumeration: NoCredit Quarter Semester Units ClockHours CarnegieUnits ContinuingEducationUnits Unreported Other
GradePointAverage	Optional	The value of the total quality points divided by the Credit Hours for Grade Point Average	Recommended	xs:decimal
TotalQualityPoints	Optional	The total value of quality points used for the calculation of the Grade Point Average	Recommended	xs:decimal
CreditHoursforGPA	Optional	The total value of credit hours included in the Grade Point Average	Recommended	xs:decimal
NoteMessage	Optional Repeatable	Additional information about the GPA	Not Recommended	minLength 1 maxLength 80
Comment:				
Comment:				

Code illustration:

```
<GPA>  
  <CreditHoursAttempted>159</CreditHoursAttempted>  
  <CreditHoursEarned>136</CreditHoursEarned>  
  <CreditUnit>Semester</CreditUnit>  
  <GradePointAverage>3.0915</GradePointAverage>  
  <TotalQualityPoints>473</TotalQualityPoints>  
  <CreditHoursforGPA>153</CreditHoursforGPA>  
</GPA>
```

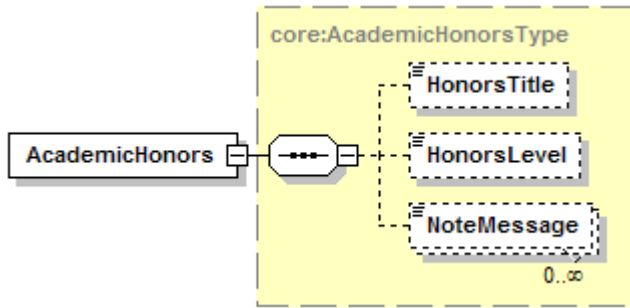
Student.AcademicRecord.AcademicSummary.AcademicHonors

Tag Name	Schema Use	Description	Recommended Use	Format
HonorsTitle	Optional	The descriptive title for the honors received	Recommended	minLength 1 maxLength 30
HonorsLevel	Optional	A code value representing 1st highest honor, 2nd highest and 3rd highest	Recommended	Enumeration: FirstHighest SecondHighest ThirdHighest
NoteMessage	Optional Repeatable	Additional information about the Academic Honors	Not Recommended	minLength 1 maxLength 80
	Comment:			
	Comment:			

Code illustration:

```

<AcademicHonors>
  <HonorsTitle>Cum Laude</HonorsTitle>
  <HonorsLevel>ThirdHighest</HonorsLevel>
</AcademicHonors>
  
```

Student.AcademicRecord.AcademicSummary.AcademicProgram

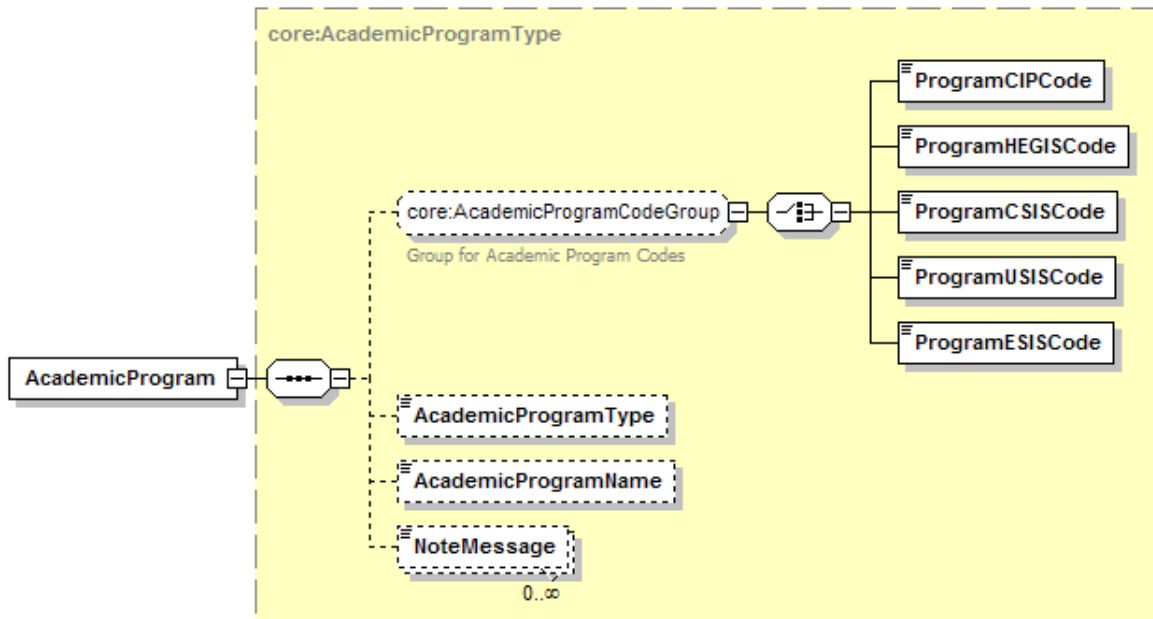

Tag Name	Schema Use	Description	Recommended Use	Format
ProgramCIPCode	Optional exclusive choice	Code indicating a discipline or field of study assigned by the Classification of Instructional Programs	Recommended (use one)	minLength 6 maxLength 20
ProgramHEGISCode	Optional exclusive choice	Code indicating a discipline or field of study assigned by Higher Education General Information Survey	Recommended (use one)	minLength 6 maxLength 20
ProgramCSISCode	Optional exclusive choice	Code indicating a discipline or field of study assigned by Statistics Canada Canadian College Student Information System	Recommended (use one)	minLength 5 maxLength 5
ProgramUSISCode	Optional exclusive choice	Code indicating a discipline or field of study assigned by the Statistics Canada University Student Information System.	Recommended (use one)	minLength 5 maxLength 5
ProgramESISCode	Optional exclusive choice	Code indicating a discipline or field of study assigned by the Statistics Canada Enhanced Student Information System.	Recommended (use one)	minLength 1 maxLength 20
AcademicProgramType	Optional	Indicates whether the academic program is a major, minor, area of concentration or specialization.	Recommended	Enumeration: Concentration Major Minor Specialization
AcademicProgramName	Optional	Literal name of program, major, or field of study.	Recommended	minLength 1 maxLength 60
NoteMessage	Optional Repeatable	Additional information about the Academic Program	Not Recommended	minLength 1 maxLength 80
Comment:				
Comment:				

Code illustration:

```
<AcademicProgram>  
  <ProgramCIPCode>123456</ProgramCIPCode>  
  <AcademicProgramType>Major</AcademicProgramType>  
  <AcademicProgramName>[need text]</AcademicProgramName>  
  <NoteMessage>String</NoteMessage>  
</AcademicProgram>
```

Student.AcademicRecord.AcademicSession

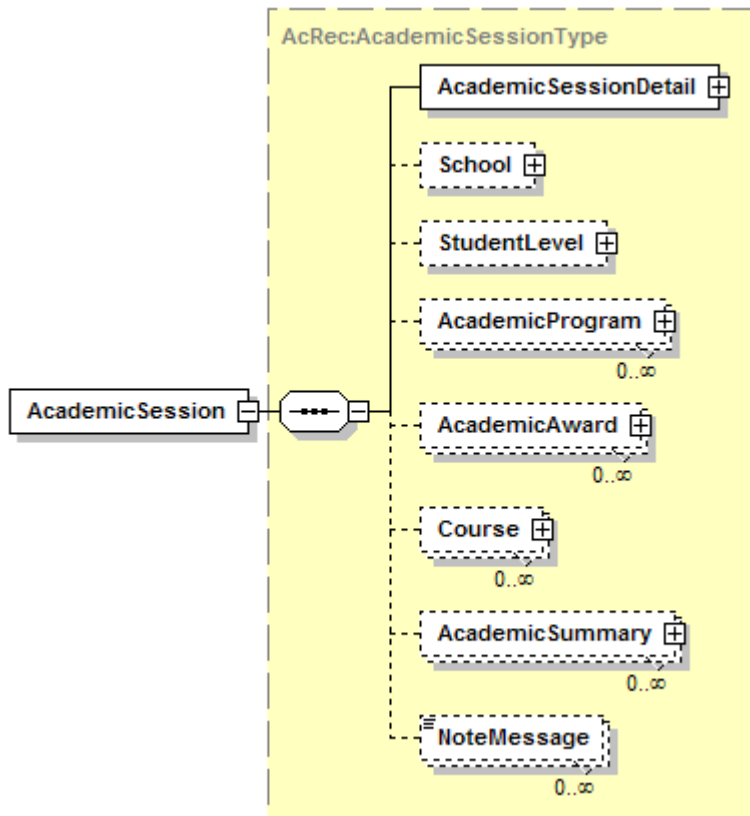

Tag Name	Schema Use	Description	Recommended Use	Format
AcademicSessionDetail	Required	Information identifying the time period of the beginning of this session	Required	
School	Optional	Override School	Conditional	
	Comment: Recommended when the school for this AcademicSession differs from the Sending institution. Not Recommended when this AcademicSession belongs to the Sending institution.			
StudentLevel	Optional	An indication of the classification of the student at the time of this Academic Session	Optional	
AcademicProgram	Optional Repeatable	The major or degree objectives for the student at the time of this session	Optional	
AcademicAward	Optional Repeatable	Academic awards associated with this session	Recommended	
	Comment: Degree award information should be placed here when it is associated with an academic session, or in AcademicRecord.AcademicAward when not associated with an academic session.			
Course	Optional Repeatable	Courses associated with this session	Recommended	
AcademicSummary	Optional Repeatable	Academic summary for this session	Optional	
NoteMessage	Optional Repeatable	Additional information about the academic session	Not Recommended	minLength 1 maxLength 80

	Comment:
Comment:	

Code illustration:

```

    <AcademicSession>
      <AcademicSessionDetail>
*
*
        </AcademicSessionDetail>
        <School>
*
*
          </School>
          <StudentLevel>
*
*
            </StudentLevel>
            <AcademicProgram>
*
*
              </AcademicProgram>
              <AcademicAward>
*
*
                </AcademicAward>
                <Course>
*
*
                  </Course>
                  <Course>
*
*
                    </Course> [repeat as needed]
                    <AcademicSummary>
*
*
                      </AcademicSummary>
    </AcademicSession>

```

Student.AcademicRecord.AcademicSession.AcademicSessionDetail

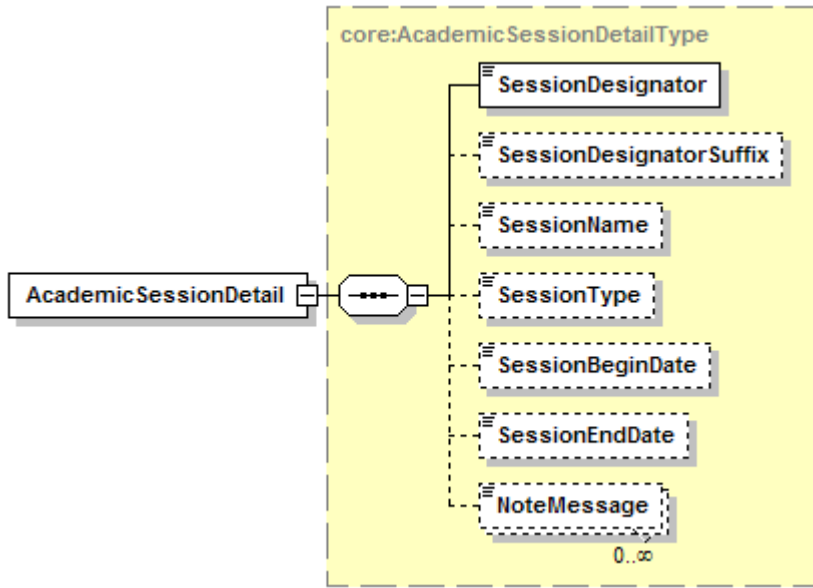

Tag Name	Schema Use	Description	Recommended Use	Format
SessionDesignator	Required	The academic session for which the data are recorded and applicable.	Required	YearMonth (ccyy-mm)
		<p>Comment: The Session Designator is used to indicate the starting year and month of major academic terms within the sending school's calendar. For example, a typical fall term would begin in August or September. So, for a fall term that began in August of the year 2002, the value of this field would be 2002-08. All classes that began in this month and year would normally be included within this session designator, regardless of the ending dates of the classes within this session. Therefore, all classes with this same session designator would be included in the academic summary for this session.</p>		
SessionDesignatorSuffix	Optional	A free form extension to the session ID to differentiate discreet sub-sessions within the same session	Optional	minLength 1 maxLength 10
		<p>Comment: If you have a mini term or short term within the major term, you can use this field to identify those classes. They could be identified with different beginning or ending dates, but they would still be a part of the major session designator.</p>		
SessionName	Optional	Free-form name of session.	Recommended	minLength 1 maxLength 30
		<p>Comment: For example, Fall Semester 2002 or Fall Semester 2003 or Fall Semester 2002-2003 for the example in the comments above.</p>		
SessionType	Optional	Indicates the type of academic session at an educational institution.	Recommended	<p>Enumeration: FullYear Semester Trimester Quarter Quinmester MiniTerm SummerSession Intersession LongSession FallSession FourOneFourPlan Continuous DiffersByProgram Other TwelveMonth</p>

	Comment: This is the type of calendar used by the sending school. It does not refer to the type of units of credit awarded.			
SessionBeginDate	Optional	Actual calendar date when session begins.	Optional	xs:date
SessionEndDate	Optional	Actual calendar date when session ends.	Optional	xs:date
NoteMessage	Optional Repeatable	Additional information about the Academic Session	Not Recommended	minLength 1 maxLength 80
	Comment:			
	Comment:			

Code illustration:

```

<AcademicSessionDetail>
  <SessionDesignator>1985-09</SessionDesignator>
  <SessionDesignatorSuffix>1</SessionDesignatorSuffix>
  <SessionName>FALL SEMESTER 1985</SessionName>
  <SessionType>Semester</SessionType>
  <SessionBeginDate/>
  <SessionEndDate/>
</AcademicSessionDetail>

```

Student.AcademicRecord. AcademicSession.School

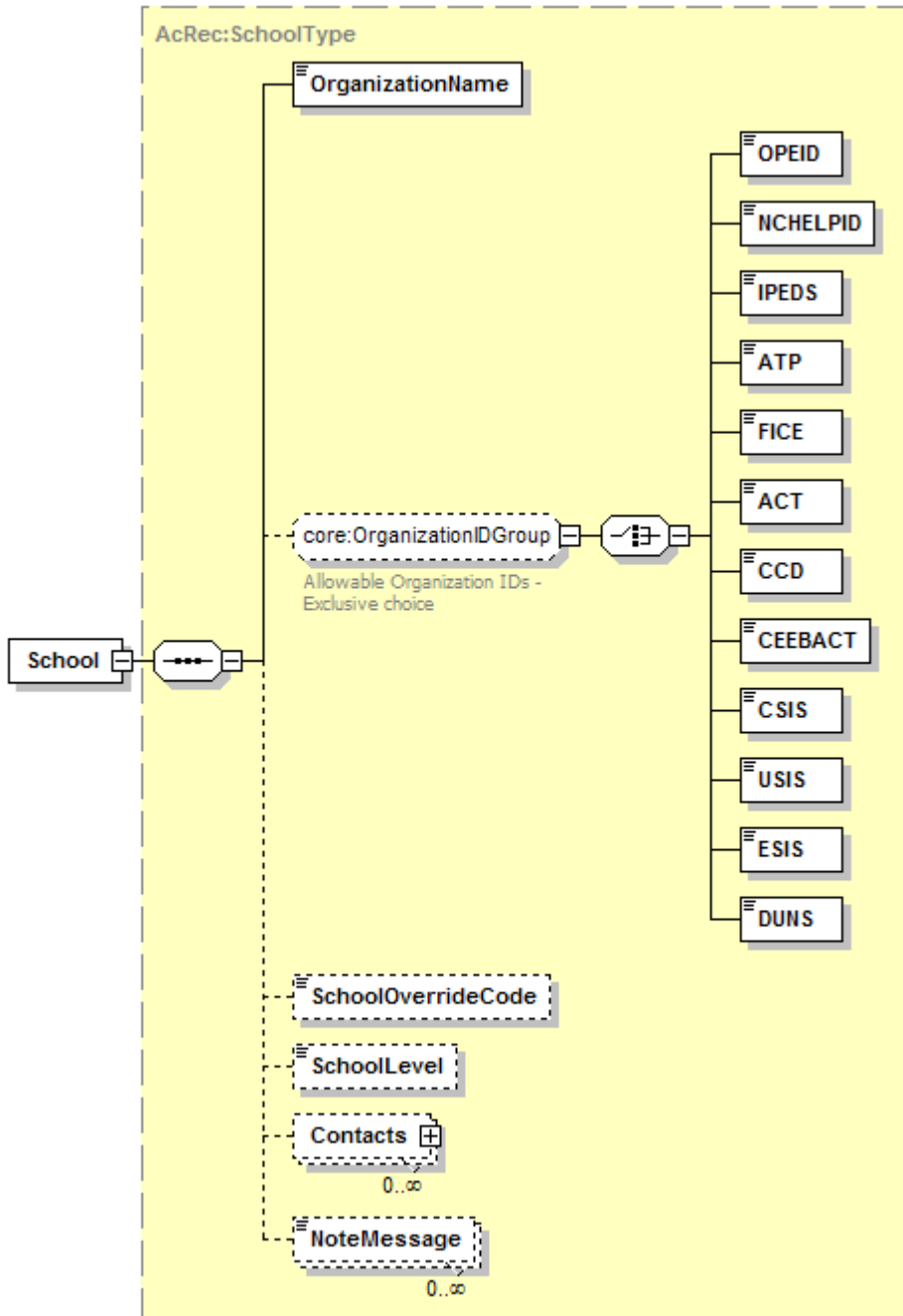

Tag Name	Schema Use	Description	Recommended Use	Format
OrganizationName	Required	Name of Override School	Required	minLength 1 maxLength 60
OPEID	Required choice	The unique identifier assigned by the Office of Postsecondary Education for each data exchange partner.	Recommended (use one)	minLength 3 maxLength 8

NHELPIID	Required choice	The unique identifier assigned by National Council on Higher Education Loan Programs for each data exchange partner.	Recommended (use one)	minLength 3 maxLength 8
IPEDS	Required choice	The unique identifier assigned by the National Center for Education Statistics for the Integrated Postsecondary Education Data System for each postsecondary data exchange partner.	Recommended (use one)	minLength 6 maxLength 6
ATP	Required choice	The unique identifier assigned for the Admissions Testing Program by the College Board for each postsecondary data exchange partner.	Recommended (use one)	minLength 6 maxLength 6
FICE	Required choice	The unique identifier assigned for the Federal Interagency Committee on Education by the US Department of Education's National Center for Education Statistics for each postsecondary data exchange partner	Recommended (use one)	minLength 6 maxLength 6
ACT	Required choice	The unique identifier assigned by the American College Testing or ACT for each postsecondary data exchange partner. See www.act.org .	Recommended (use one)	minLength 4 maxLength 4
CCD	Required choice	The unique identifier assigned by the US Department of Education's National Center for Education Statistics as the Common Core of Data for each K12 data exchange partner.	Recommended (use one)	minLength 12 maxLength 12
CEEBACT	Required choice	The unique identifier assigned by the College Entrance Examining Board and ACT for each data exchange partner.	Recommended (use one)	minLength 6 maxLength 6
CSIS	Required choice	The unique identifier assigned by the Statistics Canada Canadian College Student Information System for each data exchange partner	Recommended (use one)	minLength 6 maxLength 6
USIS	Required choice	The unique identifier assigned by the Statistics Canada University Student Information System for each data exchange partner	Recommended (use one)	minLength 6 maxLength 6
ESIS	Required choice	The unique identifier assigned by the Statistics Canada Enhanced Student Information System for each data exchange partner.	Recommended (use one)	minLength 8 maxLength 8
DUNS	Required choice	Data Universal Numbering System (DUNS), unique nine character company identification number issued by Dun and Bradstreet Corporation.	Recommended (use one)	minLength 9 maxLength 9

SchoolOverrideCode	Optional	The source of the academic credit if not awarded by the home or parent institution. Institutional - Institutional Agreement Multicampus - Multiple Campus Course Offering Transfer - Transfer Credit StudyAbroad - Study Abroad Coop - Cooperative Program Reciprocal - Reciprocal Exchange Internship - Internship	Recommended	Enumeration: Institutional Multicampus Transfer StudyAbroad Coop Reciprocal Internship
SchoolLevel	Optional	Indicates level of Override School	Recommended	Enumeration: Elementary Secondary Postsecondary
Contacts	Optional Repeatable	Contact info at Override School	Optional	
NoteMessage	Optional Repeatable	Additional information about the Override School	Not Recommended	minLength 1 maxLength 80

Comment:

Comment:

Code illustration:

```

<School>
  <OrganizationName>TEXAS A&M UNIVERSITY COLLEGE STATION</OrganizationName>
  <ATP>006003</ATP>
  <SchoolOverrideCode>Transfer</SchoolOverrideCode>
  <SchoolLevel>Postsecondary</SchoolLevel>
  <Contacts>
*
*
  </Contacts>
</School>
    
```

Student.AcademicRecord. AcademicSession.School.Contacts

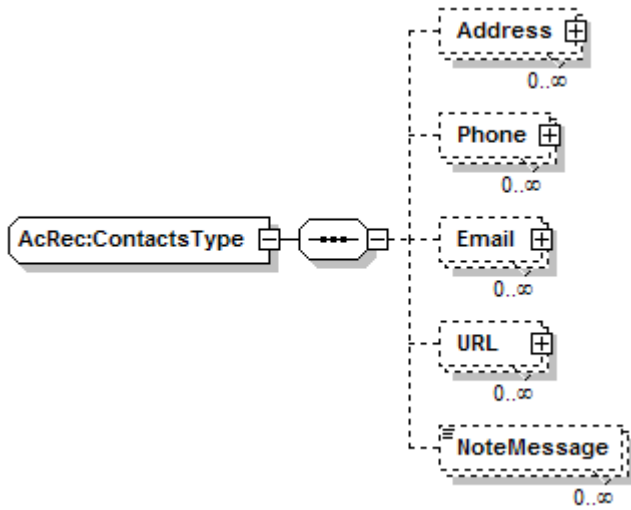

Tag Name	Schema Use	Description	Recommended Use	Format
Address	Optional Repeatable	Address of the Override School	Recommended	minOcc 0 maxOcc ∞
Phone	Optional Repeatable	Phone Number of the Override School	Optional	minOcc 0 maxOcc ∞
Email	Optional Repeatable	Email Address of the Override School	Optional	minOcc 0 maxOcc ∞
URL	Optional Repeatable	Universal Resouce Locator of the Override School	Optional	minOcc 0 maxOcc ∞
NoteMessage	Optional Repeatable	Additional information about the contacts at the Override School	Not Recommended	minLength 1 maxLength 80
Comment:				
Comment:				

Code illustration:

```

<Contacts>
  <Address>
*
*
  </Address>
  <Phone>
*
*
  </Phone>
  <Email>
*
  </Email>
  <URL>
*
  </URL>
  <NoteMessage/>
</Contacts>
    
```

Student.AcademicRecord. AcademicSession.School.Contacts.Address

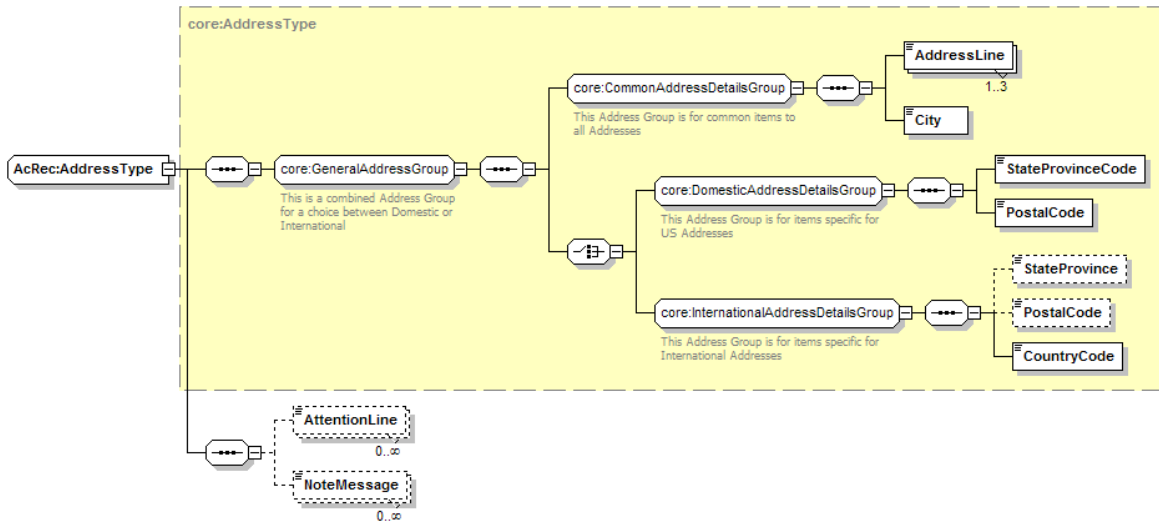

Tag Name	Schema Use	Description	Recommended Use	Format
CommonAddressDetailsGroup	Required	This Address Group is for items common to all Addresses	Required	minOcc 1 maxOcc 1
	Comment: [CommonAddressDetailsGroup] is not a tag and does not appear in the instance document. If the address of a contact is included in the transcript, then this must be sent. It is required and must be paired with one of either DomesticAddressDetailsGroup or InternationalAddressDetailsGroup.			
DomesticAddressDetailsGroup	Required choice	This Address Group is for items specific for US and Canadian Addresses	Required for domestic addresses	minOcc 1 maxOcc 1
	Comment: [DomesticAddressDetailsGroup] is not a tag and does not appear in the instance document. If the address has a United States or Canadian Postal Code and a US State or Canadian Province Code, then this should be the required choice.			
InternationalAddressDetailsGroup	Required choice	This Address Group is for items specific for International Addresses	Required for international addresses	minOcc 1 maxOcc 1
	Comment: [InternationalAddressDetailsGroup] is not a tag and does not appear in the instance document. This choice is for addresses that do not have a US or Canadian postal code.			
AttentionLine	Optional	The individual or office name within the postal address where inquiries should be directed.	Optional	minOcc 0 maxOcc ∞ minLength 1 maxLength 45
NoteMessage	Optional Repeatable	Additional information about the address	Not Recommended	minOcc 0 maxOcc ∞
	Comment:			
	Comment:			

Code illustration:

```
<Address>  
  <AddressLine>Office of the Registrar</AddressLine>  
  <AddressLine>1 University Station</AddressLine>  
  <City>Austin</City>  
  <StateProvinceCode>TX</StateProvinceCode>  
  <PostalCode>78712</PostalCode>  
  <AttentionLine>Jane Shaugness</AttentionLine>  
  <NoteMessage/>  
</Address>
```

Student.AcademicRecord.AcademicSession.School.Contacts.Address.CommonAddressDetailsGroup

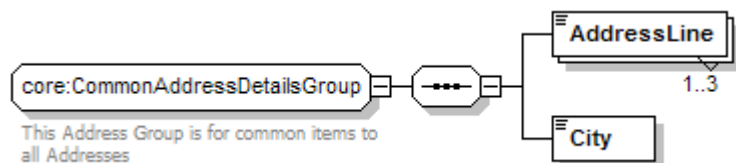

Tag Name	Schema Use	Description	Recommended Use	Format
AddressLine	Required Repeatable	Local delivery information such as street, building number, PO box, or apartment portion of a postal address.	Required	minOcc 1 maxOcc 3 minLength 1 maxLength 40
City	Required	The city portion of the Address.	Required	minOcc 1 maxOcc 1 minLength 2 maxLength 30
	Comment:			
	Comment:			

Code illustration:

```
<AddressLine>University of Oxford</AddressLine>
<AddressLine>Wellington Square</AddressLine>
<City>Oxford</City>
```

Student.AcademicRecord.AcademicSession.School.Contacts.Address.DomesticAddressDetailsGroup

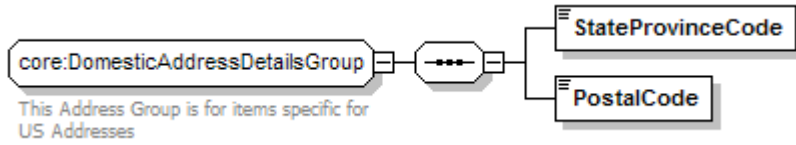

Tag Name	Schema Use	Description	Recommended Use	Format
StateProvinceCode	Required	Code for US states, etc., and Canadian provinces.	Required	See Appendix A
PostalCode	Required	The postal code portion of the Address.	Required	minLength 1 maxLength 17
Comment:				
Comment:				

Code illustration:

```
<StateProvinceCode>TX</StateProvinceCode>
<PostalCode>78712</PostalCode>
```

Student.AcademicRecord.AcademicSession.School.Contacts.Address.InternationalAddressDetails Group

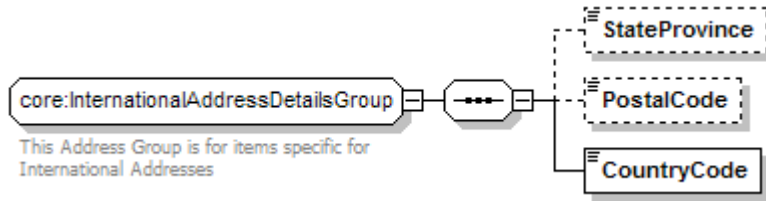

Tag Name	Schema Use	Description	Recommended Use	Format
StateProvince	Optional	The literal name of the state, province or territory of a postal address. Use for addresses outside US or Canada.	Optional	minLength 2 maxLength 30
	Comment: For an internet resource of states or other geographical subdivisions in countries other than the US and Canada, you might choose to refer to the website of the Universal Postal Union at http://www.upu.int			
PostalCode	Optional	The postal code portion of the Address.	Optional	minLength 1
	Comment: For an internet resource of states or other geographical subdivisions in countries other than the US and Canada, you might choose to refer to the website of the Universal Postal Union at http://www.upu.int			
CountryCode	Required	Code indicating Country. Use ISO 3166-1 alpha-2 standard.	Required	See Appendix B
	Comment:			
	Comment:			

Code illustration:

```
<PostalCode>0X1 2JD</PostalCode>
<CountryCode>GB</CountryCode>
```

Student.AcademicRecord.AcademicSession.School.Contacts.Phone

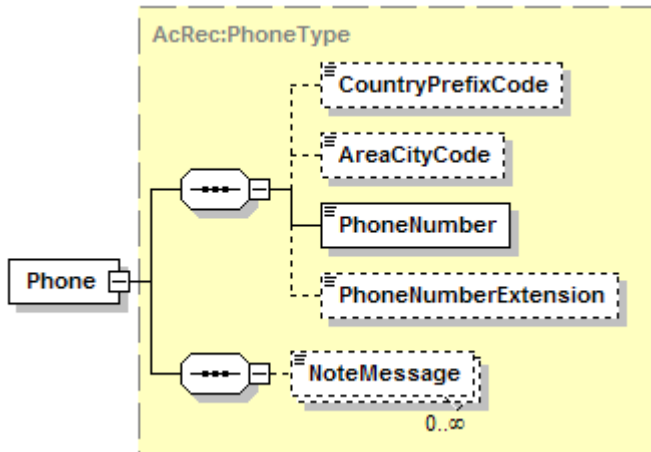

Tag Name	Schema Use	Description	Recommended Use	Format
CountryPrefixCode	Optional	International dialing code.	Optional	minLength 1 maxLength 3
AreaCityCode	Optional	Regional dialing code.	Recommended	minLength 1 maxLength 5
PhoneNumber	Required	Telephone number.	Required	minLength 1 maxLength 11
PhoneNumberExtension	Optional	The extended telephone addressing information used in addition to phone number such as a PBX extension, a pager PIN, or FAX sub-address.	Optional	minLength 1 maxLength 5
NoteMessage	Optional Repeatable	Additional information about the phone number	Not recommended	minOcc 0 maxOcc ∞
Comment:				
Comment:				

Code illustration:

```

<Phone>
  <CountryPrefixCode/>
  <AreaCityCode>512</AreaCityCode>
  <PhoneNumber>4757638</PhoneNumber>
  <PhoneNumberExtension/>
  <NoteMessage/>
</Phone>
    
```

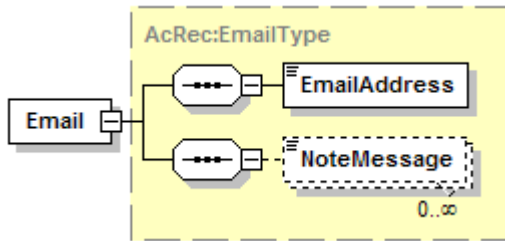
Student.AcademicRecord.AcademicSession.School.Contacts.Email

Tag Name	Schema Use	Description	Recommended Use	Format
EmailAddress	Required	The numbers, letters, and symbols used to identify an electronic mail (Email) user within a network.	Required	minLength 1 maxLength 128
NoteMessage	Optional Repeatable	Additional information about the email address	Not recommended	minOcc 0 maxOcc ∞
Comment:				
Comment:				

Code illustration:

```

<Email>
  <EmailAddress/>
  <NoteMessage/>
</Email>

```

Student.AcademicRecord.AcademicSession.School.Contacts.URL

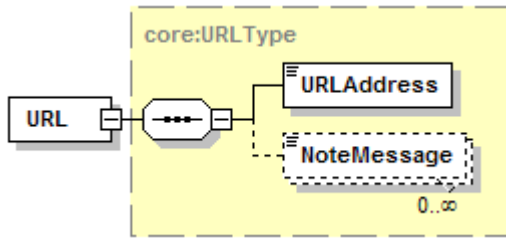

Tag Name	Schema Use	Description	Recommended Use	Format
URLAddress	Required	The Uniform Resource Locator (URL) address associated with a product, deliverable or contact.	Required	minLength 0 maxLength 512
NoteMessage	Optional Repeatable	Additional information about the URL	Not Recommended	minLength 1 maxLength 80
	Comment:			
	Comment:			

Code illustration:

```

<URL>
  <URLAddress/>
  <NoteMessage/>
</URL>
    
```

Student.AcademicRecord.AcademicSession.StudentLevel

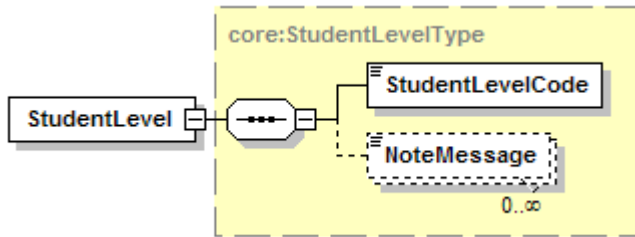

Tag Name	Schema Use	Description	Recommended Use	Format
StudentLevelCode	Required	The student's grade level or academic classification.	Required	Enumeration: NinthGrade TenthGrade EleventhGrade TwelfthGrade PostsecondaryBachelorPre NonDegree CollegeFirstYear CollegeFirstYearAttendedB CollegeSophomore CollegeJunior CollegeSenior CollegeFifthYear PostBaccalaureate GraduateNonDegree GraduateFirstYear GraduateSecondYear GraduateThirdYear GraduateBeyondThirdYear Professional ProfessionalFirstYear ProfessionalSecondYear ProfessionalThirdYear ProfessionalBeyondThirdYe MastersQualifying Masters Doctoral Postdoctoral
NoteMessage	Optional Repeatable	Additional information about the student level	Not Recommended	minLength 1 maxLength 80
Comment:				
Comment:				

Code illustration:

```

<StudentLevel>
  <StudentLevelCode>CollegeFirstYear</StudentLevelCode>
</StudentLevel>
    
```

Student.AcademicRecord.AcademicSession.AcademicProgram

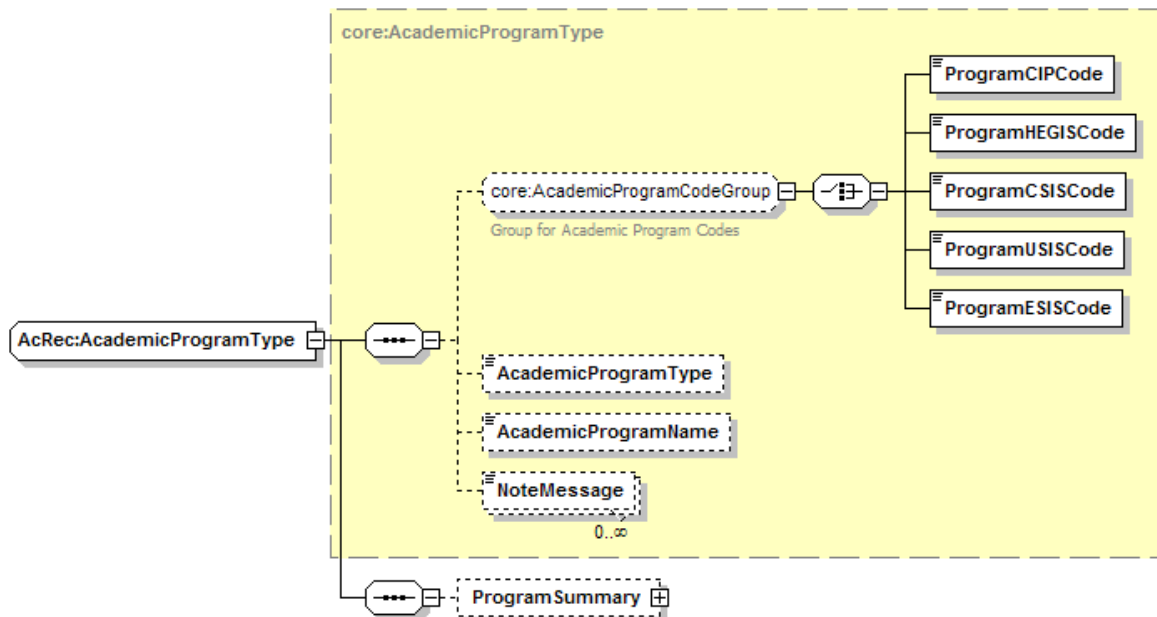

Tag Name	Schema Use	Description	Recommended Use	Format
ProgramCIPCode	Optional exclusive choice	Code indicating a discipline or field of study assigned by the Classification of Instructional Programs	Recommended (use one)	minLength 6 maxLength 20
ProgramHEGISCode	Optional exclusive choice	Code indicating a discipline or field of study assigned by Higher Education General Information Survey	Recommended (use one)	minLength 6 maxLength 20
ProgramCSISCode	Optional exclusive choice	Code indicating a discipline or field of study assigned by Statistics Canada Canadian College Student Information System	Recommended (use one)	minLength 5 maxLength 5
ProgramUSISCode	Optional exclusive choice	Code indicating a discipline or field of study assigned by the Statistics Canada University Student Information System.	Recommended (use one)	minLength 5 maxLength 5
ProgramESISCode	Optional exclusive choice	Code indicating a discipline or field of study assigned by the Statistics Canada Enhanced Student Information System.	Recommended (use one)	minLength 1 maxLength 20
AcademicProgramType	Optional	Indicates whether the academic program is a major, minor, area of concentration or specialization.	Recommended	Enumeration: Concentration Major Minor Specialization
AcademicProgramName	Optional	Literal name of program, major, or field of study.	Recommended	minLength 1 maxLength 60
NoteMessage	Optional Repeatable	Additional information about the academic program	Not Recommended	minLength 1 maxLength 80
ProgramSummary	Optional	Summary information about the Academic Program	Optional	
Comment:				

Comment:

Code illustration:

```
<AcademicProgram>
  <ProgramCIPCode>123456</ProgramCIPCode>
  <AcademicProgramType>Major</AcademicProgramType>
  <AcademicProgramName>[need text]</AcademicProgramName>
  <NoteMessage>String</NoteMessage>
  <ProgramSummary>
*
*
    </ProgramSummary>
</AcademicProgram>
```

Student.AcademicRecord.AcademicSession.AcademicProgram.ProgramSummary

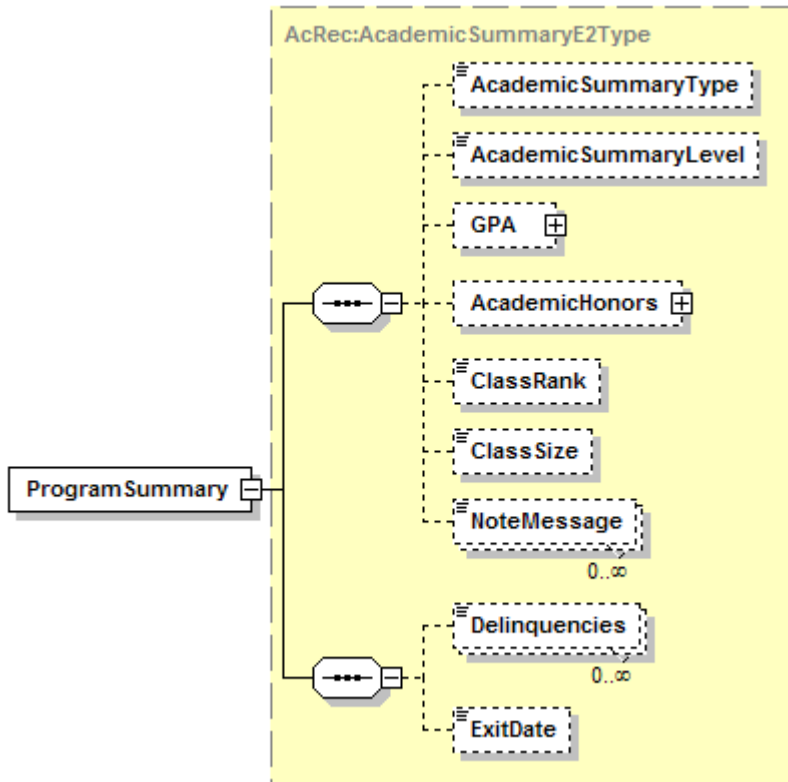

Tag Name	Schema Use	Description	Recommended Use	Format
AcademicSummaryType	Optional	<p>Summary Type is an indication of what is being summarized over what period of time</p> <p>All - Summary of all courses regardless of institution SenderOnly - Summary of all courses at sending institution (or recorded as if they were taken at the TransferOnly - Summary of transfer work (courses taken at other than the sending institution) AllNotRepeated - Summary of all courses except for repeated or forgiven courses/credits SenderNotRepeated - Summary of all courses at sending institution except for repeated or forgiven courses/credits TransferNotRepeated - Summary of transfer work except for repeated or forgiven courses/credits AcademicRenewal - Subset of forgiven courses CarryoverCredit - Summary from offline records and used as the initial point for cumulatives and averages DegreeApplicable - Summary of course that apply to degree NonDegreeApplicable - Summary of courses that do not apply toward degree</p>	Recommended	<p>Enumeration: All SenderOnly TransferOnly AllNotRepeated SenderNotRepeated TransferNotRepeated AcademicRenewal CarryoverCredit DegreeApplicable NonDegreeApplicable ConvertedFrom ConvertedTo UserDefined</p>

		<p>ConvertedFrom - Summary of credits before an institutional term-basis conversion, such as from quarters to semesters</p> <p>ConvertedTo - Summary of credits after an institutional term-basis conversion, such as from quarters to semesters</p> <p>UserDefined - see NoteMessage for explanation</p>		
AcademicSummaryLevel	Optional	<p>The level of credit associated with the credit hours earned for the course.</p> <p>Undergraduate - Undergraduate</p> <p>LowerDivision - Lower division credit (associated with first/second year)</p> <p>UpperDivision - Higher or upper division credit (associated with third or fourth year)</p> <p>Vocational - Vocational/technical credit</p> <p>TechnicalPreparatory - Tech Prep credit</p> <p>Graduate - Graduate level credit</p> <p>Professional - Professional</p> <p>Dual - Dual level (upper division and graduate- may be applicable to a bachelor's degree or graduate degree or both)</p> <p>GraduateProfessional - Dual level (graduate and professional- may be applicable to both)</p>	Recommended	<p>Enumeration:</p> <p>Undergraduate</p> <p>LowerDivision</p> <p>UpperDivision</p> <p>Vocational</p> <p>TechnicalPreparatory</p> <p>Graduate</p> <p>Professional</p> <p>Dual</p> <p>GraduateProfessional</p>
GPA	Optional	GPA for the Award Program	Recommended	
AcademicHonors	Optional	Honors for the Award Program	Recommended	
ClassRank	Optional	The student's class rank relative to other students in their academic cohort (e.g. class).	Not Recommended	<p>minInclusive 1</p> <p>maxInclusive 9999</p> <p>totalDigits 4</p>
ClassSize	Optional	The numeric size of the academic cohort (e.g. class).	Not Recommended	<p>minInclusive 1</p> <p>maxInclusive 9999</p> <p>totalDigits 4</p>
NoteMessage	Optional Repeatable	Additional information about the Program Summary	Not Recommended	<p>minLength 1</p> <p>maxLength 80</p>
Delinquencies	Optional Repeatable	<p>The academic standing of the student upon transfer to the institution.</p> <p>GoodStanding - Student was in good standing</p> <p>ProbationGPA - Student was on academic probation (because of low GPA)</p> <p>ProbationHours - Student was on academic probation (deficiency in credit hours)</p> <p>SuspensionGPA - Student was on academic suspension (because of low GPA)</p> <p>SuspensionHours - Student was on academic suspension (deficiency in credit hours)</p> <p>ProbationDiscipline - Student was on disciplinary probation</p> <p>SuspensionDiscipline - Student was on disciplinary suspension</p> <p>Unknown</p> <p>Other</p>	Not Recommended	<p>Enumeration:</p> <p>GoodStanding</p> <p>ProbationGPA</p> <p>ProbationHours</p> <p>SuspensionGPA</p> <p>SuspensionHours</p> <p>ProbationDiscipline</p> <p>SuspensionDiscipline</p> <p>Unknown</p> <p>Other</p>

ExitDate	Optional	The date on which the student officially withdrew or graduated.	Not Recommended	xs:date
	Comment:			
Comment:				

Code illustration:

```

<ProgramSummary>
  <AcademicSummaryType>All</AcademicSummaryType>
  <AcademicSummaryLevel>Undergraduate</AcademicSummaryLevel>
  <GPA>
*
*
  </GPA>
  <AcademicHonors>
*
*
  </AcademicHonors>
  <ClassRank/>
  <ClassSize/>
  <NoteMessage/>
  <Delinquencies/>
  <ExitDate/>
</ProgramSummary>

```

Student.AcademicRecord.AcademicSession.AcademicProgram.ProgramSummary.GPA

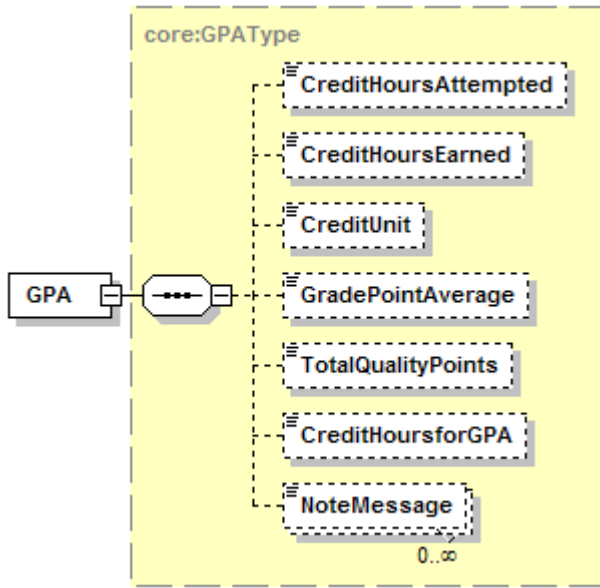

Tag Name	Schema Use	Description	Recommended Use	Format
CreditHoursAttempted	Optional	The total value of credit hours attempted whether or not included in the hours for GPA or hours earned.	Recommended	
CreditHoursEarned	Optional	The total value of credit hours successfully completed or earned.	Recommended	
CreditUnit	Optional	The type of credit (unit, semester, or quarter) associated with the credit hours earned for the course.	Recommended	Enumeration: NoCredit Quarter Semester Units ClockHours CarnegieUnits ContinuingEducationUnits Unreported Other
GradePointAverage	Optional	The value of the total quality points divided by the Credit Hours for Grade Point Average.	Recommended	xs:decimal
TotalQualityPoints	Optional	The total value of quality points used for the calculation of the Grade Point Average.	Recommended	xs:decimal
CreditHoursforGPA	Optional	The total value of credit hours included in the Grade Point Average.	Recommended	xs:decimal
NoteMessage	Optional Repeatable	Additional information about the GPA	Not Recommended	minLength 1 maxLength 80
Comment:				
Comment:				

Code illustration:

```
<GPA>  
  <CreditHoursAttempted>12</CreditHoursAttempted>  
  <CreditHoursEarned>12</CreditHoursEarned>  
  <CreditUnit>Semester</CreditUnit>  
  <GradePointAverage>3.75</GradePointAverage>  
  <TotalQualityPoints>45</TotalQualityPoints>  
  <CreditHoursforGPA>12</CreditHoursforGPA>  
</GPA>
```

Student.AcademicRecord.AcademicSession.AcademicProgram.ProgramSummary.AcademicHono
RS

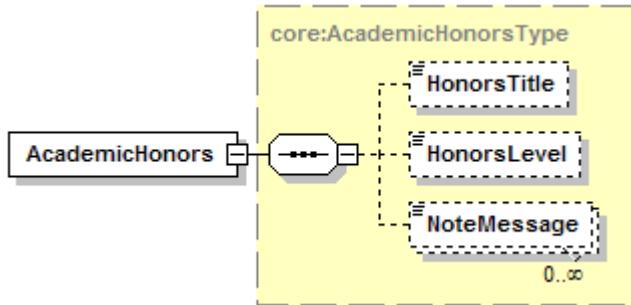

Tag Name	Schema Use	Description	Recommended Use	Format
HonorsTitle	Optional	The descriptive title for the honors received.	Recommended	minLength 1 maxLength 30
HonorsLevel	Optional	A code value representing 1st highest honor, 2nd highest and 3rd highest.	Recommended	Enumeration: FirstHighest SecondHighest ThirdHighest
NoteMessage	Optional Repeatable	Additional information about the Academic Honors	Not Recommended	minLength 1 maxLength 80
	Comment:			
	Comment:			

Code illustration:

```
<AcademicHonors>
  <HonorsTitle>Cum Laude</HonorsTitle>
  <HonorsLevel>ThirdHighest</HonorsLevel>
</AcademicHonors>
```

Student.AcademicRecord.AcademicSession.AcademicAward

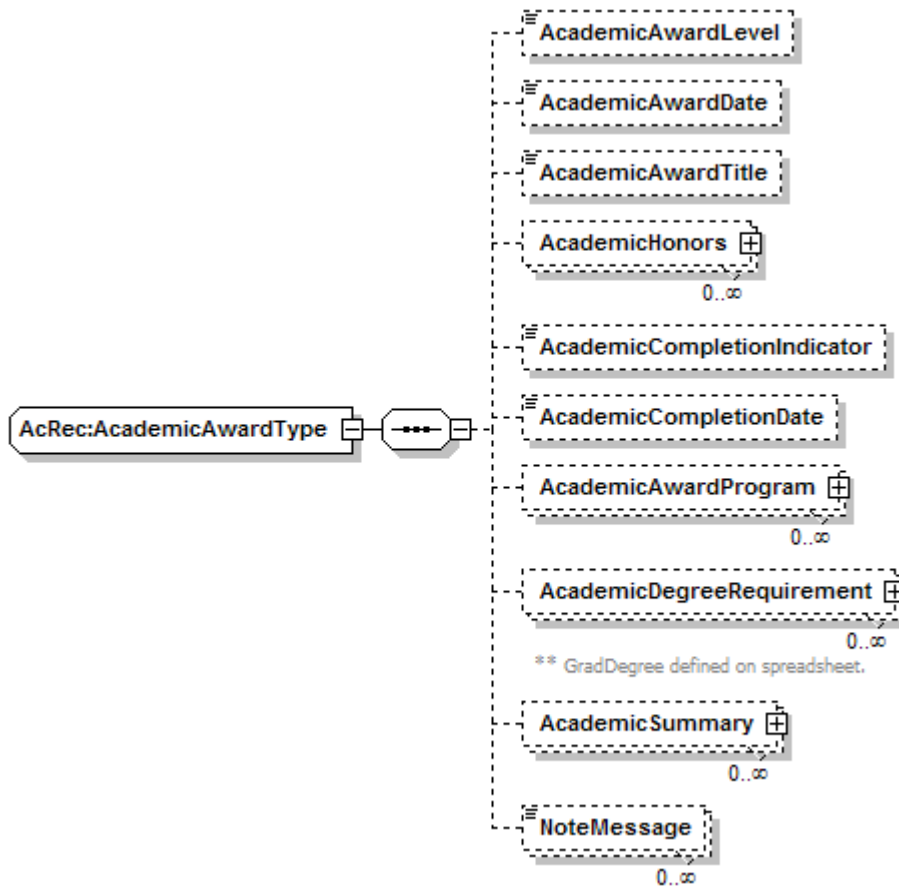

Tag Name	Schema Use	Description	Recommended Use	Format
AcademicAwardLevel	Optional	The level of the degree, certificate, or award granted for the successful completion of requirements of an academic program. 1.1 - Certificate of completion 1.2 - Certificate of proficiency 2.0 – Certificate 2.1 Postsecondary Certificate Or Diploma (less than one year) 2.2 Postsecondary Certificate Or Diploma (one year or more but less than four years) 2.3 Associate Degree (e.g., Associate In Arts, Associate In Science) 2.4 Baccalaureate Degree 2.5 Baccalaureate (Honors) Degree 2.6 Postsecondary Certificate Or Diploma (one year or more but less than two years) 2.7 Postsecondary Certificate Or Diploma (two years or more but less than four years) 3.1 First Professional Degree 3.2 Post-Professional Degree 4.1 Graduate Certificate 4.2 Master's Degree 4.3 Intermediate Graduate Degree	Recommended	Enumeration: 1.1 1.2 2.0 2.1 2.2 2.3 2.4 2.5 2.6 2.7 3.1 3.2 4.1 4.2 4.3 4.4 4.5

		4.4 Doctoral Degree 4.5 Post-doctoral Award		
AcademicAwardDate	Optional	The date on which the academic award was conferred.	Recommended	xs:date
AcademicAwardTitle	Optional	The descriptive title for the academic award.	Recommended	minLength 1 maxLength 80
AcademicHonors	Optional Repeatable	Honors information for the academic award.	Recommended	
AcademicCompletionIndicator	Optional	An indication that the degree-seeking student completed all of the requirements for his or her academic program. Not used for Non-Degree programs.	Recommended	true/false
AcademicCompletionDate	Optional	The date on which the student's requirements for the degree were met or completed.	Recommended	xs:date
AcademicAwardProgram	Optional Repeatable	Information related to the specific area of study (e.g. major) under which the award was granted.	Recommended	
AcademicDegreeRequirement	Optional Repeatable	Thesis or dissertation information if required for the award.	Recommended	
AcademicSummary	Optional Repeatable	Academic summary information pertaining to the award.	Optional	
NoteMessage	Optional Repeatable	Additional information about the academic award	Not Recommended	minLength 1 maxLength 80
	Comment:			
	Comment:			

Code illustration:

```

<AcademicAward>
  <AcademicAwardLevel>2.4</AcademicAwardLevel>
  <AcademicAwardDate>1990-05-09</AcademicAwardDate>
  <AcademicAwardTitle>BACHELOR OF ARTS</AcademicAwardTitle>
  <AcademicHonors>
*
*
    </AcademicHonors>
    <AcademicCompletionIndicator/>
    <AcademicCompletionDate/>
    <AcademicAwardProgram>
*
*
    </AcademicAwardProgram>
    <AcademicDegreeRequirement>
*
*
    </AcademicDegreeRequirement>
    <AcademicSummary>
*
*
    </AcademicSummary>
    <NoteMessage/>
</AcademicAward>

```

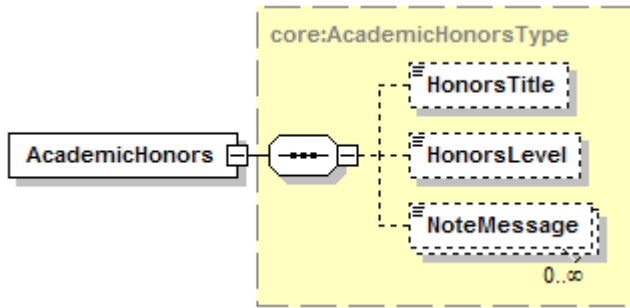
Student.AcademicRecord.AcademicSession.AcademicAward.AcademicHonors

Tag Name	Schema Use	Description	Recommended Use	Format
HonorsTitle	Optional	The descriptive title for the honors received	Recommended	minLength 1 maxLength 30
HonorsLevel	Optional	A code value representing 1st highest honor, 2nd highest and 3rd highest	Recommended	Enumeration: FirstHighest SecondHighest ThirdHighest
NoteMessage	Optional Repeatable	Additional information about the academic honors	Not Recommended	minLength 1 maxLength 80
	Comment:			
	Comment:			

Code illustration:

```

<AcademicHonors>
  <HonorsTitle/>
  <HonorsLevel>ThirdHighest</HonorsLevel>
</AcademicHonors>

```

Student.AcademicRecord.AcademicSession.AcademicAward.AcademicAwardProgram

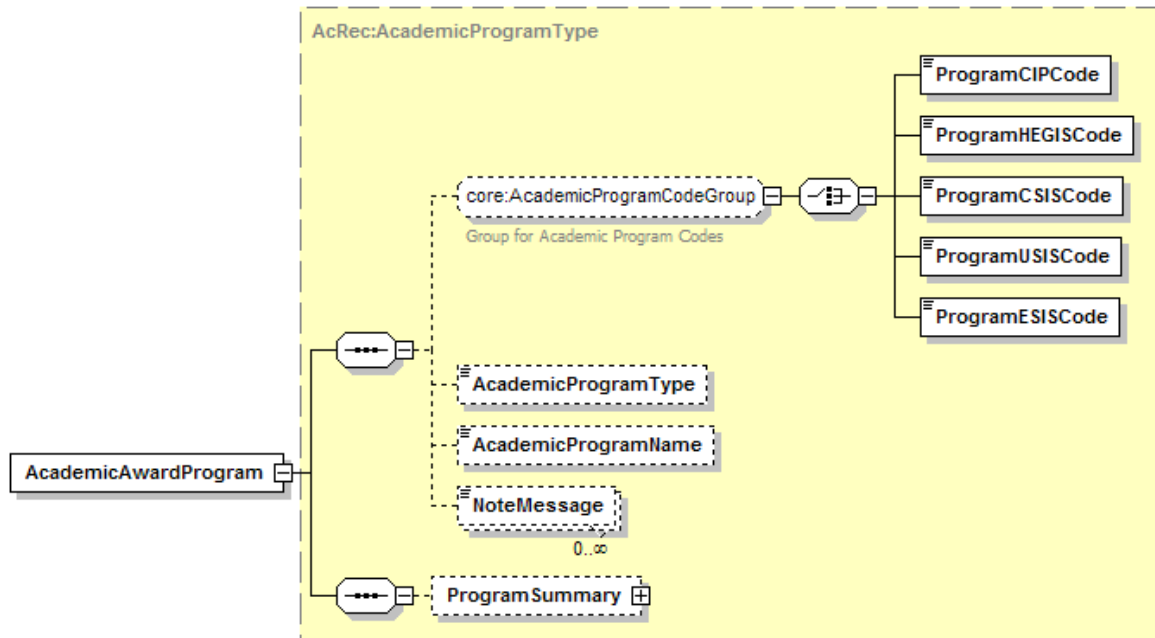

Tag Name	Schema Use	Description	Recommended Use	Format
ProgramCIPCode	Optional exclusive choice	Code indicating a discipline or field of study assigned by the Classification of Instructional Programs	Recommended (use one)	minLength 6 maxLength 20
ProgramHEGISCode	Optional exclusive choice	Code indicating a discipline or field of study assigned by Higher Education General Information Survey	Recommended (use one)	minLength 6 maxLength 20
ProgramCSISCode	Optional exclusive choice	Code indicating a discipline or field of study assigned by Statistics Canada Canadian College Student Information System	Recommended (use one)	minLength 5 maxLength 5
ProgramUSISCode	Optional exclusive choice	Code indicating a discipline or field of study assigned by the Statistics Canada University Student Information System.	Recommended (use one)	minLength 5 maxLength 5
ProgramESISCode	Optional exclusive choice	Code indicating a discipline or field of study assigned by the Statistics Canada Enhanced Student Information System.	Recommended (use one)	minLength 1 maxLength 20
AcademicProgramType	Optional	Indicates whether the academic program is a major, minor, area of concentration or specialization.	Recommended	Enumeration: Concentration Major Minor Specialization
AcademicProgramName	Optional	Literal name of program, major, or field of study.	Recommended	minLength 1 maxLength 60
NoteMessage	Optional Repeatable	Additional information about the Academic Award Program	Not Recommended	minLength 1 maxLength 80
ProgramSummary	Optional	Summary information about the Academic Award Program	Recommended	

Comment:

<i>Comment:</i>

Code illustration:

```
<AcademicAwardProgram>
  <ProgramCIPCode/>
  <AcademicProgramType>Major</AcademicProgramType>
  <AcademicProgramName>GOVERNMENT</AcademicProgramName>
  <ProgramSummary>
*
*
    </ProgramSummary>
  </AcademicAwardProgram>
```

Student.AcademicRecord.AcademicSession.AcademicAward.AcademicAwardProgram.ProgramSummary

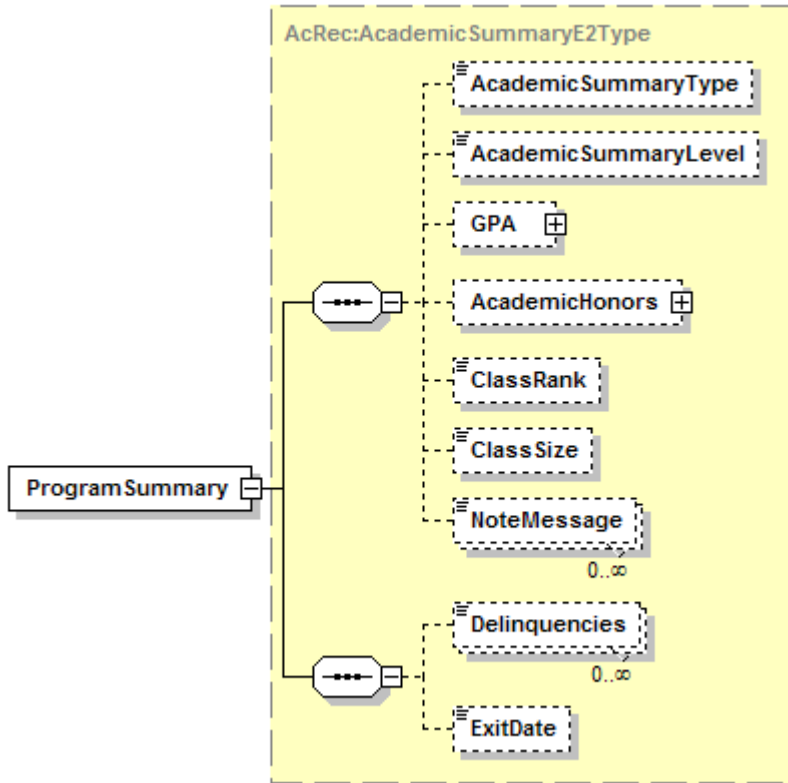

Tag Name	Schema Use	Description	Recommended Use	Format
AcademicSummaryType	Optional	<p>Summary Type is an indication of what is being summarized over what period of time</p> <p>All - Summary of all courses regardless of institution SenderOnly - Summary of all courses at sending institution (or recorded as if they were taken at the TransferOnly - Summary of transfer work (courses taken at other than the sending institution) AllNotRepeated - Summary of all courses except for repeated or forgiven courses/credits SenderNotRepeated - Summary of all courses at sending institution except for repeated or forgiven courses/credits TransferNotRepeated - Summary of transfer work except for repeated or forgiven courses/credits AcademicRenewal - Subset of forgiven courses CarryoverCredit - Summary from offline records and used as the initial point for cumulatives and averages DegreeApplicable - Summary of course that apply to degree NonDegreeApplicable - Summary of courses that do not apply toward</p>	Not Recommended	<p>Enumeration: All SenderOnly TransferOnly AllNotRepeated SenderNotRepeated TransferNotRepeated AcademicRenewal CarryoverCredit DegreeApplicable NonDegreeApplicable ConvertedFrom ConvertedTo UserDefined</p>

		<p>degree</p> <p>ConvertedFrom - Summary of credits before an institutional term-basis conversion, such as from quarters to semesters</p> <p>ConvertedTo - Summary of credits after an institutional term-basis conversion, such as from quarters to semesters</p> <p>UserDefined - see NoteMessage for explanation</p>		
AcademicSummaryLevel	Optional	<p>The level of credit associated with the credit hours earned for the course.</p> <p>Undergraduate - Undergraduate</p> <p>LowerDivision - Lower division credit (associated with first/second year)</p> <p>UpperDivision - Higher or upper division credit (associated with third or fourth year)</p> <p>Vocational - Vocational/technical credit</p> <p>TechnicalPreparatory - Tech Prep credit</p> <p>Graduate - Graduate level credit</p> <p>Professional - Professional</p> <p>Dual - Dual level (upper division and graduate- may be applicable to a bachelor's degree or graduate degree or both)</p> <p>GraduateProfessional - Dual level (graduate and professional- may be applicable to both)</p>	Not Recommended	<p>Enumeration:</p> <p>Undergraduate</p> <p>LowerDivision</p> <p>UpperDivision</p> <p>Vocational</p> <p>TechnicalPreparatory</p> <p>Graduate</p> <p>Professional</p> <p>Dual</p> <p>GraduateProfessional</p>
GPA	Optional	GPA for the Award Program	Recommended	
AcademicHonors	Optional	Honors for the Award Program	Recommended	
ClassRank	Optional	The student's class rank relative to other students in their academic cohort (e.g. class).	Not Recommended	<p>minInclusive 1</p> <p>maxInclusive 9999</p> <p>totalDigits 4</p>
ClassSize	Optional	The numeric size of the academic cohort (e.g. class).	Not Recommended	<p>minInclusive 1</p> <p>maxInclusive 9999</p> <p>totalDigits 4</p>
NoteMessage	Optional Repeatable	Additional information about the Program Summary	Not Recommended	<p>minLength 1</p> <p>maxLength 80</p>
Delinquencies	Optional Repeatable	<p>The academic standing of the student upon transfer to the institution.</p> <p>GoodStanding - Student was in good standing</p> <p>ProbationGPA - Student was on academic probation (because of low GPA)</p> <p>ProbationHours - Student was on academic probation (deficiency in credit hours)</p> <p>SuspensionGPA - Student was on academic suspension (because of low GPA)</p> <p>SuspensionHours - Student was on academic suspension (deficiency in credit hours)</p> <p>ProbationDiscipline - Student was on disciplinary probation</p> <p>SuspensionDiscipline - Student was on disciplinary suspension</p> <p>Unknown</p> <p>Other</p>	Not Recommended	<p>Enumeration:</p> <p>GoodStanding</p> <p>ProbationGPA</p> <p>ProbationHours</p> <p>SuspensionGPA</p> <p>SuspensionHours</p> <p>ProbationDiscipline</p> <p>SuspensionDiscipline</p> <p>Unknown</p> <p>Other</p>

ExitDate	Optional	The date on which the student officially withdrew or graduated.	Not Recommended	xs:date
	Comment:			
Comment:				

Code illustration:

```

<ProgramSummary>
  <AcademicSummaryType/>
  <AcademicSummaryLevel>Undergraduate</AcademicSummaryLevel>
  <GPA>
*
*
  </GPA>
  <AcademicHonors>
*
*
  </AcademicHonors>
  <ClassRank/>
  <ClassSize/>
  <NoteMessage/>
  <Delinquencies/>
  <ExitDate/>
</ProgramSummary>

```

Student.AcademicRecord.AcademicSession.AcademicAward.AcademicAwardProgram.ProgramSummary.GPA

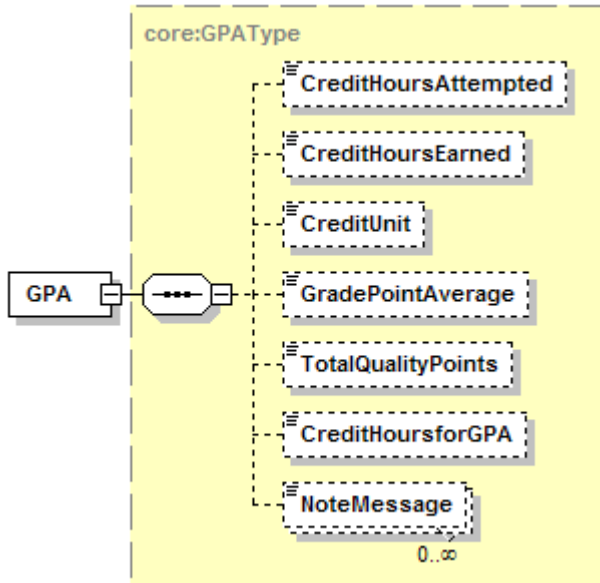

Tag Name	Schema Use	Description	Recommended Use	Format
CreditHoursAttempted	Optional	The total value of credit hours attempted whether or not included in the hours for GPA or hours earned.	Recommended	
CreditHoursEarned	Optional	The total value of credit hours successfully completed or earned.	Recommended	
CreditUnit	Optional	The type of credit (unit, semester, or quarter) associated with the credit hours earned for the course.	Recommended	Enumeration: NoCredit Quarter Semester Units ClockHours CarnegieUnits ContinuingEducationUnits Unreported Other
GradePointAverage	Optional	The value of the total quality points divided by the Credit Hours for Grade Point Average.	Recommended	xs:decimal
TotalQualityPoints	Optional	The total value of quality points used for the calculation of the Grade Point Average.	Recommended	xs:decimal
CreditHoursforGPA	Optional	The total value of credit hours included in the Grade Point Average.	Recommended	xs:decimal
NoteMessage	Optional Repeatable	Additional information about the GPA	Not Recommended	minLength 1 maxLength 80
Comment:				
Comment:				

Code illustration:

```
<GPA>  
  <CreditHoursAttempted>12</CreditHoursAttempted>  
  <CreditHoursEarned>12</CreditHoursEarned>  
  <CreditUnit>Semester</CreditUnit>  
  <GradePointAverage>3.75</GradePointAverage>  
  <TotalQualityPoints>45</TotalQualityPoints>  
  <CreditHoursforGPA>12</CreditHoursforGPA>  
</GPA>
```

Student.AcademicRecord.AcademicSession.AcademicAward.AcademicAwardProgram.ProgramSummary.AcademicHonors

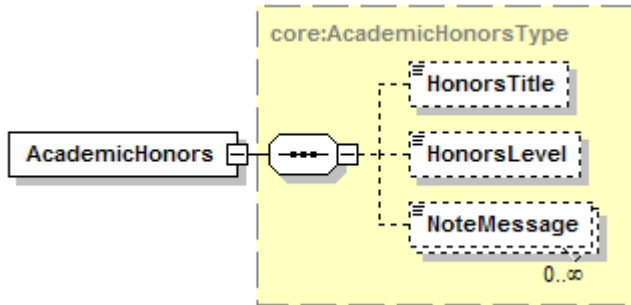

Tag Name	Schema Use	Description	Recommended Use	Format
HonorsTitle	Optional	The descriptive title for the honors received.	Recommended	minLength 1 maxLength 30
HonorsLevel	Optional	A code value representing 1st highest honor, 2nd highest and 3rd highest.	Recommended	Enumeration: FirstHighest SecondHighest ThirdHighest
NoteMessage	Optional Repeatable	Additional information about the Academic Honors	Not Recommended	minLength 1 maxLength 80
Comment:				
Comment:				

Code illustration:

```

<AcademicHonors>
  <HonorsTitle>Cum Laude</HonorsTitle>
  <HonorsLevel>ThirdHighest</HonorsLevel>
</AcademicHonors>
    
```

Student.AcademicRecord.AcademicSession.AcademicAward.AcademicDegreeRequirement

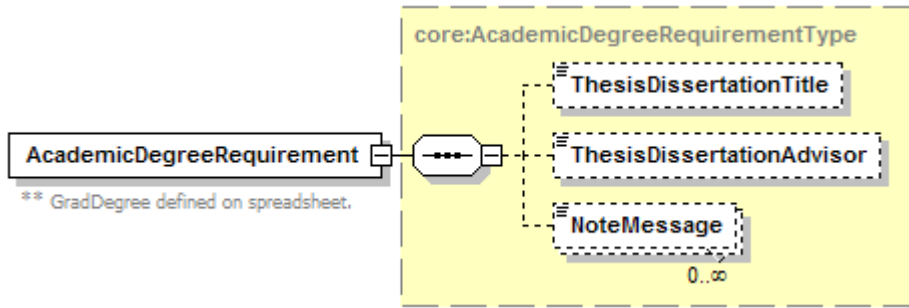

Tag Name	Schema Use	Description	Recommended Use	Format
ThesisDissertationTitle	Optional	The title of the thesis or dissertation.	Recommended	minLength 1
ThesisDissertationAdvisor	Optional	The advisor (Major Professor) supervising the Thesis or Dissertation on behalf of the student earning the degree.	Optional	minLength 1 maxLength 45
NoteMessage	Optional Repeatable	Additional information about the Academic Degree Requirement	Not Recommended	minLength 1 maxLength 80
<i>Comment:</i>				
<i>Comment:</i>				

Code illustration:

```

<AcademicDegreeRequirement>
  <ThesisDissertationTitle>The Adverse Effects of XML Implementation Guides on the Health and Sanity of
Those Charged With The Maintneance Thereof</ThesisDissertationTitle>
  <ThesisDissertationAdvisor>Bruce Marton</ThesisDissertationAdvisor>
</AcademicDegreeRequirement>
    
```

Student.AcademicRecord.AcademicSession.AcademicAward.AcademicSummary

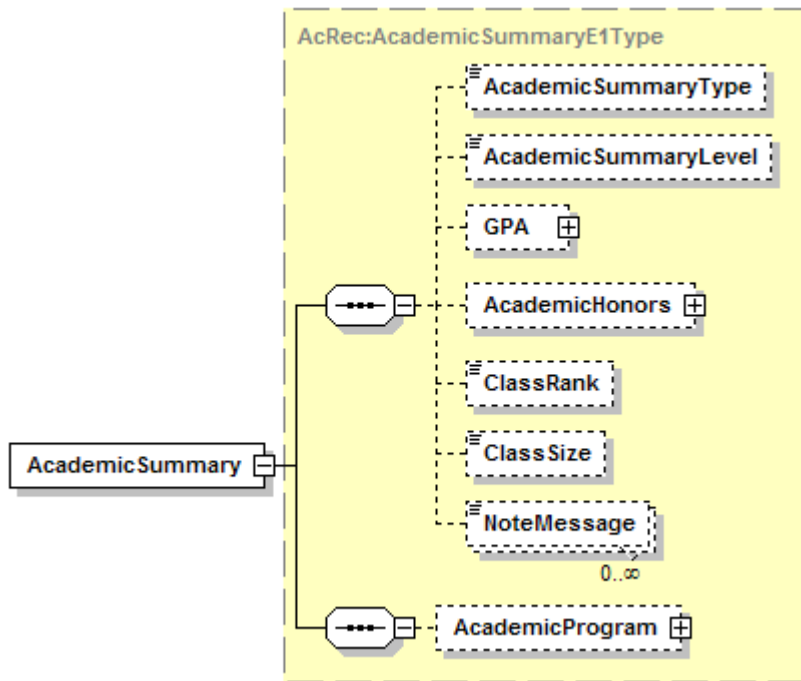

Tag Name	Schema Use	Description	Recommended Use	Format
AcademicSummaryType	Optional	<p>Summary Type is an indication of what is being summarized over what period of time</p> <p>All - Summary of all courses regardless of institution</p> <p>SenderOnly - Summary of all courses at sending institution (or recorded as if they were taken at the</p> <p>TransferOnly - Summary of transfer work (courses taken at other than the sending institution)</p> <p>AllNotRepeated - Summary of all courses except for repeated or forgiven courses/credits</p> <p>SenderNotRepeated - Summary of all courses at sending institution except for repeated or forgiven courses/credits</p> <p>TransferNotRepeated - Summary of transfer work except for repeated or forgiven courses/credits</p> <p>AcademicRenewal - Subset of forgiven courses</p> <p>CarryoverCredit - Summary from offline records and used as the initial point for cumulatives and averages</p> <p>DegreeApplicable - Summary of course that apply to degree</p> <p>NonDegreeApplicable - Summary of courses that do not apply toward degree</p> <p>ConvertedFrom - Summary of credits before an institutional term-basis conversion, such as from quarters to semesters</p> <p>ConvertedTo - Summary of credits</p>	Recommended	<p>Enumeration:</p> <p>All</p> <p>SenderOnly</p> <p>TransferOnly</p> <p>AllNotRepeated</p> <p>SenderNotRepeated</p> <p>TransferNotRepeated</p> <p>AcademicRenewal</p> <p>CarryoverCredit</p> <p>DegreeApplicable</p> <p>NonDegreeApplicable</p> <p>ConvertedFrom</p> <p>ConvertedTo</p> <p>UserDefined</p>

		after an institutional term-basis conversion, such as from quarters to semesters UserDefined - see NoteMessage for explanation		
AcademicSummaryLevel	Optional	The level of credit associated with the credit hours earned for the course.	Not Recommended	Enumeration: Undergraduate LowerDivision UpperDivision Vocational TechnicalPreparatory Graduate Professional Dual GraduateProfessional
GPA	Optional	GPA for the Academic Award	Recommended	
AcademicHonors	Optional	Honors for the Academic Award	Recommended	
ClassRank	Optional	The student's class rank relative to other students in their academic cohort (e.g. class).	Not Recommended	minInclusive 1 maxInclusive 9999 totalDigits 4
ClassSize	Optional	The numeric size of the academic cohort (e.g. class).	Not Recommended	minInclusive 1 maxInclusive 9999 totalDigits 4
NoteMessage	Optional Repeatable	Additional information about the Academic Summary	Not Recommended	minLength 1 maxLength 80
AcademicProgram	Optional	Academic Program(s) related to this Academic Summary	Not Recommended	
	Comment:			
	Comment:			

Code illustration:

```

<AcademicSummary>
  <AcademicSummaryType>All</AcademicSummaryType>
  <AcademicSummaryLevel>Undergraduate</AcademicSummaryLevel>
  <GPA>
*
*
  </GPA>
  <AcademicHonors>
*
*
  </AcademicHonors>
  <ClassRank>43</ClassRank>
  <ClassSize>849</ClassSize>
  <AcademicProgram>
*
*
  </AcademicProgram>
</AcademicSummary>

```

Student.AcademicRecord.AcademicSession.AcademicAward.AcademicSummary.GPA

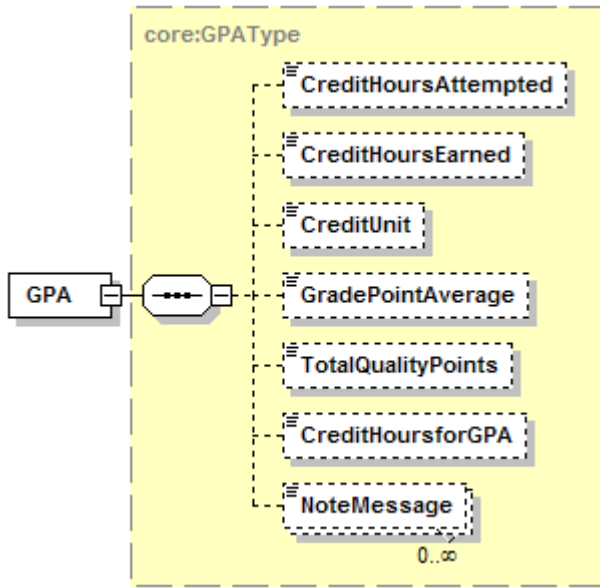

Tag Name	Schema Use	Description	Recommended Use	Format
CreditHoursAttempted	Optional	The total value of credit hours attempted whether or not included in the hours for GPA or hours earned.	Recommended	xs:decimal
CreditHoursEarned	Optional	The total value of credit hours successfully completed or earned.	Recommended	xs:decimal
CreditUnit	Optional	The type of credit (unit, semester, or quarter) associated with the credit hours earned for the course.	Recommended	Enumeration: NoCredit Quarter Semester Units ClockHours CarnegieUnits ContinuingEducationUnits Unreported Other
GradePointAverage	Optional	The value of the total quality points divided by the Credit Hours for Grade Point Average.	Recommended	xs:decimal
TotalQualityPoints	Optional	The total value of quality points used for the calculation of the Grade Point Average.	Recommended	xs:decimal
CreditHoursforGPA	Optional	The total value of credit hours included in the Grade Point Average.	Recommended	xs:decimal
NoteMessage	Optional Repeatable	Additional information about the GPA	Not Recommended	minLength 1 maxLength 80
Comment:				
Comment:				

Code illustration:

```
<GPA>  
  <CreditHoursAttempted>159</CreditHoursAttempted>  
  <CreditHoursEarned>136</CreditHoursEarned>  
  <CreditUnit>Semester</CreditUnit>  
  <GradePointAverage>3.0915</GradePointAverage>  
  <TotalQualityPoints>473</TotalQualityPoints>  
  <CreditHoursforGPA>153</CreditHoursforGPA>  
</GPA>
```

Student.AcademicRecord.AcademicSession.AcademicAward.AcademicSummary.AcademicHonors

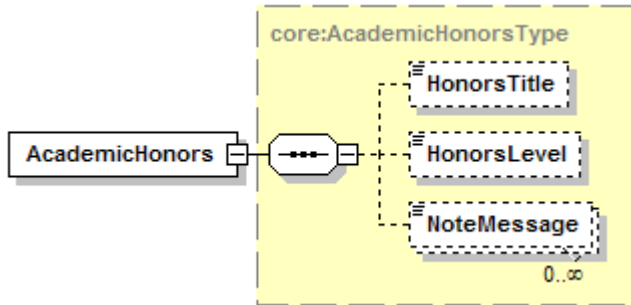

Tag Name	Schema Use	Description	Recommended Use	Format
HonorsTitle	Optional	The descriptive title for the honors received.	Recommended	minLength 1 maxLength 30
HonorsLevel	Optional	A code value representing 1st highest honor, 2nd highest and 3rd highest.	Recommended	Enumeration: FirstHighest SecondHighest ThirdHighest
NoteMessage	Optional Repeatable	Additional information about the Academic Honors	Not Recommended	minLength 1 maxLength 80
Comment:				
Comment:				

Code illustration:

```

<AcademicHonors>
  <HonorsTitle>Cum Laude</HonorsTitle>
  <HonorsLevel>ThirdHighest</HonorsLevel>
</AcademicHonors>
    
```

Student.AcademicRecord.AcademicSession.AcademicAward.AcademicSummary.AcademicProgram

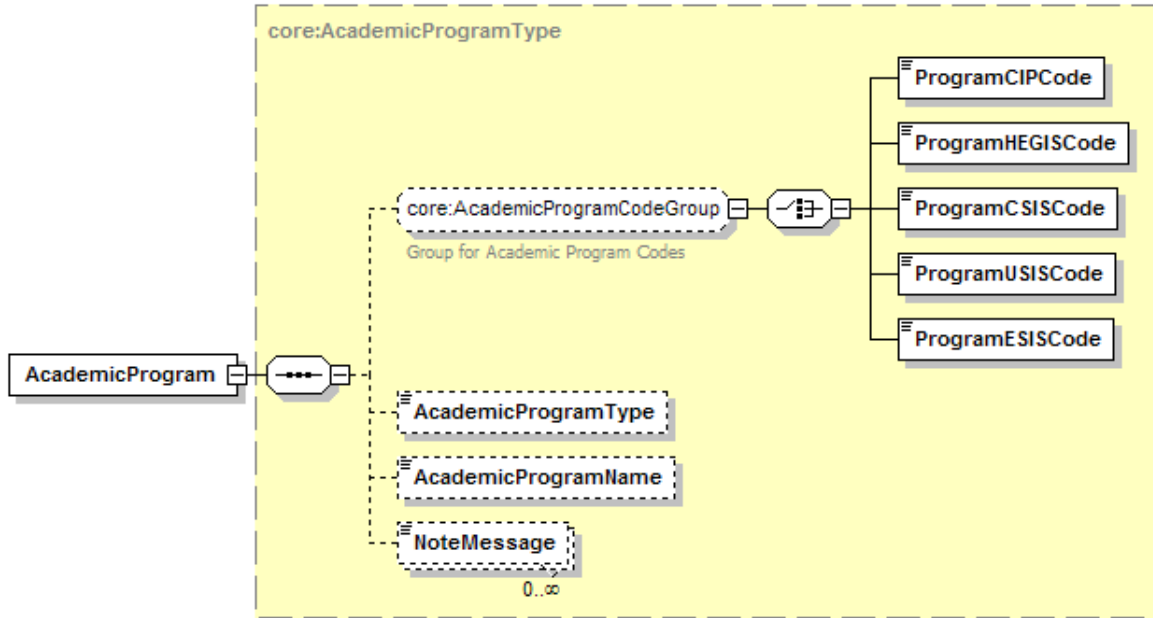

Tag Name	Schema Use	Description	Recommended Use	Format
ProgramCIPCode	Optional exclusive choice	Code indicating a discipline or field of study assigned by the Classification of Instructional Programs	Recommended (use one)	minLength 6 maxLength 20
ProgramHEGISCode	Optional exclusive choice	Code indicating a discipline or field of study assigned by Higher Education General Information Survey	Recommended (use one)	minLength 6 maxLength 20
ProgramCSISCode	Optional exclusive choice	Code indicating a discipline or field of study assigned by Statistics Canada Canadian College Student Information System	Recommended (use one)	minLength 5 maxLength 5
ProgramUSISCode	Optional exclusive choice	Code indicating a discipline or field of study assigned by the Statistics Canada University Student Information System.	Recommended (use one)	minLength 5 maxLength 5
ProgramESISCode	Optional exclusive choice	Code indicating a discipline or field of study assigned by the Statistics Canada Enhanced Student Information System.	Recommended (use one)	minLength 1 maxLength 20
AcademicProgramType	Optional	Indicates whether the academic program is a major, minor, area of concentration or specialization.	Recommended	Enumeration: Concentration Major Minor Specialization
AcademicProgramName	Optional	Literal name of program, major, or field of study.	Recommended	minLength 1 maxLength 60
NoteMessage	Optional Repeatable	Additional information about the Academic Program	Not Recommended	minLength 1 maxLength 80

Comment:

Comment:

Code illustration:

```
<AcademicProgram>  
  <ProgramCIPCode>123456</ProgramCIPCode>  
  <AcademicProgramType>Major</AcademicProgramType>  
  <AcademicProgramName>[need text]</AcademicProgramName>  
  <NoteMessage/>  
</AcademicProgram>
```

Student.AcademicRecord.AcademicSession.Course

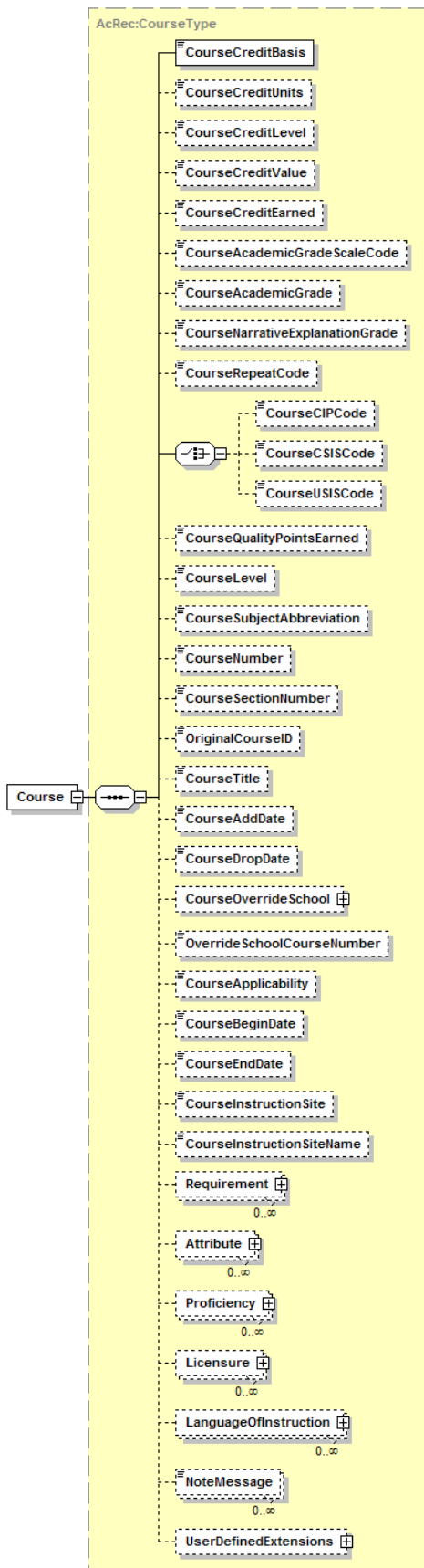

Tag Name	Schema Use	Description	Recommended Use	Format
CourseCreditBasis	Required	The type of enrollment associated with the credit hours for the course.	Required	Enumeration: Regular Major AcademicRenewal AdultBasic AdvancedPlacement AdvancedStanding ContinuingEducation Exemption Equivalence InternationalBaccalaureate Military Remedial CreditByExam HighSchoolTransferCredit HighSchoolCreditOnly HighSchoolDualCredit
CourseCreditUnits	Optional	The type of credit (unit, semester, or quarter) associated with the credit hours earned for the course.	Recommended	Enumeration: NoCredit Quarter Semester Units ClockHours CarnegieUnits ContinuingEducationUnits Unreported Other
CourseCreditLevel	Optional	The level of credit associated with the credit hours earned for the course.	Recommended	Enumeration: Undergraduate LowerDivision UpperDivision Vocational TechnicalPreparatory Graduate Professional Dual GraduateProfessional
	Comment: Usually the same as CourseLevel; differs when the student uses the credit at a level different from the CourseLevel, e.g., when the student uses an UpperDivision course (CourseLevel) for Graduate credit (CourseCreditLevel).			
CourseCreditValue	Optional	Number indicating the credit hours that may be earned in the course.	Recommended	xs:decimal
CourseCreditEarned	Optional	The number of credits a student earns by the successful completion of a course.	Recommended	xs:decimal
CourseAcademicGradeScaleCode	Optional	The grading scale used by an academic educational institution for an academic course.	Recommended	minLength 1 maxLength 3 See Appendix E
	Comment: Grade scale is based on the American Medical Colleges Admissions Services (AMCAS) grade scale, values 001 through 499 and from the American Association of Collegiate Registrars and Admissions Officers grade scale for miscellaneous grades, values 500 through 999. See Appendix E for a complete list of code values.			
CourseAcademicGrade	Optional	The final grade awarded for participation in the course.	Recommended	minLength 1 maxLength 10
CourseNarrativeExplanationGrade	Optional	The narrative of the grade awarded to a student in an academic course in those cases where a course does not receive a letter or numeric grade included in the grading scale of the Course Academic Grade Qualifier.	Not Recommended	minLength 1 maxLength 200

CourseRepeatCode	Optional	Indicates that an academic course has been repeated by a student and how that repeat is to be computed in the student's academic grade average.	Recommended	Enumeration: RepeatCounted RepeatNotCounted ReplacementCounted ReplacedNotCounted RepeatOtherInstitution NotCountedOther
CourseCIPCode	Optional Choice required	The Classification of Instructional Programs (CIP) code to describe the area of study for the course.	Optional (use one)	minLength 1 maxLength 10
CourseCSISCode	Optional Choice required	The Statistics Canada Canadian College Student Information System (CCSIS) code to describe the area of study for the course.	Optional (use one)	minLength 1 maxLength 10
CourseUSISCode	Optional Choice required	The Statistics Canada University Student Information System (USIS) code to describe the area of study for the course.	Optional (use one)	minLength 1 maxLength 10
CourseQualityPointsEarned	Optional	The numerical value assigned to a letter grade to provide a basis of quantitative determination of an average.	Recommended	xs:decimal
CourseLevel	Optional	The level of work which is reflected in the credits associated with the academic course being described or the level of the typical student taking the academic course.	Recommended	Enumeration: LowerDivision UpperDivision Dual GraduateProfessional Remedial
CourseSubjectAbbreviation	Optional	The alphabetic abbreviation of the academic department or discipline offering the course. It is one part of the total course identifier number.	Recommended	minLength 1 maxLength 10
CourseNumber	Optional	The official reference number portion of a course identifier. This number normally designates the level of the course as well as the level of the student expected to enroll in the course.	Recommended	minLength 1 maxLength 15
CourseSectionNumber	Optional	The number assigned to differentiate among distinct occurrences of courses that have the same course abbreviation and number but are considered to be different courses.	Optional	minLength 1 maxLength 10
OriginalCourseID	Optional	The course ID as it was listed when the credit was earned (e.g. before a system conversion) to show consistency between present transcripts and older ones.	Recommended	minLength 1 maxLength 30
CourseTitle	Optional	The name or title of the course taken by a student at an academic institution.	Recommended	minLength 1 maxLength 60
CourseAddDate	Optional	The date a student was added to an academic course at a school.	Optional	xs:date
CourseDropDate	Optional	The date on which the student drops or withdraws from the course.	Optional	xs:date
CourseOverrideSchool	Optional	The school where the credit was earned if different from the Academic Session School	Conditional	

OverrideSchoolCourseNumber	Optional	The course ID as it was listed at the school where the credit was earned	Conditional	minLength 1 maxLength 35
Comment: <i>CourseOverrideSchool and OverrideSchoolCourseNumber are normally used for situations like consortiums, concurrent enrollment or transfer courses, although transfer work is recommended to be reported in a separate session with an override school.</i>				
CourseApplicability	Optional	The academic program to which this academic course applies toward graduation.	Not Recommended	Enumeration: NotApplicable FirstProgram SecondProgram BothPrograms
CourseBeginDate	Optional	Begin date	Optional	xs:date
CourseEndDate	Optional	End date	Optional	xs:date
Comment: <i>CourseBeginDate and CourseEndDate are recommended when the dates differ from the session begin and end dates.</i>				
CourseInstructionSite	Optional	An indication of the type of location at which the course is taught.	Optional	Enumeration: OnCampus OffCampus Extension StudyAbroad Correctional Military Telecommunication Auxiliary ClinicHospital
CourseInstructionSiteName	Optional	The name of the location at which the course is taught.	Optional	minLength 1 maxLength 30
Requirement	Optional Repeatable	Curriculum requirements satisfied by successful completion of this course	Optional	
Attribute	Optional Repeatable	Attributes of this course which may require special handling by the receiving institution	Optional	
Proficiency	Optional Repeatable	Proficiency level signified by successful completion of this course	Optional	
Licensure	Optional Repeatable	Licensure requirements satisfied by successful completion of this course	Optional	
LanguageOfInstruction	Optional Repeatable	Language associated with one or more aspects of the course	Optional	
NoteMessage	Optional Repeatable	Additional information about the course	Not Recommended	minLength 1 maxLength 80
UserDefinedExtensions	Optional	Additional structured information. Requires mutually defined XML schema.	Optional	
Comment:				
Comment:				

Code illustration:

```

<Course>
  <CourseCreditBasis>Regular</CourseCreditBasis>
  <CourseCreditUnits>Semester </CourseCreditUnits>
  <CourseCreditLevel>LowerDivision</CourseCreditLevel>
  <CourseCreditValue>3</CourseCreditValue>
  <CourseCreditEarned>3</CourseCreditEarned>
  <CourseAcademicGradeScaleCode>25</CourseAcademicGradeScaleCode>
  <CourseAcademicGrade>A</CourseAcademicGrade>
  <CourseNarrativeExplanationGrade>text</CourseNarrativeExplanationGrade>
  <CourseRepeatCode>NotCountedOther</CourseRepeatCode>
  <CourseCIPCode>999</CourseCIPCode>
  <CourseQualityPointsEarned>12</CourseQualityPointsEarned>
  <CourseLevel>LowerDivision</CourseLevel>
  <CourseSubjectAbbreviation>HIS</CourseSubjectAbbreviation>
  <CourseNumber>315K</CourseNumber>
  <CourseSectionNumber>text</CourseSectionNumber>
  <OriginalCourseID>HIST 105</OriginalCourseID>
  <CourseTitle>HISTORY OF THE US 1</CourseTitle>
  <CourseAddDate>2005-09-01</CourseAddDate>
  <CourseDropDate>2005-09-08</CourseDropDate>
  <CourseOverrideSchool>
*
*
    </CourseOverrideSchool>
    <OverrideSchoolCourseNumber>HST 26A</OverrideSchoolCourseNumber>
    <CourseApplicability>NotApplicable</CourseApplicability>
    <CourseBeginDate>2005-09-01</CourseBeginDate>
    <CourseEndDate>2005-12-07</CourseEndDate>
    <CourseInstructionSite>OnCampus</CourseInstructionSite>
    <CourseInstructionSiteName>text</CourseInstructionSiteName>
    <Requirement>
*
*
      </Requirement>
      <Attribute>
*
*
        </Attribute>
        <Proficiency>
*
*
          </Proficiency>
          <Licensure>
*
*
            </Licensure>
            <LanguageOfInstruction>
*
*
              </LanguageOfInstruction>
              <NoteMessage>String</NoteMessage>
              <UserDefinedExtensions/>
</Course>

```

Student.AcademicRecord.AcademicSession.Course.CourseOverrideSchool

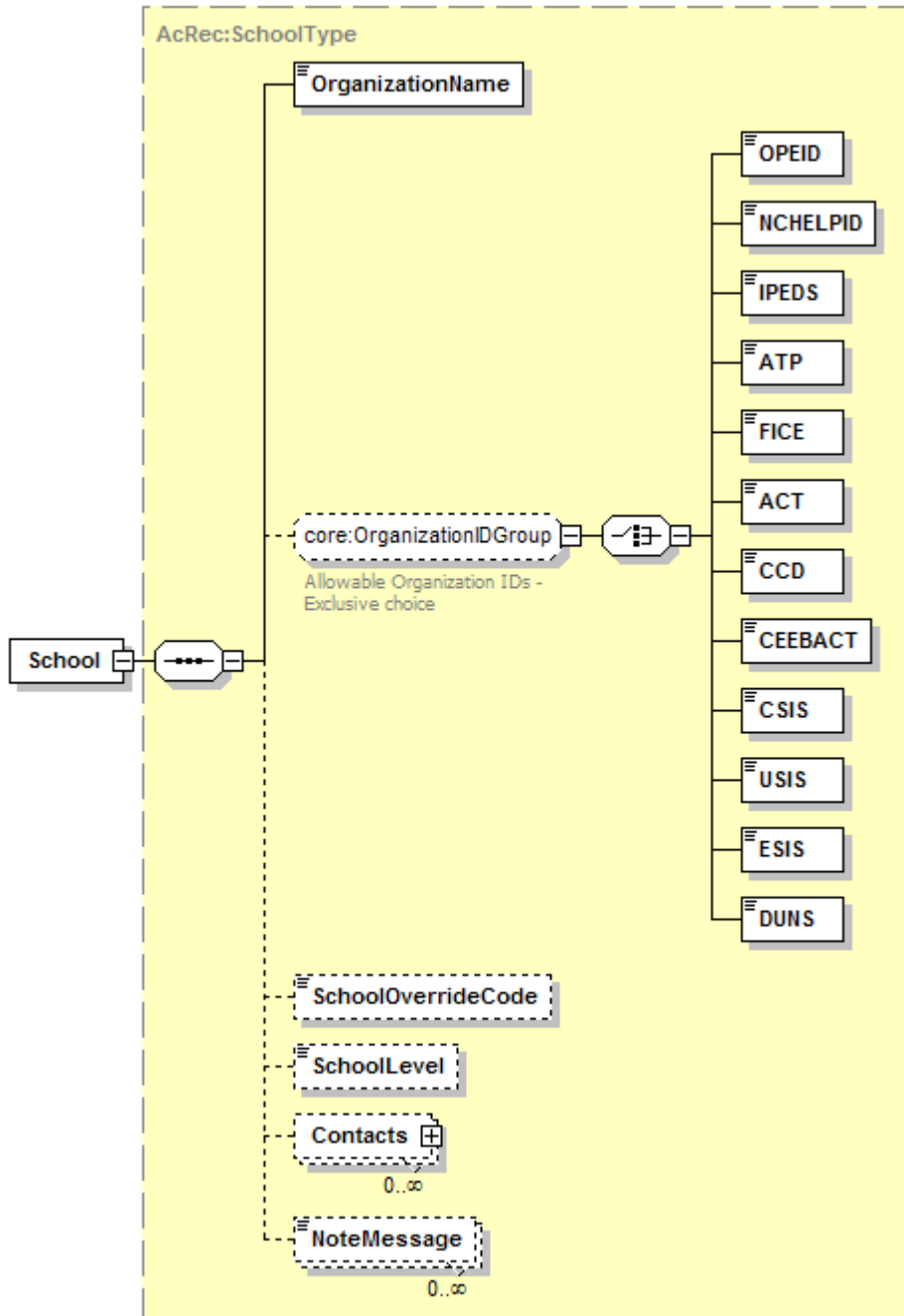

Tag Name	Schema Use	Description	Recommended Use	Format
OrganizationName	Required	Name of override school	Required	minLength 1 maxLength 60
OPEID	Required choice	The unique identifier assigned by the Office of Postsecondary Education for each data exchange partner.	Recommended (use one)	minLength 3 maxLength 8

NHELPIID	Required choice	The unique identifier assigned by National Council on Higher Education Loan Programs for each data exchange partner.	Recommended (use one)	minLength 3 maxLength 8
IPEDS	Required choice	The unique identifier assigned by the National Center for Education Statistics for the Integrated Postsecondary Education Data System for each postsecondary data exchange partner.	Recommended (use one)	minLength 6 maxLength 6
ATP	Required choice	The unique identifier assigned for the Admissions Testing Program by the College Board for each postsecondary data exchange partner.	Recommended (use one)	minLength 6 maxLength 6
FICE	Required choice	The unique identifier assigned for the Federal Interagency Committee on Education by the US Department of Education's National Center for Education Statistics for each postsecondary data exchange partner	Recommended (use one)	minLength 6 maxLength 6
ACT	Required choice	The unique identifier assigned by the American College Testing or ACT for each postsecondary data exchange partner. See www.act.org .	Recommended (use one)	minLength 4 maxLength 4
CCD	Required choice	The unique identifier assigned by the US Department of Education's National Center for Education Statistics as the Common Core of Data for each K12 data exchange partner.	Recommended (use one)	minLength 12 maxLength 12
CEEBACT	Required choice	The unique identifier assigned by the College Entrance Examining Board and ACT for each data exchange partner.	Recommended (use one)	minLength 6 maxLength 6
CSIS	Required choice	The unique identifier assigned by the Statistics Canada Canadian College Student Information System for each data exchange partner	Recommended (use one)	minLength 6 maxLength 6
USIS	Required choice	The unique identifier assigned by the Statistics Canada University Student Information System for each data exchange partner	Recommended (use one)	minLength 6 maxLength 6
ESIS	Required choice	The unique identifier assigned by the Statistics Canada Enhanced Student Information System for each data exchange partner.	Recommended (use one)	minLength 8 maxLength 8
DUNS	Required choice	Data Universal Numbering System (DUNS), unique nine character company identification number issued by Dun and Bradstreet Corporation.	Recommended (use one)	minLength 9 maxLength 9

SchoolOverrideCode	Optional	The source of the academic credit if not awarded by the home or parent institution. Institutional - Institutional Agreement Multicampus - Multiple Campus Course Offering Transfer - Transfer Credit StudyAbroad - Study Abroad Coop - Cooperative Program Reciprocal - Reciprocal Exchange Internship - Internship	Recommended	Enumeration: Institutional Multicampus Transfer StudyAbroad Coop Reciprocal Internship
SchoolLevel	Optional	Indicates level of Override School	Recommended	Enumeration: Elementary Secondary Postsecondary
Contacts	Optional Repeatable	Contact info at Override School	Optional	
NoteMessage	Optional Repeatable	Additional information about the Override School	Not Recommended	minLength 1 maxLength 80

Comment:

Comment:

Code illustration:

```

<School>
  <OrganizationName>TEXAS A&M UNIVERSITY COLLEGE STATION</OrganizationName>
  <ATP>006003</ATP>
  <SchoolOverrideCode>Transfer</SchoolOverrideCode>
  <SchoolLevel>Postsecondary</SchoolLevel>
  <Contacts>
*
*
  </Contacts>
</School>
    
```

Student.AcademicRecord.AcademicSession.Course.CourseOverrideSchool.Contacts

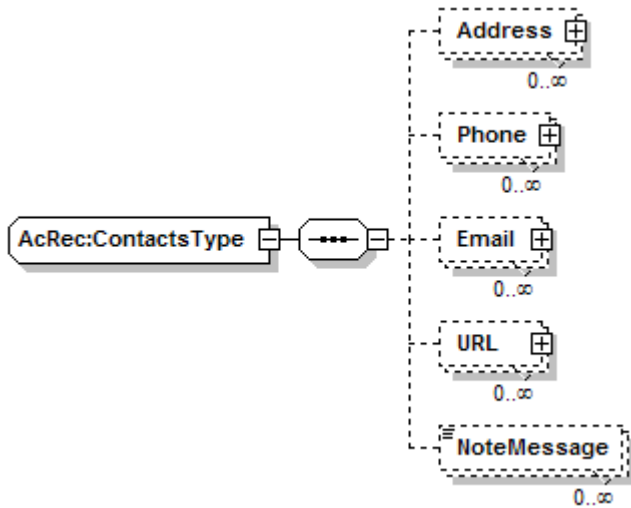

Tag Name	Schema Use	Description	Recommended Use	Format
Address	Optional Repeatable	Address of the Override School	Recommended	minOcc 0 maxOcc ∞
Phone	Optional Repeatable	Phone Number of the Override School	Optional	minOcc 0 maxOcc ∞
Email	Optional Repeatable	Email Address of the Override School	Optional	minOcc 0 maxOcc ∞
URL	Optional Repeatable	Universal Resouce Locator of the Override School	Optional	minOcc 0 maxOcc ∞
NoteMessage	Optional Repeatable	Additional information about the contacts at the Override School	Not Recommended	minLength 1 maxLength 80
	Comment:			
	Comment:			

Code illustration:

```

<Contacts>
  <Address>
*
*
  </Address>
  <Phone>
*
*
  </Phone>
  <Email>
*
*
  </Email>
  <URL>
*
*
  </URL>
  <NoteMessage/>
</Contacts>
    
```

Student.AcademicRecord.AcademicSession.Course.CourseOverrideSchool.Contacts.Address

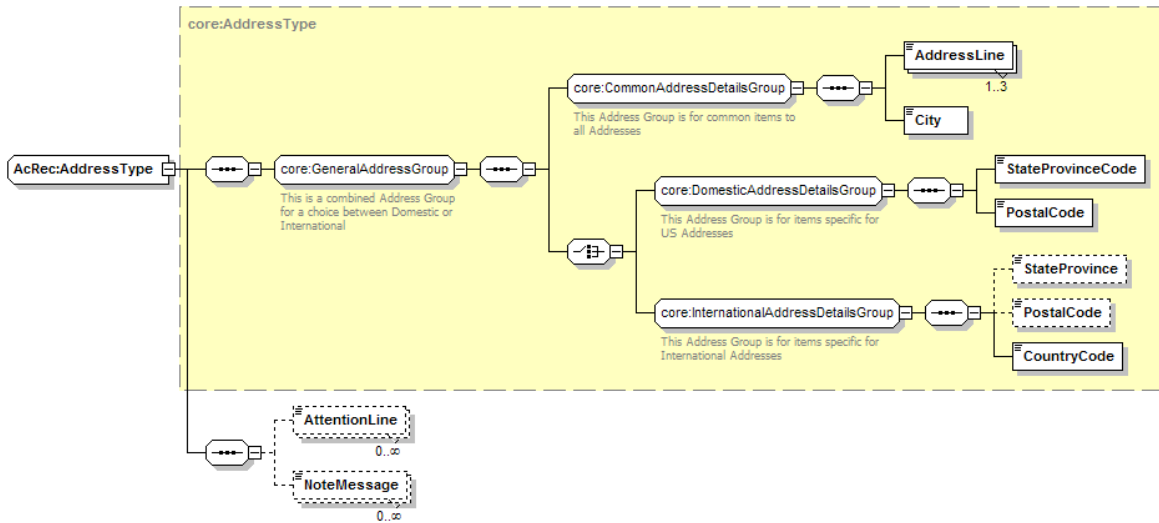

Tag Name	Schema Use	Description	Recommended Use	Format
CommonAddressDetailsGroup	Required	This Address Group is for items common to all Addresses	Required	minOcc 1 maxOcc 1
Comment: [CommonAddressDetailsGroup] is not a tag and does not appear in the instance document. If the address of a contact is included in the transcript, then this must be sent. It is required and must be paired with one of either DomesticAddressDetailsGroup or InternationalAddressDetailsGroup.				
DomesticAddressDetailsGroup	Required choice	This Address Group is for items specific for US and Canadian Addresses	Required for domestic addresses	minOcc 1 maxOcc 1
Comment: [DomesticAddressDetailsGroup] is not a tag and does not appear in the instance document. If the address has a United States or Canadian Postal Code and a US State or Canadian Province Code, then this should be the required choice.				
InternationalAddressDetailsGroup	Required choice	This Address Group is for items specific for International Addresses	Required for international addresses	minOcc 1 maxOcc 1
Comment: [InternationalAddressDetailsGroup] is not a tag and does not appear in the instance document. This choice is for addresses that do not have a US or Canadian postal code.				
AttentionLine	Optional	The individual or office name within the postal address where inquiries should be directed.	Optional	minOcc 0 maxOcc ∞ minLength 1 maxLength 45
NoteMessage	Optional Repeatable	Additional information about the address	Not Recommended	minOcc 0 maxOcc ∞
Comment:				
Comment:				

Code illustration:

```
<Address>  
  <AddressLine>Office of the Registrar</AddressLine>  
  <AddressLine>1 University Station</AddressLine>  
  <City>Austin</City>  
  <StateProvinceCode>TX</StateProvinceCode>  
  <PostalCode>78712</PostalCode>  
  <AttentionLine>Jane Shaugness</AttentionLine>  
  <NoteMessage/>  
</Address>
```

Student.AcademicRecord.AcademicSession.Course.CourseOverrideSchool.Contacts.Address.CommonAddressDetailsGroup

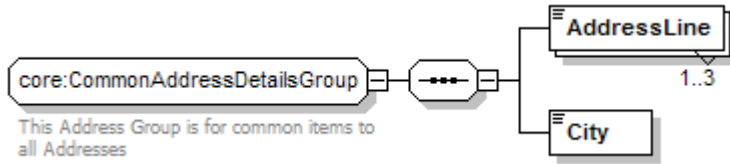

Tag Name	Schema Use	Description	Recommended Use	Format
AddressLine	Required Repeatable	Local delivery information such as street, building number, PO box, or apartment portion of a postal address.	Required	minOcc 1 maxOcc 3 minLength 1 maxLength 40
City	Required	The city portion of the Address.	Required	minOcc 1 maxOcc 1 minLength 2 maxLength 30
	Comment:			
	Comment:			

Code illustration:

```
<AddressLine>University of Oxford</AddressLine>
<AddressLine>Wellington Square</AddressLine>
<City>Oxford</City>
```

Student.AcademicRecord.AcademicSession.Course.CourseOverrideSchool.Contacts.Address.DomesticAddressDetailsGroup

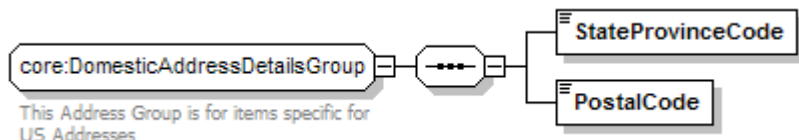

Tag Name	Schema Use	Description	Recommended Use	Format
StateProvinceCode	Required	Code for US states, etc., and Canadian provinces.	Required	See Appendix A
PostalCode	Required	The postal code portion of the Address.	Required	minLength 1 maxLength 17
Comment:				
Comment:				

Code illustration:

```
<StateProvinceCode>TX</StateProvinceCode>
<PostalCode>78712</PostalCode>
```

Student.AcademicRecord.AcademicSession.Course.CourseOverrideSchool.Contacts.Address.InternationalAddressDetailsGroup

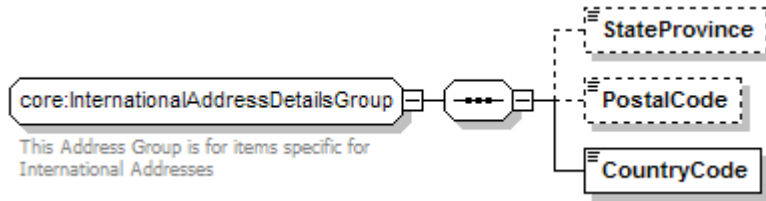

Tag Name	Schema Use	Description	Recommended Use	Format
StateProvince	Optional	The literal name of the state, province or territory of a postal address. Use for addresses outside US or Canada.	Optional	minLength 2 maxLength 30
	Comment: For an internet resource of states or other geographical subdivisions in countries other than the US and Canada, you might choose to refer to the website of the Universal Postal Union at http://www.upu.int			
PostalCode	Optional	The postal code portion of the Address.	Optional	minLength 1
	Comment: For an internet resource of states or other geographical subdivisions in countries other than the US and Canada, you might choose to refer to the website of the Universal Postal Union at http://www.upu.int			
CountryCode	Required	Code indicating Country. Use ISO 3166-1 alpha-2 standard.	Required	See Appendix B
	Comment:			
	Comment:			

Code illustration:

```
<PostalCode>0X1 2JD</PostalCode>
<CountryCode>GB</CountryCode>
```

Student.AcademicRecord.AcademicSession.Course.CourseOverrideSchool.Contacts.Phone

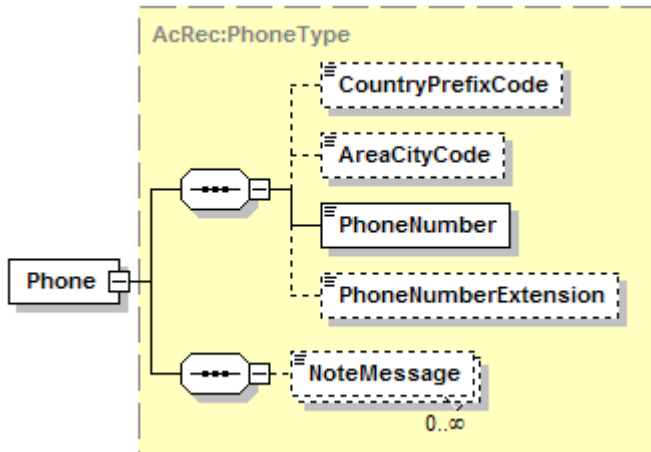

Tag Name	Schema Use	Description	Recommended Use	Format
CountryPrefixCode	Optional	International dialing code.	Optional	minLength 1 maxLength 3
AreaCityCode	Optional	Regional dialing code.	Recommended	minLength 1 maxLength 5
PhoneNumber	Required	Telephone number.	Required	minLength 1 maxLength 11
PhoneNumberExtension	Optional	The extended telephone addressing information used in addition to phone number such as a PBX extension, a pager PIN, or FAX sub-address.	Optional	minLength 1 maxLength 5
NoteMessage	Optional Repeatable	Additional information about the phone number of the override school	Not recommended	minOcc 0 maxOcc ∞
Comment:				
Comment:				

Code illustration:

```

<Phone>
  <CountryPrefixCode/>
  <AreaCityCode>512</AreaCityCode>
  <PhoneNumber>4757638</PhoneNumber>
  <PhoneNumberExtension/>
  <NoteMessage/>
</Phone>
    
```

Student.AcademicRecord.AcademicSession.Course.CourseOverrideSchool.Contacts.Email

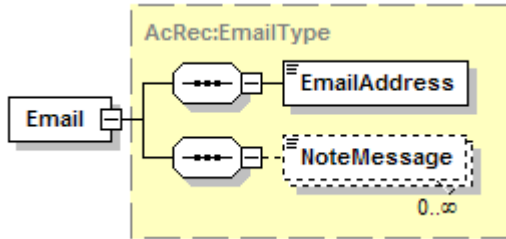

Tag Name	Schema Use	Description	Recommended Use	Format
EmailAddress	Required	The numbers, letters, and symbols used to identify an electronic mail (Email) user within a network.	Required	minLength 1 maxLength 128
NoteMessage	Optional Repeatable	Additional information about the email address	Not recommended	minOcc 0 maxOcc ∞
Comment:				
Comment:				

Code illustration:

```

<Email>
  <EmailAddress/>
  <NoteMessage/>
</Email>
    
```

Student.AcademicRecord.AcademicSession.Course.CourseOverrideSchool.Contacts.URL

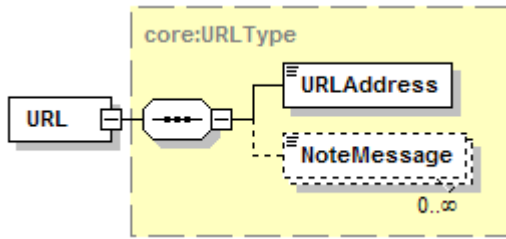

Tag Name	Schema Use	Description	Recommended Use	Format
URLAddress	Required	The Uniform Resource Locator (URL) address associated with a product, deliverable or contact.	Required	minLength 0 maxLength 512
NoteMessage	Optional Repeatable	Additional information about the URL	Not Recommended	minLength 1 maxLength 80
	Comment:			
	Comment:			

Code illustration:

```

<URL>
  <URLAddress/>
  <NoteMessage/>
</URL>
    
```

Student.AcademicRecord.AcademicSession.Course.Requirement

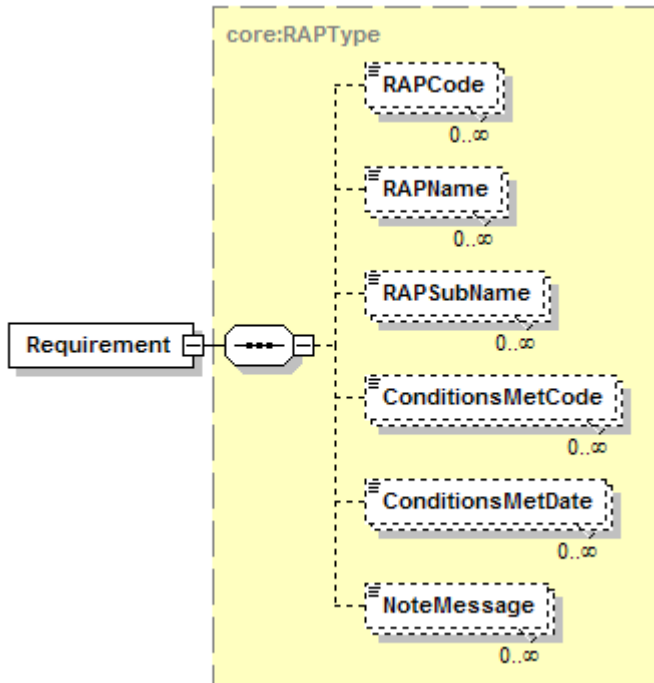

Tag Name	Schema Use	Description	Recommended Use	Format
RAPCode	Optional Repeatable	Requirement demonstrated or earned in addition to academic award.	Recommended	minLength 1 maxLength 3
RAPName	Optional Repeatable	Literal name of requirement	Recommended	minLength 1 maxLength 60
RAPSubName	Optional Repeatable	Literal name of subsection of requirement	Optional	minLength 1 maxLength 60
ConditionsMetCode	Optional Repeatable	Indicates whether and how conditions for certification have been attained.	Recommended	Enumeration: Yes No Conditional MutuallyDefined
ConditionsMetDate	Optional Repeatable	Date of requirement	Optional	xs:date
NoteMessage	Optional Repeatable	Additional information about the requirement	Not Recommended	minLength 1 maxLength 80
Comment:				
Comment:				

Code illustration:

```

<Requirement>
  <RAPCode>9TX</RAPCode>
  <RAPName>TXCORECURR</RAPName>
  <RAPSubName>030Natural Sciences - C1</RAPSubName>
  <ConditionsMetCode>Yes</ConditionsMetCode>
  <ConditionsMetDate>2002-08-13</ConditionsMetDate>
</Requirement>
    
```

Student.AcademicRecord.AcademicSession.Course.Attribute

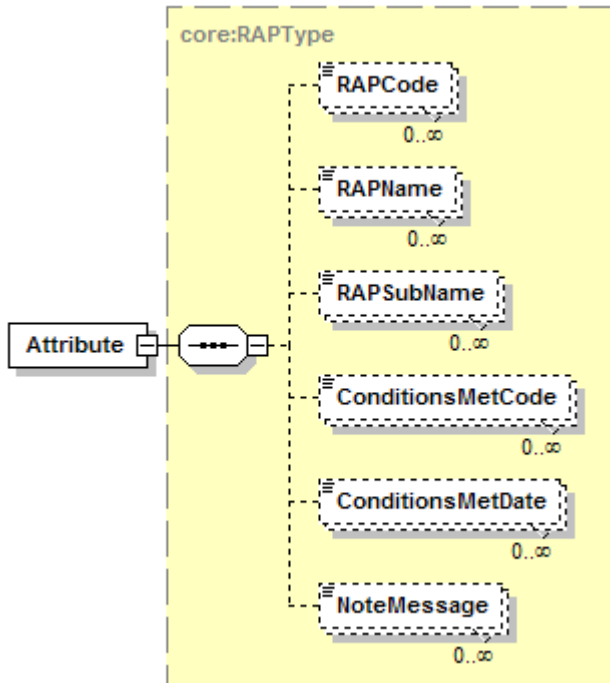

Tag Name	Schema Use	Description	Recommended Use	Format
RAPCode	Optional Repeatable	Attribute demonstrated or earned in addition to academic award.	Recommended	minLength 1 maxLength 3
RAPName	Optional Repeatable	Literal name of attribute	Recommended	minLength 1 maxLength 60
RAPSubName	Optional Repeatable	Literal name of subsection of attribute	Optional	minLength 1 maxLength 60
ConditionsMetCode	Optional Repeatable	Indicates whether and how conditions for certification have been attained.	Recommended	Enumeration: Yes No Conditional MutuallyDefined
ConditionsMetDate	Optional Repeatable	Date of attribute	Optional	
NoteMessage	Optional Repeatable	Additional information about the attribute	Not Recommended	minLength 1 maxLength 80
	Comment:			
	Comment:			

Code illustration:

```

<Attribute>
  <RAPCode>9TX</RAPCode>
  <RAPName>TXCORECURR</RAPName>
  <RAPSubName>030Natural Sciences - C1</RAPSubName>
  <ConditionsMetCode>Yes</ConditionsMetCode>
  <ConditionsMetDate>2002-08-13</ConditionsMetDate>
</Attribute>
    
```

Student.AcademicRecord.AcademicSession.Course.Proficiency

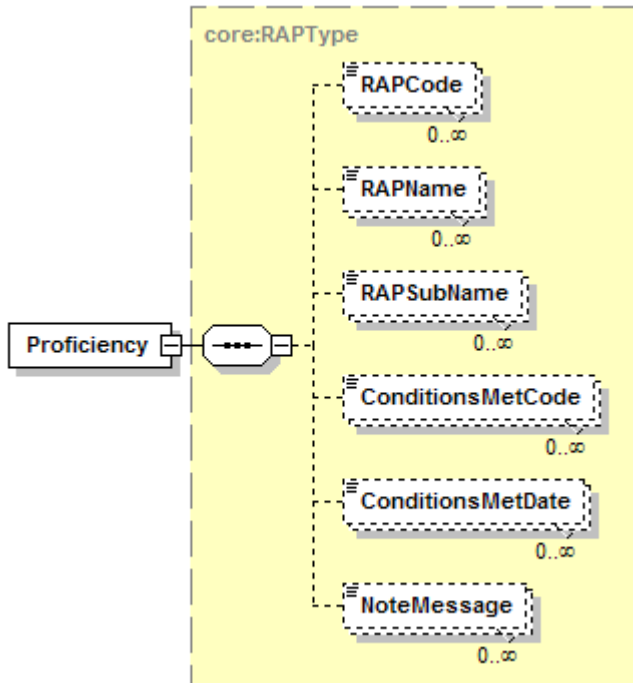

Tag Name	Schema Use	Description	Recommended Use	Format
RAPCode	Optional Repeatable	Proficiency demonstrated or earned in addition to academic award.	Recommended	minLength 1 maxLength 3
RAPName	Optional Repeatable	Literal name of proficiency	Recommended	minLength 1 maxLength 60
RAPSubName	Optional Repeatable	Literal name of subsection of proficiency	Optional	minLength 1 maxLength 60
ConditionsMetCode	Optional Repeatable	Indicates whether and how conditions for certification have been attained.	Recommended	Enumeration: Yes No Conditional MutuallyDefined
ConditionsMetDate	Optional Repeatable	Date of proficiency	Optional	
NoteMessage	Optional Repeatable	Additional information about the proficiency	Not Recommended	minLength 1 maxLength 80
	Comment:			
	Comment:			

Code illustration:

```

<Proficiency>
  <RAPCode>9TX</RAPCode>
  <RAPName>TXCORECURR</RAPName>
  <RAPSubName>030Natural Sciences - C1</RAPSubName>
  <ConditionsMetCode>Yes</ConditionsMetCode>
  <ConditionsMetDate>2002-08-13</ConditionsMetDate>
</Proficiency>
    
```

Student.AcademicRecord.AcademicSession.Course.Licensure

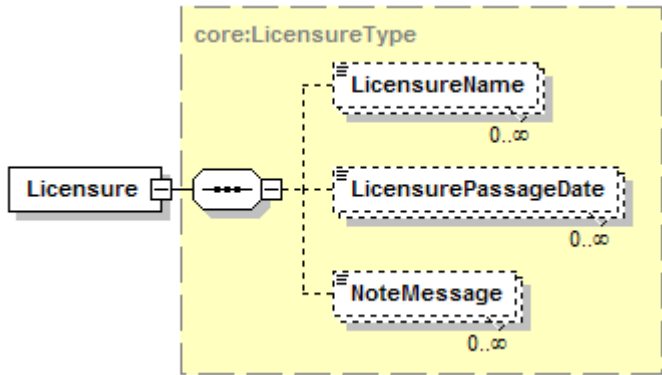

Tag Name	Schema Use	Description	Recommended Use	Format
LicensureName	Optional Repeatabe	Free-form name of license or certification.	Recommended	minLength 1 maxLength 60
LicensurePassageDate	Optional Repeatabe	Date of licensure passage	Not Recommended	xs:date
NoteMessage	Optional Repeatabe	Additional information about the licensure	Not Recommended	minLength 1 maxLength 80
	Comment:			
	Comment:			

Code illustration:

```

<Licensure>
  <LicensureName>Occupational Therapy Assistant</LicensureName>
  <LicensurePassageDate>1992-05-20</LicensurePassageDate>
  <NoteMessage/>
</Licensure>
    
```

Student.AcademicRecord.AcademicSession.Course.LanguageOfInstruction

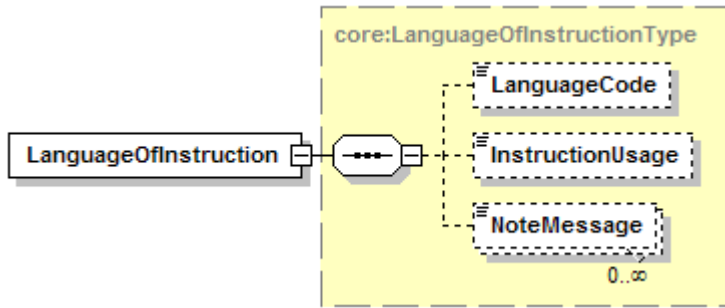

Tag Name	Schema Use	Description	Recommended Use	Format
LanguageCode	Optional	Code indicating the language being used, using ISO 639-2 code (Alpha-3) set. These codes are available at http://www.loc.gov/standards/iso639-2/	Recommended	minLength 3 maxLength 3
InstructionUsage	Optional	The use of the language in the context of instruction. Instruction - Language of Instruction Examination - Language of Examination WrittenExam - Language in which Examination is written	Recommended	Enumeration: Instruction Examination WrittenExam
NoteMessage	Optional Repeatable	Additional information about the language of instruction	Not Recommended	minLength 1 maxLength 80
Comment:				
Comment:				

Code illustration:

```
<LanguageOfInstruction>
  <LanguageCode>fre</LanguageCode>
  <InstructionUsage>Examination</InstructionUsage>
  <NoteMessage/>
</LanguageOfInstruction>
```

Student.AcademicRecord.AcademicSession.AcademicSummary

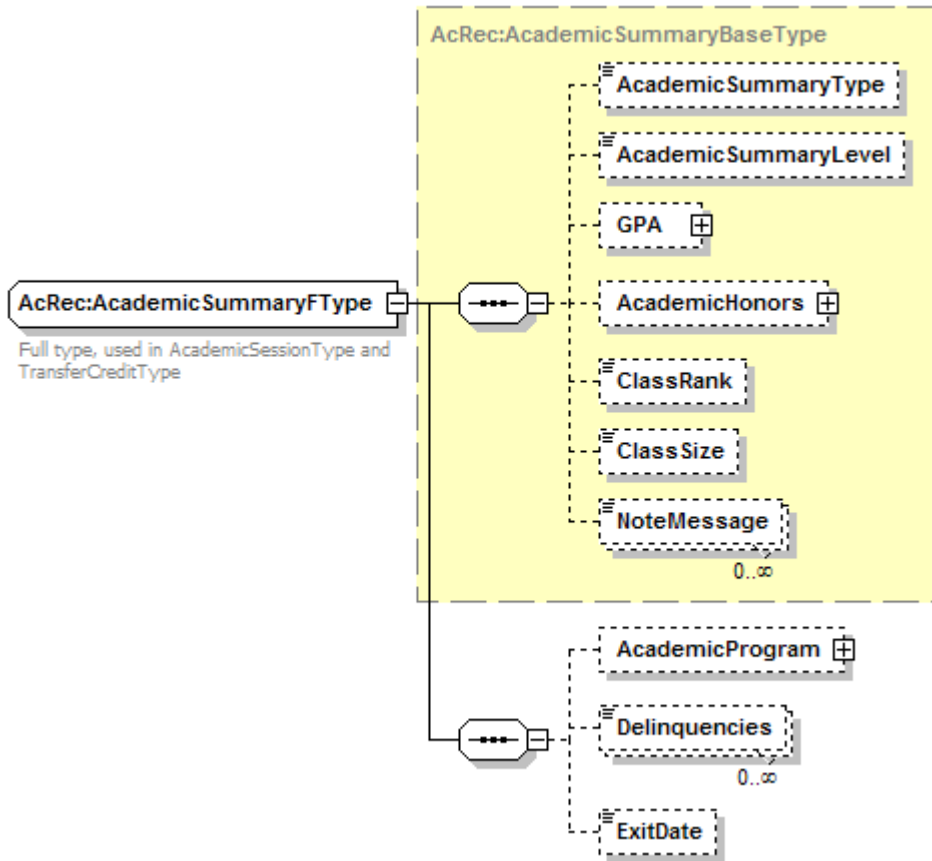

Tag Name	Schema Use	Description	Recommended Use	Format
AcademicSummaryType	Optional	Summary Type is an indication of what is being summarized over what period of time All - Summary of all courses regardless of institution SenderOnly - Summary of all courses at sending institution (or recorded as if they were taken at the TransferOnly - Summary of transfer work (courses taken at other than the sending institution) AllNotRepeated - Summary of all courses except for repeated or forgiven courses/credits SenderNotRepeated - Summary of all courses at sending institution except for repeated or forgiven courses/credits TransferNotRepeated - Summary of transfer work except for repeated or forgiven courses/credits AcademicRenewal - Subset of forgiven courses CarryoverCredit - Summary from offline records and used as the initial point for cumulatives and averages DegreeApplicable - Summary of course that apply to degree	Recommended	Enumeration: All SenderOnly TransferOnly AllNotRepeated SenderNotRepeated TransferNotRepeated AcademicRenewal CarryoverCredit DegreeApplicable NonDegreeApplicable ConvertedFrom ConvertedTo UserDefined

		<p>NonDegreeApplicable - Summary of courses that do not apply toward degree</p> <p>ConvertedFrom - Summary of credits before an institutional term-basis conversion, such as from quarters to semesters</p> <p>ConvertedTo - Summary of credits after an institutional term-basis conversion, such as from quarters to semesters</p> <p>UserDefined - see NoteMessage for explanation</p>		
<p>Comment: Additional Enumeration is needed to distinguish session summary from cumulative summary as of the end of this session.</p>				
AcademicSummaryLevel	Optional	The level of credit associated with the credit hours earned for the course.	Optional	<p>Enumeration:</p> <p>Undergraduate</p> <p>LowerDivision</p> <p>UpperDivision</p> <p>Vocational</p> <p>TechnicalPreparatory</p> <p>Graduate</p> <p>Professional</p> <p>Dual</p> <p>GraduateProfessional</p>
GPA	Optional	GPA for this academic summary	Recommended	
AcademicHonors	Optional	Honors associated with this academic summary	Optional	
<p>Comment: This would typically be where items like Dean's List are listed.</p>				
ClassRank	Optional	The student's class rank relative to other students in their academic cohort (e.g. class).	Not Recommended	<p>minInclusive 1</p> <p>maxInclusive 9999</p> <p>totalDigits 4</p>
ClassSize	Optional	The numeric size of the academic cohort (e.g. class).	Not Recommended	<p>minInclusive 1</p> <p>maxInclusive 9999</p> <p>totalDigits 4</p>
NoteMessage	Optional Repeatable	Additional information about the academic summary	Not Recommended	<p>minLength 1</p> <p>maxLength 80</p>
AcademicProgram	Optional	Academic program (major) associated with this academic summary	Not Recommended	
Delinquencies	Optional Repeatable	<p>The academic standing of the student at the end of this session.</p> <p>GoodStanding - Student was in good standing</p> <p>ProbationGPA - Student was on academic probation (because of low GPA)</p> <p>ProbationHours - Student was on academic probation (deficiency in credit hours)</p> <p>SuspensionGPA - Student was on academic suspension (because of low GPA)</p> <p>SuspensionHours - Student was on academic suspension (deficiency in credit hours)</p> <p>ProbationDiscipline - Student was on disciplinary probation</p> <p>SuspensionDiscipline - Student was on disciplinary suspension</p> <p>Unknown</p> <p>Other</p>	Optional	<p>Enumeration:</p> <p>GoodStanding</p> <p>ProbationGPA</p> <p>ProbationHours</p> <p>SuspensionGPA</p> <p>SuspensionHours</p> <p>ProbationDiscipline</p> <p>SuspensionDiscipline</p> <p>Unknown</p> <p>Other</p>

ExitDate	Optional	The date on which the student officially withdrew or graduated.	Optional	
	Comment:			
Comment:				

Code illustration:

```

<AcademicSummary>
  <AcademicSummaryType>All</AcademicSummaryType>
  <AcademicSummaryLevel>Undergraduate</AcademicSummaryLevel>
  <GPA>
*
*
    </GPA>
    <AcademicHonors>
*
*
      </AcademicHonors>
      <ClassRank>43</ClassRank>
      <ClassSize>849</ClassSize>
      <AcademicProgram>
*
*
        </AcademicProgram>
        <Delinquencies>GoodStanding</Delinquencies>
        <ExitDate>2003-05-13</ExitDate>
</AcademicSummary>

```

Student.AcademicRecord.AcademicSession.AcademicSummary.GPA

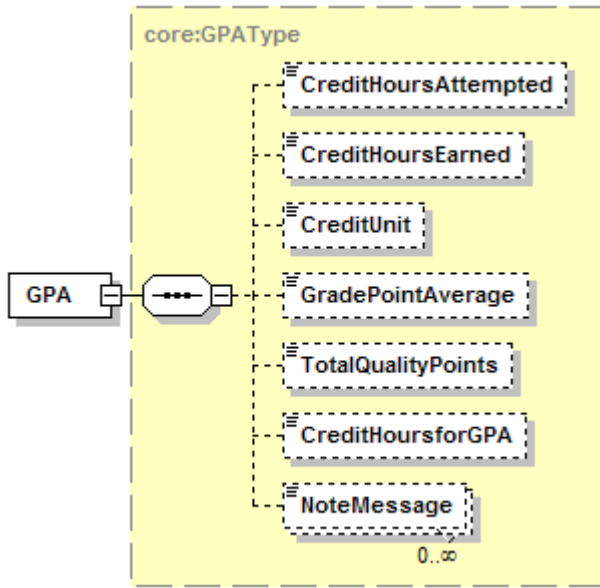

Tag Name	Schema Use	Description	Recommended Use	Format
CreditHoursAttempted	Optional	The total value of credit hours attempted whether or not included in the hours for GPA or hours earned.	Recommended	xs:decimal
CreditHoursEarned	Optional	The total value of credit hours successfully completed or earned.	Recommended	xs:decimal
CreditUnit	Optional	The type of credit (unit, semester, or quarter) associated with the credit hours earned for the course.	Recommended	Enumeration: NoCredit Quarter Semester Units ClockHours CarnegieUnits ContinuingEducationUnits Unreported Other
GradePointAverage	Optional	The value of the total quality points divided by the Credit Hours for Grade Point Average.	Recommended	xs:decimal
TotalQualityPoints	Optional	The total value of quality points used for the calculation of the Grade Point Average.	Recommended	xs:decimal
CreditHoursforGPA	Optional	The total value of credit hours included in the Grade Point Average.	Recommended	xs:decimal
NoteMessage	Optional Repeatable	Additional information about the GPA	Not Recommended	minLength 1 maxLength 80
Comment:				
Comment:				

Code illustration:

```
<GPA>  
  <CreditHoursAttempted>159</CreditHoursAttempted>  
  <CreditHoursEarned>136</CreditHoursEarned>  
  <CreditUnit>Semester</CreditUnit>  
  <GradePointAverage>3.0915</GradePointAverage>  
  <TotalQualityPoints>473</TotalQualityPoints>  
  <CreditHoursforGPA>153</CreditHoursforGPA>  
</GPA>
```

Student.AcademicRecord.AcademicSession.AcademicSummary.AcademicHonors

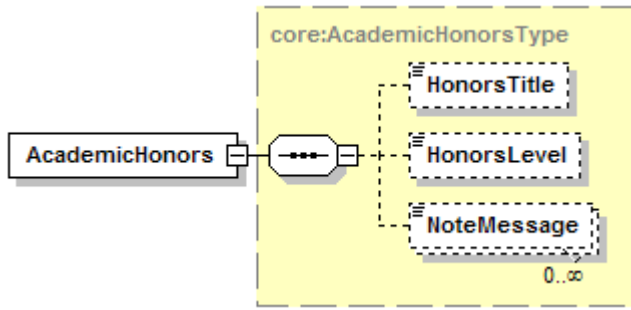

Tag Name	Schema Use	Description	Recommended Use	Format
HonorsTitle	Optional	The descriptive title for the honors received.	Recommended	minLength 1 maxLength 30
HonorsLevel	Optional	A code value representing 1st highest honor, 2nd highest and 3rd highest.	Not Recommended	Enumeration: FirstHighest SecondHighest ThirdHighest
NoteMessage	Optional Repeatable	Additional information about the honors	Not Recommended	minLength 1 maxLength 80
Comment:				
Comment:				

Code illustration:

```

<AcademicHonors>
  <HonorsTitle>Cum Laude</HonorsTitle>
  <HonorsLevel>ThirdHighest</HonorsLevel>
</AcademicHonors>
    
```

Student.AcademicRecord.AcademicSession.AcademicSummary.AcademicProgram

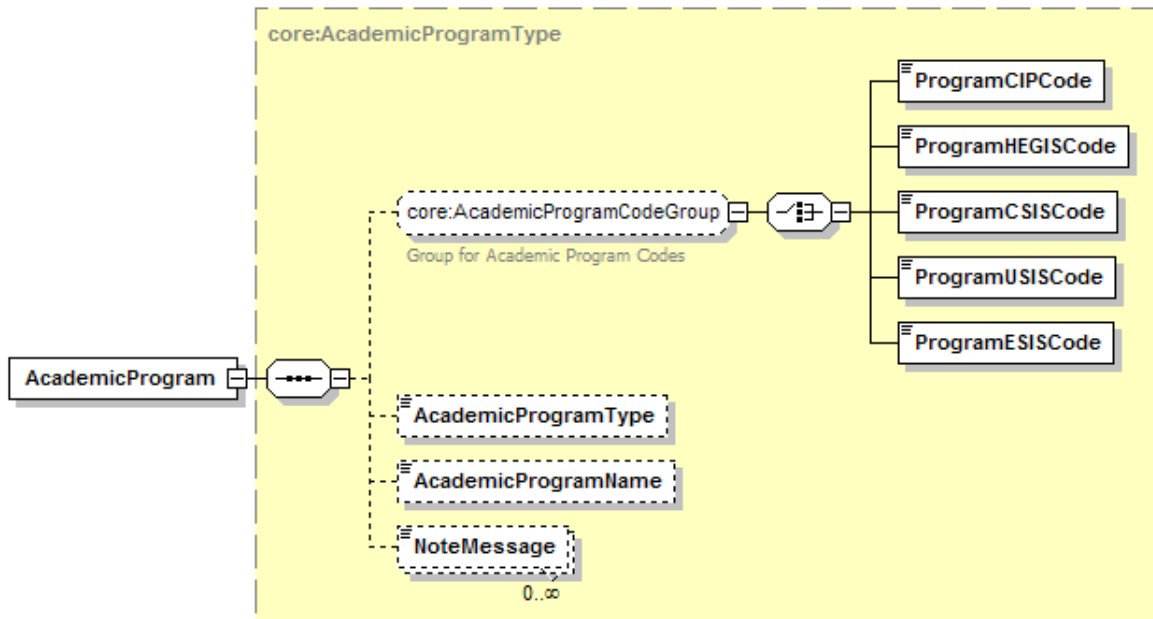

Tag Name	Schema Use	Description	Recommended Use	Format
ProgramCIPCode	Optional exclusive choice	Code indicating a discipline or field of study assigned by the Classification of Instructional Programs	Recommended (use one)	minLength 6 maxLength 20
ProgramHEGISCode	Optional exclusive choice	Code indicating a discipline or field of study assigned by Higher Education General Information Survey	Recommended (use one)	minLength 6 maxLength 20
ProgramCSISCode	Optional exclusive choice	Code indicating a discipline or field of study assigned by Statistics Canada Canadian College Student Information System	Recommended (use one)	minLength 5 maxLength 5
ProgramUSISCode	Optional exclusive choice	Code indicating a discipline or field of study assigned by the Statistics Canada University Student Information System.	Recommended (use one)	minLength 5 maxLength 5
ProgramESISCode	Optional exclusive choice	Code indicating a discipline or field of study assigned by the Statistics Canada Enhanced Student Information System.	Recommended (use one)	minLength 1 maxLength 20
AcademicProgramType	Optional	Indicates whether the academic program is a major, minor, area of concentration or specialization.	Recommended	Enumeration: Concentration Major Minor Specialization
AcademicProgramName	Optional	Literal name of program, major, or field of study.	Recommended	minLength 1 maxLength 60
NoteMessage	Optional Repeatable	Additional information about the Academic Program	Not Recommended	minLength 1 maxLength 80
Comment:				
Comment:				

Code illustration:

```
<AcademicProgram>  
  <ProgramCIPCode>123456</ProgramCIPCode>  
  <AcademicProgramType>Major</AcademicProgramType>  
  <AcademicProgramName>[need text]</AcademicProgramName>  
  <NoteMessage>String</NoteMessage>  
</AcademicProgram>
```

Student.AcademicRecord.Course

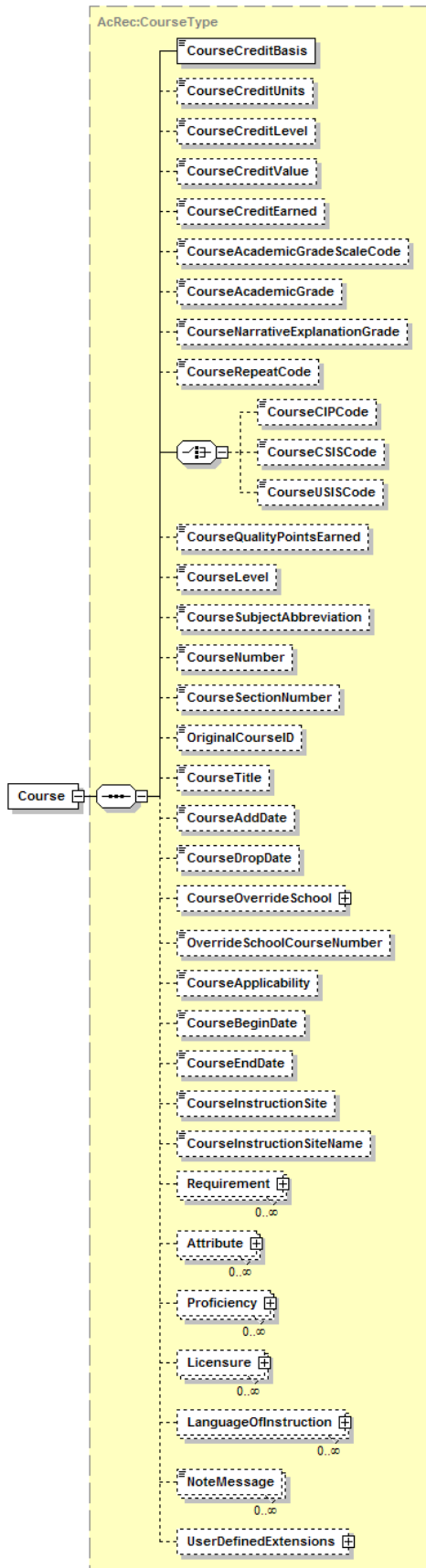

Tag Name	Schema Use	Description	Recommended Use	Format
CourseCreditBasis	Required	The type of enrollment associated with the credit hours for the course.	Required	Enumeration: Regular Major AcademicRenewal AdultBasic AdvancedPlacement AdvancedStanding ContinuingEducation Exemption Equivalence InternationalBaccalaureate Military Remedial CreditByExam HighSchoolTransferCredit HighSchoolCreditOnly HighSchoolDualCredit
CourseCreditUnits	Optional	The type of credit (unit, semester, or quarter) associated with the credit hours earned for the course.	Recommended	Enumeration: NoCredit Quarter Semester Units ClockHours CarnegieUnits ContinuingEducationUnits Unreported Other
CourseCreditLevel	Optional	The level of credit associated with the credit hours earned for the course.	Recommended	Enumeration: Undergraduate LowerDivision UpperDivision Vocational TechnicalPreparatory Graduate Professional Dual GraduateProfessional
CourseCreditValue	Optional	Number indicating the credit hours that may be earned in the course.	Recommended	xs:decimal
CourseCreditEarned	Optional	The number of credits a student earns by the successful completion of a course.	Recommended	xs:decimal
CourseAcademicGradeScaleCode	Optional	The grading scale used by an academic educational institution for an academic course.	Recommended	minLength 1 maxLength 3 See Appendix E
CourseAcademicGrade	Optional	The final grade awarded for participation in the course.	Recommended	minLength 1 maxLength 10
CourseNarrativeExplanationGrade	Optional	The narrative of the grade awarded to a student in an academic course in those cases where a course does not receive a letter or numeric grade included in the grading scale of the Course Academic Grade Qualifier.	Not Recommended	minLength 1 maxLength 200
CourseRepeatCode	Optional	Indicates that an academic course has been repeated by a student and how that repeat is to be computed in the student's academic grade average.	Recommended	Enumeration: RepeatCounted RepeatNotCounted ReplacementCounted ReplacedNotCounted RepeatOtherInstitution NotCountedOther

CourseCIPCode	Optional Choice required	The Classification of Instructional Programs (CIP) code to describe the area of study for the course.	Optional (use one)	minLength 1 maxLength 10
CourseCSISCode	Optional Choice required	The Statistics Canada Canadian College Student Information System (CCSIS) code to describe the area of study for the course.	Optional (use one)	minLength 1 maxLength 10
CourseUSISCode	Optional Choice required	The Statistics Canada University Student Information System (USIS) code to describe the area of study for the course.	Optional (use one)	minLength 1 maxLength 10
CourseQualityPointsEarned	Optional	The numerical value assigned to a letter grade to provide a basis of quantitative determination of an average.	Recommended	xs:decimal
CourseLevel	Optional	The level of work which is reflected in the credits associated with the academic course being described or the level of the typical student taking the academic course.	Recommended	Enumeration: LowerDivision UpperDivision Dual GraduateProfessional Remedial
CourseSubjectAbbreviation	Optional	The alphabetic abbreviation of the academic department or discipline offering the course. It is one part of the total course identifier number.	Recommended	minLength 1 maxLength 10
CourseNumber	Optional	The official reference number portion of a course identifier. This number normally designates the level of the course as well as the level of the student expected to enroll in the course.	Recommended	minLength 1 maxLength 15
CourseSectionNumber	Optional	The number assigned to differentiate among distinct occurrences of courses that have the same course abbreviation and number but are considered to be different courses.	Optional	minLength 1 maxLength 10
OriginalCourseID	Optional	The course ID as it was listed when the credit was earned (e.g. before a system conversion) to show consistency between present transcripts and older ones.	Recommended	minLength 1 maxLength 30
CourseTitle	Optional	The name or title of the course taken by a student at an academic institution.	Recommended	minLength 1 maxLength 60
CourseAddDate	Optional	The date a student was added to an academic course at a school.	Optional	xs:date
CourseDropDate	Optional	The date on which the student drops or withdraws from the course.	Optional	xs:date
CourseOverrideSchool	Optional	The school at which this particular course was taken.	Conditional	
Comment: If this course was taken at the school already noted above as the school in the Student Academic Record, then this data element is not used. It is only used to identify a specific course taken at a school other than the primary one described for the Student Academic Record.				
OverrideSchoolCourseNumber	Optional	This is the course number used at the Course Override School to identify this course.	Conditional	minLength 1 maxLength 35

	Comment: <i>OverrideSchoolCourseNumber will normally be formatted as Course Abbreviation followed by Course Number and then followed by the course suffix, if there is one. This field is used only if the CourseOverrideSchool above is included.</i>			
	Comment: <i>CourseOverrideSchool and OverrideSchoolCourseNumber are normally used for situations like consortiums, concurrent enrollment or transfer courses, although transfer work is recommended to be reported in a separate session with an override school.</i>			
CourseApplicability	Optional	The academic program to which this academic course applies toward graduation.	Not Recommended	Enumeration: NotApplicable FirstProgram SecondProgram BothPrograms
CourseBeginDate	Optional	Begin date	Recommended	xs:date
CourseEndDate	Optional	End date	Recommended	xs:date
CourseInstructionSite	Optional	An indication of the type of location at which the course is taught.	Optional	Enumeration: OnCampus OffCampus Extension StudyAbroad Correctional Military Telecommunication Auxiliary ClinicHospital
CourseInstructionSiteName	Optional	The name of the location at which the course is taught.	Optional	minLength 1 maxLength 30
Requirement	Optional Repeatable	A requirement for an academic award or other institution or agency award that is met by successful completion of this course.	Optional	
Attribute	Optional Repeatable	A special attribute of this course that may be used to meet special institutional requirements.	Optional	
Proficiency	Optional Repeatable	A proficiency that may be partially or totally demonstrated by successful completion of this course.	Optional	
Licensure	Optional Repeatable	Licensure requirements that may be partially or totally met by successful completion of this course.	Optional	
LanguageOfInstruction	Optional Repeatable	The language primarily used in the instruction of this course.	Optional	
	Comment: <i>If LanguageOfInstruction is not indicated, it is assumed to be primary language of the country or province where the institution is located. For United States institutions, it is assumed to be English.</i>			
NoteMessage	Optional Repeatable	Additional information about the course	Not Recommended	minLength 1 maxLength 80
UserDefinedExtensions	Optional	Additional structured information. Requires mutually defined XML schema.	Optional	
Comment:				

Code illustration:

```

<Course>
  <CourseCreditBasis>Regular</CourseCreditBasis>
  <CourseCreditUnits>Semester </CourseCreditUnits>
  <CourseCreditLevel>LowerDivision</CourseCreditLevel>
  <CourseCreditValue>3</CourseCreditValue>
  <CourseCreditEarned>3</CourseCreditEarned>
  <CourseAcademicGradeScaleCode>25</CourseAcademicGradeScaleCode>
  <CourseAcademicGrade>A</CourseAcademicGrade>
  <CourseNarrativeExplanationGrade>text</CourseNarrativeExplanationGrade>
  <CourseRepeatCode>NotCountedOther</CourseRepeatCode>
  <CourseCIPCode>999</CourseCIPCode>
  <CourseQualityPointsEarned>12</CourseQualityPointsEarned>
  <CourseLevel>LowerDivision</CourseLevel>
  <CourseSubjectAbbreviation>HIS</CourseSubjectAbbreviation>
  <CourseNumber>315K</CourseNumber>
  <CourseSectionNumber>text</CourseSectionNumber>
  <OriginalCourseID>HIST 105</OriginalCourseID>
  <CourseTitle>HISTORY OF THE US 1</CourseTitle>
  <CourseAddDate>2005-09-01</CourseAddDate>
  <CourseDropDate>2005-09-08</CourseDropDate>
  <CourseOverrideSchool>
*
*
    </CourseOverrideSchool>
    <OverrideSchoolCourseNumber>HST 26A</OverrideSchoolCourseNumber>
    <CourseApplicability>NotApplicable</CourseApplicability>
    <CourseBeginDate>2005-09-01</CourseBeginDate>
    <CourseEndDate>2005-12-07</CourseEndDate>
    <CourseInstructionSite>OnCampus</CourseInstructionSite>
    <CourseInstructionSiteName>text</CourseInstructionSiteName>
    <Requirement>
*
*
      </Requirement>
      <Attribute>
*
*
        </Attribute>
        <Proficiency>
*
*
          </Proficiency>
          <Licensure>
*
*
            </Licensure>
            <LanguageOfInstruction>
*
*
              </LanguageOfInstruction>
              <NoteMessage>String</NoteMessage>
              <UserDefinedExtensions/>
</Course>

```

Student.AcademicRecord.Course.CourseOverrideSchool

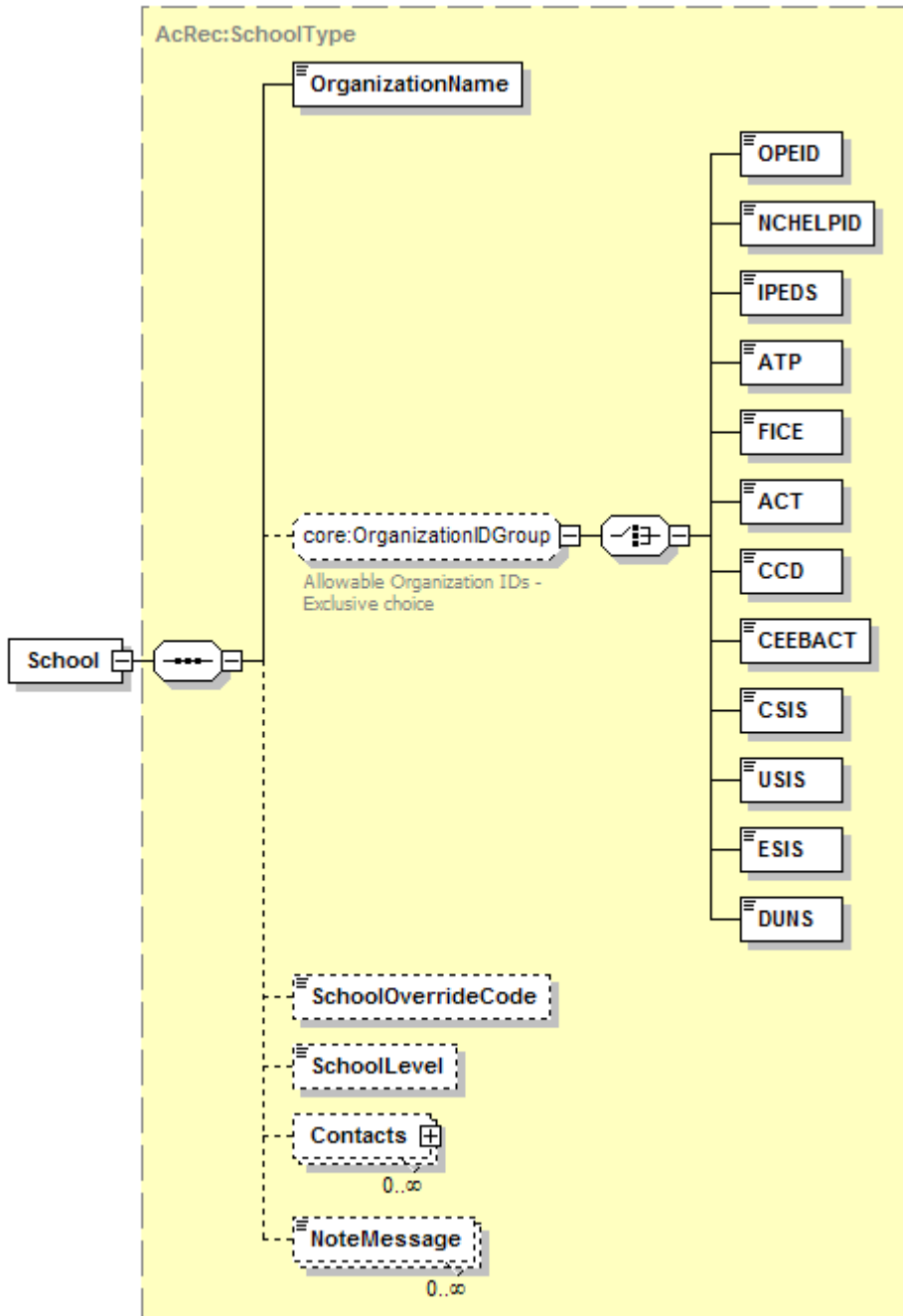

Tag Name	Schema Use	Description	Recommended Use	Format
OrganizationName	Required	Name of override school	Required	minLength 1 maxLength 60
OPEID	Required choice	The unique identifier assigned by the Office of Postsecondary Education for each data exchange partner.	Recommended (use one)	minLength 3 maxLength 8

NHELPIID	Required choice	The unique identifier assigned by National Council on Higher Education Loan Programs for each data exchange partner.	Recommended (use one)	minLength 3 maxLength 8
IPEDS	Required choice	The unique identifier assigned by the National Center for Education Statistics for the Integrated Postsecondary Education Data System for each postsecondary data exchange partner.	Recommended (use one)	minLength 6 maxLength 6
ATP	Required choice	The unique identifier assigned for the Admissions Testing Program by the College Board for each postsecondary data exchange partner.	Recommended (use one)	minLength 6 maxLength 6
FICE	Required choice	The unique identifier assigned for the Federal Interagency Committee on Education by the US Department of Education's National Center for Education Statistics for each postsecondary data exchange partner	Recommended (use one)	minLength 6 maxLength 6
ACT	Required choice	The unique identifier assigned by the American College Testing or ACT for each postsecondary data exchange partner. See www.act.org .	Recommended (use one)	minLength 4 maxLength 4
CCD	Required choice	The unique identifier assigned by the US Department of Education's National Center for Education Statistics as the Common Core of Data for each K12 data exchange partner.	Recommended (use one)	minLength 12 maxLength 12
CEEBACT	Required choice	The unique identifier assigned by the College Entrance Examining Board and ACT for each data exchange partner.	Recommended (use one)	minLength 6 maxLength 6
CSIS	Required choice	The unique identifier assigned by the Statistics Canada Canadian College Student Information System for each data exchange partner	Recommended (use one)	minLength 6 maxLength 6
USIS	Required choice	The unique identifier assigned by the Statistics Canada University Student Information System for each data exchange partner	Recommended (use one)	minLength 6 maxLength 6
ESIS	Required choice	The unique identifier assigned by the Statistics Canada Enhanced Student Information System for each data exchange partner.	Recommended (use one)	minLength 8 maxLength 8
DUNS	Required choice	Data Universal Numbering System (DUNS), unique nine character company identification number issued by Dun and Bradstreet Corporation.	Recommended (use one)	minLength 9 maxLength 9

SchoolOverrideCode	Optional	The source of the academic credit if not awarded by the home or parent institution. Institutional - Institutional Agreement Multicampus - Multiple Campus Course Offering Transfer - Transfer Credit StudyAbroad - Study Abroad Coop - Cooperative Program Reciprocal - Reciprocal Exchange Internship - Internship	Recommended	Enumeration: Institutional Multicampus Transfer StudyAbroad Coop Reciprocal Internship
SchoolLevel	Optional	Indicates level of Override School	Recommended	Enumeration: Elementary Secondary Postsecondary
Contacts	Optional Repeatable	Contact info at Override School	Optional	
NoteMessage	Optional Repeatable	Additional information about the Override School	Not Recommended	minLength 1 maxLength 80
	Comment:			
	Comment:			

Code illustration:

```

<School>
  <OrganizationName>TEXAS A&M UNIVERSITY COLLEGE STATION</OrganizationName>
  <ATP>006003</ATP>
  <SchoolOverrideCode>Transfer</SchoolOverrideCode>
  <SchoolLevel>Postsecondary</SchoolLevel>
  <Contacts>
*
*
  </Contacts>
</School>

```

Student.AcademicRecord.Course.CourseOverrideSchool.Contacts

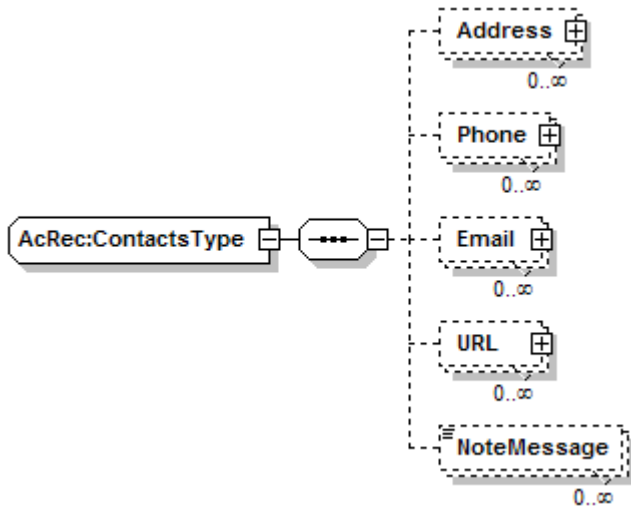

Tag Name	Schema Use	Description	Recommended Use	Format
Address	Optional Repeatable	Address of the Override School	Recommended	minOcc 0 maxOcc ∞
Phone	Optional Repeatable	Phone Number of the Override School	Optional	minOcc 0 maxOcc ∞
Email	Optional Repeatable	Email Address of the Override School	Optional	minOcc 0 maxOcc ∞
URL	Optional Repeatable	Universal Resouce Locator of the Override School	Optional	minOcc 0 maxOcc ∞
NoteMessage	Optional Repeatable	Additional information about the contacts at the Override School	Not Recommended	minLength 1 maxLength 80
	Comment:			
	Comment:			

Code illustration:

```

<Contacts>
  <Address>
  *
  *
  </Address>
  <Phone>
  *
  *
  </Phone>
  <Email>
  *
  *
  </Email>
  <URL>
  *
  *
  </URL>
  <NoteMessage/>
</Contacts>
    
```

Student.AcademicRecord.Course.CourseOverrideSchool.Contacts.Address

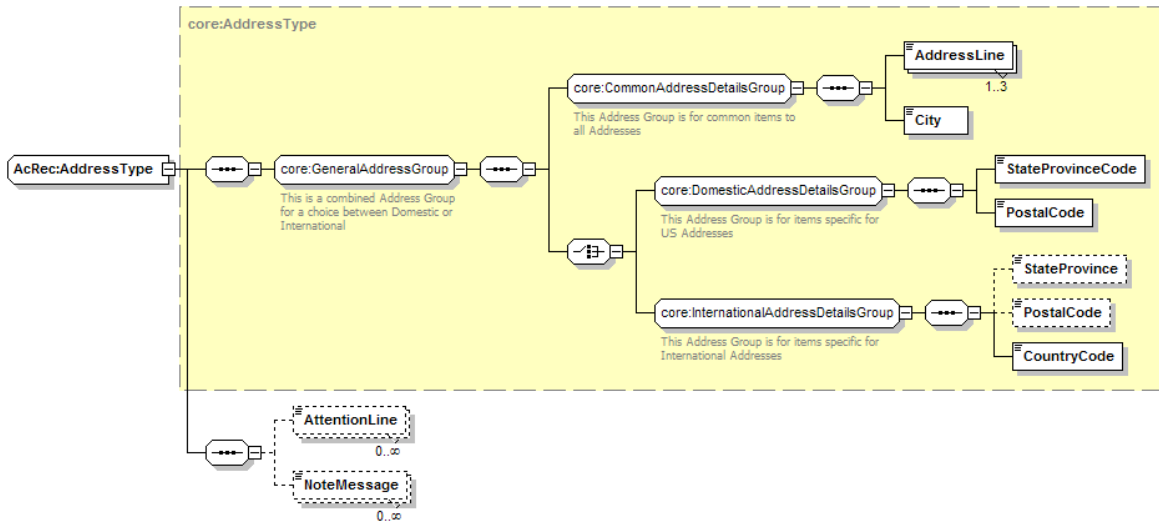

Tag Name	Schema Use	Description	Recommended Use	Format
CommonAddressDetailsGroup	Required	This Address Group is for items common to all Addresses	Required	minOcc 1 maxOcc 1
	Comment: [CommonAddressDetailsGroup] is not a tag and does not appear in the instance document. If the address of a contact is included in the transcript, then this must be sent. It is required and must be paired with one of either DomesticAddressDetailsGroup or InternationalAddressDetailsGroup.			
DomesticAddressDetailsGroup	Required choice	This Address Group is for items specific for US and Canadian Addresses	Required for domestic addresses	minOcc 1 maxOcc 1
	Comment: [DomesticAddressDetailsGroup] is not a tag and does not appear in the instance document. If the address has a United States or Canadian Postal Code and a US State or Canadian Province Code, then this should be the required choice.			
InternationalAddressDetailsGroup	Required choice	This Address Group is for items specific for International Addresses	Required for international addresses	minOcc 1 maxOcc 1
	Comment: [InternationalAddressDetailsGroup] is not a tag and does not appear in the instance document. This choice is for addresses that do not have a US or Canadian postal code.			
AttentionLine	Optional	The individual or office name within the postal address where inquiries should be directed.	Optional	minOcc 0 maxOcc ∞ minLength 1 maxLength 45
NoteMessage	Optional Repeatable	Additional information about the address	Not Recommended	minOcc 0 maxOcc ∞
	Comment:			
	Comment:			

Code illustration:

```
<Address>  
  <AddressLine>Office of the Registrar</AddressLine>  
  <AddressLine>1 University Station</AddressLine>  
  <City>Austin</City>  
  <StateProvinceCode>TX</StateProvinceCode>  
  <PostalCode>78712</PostalCode>  
  <AttentionLine>Jane Shaugness</AttentionLine>  
  <NoteMessage/>  
</Address>
```

Student.AcademicRecord.Course.CourseOverrideSchool.Contacts.Address.CommonAddressDetailsGroup

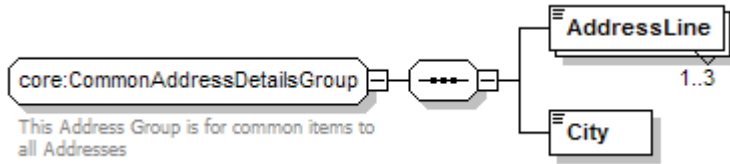

Tag Name	Schema Use	Description	Recommended Use	Format
AddressLine	Required Repeatable	Local delivery information such as street, building number, PO box, or apartment portion of a postal address.	Required	minOcc 1 maxOcc 3 minLength 1 maxLength 40
City	Required	The city portion of the Address.	Required	minOcc 1 maxOcc 1 minLength 2 maxLength 30
	Comment:			
	Comment:			

Code illustration:

```
<AddressLine>University of Oxford</AddressLine>
<AddressLine>Wellington Square</AddressLine>
<City>Oxford</City>
```

Student.AcademicRecord.Course.CourseOverrideSchool.Contacts.Address.DomesticAddressDetailsGroup

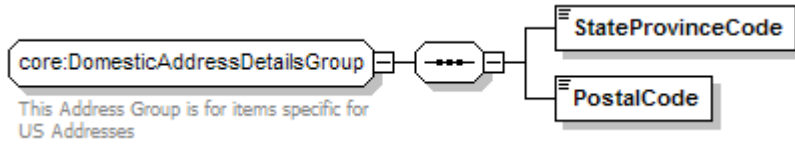

Tag Name	Schema Use	Description	Recommended Use	Format
StateProvinceCode	Required	Code for US states, etc., and Canadian provinces.	Required	See Appendix A
PostalCode	Required	The postal code portion of the Address.	Required	minLength 1 maxLength 17
Comment:				
Comment:				

Code illustration:

```
<StateProvinceCode>TX</StateProvinceCode>
<PostalCode>78712</PostalCode>
```

Student.AcademicRecord.Course.CourseOverrideSchool.Contacts.Address.InternationalAddressDetailsGroup

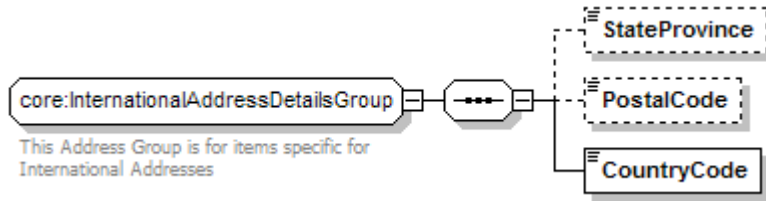

Tag Name	Schema Use	Description	Recommended Use	Format
StateProvince	Optional	The literal name of the state, province or territory of a postal address. Use for addresses outside US or Canada.	Optional	minLength 2 maxLength 30
		Comment: For an internet resource of states or other geographical subdivisions in countries other than the US and Canada, you might choose to refer to the website of the Universal Postal Union at http://www.upu.int		
PostalCode	Optional	The postal code portion of the Address.	Optional	minLength 1
		Comment: For an internet resource of states or other geographical subdivisions in countries other than the US and Canada, you might choose to refer to the website of the Universal Postal Union at http://www.upu.int		
CountryCode	Required	Code indicating Country. Use ISO 3166-1 alpha-2 standard.	Required	See Appendix B
		Comment:		
		Comment:		

Code illustration:

```
<PostalCode>0X1 2JD</PostalCode>
<CountryCode>GB</CountryCode>
```

Student.AcademicRecord.Course.CourseOverrideSchool.Contacts.Phone

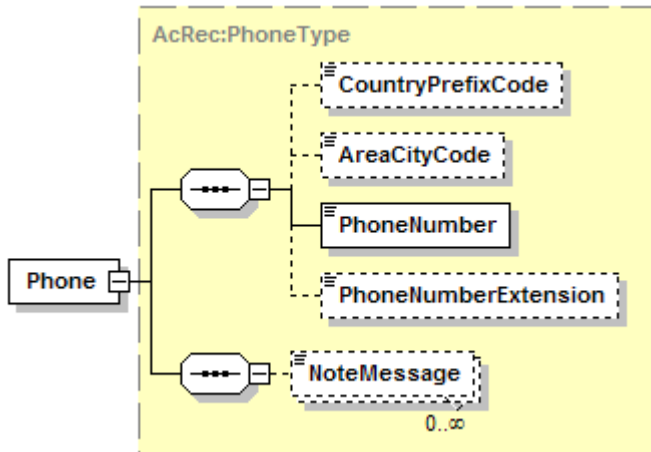

Tag Name	Schema Use	Description	Recommended Use	Format
CountryPrefixCode	Optional	International dialing code.	Optional	minLength 1 maxLength 3
AreaCityCode	Optional	Regional dialing code.	Recommended	minLength 1 maxLength 5
Comment: This is the 3 digit area code in the United States and Canada.				
PhoneNumber	Required	Telephone number.	Required	minLength 1 maxLength 11
PhoneNumberExtension	Optional	The extended telephone addressing information used in addition to phone number such as a PBX extension, a pager PIN, or FAX sub-address.	Optional	minLength 1 maxLength 5
NoteMessage	Optional Repeatable	Additional information about the phone number of the override school	Not recommended	minOcc 0 maxOcc ∞
Comment:				
Comment:				

Code illustration:

```

<Phone>
  <CountryPrefixCode/>
  <AreaCityCode>512</AreaCityCode>
  <PhoneNumber>4757638</PhoneNumber>
  <PhoneNumberExtension/>
  <NoteMessage/>
</Phone>
    
```

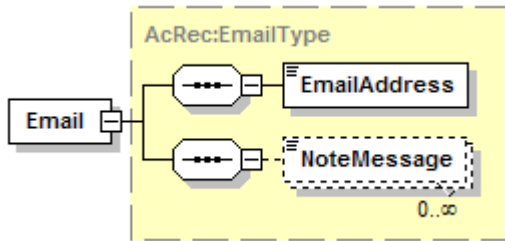
Student.AcademicRecord.Course.CourseOverrideSchool.Contacts.Email

Tag Name	Schema Use	Description	Recommended Use	Format
EmailAddress	Required	The numbers, letters, and symbols used to identify an electronic mail (Email) user within a network.	Required	minLength 1 maxLength 128
NoteMessage	Optional Repeatable	Additional information about the email address	Not recommended	minOcc 0 maxOcc ∞
Comment:				
Comment:				

Code illustration:

```

<Email>
  <EmailAddress/>
  <NoteMessage/>
</Email>

```

Student.AcademicRecord.Course.CourseOverrideSchool.Contacts.URL

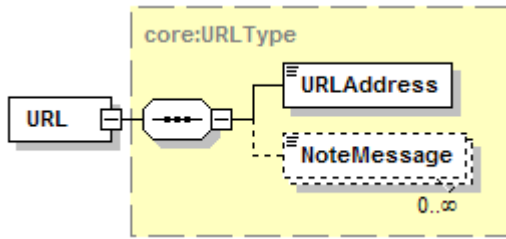

Tag Name	Schema Use	Description	Recommended Use	Format
URLAddress	Required	The Uniform Resource Locator (URL) address associated with a product, deliverable or contact.	Required	minLength 0 maxLength 512
NoteMessage	Optional Repeatable	Additional information about the URL	Not Recommended	minLength 1 maxLength 80
	Comment:			
	Comment:			

Code illustration:

```

<URL>
  <URLAddress/>
  <NoteMessage/>
</URL>
    
```

Student.AcademicRecord.Course.Requirement

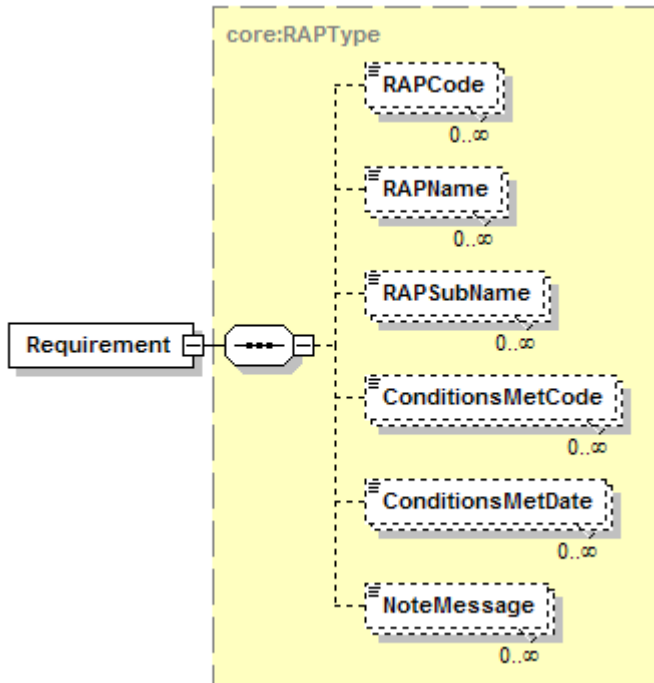

Tag Name	Schema Use	Description	Recommended Use	Format
RAPCode	Optional Repeatable	Requirement demonstrated or earned in addition to academic award.	Recommended	minLength 1 maxLength 3
RAPName	Optional Repeatable	Literal name of requirement	Recommended	minLength 1 maxLength 60
RAPSubName	Optional Repeatable	Literal name of subsection of requirement	Optional	minLength 1 maxLength 60
ConditionsMetCode	Optional Repeatable	Indicates whether and how conditions for certification have been attained.	Recommended	Enumeration: Yes No Conditional MutuallyDefined
ConditionsMetDate	Optional Repeatable	Date of requirement	Optional	xs:date
NoteMessage	Optional Repeatable	Additional information about the requirement	Not Recommended	minLength 1 maxLength 80
Comment:				
Comment:				

Code illustration:

```

<Requirement>
  <RAPCode>9TX</RAPCode>
  <RAPName>TXCORECURR</RAPName>
  <RAPSubName>030Natural Sciences - C1</RAPSubName>
  <ConditionsMetCode>Yes</ConditionsMetCode>
  <ConditionsMetDate>2002-08-13</ConditionsMetDate>
</Requirement>
    
```

Student.AcademicRecord.Course.Attribute

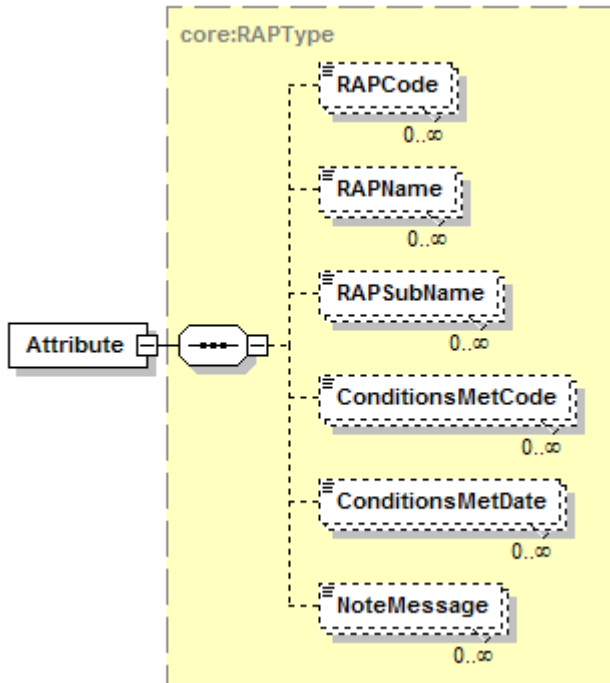

Tag Name	Schema Use	Description	Recommended Use	Format
RAPCode	Optional Repeatable	Attribute demonstrated or earned in addition to academic award.	Recommended	minLength 1 maxLength 3
RAPName	Optional Repeatable	Literal name of attribute	Recommended	minLength 1 maxLength 60
RAPSubName	Optional Repeatable	Literal name of subsection of attribute	Optional	minLength 1 maxLength 60
ConditionsMetCode	Optional Repeatable	Indicates whether and how conditions for certification have been attained.	Recommended	Enumeration: Yes No Conditional MutuallyDefined
ConditionsMetDate	Optional Repeatable	Date of attribute	Optional	
NoteMessage	Optional Repeatable	Additional information about the attribute	Not Recommended	minLength 1 maxLength 80
	Comment:			
	Comment:			

Code illustration:

```

<Attribute>
  <RAPCode>9TX</RAPCode>
  <RAPName>TXCORECURR</RAPName>
  <RAPSubName>030Natural Sciences - C1</RAPSubName>
  <ConditionsMetCode>Yes</ConditionsMetCode>
  <ConditionsMetDate>2002-08-13</ConditionsMetDate>
</Attribute>
    
```

Student.AcademicRecord.Course.Proficiency

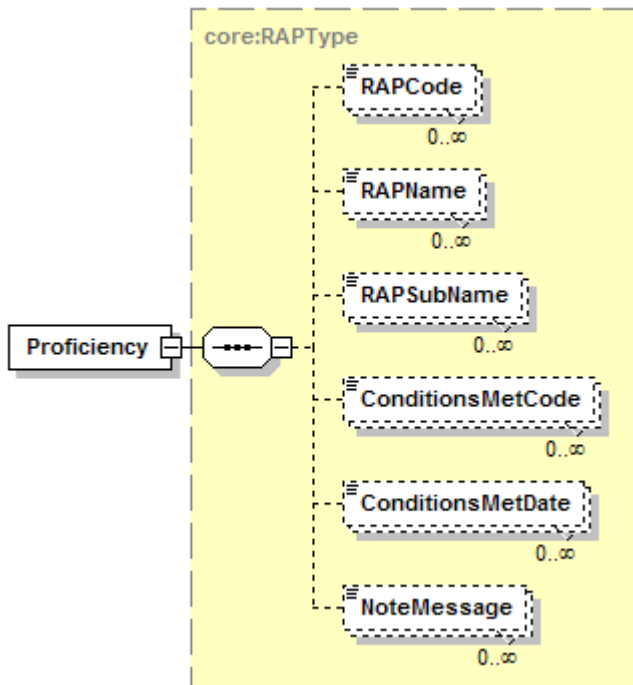

Tag Name	Schema Use	Description	Recommended Use	Format
RAPCode	Optional Repeatable	Proficiency demonstrated or earned in addition to academic award.	Recommended	minLength 1 maxLength 3
RAPName	Optional Repeatable	Literal name of proficiency	Recommended	minLength 1 maxLength 60
RAPSubName	Optional Repeatable	Literal name of subsection of proficiency	Optional	minLength 1 maxLength 60
ConditionsMetCode	Optional Repeatable	Indicates whether and how conditions for certification have been attained.	Recommended	Enumeration: Yes No Conditional MutuallyDefined
ConditionsMetDate	Optional Repeatable	Date of proficiency	Optional	
NoteMessage	Optional Repeatable	Additional information about the proficiency	Not Recommended	minLength 1 maxLength 80
	Comment:			
	Comment:			

Code illustration:

```

<Proficiency>
  <RAPCode>9TX</RAPCode>
  <RAPName>TXCORECURR</RAPName>
  <RAPSubName>030Natural Sciences - C1</RAPSubName>
  <ConditionsMetCode>Yes</ConditionsMetCode>
  <ConditionsMetDate>2002-08-13</ConditionsMetDate>
</Proficiency>
    
```

Student.AcademicRecord.Course.Licensure

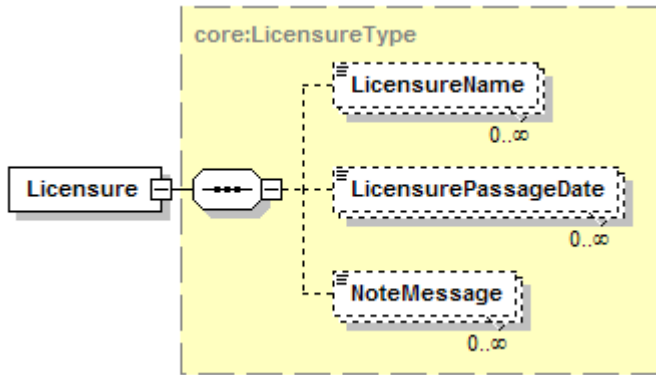

Tag Name	Schema Use	Description	Recommended Use	Format
LicensureName	Optional Repeatable	Free-form name of license or certification.	Recommended	minLength 1 maxLength 60
LicensurePassageDate	Optional Repeatable	Date of licensure passage	Not Recommended	xs:date
NoteMessage	Optional Repeatable	Additional information about the licensure	Not Recommended	minLength 1 maxLength 80
	Comment:			
	Comment:			

Code illustration:

```

<Licensure>
  <LicensureName>Occupational Therapy Assistant</LicensureName>
  <LicensurePassageDate>1992-05-20</LicensurePassageDate>
  <NoteMessage/>
</Licensure>
    
```

Student.AcademicRecord.Course.LanguageOfInstruction

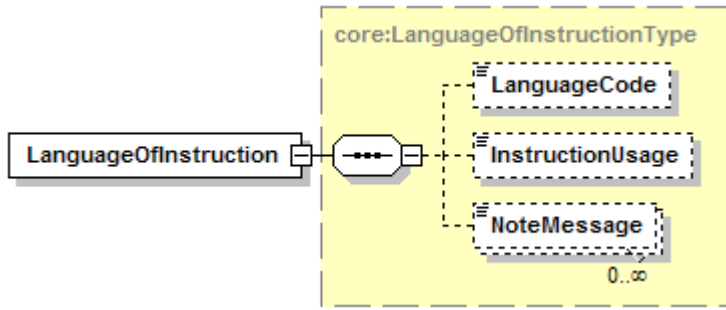

Tag Name	Schema Use	Description	Recommended Use	Format
LanguageCode	Optional	Code indicating the language being used, using ISO 639-2 code (Alpha-3) set. These codes are available at http://www.loc.gov/standards/iso639-2/	Recommended	minLength 3 maxLength 3
InstructionUsage	Optional	The use of the language in the context of instruction. Instruction - Language of Instruction Examination - Language of Examination WrittenExam - Language in which Examination is written	Recommended	Enumeration: Instruction Examination WrittenExam
NoteMessage	Optional Repeatable	Additional information about the language of instruction	Not Recommended	minLength 1 maxLength 80
Comment:				
Comment:				

Code illustration:

```

<LanguageOfInstruction>
  <LanguageCode>fre</LanguageCode>
  <InstructionUsage>Examination</InstructionUsage>
  <NoteMessage/>
</LanguageOfInstruction>
    
```

Student.AcademicRecord.AdditionalStudentAchievements

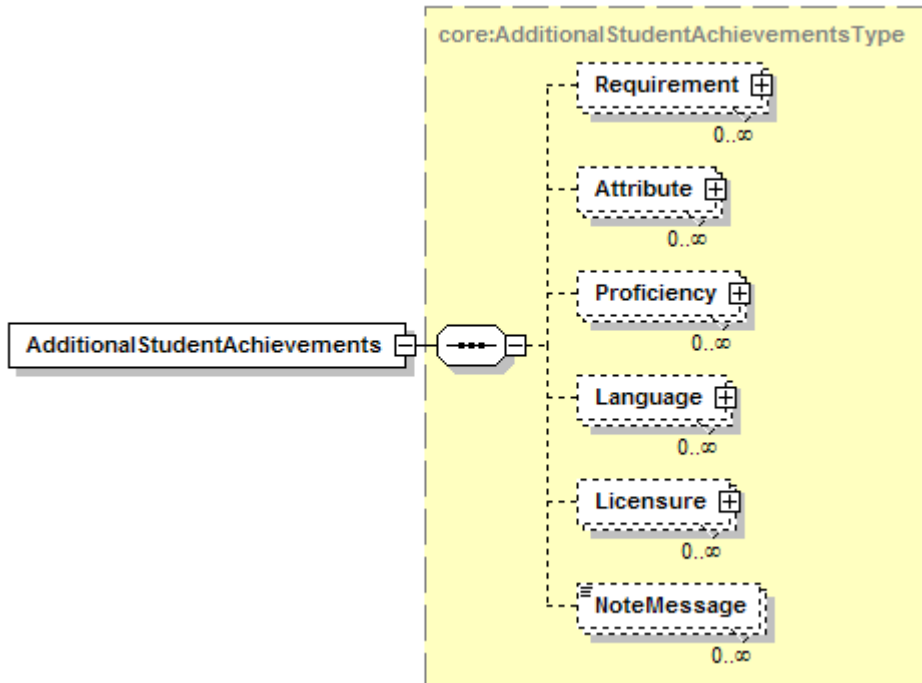

Tag Name	Schema Use	Description	Recommended Use	Format
Requirement	Optional Repeatable	Curriculum requirements satisfied by successful completion of the Additional Student Achievement	Optional	
Attribute	Optional Repeatable	Attributes of the Additional Student Achievement which may require special handling by the receiving institution	Optional	
Proficiency	Optional Repeatable	Proficiency level signified by successful completion of the Additional Student Achievement	Optional	
Language	Optional Repeatable	Language associated with one or more aspects of the Additional Student Achievement	Optional	
Licensure	Optional Repeatable	Licensure requirements satisfied by successful completion of the Additional Student Achievement	Optional	
NoteMessage	Optional Repeatable	Additional information about the Additional Student Achievement	Not Recommended	minLength 1 maxLength 80

Comment:

Comment: The use of the Requirement, Attribute and Proficiency fields is normally based on previously made agreements between or among selected trading partners (usually within a state or region). For example, a specific state might have a requirement for computer competency. That state might use a requirement code of TXA, where TX is the state code and A designates the computer competency requirement. Another state might wish to identify an attribute of the student that indicates the student is the first in his or her family to attend a postsecondary institution. This attribute might be identified with a state code of IA and the attribute code of B. This attribute would be based on prior agreements among states, and it provides a great deal of flexibility to exchange previously specified data within a state or region.

Code illustration:

```
<AdditionalStudentAchievements>
  <Requirement>
*
*
    </Requirement>
    <Attribute>
*
*
      </Attribute>
      <Proficiency>
*
*
        </Proficiency>
        <Language>
*
*
          </Language>
          <Licensure>
*
*
            </Licensure>
            <NoteMessage/>
  </AdditionalStudentAchievements>
```

Student.AcademicRecord.AdditionalStudentAchievements.Requirement

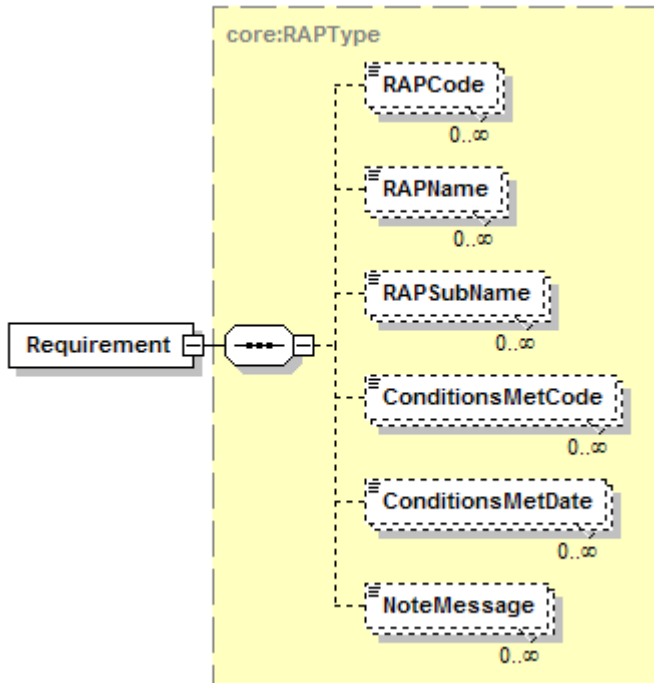

Tag Name	Schema Use	Description	Recommended Use	Format
RAPCode	Optional Repeatable	Requirement demonstrated or earned.	Recommended	minLength 1 maxLength 3
RAPName	Optional Repeatable	Literal name of requirement	Recommended	minLength 1 maxLength 60
RAPSubName	Optional Repeatable	Literal name of subsection of requirement	Optional	minLength 1 maxLength 60
ConditionsMetCode	Optional Repeatable	Indicates whether and how conditions for certification have been attained.	Recommended	Enumeration: Yes No Conditional MutuallyDefined
ConditionsMetDate	Optional Repeatable	Date of requirement	Recommended	xs:date
NoteMessage	Optional Repeatable	Additional information about the requirement	Not Recommended	minLength 1 maxLength 80
Comment:				
Comment:				

Code illustration:

```

<Requirement>
  <RAPCode>9TX</RAPCode>
  <RAPName>TXCORECURR</RAPName>
  <RAPSubName>030Natural Sciences - C1</RAPSubName>
  <ConditionsMetCode>Yes</ConditionsMetCode>
  <ConditionsMetDate>2002-08-13</ConditionsMetDate>
</Requirement>
    
```

Student.AcademicRecord.AdditionalStudentAchievements.Attribute

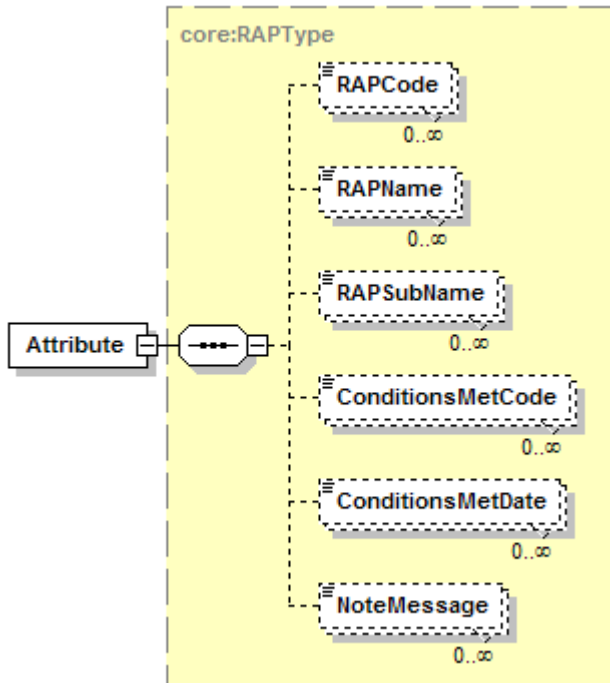

Tag Name	Schema Use	Description	Recommended Use	Format
RAPCode	Optional Repeatable	Attribute demonstrated or earned	Recommended	minLength 1 maxLength 3
RAPName	Optional Repeatable	Literal name of attribute	Recommended	minLength 1 maxLength 60
RAPSubName	Optional Repeatable	Literal name of subsection of attribute	Optional	minLength 1 maxLength 60
ConditionsMetCode	Optional Repeatable	Indicates whether and how conditions for certification have been attained.	Recommended	Enumeration: Yes No Conditional MutuallyDefined
ConditionsMetDate	Optional Repeatable	Date of attribute	Recommended	
NoteMessage	Optional Repeatable	Additional information about the attribute	Not Recommended	minLength 1 maxLength 80
	Comment:			
	Comment:			

Code illustration:

```

<Attribute>
  <RAPCode>9TX</RAPCode>
  <RAPName>TXCORECURR</RAPName>
  <RAPSubName>030Natural Sciences - C1</RAPSubName>
  <ConditionsMetCode>Yes</ConditionsMetCode>
  <ConditionsMetDate>2002-08-13</ConditionsMetDate>
</Attribute>
    
```

Student.AcademicRecord.AdditionalStudentAchievements.Proficiency

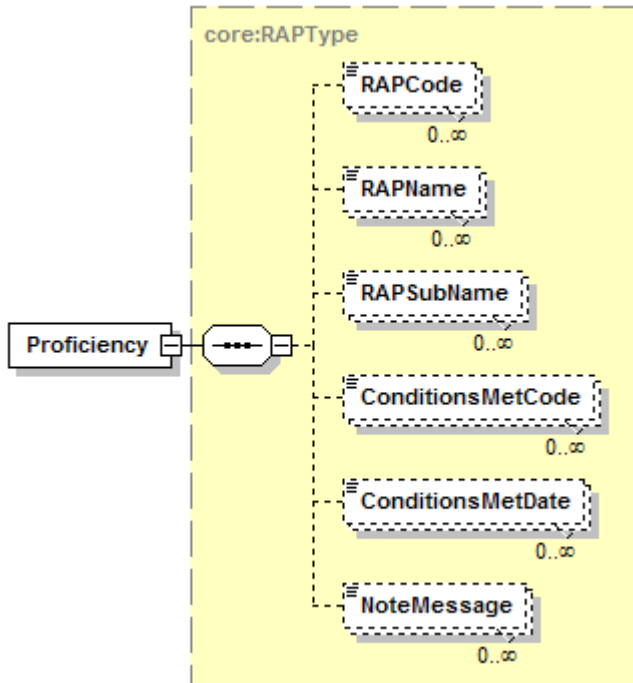

Tag Name	Schema Use	Description	Recommended Use	Format
RAPCode	Optional Repeatable	Proficiency demonstrated or earned	Recommended	minLength 1 maxLength 3
RAPName	Optional Repeatable	Literal name of proficiency	Recommended	minLength 1 maxLength 60
RAPSubName	Optional Repeatable	Literal name of subsection of proficiency	Optional	minLength 1 maxLength 60
ConditionsMetCode	Optional Repeatable	Indicates whether and how conditions for certification have been attained.	Recommended	Enumeration: Yes No Conditional MutuallyDefined
ConditionsMetDate	Optional Repeatable	Date of proficiency	Recommended	
NoteMessage	Optional Repeatable	Additional information about the proficiency	Not Recommended	minLength 1 maxLength 80
Comment:				
Comment:				

Code illustration:

```

<Proficiency>
  <RAPCode>9TX</RAPCode>
  <RAPName>TXCORECURR</RAPName>
  <RAPSubName>030Natural Sciences - C1</RAPSubName>
  <ConditionsMetCode>Yes</ConditionsMetCode>
  <ConditionsMetDate>2002-08-13</ConditionsMetDate>
</Proficiency>
    
```

Student.AcademicRecord.AdditionalStudentAchievements.Language

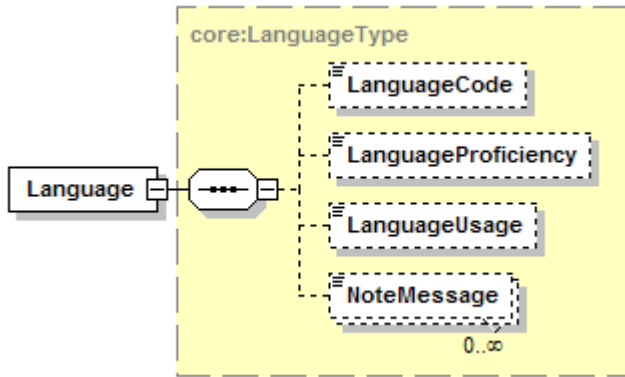

Tag Name	Schema Use	Description	Recommended Use	Format
LanguageCode	Optional	Code indicating the language being used, using ISO 639-2 code (Alpha-3) set. These codes are available at http://www.loc.gov/standards/iso639-2/	Recommended	minLength 3 maxLength 3
LanguageProficiency	Optional	Adeptness in comprehending and using the language	Recommended	Enumeration: Excellent Good Fair Poor Unacceptable Unknown
LanguageUsage	Optional	Indication of person's use of the language	Recommended	Enumeration: SpokenAtHome Reading Writing Speaking Native
NoteMessage	Optional Repeatable	Additional information about the language proficiency	Not Recommended	minLength 1 maxLength 80
Comment:				
Comment:				

Code illustration:

```

<Language>
  <LanguageCode>rus</LanguageCode>
  <LanguageProficiency>Excellent</LanguageProficiency>
  <LanguageUsage>Speaking</LanguageUsage>
  <NoteMessage/>
</Language>
    
```

Student.AcademicRecord.AdditionalStudentAchievements.Licensure

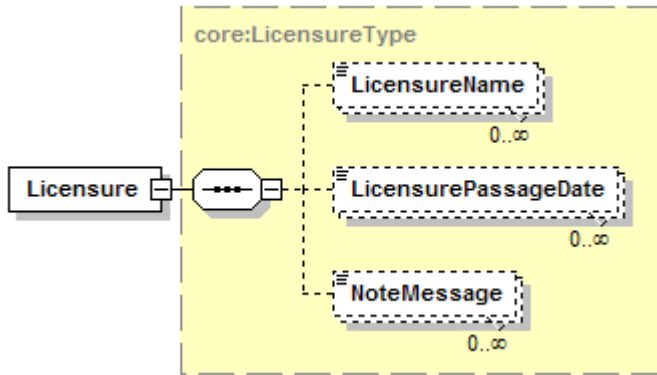

Tag Name	Schema Use	Description	Recommended Use	Format
LicensureName	Optional Repeatabe	Free-form name of license or certification.	Recommended	minLength 1 maxLength 60
LicensurePassageDate	Optional Repeatabe	Date of licensure passage	Recommended	xs:date
NoteMessage	Optional Repeatabe	Additional information about the licensure	Not Recommended	minLength 1 maxLength 80
	Comment:			
	Comment:			

Code illustration:

```

<Licensure>
  <LicensureName>Texas Real Estate Sales</LicensureName>
  <LicensurePassageDate>1986-03-12</LicensurePassageDate>
  <NoteMessage/>
</Licensure>
    
```

Student.Health

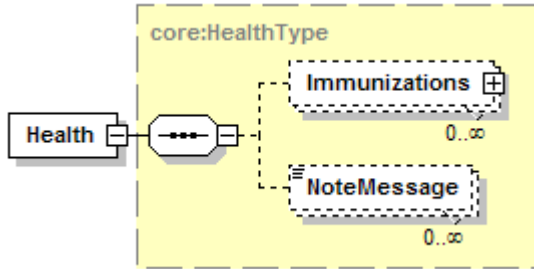

Tag Name	Schema Use	Description	Recommended Use	Format
Immunizations	Optional Repeatable	Information about immunizations	Recommended	
NoteMessage	Optional Repeatable	Additional information about immunizations	Not Recommended	minLength 1 maxLength 80
Comment:				
<i>Comment: Although most colleges and universities do not maintain these data in the student record system, if the data are available, the inclusion of the data might assist the receiving institution in satisfying an immunization requirement at that school.</i>				

Code illustration:

```

    <Health>
      <Immunizations>
*
*
      </Immunizations>
    <NoteMessage/>
  </Health>
  
```

Student.Health.Immunizations

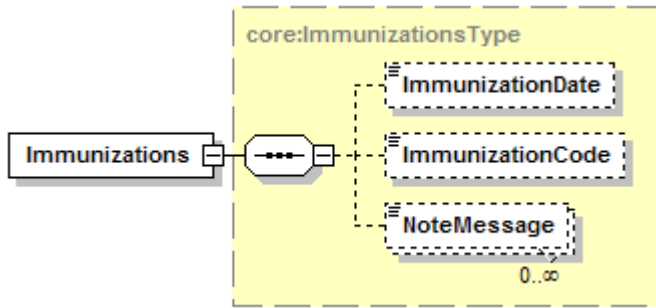

Tag Name	Schema Use	Description	Recommended Use	Format
ImmunizationDate	Optional	Date of immunization	Recommended	
ImmunizationCode	Optional	Medical immunization or vaccine code from the Current Procedural Terminology (CPT) 2002 of the American Medical Association.	Recommended	
NoteMessage	Optional Repeatable	Additional information about the immunization	Not Recommended	minLength 1 maxLength 80
	<i>Comment:</i>			
	<i>Comment:</i>			

Code illustration:

```

<Immunizations>
  <ImmunizationDate>1981-04-30</ImmunizationDate>
  <ImmunizationCode>90705</ImmunizationCode>
  <NoteMessage/>
</Immunizations>
    
```

Student.Tests

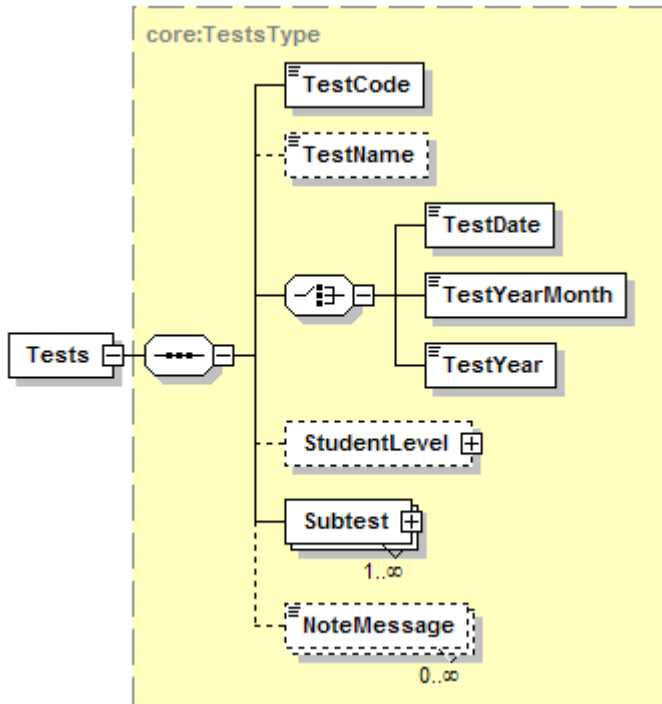

Tag Name	Schema Use	Description	Recommended Use	Format
TestCode	Required	Code identifying the test	Required	See Appendix C
TestName	Optional	Name identifying the test	Recommended	See Appendix C
TestDate	Required choice	Date of the test	Required (use one)	ccyy-mm-dd
TestYearMonth	Required choice	Date of the test	Required (use one)	ccyy-mm
TestYear	Required choice	Date of the test	Required (use one)	ccyy
StudentLevel	Optional	The classification of the student at the time the student took the test	Not Recommended	
Subtest	Required Repeatable	Subdivision of a standardized test (including the score)	Required	
NoteMessage	Optional Repeatable	Additional information about the test	Not Recommended	minLength 1 maxLength 80
	Comment:			
	Comment:			

Code illustration:

```
<Tests>
  <TestCode>809</TestCode>
  <TestName>TEST OF ENGLISH AS A FOREIGN LANGUAGE (TOEFL)</TestName>
  <TestYearMonth>1988-04</TestYearMonth>
  <StudentLevel>
*
*
    </StudentLevel>
  <Subtest>
*
*
    </Subtest>
  <NoteMessage/>
</Tests>
```

Student.Tests.StudentLevel

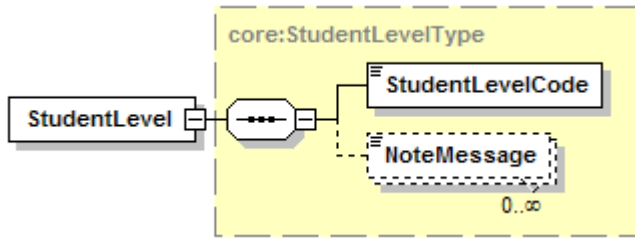

Tag Name	Schema Use	Description	Recommended Use	Format
StudentLevelCode	Required	The classification of the student at the time the student took the test	Required	Enumeration: NinthGrade TenthGrade EleventhGrade TwelfthGrade PostsecondaryBachelorPre NonDegree CollegeFirstYear CollegeFirstYearAttendedB CollegeSophomore CollegeJunior CollegeSenior CollegeFifthYear PostBaccalaureate GraduateNonDegree GraduateFirstYear GraduateSecondYear GraduateThirdYear GraduateBeyondThirdYear Professional ProfessionalFirstYear ProfessionalSecondYear ProfessionalThirdYear ProfessionalBeyondThirdYe MastersQualifying Masters Doctoral Postdoctoral
NoteMessage	Optional Repeatable	Additional information about the student level	Not Recommended	minLength 1 maxLength 80
Comment:				
Comment:				

Code illustration:

```

<StudentLevel>
  <StudentLevelCode>CollegeFirstYear</StudentLevelCode>
  <NoteMessage/>
</StudentLevel>

```

Student.Tests.Subtest

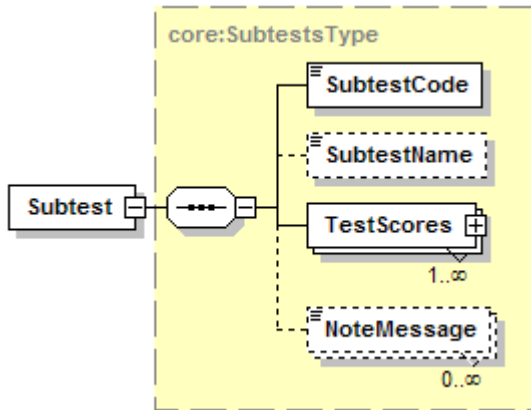

Tag Name	Schema Use	Description	Recommended Use	Format
SubtestCode	Required	Code identifying the sub-part of a standardized test (e.g. Quantitative, Verbal)	Required	See Appendix D
SubtestName	Optional	Name of the sub-part of a standardized test	Recommended	See Appendix D
TestScores	Required Repeatable	The score received on the test	Required	
NoteMessage	Optional Repeatable	Additional information about the subtest	Not Recommended	minLength 1 maxLength 80
Comment:				
Comment:				

Code illustration:

```

<Subtest>
  <SubtestCode>0001</SubtestCode>
  <SubtestName>Listening Comprehension</SubtestName>
  <TestScores>
*
*
    </TestScores>
  <NoteMessage/>
</Subtest>
    
```

Student.Tests.Subtest.TestScores

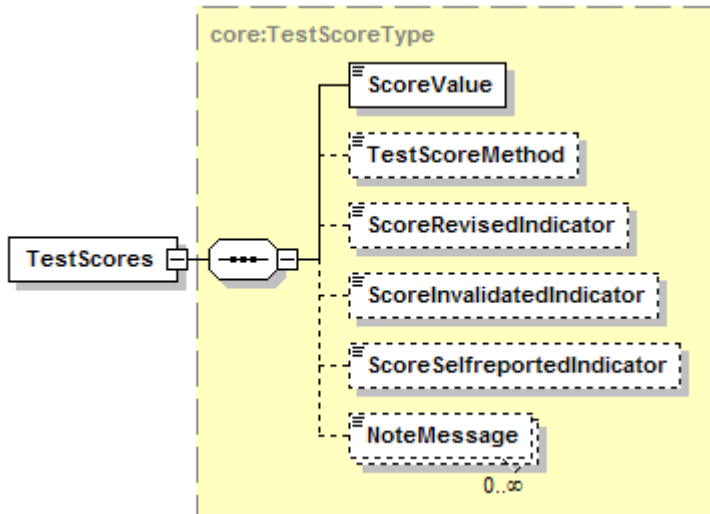

Tag Name	Schema Use	Description	Recommended Use	Format
ScoreValue	Required	The actual value of the score received on the test	Required	minLength 1 maxLength 80
TestScoreMethod	Optional	Code identifying the method used to measure and report the test scores. Scaled - Scaled Score Graded - Grade Equivalent or Grade Level Indicator Standard - Standard Score Raw - Raw Score Percent - Percent of Items Correct Mastery - Mastery Score Adjective - Adjective Classification or Locally Defined Score Stanine - Stanine Percentile - Percentile NormalCurve - Normal Curve Equivalent Equated - Equated Score (pre-test and post-test were different) Local - Locally Defined	Optional	Enumeration: Scaled Graded Standard Raw Percent Mastery Adjective Stanine Percentile NormalCurve Equated Local
ScoreRevisedIndicator	Optional	Indicates if the score report has been revised. If true, score may differ from score previously reported for this test and test date.	Optional	true false
ScoreInvalidatedIndicator	Optional	Indicates if the score has been invalidated. If true, score previously reported for this test and test date is not valid.	Optional	true false
ScoreSelfreportedIndicator	Optional	Indicates if the score has been self-reported by the student.	Optional	true false
NoteMessage	Optional Repeatable	Additional information about the test score	Not Recommended	minLength 1 maxLength 80
Comment:				
Comment:				

Code illustration:

```
<TestScores>  
  <ScoreValue>25</ScoreValue>  
  <TestScoreMethod>Scaled</TestScoreMethod>  
  <ScoreRevisedIndicator>true</ScoreRevisedIndicator>  
  <ScoreInvalidatedIndicator>false</ScoreInvalidatedIndicator>  
  <ScoreSelfreportedIndicator>false</ScoreSelfreportedIndicator>  
  <NoteMessage/>  
</TestScores>
```

Appendix A – StateProvinceCode

StateProvinceCode	Description	StateProvinceCode	Description
AA	Military-Americas	NB	New Brunswick
AB	Alberta	NC	North Carolina
AE	Military-Europe	ND	North Dakota
AK	Alaska	NE	Nebraska
AL	Alabama	NF	Newfoundland
AP	Military-Pacific	NH	New Hampshire
AR	Arkansas	NJ	New Jersey
AS	American Samoa	NL	Newfoundland And Labrador
AZ	Arizona	NM	New Mexico
BC	British Columbia	NS	Nova Scotia
CA	California	NT	Northwest Territories
CO	Colorado	NU	Nunavut
CT	Connecticut	NV	Nevada
CZ	Canal Zone	NY	New York
DC	District Of Columbia	OH	Ohio
DE	Delaware	OK	Oklahoma
FL	Florida	ON	Ontario
FM	Federated States Of Micronesia	OR	Oregon
GA	Georgia	PA	Pennsylvania
GU	Guam	PE	Prince Edward Island
HI	Hawaii	PR	Puerto Rico
IA	Iowa	PW	Republic Of Palau
ID	Idaho	QC	Quebec
IL	Illinois	RI	Rhode Island
IN	Indiana	SC	South Carolina
KS	Kansas	SD	South Dakota
KY	Kentucky	SK	Saskatchewan
LA	Louisiana	TN	Tennessee
MA	Massachusetts	TX	Texas
MB	Manitoba	UT	Utah
MD	Maryland	VA	Virginia
ME	Maine	VI	Virgin Islands
MH	Marshall Islands	VT	Vermont
MI	Michigan	WA	Washington
MN	Minnesota	WI	Wisconsin
MO	Missouri	WV	West Virginia
MP	Northern Mariana Islands	WY	Wyoming
MS	Mississippi	YT	Yukon
MT	Montana		

Appendix B – CountryCode

CountryCode	Description	CountryCode	Description
AD	Andorra	ES	Spain
AE	United Arab Emirates	ET	Ethiopia
AF	Afghanistan	FI	Finland
AG	Antigua And Barbuda	FJ	Fiji
AI	Anguilla	FK	Falkland Islands (Malvinas)
AL	Albania	FM	Micronesia, Federated States Of
AM	Armenia	FO	Faroe Islands
AN	Netherlands Antilles	FR	France
AO	Angola	GA	Gabon
AQ	Antarctica	GB	United Kingdom
AR	Argentina	GD	Grenada
AS	American Samoa	GE	Georgia
AT	Austria	GF	French Guiana
AU	Australia	GH	Ghana
AW	Aruba	GI	Gibraltar
AX	Åland Islands	GL	Greenland
AZ	Azerbaijan	GM	Gambia
BA	Bosnia And Herzegovina	GN	Guinea
BB	Barbados	GP	Guadeloupe
BD	Bangladesh	GQ	Equatorial Guinea
BE	Belgium	GR	Greece
BF	Burkina Faso	GS	South Georgia And The South Sandwich Islands
BG	Bulgaria	GT	Guatemala
BH	Bahrain	GU	Guam
BI	Burundi	GW	Guinea Bissau
BJ	Benin	GY	Guyana
BM	Bermuda	HK	Hong Kong
BN	Brunei Darussalam	HM	Heard Island And Mcdonald Islands
BO	Bolivia	HN	Honduras
BR	Brazil	HR	Croatia
BS	Bahamas	HT	Haiti
BT	Bhutan	HU	Hungary
BV	Bouvet Island	ID	Indonesia
BW	Botswana	IE	Ireland
BY	Belarus	IL	Israel
BZ	Belize	IN	India
CA	Canada	IO	British Indian Ocean Territory
CC	Cocos (Keeling) Islands	IQ	Iraq
CD	Congo, The Democratic Republic Of The	IR	Iran, Islamic Republic Of
CF	Central African Republic	IS	Iceland
CG	Congo	IT	Italy
CH	Switzerland	JM	Jamaica
CI	Cote D'ivoire	JO	Jordan
CK	Cook Islands	JP	Japan
CL	Chile	KE	Kenya
CM	Cameroon	KG	Kyrgyzstan
CN	China	KH	Cambodia
CO	Colombia	KI	Kiribati
CR	Costa Rica	KM	Comoros
CS	Serbia And Montenegro	KN	Saint Kitts And Nevis
CU	Cuba	KP	Korea, Democratic People's Republic Of
CV	Cape Verde	KR	Korea, Republic Of
CX	Christmas Island	KW	Kuwait
CY	Cyprus	KY	Cayman Islands
CZ	Czech Republic	KZ	Kazakhstan
DE	Germany	LA	Lao People's Democratic Republic
DJ	Djibouti	LB	Lebanon
DK	Denmark	LC	Saint Lucia
DM	Dominica	LI	Liechtenstein
DO	Dominican Republic	LK	Sri Lanka
DZ	Algeria	LR	Liberia
EC	Ecuador	LS	Lesotho
EE	Estonia	LT	Lithuania
EG	Egypt	LU	Luxembourg
EH	Western Sahara	LV	Latvia
ER	Eritrea		

CountryCode	Description	CountryCode	Description
LY	Libyan Arab Jamahiriya	SB	Solomon Islands
MA	Morocco	SC	Seychelles
MC	Monaco	SD	Sudan
MD	Moldova, Republic Of	SE	Sweden
MG	Madagascar	SG	Singapore
MH	Marshall Islands	SH	Saint Helena
MK	Macedonia, The Former Yugoslav Republic Of	SI	Slovenia
ML	Mali	SJ	Svalbard And Jan Mayen
MM	Myanmar	SK	Slovakia
MN	Mongolia	SL	Sierra Leone
MO	Macao	SM	San Marino
MP	Northern Mariana Islands	SN	Senegal
MQ	Martinique	SO	Somalia
MR	Mauritania	SR	Suriname
MS	Montserrat	ST	Sao Tome And Principe
MT	Malta	SV	El Salvador
MU	Mauritius	SY	Syrian Arab Republic
MV	Maldives	SZ	Swaziland
MW	Malawi	TC	Turks And Caicos Islands
MX	Mexico	TD	Chad
MY	Malaysia	TF	French Southern Territories
MZ	Mozambique	TG	Togo
NA	Namibia	TH	Thailand
NC	New Caledonia	TJ	Tajikistan
NE	Niger	TK	Tokelau
NF	Norfolk Island	TL	Timor Leste
NG	Nigeria	TM	Turkmenistan
NI	Nicaragua	TN	Tunisia
NL	Netherlands	TO	Tonga
NO	Norway	TR	Turkey
NP	Nepal	TT	Trinidad And Tobago
NR	Nauru	TV	Tuvalu
NU	Niue	TW	Taiwan, Province Of China
NZ	New Zealand	TZ	Tanzania, United Republic Of
OM	Oman	UA	Ukraine
PA	Panama	UG	Uganda
PE	Peru	UM	United States Minor Outlying Islands
PF	French Polynesia	US	United States
PG	Papua New Guinea	UY	Uruguay
PH	Philippines	UZ	Uzbekistan
PK	Pakistan	VA	Holy See (Vatican City State)
PL	Poland	VC	Saint Vincent And The Grenadines
PM	Saint Pierre And Miquelon	VE	Venezuela
PN	Pitcairn	VG	Virgin Islands, British
PR	Puerto Rico	VI	Virgin Islands, U.S.
PS	Palestinian Territory, Occupied	VN	Viet Nam
PT	Portugal	VU	Vanuatu
PW	Palau	WF	Wallis And Futuna
PY	Paraguay	WS	Samoa
QA	Qatar	YE	Yemen
RE	Reunion	YT	Mayotte
RO	Romania	ZA	South Africa
RU	Russian Federation	ZM	Zambia
RW	Rwanda	ZW	Zimbabwe
SA	Saudi Arabia		

Appendix C – TestCode and TestName

TestCode	TestName	TestCode	TestName
1	California Achievement Tests, 1977	815	Dental Admissions Test
2	California Achievement Tests, 1985	816	Optometry Admissions Test
3	California Achievement Tests, 1986	817	Allied Health Professions Admission Test (AHPAT)
4	Comprehensive Assessment Program Achievement Series, 1980	818	College Level Examination Program (CLEP)
5	Comprehensive Tests of Basic Skills, 1981		General Examinations
6	Comprehensive Tests of Basic Skills, 1988	819	College Level Examination Program (CLEP) Subject Examinations
7	Iowa Tests of Basic Skills, 1978	821	Graduate Record Examination (GRE) General Test
8	Iowa Tests of Basic Skills, 1985	822	Graduate Record Examination (GRE) Subject Tests
9	Tests of Achievement and Proficiency, 1978	826	Pre-Professional Skills Test (PPST)
10	Tests of Achievement and Proficiency, 1985	828	Test of Spoken English (TSE)
11	Metropolitan Achievement Tests, 1978	829	Test of Written English (TWE)
12	Metropolitan Achievement Tests, 1985	830	Veterinary College Admission Test (VCAT)
13	Metropolitan Language Instructional Tests, 1979	831	College Board's Advanced Placement Program (AP)
14	Metropolitan Reading Instructional Tests, 1979	9AK	Alaska State Adopted Test or Requirement
15	National Tests of Basic Skills, 1985	9AL	Alabama State Adopted Test or Requirement
16	National Tests of Basic Skills, 1986	9AR	Arkansas State Adopted Test or Requirement
17	National Achievement Tests Comprehensive Assessment Program, 1989	9AZ	Arizona State Adopted Test or Requirement
18	Science Research Associates Achievement Tests, 1978	9CA	California State Adopted Test or Requirement
19	Science Research Associates Survey of Basic Skills, 1985	9CO	Colorado State Adopted Test or Requirement
20	Stanford Diagnostic Reading Test, 1984	9CT	Connecticut State Adopted Test or Requirement
21	Stanford Achievement Tests, 1982		District of Columbia State Adopted Test or Requirement
22	Stanford Achievement Tests, 1987	9DC	Delaware State Adopted Test or Requirement
23	Stanford Achievement Tests, 1988	9DE	Florida State Adopted Test or Requirement
24	Stanford Test of Academic Skills, 1982	9FL	Georgia State Adopted Test or Requirement
25	Stanford Test of Academic Skills, 1987	9GA	Hawaii State Adopted Test or Requirement
26	Stanford Test of Academic Skills, 1988	9HI	Iowa State Adopted Test or Requirement
27	Sequential Tests of Educational Progress, 1979	9IA	Idaho State Adopted Test or Requirement
28	The 3 R's Test, 1982	9ID	Illinois State Adopted Test or Requirement
29	California Achievement Tests	9IL	Indiana State Adopted Test or Requirement
30	Comprehensive Assessment Program Achievement Series	9IN	Kansas State Adopted Test or Requirement
31	Comprehensive Tests of Basic Skills	9KS	Kentucky State Adopted Test or Requirement
32	Iowa Tests of Basic Skills	9KY	Louisiana State Adopted Test or Requirement
33	Tests of Achievement and Proficiency	9LA	Massachusetts State Adopted Test or Requirement
34	Metropolitan Achievement Tests	9MA	Maryland State Adopted Test or Requirement
35	Metropolitan Language Instructional Tests	9MD	Maine State Adopted Test or Requirement
36	Metropolitan Reading Instructional Tests	9ME	Michigan State Adopted Test or Requirement
37	National Tests of Basic Skills	9MI	Minnesota State Adopted Test or Requirement
38	National Achievement Tests Comprehensive Assessment Program	9MN	Missouri State Adopted Test or Requirement
39	Science Research Associates Achievement Tests	9MO	Mississippi State Adopted Test or Requirement
40	Science Research Associates Survey of Basic Skills	9MS	Montana State Adopted Test or Requirement
41	Stanford Diagnostic Reading Test	9MT	North Carolina State Adopted Test or Requirement
42	Stanford Achievement Tests	9NC	North Dakota State Adopted Test or Requirement
43	Stanford Test of Academic Skills	9ND	Nebraska State Adopted Test or Requirement
44	Sequential Tests of Educational Progress	9NE	New Hampshire State Adopted Test or Requirement
45	The 3 R's Test	9NH	New Jersey State Adopted Test or Requirement
46	Iowa Test of Educational Development (Grades 9-12)	9NJ	New Mexico State Adopted Test or Requirement
555	Local/District Adopted Test	9NM	Nevada State Adopted Test or Requirement
801	American College Testing Program (ACT)	9NV	New York State Adopted Test or Requirement
802	Preliminary American College Testing (PACT)	9OH	Ohio State Adopted Test or Requirement
803	College Board's Scholastic Aptitude Test (SAT I) Preliminary Scholastic Aptitude Test/ National Merit Scholarship Qualifying Test (PSAT/NMSQT)	9OK	Oklahoma State Adopted Test or Requirement
804	College Board's Achievement Tests (SAT II)	9OR	Oregon State Adopted Test or Requirement
805	Test of Adult Basic Education (TABE)	9PA	Pennsylvania State Adopted Test or Requirement
806	International Baccalaureate (IB)	9RI	Rhode Island State Adopted Test or Requirement
807	General Education Development (GED)	9SC	South Carolina State Adopted Test or Requirement
808	Test of English as a Foreign Language (TOEFL)	9SD	South Dakota State Adopted Test or Requirement
809	Graduate Management Admissions Test (GMAT)	9TN	Tennessee State Adopted Test or Requirement
811	Law School Admissions Test (LSAT)	9TX	Texas State Adopted Test or Requirement
812	Miller Analogies Test	9UT	Utah State Adopted Test or Requirement
813	Medical Colleges Aptitude Test (MCAT)	9VA	Virginia State Adopted Test or Requirement
814		9VT	Vermont State Adopted Test or Requirement
		9WA	Washington State Adopted Test or Requirement
		9WI	Wisconsin State Adopted Test or Requirement
		9WV	West Virginia State Adopted Test or Requirement
		9WY	Wyoming State Adopted Test or Requirement
		999	Other Tests Not Listed or Provided by Sender

Appendix D – SubtestCode and SubtestName

CALIFORNIA ACHIEVEMENT TESTS (Test codes 1, 2, 3, and 29)

00001	Vocabulary
00002	Reading Comprehension
00003	Reading Total
00004	Spelling
00005	Language Mechanics
00006	Language Expression
00007	Language Total
00008	Mathematics Computation
00009	Mathematics Concepts and Applications
00010	Mathematics Total
00011	Total Battery
00012	Study Skills
00013	Science
00014	Social Studies
00100	Complete Battery
00101	Basic Battery

COMPREHENSIVE TESTS OF BASIC SKILLS (Test codes 5, 6 and 31)

00001	Visual Recognition
00002	Sound Recognition
00003	Oral Comprehension
00004	Word Attack
00005	Vocabulary
00006	Total Reading Oral
00007	Reading Comprehension
00008	Spelling
00009	Language Mechanics
00010	Language Expression
00011	Total Language
00012	Mathematics Computation
00013	Mathematics Concepts and Applications
00014	Reference Skills
00015	Science
00016	Social Studies
00100	Complete Battery
00101	Basic Battery

IOWA TESTS OF BASIC SKILLS (Test codes 7, 8 and 32)

00001	Listening
00002	Word Analysis
00003	Vocabulary
00004	Reading Comprehension
00005	Spelling
00006	Capitalization
00007	Punctuation
00008	Usage and Expression
00009	Language Total
00010	Visual Materials
00011	Reference Materials
00012	Work-Study Skills
00013	Mathematics Concepts
00014	Mathematics Problems
00015	Mathematics Computation
00016	Science
00017	Materials Total
00018	Mathematics Total
00019	Social Studies
00100	Complete Battery
00101	Basic Battery

TESTS OF ACHIEVEMENT AND PROFICIENCY (Test codes 9, 10 and 33)

00001 Reading Comprehension
00002 Mathematics
00003 Written Expression
00004 Using Sources of Information
00005 Social Studies
00006 Science
00007 Applied Proficiency Skills
00008 Total Battery
00100 Complete Battery
00101 Basic Battery

METROPOLITAN ACHIEVEMENT TESTS (Test codes 11, 12 and 34)

00001 Vocabulary
00002 Word Recognition Skills
00003 Reading Comprehension
00004 Total Reading
00005 Mathematics: Concepts
00006 Mathematics: Problem Solving
00007 Mathematics: Computation
00008 Total Mathematics
00009 Spelling
00010 Language
00011 Total Language
00012 Science
00013 Social Studies
00014 Research Skills
00100 Complete Battery
00101 Basic Battery

NATIONAL TESTS OF BASIC SKILLS (Test codes 15, 16 and 37)

00001 Listening
00002 Word Analysis
00003 Vocabulary
00004 Reading Comprehension
00005 Spelling
00006 Capitalization
00007 Punctuation
00008 Usage and Expression
00009 Language Total
00010 Visual Materials
00011 Reference Materials
00012 Work-Study Skills
00013 Mathematics Concepts
00014 Mathematics Problems
00015 Mathematics Computation
00016 Science
00017 Social Studies
00100 Basic Battery
00101 Complete Battery

SCIENCE RESEARCH ASSOCIATES SURVEY OF BASIC SKILLS (Test codes 19 and 40)

00001 Reading Total
00002 Auditory Discrimination
00003 Letters and Sounds
00004 Decoding
00005 Listening Comprehension
00006 Vocabulary
00007 Reading Comprehension
00008 Language Arts
00009 Mechanics
00010 Usage
00011 Spelling
00012 Mathematics: Concepts/Problem Solving
00013 Mathematics: Computation
00014 Reference Materials
00015 Educational Ability Series
00016 Reading Comprehension
00017 Social Studies
00018 Science
00019 Survey of Applied Skills
00100 Complete Battery
00101 Basic Battery

STANFORD ACHIEVEMENT TESTS (Test codes 21, 22, 23 and 42)

00001 Listening
00002 Word Analysis
00003 Vocabulary
00004 Reading Comprehension
00005 Spelling
00006 Capitalization
00007 Punctuation
00008 Usage and Expression
00009 Language Total
00010 Visual Materials
00011 Reference Materials
00012 Work-Study Skills
00013 Mathematics Concepts
00014 Mathematics Problems
00015 Mathematics Computation
00016 Basic Battery
00017 Complete Battery
00018 Social Studies
00019 Science
00100 Complete Battery
00101 Basic Battery

STANFORD TEST OF ACADEMIC SKILLS (Test codes 24, 25, 26 and 43)

00001 Word Reading
00002 Reading Comprehension
00003 Auditory Discrimination
00004 Phonetic Analysis
00005 Structural Analysis
00006 Auditory Vocabulary
00007 Vocabulary
00008 Word Parts
00009 Reading Rate
00010 Scanning and Skimming
00011 Fast Reading
00012 Number System and Numeration
00013 Computation
00014 Applications
00015 Mathematics Total
00100 Complete Battery
00101 Basic Battery

THE 3 R'S TEST (Test codes 28 and 45)

00001 Listening
00002 Word Analysis
00003 Vocabulary
00004 Reading Comprehension
00005 Spelling
00006 Capitalization
00007 Punctuation
00008 Usage and Expression
00009 Language Total
00010 Visual Materials
00011 Reference Materials
00012 Work-Study Skills
00013 Mathematics Concepts
00014 Mathematics Problems
00015 Mathematics Computation
00016 Social Studies
00017 Science
00100 Complete Battery
00101 Basic Battery

IOWA TEST OF EDUCATIONAL DEVELOPMENT, GRADES 9-12 (Test code 46)

00001 Vocabulary
00002 Content Area Reading
00003 Reading Total
00004 Expression – Advanced
00005 Expression Total
00006 Quantitative Thinking
00007 Quantitative Thinking
00008 Core Total
00009 Literary Materials
00010 Social Studies
00011 Science
00012 Sources of Informatio
00013 Composite

AMERICAN COLLEGE TESTING PROGRAM (ACT) (Test code 801)

00001 English
00002 English: Usage/Mechanics
00003 English: Rhetorical Skills
00004 Mathematics
00005 Mathematics: Preliminary and Elementary Algebra
00006 Mathematics: Intermediate Algebra and Geometry
00007 Mathematics: Plane Geometry and Trigonometry
00008 Reading
00009 Reading: Social Studies and Science
00010 Reading: Arts and Literature
00011 Science Reasoning
00012 Composite

PRELIMINARY AMERICAN COLLEGE TESTING (Test code 802)

00001 English
00002 English: Usage and Mechanics
00003 English: Rhetorical Skills
00004 Mathematics
00005 Mathematics: Preliminary Algebra
00006 Mathematics: Geometry
00007 Reading
00008 Reading: Social Studies and Scie
00009 Reading: Arts and Literature
00010 Science Reasoning
00011 Composite

THE COLLEGE BOARD'S SCHOLASTIC APTITUDE TEST (SAT I) (Test code 803)

00001 Verbal
00002 Reading Comprehension
00003 Vocabulary
00004 Mathematical
00005 Total
00006 Test of Standard Written English (TSWE)

PRELIMINARY SCHOLASTIC APTITUDE TEST/NATIONAL MERIT SCHOLARSHIP QUALIFYING TEST (PSAT/NMSQT) (Test code 804)

00001 Verbal
00002 Mathematical
00003 Total

COLLEGE BOARD'S ACHIEVEMENT TESTS (SAT II) (Test code 805)

00001 English Composition
00002 Literature
00003 American History
00004 European History
00005 Mathematics I
00006 Mathematics II
00007 Biology
00008 Chemistry
00009 Physics
00010 French
00011 German
00012 Hebrew
00013 Latin
00014 Spanish
00015 World History
00016 French Listening
00017 Japanese with Listening
00018 German Listening
00019 Spanish Listening
00020 Chinese with Listening
00021 English Composition with Essay
00022 Italian
00023 Mathematics Level IC
00024 Mathematics Level IIC
00025 Modern Hebrew
00026 Writing

TEST OF ADULT BASIC EDUCATION (TABE) (Test code 806)

00001 Language Arts
00002 Mechanics
00003 Expression
00004 Reading
00005 Vocabulary
00006 Comprehension
00007 Mathematics
00008 Computation
00009 Concepts/Applications
00010 Spelling

INTERNATIONAL BACCALAUREATE (IB) (Test code 807)

00001 Biology
00002 Chemistry
00003 English A
00004 English B
00005 Foreign Language A
00006 Foreign Language B
00007 History (American)
00008 History (European)
00009 Mathematics
00010 Physics

GENERAL EDUCATION DEVELOPMENT (GED) (Test code 808)

00001 Mathematics
00002 Interpreting Literature and the Arts
00003 Science
00004 Social Studies
00005 Writing Skills

TEST OF ENGLISH AS A FOREIGN LANGUAGE (TOEFL) (Test code 809)

00001 Listening Comprehension
00002 Structure and Written Expression
00003 Vocabulary
00004 Total

GRADUATE MANAGEMENT ADMISSIONS TEST (GMAT) (Test code 811)

00001 Verbal
00002 Quantitative

LAW SCHOOL ADMISSIONS TEST (LSAT) (Test code 812)

00001 Reading Comprehension
00002 Analytical Reasoning
00003 Logical Reasoning
00004 Variable

MEDICAL COLLEGES ADMISSIONS TEST (MCAT) (Test code 814)

00001 Biology
00002 Chemistry
00003 Physics
00004 Science
00005 Reading
00006 Quantitative

DENTAL ADMISSIONS TEST (Test code 815)

00001 Quantitative Reasoning
00002 Reading
00003 Biology
00004 General Chemistry
00005 Organic Chemistry
00006 Perceptual Ability
00007 Survey of Natural Science
00008 Academic Average

OPTOMETRY ADMISSIONS TEST (Test code 816)

00001 Quantitative Reasoning
00002 Reading
00003 Biology
00004 General Chemistry
00005 Organic Chemistry
00006 General Physics
00007 Survey of Natural Science
00008 Academic Average

ALLIED HEALTH PROFESSIONS ADMISSION TEST (AHPAT) (Test code 817)

00001 Verbal Ability
00002 Quantitative Ability
00003 Biology
00004 Chemistry
00005 Reading Comprehension

COLLEGE LEVEL EXAMINATION PROGRAM (CLEP) GENERAL EXAMS (Test code 818)

00001 English Composition
00002 Humanities
00003 Mathematics
00004 Natural Sciences
00005 Social Sciences and History

COLLEGE LEVEL EXAMINATION PROGRAM (CLEP) SUBJECT EXAMS (Test code 819)

00001 American Government
00002 American History I: Early Colonization to 1877
00003 American History II: 1865 to Present
00004 General Psychology

00005 Human Growth and Development
 00006 Introduction to Educational Psychology
 00007 Introductory Macro Economics
 00008 Introductory Micro Economics
 00009 Introductory Sociology
 00010 Western Civilization I: Ancient Near East to 1648
 00011 Western Civilization II: 1648 to the Present
 00012 College French: Levels 1 and 2
 00013 College German: Levels 1 and 2
 00014 College Spanish: Levels 1 and 2
 00015 American Literature
 00016 Analysis and Interpretation of Literature
 00017 College Composition
 00018 English Literature
 00019 Freshman English
 00020 Calculus with Elementary Functions
 00021 College Algebra
 00022 Trigonometry
 00023 College Algebra with Trigonometry
 00024 General Biology
 00025 General Chemistry
 00026 Information Systems and Computer Applications
 00027 Introduction to Management
 00028 Introductory Accounting
 00029 Introductory Business Law
 00030 Introductory Marketing

GRADUATE RECORD EXAMINATION (GRE) GENERAL TEST (Test code 821)

00001 Verbal
 00002 Quantitative
 00003 Analytical

GRADUATE RECORD EXAMINATION (GRE) SUBJECT TESTS (Test code 822)

00001 Biochemistry, Cell and Molecular Biology (B22)
 00002 Biology (B24)
 00003 Chemistry (C27)
 00004 Computer Science (C29)
 00005 Economics (E31)
 00006 Education (E34)
 00007 Engineering (E37)
 00008 Geology (G47)
 00009 History (H57)
 00010 Literature in English (L64)
 00011 Mathematics (M67)
 00012 Revised Music (M72)
 00013 Physics (P77)
 00014 Political Science (P79)
 00015 Psychology (P81)
 00016 Sociology (S87)

PRE-PROFESSIONAL SKILLS TEST (PPST) (Test code 826)

00001 Reading
 00002 Mathematics
 00003 Writing
 00004 Grammar
 00005 Fluency
 00006 Overall Comprehension

TEST OF SPOKEN ENGLISH (TSE) (Test code 828)

00001 Pronunciation
 00002 Grammar
 00003 Fluency
 00004 Overall Comprehension

VETERINARY COLLEGE ADMISSION TEST (VCAT) (Test code 830)

00001 Verbal Ability
 00002 Biology
 00003 Chemistry
 00004 Quantitative Ability
 00005 Reading Comprehension

THE COLLEGE BOARD'S ADVANCED PLACEMENT PROGRAM (Test code 831)

00001	U.S. History
00002	Art History
00003	Art - Drawing
00004	Art - General
00005	Biology
00006	Chemistry
00007	Comp Sci - A
00008	Comp Sci - B
00009	Economics - Micro
00010	Economics - Macro
00011	English Language/Comp
00012	English Literature/Comp
00013	European History
00014	French Language
00015	French Literature
00016	German Language
00017	Govt & Pol - US
00018	Govt & Pol - Comp
00019	Latin - Vergil
00020	Latin - Cat Hor
00021	Calculus AB
00022	Calculus BC
00023	Music List & Lit
00024	Music Theory
00025	Physics
00026	Physics C - Mech
00027	Physics C - E & M
00028	Psychology
00029	Spanish Language
00030	Spanish Literature

Appendix E – CourseAcademicGradeScaleCode

I. Five or more passing grades (alpha with +/-)												
Code	Grades Used											
Wt	4.0	3.7	3.3	3.0	2.7	2.3	2.0	1.7	1.3	1.0	0.7	0.0
01	A	A-	B+	B	B-	C+	C	C-	D+	D	D-	F
02	A+,A	A-	B+	B	B-	C+	C	C-	D+	D	D-	F
03	A		B+	B		C+	C		D+	D		F
04	A+, A		B+	B		C+	C		D+	D		F
05	A+, A	A-	B+	B	B-	C+	C	C-	D+	D		F
06	A	A-	B+	B	B-	C+	C	C-				F
07	A		B+	B		C+	C			D		F
08	A	A-	B+	B	B-	C+	C	C-	D+	D		F
09	A	A-	B+	B	B-	C+	C	C-		D		F
10	A	A-	B+	B	B-	C+	C	C-	D+	D	D-	E/NC
11	A+, A	A-	B+	B	B-	C+	C	C-				
12	A+, A	A-	B+	B	B-	C+	C	C-	D+	D	D-	
13	A	A-	B+	B	B-	C+	C	C-	D+	D	D-	
14	Non-standard system using 5 or more alpha grades, no "F"											
15	Non-standard system using 5 or more alpha grades, and "F"											

II. ABCD/F with Halfstep Grades (AB, BC, etc.)									
Code	Grades Used								
Wt	4.0	3.5	3.0	2.5	2.0	1.5	1.0	0.5	0.0
16	A	AB	B	BC	C	CD	D	DF	F
17	A	AB	B	BC	C		D		F
18	A		B	C+	C		D		F
19	A	B+	B	C+	C	D+	D		F
20	A	B+	B	C+	C		D		F
21	A	B+	B	C+	C	C-	D		F
22	A+,A	B+	B	C+	C	D+	D		F
23	Other ABCDF system with halfstep grades, no "F" grade								
24	Other ABCDF system with halfstep grades and "F" grade								

III. ABCD/F Type (4 passing letter grades)					
Code	Grades Used				
Wt	4.0	3.0	2.0	1.0	0.0
25	A	B	C	D	F
26	A	B	C	D	NC/N
27	A	B	C	D	E
28	H	S+	S	S-	U
29	E	S	M	I	F
30	DN	HP	P	HCO	NC
31	D	E	G	Q	U/F
32	H	E	G	P	U
33	S	H	P	LP	F
34	E	VG	G	P	F
35	HO	HP	PA	CR	NC
36	A	B	C	D	
37	A	B	C	D	U/R
38	Other ABCD/F type system, no "F" grade				
39	Other ABCD/F type system, with "F" grade				

IV. ABC/F Type (3 passing letter grades)				
Code	Grades Used			
Wt	4.0	3.0	2.0	0.0
40	A	B	C	F
41	H	HP	CR	NC
42	H	HP	P	F
43	A	B	C	NC
44	A	B	C	
45	H	HP	P	NP
46	HH	H	P	
47	HH	H	P	F
48	E	G	P	U/F
53	Other ABC/F type system, with no "F" grade			
54	Other ABC/F type system, with "F" grade			

V. Graduate School Grading Systems (not normally found in Manual)					
Code	Grades Used				
Wt	4.0	3.7	3.0	2.7	0.0
49	H	HP	P	LP	U/F
50	H	HP	P		F
51	DIST	HIGH PASS	PASS	LOW PASS	F
52	H	HP	P		U

VI. Pass/Fail Type (one or two passing grades)	
Code	Grades Used
Two passing grades, each converted to an American Medical Colleges Admissions Service (AMCAS) grade of "P"; failing grade converted to "N"	
55	Pass/Fail: HP and P, F
56	Pass/Fail: H and P, F
57	Pass/Fail: HP and P, N/NC
58	Pass/Fail: H and P, U
59	Other Pass/Fail types with two passing grades
One passing grade, converted to AMCAS grade of "P"; failing grade converted to AMCAS grade of "N"	
60	Pass/Fail: P, F
61	Pass/Fail: SAT, U
62	Pass/Fail: CR, NC
63	Pass/Fail: S, U
64	Other Pass/Fail types with one passing grade

VII. Numeric - Percent Type												
Code	Grades Used											
Wt	4.0	3.7	3.3	3.0	2.7	2.3	2.0	1.7	1.3	1.0	0.7	0.0
65	100-93	92-90	89-87	86-83	82-80	79-77	76-73	72-70	69-67	66-63	62-60	59-0
66	100-90			89-80			79-70			69-60		59-0
67	100-94	93-90		89-85			84-75			74-70		69-0
68	100-90			89-80			79-70			69-65		64-0
69	100-93			92-85			84-77			76-70		69-0
70	100-93			92-84			83-75			74-70		69-0
71	100-90			89-80		79-76	75-70			69-60		59-0
72	100-90		89-85	84-80		79-75	74-70					69-0
73	Other numeric grading system - percent type											

VIII. Numeric - Percent Type												
Code	Grades Used											
Wt	4.0	3.7	3.3	3.0	2.7	2.3	2.0	1.7	1.3	1.0	0.7	0.0
74	4.0	3.7	3.3	3.0	2.7	2.3	2.0	1.7	1.3	1.0	0.7	0.0
77	1			2			3			4		5
79	4.0			3.0			2.0			1.0		0.0
80	1+,1	1-	2+	2	2-	3+	3	3-	4+	4	4-	5/6
81	3.0			2.0			1.0					0.0
82	Other numeric grading system - 4.0 or integer type											

IX. Numeric (4.0 type) Grading Systems using Halfstep Grades										
Code	Grades Used									
Wt	4.0	3.5	3.0	2.5	2.0	1.5	1.0	0.5	0.0	
76	4.0	3.5	3.0	2.5	2.0	1.5	1.0	0.5	0.0	
78	4.0	3.5	3.0	2.5	2.0		1.0		0.0	
82	Other numeric grading system - 4.0 or integer type									
75	Continuous 4.0 scale (4.0 to 0.0)									

X. Numeric - Canadian Type												
Code	Grades Used											
Wt	4.0	3.7	3.3	3.0	2.7	2.3	2.0	1.7	1.3	1.0	0.7	0.0
83	9	8	7		6	5		4	3			2,1
84	10,9	8	7		6	5		4	3	2	1	0
85	100-87	86-80	79-76	75-73	72-70	69-66	65-63	62-60	59-56	55-53	52-50	49-0
86	100-84	83-75	74-72	71-69	68-66	65-64	63-62	61-60	59-56	55-53	52-50	49-0
87	100-87	86-80	79-75	74-70	69-65	64-60	59-55	54-50				49-0
88	100-87	86-80	79-75	74-70	69-65	64-62	61-59	58-55	54-52	51-48	47-45	44-0
89	Other numeric grading system - Canadian											

XI. Miscellaneous grades used for transcripts	
Code	Description
500	Current Enrollment; Course in Progress; Permanent grade not yet assigned
501	Passing grade in a course (credit or non-credit) which is normally, or based on student option, given a pass/fail or satisfactory/unsatisfactory designation
502	Failing grade in a course (credit or non-credit) which is normally, or based on student option, given a pass/fail or satisfactory/unsatisfactory designation
503	Credit established by advanced placement examination, departmental or institutional credit, credit by exam, etc.
504	Transfer credit; grade not carried on receiving institution's transcript
505	Incomplete
506	Withdrew (without penalty or pass/fail designation)
507	Withdrew passing
509	Withdrew failing
510	Honors grade
511	Audited or visited the course
512	Exempted course
513	No grade reported yet by instructor (although the course has ended)
514	Failing/no pass/unsatisfactory grade awarded because incomplete not resolved satisfactorily
515	Repeated course
517	Grade Scale Unknown
530	Other passing/satisfactory grade not described above
540	Other not passing/unsatisfactory grade not described above

Appendix F – Sample XML College Transcript

```

<?xml version="1.0" encoding="UTF-8"?>
<!-- edited with XMLSPY v5 rel. 4 U (http://www.xmlspy.com) by Bruce Robert Marton (The University of Texas at Austin) -->
<!-- Sample XML file generated by XMLSPY v5 rel. 4 U (http://www.xmlspy.com)-->
<ColTrn:CollegeTranscript xmlns:ColTrn="urn:org:psc:message:CollegeTranscript:v1.0.0"
xmlns:AcRec="urn:org:psc:sector:AcademicRecord:v1.0.0" xmlns:core="urn:org:psc:core:CoreMain:v1.0.0"
xmlns:xsi="http://www.w3.org/2001/XMLSchema-instance" xsi:schemaLocation="urn:org:psc:message:CollegeTranscript:v1.0.0
G:\Brucework\XML\FINALS~1\CollegeTranscript_v1.0.0.xsd">
  <TransmissionData>
    <DocumentID>050330001</DocumentID>
    <CreatedDateTime>2005-02-02T10:04:29-05:00</CreatedDateTime>
    <DocumentTypeCode>RequestedRecord</DocumentTypeCode>
    <TransmissionType>Original</TransmissionType>
    <Source>
      <Organization>
        <ATP>006882</ATP>
        <OrganizationName>THE UNIVERSITY OF TEXAS AT AUSTIN</OrganizationName>
        <Contacts>
          <Address>
            <AddressLine>Office of the Registrar</AddressLine>
            <City>Austin</City>
            <StateProvinceCode>TX</StateProvinceCode>
            <PostalCode>78712</PostalCode>
            <AttentionLine>Jane Shaugness</AttentionLine>
          </Address>
          <Phone>
            <AreaCityCode>512</AreaCityCode>
            <PhoneNumber>4757638</PhoneNumber>
          </Phone>
        </Contacts>
      </Organization>
    </Source>
    <Destination>
      <Organization>
        <FICE>003658</FICE>
      </Organization>
    </Destination>
  </TransmissionData>
  <Student>
    <Person>
      <SSN>100000000</SSN>
      <Birth>
        <BirthDate>1967-07-14</BirthDate>
      </Birth>
      <Name>
        <FirstName>Test</FirstName>
        <MiddleName>Record</MiddleName>
        <MiddleName>Test</MiddleName>
        <LastName>Speede</LastName>
      </Name>
      <HighSchool>
        <OrganizationName>AUSTIN HIGH SCHOOL</OrganizationName>
        <CEEBACT>440320</CEEBACT>
      </HighSchool>
      <Gender>
        <GenderCode>Female</GenderCode>
      </Gender>
      <Deceased>
        <DeceasedIndicator>true</DeceasedIndicator>
      </Deceased>
    </Person>
    <AcademicRecord>
      <School>
        <OrganizationName>AUSTIN HIGH SCHOOL</OrganizationName>
        <CEEBACT>440320</CEEBACT>
        <SchoolLevel>Secondary</SchoolLevel>
        <NoteMessage>LOCATION: AUSTIN, TX</NoteMessage>
      </School>
    </AcademicRecord>
  </Student>
</ColTrn:CollegeTranscript>

```

```

        <AcademicAward>
          <AcademicAwardLevel>1.1</AcademicAwardLevel>
          <AcademicAwardDate>1985-05-01</AcademicAwardDate>
          <AcademicCompletionIndicator>true</AcademicCompletionIndicator>
        </AcademicAward>
      </AcademicRecord>
    <AcademicRecord>
      <School>
        <OrganizationName>AUSTIN COMMUNITY COLLEGE</OrganizationName>
        <ATP>006759</ATP>
        <SchoolOverrideCode>Transfer</SchoolOverrideCode>
        <SchoolLevel>Postsecondary</SchoolLevel>
        <NoteMessage>ATTENDED: 19880601-19880831</NoteMessage>
      </School>
    </AcademicRecord>
    <AcademicRecord>
      <School>
        <OrganizationName>TEXAS A&M UNIVERSITY COLLEGE STATION</OrganizationName>
        <ATP>006003</ATP>
        <SchoolOverrideCode>Transfer</SchoolOverrideCode>
        <SchoolLevel>Postsecondary</SchoolLevel>
        <NoteMessage>ATTENDED: 19980901-19981231</NoteMessage>
      </School>
    </AcademicRecord>
    <AcademicRecord>
      <AcademicSummary>
        <AcademicSummaryType>All</AcademicSummaryType>
        <AcademicSummaryLevel>Undergraduate</AcademicSummaryLevel>
        <GPA>
          <CreditHoursAttempted>159</CreditHoursAttempted>
          <CreditHoursEarned>136</CreditHoursEarned>
          <CreditUnit>Semester </CreditUnit>
          <GradePointAverage>3.0915</GradePointAverage>
          <CreditHoursforGPA>153</CreditHoursforGPA>
        </GPA>
      </AcademicSummary>
      <AcademicSession>
        <AcademicSessionDetail>
          <SessionDesignator>1985-09</SessionDesignator>
          <SessionDesignatorSuffix>1</SessionDesignatorSuffix>
        </AcademicSessionDetail>
        <School>
          <OrganizationName>TEXAS A & M UNIVERSITY COLLEGE STATION
</OrganizationName>
          <ATP>006003</ATP>
          <SchoolOverrideCode>Transfer</SchoolOverrideCode>
        </School>
        <Course>
          <CourseCreditBasis>Regular</CourseCreditBasis>
          <CourseCreditUnits>Semester </CourseCreditUnits>
          <CourseCreditLevel>LowerDivision</CourseCreditLevel>
          <CourseCreditValue>4</CourseCreditValue>
          <CourseCreditEarned>4</CourseCreditEarned>
          <CourseAcademicGradeScaleCode>25</CourseAcademicGradeScaleCode>
          <CourseAcademicGrade>A</CourseAcademicGrade>
          <CourseRepeatCode>NotCountedOther</CourseRepeatCode>
          <CourseCIPCode>999</CourseCIPCode>
          <CourseSubjectAbbreviation>SPN</CourseSubjectAbbreviation>
          <CourseNumber>406</CourseNumber>
          <OriginalCourseID>SPAN 105</OriginalCourseID>
          <CourseTitle>BEGINNING SPANISH 1</CourseTitle>
        </Course>
        <Course>
          <CourseCreditBasis>Regular</CourseCreditBasis>
          <CourseCreditUnits>Semester </CourseCreditUnits>
          <CourseCreditLevel>LowerDivision</CourseCreditLevel>
          <CourseCreditValue>3</CourseCreditValue>
          <CourseCreditEarned>3</CourseCreditEarned>
          <CourseAcademicGradeScaleCode>25</CourseAcademicGradeScaleCode>
          <CourseAcademicGrade>A</CourseAcademicGrade>

```

```

        <CourseRepeatCode>NotCountedOther</CourseRepeatCode>
        <CourseCIPCode>999</CourseCIPCode>
        <CourseSubjectAbbreviation>HIS</CourseSubjectAbbreviation>
        <CourseNumber>315K</CourseNumber>
        <OriginalCourseID>HIST 105</OriginalCourseID>
        <CourseTitle>HISTORY OF THE US 1</CourseTitle>
    </Course>
    <Course>
        <CourseCreditBasis>Regular</CourseCreditBasis>
        <CourseCreditUnits>Semester </CourseCreditUnits>
        <CourseCreditLevel>LowerDivision</CourseCreditLevel>
        <CourseCreditValue>3</CourseCreditValue>
        <CourseCreditEarned>3</CourseCreditEarned>
        <CourseAcademicGradeScaleCode>25</CourseAcademicGradeScaleCode>
        <CourseAcademicGrade>B</CourseAcademicGrade>
        <CourseRepeatCode>NotCountedOther</CourseRepeatCode>
        <CourseCIPCode>999</CourseCIPCode>
        <CourseSubjectAbbreviation>ECO</CourseSubjectAbbreviation>
        <CourseNumber>302</CourseNumber>
        <OriginalCourseID>ECON 203</OriginalCourseID>
        <CourseTitle>MACROECONOMICS</CourseTitle>
    </Course>
    <Course>
        <CourseCreditBasis>Regular</CourseCreditBasis>
        <CourseCreditUnits>Semester </CourseCreditUnits>
        <CourseCreditLevel>LowerDivision</CourseCreditLevel>
        <CourseCreditValue>3</CourseCreditValue>
        <CourseCreditEarned>3</CourseCreditEarned>
        <CourseAcademicGradeScaleCode>25</CourseAcademicGradeScaleCode>
        <CourseAcademicGrade>A</CourseAcademicGrade>
        <CourseRepeatCode>NotCountedOther</CourseRepeatCode>
        <CourseCIPCode>999</CourseCIPCode>
        <CourseSubjectAbbreviation>E</CourseSubjectAbbreviation>
        <CourseNumber>306</CourseNumber>
        <OriginalCourseID>ENGL 103</OriginalCourseID>
        <CourseTitle>COMPOSITN/RHETORIC 1</CourseTitle>
    </Course>
</AcademicSession>
<AcademicSession>
    <AcademicSessionDetail>
        <SessionDesignator>1986-01</SessionDesignator>
        <SessionDesignatorSuffix>1</SessionDesignatorSuffix>
    </AcademicSessionDetail>
    <School>
        <OrganizationName>TEXAS A&M UNIVERSITY COLLEGE STATION
        <ATP>006003</ATP>
        <SchoolOverrideCode>Transfer</SchoolOverrideCode>
    </School>
    <Course>
        <CourseCreditBasis>Regular</CourseCreditBasis>
        <CourseCreditUnits>Semester </CourseCreditUnits>
        <CourseCreditLevel>LowerDivision</CourseCreditLevel>
        <CourseCreditValue>4</CourseCreditValue>
        <CourseCreditEarned>4</CourseCreditEarned>
        <CourseAcademicGradeScaleCode>25</CourseAcademicGradeScaleCode>
        <CourseAcademicGrade>A</CourseAcademicGrade>
        <CourseRepeatCode>NotCountedOther</CourseRepeatCode>
        <CourseCIPCode>999</CourseCIPCode>
        <CourseSubjectAbbreviation>SPN</CourseSubjectAbbreviation>
        <CourseNumber>407</CourseNumber>
        <OriginalCourseID>SPAN 106</OriginalCourseID>
        <CourseTitle>BEGINNING SPANISH 2</CourseTitle>
    </Course>
    <Course>
        <CourseCreditBasis>Regular</CourseCreditBasis>
        <CourseCreditUnits>Semester </CourseCreditUnits>
        <CourseCreditLevel>LowerDivision</CourseCreditLevel>
        <CourseCreditValue>3</CourseCreditValue>
        <CourseCreditEarned>3</CourseCreditEarned>

```

```

        <CourseAcademicGradeScaleCode>25</CourseAcademicGradeScaleCode>
        <CourseAcademicGrade>B</CourseAcademicGrade>
        <CourseRepeatCode>NotCountedOther</CourseRepeatCode>
        <CourseCIPCode>999</CourseCIPCode>
        <CourseSubjectAbbreviation>HIS</CourseSubjectAbbreviation>
        <CourseNumber>315L</CourseNumber>
        <OriginalCourseID>HIST 106</OriginalCourseID>
        <CourseTitle>HISTORY OF THE US 2</CourseTitle>
    </Course>
</Course>
<Course>
    <CourseCreditBasis>Regular</CourseCreditBasis>
    <CourseCreditUnits>Semester </CourseCreditUnits>
    <CourseCreditLevel>LowerDivision</CourseCreditLevel>
    <CourseCreditValue>3</CourseCreditValue>
    <CourseCreditEarned>3</CourseCreditEarned>
    <CourseAcademicGradeScaleCode>25</CourseAcademicGradeScaleCode>
    <CourseAcademicGrade>B</CourseAcademicGrade>
    <CourseRepeatCode>NotCountedOther</CourseRepeatCode>
    <CourseCIPCode>999</CourseCIPCode>
    <CourseSubjectAbbreviation>GEO</CourseSubjectAbbreviation>
    <CourseNumber>303</CourseNumber>
    <OriginalCourseID>GEOL 103</OriginalCourseID>
    <CourseTitle>ELEMENTS OF GEOLOGY</CourseTitle>
</Course>
<Course>
    <CourseCreditBasis>Regular</CourseCreditBasis>
    <CourseCreditUnits>Semester </CourseCreditUnits>
    <CourseCreditLevel>LowerDivision</CourseCreditLevel>
    <CourseCreditValue>3</CourseCreditValue>
    <CourseCreditEarned>3</CourseCreditEarned>
    <CourseAcademicGradeScaleCode>25</CourseAcademicGradeScaleCode>
    <CourseAcademicGrade>A</CourseAcademicGrade>
    <CourseRepeatCode>NotCountedOther</CourseRepeatCode>
    <CourseCIPCode>999</CourseCIPCode>
    <CourseSubjectAbbreviation>GRG</CourseSubjectAbbreviation>
    <CourseNumber>305</CourseNumber>
    <OriginalCourseID>GEOG 201</OriginalCourseID>
    <CourseTitle>INTRO TO HUMAN GEOG</CourseTitle>
</Course>
</AcademicSession>
<AcademicSession>
    <AcademicSessionDetail>
        <SessionDesignator>1986-09</SessionDesignator>
        <SessionDesignatorSuffix>1</SessionDesignatorSuffix>
        <SessionName>FALL SEMESTER 1986</SessionName>
        <SessionType>Semester</SessionType>
    </AcademicSessionDetail>
    <AcademicProgram>
        <AcademicProgramName>NATURAL SCIENCES</AcademicProgramName>
    </AcademicProgram>
    <AcademicSummary>
        <NoteMessage>EFFECTIVE SPRING 1987 SCHOLASTIC PROBATION</NoteMessage>
        <Delinquencies>ProbationGPA</Delinquencies>
    </AcademicSummary>
</AcademicSession>
<AcademicSession>
    <AcademicSessionDetail>
        <SessionDesignator>1986-09</SessionDesignator>
        <SessionDesignatorSuffix>2</SessionDesignatorSuffix>
        <SessionName>FALL SEMESTER 1986</SessionName>
        <SessionType>Semester</SessionType>
    </AcademicSessionDetail>
    <AcademicProgram>
        <AcademicProgramName>ENGINEERING</AcademicProgramName>
    </AcademicProgram>
    <Course>
        <CourseCreditBasis>Regular</CourseCreditBasis>
        <CourseCreditUnits>Semester </CourseCreditUnits>
        <CourseCreditLevel>LowerDivision</CourseCreditLevel>
        <CourseCreditValue>3</CourseCreditValue>

```

```

        <CourseCreditEarned>3</CourseCreditEarned>
        <CourseAcademicGradeScaleCode>25</CourseAcademicGradeScaleCode>
        <CourseAcademicGrade>B</CourseAcademicGrade>
        <CourseCIPCode>999</CourseCIPCode>
        <CourseSubjectAbbreviation>GOV</CourseSubjectAbbreviation>
        <CourseNumber>310L</CourseNumber>
        <OriginalCourseID> </OriginalCourseID>
        <CourseTitle>AMERICAN GOVERNMENT</CourseTitle>
    </Course>
</Course>
<Course>
    <CourseCreditBasis>Regular</CourseCreditBasis>
    <CourseCreditUnits>Semester </CourseCreditUnits>
    <CourseCreditLevel>LowerDivision</CourseCreditLevel>
    <CourseCreditValue>3</CourseCreditValue>
    <CourseCreditEarned>0</CourseCreditEarned>
    <CourseAcademicGradeScaleCode>25</CourseAcademicGradeScaleCode>
    <CourseAcademicGrade>F</CourseAcademicGrade>
    <CourseCIPCode>999</CourseCIPCode>
    <CourseSubjectAbbreviation>HIS</CourseSubjectAbbreviation>
    <CourseNumber>309K</CourseNumber>
    <OriginalCourseID> </OriginalCourseID>
    <CourseTitle>WESTERN CIV IN MEDIEVAL TIMES</CourseTitle>
</Course>
</Course>
<Course>
    <CourseCreditBasis>Regular</CourseCreditBasis>
    <CourseCreditUnits>Semester </CourseCreditUnits>
    <CourseCreditLevel>LowerDivision</CourseCreditLevel>
    <CourseCreditValue>4</CourseCreditValue>
    <CourseCreditEarned>4</CourseCreditEarned>
    <CourseAcademicGradeScaleCode>25</CourseAcademicGradeScaleCode>
    <CourseAcademicGrade>C</CourseAcademicGrade>
    <CourseCIPCode>999</CourseCIPCode>
    <CourseSubjectAbbreviation>GEO</CourseSubjectAbbreviation>
    <CourseNumber>405</CourseNumber>
    <OriginalCourseID> </OriginalCourseID>
    <CourseTitle>LIFE THROUGH TIME</CourseTitle>
</Course>
</Course>
<Course>
    <CourseCreditBasis>Regular</CourseCreditBasis>
    <CourseCreditUnits>Semester </CourseCreditUnits>
    <CourseCreditLevel>LowerDivision</CourseCreditLevel>
    <CourseCreditValue>3</CourseCreditValue>
    <CourseCreditEarned>0</CourseCreditEarned>
    <CourseAcademicGradeScaleCode>25</CourseAcademicGradeScaleCode>
    <CourseAcademicGrade>F</CourseAcademicGrade>
    <CourseCIPCode>999</CourseCIPCode>
    <CourseSubjectAbbreviation>M</CourseSubjectAbbreviation>
    <CourseNumber>305G</CourseNumber>
    <OriginalCourseID> </OriginalCourseID>
    <CourseTitle>ELEM FUNCTIONS-COORD GEOMETRY</CourseTitle>
</Course>
</Course>
<AcademicSummary>
    <GPA>
        <CreditHoursAttempted>13</CreditHoursAttempted>
        <CreditHoursEarned>7</CreditHoursEarned>
        <CreditUnit>Semester </CreditUnit>
        <GradePointAverage>1.3076</GradePointAverage>
        <CreditHoursforGPA>13</CreditHoursforGPA>
    </GPA>
</AcademicSummary>
</AcademicSession>
<AcademicSession>
    <AcademicSessionDetail>
        <SessionDesignator>1987-01</SessionDesignator>
        <SessionDesignatorSuffix>2</SessionDesignatorSuffix>
        <SessionName>SPRING SEMESTER 1987</SessionName>
        <SessionType>Semester</SessionType>
    </AcademicSessionDetail>
</AcademicSession>
<AcademicProgram>
    <AcademicProgramName>LIBERAL ARTS</AcademicProgramName>

```

```

</AcademicProgram>
<Course>
  <CourseCreditBasis>Regular</CourseCreditBasis>
  <CourseCreditUnits>Semester </CourseCreditUnits>
  <CourseCreditLevel>LowerDivision</CourseCreditLevel>
  <CourseCreditValue>3</CourseCreditValue>
  <CourseCreditEarned>3</CourseCreditEarned>
  <CourseAcademicGradeScaleCode>25</CourseAcademicGradeScaleCode>
  <CourseAcademicGrade>C</CourseAcademicGrade>
  <CourseCIPCode>999</CourseCIPCode>
  <CourseSubjectAbbreviation>GOV</CourseSubjectAbbreviation>
  <CourseNumber>312L</CourseNumber>
  <OriginalCourseID> </OriginalCourseID>
  <CourseTitle>ISSUES & POLICIES IN AM GOV-FR</CourseTitle>
</Course>
<Course>
  <CourseCreditBasis>Regular</CourseCreditBasis>
  <CourseCreditUnits>Semester </CourseCreditUnits>
  <CourseCreditLevel>LowerDivision</CourseCreditLevel>
  <CourseCreditValue>3</CourseCreditValue>
  <CourseCreditEarned>3</CourseCreditEarned>
  <CourseAcademicGradeScaleCode>25</CourseAcademicGradeScaleCode>
  <CourseAcademicGrade>B</CourseAcademicGrade>
  <CourseCIPCode>999</CourseCIPCode>
  <CourseSubjectAbbreviation>HIS</CourseSubjectAbbreviation>
  <CourseNumber>309K</CourseNumber>
  <OriginalCourseID> </OriginalCourseID>
  <CourseTitle>WESTERN CIV IN MEDIEVAL TIMES</CourseTitle>
</Course>
<Course>
  <CourseCreditBasis>Regular</CourseCreditBasis>
  <CourseCreditUnits>Semester </CourseCreditUnits>
  <CourseCreditLevel>LowerDivision</CourseCreditLevel>
  <CourseCreditValue>3</CourseCreditValue>
  <CourseCreditEarned>3</CourseCreditEarned>
  <CourseAcademicGradeScaleCode>25</CourseAcademicGradeScaleCode>
  <CourseAcademicGrade>A</CourseAcademicGrade>
  <CourseCIPCode>999</CourseCIPCode>
  <CourseSubjectAbbreviation>PHL</CourseSubjectAbbreviation>
  <CourseNumber>318</CourseNumber>
  <OriginalCourseID> </OriginalCourseID>
  <CourseTitle>INTRODUCTION TO ETHICS</CourseTitle>
</Course>
<Course>
  <CourseCreditBasis>Regular</CourseCreditBasis>
  <CourseCreditUnits>Semester </CourseCreditUnits>
  <CourseCreditLevel>LowerDivision</CourseCreditLevel>
  <CourseCreditValue>3</CourseCreditValue>
  <CourseCreditEarned>0</CourseCreditEarned>
  <CourseAcademicGradeScaleCode>25</CourseAcademicGradeScaleCode>
  <CourseAcademicGrade>F</CourseAcademicGrade>
  <CourseCIPCode>999</CourseCIPCode>
  <CourseSubjectAbbreviation>M</CourseSubjectAbbreviation>
  <CourseNumber>305G</CourseNumber>
  <OriginalCourseID> </OriginalCourseID>
  <CourseTitle>ELEM FUNCTIONS-COORD GEOMETRY</CourseTitle>
</Course>
<AcademicSummary>
  <AcademicSummaryLevel>Undergraduate</AcademicSummaryLevel>
  <GPA>
    <CreditHoursAttempted>12</CreditHoursAttempted>
    <CreditHoursEarned>9</CreditHoursEarned>
    <CreditUnit>Semester </CreditUnit>
    <GradePointAverage>2.25</GradePointAverage>
    <CreditHoursforGPA>9</CreditHoursforGPA>
  </GPA>
  <NoteMessage>EFFECTIVE SUMMER 1987 SCHOLASTIC DISMISSAL - 1
  <Delinquencies>SuspensionGPA</Delinquencies>
</AcademicSummary>

```

SEMESTER</NoteMessage>

```

</AcademicSession>
<AcademicSession>
  <AcademicSessionDetail>
    <SessionDesignator>1988-01</SessionDesignator>
    <SessionDesignatorSuffix>1</SessionDesignatorSuffix>
    <SessionName>SPRING SEMESTER 1988</SessionName>
    <SessionType>Semester</SessionType>
  </AcademicSessionDetail>
  <AcademicProgram>
    <AcademicProgramName>LIBERAL ARTS</AcademicProgramName>
  </AcademicProgram>
  <Course>
    <CourseCreditBasis>CreditByExam</CourseCreditBasis>
    <CourseCreditUnits>Semester </CourseCreditUnits>
    <CourseCreditLevel>LowerDivision</CourseCreditLevel>
    <CourseCreditValue>3</CourseCreditValue>
    <CourseCreditEarned>3</CourseCreditEarned>
    <CourseAcademicGradeScaleCode>25</CourseAcademicGradeScaleCode>
    <CourseAcademicGrade>A</CourseAcademicGrade>
    <CourseCIPCode>999</CourseCIPCode>
    <CourseSubjectAbbreviation>SPN</CourseSubjectAbbreviation>
    <CourseNumber>312K</CourseNumber>
    <OriginalCourseID> </OriginalCourseID>
    <CourseTitle>2ND YR SPN I: ORL EXPR/RD/COMP</CourseTitle>
  </Course>
  <Course>
    <CourseCreditBasis>CreditByExam</CourseCreditBasis>
    <CourseCreditUnits>Semester </CourseCreditUnits>
    <CourseCreditLevel>LowerDivision</CourseCreditLevel>
    <CourseCreditValue>3</CourseCreditValue>
    <CourseCreditEarned>3</CourseCreditEarned>
    <CourseAcademicGradeScaleCode>25</CourseAcademicGradeScaleCode>
    <CourseAcademicGrade>A</CourseAcademicGrade>
    <CourseCIPCode>999</CourseCIPCode>
    <CourseSubjectAbbreviation>SPN</CourseSubjectAbbreviation>
    <CourseNumber>312L</CourseNumber>
    <OriginalCourseID> </OriginalCourseID>
    <CourseTitle>2ND YR SPN II-ORL EXPR/RD/COMP</CourseTitle>
  </Course>
  <AcademicSummary>
    <NoteMessage>EFFECTIVE SPRING 1988 SCHOLASTIC PROBATION</NoteMessage>
    <Delinquencies>SuspensionGPA</Delinquencies>
  </AcademicSummary>
</AcademicSession>
<AcademicSession>
  <AcademicSessionDetail>
    <SessionDesignator>1988-01</SessionDesignator>
    <SessionDesignatorSuffix>2</SessionDesignatorSuffix>
    <SessionName>SPRING SEMESTER 1988</SessionName>
    <SessionType>Semester</SessionType>
  </AcademicSessionDetail>
  <AcademicProgram>
    <AcademicProgramName>LIBERAL ARTS</AcademicProgramName>
  </AcademicProgram>
  <Course>
    <CourseCreditBasis>Regular</CourseCreditBasis>
    <CourseCreditUnits>Semester </CourseCreditUnits>
    <CourseCreditLevel>UpperDivision</CourseCreditLevel>
    <CourseCreditValue>3</CourseCreditValue>
    <CourseCreditEarned>3</CourseCreditEarned>
    <CourseAcademicGradeScaleCode>25</CourseAcademicGradeScaleCode>
    <CourseAcademicGrade>A</CourseAcademicGrade>
    <CourseCIPCode>999</CourseCIPCode>
    <CourseSubjectAbbreviation>GOV</CourseSubjectAbbreviation>
    <CourseNumber>320K</CourseNumber>
    <OriginalCourseID> </OriginalCourseID>
    <CourseTitle>AMER CONSTITUTIONAL DEVEL</CourseTitle>
  </Course>
  <Course>
    <CourseCreditBasis>Regular</CourseCreditBasis>

```

```

        <CourseCreditUnits>Semester </CourseCreditUnits>
        <CourseCreditLevel>LowerDivision</CourseCreditLevel>
        <CourseCreditValue>3</CourseCreditValue>
        <CourseCreditEarned>3</CourseCreditEarned>
        <CourseAcademicGradeScaleCode>25</CourseAcademicGradeScaleCode>
        <CourseAcademicGrade>A</CourseAcademicGrade>
        <CourseCIPCode>999</CourseCIPCode>
        <CourseSubjectAbbreviation>HIS</CourseSubjectAbbreviation>
        <CourseNumber>309L</CourseNumber>
        <OriginalCourseID> </OriginalCourseID>
        <CourseTitle>WESTERN CIV IN MODERN TIMES</CourseTitle>
    </Course>
</Course>
<Course>
    <CourseCreditBasis>Regular</CourseCreditBasis>
    <CourseCreditUnits>Semester </CourseCreditUnits>
    <CourseCreditLevel>UpperDivision</CourseCreditLevel>
    <CourseCreditValue>3</CourseCreditValue>
    <CourseCreditEarned>3</CourseCreditEarned>
    <CourseAcademicGradeScaleCode>25</CourseAcademicGradeScaleCode>
    <CourseAcademicGrade>A</CourseAcademicGrade>
    <CourseCIPCode>999</CourseCIPCode>
    <CourseSubjectAbbreviation>HIS</CourseSubjectAbbreviation>
    <CourseNumber>332G</CourseNumber>
    <OriginalCourseID> </OriginalCourseID>
    <CourseTitle>EUR INTELL HIST, A SMITH-FREUD</CourseTitle>
</Course>
<Course>
    <CourseCreditBasis>Regular</CourseCreditBasis>
    <CourseCreditUnits>Semester </CourseCreditUnits>
    <CourseCreditLevel>LowerDivision</CourseCreditLevel>
    <CourseCreditValue>3</CourseCreditValue>
    <CourseCreditEarned>3</CourseCreditEarned>
    <CourseAcademicGradeScaleCode>25</CourseAcademicGradeScaleCode>
    <CourseAcademicGrade>B</CourseAcademicGrade>
    <CourseCIPCode>999</CourseCIPCode>
    <CourseSubjectAbbreviation>AST</CourseSubjectAbbreviation>
    <CourseNumber>303</CourseNumber>
    <OriginalCourseID> </OriginalCourseID>
    <CourseTitle>INTRO TO AST WITH CELESTL OBS</CourseTitle>
</Course>
<Course>
    <CourseCreditBasis>Regular</CourseCreditBasis>
    <CourseCreditUnits>Semester </CourseCreditUnits>
    <CourseCreditLevel>LowerDivision</CourseCreditLevel>
    <CourseCreditValue>3</CourseCreditValue>
    <CourseCreditEarned>3</CourseCreditEarned>
    <CourseAcademicGradeScaleCode>25</CourseAcademicGradeScaleCode>
    <CourseAcademicGrade>C</CourseAcademicGrade>
    <CourseCIPCode>999</CourseCIPCode>
    <CourseSubjectAbbreviation>M</CourseSubjectAbbreviation>
    <CourseNumber>305G</CourseNumber>
    <OriginalCourseID> </OriginalCourseID>
    <CourseTitle>ELEM FUNCTIONS/COORD GEOMETRY</CourseTitle>
</Course>
<AcademicSummary>
    <AcademicSummaryLevel>Undergraduate</AcademicSummaryLevel>
    <GPA>
        <CreditHoursAttempted>15</CreditHoursAttempted>
        <CreditHoursEarned>15</CreditHoursEarned>
        <CreditUnit>Semester </CreditUnit>
        <GradePointAverage>3.4</GradePointAverage>
        <CreditHoursforGPA>15</CreditHoursforGPA>
    </GPA>
    <NoteMessage>EFFECTIVE SUMMER 1988 PROBATION ENDED
    <Delinquencies>GoodStanding</Delinquencies>
</AcademicSummary>
</AcademicSession>
<AcademicSession>
    <AcademicSessionDetail>

```

```

        <SessionDesignator>1988-06</SessionDesignator>
        <SessionDesignatorSuffix>1</SessionDesignatorSuffix>
        <SessionName>SUMMER SEMESTER 1988</SessionName>
        <SessionType>SummerSession</SessionType>
    </AcademicSessionDetail>
</AcademicProgram>
<AcademicProgram>
    <AcademicProgramName>LIBERAL ARTS</AcademicProgramName>
</AcademicProgram>
<Course>
    <CourseCreditBasis>CreditByExam</CourseCreditBasis>
    <CourseCreditUnits>Semester </CourseCreditUnits>
    <CourseCreditLevel>UpperDivision</CourseCreditLevel>
    <CourseCreditValue>3</CourseCreditValue>
    <CourseCreditEarned>3</CourseCreditEarned>
    <CourseAcademicGradeScaleCode>25</CourseAcademicGradeScaleCode>
    <CourseAcademicGrade>A</CourseAcademicGrade>
    <CourseCIPCode>999</CourseCIPCode>
    <CourseSubjectAbbreviation>HIS</CourseSubjectAbbreviation>
    <CourseNumber>346K</CourseNumber>
    <OriginalCourseID> </OriginalCourseID>
    <CourseTitle>LATIN AMERICA BEFORE 1810</CourseTitle>
    <CourseOverrideSchool>
        <OrganizationName>AUSTIN COMMUNITY COLLEGE</OrganizationName>
        <ATP>006759</ATP>
    </CourseOverrideSchool>
</Course>
</AcademicSession>
<AcademicSession>
    <AcademicSessionDetail>
        <SessionDesignator>1988-06</SessionDesignator>
        <SessionDesignatorSuffix>2</SessionDesignatorSuffix>
    </AcademicSessionDetail>
    <AcademicProgram>
        <AcademicProgramName>LIBERAL ARTS</AcademicProgramName>
    </AcademicProgram>
    <Course>
        <CourseCreditBasis>Regular</CourseCreditBasis>
        <CourseCreditUnits>Semester </CourseCreditUnits>
        <CourseCreditLevel>LowerDivision</CourseCreditLevel>
        <CourseCreditValue>3</CourseCreditValue>
        <CourseCreditEarned>3</CourseCreditEarned>
        <CourseAcademicGradeScaleCode>25</CourseAcademicGradeScaleCode>
        <CourseAcademicGrade>A</CourseAcademicGrade>
        <CourseRepeatCode>NotCountedOther</CourseRepeatCode>
        <CourseCIPCode>999</CourseCIPCode>
        <CourseSubjectAbbreviation>E</CourseSubjectAbbreviation>
        <CourseNumber>316K</CourseNumber>
        <OriginalCourseID>ENG 2633</OriginalCourseID>
        <CourseTitle>AMERICAN LITERATURE 1</CourseTitle>
    </Course>
    <Course>
        <CourseCreditBasis>Regular</CourseCreditBasis>
        <CourseCreditUnits>Semester </CourseCreditUnits>
        <CourseCreditLevel>Undergraduate</CourseCreditLevel>
        <CourseCreditValue>4</CourseCreditValue>
        <CourseCreditEarned>4</CourseCreditEarned>
        <CourseAcademicGradeScaleCode>25</CourseAcademicGradeScaleCode>
        <CourseAcademicGrade>A</CourseAcademicGrade>
        <CourseRepeatCode>NotCountedOther</CourseRepeatCode>
        <CourseCIPCode>999</CourseCIPCode>
        <CourseSubjectAbbreviation>C S</CourseSubjectAbbreviation>
        <CourseNumber>4ADV</CourseNumber>
        <OriginalCourseID>CIS 1064</OriginalCourseID>
        <CourseTitle>ASSEMBLY LANGUAGE</CourseTitle>
    </Course>
</AcademicSession>
<AcademicSession>
    <AcademicSessionDetail>
        <SessionDesignator>1988-09</SessionDesignator>
        <SessionDesignatorSuffix>1</SessionDesignatorSuffix>

```

```

        <SessionName>FALL SEMESTER 1988</SessionName>
        <SessionType>Semester</SessionType>
    </AcademicSessionDetail>
    <AcademicProgram>
        <AcademicProgramName>LIBERAL ARTS</AcademicProgramName>
    </AcademicProgram>
    <Course>
        <CourseCreditBasis>Regular</CourseCreditBasis>
        <CourseCreditUnits>Semester </CourseCreditUnits>
        <CourseCreditLevel>LowerDivision</CourseCreditLevel>
        <CourseCreditValue>0</CourseCreditValue>
        <CourseCreditEarned>0</CourseCreditEarned>
        <CourseAcademicGradeScaleCode>500</CourseAcademicGradeScaleCode>
        <CourseRepeatCode>NotCountedOther</CourseRepeatCode>
        <CourseCIPCode>999</CourseCIPCode>
        <CourseSubjectAbbreviation>SAB</CourseSubjectAbbreviation>
        <CourseNumber>0</CourseNumber>
        <CourseTitle>STUDY ABROAD EXCHANGE PROGRAMS</CourseTitle>
    </Course>
    <Course>
        <CourseCreditBasis>Regular</CourseCreditBasis>
        <CourseCreditUnits>Semester </CourseCreditUnits>
        <CourseCreditLevel>LowerDivision</CourseCreditLevel>
        <CourseCreditValue>0</CourseCreditValue>
        <CourseCreditEarned>0</CourseCreditEarned>
        <CourseAcademicGradeScaleCode>500</CourseAcademicGradeScaleCode>
        <CourseRepeatCode>NotCountedOther</CourseRepeatCode>
        <CourseCIPCode>999</CourseCIPCode>
        <CourseSubjectAbbreviation>SAB</CourseSubjectAbbreviation>
        <CourseNumber>0</CourseNumber>
        <CourseTitle>STUDY ABROAD EXCHANGE PROGRAMS</CourseTitle>
    </Course>
    <Course>
        <CourseCreditBasis>Regular</CourseCreditBasis>
        <CourseCreditUnits>Semester </CourseCreditUnits>
        <CourseCreditLevel>UpperDivision</CourseCreditLevel>
        <CourseCreditValue>3</CourseCreditValue>
        <CourseCreditEarned>3</CourseCreditEarned>
        <CourseAcademicGradeScaleCode>25</CourseAcademicGradeScaleCode>
        <CourseAcademicGrade>A</CourseAcademicGrade>
        <CourseCIPCode>999</CourseCIPCode>
        <CourseSubjectAbbreviation>GOV</CourseSubjectAbbreviation>
        <CourseNumber>336L</CourseNumber>
        <CourseTitle>INTERNATIONAL LAW</CourseTitle>
    </Course>
    <Course>
        <CourseCreditBasis>Regular</CourseCreditBasis>
        <CourseCreditUnits>Semester </CourseCreditUnits>
        <CourseCreditLevel>UpperDivision</CourseCreditLevel>
        <CourseCreditValue>3</CourseCreditValue>
        <CourseCreditEarned>3</CourseCreditEarned>
        <CourseAcademicGradeScaleCode>25</CourseAcademicGradeScaleCode>
        <CourseAcademicGrade>A</CourseAcademicGrade>
        <CourseCIPCode>999</CourseCIPCode>
        <CourseSubjectAbbreviation>HIS</CourseSubjectAbbreviation>
        <CourseNumber>321</CourseNumber>
        <CourseTitle>HISTORY OF ROME-THE EMPIRE</CourseTitle>
    </Course>
    <Course>
        <CourseCreditBasis>Regular</CourseCreditBasis>
        <CourseCreditUnits>Semester </CourseCreditUnits>
        <CourseCreditLevel>UpperDivision</CourseCreditLevel>
        <CourseCreditValue>3</CourseCreditValue>
        <CourseCreditEarned>3</CourseCreditEarned>
        <CourseAcademicGradeScaleCode>25</CourseAcademicGradeScaleCode>
        <CourseAcademicGrade>A</CourseAcademicGrade>
        <CourseCIPCode>999</CourseCIPCode>
        <CourseSubjectAbbreviation>C C</CourseSubjectAbbreviation>
        <CourseNumber>331</CourseNumber>
        <CourseTitle>ROMAN GOVERNMENT</CourseTitle>
    </Course>

```

```

</Course>
<Course>
  <CourseCreditBasis>Regular</CourseCreditBasis>
  <CourseCreditUnits>Semester </CourseCreditUnits>
  <CourseCreditLevel>UpperDivision</CourseCreditLevel>
  <CourseCreditValue>3</CourseCreditValue>
  <CourseCreditEarned>3</CourseCreditEarned>
  <CourseAcademicGradeScaleCode>25</CourseAcademicGradeScaleCode>
  <CourseAcademicGrade>A</CourseAcademicGrade>
  <CourseCIPCode>999</CourseCIPCode>
  <CourseSubjectAbbreviation>GOV</CourseSubjectAbbreviation>
  <CourseNumber>360N</CourseNumber>
  <CourseTitle>POLITICS AND THE INTL ECONOMY</CourseTitle>
</Course>
<AcademicSummary>
  <AcademicSummaryLevel>Undergraduate</AcademicSummaryLevel>
  <GPA>
    <CreditHoursAttempted>12</CreditHoursAttempted>
    <CreditHoursEarned> 12</CreditHoursEarned>
    <CreditUnit>Semester </CreditUnit>
    <GradePointAverage>4</GradePointAverage>
    <CreditHoursforGPA>12</CreditHoursforGPA>
  </GPA>
</AcademicSummary>
<NoteMessage>WORK TAKEN AT UNIVERSITY OF ROME, ITALY
</NoteMessage>
</AcademicSession>
<AcademicSession>
  <AcademicSessionDetail>
    <SessionDesignator>1989-01</SessionDesignator>
    <SessionDesignatorSuffix> 1</SessionDesignatorSuffix>
    <SessionName>SPRING SEMESTER 1989</SessionName>
    <SessionType>Semester</SessionType>
  </AcademicSessionDetail>
  <AcademicProgram>
    <AcademicProgramName>LIBERAL ARTS</AcademicProgramName>
  </AcademicProgram>
  <Course>
    <CourseCreditBasis>Regular</CourseCreditBasis>
    <CourseCreditUnits>Semester </CourseCreditUnits>
    <CourseCreditLevel>UpperDivision</CourseCreditLevel>
    <CourseCreditValue>3</CourseCreditValue>
    <CourseCreditEarned>3</CourseCreditEarned>
    <CourseAcademicGradeScaleCode>25</CourseAcademicGradeScaleCode>
    <CourseAcademicGrade>A</CourseAcademicGrade>
    <CourseCIPCode>999</CourseCIPCode>
    <CourseSubjectAbbreviation>GOV</CourseSubjectAbbreviation>
    <CourseNumber>327L</CourseNumber>
    <CourseTitle>PUBLIC OPINION AND AMER POL</CourseTitle>
  </Course>
  <Course>
    <CourseCreditBasis>Regular</CourseCreditBasis>
    <CourseCreditUnits>Semester </CourseCreditUnits>
    <CourseCreditLevel>UpperDivision</CourseCreditLevel>
    <CourseCreditValue>3</CourseCreditValue>
    <CourseCreditEarned>3</CourseCreditEarned>
    <CourseAcademicGradeScaleCode>25</CourseAcademicGradeScaleCode>
    <CourseAcademicGrade>A</CourseAcademicGrade>
    <CourseCIPCode>999</CourseCIPCode>
    <CourseSubjectAbbreviation>GOV</CourseSubjectAbbreviation>
    <CourseNumber>344</CourseNumber>
    <CourseTitle>AMERICAN FOREIGN RELATIONS</CourseTitle>
  </Course>
  <Course>
    <CourseCreditBasis>Regular</CourseCreditBasis>
    <CourseCreditUnits>Semester </CourseCreditUnits>
    <CourseCreditLevel>UpperDivision</CourseCreditLevel>
    <CourseCreditValue>3</CourseCreditValue>
    <CourseCreditEarned>3</CourseCreditEarned>
    <CourseAcademicGradeScaleCode>25</CourseAcademicGradeScaleCode>

```

```

        <CourseAcademicGrade>B</CourseAcademicGrade>
        <CourseCIPCode>999</CourseCIPCode>
        <CourseSubjectAbbreviation>HIS</CourseSubjectAbbreviation>
        <CourseNumber>320L</CourseNumber>
        <CourseTitle>TEXAS UNTIL 1845</CourseTitle>
    </Course>
</Course>
<Course>
    <CourseCreditBasis>Regular</CourseCreditBasis>
    <CourseCreditUnits>Semester </CourseCreditUnits>
    <CourseCreditLevel>LowerDivision</CourseCreditLevel>
    <CourseCreditValue>3</CourseCreditValue>
    <CourseCreditEarned>3</CourseCreditEarned>
    <CourseAcademicGradeScaleCode>25</CourseAcademicGradeScaleCode>
    <CourseAcademicGrade>A</CourseAcademicGrade>
    <CourseCIPCode>999</CourseCIPCode>
    <CourseSubjectAbbreviation>BIO</CourseSubjectAbbreviation>
    <CourseNumber>301M</CourseNumber>
    <CourseTitle>ECOLOGY, EVOLUTION, & SOCIETY</CourseTitle>
</Course>
<AcademicSummary>
    <AcademicSummaryLevel>Undergraduate</AcademicSummaryLevel>
    <GPA>
        <CreditHoursAttempted>12</CreditHoursAttempted>
        <CreditHoursEarned>12</CreditHoursEarned>
        <CreditUnit>Semester </CreditUnit>
        <GradePointAverage>3.75</GradePointAverage>
        <CreditHoursforGPA>12</CreditHoursforGPA>
    </GPA>
</AcademicSummary>
</AcademicSession>
<AcademicSession>
    <AcademicSessionDetail>
        <SessionDesignator>1989-09</SessionDesignator>
        <SessionDesignatorSuffix>1</SessionDesignatorSuffix>
        <SessionName>FALL SEMESTER 1989</SessionName>
        <SessionType>Semester</SessionType>
    </AcademicSessionDetail>
    <AcademicProgram>
        <AcademicProgramName>LIBERAL ARTS</AcademicProgramName>
    </AcademicProgram>
</Course>
<Course>
    <CourseCreditBasis>Regular</CourseCreditBasis>
    <CourseCreditUnits>Semester </CourseCreditUnits>
    <CourseCreditLevel>UpperDivision</CourseCreditLevel>
    <CourseCreditValue>3</CourseCreditValue>
    <CourseCreditEarned>3</CourseCreditEarned>
    <CourseAcademicGradeScaleCode>25</CourseAcademicGradeScaleCode>
    <CourseAcademicGrade>A</CourseAcademicGrade>
    <CourseCIPCode>999</CourseCIPCode>
    <CourseSubjectAbbreviation>GOV</CourseSubjectAbbreviation>
    <CourseNumber>357M</CourseNumber>
    <CourseTitle>JURISPRUDENCE</CourseTitle>
</Course>
</Course>
<Course>
    <CourseCreditBasis>Regular</CourseCreditBasis>
    <CourseCreditUnits>Semester </CourseCreditUnits>
    <CourseCreditLevel>UpperDivision</CourseCreditLevel>
    <CourseCreditValue>3</CourseCreditValue>
    <CourseCreditEarned>3</CourseCreditEarned>
    <CourseAcademicGradeScaleCode>25</CourseAcademicGradeScaleCode>
    <CourseAcademicGrade>A</CourseAcademicGrade>
    <CourseCIPCode>999</CourseCIPCode>
    <CourseSubjectAbbreviation>GOV</CourseSubjectAbbreviation>
    <CourseNumber>358</CourseNumber>
    <CourseTitle>INTRO TO PUBLIC ADMINISTRATION</CourseTitle>
</Course>
</Course>
<Course>
    <CourseCreditBasis>Regular</CourseCreditBasis>
    <CourseCreditUnits>Semester </CourseCreditUnits>
    <CourseCreditLevel>UpperDivision</CourseCreditLevel>

```

```

        <CourseCreditValue>3</CourseCreditValue>
        <CourseCreditEarned>3</CourseCreditEarned>
        <CourseAcademicGradeScaleCode>25</CourseAcademicGradeScaleCode>
        <CourseAcademicGrade>A</CourseAcademicGrade>
        <CourseCIPCode>999</CourseCIPCode>
        <CourseSubjectAbbreviation>HIS</CourseSubjectAbbreviation>
        <CourseNumber>344D</CourseNumber>
        <CourseTitle>ENGLAND IN THE MIDDLE AGES</CourseTitle>
    </Course>
    <Course>
        <CourseCreditBasis>Regular</CourseCreditBasis>
        <CourseCreditUnits>Semester </CourseCreditUnits>
        <CourseCreditLevel>UpperDivision</CourseCreditLevel>
        <CourseCreditValue>3</CourseCreditValue>
        <CourseCreditEarned>3</CourseCreditEarned>
        <CourseAcademicGradeScaleCode>25</CourseAcademicGradeScaleCode>
        <CourseAcademicGrade>A</CourseAcademicGrade>
        <CourseCIPCode>999</CourseCIPCode>
        <CourseSubjectAbbreviation>HIS</CourseSubjectAbbreviation>
        <CourseNumber>350L</CourseNumber>
        <CourseTitle>FIRST LADIES IN THE 20TH CEN</CourseTitle>
    </Course>
    <AcademicSummary>
        <AcademicSummaryLevel>Undergraduate</AcademicSummaryLevel>
        <GPA>
            <CreditHoursAttempted>12</CreditHoursAttempted>
            <CreditHoursEarned>12</CreditHoursEarned>
            <CreditUnit>Semester </CreditUnit>
            <GradePointAverage>4</GradePointAverage>
            <CreditHoursforGPA>12</CreditHoursforGPA>
        </GPA>
    </AcademicSummary>
</AcademicSession>
<AcademicSession>
    <AcademicSessionDetail>
        <SessionDesignator>1990-01</SessionDesignator>
        <SessionDesignatorSuffix>1</SessionDesignatorSuffix>
        <SessionName>SPRING SEMESTER 1990</SessionName>
        <SessionType>Semester</SessionType>
    </AcademicSessionDetail>
    <AcademicProgram>
        <AcademicProgramName>LIBERAL ARTS</AcademicProgramName>
    </AcademicProgram>
    <AcademicAward>
        <AcademicAwardLevel>2.4</AcademicAwardLevel>
        <AcademicAwardDate>1990-05-09</AcademicAwardDate>
        <AcademicAwardTitle>BACHELOR OF ARTS
</AcademicAwardTitle>
        <AcademicHonors>
            <HonorsLevel>ThirdHighest</HonorsLevel>
        </AcademicHonors>
        <AcademicAwardProgram>
            <AcademicProgramName>MAJOR: GOVERNMENT</AcademicProgramName>
        </AcademicAwardProgram>
        <AcademicAwardProgram>
            <AcademicProgramName>SECOND MAJOR
HISTORY</AcademicProgramName>
        </AcademicAwardProgram>
    </AcademicAward>
    <Course>
        <CourseCreditBasis>Regular</CourseCreditBasis>
        <CourseCreditUnits>Semester </CourseCreditUnits>
        <CourseCreditLevel>UpperDivision</CourseCreditLevel>
        <CourseCreditValue>3</CourseCreditValue>
        <CourseCreditEarned>3</CourseCreditEarned>
        <CourseAcademicGradeScaleCode>25</CourseAcademicGradeScaleCode>
        <CourseAcademicGrade>A</CourseAcademicGrade>
        <CourseCIPCode>999</CourseCIPCode>
        <CourseSubjectAbbreviation>GOV</CourseSubjectAbbreviation>
        <CourseNumber>321</CourseNumber>

```

```

        <CourseTitle>AMERICAN STATE POLITICS</CourseTitle>
    </Course>
    <Course>
        <CourseCreditBasis>Regular</CourseCreditBasis>
        <CourseCreditUnits>Semester </CourseCreditUnits>
        <CourseCreditLevel>UpperDivision</CourseCreditLevel>
        <CourseCreditValue>3</CourseCreditValue>
        <CourseCreditEarned>3</CourseCreditEarned>
        <CourseAcademicGradeScaleCode>25</CourseAcademicGradeScaleCode>
        <CourseAcademicGrade>A</CourseAcademicGrade>
        <CourseCIPCode>999</CourseCIPCode>
        <CourseSubjectAbbreviation>GOV</CourseSubjectAbbreviation>
        <CourseNumber>348</CourseNumber>
        <CourseTitle>GOVERNMENT AND AMER ECONOMY</CourseTitle>
    </Course>
    <Course>
        <CourseCreditBasis>Regular</CourseCreditBasis>
        <CourseCreditUnits>Semester </CourseCreditUnits>
        <CourseCreditLevel>UpperDivision</CourseCreditLevel>
        <CourseCreditValue>3</CourseCreditValue>
        <CourseCreditEarned>3</CourseCreditEarned>
        <CourseAcademicGradeScaleCode>25</CourseAcademicGradeScaleCode>
        <CourseAcademicGrade>A</CourseAcademicGrade>
        <CourseCIPCode>999</CourseCIPCode>
        <CourseSubjectAbbreviation>HIS</CourseSubjectAbbreviation>
        <CourseNumber>320P</CourseNumber>
        <CourseTitle>TEXAS, 1845-1914</CourseTitle>
    </Course>
    <Course>
        <CourseCreditBasis>Regular</CourseCreditBasis>
        <CourseCreditUnits>Semester </CourseCreditUnits>
        <CourseCreditLevel>UpperDivision</CourseCreditLevel>
        <CourseCreditValue>3</CourseCreditValue>
        <CourseCreditEarned>3</CourseCreditEarned>
        <CourseAcademicGradeScaleCode>25</CourseAcademicGradeScaleCode>
        <CourseAcademicGrade>A</CourseAcademicGrade>
        <CourseCIPCode>999</CourseCIPCode>
        <CourseSubjectAbbreviation>HIS</CourseSubjectAbbreviation>
        <CourseNumber>331N</CourseNumber>
        <CourseTitle>MIDDLE EAST SINCE 1914</CourseTitle>
    </Course>
    <AcademicSummary>
        <AcademicSummaryLevel>Undergraduate</AcademicSummaryLevel>
        <GPA>
            <CreditHoursAttempted>12</CreditHoursAttempted>
            <CreditHoursEarned>12</CreditHoursEarned>
            <CreditUnit>Semester </CreditUnit>
            <GradePointAverage>4</GradePointAverage>
            <CreditHoursforGPA>12</CreditHoursforGPA>
        </GPA>
    </AcademicSummary>
</AcademicSession>
<AcademicSession>
    <AcademicSessionDetail>
        <SessionDesignator>1997-09</SessionDesignator>
        <SessionDesignatorSuffix>1</SessionDesignatorSuffix>
        <SessionName>FALL SEMESTER 1997

        <SessionType>Semester</SessionType>
    </AcademicSessionDetail>
    <AcademicProgram>
        <AcademicProgramName>LIBERAL ARTS</AcademicProgramName>
    </AcademicProgram>
    <Course>
        <CourseCreditBasis>AcademicRenewal</CourseCreditBasis>
        <CourseCreditUnits>Semester </CourseCreditUnits>
        <CourseCreditLevel>LowerDivision</CourseCreditLevel>
        <CourseCreditValue>3</CourseCreditValue>
        <CourseCreditEarned>0</CourseCreditEarned>
        <CourseAcademicGradeScaleCode>25</CourseAcademicGradeScaleCode>

```



```

        <CourseAcademicGrade>F</CourseAcademicGrade>
        <CourseCIPCode>999</CourseCIPCode>
        <CourseSubjectAbbreviation>E</CourseSubjectAbbreviation>
        <CourseNumber>316K</CourseNumber>
        <CourseTitle>MASTERWORKS OF LIT: AMERICAN</CourseTitle>
        <NoteMessage>ORIGINAL GRADE X</NoteMessage>
    </Course>
    <Course>
        <CourseCreditBasis>Regular</CourseCreditBasis>
        <CourseCreditUnits>Semester </CourseCreditUnits>
        <CourseCreditLevel>UpperDivision</CourseCreditLevel>
        <CourseCreditValue>3</CourseCreditValue>
        <CourseCreditEarned>0</CourseCreditEarned>
        <CourseAcademicGradeScaleCode>25</CourseAcademicGradeScaleCode>
        <CourseAcademicGrade>F</CourseAcademicGrade>
        <CourseCIPCode>999</CourseCIPCode>
        <CourseSubjectAbbreviation>GRG</CourseSubjectAbbreviation>
        <CourseNumber>337</CourseNumber>
        <CourseTitle>THE MODERN AMERICAN CITY</CourseTitle>
    </Course>
    <Course>
        <CourseCreditBasis>Regular</CourseCreditBasis>
        <CourseCreditUnits>Semester </CourseCreditUnits>
        <CourseCreditLevel>LowerDivision</CourseCreditLevel>
        <CourseCreditValue>5</CourseCreditValue>
        <CourseCreditEarned>0</CourseCreditEarned>
        <CourseAcademicGradeScaleCode>25</CourseAcademicGradeScaleCode>
        <CourseAcademicGrade>F</CourseAcademicGrade>
        <CourseCIPCode>999</CourseCIPCode>
        <CourseSubjectAbbreviation>GER</CourseSubjectAbbreviation>
        <CourseNumber>507</CourseNumber>
        <CourseTitle>FIRST-YEAR GERMAN II</CourseTitle>
    </Course>
    <AcademicSummary>
        <AcademicSummaryLevel>Undergraduate</AcademicSummaryLevel>
        <GPA>
            <CreditHoursAttempted>11</CreditHoursAttempted>
            <CreditHoursEarned>0</CreditHoursEarned>
            <CreditUnit>Semester </CreditUnit>
            <GradePointAverage>0</GradePointAverage>
            <CreditHoursforGPA>11</CreditHoursforGPA>
        </GPA>
    </AcademicSummary>
</AcademicSession>
<AcademicSession>
    <AcademicSessionDetail>
        <SessionDesignator>1998-01</SessionDesignator>
        <SessionDesignatorSuffix>1</SessionDesignatorSuffix>
        <SessionName>SPRING SEMESTER 1998</SessionName>
        <SessionType>Semester</SessionType>
    </AcademicSessionDetail>
    <AcademicProgram>
        <AcademicProgramName>LIBERAL ARTS</AcademicProgramName>
    </AcademicProgram>
    <AcademicAward>
        <AcademicAwardLevel>2.4</AcademicAwardLevel>
        <AcademicAwardDate>1998-05-23</AcademicAwardDate>
        <AcademicAwardTitle>BACHELOR OF SCIENCE IN ELECTRICAL
ENGINEERING</AcademicAwardTitle>
        <AcademicAwardProgram>
            <AcademicProgramName>MAJOR: ELECTRICAL ENGINEERING, COMPUTER
ENGINEERING </AcademicProgramName>
        </AcademicAwardProgram>
    </AcademicAward>
</AcademicSession>
<AcademicSession>
    <AcademicSessionDetail>
        <SessionDesignator>2000-09</SessionDesignator>
        <SessionDesignatorSuffix>1</SessionDesignatorSuffix>
        <SessionName>FALL SEMESTER 2000</SessionName>

```

```

        <SessionType>Semester</SessionType>
    </AcademicSessionDetail>
    <AcademicProgram>
        <AcademicProgramName>NATURAL SCIENCES</AcademicProgramName>
    </AcademicProgram>
    <Course>
        <CourseCreditBasis>AcademicRenewal</CourseCreditBasis>
        <CourseCreditUnits>Semester </CourseCreditUnits>
        <CourseCreditLevel>UpperDivision</CourseCreditLevel>
        <CourseCreditValue>3</CourseCreditValue>
        <CourseCreditEarned>3</CourseCreditEarned>
        <CourseAcademicGradeScaleCode>25</CourseAcademicGradeScaleCode>
        <CourseAcademicGrade>A</CourseAcademicGrade>
        <CourseCIPCode>999</CourseCIPCode>
        <CourseSubjectAbbreviation>MAN</CourseSubjectAbbreviation>
        <CourseNumber>320F</CourseNumber>
        <CourseTitle>FOUNDS OF ORG BEHAV AND ADMIN</CourseTitle>
        <NoteMessage>ORIGINAL GRADE X</NoteMessage>
    </Course>
    <Course>
        <CourseCreditBasis>Regular</CourseCreditBasis>
        <CourseCreditUnits>Semester </CourseCreditUnits>
        <CourseCreditLevel>UpperDivision</CourseCreditLevel>
        <CourseCreditValue>3</CourseCreditValue>
        <CourseCreditEarned>3</CourseCreditEarned>
        <CourseAcademicGradeScaleCode>25</CourseAcademicGradeScaleCode>
        <CourseAcademicGrade>B</CourseAcademicGrade>
        <CourseCIPCode>999</CourseCIPCode>
        <CourseSubjectAbbreviation>LEB</CourseSubjectAbbreviation>
        <CourseNumber>320F</CourseNumber>
        <CourseTitle>FOUNDS OF LEGAL ENVIR OF BUSN</CourseTitle>
    </Course>
    <Course>
        <CourseCreditBasis>Regular</CourseCreditBasis>
        <CourseCreditUnits>Semester </CourseCreditUnits>
        <CourseCreditLevel>UpperDivision</CourseCreditLevel>
        <CourseCreditValue>3</CourseCreditValue>
        <CourseCreditEarned>3</CourseCreditEarned>
        <CourseAcademicGradeScaleCode>501</CourseAcademicGradeScaleCode>
        <CourseAcademicGrade>CR</CourseAcademicGrade>
        <CourseRepeatCode>NotCountedOther</CourseRepeatCode>
        <CourseCIPCode>999</CourseCIPCode>
        <CourseSubjectAbbreviation>GRG</CourseSubjectAbbreviation>
        <CourseNumber>341K</CourseNumber>
        <CourseTitle>GRG OF MEXICO AND CARIBBN AMER</CourseTitle>
    </Course>
    <Course>
        <CourseCreditBasis>Regular</CourseCreditBasis>
        <CourseCreditUnits>Semester </CourseCreditUnits>
        <CourseCreditLevel>LowerDivision</CourseCreditLevel>
        <CourseCreditValue>3</CourseCreditValue>
        <CourseCreditEarned>0</CourseCreditEarned>
        <CourseAcademicGradeScaleCode>25</CourseAcademicGradeScaleCode>
        <CourseAcademicGrade>F</CourseAcademicGrade>
        <CourseCIPCode>999</CourseCIPCode>
        <CourseSubjectAbbreviation>C S</CourseSubjectAbbreviation>
        <CourseNumber>310</CourseNumber>
        <CourseTitle>COMPUTER ORGANIZATION AND PROG</CourseTitle>
    </Course>
    <AcademicSummary>
        <AcademicSummaryLevel>Undergraduate</AcademicSummaryLevel>
        <GPA>
            <CreditHoursAttempted>12</CreditHoursAttempted>
            <CreditHoursEarned>9</CreditHoursEarned>
            <CreditUnit>Semester </CreditUnit>
            <GradePointAverage>2.3333</GradePointAverage>
            <CreditHoursforGPA>9</CreditHoursforGPA>
        </GPA>
    </AcademicSummary>
</AcademicSession>

```

```

<AcademicSession>
  <AcademicSessionDetail>
    <SessionDesignator>2001-01</SessionDesignator>
    <SessionDesignatorSuffix>1</SessionDesignatorSuffix>
    <SessionName>SPRING SEMESTER 2001</SessionName>
    <SessionType>Semester</SessionType>
  </AcademicSessionDetail>
  <AcademicProgram>
    <AcademicProgramName>INTERNATIONAL EXCHANGE</AcademicProgramName>
    <NoteMessage>CURRIC: LIBERAL ARTS</NoteMessage>
  </AcademicProgram>
</AcademicSession>
<AcademicSession>
  <AcademicSessionDetail>
    <SessionDesignator>20010-01</SessionDesignator>
    <SessionDesignatorSuffix>2</SessionDesignatorSuffix>
    <SessionName>SPRING SEMESTER 2001</SessionName>
    <SessionType>Semester</SessionType>
  </AcademicSessionDetail>
  <AcademicProgram>
    <AcademicProgramName>FINE ARTS</AcademicProgramName>
  </AcademicProgram>
  <Course>
    <CourseCreditBasis>Regular</CourseCreditBasis>
    <CourseCreditUnits>Semester </CourseCreditUnits>
    <CourseCreditLevel>LowerDivision</CourseCreditLevel>
    <CourseCreditValue>3</CourseCreditValue>
    <CourseCreditEarned>3</CourseCreditEarned>
    <CourseAcademicGradeScaleCode>25</CourseAcademicGradeScaleCode>
    <CourseAcademicGrade>A</CourseAcademicGrade>
    <CourseCIPCode>999</CourseCIPCode>
    <CourseSubjectAbbreviation>T D</CourseSubjectAbbreviation>
    <CourseNumber>303C</CourseNumber>
    <CourseTitle>TRAINING SPEAKING VOICE-CXS</CourseTitle>
  </Course>
  <Course>
    <CourseCreditBasis>Regular</CourseCreditBasis>
    <CourseCreditUnits>Semester </CourseCreditUnits>
    <CourseCreditLevel>UpperDivision</CourseCreditLevel>
    <CourseCreditValue>3</CourseCreditValue>
    <CourseCreditEarned>3</CourseCreditEarned>
    <CourseAcademicGradeScaleCode>25</CourseAcademicGradeScaleCode>
    <CourseAcademicGrade>B</CourseAcademicGrade>
    <CourseCIPCode>999</CourseCIPCode>
    <CourseSubjectAbbreviation>E</CourseSubjectAbbreviation>
    <CourseNumber>321</CourseNumber>
    <CourseTitle>SHAKESPEARE: SELECTED PLAYS</CourseTitle>
  </Course>
  <Course>
    <CourseCreditBasis>Regular</CourseCreditBasis>
    <CourseCreditUnits>Semester </CourseCreditUnits>
    <CourseCreditLevel>UpperDivision</CourseCreditLevel>
    <CourseCreditValue>3</CourseCreditValue>
    <CourseCreditEarned>3</CourseCreditEarned>
    <CourseAcademicGradeScaleCode>25</CourseAcademicGradeScaleCode>
    <CourseAcademicGrade>B</CourseAcademicGrade>
    <CourseCIPCode>999</CourseCIPCode>
    <CourseSubjectAbbreviation>GOV</CourseSubjectAbbreviation>
    <CourseNumber>365N</CourseNumber>
    <CourseTitle>2-IMMIGRATION AND COMPAR POLIT</CourseTitle>
  </Course>
  <Course>
    <CourseCreditBasis>Regular</CourseCreditBasis>
    <CourseCreditUnits>Semester </CourseCreditUnits>
    <CourseCreditLevel>LowerDivision</CourseCreditLevel>
    <CourseCreditValue>3</CourseCreditValue>
    <CourseCreditEarned>3</CourseCreditEarned>
    <CourseAcademicGradeScaleCode>25</CourseAcademicGradeScaleCode>
    <CourseAcademicGrade>A</CourseAcademicGrade>
    <CourseCIPCode>999</CourseCIPCode>

```

```

        <CourseSubjectAbbreviation>TLC</CourseSubjectAbbreviation>
        <CourseNumber>311</CourseNumber>
        <CourseTitle>INFORMATION IN CYBERSPACE</CourseTitle>
    </Course>
</Course>
<Course>
    <CourseCreditBasis>Regular</CourseCreditBasis>
    <CourseCreditUnits>Semester </CourseCreditUnits>
    <CourseCreditLevel>LowerDivision</CourseCreditLevel>
    <CourseCreditValue>3</CourseCreditValue>
    <CourseCreditEarned>3</CourseCreditEarned>
    <CourseAcademicGradeScaleCode>25</CourseAcademicGradeScaleCode>
    <CourseAcademicGrade>A</CourseAcademicGrade>
    <CourseCIPCode>999</CourseCIPCode>
    <CourseSubjectAbbreviation>S W</CourseSubjectAbbreviation>
    <CourseNumber>310</CourseNumber>
    <CourseTitle>INTRO TO SOCL WORK & SOCL WELF</CourseTitle>
</Course>
<AcademicSummary>
    <GPA>
        <CreditHoursAttempted>15</CreditHoursAttempted>
        <CreditHoursEarned>15</CreditHoursEarned>
        <CreditUnit>Semester </CreditUnit>
        <GradePointAverage>3.6</GradePointAverage>
        <CreditHoursforGPA>15</CreditHoursforGPA>
    </GPA>
</AcademicSummary>
</AcademicSession>
<AcademicSession>
    <AcademicSessionDetail>
        <SessionDesignator>2001-09</SessionDesignator>
        <SessionDesignatorSuffix>1</SessionDesignatorSuffix>
        <SessionName>FALL SEMESTER 2001</SessionName>
        <SessionType>Semester</SessionType>
    </AcademicSessionDetail>
    <AcademicProgram>
        <AcademicProgramName>INTERNATIONAL EXCHANGE</AcademicProgramName>
        <NoteMessage>CURRIC: LIBERAL ARTS</NoteMessage>
    </AcademicProgram>
</AcademicSession>
<Course>
    <CourseCreditBasis>Regular</CourseCreditBasis>
    <CourseCreditUnits>Semester </CourseCreditUnits>
    <CourseCreditLevel>Graduate</CourseCreditLevel>
    <CourseCreditValue>3</CourseCreditValue>
    <CourseCreditEarned>3</CourseCreditEarned>
    <CourseAcademicGradeScaleCode>25</CourseAcademicGradeScaleCode>
    <CourseAcademicGrade>A</CourseAcademicGrade>
    <CourseCIPCode>999</CourseCIPCode>
    <CourseSubjectAbbreviation>PHL</CourseSubjectAbbreviation>
    <CourseNumber>388</CourseNumber>
    <CourseTitle>CONFERENCE COURSE</CourseTitle>
</Course>
<Course>
    <CourseCreditBasis>Regular</CourseCreditBasis>
    <CourseCreditUnits>Semester </CourseCreditUnits>
    <CourseCreditLevel>Graduate</CourseCreditLevel>
    <CourseCreditValue>3</CourseCreditValue>
    <CourseCreditEarned>3</CourseCreditEarned>
    <CourseAcademicGradeScaleCode>501</CourseAcademicGradeScaleCode>
    <CourseAcademicGrade>CR</CourseAcademicGrade>
    <CourseRepeatCode>NotCountedOther</CourseRepeatCode>
    <CourseCIPCode>999</CourseCIPCode>
    <CourseSubjectAbbreviation>PHL</CourseSubjectAbbreviation>
    <CourseNumber>388C</CourseNumber>
    <CourseTitle>CONFERENCE COURSE</CourseTitle>
</Course>
<Course>
    <CourseCreditBasis>Regular</CourseCreditBasis>
    <CourseCreditUnits>Semester </CourseCreditUnits>
    <CourseCreditLevel>Graduate</CourseCreditLevel>
    <CourseCreditValue>3</CourseCreditValue>

```

```

        <CourseCreditEarned>3</CourseCreditEarned>
        <CourseAcademicGradeScaleCode>25</CourseAcademicGradeScaleCode>
        <CourseAcademicGrade>A</CourseAcademicGrade>
        <CourseCIPCode>999</CourseCIPCode>
        <CourseSubjectAbbreviation>SOC</CourseSubjectAbbreviation>
        <CourseNumber>387J</CourseNumber>
        <CourseTitle>FUNDAMENTALS OF RESEARCH METHS</CourseTitle>
    </Course>
</Course>
<Course>
    <CourseCreditBasis>Regular</CourseCreditBasis>
    <CourseCreditUnits>Semester </CourseCreditUnits>
    <CourseCreditLevel>Graduate</CourseCreditLevel>
    <CourseCreditValue>3</CourseCreditValue>
    <CourseCreditEarned>3</CourseCreditEarned>
    <CourseAcademicGradeScaleCode>25</CourseAcademicGradeScaleCode>
    <CourseAcademicGrade>B</CourseAcademicGrade>
    <CourseCIPCode>999</CourseCIPCode>
    <CourseSubjectAbbreviation>SOC</CourseSubjectAbbreviation>
    <CourseNumber>389K</CourseNumber>
    <CourseTitle>3-HUMAN MORTALITY</CourseTitle>
</Course>
<AcademicSummary>
    <AcademicSummaryLevel>Undergraduate</AcademicSummaryLevel>
    <GPA>
        <CreditHoursAttempted>12</CreditHoursAttempted>
        <CreditHoursEarned>12</CreditHoursEarned>
        <CreditUnit>Semester </CreditUnit>
        <GradePointAverage>3.6666</GradePointAverage>
        <CreditHoursforGPA>9</CreditHoursforGPA>
    </GPA>
</AcademicSummary>
</AcademicSession>
<AcademicSession>
    <AcademicSessionDetail>
        <SessionDesignator>2002-01</SessionDesignator>
        <SessionDesignatorSuffix>1</SessionDesignatorSuffix>
        <SessionName>SPRING SEMESTER 2002</SessionName>
        <SessionType>Semester</SessionType>
    </AcademicSessionDetail>
    <AcademicProgram>
        <AcademicProgramName>COMMUNICATION</AcademicProgramName>
    </AcademicProgram>
</AcademicSession>
<Course>
    <CourseCreditBasis>Regular</CourseCreditBasis>
    <CourseCreditUnits>Semester </CourseCreditUnits>
    <CourseCreditLevel>LowerDivision</CourseCreditLevel>
    <CourseCreditValue>3</CourseCreditValue>
    <CourseCreditEarned>3</CourseCreditEarned>
    <CourseAcademicGradeScaleCode>25</CourseAcademicGradeScaleCode>
    <CourseAcademicGrade>A</CourseAcademicGrade>
    <CourseCIPCode>999</CourseCIPCode>
    <CourseSubjectAbbreviation>J</CourseSubjectAbbreviation>
    <CourseNumber>310</CourseNumber>
    <CourseTitle>CRITICAL ISSUES IN JOURNALISM</CourseTitle>
</Course>
</Course>
<Course>
    <CourseCreditBasis>Regular</CourseCreditBasis>
    <CourseCreditUnits>Semester </CourseCreditUnits>
    <CourseCreditLevel>LowerDivision</CourseCreditLevel>
    <CourseCreditValue>3</CourseCreditValue>
    <CourseCreditEarned>3</CourseCreditEarned>
    <CourseAcademicGradeScaleCode>25</CourseAcademicGradeScaleCode>
    <CourseAcademicGrade>B</CourseAcademicGrade>
    <CourseCIPCode>999</CourseCIPCode>
    <CourseSubjectAbbreviation>J</CourseSubjectAbbreviation>
    <CourseNumber>315</CourseNumber>
    <CourseTitle>NEWS MEDIA WRITING & EDITING-W</CourseTitle>
</Course>
</Course>
<Course>
    <CourseCreditBasis>Regular</CourseCreditBasis>

```

```

        <CourseCreditUnits>Semester </CourseCreditUnits>
        <CourseCreditLevel>UpperDivision</CourseCreditLevel>
        <CourseCreditValue>3</CourseCreditValue>
        <CourseCreditEarned>3</CourseCreditEarned>
        <CourseAcademicGradeScaleCode>25</CourseAcademicGradeScaleCode>
        <CourseAcademicGrade>A</CourseAcademicGrade>
        <CourseCIPCode>999</CourseCIPCode>
        <CourseSubjectAbbreviation>J</CourseSubjectAbbreviation>
        <CourseNumber>327</CourseNumber>
        <CourseTitle>FEATURE WRITING-W</CourseTitle>
    </Course>
    <Course>
        <CourseCreditBasis>Regular</CourseCreditBasis>
        <CourseCreditUnits>Semester </CourseCreditUnits>
        <CourseCreditLevel>UpperDivision</CourseCreditLevel>
        <CourseCreditValue>3</CourseCreditValue>
        <CourseCreditEarned>3</CourseCreditEarned>
        <CourseAcademicGradeScaleCode>25</CourseAcademicGradeScaleCode>
        <CourseAcademicGrade>A</CourseAcademicGrade>
        <CourseCIPCode>999</CourseCIPCode>
        <CourseSubjectAbbreviation>J</CourseSubjectAbbreviation>
        <CourseNumber>336</CourseNumber>
        <CourseTitle>VISUAL DESIGN</CourseTitle>
    </Course>
    <AcademicSummary>
        <AcademicSummaryLevel>Undergraduate</AcademicSummaryLevel>
        <GPA>
            <CreditHoursAttempted>12</CreditHoursAttempted>
            <CreditHoursEarned>12</CreditHoursEarned>
            <CreditUnit>Semester </CreditUnit>
            <GradePointAverage>3.75</GradePointAverage>
            <CreditHoursforGPA>12</CreditHoursforGPA>
        </GPA>
    </AcademicSummary>
</AcademicSession>
</AcademicRecord>
</Student>
</ColTrn:CollegeTranscript>

```