



**COMMON TRAINING
GREEN STAR
INSTRUCTIONAL GUIDE**



SECTION 1

EO M106.01 – IDENTIFY THE PARTS AND CHARACTERISTICS OF THE DAISY 853C AIR RIFLE

Total Time:

30 min

PREPARATION

PRE-LESSON INSTRUCTIONS

Resources needed for the delivery of this lesson are listed in the lesson specification located in A-CR-CCP-701/PG-001, *Green Star Qualification Standard and Plan*, Chapter 4. Specific uses for said resources are identified throughout the instructional guide within the TP for which they are required.

Prior to instructing this lesson the instructor shall:

- review the lesson content, and become familiar with the material;
- carry out a safety precaution check on all rifles to be used during this lesson; and
- state to cadets that the rifles have been inspected and are safe to handle.

PRE-LESSON ASSIGNMENT

Nil.

APPROACH

An interactive lecture was chosen for this lesson to orient the cadets to the parts and characteristics of the Daisy 853C Air rifle and generate interest.

INTRODUCTION

REVIEW

Nil.

OBJECTIVES

By the end of this lesson the cadet shall be expected to identify the parts, and list the characteristics of the cadet air rifle.

IMPORTANCE

Cadets must have a basic knowledge of the cadet air rifle in order to understand how the rifle works and to safely follow directions given on the range.

Teaching Point 1**Identify the parts of the Daisy 853C air rifle.**

Time: 13 min

Method: Interactive Lecture

PARTS

- Depending on the number of rifles available, distribute them with an optimum ratio of one rifle for every two cadets.
- When possible, have a second instructor in the room to assist.
- **For safety purposes, maintain strict class control at all times.**

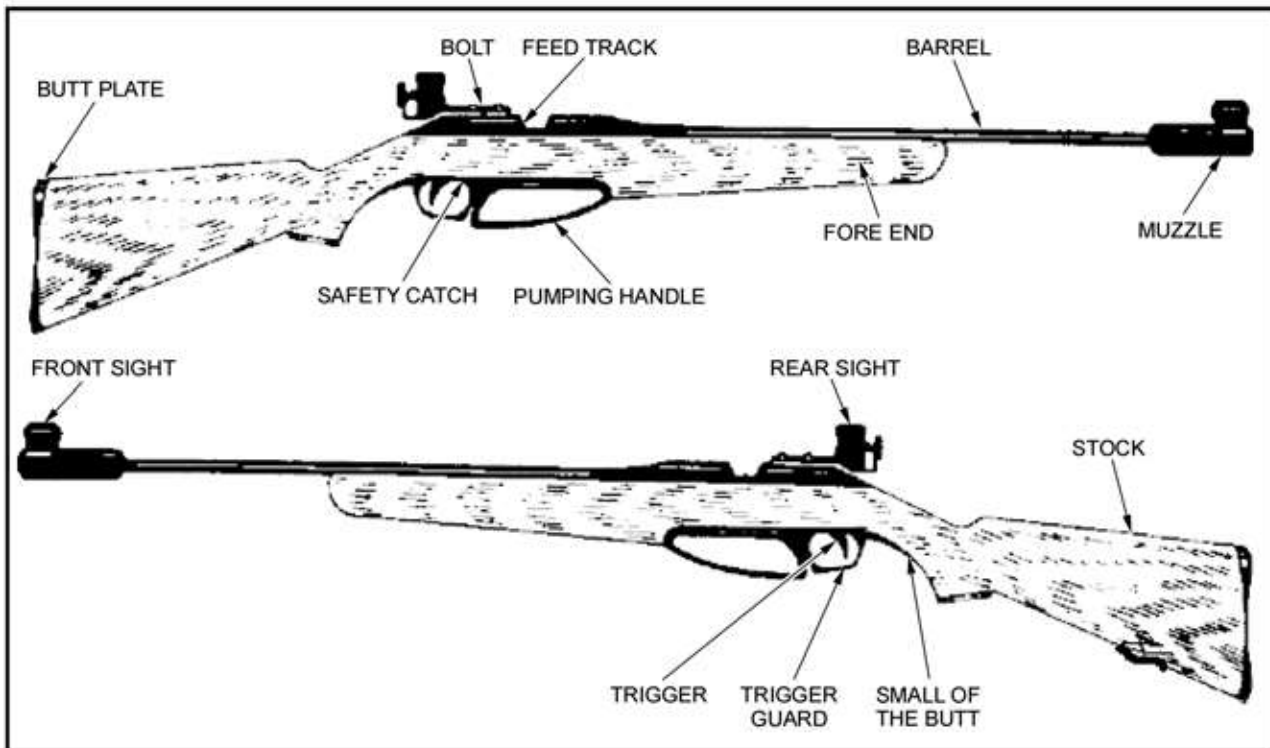

A-CR-CCP-177/PT-001

Figure 1 Parts of the Cadet Air Rifle

Butt Plate (End of the Butt). It is the part of the rifle directly in contact with the marksman's shoulder. When fitted properly, the butt plate aids in achieving a snug fit, and a consistent placement of the rifle into the shoulder. The addition of butt spacers allows for this adjustment in length.

Spacers. Plastic inserts that can be added or removed from the butt plate to vary its length. To add or take away butt spacers, use a Phillips screwdriver to loosen the butt plate and slide in/out the amount of spacers desired.

Small of the Butt (Pistol Grip). Curved area directly behind the trigger guard where the hand controlling the trigger grips the rifle.

Stock. Complete wooden portion of the rifle (from the butt plate end forward).

Fore End (of the Stock). Wooden portion of the stock from the trigger guard forward, in which the barrel and the rifle mechanism are encased.

Sling. It is a web sling made of nylon. Links the rifle to the marksman's arm to support most of the weight of the rifle. One end attaches to the sling bracket and the other to the upper arm.

Sling Bracket (Hand Stop). Adjustable metal clasp attached to the fore stock used to affix the sling to the rifle. It also acts as a hand stop, used to rest the left hand to prevent it from moving.

Trigger. Movable device that releases a spring and releases the rifle mechanism. This rifle has a single stage trigger that cannot be adjusted for weight.

Trigger Guard. Metal band that surrounds and protects the trigger.

Safety Catch. This is a mechanism that, once engaged, prevents the rifle from firing by locking the trigger in place. It is a cross bolt type device located on the trigger guard. The black side indicates that the rifle is unable to fire; the red side indicates the rifle is ready to fire. It should be ON (no red) at all times, unless firing.

Bolt. Metal lever used for opening or closing the rifle mechanism. It must be in the closed position in order to fire. For maximum safety when the rifle is uncased and not firing, the bolt should be kept open.

Pump Handle. Metal lever used to compress the air required to fire the pellet. Whenever the rifle is in a "safe rifle status", the pump lever should be left partially open.

Front Sight. Global front sight that uses aperture inserts.

Rear Sight. Micrometer sight adjustable for windage and elevation. It is easily attached to a metal rail located above the action. This rail allows for adjustment of the sight forward or backward, in order to maintain proper eye relief. The sight is attached using a small flat-blade screwdriver.

Muzzle. Front end of the barrel equipped with attachable barrel weight.

Barrel With Barrel Weight. Steel tube through which the pellet travels, extending from the muzzle to the chamber. The barrel weight ensures that the rifle's weight is evenly distributed and that the rifle's balance is maintained.

Bore. Interior of the barrel has spiral grooves cut into it. The lands are the ridges of metal between the grooves. Together, the grooves and lands are called rifling.

Feed Track. Delicate area where the pellet is inserted manually onto a single pellet adapter, or with a five-shot clip.

Single Shot Adapter. Plastic clip that aids in placing a pellet in the chamber.

Five-shot Clip. Plastic clip that holds a maximum of five pellets and used to place the pellets in the chamber.

Chamber. Location where the pellet is held before firing.

CONFIRMATION OF TEACHING POINT 1

The instructor shall ensure that the cadet can identify the parts of the cadet air rifle by physically pointing to the parts, and having the cadets properly name the part.

Teaching Point 2**Identify the characteristics of the Daisy 853C air rifle.**

Time: 12 min

Method: Interactive Lecture

CHARACTERISTICS

Identify the main characteristics of the cadet air rifle. Focus on these points during the confirmation section of this teaching point.

The characteristics of the Daisy 853C air rifle are:

- **Action.** Single pump pneumatic, straight pull-bolt.
- **Total Length.** 97.8 cm.
- **Total Weight.** 2.5 kg.
- **Calibre.** 0.177 calibre (4.5 mm).
- **Front Sight.** Global type with interchangeable aperture inserts.
- **Rear Sight.** Fully adjustable peep rear sight with micrometer click adjustment.
- **Muzzle Velocity.** 150.8 metres per second.
- **Loading.** Single or auto indexing five-pellet clip.
- **Stock.** Full-length, sporter-styled hardwood with adjustable length.
- **Safety.** Manual cross-bolt trigger block with red indicator.



These characteristics are “Nice to Know” and should be taught only if time permits.

- **Barrel.** Lothar Walther rifled high-grade steel barrel with weight: crowned 12 lands and grooves, right hand twist. Precision bore sized for match pellets. Approximate length 53.1 cm.
- **Maximum Range.** 235.4 metres.
- **Sling.** Adjustable competition web.
- **Trigger Weight.** Minimum 3.5 lb.
- **Chamber.** Open loading and made of steel.
- **Pumping Force.** 20 lbf.

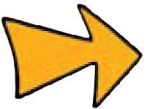

With a muzzle velocity of 150.8 metres per second, the cadet air rifle is not a “firearm” under the current federal firearms legislation, but it is treated as one under the definition used by the Military Police.

CONFIRMATION OF TEACHING POINT 2

QUESTIONS

- Q1. The cadet air rifle has what type of action?
Q2. What is the calibre of the cadet air rifle?
Q3. The cadet air rifle uses what type of safety?

ANTICIPATED ANSWERS

- A1. Single pump pneumatic, straight pull-bolt.
A2. 0.177 calibre (4.5 mm).
A3. Manual cross-bolt trigger block with red indicator.

END OF LESSON CONFIRMATION

This EO may be confirmed with the handout found at Attachment A. Allow cadets a few minutes to complete the handout, then have cadets switch sheets for correcting.



Correctly labelled diagram is located at page M106.01A-2.

CONCLUSION

HOMEWORK/READING/PRACTICE

Cadets are to take home the corrected handout to study the parts of the cadet air rifle.

METHOD OF EVALUATION

Nil.

CLOSING STATEMENT

Knowing the parts and characteristics of the cadet air rifle is important in understanding how the rifle works. This allows the cadet to be able to follow directions given on the range, and properly perform a handling test whenever an air rifle is to be used.

INSTRUCTOR NOTES/REMARKS

Emphasis must be placed on the safety aspect of this lesson.

REFERENCES

A0-027 A-CR-CCP-177/PT-001 D Cdts 3. (2001). *Canadian Cadet Movement: Cadet Marksmanship Programme Reference Manual*. Ottawa, ON: Department of National Defence.

THIS PAGE INTENTIONALLY LEFT BLANK

PARTS AND CHARACTERISTICS OF THE CADET AIR RIFLE

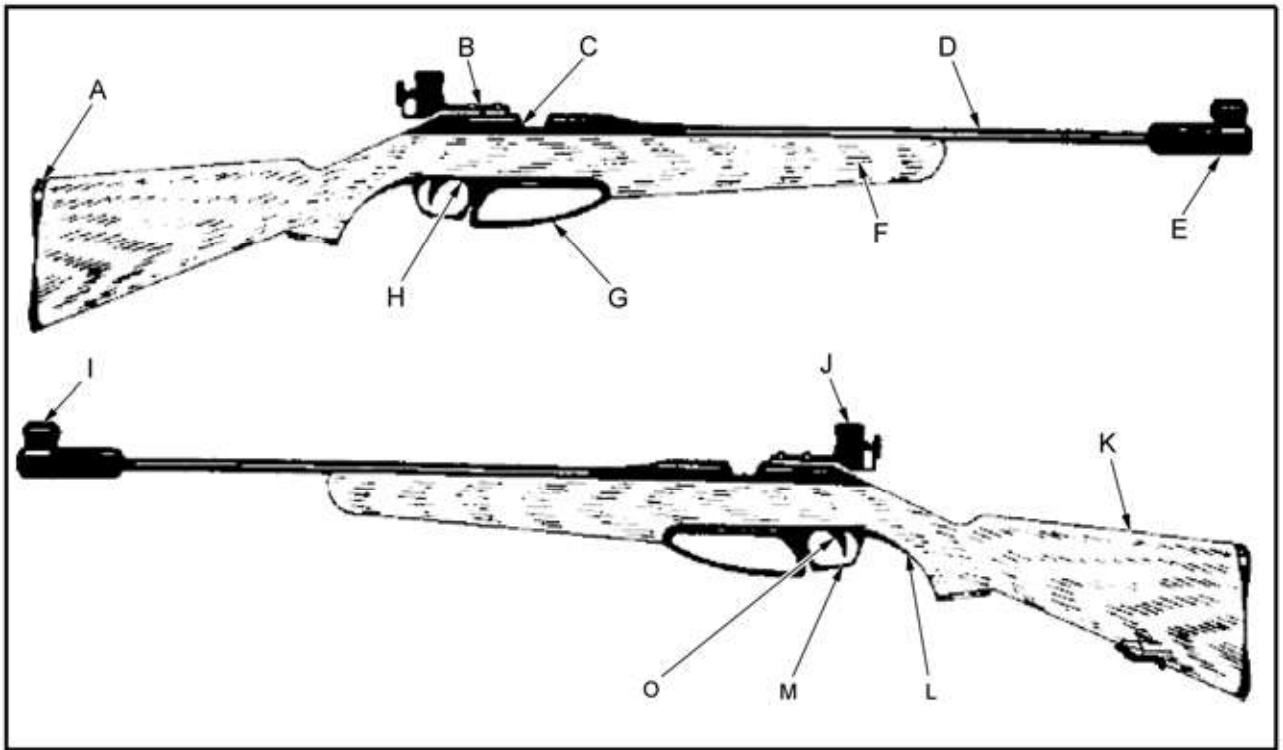

Put the letter next to the matching name of the part of the cadet air rifle.

- | | | | |
|----------------------|-------|-------------------|-------|
| 1. Feed Track | _____ | 8. Safety Catch | _____ |
| 2. Small of the Butt | _____ | 9. Muzzle | _____ |
| 3. Barrel | _____ | 10. Pump Lever | _____ |
| 4. Fore End | _____ | 11. Front Sight | _____ |
| 5. Rear Sight | _____ | 12. Trigger Guard | _____ |
| 6. Trigger | _____ | 13. Butt Plate | _____ |
| 7. Bolt | _____ | 14. Stock | _____ |

ANSWER KEY

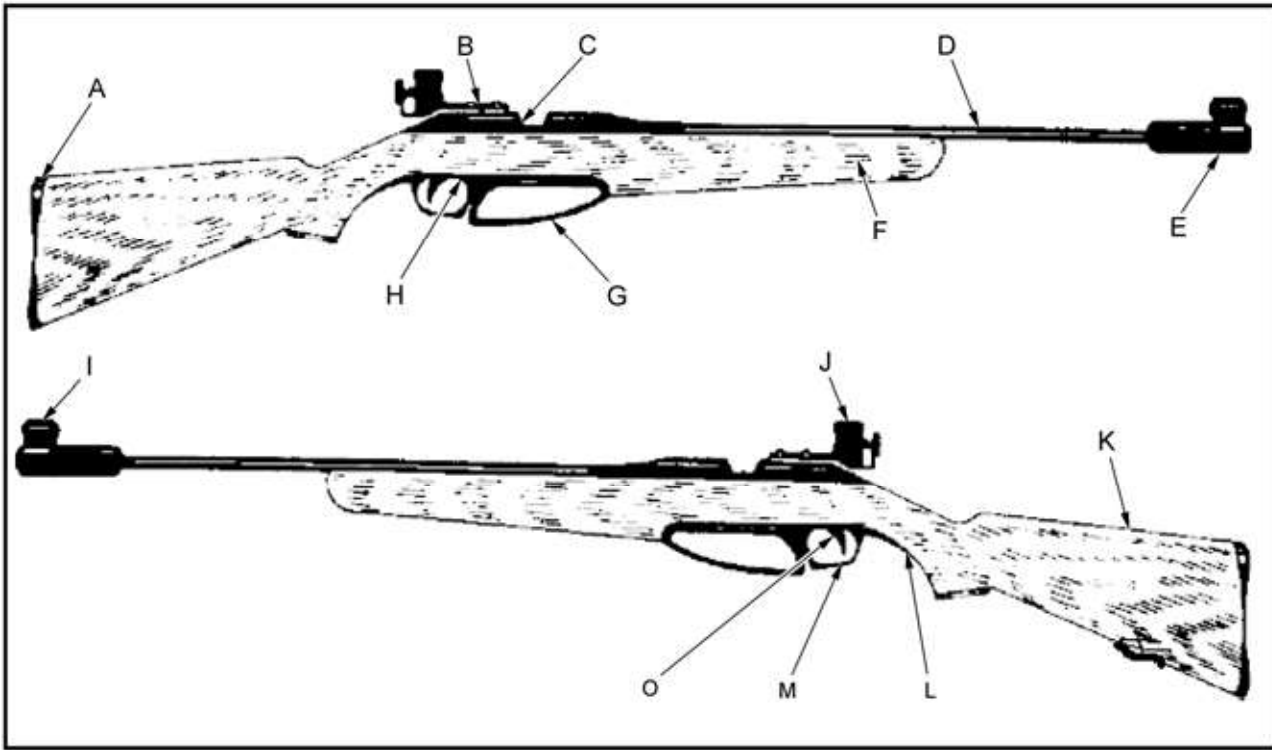

Put the letter next to the matching name of the part of the cadet air rifle.

- | | | | |
|----------------------|------------------------------|-------------------|------------------------------|
| 1. Feed Track | <u> C </u> | 8. Safety Catch | <u> H </u> |
| 2. Small of the Butt | <u> L </u> | 9. Muzzle | <u> E </u> |
| 3. Barrel | <u> D </u> | 10. Pump Lever | <u> G </u> |
| 4. Fore End | <u> F </u> | 11. Front Sight | <u> I </u> |
| 5. Rear Sight | <u> J </u> | 12. Trigger Guard | <u> M </u> |
| 6. Trigger | <u> O </u> | 13. Butt Plate | <u> A </u> |
| 7. Bolt | <u> B </u> | 14. Stock | <u> K </u> |



**COMMON TRAINING
GREEN STAR
INSTRUCTIONAL GUIDE**



SECTION 2

EO M106.02 – CARRY OUT SAFETY PRECAUTIONS ON THE CADET AIR RIFLE

Total Time:

30 min

PREPARATION

PRE-LESSON INSTRUCTIONS

Resources needed for the delivery of this lesson are listed in the lesson specification located in A-CR-CCP-701/PG-001, *Green Star Qualification Standard and Plan*, Chapter 4. Specific uses for said resources are identified throughout the instructional guide within the TP for which they are required.

Prior to instructing this lesson the instructor shall:

- review the lesson content, and become familiar with the material; and
- carry out a safety precaution check on all rifles to be used during this lesson. State to cadets that the rifles have been inspected and are safe to handle.

PRE-LESSON ASSIGNMENT

Nil.

APPROACH

A demonstration and performance was chosen for TPs 1 and 2 as it allows the instructor to explain and demonstrate safety precautions on the cadet air rifle, while providing an opportunity for the cadets to practice under supervision.

An interactive lecture was chosen for TP 3 to orient the cadets to the safety regulations of the Daisy 853C Air rifle and generate interest.

INTRODUCTION

REVIEW

The pertinent review for this lesson from, EO M106.01 (Section 1), will include:

- Having the cadets identify the characteristics of the Daisy 853C, to include:
 - **Action.** Single pump pneumatic, straight pull-bolt.
 - **Calibre.** 0.177 calibre (4.5 mm).
 - **Safety.** Manual cross-bolt trigger block with red indicator.

- **Loading.** Single or auto indexing five-shot clip.
- **Muzzle Velocity.** 150.8 metres per second.
- Having the cadets identify parts of the Daisy 853C by physically pointing to them and naming them, to include:
 - butt plate,
 - small of the butt (pistol grip),
 - sling bracket (hand stop),
 - trigger,
 - trigger guard,
 - safety catch,
 - bolt,
 - pump lever,
 - muzzle,
 - barrel with barrel weight, and
 - feed track.

OBJECTIVES

By the end of this lesson the cadet shall be expected to carry out individual safety precautions on the cadet air rifle.

IMPORTANCE

Safety precautions are essential to ensure everyone's safety on the range. Every time a cadet picks up a rifle or steps on a range, they must have safety in mind and check to ensure the rifle is safe (an individual safety precaution check when receiving, handing over, or returning to a rifle). Even when a rifle is presumably safe, it is to be checked again.

Teaching Point 1**Explain and demonstrate safe rifle status for the cadet air rifle.**

Time: 10 min

Method: Demonstration and Performance

REMOVING A RIFLE FROM THE CASE

The rifle case should be clearly marked on the outside with an arrow, indicating in what direction the rifle inside is pointing. This will ensure that, when the case is opened, the rifle is pointing in a safe direction. The following steps must be followed when removing a rifle from its case:

1. Place the rifle case on a flat surface and ensure the arrow is pointing in a safe direction.
2. Open the case.
3. Cock the action (leave the bolt to the rear).
4. Confirm that the safety catch is ON.
5. Confirm that the pumping lever is partially open.
6. Slide the safety rod in the barrel towards the bolt until it can be seen in the feed track.
7. Remove the rifle from the case.
8. Remove the safety rod when you are on the firing line.

SAFETY CATCH AND SECURITY MEASURES

The safety catch is a mechanism that, once engaged, prevents a rifle from firing by locking its trigger into place. It is located just in front of the trigger, on the trigger guard. To engage the safety catch (ON) it must be pushed towards the right **so no red can be seen**. To fire, the safety catch must be pushed towards the left in the OFF position and a red mark must be seen on it. For maximum security, it is recommended that the safety catch be kept engaged until the rifle is ready for firing.

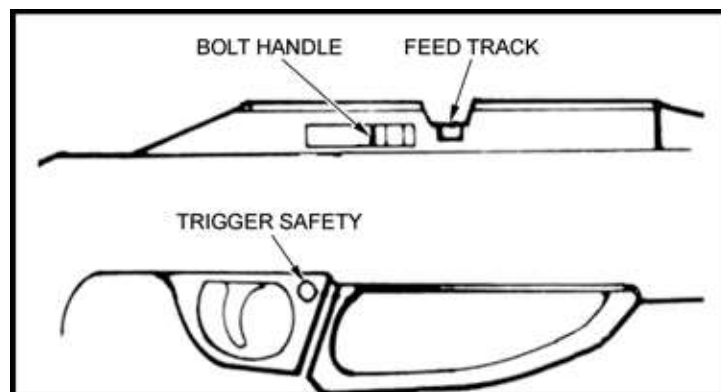

Daisy 853C Operational Manual

Figure 1 Safety Catch

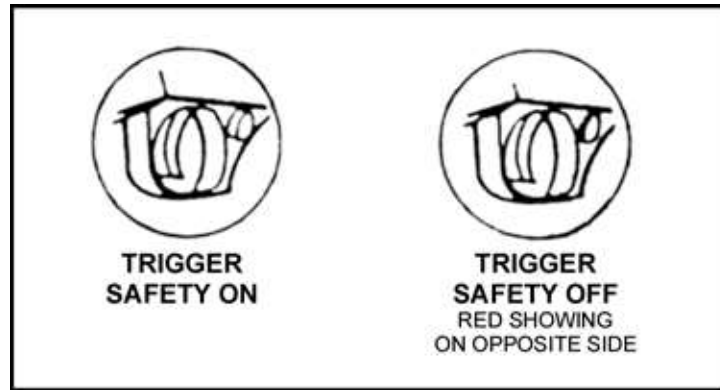

Daisy 853C Operational Manual

Figure 2 Safety Catch Detail View

SAFETY ROD

To ensure that air rifles are not removed from the firing point or stored with a pellet in the chamber or barrel, a safety rod is to be inserted in the barrel from the muzzle end. It consists of two sections of doweling joined together in a “T” shape, and may be made of varying materials. Dimensions are detailed in Figure 3. The tip of the safety rod is to be coloured red so that it is visible in the feed track with the bolt fully to the rear.

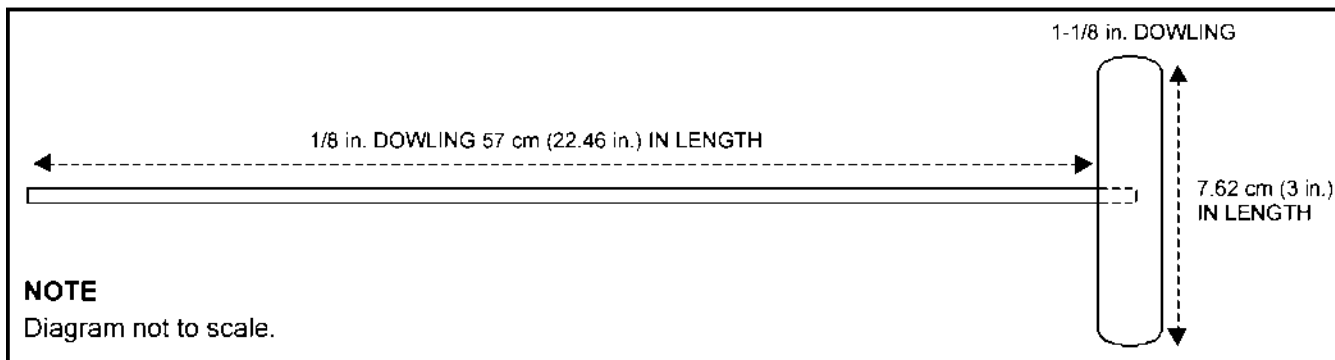

Cadet Marksmanship Program Reference Manual

Figure 3 Safety Rod

SAFE RIFLE STATUS



The instructor shall demonstrate and explain points 1, 2 and 3 of the safe rifle status checks using full demonstrations and explanations prior to each new skill, followed by a chance for the cadets to imitate the skill under supervision.

When not being handled on the range or in a training environment, the air rifle must be in a safe status. The following options denote various states of “safe rifle status”:

1. **In the rifle case:**
 - (a) The safety catch is ON.
 - (b) The bolt is forward.
 - (c) The action is not cocked.

- (d) The safety rod is in the case but not in the barrel.
 - (e) The pump lever is partially open (5 to 8 cm).
2. **On the firing line:**
- (a) The safety catch is ON.
 - (b) The bolt is to the rear.
 - (c) The pump lever is partially open.
3. **Off the firing line:**
- (a) The safety catch is on.
 - (b) The bolt is to the rear.
 - (c) The safety rod is in the barrel (visible in the feed track).
 - (d) The pump lever is partially open.

CONFIRMATION OF TEACHING POINT 1

Have the cadets, under supervision, perform the steps for “Safe Rifle Status” for:

- a. on the firing line; and
- b. off the firing line.

Teaching Point 2

Carry out individual safety precautions.

Time: 10 min

Method: Demonstration and Performance

INDIVIDUAL SAFETY PRECAUTIONS



The instructor shall provide an EXPLANATION and DEMONSTRATION of the complete skill.
The instructor shall also provide an EXPLANATION and DEMONSTRATION of each step required to effectively complete the skill.

Upon receiving a rifle, or when the “Safe Rifle Status” is uncertain, individual safety precautions shall be done to confirm that the rifle is safe. An individual must ensure that:

1. the bolt is open fully to the rear;
2. the safety catch is in the ON position;
3. the pump lever is left partially open; and
4. a safety rod is placed in the barrel.

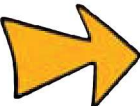

Cadets will IMITATE the demonstration provided by the instructor for each step within the skill. The instructor(s) will SUPERVISE the cadets during this imitation.

CONFIRMATION OF TEACHING POINT 2

Have cadets carry out individual safety precautions. Cadets will also be required to perform this skill during their air rifle handling test.

Teaching Point 3

Explain and demonstrate safety regulations for the cadet air rifle.

Time: 5 min

Method: Interactive Lecture

SAFETY REGULATIONS

Safety regulations are all common sense and are easy to apply when people understand that they are necessary to help prevent accidents with the air rifle. Regulations include:

1. treating the air rifle as if it is loaded;
2. never pointing the air rifle at anyone;
3. holding the rifle vertically when moving to and from the firing point;
4. leaving fingers off the trigger until ready to fire;
5. wearing safety glasses/goggles; and
6. employing hygiene on the range by washing hands after every practice.



The Canadian Firearms Centre safety training teaches that the vital four “**ACTS**” of firearm safety. The acronym “**ACTS**” stands for:

- **A**ssume every firearm is loaded.
- **C**ontrol the muzzle direction at all times.
- **T**rigger finger must be kept off the trigger and out of the trigger guard.
- **S**ee that the firearm is unloaded – prove it safe.

CONFIRMATION OF TEACHING POINT 3

QUESTIONS

- Q1. Why do we follow safety regulations?
- Q2. What are some common sense safety regulations?
- Q3. What does the acronym “ACTS” stand for?

ANTICIPATED ANSWERS

- A1. To help prevent accidents with the air rifle.

A2. Any from list taught:

- (a) Treating the air rifle as if it is loaded.
- (b) Never point the air rifle at anyone.
- (c) Holding the rifle vertically when moving to and from the firing point.
- (d) Leaving fingers off the trigger until ready to fire.
- (e) Wearing safety glasses/goggles.
- (f) Employing hygiene on the range by washing hands after every practice.

A3. **ACTS** stands for; **A**ssume every firearm is loaded, **C**ontrol the muzzle direction at all times, **T**rigger finger must be kept off the trigger and out of the trigger guard, **S**ee that the firearm is unloaded – prove it safe.

END OF LESSON CONFIRMATION

QUESTIONS

- Q1. What does the arrow on the rifle case indicate?
- Q2. How do we know if the safety catch is ON?
- Q3. What are the vital four “**ACTS**” of firearm safety?

ANTICIPATED ANSWERS

- A1. The direction of the rifle inside the case.
- A2. No red can be seen.
- A3. **ACTS** stands for; **A**ssume every firearm is loaded, **C**ontrol the muzzle direction at all times, **T**rigger finger must be kept off the trigger and out of the trigger guard, **S**ee that the firearm is unloaded – prove it safe.

CONCLUSION

HOMEWORK/READING/PRACTICE

Nil.

METHOD OF EVALUATION

Assessment of this EO will occur during EO M106.05 (Participate in Marksmanship Familiarization Using the Cadet Air Rifle), where cadets are required to successfully complete the Cadet Air Rifle Handling Test prior to firing.

CLOSING STATEMENT

Being able to carry out safety precautions on the cadet air rifle is essential for functioning safely on the range following directions given on the range, and successfully performing a handling test.

INSTRUCTOR NOTES/REMARKS

Emphasis must be placed on the safety aspects of this lesson.

REFERENCES

A0-027 A-CR-CCP-177/PT-001 D Cdts 3. (2001). *Canadian Cadet Movement: Cadet Marksmanship Programme Reference Manual*. Ottawa, ON: Department of National Defence.



**COMMON TRAINING
GREEN STAR
INSTRUCTIONAL GUIDE**



SECTION 3

EO M106.03 – APPLY BASIC MARKSMANSHIP TECHNIQUES

Total Time:

60 min

PREPARATION

PRE-LESSON INSTRUCTIONS

Resources needed for the delivery of this lesson are listed in the lesson specification located in A-CR-CCP-701/PG-001, *Green Star Qualification Standard and Plan*, Chapter 4. Specific uses for said resources are identified throughout the instructional guide within the TP for which they are required.

Prior to instructing this lesson the instructor shall:

- review the lesson content, and become familiar with the material; and
- prepare a mock air rifle range prior to the beginning of the lesson.

PRE-LESSON ASSIGNMENT

Nil.

APPROACH

A demonstration and performance was chosen for this lesson as it allows the instructor to explain and demonstrate basic marksmanship techniques, while providing an opportunity for the cadets to practice under supervision.

INTRODUCTION

REVIEW

The pertinent review for this lesson, from EO M106.02 (Section 2), will include:

QUESTIONS

- Q1. Why are the individual safety precautions performed?
- Q2. What is the purpose of the “safety catch”?

ANTICIPATED ANSWERS

- A1. To confirm a rifle is safe.
- A2. It prevents a rifle from firing by locking its trigger into place.

OBJECTIVES

By the end of this lesson the cadet shall be expected to apply basic marksmanship techniques to include:

- prone position;
- basic holding;
- basic aiming;
- loading;
- firing; and
- unloading.

Cadets will apply the knowledge gained during this lesson when they participate in any range practice.

IMPORTANCE

These techniques must all be applied in harmony. Improving one while not working on another will not produce the best results in the long run. Perfecting these techniques takes time and concentration. Cadets should remember – PRACTICE MAKES PERFECT!

Teaching Point 1**Explain and demonstrate the prone position.**

Time: 4 min

Method: Demonstration and Performance

The first principle of marksmanship is to find a comfortable firing position. A comfortable firing position will enable cadets to fire safely and with much better results. The prone position is the most stable firing position to use.

OBJECTIVES OF A GOOD POSITION

Have cadets down get on the mat and assume the prone position. From here, the instructor is better prepared to observe the cadets imitating the skills being taught.



The instructor shall provide an EXPLANATION and DEMONSTRATION of the complete skill. The instructor shall also provide an EXPLANATION and DEMONSTRATION of each step required to effectively complete the skill.

Obtaining a good prone position is one of the most, if not the most, important principle of marksmanship. A good prone position helps to maintain comfort and stability during the firing session. The prone position is assumed when the marksman lies flat, directly behind the rifle, with a very slight angle between their body and the rifle, and in line with the target. The position should be:

- natural;
- without strain;
- comfortable; and
- stable, in that the:
 - body should form an angle with the line of sight;
 - spine should remain straight;
 - left leg should be parallel with the spine;
 - right foot should turn out and point to the right;
 - left foot should either be straight or point towards the right; and
 - right knee should form an angle with the left leg.

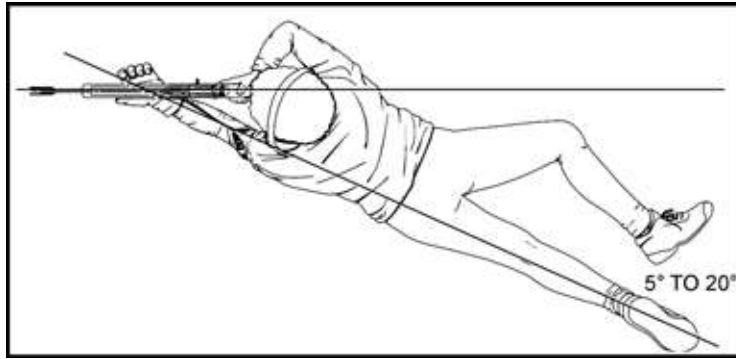

Cadet Marksmanship Program Reference Manual

Figure 1 Prone Position

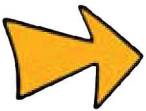

Cadets will IMITATE the demonstration provided by the instructor for each step within the skill. The instructor(s) will SUPERVISE the cadets during this imitation.

CONFIRMATION OF TEACHING POINT 1



The instructor will divide the group into two, or, by the number of air rifles available. The instructor shall have one group imitate the actions of the sequence as demonstrated, while the remainder observe. Have them trade places, and repeat.

Teaching Point 2

Explain and demonstrate how to hold the cadet air rifle.

Time: 7 min

Method: Demonstration and Performance

HOLDING THE CADET AIR RIFLE



The instructor shall provide an EXPLANATION and DEMONSTRATION of the complete skill. The instructor shall also provide an EXPLANATION and DEMONSTRATION of each step required to effectively complete the skill.

The prone position allows holding to be achieved with as little movement and muscular tension as possible, in that the:

- left elbow should be positioned slightly to the left of the rifle;
- left hand must rest firmly against the sling swivel, and the fingers should be relaxed and not grip the fore end;
- right hand should slightly grip the small of the butt with constant pressure;
- right thumb should be placed on the stock directly behind the rear sight or around the small of the butt;
- right elbow should rest naturally where it falls, not too close or too far from the rifle;

- the shoulders should be straight and form right angles with the spine;
- the butt plate is kept firmly in the hollow of the right shoulder. The right elbow will naturally fall in the same spot throughout the relay; and
- the head rests comfortably on the butt and remains straight.



Cadet Marksmanship Program Reference Manual

Figure 2 Prone Position (Front)



Cadet Marksmanship Program Reference Manual

Figure 3 Prone Position (Side)



Cadets will IMITATE the demonstration provided by the instructor for each step within the skill. The instructor(s) will SUPERVISE the cadets during this imitation.

CONFIRMATION OF TEACHING POINT 2



The instructor will divide the group into two, or, by the number of air rifles available. The instructor shall have one group imitate the actions of the sequence as demonstrated, while the remainder observe, and then have them trade places, and repeat.

Teaching Point 3

Explain and demonstrate how to aim the cadet air rifle.

Time: 4 min

Method: Demonstration and Performance

AIMING THE CADET AIR RIFLE

Cadets must constantly strive to maintain proper sight alignment, while obtaining a sight picture. It is the most critical element of the aiming process.

The **aiming process** consists of:

- adopting a comfortable position; and
- ensuring proper body alignment with the target.

Sight Alignment. It is the alignment of the eye, the rear sight, and the front sight. When cadets bring their eye 5 to 15 cm from the rear sight, they will find that the small hole is large enough to look through and see all of the front sight. Proper sight alignment is a matter of centering the front sight tube in the rear sight. The tube will not quite fill the rear sight and cadets will be able to see light around the outside of the tube; we call this a “line of white”.

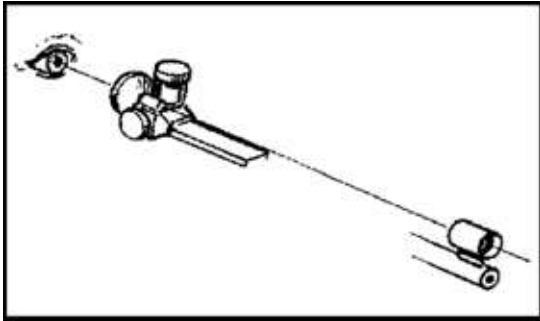

Cadet Marksmanship Program Reference Manual

Figure 4 Sight Alignment

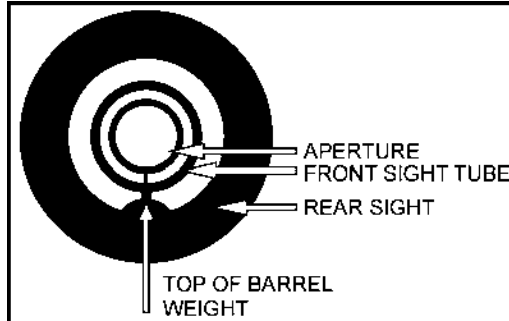

Cadet Marksmanship Program Reference Manual

Figure 5 Line of White

Sight Picture. To obtain a proper sight picture, a bull's-eye is simply added to the innermost ring. The goal during the aiming process is to maintain proper sight alignment while keeping the bull centered in the front sight.

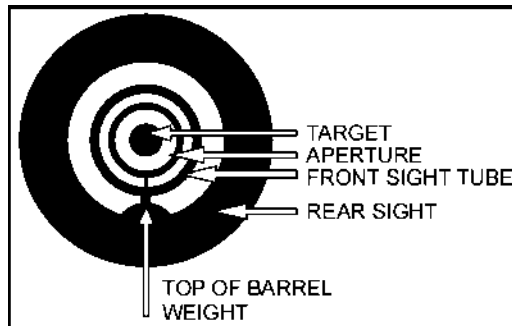

Cadet Marksmanship Program Reference Manual

Figure 6 Sight Picture

CONFIRMATION OF TEACHING POINT 3

QUESTIONS

- Q1. What are the two critical elements of the aiming process?
- Q2. Sight alignment consists of what three things?
- Q3. What is added to the innermost ring to obtain a proper sight picture?

ANTICIPATED ANSWERS

- A1. Adopting a comfortable position, and ensuring proper body alignment with the target.
- A2. The eye, the rear sight, and the front sight.
- A3. A bull's-eye.



The cadets' aiming abilities will be further assessed during future range practices. The instructor(s) will observe cadets during practices, and assess targets to confirm the skill of aiming.

Teaching Point 4

Explain, demonstrate, and have the cadets practice (dry fire) the actions required on the command “Relay, load, commence firing.”

Time: 14 min

Method: Demonstration and Performance

LOADING THE AIR RIFLE

The instructor shall provide an explanation and demonstration of the complete skill.

The instructor shall also provide an explanation and demonstration of each step required to effectively complete the skill.

Then, the cadets, under the supervision of the instructor, will have an opportunity to perform each step.

This will be conducted as a DRY FIRE EXERCISE ONLY.

On the command “Relay load” the following sequence must be followed:

Loading procedure:

1. pick up the rifle with the left hand;
2. ensure the safety catch is in the ON position;
3. pump the air rifle, pausing for three seconds with the pump handle fully extended;
4. bring the pump handle back to closed position;
5. simulate loading a pellet, or load an auto indexing five pellet-clip into the feed track; and
6. close the bolt.

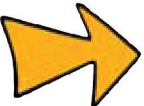

The following methods may be used when pumping the air rifle:

- **Option 1.** Grasp the pistol grip with the right hand. Grasp the pump handle with the left hand. Push downward with the left hand until the pump handle is fully extended. Wait for a few seconds. Using the left hand, bring the pump handle back to the stock of the rifle. The rifle should remain stationary during the pumping process and always point towards the targets.
- **Option 2.** Grasp the pistol grip with the right hand. Grasp the pump handle with the left hand. Place the butt of the rifle under the right arm or shoulder for support. Push downward with the left hand until the pump handle is fully extended. Wait for a few seconds. Using the left hand, bring the pump handle back to the stock of the rifle allowing the underarm and shoulder to help hold the rifle steady when closing the pump handle. Remember that the rifle must always point towards the targets.
- **Option 3. Coach assistance.** Point the rifle in a safe direction and request the assistance from a coach. The coach should move in and pump the rifle using both hands. This should be used as last resorts as any cadet can easily do the above two options.

FIRING THE CADET AIR RIFLE

On the command "Fire", the following sequence must be followed:

1. when the RSO gives the command, place safety catch in the OFF position;
2. aim the air rifle at the target;
3. squeeze the trigger;
4. open the bolt, pump the rifle, re-load, aim and fire;
5. repeat the last step until firing is complete;
6. upon completion, place the safety catch in the ON position, open the bolt and partially open the pump lever; and
7. lay the air rifle down.

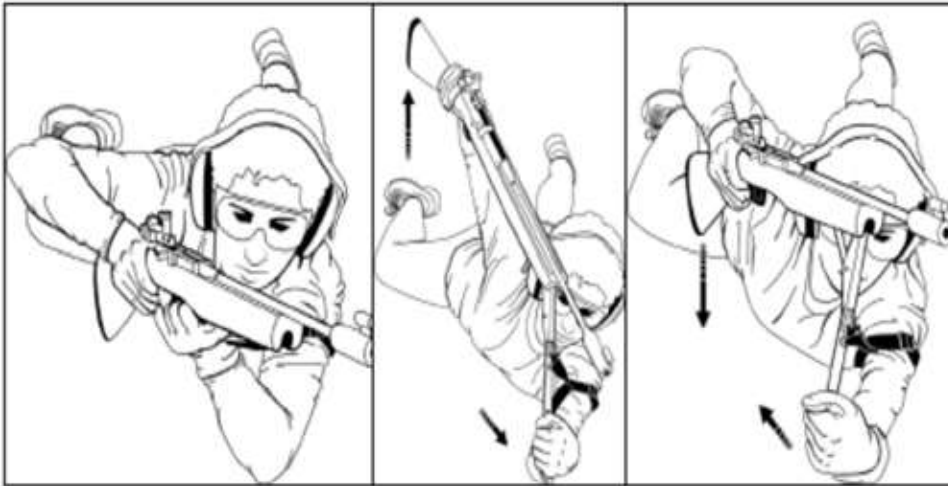

Cadet Marksmanship Program Reference Manual

Figure 7 Pumping the air rifle



The rifle should not be pumped more than once per shot. This air rifle is designed to withstand the pressure based on a single pump stroke.

CONFIRMATION OF TEACHING POINT 4

The instructor will divide the group into two, or into the number of air rifles available. The instructor shall have one group imitate the actions of the sequence as demonstrated, while the remainder observe. Have them trade places, and repeat.

Teaching Point 5

Explain, demonstrate, and have the cadets practice the actions required on the command “Relay, unload and prepare for inspection.”

Time: 22 min

Method: Demonstration and Performance



The instructor shall provide an explanation and demonstration of the complete skill.

The instructor shall also provide an explanation and demonstration of each step required to effectively complete the skill.

Then, the cadets, under the supervision of the instructor, will have an opportunity to perform each step.

This will be conducted as a DRY FIRE EXERCISE ONLY.

UNLOADING AND PREPARING FOR INSPECTION

Follow the unloading sequence of the cadet air rifle, to include:

1. pick up the air rifle;
2. remove the five pellet clip (if used);
3. pump the air rifle (hold for three seconds and close);
4. move the bolt forward (do not insert a pellet);
5. place the safety catch in the OFF position;
6. aim the rifle at the target;
7. squeeze the trigger;
8. open the bolt;
9. place the safety catch in the ON position;
10. open the pump lever 5-8 cm;
11. place the rifle on the shoulder, muzzle pointed down range;
12. wait to be cleared by the RSO; and
13. lay the rifle down.

CONFIRMATION OF TEACHING POINT 5

The instructor will divide the group into two, or into the number of air rifles available. The instructor shall have one group imitate the actions of the sequence as demonstrated, while the remainder observe. Have them trade places, and repeat.

END OF LESSON CONFIRMATION

The instructor will divide the group into two, or by the number of air rifles available. The instructor shall have one group imitate the actions of the sequence for all teaching points as demonstrated, while the remainder observe, and then have them trade places, and repeat.

CONCLUSION

HOMEWORK/READING/PRACTICE

Nil.

METHOD OF EVALUATION

Assessment of this EO will occur during EO M106.05 (Participate in Marksmanship Familiarization Using the Cadet Air Rifle), where cadets are required to successfully complete the Cadet Air Rifle Handling Test prior to firing.

CLOSING STATEMENT

The first principle of marksmanship is to find a comfortable firing position. A comfortable firing position will enable cadets to fire safely and with much better results. The prone position is the most stable firing position to use.

INSTRUCTOR NOTES/REMARKS

1. Emphasis must be placed on the safety aspects of this lesson.
2. Ensure thorough confirmation by stages.

REFERENCES

A0-027 A-CR-CCP-177/PT-001 D Cdts 3. (2001). *Canadian Cadet Movement: Cadet Marksmanship Programme Reference Manual*. Ottawa, ON: Department of National Defence.



**COMMON TRAINING
GREEN STAR
INSTRUCTIONAL GUIDE**



SECTION 4

EO M106.04 – FOLLOW RULES AND COMMANDS ON AN AIR RIFLE RANGE

Total Time:

30 min

PREPARATION

PRE-LESSON INSTRUCTIONS

Resources needed for the delivery of this lesson are listed in the lesson specification located in A-CR-CCP-701/PG-001, *Green Star Qualification Standard and Plan*, Chapter 4. Specific uses for said resources are identified throughout the instructional guide within the TP for which they are required.

Prior to instructing this lesson the instructor shall:

- review the lesson content, and become familiar with the material; and
- prepare a mock air rifle range to be used when teaching the lesson.

PRE-LESSON ASSIGNMENT

Nil.

APPROACH

An interactive lecture was chosen for TP 1 to orient the cadets to the rules to be followed on a range and generate interest.

A demonstration and performance was chosen for TP 2 as it allows the instructor to explain and demonstrate responding to range commands, while providing an opportunity for the cadets to practice under supervision.

INTRODUCTION

REVIEW

The pertinent review for this lesson, from EO M106.03 (Section 3), will include:

QUESTIONS

- Q1. What two things do a good prone position help to maintain?
- Q2. Sight alignment consists of what three steps?
- Q3. What is added to the innermost ring to obtain a proper sight picture?

ANTICIPATED ANSWERS

- A1. Comfort and stability.
- A2. The eye, the rear sight, and the front sight.
- A3. A bull's-eye.

OBJECTIVES

By the end of this lesson the cadet shall be expected to handle rifles safely and properly execute range commands.

IMPORTANCE

Firearms safety is the number one priority on and off the range so everyone must do their part to prevent accidents. In marksmanship, the majority of incidents are caused by ignorance of proper rifle operating procedures or by mishandling.

Teaching Point 1**Explain rules cadets must follow on the range.**

Time: 10 min

Method: Interactive Lecture

RULES CADETS MUST FOLLOW ON THE RANGE**The instructor will read Local Range Standing Orders at the beginning of this period.**

Range Standing Orders are locally produced for each range. They detail rules to be followed on that range. General rules observed on all ranges include:

1. Rifles will be proved safe when picked up, handed to or received from another person.
2. Rifles are never pointed at any person.
3. Safety rods shall be inserted into the barrels of rifles when not in use on the range.
4. Horseplay is forbidden on the range.
5. Rifles, whether loaded or not, will always be pointed down range.
6. Eating is not permitted on or near the range or around the pellets.
7. All personnel shall read or be briefed on the contents of the Range Standing Orders.
8. The RSO's directions and orders are to be obeyed at all times.

CONFIRMATION OF TEACHING POINT 1

QUESTIONS

- Q1. When should a rifle be proved safe?
Q2. When can rifles be pointed at other people?
Q3. When should the directions and orders of the RSO be followed?

ANTICIPATED ANSWERS

- A1. When picked up, handed to or received from another person.
A2. Rifles are never pointed at any person.
A3. The RSO's directions and orders are to be obeyed at all times.

Teaching Point 2**Explain range commands.**

Time: 15 min

Method: Demonstration and Performance



The instructor shall provide an EXPLANATION and DEMONSTRATION of each command and the associated action to be taken.

All loading/firing is to be simulated. No pellets are to be fired.

RANGE COMMANDS CADETS MUST FOLLOW

COMMAND	ACTION
“Cover off your firing point”	Stand up, move behind the firing point and await further commands.
“Place your equipment down and stand back”	Lay the equipment down on the mat and stand back when finished.
“Adopt the prone position”	Adopt the prone position, pick up the rifle, ready the equipment and put on hearing (if applicable) and eye protection.
Type of firing	This command includes information about the range and type of firing. i.e., Relay #__, ten (10) metres, five (5) rounds, Grouping, On Your Own Time...
“Relay, load, commence firing”	<p>Pick up the rifle with the left hand;</p> <p>Ensure the safety catch is in the ON position;</p> <p>Pump the rifle, pausing for three seconds with the pump handle fully extended;</p> <p>Bring the pump handle back to the closed position;</p> <p>Load the pellet;</p> <p>Close the bolt;</p> <p>Place the safety catch in the OFF position; Aim the rifle at the target.</p> <p>Squeeze the trigger;</p> <p>Open the bolt, pump the rifle, re-load, aim, and fire;</p> <p>Repeat the last step until firing is complete;</p> <p>Upon completion, place the safety catch in the ON position, open the bolt, and partially open the pump lever; and</p> <p>Lay down the rifle.</p>
MAY BE GIVEN	

COMMAND	ACTION
<p>“Relay, cease fire”</p> <p>“Relay, resume fire”</p>	<p>Stop firing immediately, put the safety catch in the ON position and lay the rifle down.</p> <p>Put the safety in the OFF position and continue the practice.</p>
<p>“Relay, unload and prepare for inspection”</p>	<p>Pick up the rifle;</p> <p>Remove the five (5) pellet clip if used;</p> <p>Pump the rifle (hold for three seconds and close);</p> <p>Move the bolt forward;</p> <p>Place the safety catch in the OFF position;</p> <p>Aim rifle at target;</p> <p>Pull the trigger;</p> <p>Open the bolt;</p> <p>Place safety catch in the ON position;</p> <p>Open the pump lever 5-8 cm;</p> <p>Place the rifle on the shoulder, muzzle pointed down range;</p> <p>Wait to be cleared by the RSO;</p> <p>Lay the rifle down; and</p> <p>Remove your hearing (if applicable) and eye protection.</p>
<p>“Relay, stand up”</p>	<p>Stand up and leave the equipment on the ground.</p>
<p>“Change targets”</p>	<p>Move forward, walk down the lane to remove old targets and replace them with new ones. Return to the firing point.</p>
<p>“Change relays”</p>	<p>Cadets who have just fired pick up their personal equipment and move off the firing point. The new relay covers off behind the firing point.</p>



Cadets will IMITATE the demonstration provided by the instructor for each step within the process. The instructor(s) will SUPERVISE the cadets during this imitation.



The information in this teaching point is amplified in Annex A, and should be reviewed prior to any cadet participating in a marksmanship practice.

CONFIRMATION OF TEACHING POINT 2

Confirmation of this teaching point shall be accomplished through observation during the above imitation and supervision phases.

END OF LESSON CONFIRMATION

QUESTIONS

- Q1. When is horseplay allowed on the range?
- Q2. The contents of the Range Standing Orders shall be read to whom?
- Q3. What direction must rifles be pointed while on the range?

ANTICIPATED ANSWERS

- A1. Never, it is forbidden.
- A2. Everyone.
- A3. Down range at all times.

CONCLUSION

HOMEWORK/READING/PRACTICE

Study "Range Commands and Action" chart prior to all range practices.

METHOD OF EVALUATION

Assessment of this EO will occur during EO M106.05 (Participate in Marksmanship Familiarization Using the Cadet Air Rifle), where cadets are required to successfully complete the Cadet Air Rifle Handling Test prior to firing.

CLOSING STATEMENT

Firearms safety is the number one priority on and off the range, so everyone must do their part to prevent accidents. In marksmanship, the majority of incidents are caused by either ignorance of proper rifle operating procedures, or by mishandling.

INSTRUCTOR NOTES/REMARKS

Nil.

REFERENCES

A0-027 A-CR-CCP-177/PT-001 D Cdts 3. (2001). *Canadian Cadet Movement: Cadet Marksmanship Programme Reference Manual*. Ottawa, ON: Department of National Defence.

RANGE COMMANDS

COMMAND	ACTION
“Cover off your firing point”	Stand up, move behind the firing point and await further commands.
“Place your equipment down and stand back”	Lay the equipment down on the mat and stand back when finished.
“Adopt the prone position”	Adopt the prone position, pick up the rifle, ready the equipment and put on hearing (if applicable) and eye protection.
Type of firing	This command includes information about the range and type of firing. i.e., Relay #__, ten (10) metres, five (5) rounds, Grouping, On Your Own Time...
“Relay, load, commence firing”	<p>Pick up the rifle with the left hand;</p> <p>Ensure the safety catch is in the ON position;</p> <p>Pump the rifle, pausing for three seconds with the pump handle fully extended;</p> <p>Bring the pump handle back to the closed position;</p> <p>Load the pellet;</p> <p>Close the bolt;</p> <p>Place the safety catch in the OFF position; Aim the rifle at the target.</p> <p>Squeeze the trigger;</p> <p>Open the bolt, pump the rifle, re-load, aim, and fire;</p> <p>Repeat the last step until firing is complete;</p> <p>Upon completion, place the safety catch in the ON position, open the bolt, and partially open the pump lever; and</p> <p>Lay down the rifle.</p>
MAY BE GIVEN	
“Relay, cease fire” “Relay, resume fire”	<p>Stop firing immediately, put the safety catch in the ON position and lay the rifle down.</p> <p>Put the safety in the OFF position and continue the practice.</p>

COMMAND	ACTION
<p>“Relay, unload and prepare for inspection”</p>	<p>Pick up the rifle; Remove the five (5) pellet clip if used; Pump the rifle (hold for three seconds and close); Move the bolt forward; Place the safety catch in the OFF position; Aim rifle at target; Pull the trigger; Open the bolt; Place safety catch in the ON position; Open the pump lever 5-8 cm; Place the rifle on the shoulder, muzzle pointed down range; Wait to be cleared by the RSO; Lay the rifle down; and Remove your hearing (if applicable) and eye protection.</p>
<p>“Relay, stand up”</p>	<p>Stand up and leave the equipment on the ground.</p>
<p>“Change targets”</p>	<p>Move forward, walk down the lane to remove old targets and replace them with new ones. Return to the firing point.</p>
<p>“Change relays”</p>	<p>Cadets who have just fired pick up their personal equipment and move off the firing point. The new relay covers off behind the firing point.</p>



COMMON TRAINING
GREEN STAR
INSTRUCTIONAL GUIDE



SECTION 5

EO M106.05 – PARTICIPATE IN MARKSMANSHIP FAMILIARIZATION USING THE CADET AIR RIFLE

Total Time:

90 min

PREPARATION

PRE-LESSON INSTRUCTIONS

Resources needed for the delivery of this lesson are listed in the lesson specification located in A-CR-CCP-701/PG-001, *Green Star Qualification Standard and Plan*, Chapter 4. Specific uses for said resources are identified throughout the instructional guide within the TP for which they are required.

Review the lesson content, unit range standing orders, and become familiar with the material prior to delivering the lesson.

Construct a range IAW A-CR-CCP-177/PT-001, *Canadian Cadet Movement: Cadet Marksmanship Program Reference Manual*.

Photocopy the Cadet Air Rifle Handling Test for each cadet.

PRE-LESSON ASSIGNMENT

Nil.

APPROACH

A practical activity was chosen for this lesson as it is an interactive way to allow the cadet to experience marksmanship familiarization in a safe and controlled environment. This activity contributes to the development of marksmanship skills and knowledge in a fun and challenging setting.

INTRODUCTION

REVIEW

The review for this lesson will be from EO M106.02 (Carry Out Safety Precautions on the Cadet Air Rifle).

QUESTIONS:

- Q1. Why do we follow safety regulations?
- Q2. How would you verify the safety catch is ON?
- Q3. What are the four "ACTS" of firearm safety?

ANTICIPATED ANSWERS:

A1. We follow safety regulations to prevent accidents with the cadet air rifle.

A2. When the safety is ON, no red can be seen.

A3. The mnemonic "ACTS" stands for:

- Assume every firearm is loaded.
- Control the muzzle direction at all times.
- Trigger finger must be kept off the trigger and out of the trigger guard.
- See that the firearm is unloaded (prove it safe).

OBJECTIVES

By the end of this lesson the cadet shall have participated in marksmanship familiarization using the cadet air rifle.

IMPORTANCE

It is important for cadets to participate in a marksmanship familiarization activity because it allows them to experience marksmanship in a fun, dynamic and safe setting.

Teaching Point 1**Supervise the cadets' participation in marksmanship familiarization.**

Time: 10 min

Method: Practical Activity



A range briefing is conducted to pass on vital information and answer any questions the cadets may have prior to participating in a marksmanship activity. The range briefing is required to ensure the safe execution of a marksmanship activity.



The range safety briefing is normally conducted by a Range Safety Officer (RSO), as the safety of the range is their responsibility.

CONDUCT A RANGE BRIEFING

The following elements may be included in a range briefing. They would be adjusted based on the requirements of the activity.

1. Welcome and staff introduction.
2. An overview of the range layout. Description of the out of bounds / danger areas, location of range facilities, location of concurrent activities, as well as routes of access.
3. The general safety rules.
4. An explanation of the activity and course of fire: Type of activity / Training conducted, the distance, the targets being used, the indication (number of rounds and how they will be fired), and the scoring.
5. The equipment being used, eg rifles, ammunition, safety equipment.
6. The safety precautions: individual safety precautions, rifle safety principles, and safe rifle status.
7. The range commands that will be heard during the activity.
8. The cease fire command: When to use it, who can call it, and action upon hearing a cease fire.
9. Immediate actions (IAs) and stoppages: The types of stoppages that may occur and the immediate actions that must be taken.
10. Personal hygiene, eg washing hands after handling ammunition or rifles.
11. First aid and emergencies: Location of first aid point, identification of first aider, action in the event of an emergency, emergency routes of access, emergency response plan.
12. Assignment of relays: Number of relays, assignment of relay, and timing of relay.
13. Concurrent activities: Type, timing, supervisory staff / OPI.
14. Additional items, eg ensuring handling tests have been completed, timing for the activity (when the activity will begin), declaration requirements, breaks, messing / meals / snacks, set up and dismantling of the range.
15. Opportunity for cadets to ask questions.

CONDUCT THE AIR RIFLE HANDLING TEST

As per instructions in the Qualification Standard Plan, Chapter 3, Annex C, conduct the Air Rifle Handling Test.



Each cadet must complete the Air Rifle Handling Test prior to firing pellets or felt cleaning pellets on a range.

ACTIVITY

OBJECTIVE

The objective of this activity is to have the cadets participate in marksmanship familiarization.

RESOURCES

- Cadet air rifle (one per firing lane),
- Air rifle pellets (as per activity chosen),
- Target frames (one per firing lane),
- Targets (as per activity chosen),
- Marksmanship mats (one per firing lane),
- Scoring template,
- .177- / .22-scoring magnifier (scoring magnifier),
- Scoring plug,
- Safety glasses / goggles (one per firing lane and for range staff), and
- Pen / pencil.

ACTIVITY LAYOUT

Nil.

ACTIVITY INSTRUCTIONS

Once the range briefing has been conducted, and cadets have successfully completed the cadet air rifle handling test, supervise the cadets' participation in a marksmanship familiarization activity.

SAFETY

Range activities will be conducted IAW A-CR-CCP-177/PT-001, *Canadian Cadet Movement: Cadet Marksmanship Program Reference Manual*.

CONFIRMATION OF TEACHING POINT 1

The cadets' participation in the activity will serve as the confirmation of this TP.

END OF LESSON CONFIRMATION

The cadets' participation in the marksmanship activity will serve as the confirmation of this lesson.

CONCLUSION

HOMEWORK / READING / PRACTICE

Nil.

METHOD OF EVALUATION

Nil.

CLOSING STATEMENT

Marksmanship is a fun and exciting activity that requires personal discipline and teamwork skills. This activity has also developed into highly competitive levels at the provincial, regional, and national levels.

INSTRUCTOR NOTES / REMARKS

Hand-washing stations must be available for cleanup after the activity is completed.

REFERENCES

A0-027 A-CR-CCP-177/PT-001 Director Cadets 3. (2005). *Canadian cadet movement: Cadet marksmanship program reference manual*. Ottawa, ON: Department of National Defence.

A0-041 CATO 14-41 Director Cadets 4. (2007). *Marksmanship, rifles and ammunition*. Ottawa ON: Department of National Defence.

THIS PAGE INTENTIONALLY LEFT BLANK



**COMMON TRAINING
GREEN STAR
INSTRUCTIONAL GUIDE**



SECTION 6

EO C106.01 – PARTICIPATE IN A RECREATIONAL MARKSMANSHIP ACTIVITY

Total Time:

90 min

PREPARATION

PRE-LESSON INSTRUCTIONS

Resources needed for the delivery of this lesson are listed in the lesson specification located in A-CR-CCP-701/PG-001, *Green Star Qualification Standard and Plan*, Chapter 4. Specific uses for said resources are identified throughout the instructional guide within the TP for which they are required.

Review the lesson content, range standing orders, and become familiar with the material prior to delivering the lesson.

Photocopy the targets located at Attachments B–R as required.

Construct a range IAW A-CR-CCP-177/PT-001, *Canadian Cadet Movement: Cadet Marksmanship Program Reference Manual*.

PRE-LESSON ASSIGNMENT

Nil.

APPROACH

A practical activity was chosen for this lesson as it is an interactive way to allow the cadet to experience recreational marksmanship in a safe and controlled environment. This activity contributes to the development of marksmanship skills and knowledge in a fun and challenging setting.

INTRODUCTION

REVIEW

The review for this lesson consists in the procedures evaluated as part of the Air Rifle Handling Test.

OBJECTIVES

By the end of this lesson the cadet shall have participated in a recreational marksmanship activity.

IMPORTANCE

It is important for cadets to participate in a recreational marksmanship activity because it allows them to experience marksmanship in a fun, dynamic and safe setting.

Teaching Point 1**Supervise the cadet's participation in a recreational marksmanship activity.**

Time: 80 min

Method: Practical Activity



A range briefing is conducted to pass on vital information and answer any questions the cadets may have prior to participating in a marksmanship activity. The range briefing is required to ensure the safe execution of a marksmanship activity.

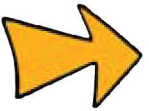

The range safety briefing is normally conducted by a Range Safety Officer (RSO), as the safety of the range is their responsibility.

CONDUCT A RANGE BRIEFING

The following elements may be included in a range briefing. They would be adjusted based on the requirements of the activity.

1. Welcome and staff introduction.
2. An overview of the range layout. Description of the out of bounds / danger areas, location of range facilities, location of concurrent activities, as well as routes of access.
3. The general safety rules.
4. An explanation of the activity and course of fire: Type of activity / Training conducted, the distance, the targets being used, the indication (number of rounds and how they will be fired), and the scoring.
5. The equipment being used, eg rifles, ammunition, safety equipment.
6. The safety precautions: individual safety precautions, rifle safety principles, and safe rifle status.
7. The range commands that will be heard during the activity.
8. The cease fire command: When to use it, who can call it, and action upon hearing a cease fire.
9. Immediate actions (IAs) and stoppages: The types of stoppages that may occur and the immediate actions that must be taken.
10. Personal hygiene, eg washing hands after handling ammunition or rifles.
11. First aid and emergencies: Location of first aid point, identification of first aider, action in the event of an emergency, emergency routes of access, emergency response plan.
12. Assignment of relays: Number of relays, assignment of relay, and timing of relay.
13. Concurrent activities: Type, timing, supervisory staff / OPI.
14. Additional items, eg ensuring handling tests have been completed, timing for the activity (when the activity will begin), declaration requirements, breaks, messing / meals / snacks, set up and dismantling of the range.
15. Opportunity for cadets to ask questions.

ACTIVITY

OBJECTIVE

The objective of this activity is to have the cadets participate in a recreational marksmanship activity.

RESOURCES

- Cadet air rifle (one per firing lane),
- Cadet air rifle sling (one per firing lane),
- Air rifle pellets (as per activity chosen),
- Target frames (one per firing lane),
- Targets (as per activity chosen),
- Marksmanship mats (one per firing lane),
- Safety glasses / goggles (one per person in the room),
- .177- / .22-scoring magnifier (scoring magnifier),
- Scoring plug,
- Scoring template,
- Stopwatch, and
- Pen / pencil.



Additional resources required for specific marksmanship activities may be found in the Attachments.

ACTIVITY LAYOUT

Nil.

ACTIVITY INSTRUCTIONS

Ensure all cadets have completed the Air Rifle Handling Test prior to the conduct of this activity. Cadets who have not completed the Air Rifle Handling Test must do so prior to firing on the range.

1. Brief cadets on the safety rules or any other guidelines pertaining to the activity.
2. Divide the cadets into relays according to the number of firing lanes.
3. Conduct a recreational marksmanship activity choosing from the following categories:
 - (a) classification,
 - (b) fun activities,

- (c) timed activities, or
- (d) competitive team / individual activities.

SAFETY

Range activities will be conducted IAW A-CR-CCP-177/PT-001, *Canadian Cadet Movement: Cadet Marksmanship Program Reference Manual*.

CONFIRMATION OF TEACHING POINT 1

The cadets' participation in the activity will serve as the confirmation of this TP.

END OF LESSON CONFIRMATION

The cadets' participation in the recreational marksmanship activity will serve as the confirmation of this lesson.

CONCLUSION

HOMEWORK / READING / PRACTICE

Nil.

METHOD OF EVALUATION

Nil.

CLOSING STATEMENT

Marksmanship is a fun and exciting activity that requires personal discipline and teamwork skills. This activity has also developed into highly competitive levels at the zone, regional, and national levels.

INSTRUCTOR NOTES / REMARKS

Hand-washing stations must be available for cleanup after the activity is completed.

REFERENCES

A0-027 A-CR-CCP-177/PT-001 Director Cadets 3. (2005). *Canadian cadet movement: Cadet marksmanship program reference manual*. Ottawa, ON: Department of National Defence.

A0-041 CATO 14-41 Director Cadets 4. (2007). *Marksmanship, rifles and ammunition*. Ottawa ON: Department of National Defence.

RECREATIONAL MARKSMANSHIP ACTIVITIES

CLASSIFICATION

- Classification (Attachment B)

FUN ACTIVITIES

- Pyramid (Attachment C)
- Beach Ball (Attachment D)
- Balloons (Attachment E)
- Rack'em Up (Attachment F)
- Lights Out (Attachment G)
- Save the Day (Attachment H)
- Flower Pot (Attachment I)

TIMED ACTIVITIES

- Chase the Dots (Attachment J)
- Speed Grid (Attachment K)
- Beat the Clock (Attachment L)
- Dartboard (Attachment M)
- Cut the Fuses (Attachment N)
- Shoo-Fly (Attachment O)
- Good Break (Attachment P)

COMPETITIVE TEAM / INDIVIDUAL ACTIVITIES

- Simulated Stage 1 Championship (Attachment Q)
- Simulated Stage 2 Championship (Attachment R)

THIS PAGE INTENTIONALLY LEFT BLANK

CLASSIFICATION

CLASSIFICATION ACTIVITY

Objective: To provide cadets the opportunity to obtain marksmanship classifications.

Scoring: The standard for the classification levels are:

1. Marksman: Two five-round groupings within a circle of 3 cm in diameter.
2. First Class Marksman: Two five-round groupings within a circle of 2.5 cm in diameter.
3. Expert Marksman: Two five-round groupings within a circle of 2 cm in diameter.
4. Distinguished Marksman: Two five-round groupings within a circle of 1.5 cm in diameter.

Equipment Required:

- Air rifle marksmanship equipment,
- Cadet air rifle,
- Air rifle pellets (10 per participant),
- CCT2000GRTD Canadian Cadet Movement Air Rifle Grouping Target (two per cadet),
- Air Rifle Grouping Template from A-CR-CCP-177/PT-001 (p. B1-1),
- Target frame, and
- Stopwatch.

Optional aids to firing are limited to the following:

- Cadet air rifle sling,
- Marksmanship jacket,
- Marksmanship glove, and
- Hat.

Activity Instructions:

1. Brief the cadets on the activity being conducted including any safety rules or other guidelines pertaining to the activity.
2. Distribute two targets to each cadet.
3. Have the cadets write their name and date on the targets and attach them to the target frame.
4. Give each cadet in the relay 10 pellets to fire 5 into the centre of each target.
5. Have the cadets fire, in relays, following the commands given by the RSO.
6. Give the cadets 15 minutes to complete firing.
7. Have the cadets retrieve their targets.
8. Score the targets using the Air Rifle Grouping Template.
9. Record the scores and allow the cadets to keep their targets.

The following are prohibited:

- Cross firing,
- Alterations, other than those permitted in A-CR-CCP-177/PT-001 Part 4, Section 4, Para 5.3,
- A pellet-loading clip,
- Supports used as a rest for the rifle or the forearm,
- A spotting scope,
- Use of sights not provided with the cadet air rifle, and
- Coaching.

PYRAMID

Objective: To fire pellets into each point on the pyramid.

Scoring: Score the targets awarding:

- a. three points for each corner hit on the pyramid,
- b. two points for each hit within one block of a corner,
- c. one point for each hit within two blocks of a corner.

Equipment Required:

- Air rifle marksmanship equipment,
- Cadet air rifle,
- Air rifle pellets (6 per participant),
- Pyramid Target (one per participant),
- Target frame, and
- Stopwatch.

Activity Instructions:

1. Brief the cadets on the activity being conducted including any safety rules or other guidelines pertaining to the activity.
2. Distribute a target to each cadet.
3. Have the cadets write their name and date on the target and attach it to the target frame.
4. Give each cadet in the relay six pellets to fire, two pellets into each corner of the pyramid.
5. Have the cadets fire, in relays, following the commands given by the RSO.
6. Give the cadets three minutes to complete firing.
7. Have the cadets retrieve their targets.
8. Score the targets awarding:
 - (a) three points for each corner hit on the pyramid,
 - (b) two points for each hit within one block of a corner,
 - (c) one point for each hit within two blocks of a corner.
9. Allow the cadets to review and keep their targets.

The following are prohibited:

- Alterations, other than those permitted in A-CR-CCP-177/PT-001 Part 4, Section 4, Para 5.3,
- A pellet-loading clip,
- Supports used as a rest for the rifle or the forearm,
- A spotting scope, and
- Use of sights not provided with the cadet air rifle.

PYRAMID TARGET

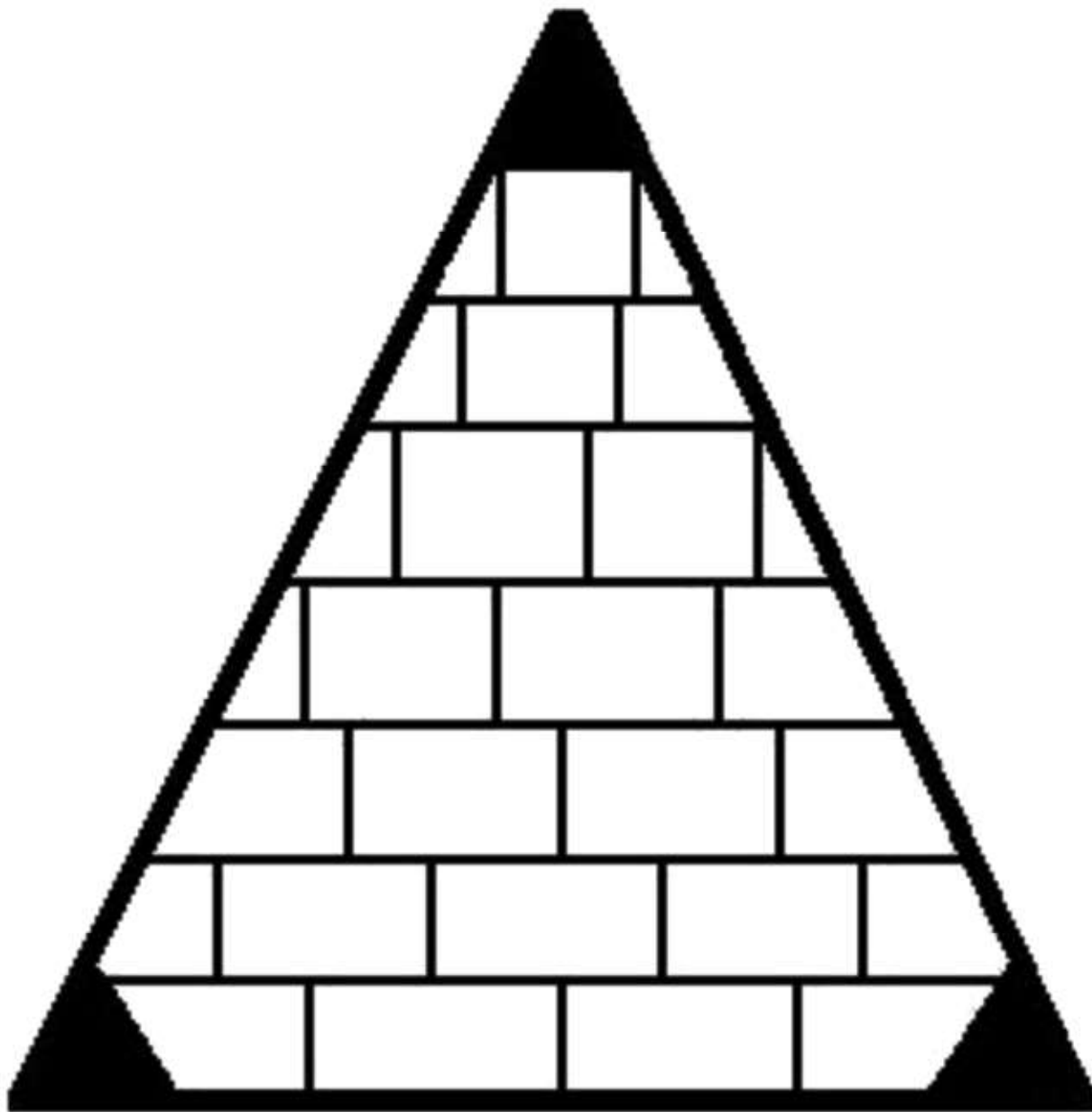

Name: _____

Date: _____

Witness: _____

Score: _____

THIS PAGE INTENTIONALLY LEFT BLANK

BEACH BALL

Objective: To fire 10 pellets into the black circle on the beach ball.

Scoring: One point is awarded for each successful hit in the black circle.

Equipment Required:

- Air rifle marksmanship equipment,
- Cadet air rifle,
- Air rifle pellets (10 per participant),
- Beach Ball Target (one per participant),
- Target frame, and
- Stopwatch.

Activity Instructions

1. Brief the cadets on the activity being conducted including any safety rules or other guidelines pertaining to the activity.
2. Distribute a target to each cadet.
3. Have the cadets write their name and date on the target and attach it to the target frame.
4. Give the cadets 10 pellets to fire into the black circle of the beach ball.
5. Have the cadets fire, in relays, following the commands given by the RSO.
6. Give the cadets 10 minutes to complete firing.
7. Have the cadets retrieve their targets.
8. Score the targets awarding one point for each pellet hit within the black circle.
9. Allow the cadets to review and keep their targets.

The following are prohibited:

- Cross firing,
- Alterations, other than those permitted in A-CR-CCP-177/PT-001 Part 4, Section 4, Para 5.3,
- A pellet-loading clip,
- Supports used as a rest for the rifle or the forearm,
- A spotting scope, and
- Use of sights not provided with the cadet air rifle.

BEACH BALL TARGET



Name:

Date:

Witness:

Score:

BALLOONS

Objective: To fire pellets into balloons on the target.

Scoring: One point is awarded for each balloon hit by a pellet.

Equipment Required:

- Air rifle marksmanship equipment,
- Cadet air rifle,
- Air rifle pellets (20 per participant),
- Balloon Target (one per participant),
- Target frame, and
- Stopwatch.

Activity Instructions:

1. Brief the cadets on the activity being conducted including any safety rules or other guidelines pertaining to the activity.
2. Distribute a target to each cadet.
3. Have the cadets write their name and date on the target and attach it to the target frame.
4. Give each cadet in the relay 20 pellets to fire, one pellet into each balloon.
5. Have the cadets fire, in relays, following the commands given by the RSO.
6. Give the cadets 15 minutes to complete firing.
7. Have the cadets retrieve their targets.
8. Score the targets awarding one point for each balloon hit.
9. Allow the cadets to review and keep their targets.

The following are prohibited:

- Cross firing,
- Alterations, other than those permitted in A-CR-CCP-177/PT-001 Part 4, Section 4, Para 5.3,
- A pellet-loading clip,
- Supports used as a rest for the rifle or the forearm,
- A spotting scope, and
- Use of sights not provided with the cadet air rifle.

Note: Actual balloons may be used in place of the paper targets.

BALLOON TARGET

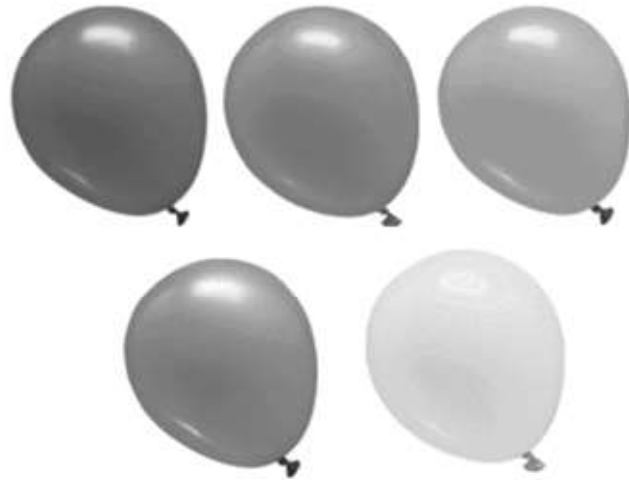
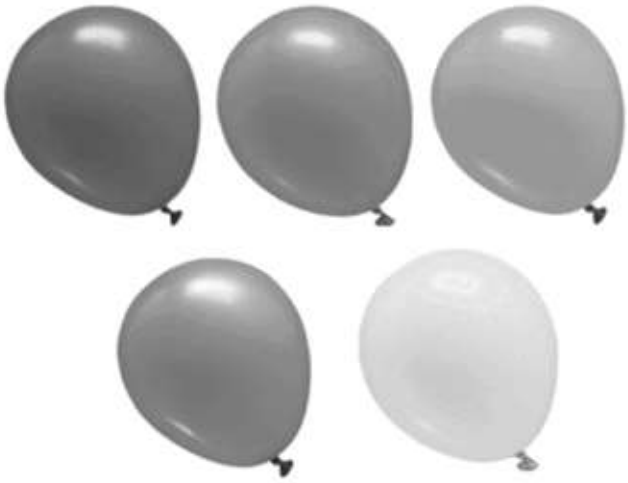
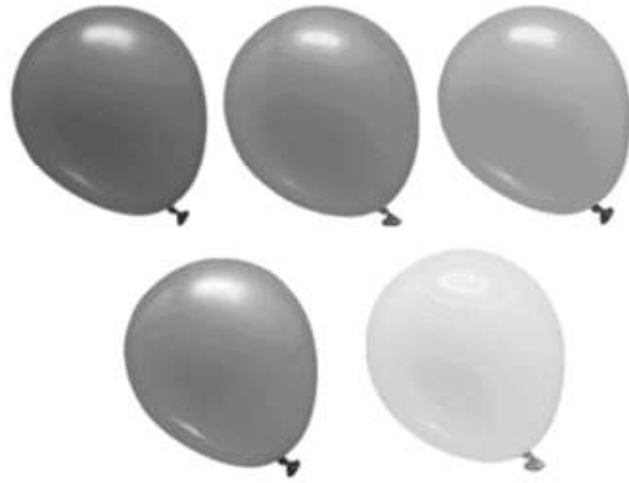
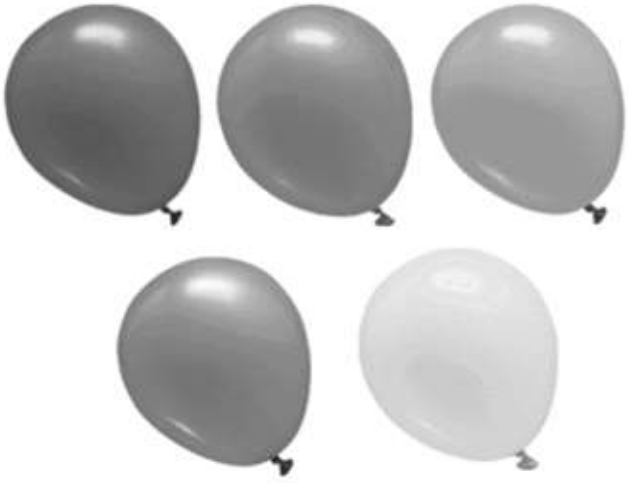

Name:

Date:

Witness:

Score:

RACK'EM UP

Objective: The cadets will be given 15 pellets and 15 minutes to fire a 1 pellet at the centre of each billiard ball.

Scoring: Targets will be scored by totalling the value for each billiard ball where the centre circle has a pellet hole located in it. Value for each ball is found on the billiard ball score sheet.

Equipment Required:

- Air rifle marksmanship equipment,
- Cadet air rifle,
- Air rifle pellets (15 per participant),
- Rack'em up Target (one per participant),
- Rack'em up scoresheet,
- Target frame, and
- Stopwatch.

Activity Instructions:

1. Brief the cadets on the activity being conducted including any safety rules or other guidelines pertaining to the activity.
2. Distribute a target to each cadet.
3. Have the cadets write their name and date on the target and attach it to the target frame.
4. Give each cadet in the relay 15 pellets to fire, one pellet into each billiard ball.
5. Have the cadets fire, in relays, following the commands given by the RSO.
6. Give the cadets 15 minutes to complete firing.
7. Have the cadets retrieve their targets.
8. Score the targets awarding one point for each balloon hit.
9. Allow the cadets to review and keep their targets.

The following are prohibited:

- Cross firing,
- Alterations, other than those permitted in A-CR-CCP-177/PT-001 Part 4, Section 4, Para 5.3,
- A pellet-loading clip,
- Supports used as a rest for the rifle or the forearm,
- A spotting scope, and
- Use of sights not provided with the cadet air rifle.

RACK'EM UP TARGET

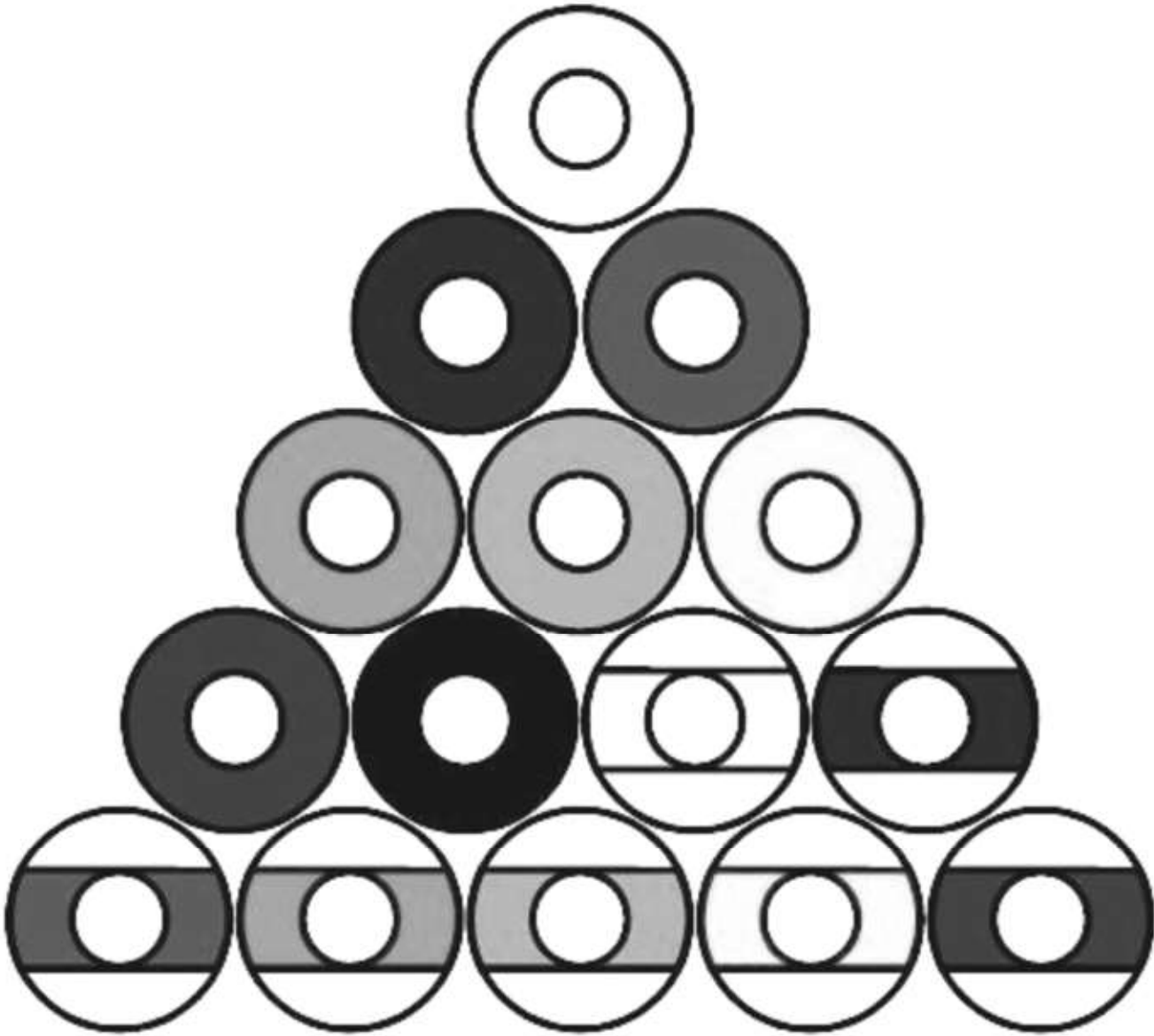

Name: _____

Date: _____

Witness: _____

Score: _____

RACK'EM UP SCORESHEET

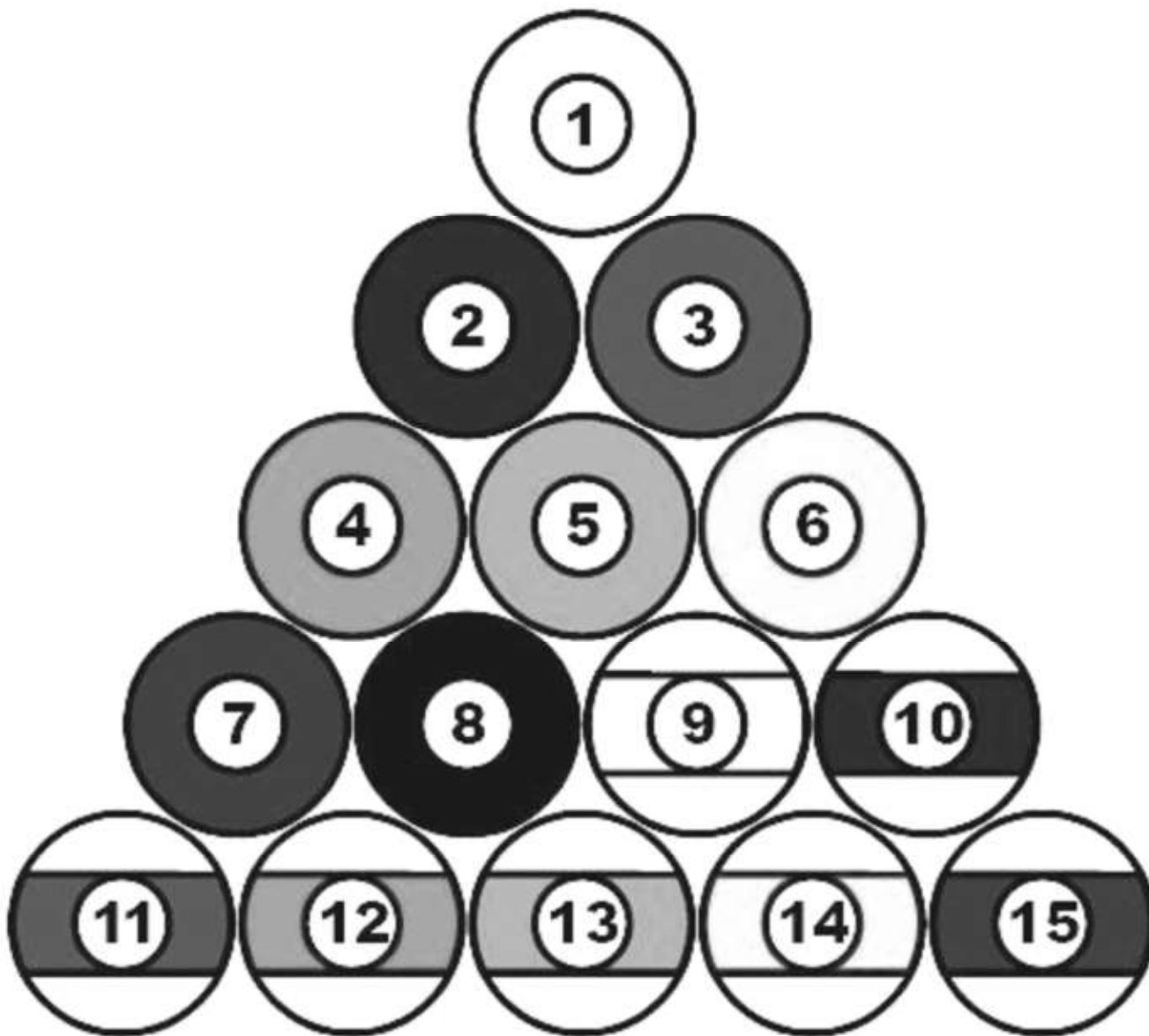

THIS PAGE INTENTIONALLY LEFT BLANK

LIGHTS OUT

Objective: The cadets will be given 10 pellets and 15 minutes to break all 6 light bulbs.

Scoring: One point is awarded for each broken bulb and two points for each broken filament. No points will be awarded for the screw base.

Equipment Required:

- Air rifle marksmanship equipment,
- Cadet air rifle,
- Air rifle pellets (10 per participant),
- Lights Out Target (one per participant),
- Target frame, and
- Stopwatch.

Activity Instructions:

1. Brief the cadets on the activity being conducted including any safety rules or other guidelines pertaining to the activity.
2. Distribute a target to each cadet.
3. Have the cadets write their name and date on the target and attach it to the target frame.
4. Give each cadet in the relay 10 pellets to fire.
5. Have the cadets fire, in relays, following the commands given by the RSO.
6. Give the cadets 15 minutes to complete firing.
7. Have the cadets retrieve their targets.
8. Score the targets (see above).
9. Allow the cadets to review and keep their targets.

The following are prohibited:

- Cross firing,
- Alterations, other than those permitted in A-CR-CCP-177/PT-001 Part 4, Section 4, Para 5.3,
- A pellet-loading clip,
- Supports used as a rest for the rifle or the forearm,
- A spotting scope, and
- Use of sights not provided with the cadet air rifle.

LIGHTS OUT TARGET



Name:

Date:

Witness:

Score:

SAVE THE DAY

Objective: The cadets will be given 5 pellets and 10 minutes to fire at (cut) the fuse of the dynamite.

Scoring: To defuse the dynamite, the cadet must hit the fuse above the split without hitting the dynamite. If the fuse is hit below the split, all three pieces must be hit to defuse the dynamite. A hit on the dynamite will cause it to explode.

Equipment Required:

- Air rifle marksmanship equipment,
- Cadet air rifle,
- Air rifle pellets (five per cadet),
- Save the Day Targets (one per cadet),
- Target frame, and
- Stopwatch.

Activity Instructions:

1. Brief the cadets on the activity being conducted including any safety rules or other guidelines pertaining to the activity.
2. Distribute a target to each cadet.
3. Have the cadets write their name and date on the target and attach it to the target frame.
4. Give each cadet in the relay five pellets to fire at the fuse.
5. Have the cadets fire, in relays, following the commands given by the RSO.
6. Give the cadets 10 minutes to complete firing.
7. Have the cadets retrieve their targets.
8. Score the targets (see above).
9. Allow the cadets to review and keep their targets.

The following are prohibited:

- Cross firing,
- Alterations, other than those permitted in A-CR-CCP-177/PT-001 Part 4, Section 4, Para 5.3,
- A pellet-loading clip,
- Supports used as a rest for the rifle or the forearm,
- A spotting scope, and
- Use of sights not provided with the cadet air rifle.

SAVE THE DAY TARGET

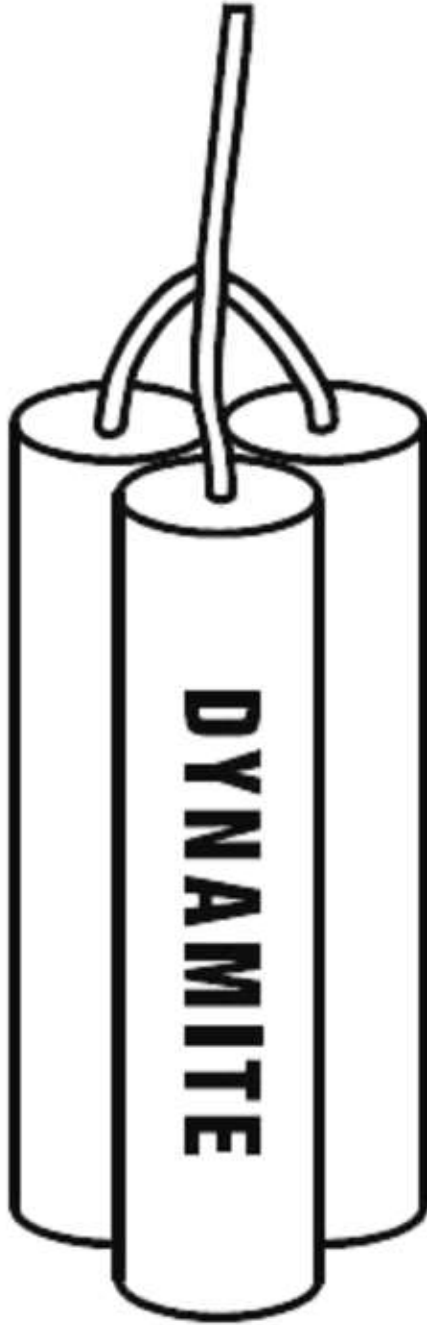

Name:

Date:

Witness:

Score:

FLOWER POT

Objective: The cadets will be given 10 pellets and 15 minutes to hit any part of the flower.

Scoring: One point is awarded for each petal, leaf or stem, and two points for each hit in the centre. One point will be deducted for each hit on the flower pot.

Equipment Required:

- Air rifle marksmanship equipment,
- Cadet air rifle,
- Air rifle pellets (10 pellets per participant),
- Flower Pot Target (one per participant),
- Target frame, and
- Stopwatch.

Activity Instructions:

1. Brief the cadets on the activity being conducted including any safety rules or other guidelines pertaining to the activity.
2. Distribute a target to each cadet.
3. Have the cadets write their name and date on the target and attach it to the target frame.
4. Give each cadet in the relay 10 pellets to fire.
5. Have the cadets fire, in relays, following the commands given by the RSO.
6. Give the cadets 15 minutes to complete firing.
7. Have the cadets retrieve their targets.
8. Score the targets (see above).
9. Allow the cadets to review and keep their targets.

The following are prohibited:

- Cross firing,
- Alterations, other than those permitted in A-CR-CCP-177/PT-001 Part 4, Section 4, Para 5.3,
- A pellet-loading clip,
- Supports used as a rest for the rifle or the forearm,
- A spotting scope, and
- Use of sights not provided with the cadet air rifle.

FLOWER POT TARGET

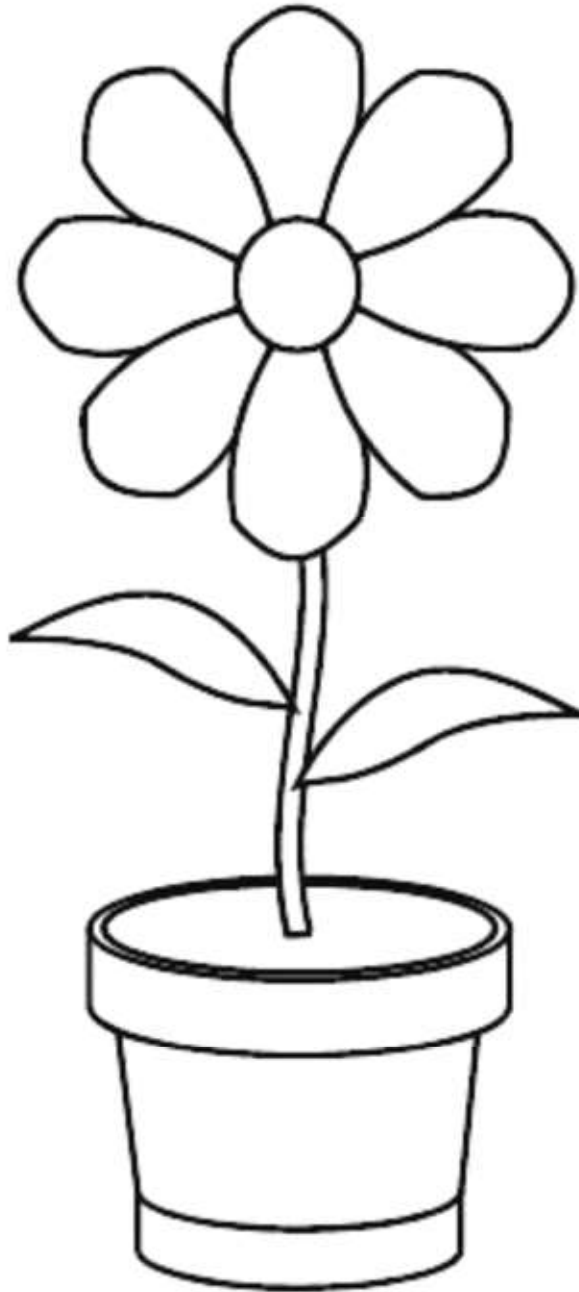

Name:

Date:

Witness:

Score:

CHASE THE DOTS

Objective: To fire pellets into the dots on the target, within a time limit.

Scoring: One point is awarded for each black dot that is hit by a pellet within the time allotted.

Equipment Required:

- Air rifle marksmanship equipment,
- Cadet air rifle,
- Air rifle pellets (10 pellets per participant),
- Chase the Dots Target (one per participant),
- Target frame, and
- Stopwatch.

Activity Instructions:

1. Brief the cadets on the activity being conducted including any safety rules or other guidelines pertaining to the activity.
2. Distribute a target to each cadet.
3. Have the cadets write their name and date on the target and attach it to the target frame.
4. Give the cadets in the relay eight pellets to fire, one pellet into each black dot, in a clockwise direction.
5. Have the cadets fire, in relays, following the commands given by the RSO.
6. Give the cadets four minutes to complete firing.
7. Return any unused pellets to the pellet controller.
8. Have the cadets retrieve their targets.
9. Score the targets awarding one point for each black dot hit.
10. Allow the cadets to review and keep their targets.

The following are prohibited:

- Alterations, other than those permitted in A-CR-CCP-177/PT-001 Part 4, Section 4, Para 5.3,
- A pellet-loading clip,
- Supports used as a rest for the rifle or the forearm,
- A spotting scope,
- Use of sights not provided with the cadet air rifle, and
- Coaching.

Note: To make this activity more difficult, shorten the time allowance.

CHASE THE DOTS TARGET

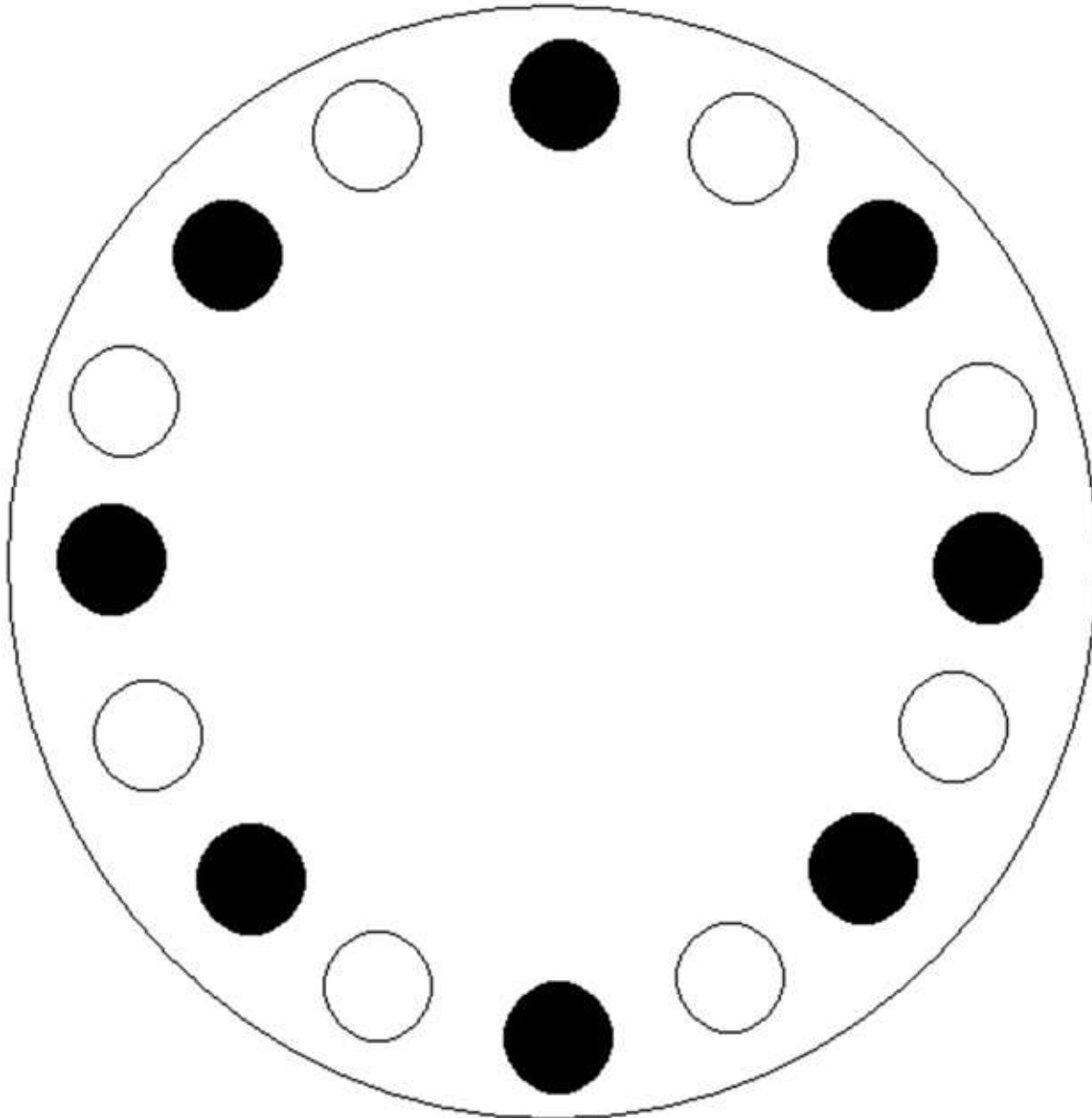

Name: _____

Date: _____

Witness: _____

Score: _____

SPEED GRID

Objective: To fire pellets into the circles on the target, within a time limit.

Scoring: One point is awarded for each circle that is hit by a pellet within the time allotted.

Equipment Required:

- Air rifle marksmanship equipment,
- Cadet air rifle,
- Cadet air rifle five-pellet clip (three per firing lane),
- Air rifle pellets (10 pellets per participant),
- Speed Grid Target (one per participant),
- Target frame, and
- Stopwatch.

Activity Instructions:

1. Brief the cadets on the activity being conducted including any safety rules or other guidelines pertaining to the activity.
2. Distribute a target to each cadet.
3. Have the cadets write their name and date on the target and attach it to the target frame.
4. Give the cadets 15 pellets, pre-loaded into three five-pellet clips.
5. Have the cadets fire one pellet into each circle on the target.
6. Have the cadets fire, in relays, following the commands given by the RSO.
7. Give the cadets eight minutes to complete firing.
8. Return any unused pellets to the pellet controller.
9. Have the cadets retrieve their targets.
10. Score the targets awarding one point for each circle hit.
11. Allow the cadets to review and keep their targets.

The following are prohibited:

- Alterations, other than those permitted in A-CR-CCP-177/PT-001 Part 4, Section 4, Para 5.3,
- Supports used as a rest for the rifle or the forearm,
- A spotting scope,
- Use of sights not provided with the cadet air rifle, and
- Coaching.

Note: To make this activity more difficult, shorten the time allowance.

SPEED GRID TARGET

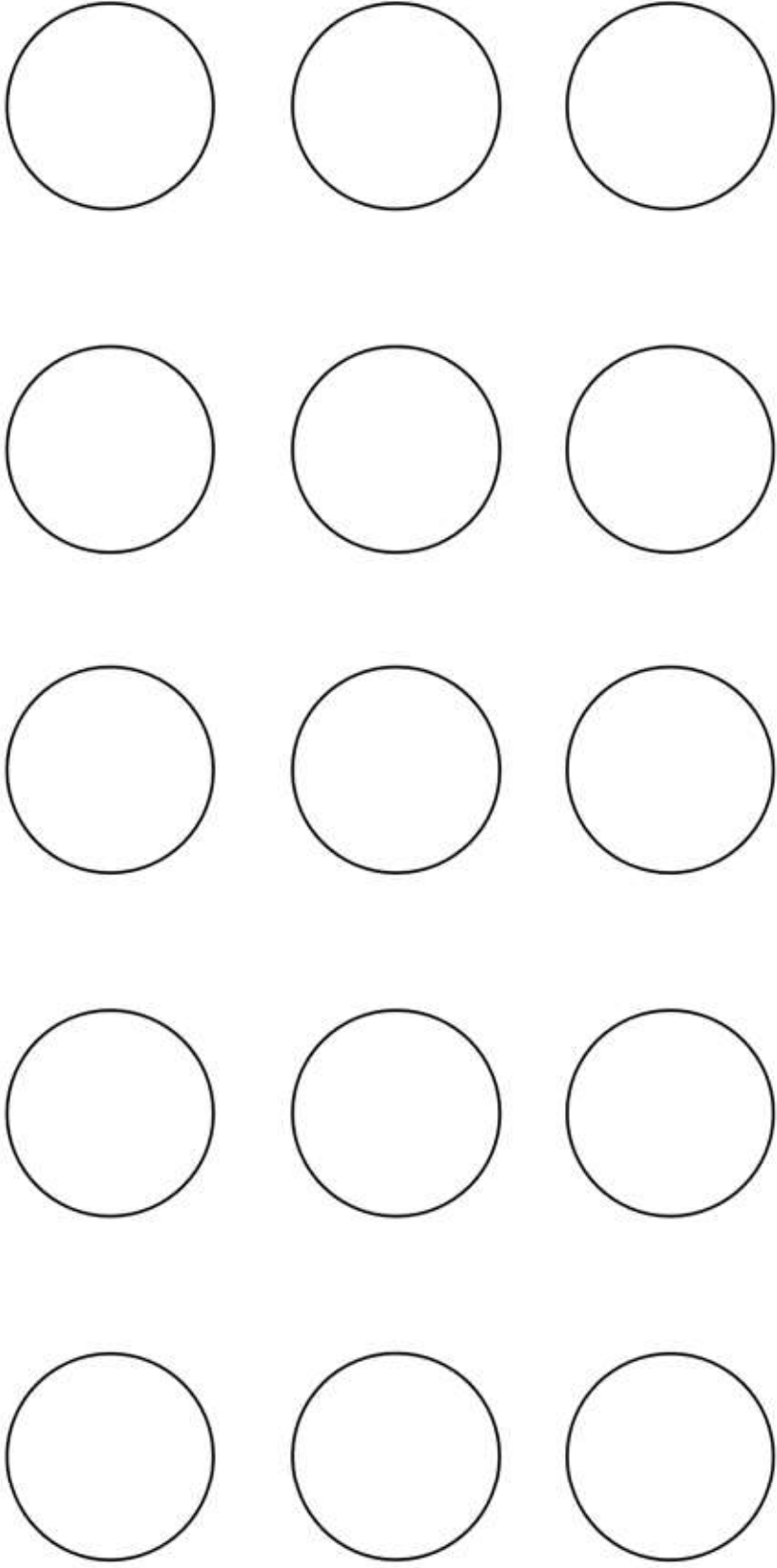

Name: _____

Date: _____

Witness: _____

Score: _____

BEAT THE CLOCK

Objective: To fire pellets into the designated hours (numbers) within a time limit.

Scoring: One point is awarded for each correct hour (number) hit by a pellet within the time allotted.

Equipment Required:

- Air rifle marksmanship equipment,
- Cadet air rifle,
- Cadet air rifle five-pellet clip (three per firing lane),
- Air rifle pellets (10 pellets per participant),
- Beat the Clock Target (one per participant),
- Target frame, and
- Stopwatch.

Activity Instructions:

1. Brief the cadets on the activity being conducted including any safety rules or other guidelines pertaining to the activity.
2. Distribute a target to each cadet.
3. Have the cadets write their name and date on the target and attach it to the target frame.
4. Give the cadets six pellets to fire, one pellet at each hour (number) as it is called.
5. Have the cadets fire, in relays, following the commands given by the RSO.
6. Have the RSO, using the clock, call out one number every 10 second for a total of six numbers.
7. Return any unused pellets to the pellet controller.
8. Have the cadets retrieve their targets.
9. Score the targets awarding one point for each correct number hit on the target.
10. Allow the cadets to review and keep their targets.

The following are prohibited:

- Alterations, other than those permitted in A-CR-CCP-177/PT-001 Part 4, Section 4, Para 5.3,
- Supports used as a rest for the rifle or the forearm,
- A spotting scope,
- Use of sights not provided with the cadet air rifle, and
- Coaching.

Note: To make this activity more difficult, shorten the time allowance.

BEAT THE CLOCK TARGET

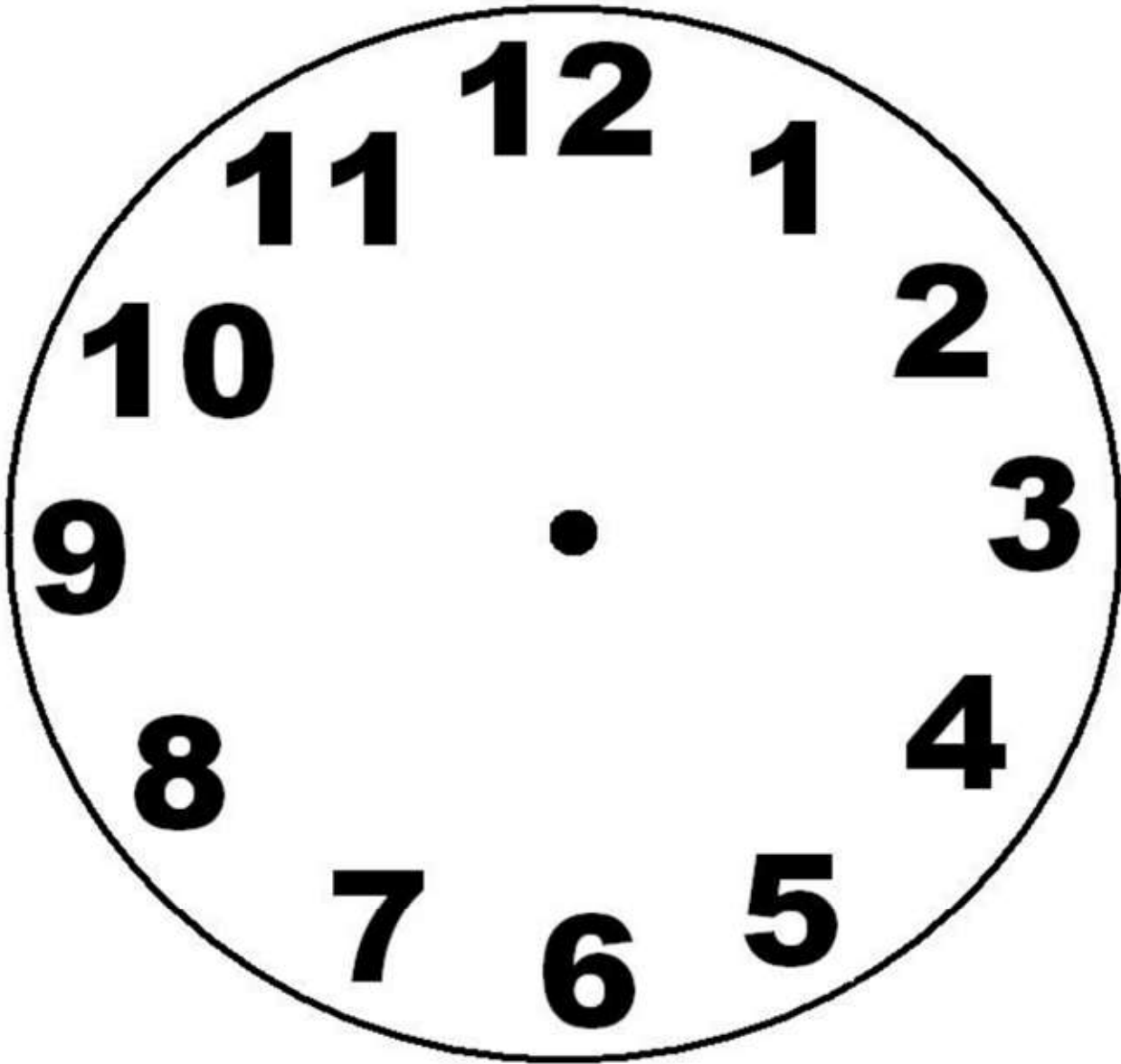

Name: _____

Date: _____

Witness: _____

Score: _____

DARTBOARD

Objective: The cadets will be given 10 pellets and 30 seconds to fire at the highest scores on the dartboard.

Scoring: Targets will be scored by totalling the value for each pellet located in each slice of the board. The bull's-eye has a value of 25 and the area around the outside with the numbers has no point value.

Equipment Required:

- Air rifle marksmanship equipment,
- Cadet air rifle,
- Air rifle pellets (10 per participant),
- Dartboard Target (one per participant),
- Target frame, and
- Stopwatch.

Activity Instructions:

1. Brief the cadets on the activity being conducted including any safety rules or other guidelines pertaining to the activity.
2. Distribute a target to each cadet.
3. Have the cadets write their name and date on the target and attach it to the target frame.
4. Give the cadets 10 pellets to fire.
5. Have the cadets fire a 30 second timed relay, in relays, following the commands given by the RSO.
6. Return unused pellets to the pellet controller.
7. Have the cadets retrieve their targets.
8. Score the targets (see above).
9. Allow the cadets to review and keep their targets.

The following are prohibited:

- Alterations, other than those permitted in A-CR-CCP-177/PT-001 Part 4, Section 4, Para 5.3,
- Supports used as a rest for the rifle or the forearm,
- A spotting scope,
- Use of sights not provided with the cadet air rifle, and
- Coaching.

Note: To make this activity more difficult, shorten the time allowance.

DARTBOARD TARGET

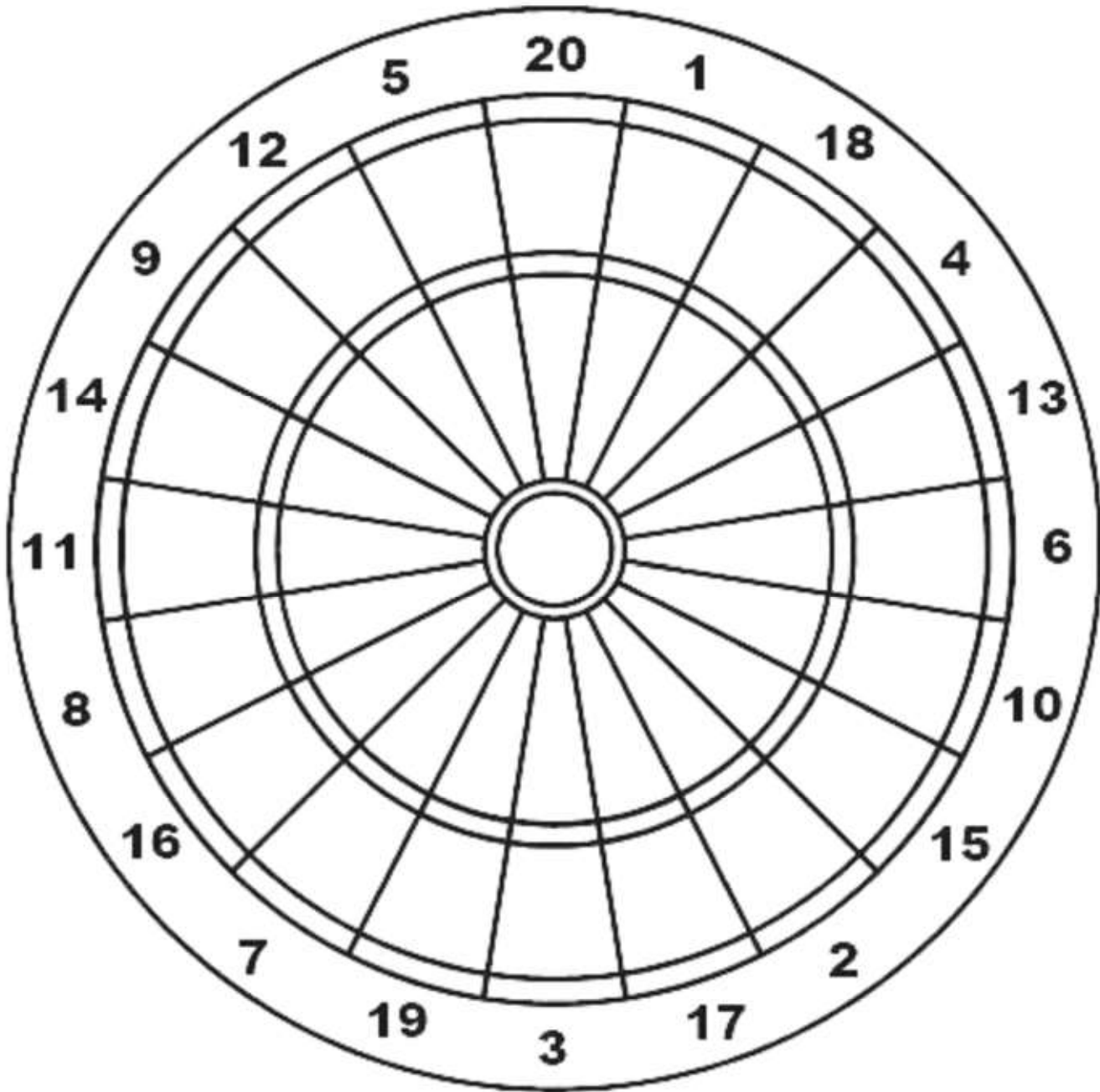

Name: _____

Date: _____

Witness: _____

Score: _____

CUT THE FUSES

Objective: The cadets will be given 10 pellets and 30 seconds to fire at the fuses of all 4 pieces of dynamite.

Scoring: The cadets must hit any portion of the fuse without hitting the dynamite; all four pieces must be hit to defuse the dynamite.

Equipment Required:

- Air rifle marksmanship equipment,
- Cadet air rifle,
- Air rifle pellets (10 per participant),
- Cut the Fuses Target (one per participant),
- Target frame, and
- Stopwatch.

Activity Instructions:

1. Brief the cadets on the activity being conducted including any safety rules or other guidelines pertaining to the activity.
2. Distribute a target to each cadet.
3. Have the cadets write their name and date on the target and attach it to the target frame.
4. Give the cadets 10 pellets to fire.
5. Have the cadets fire a 30 second timed relay, in relays, following the commands given by the RSO.
6. Return unused pellets to the pellet controller.
7. Have the cadets retrieve their targets.
8. Score the targets (see above).
9. Allow the cadets to review and keep their targets.

The following are prohibited:

- Alterations, other than those permitted in A-CR-CCP-177/PT-001 Part 4, Section 4, Para 5.3,
- Supports used as a rest for the rifle or the forearm,
- A spotting scope,
- Use of sights not provided with the cadet air rifle, and
- Coaching.

Note: To make this activity more difficult, shorten the time allowance.

CUT THE FUSES TARGET

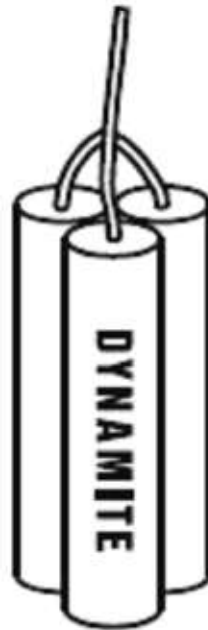
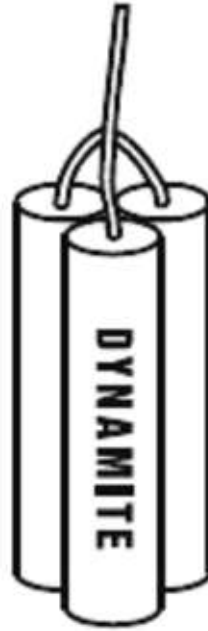

Name:

Date:

Witness:

Score:

SHOO-FLY

Objective: To provide cadets the opportunity to lead a timed air rifle marksmanship activity.

Scoring: Targets will be scored by totalling the number of flies hit. Each fly can only be hit once.

Equipment Required:

- Air rifle marksmanship equipment,
- Cadet air rifle,
- Air rifle pellets (20 per participant),
- Shoo-fly Target (one per participant),
- Target frame, and
- Stopwatch.

Activity Instructions:

1. Brief the cadets on the activity being conducted including any safety rules or other guidelines pertaining to the activity.
2. Distribute a target to each cadet.
3. Have the cadets write their name and date on the target and attach it to the target frame.
4. Give the cadets 20 pellets to fire.
5. Have the cadets fire a five minute timed relay, in relays, following the commands given by the RSO.
6. Return unused pellets to the pellet controller.
7. Have the cadets retrieve their targets.
8. Score the targets (see above).
9. Allow the cadets to review and keep their targets.

The following are prohibited:

- Alterations, other than those permitted in A-CR-CCP-177/PT-001 Part 4, Section 4, Para 5.3,
- Supports used as a rest for the rifle or the forearm,
- A spotting scope,
- Use of sights not provided with the cadet air rifle, and
- Coaching.

Note: To make this activity more difficult, shorten the time allowance.

SHOO-FLY TARGET

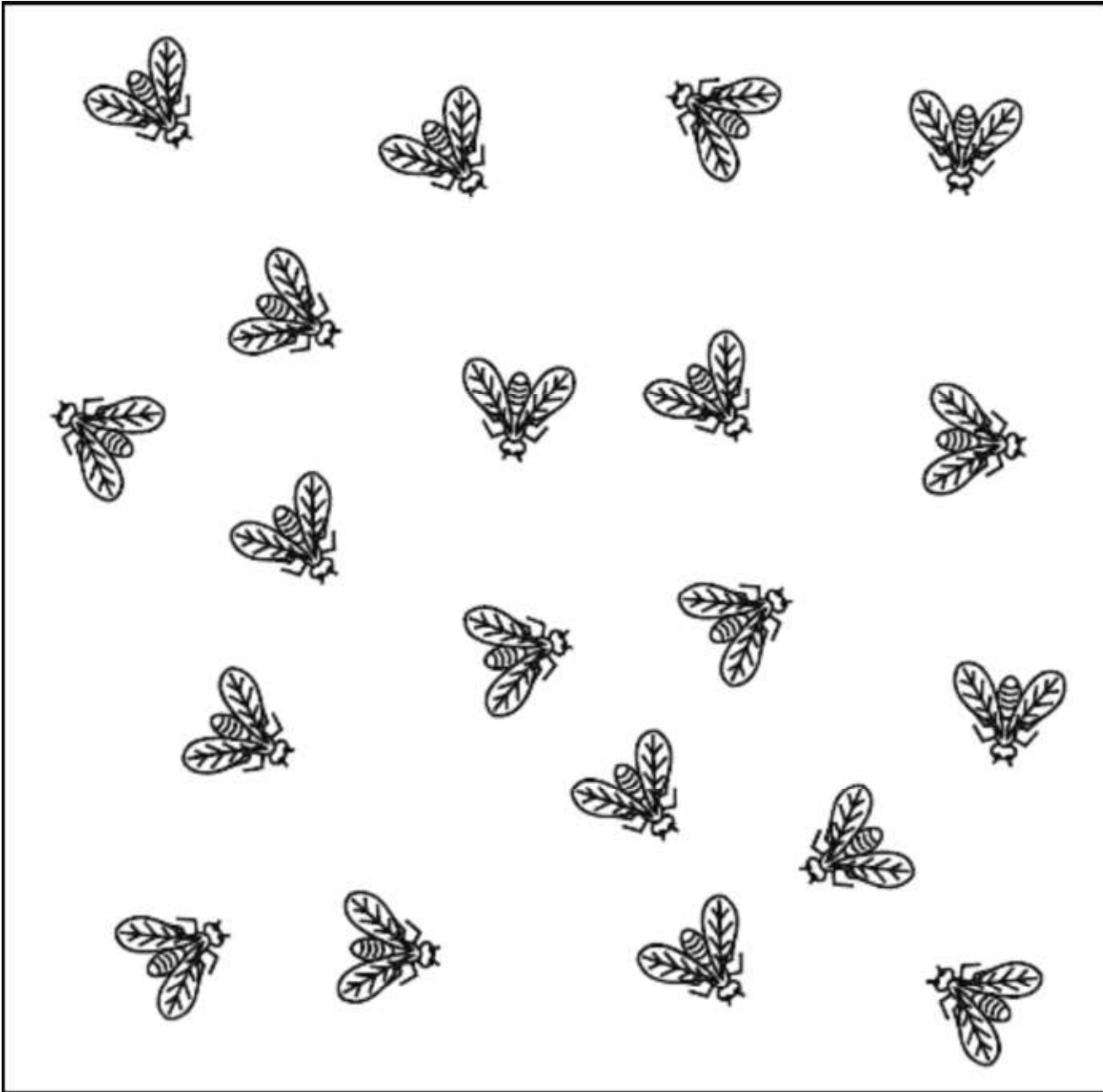

Name: _____

Date: _____

Witness: _____

Score: _____

GOOD BREAK

Objective: To provide cadets the opportunity to lead a timed air rifle marksmanship activity.

Scoring: Targets will be scored by totalling the value for each billiard ball where the centre circle has a pellet hole located in it; additional pellets will be scored as zero.

Equipment Required:

- Air rifle marksmanship equipment,
- Cadet air rifle,
- Air rifle pellets (10 per participant),
- Good Break Target (one per participant),
- Good Break scoresheet,
- Target frame, and
- Stopwatch.

Activity Instructions:

1. Brief the cadets on the activity being conducted including any safety rules or other guidelines pertaining to the activity.
2. Distribute a target to each cadet.
3. Have the cadets write their name and date on the target and attach it to the target frame.
4. Give the cadets 10 pellets to fire.
5. Have the cadets fire a five minute timed relay, in relays, following the commands given by the RSO.
6. Return unused pellets to the pellet controller.
7. Have the cadets retrieve their targets.
8. Score the targets (see above).
9. Allow the cadets to review and keep their targets.

The following are prohibited:

- Alterations, other than those permitted in A-CR-CCP-177/PT-001 Part 4, Section 4, Para 5.3,
- Supports used as a rest for the rifle or the forearm,
- A spotting scope,
- Use of sights not provided with the cadet air rifle, and
- Coaching.

GOOD BREAK TARGET

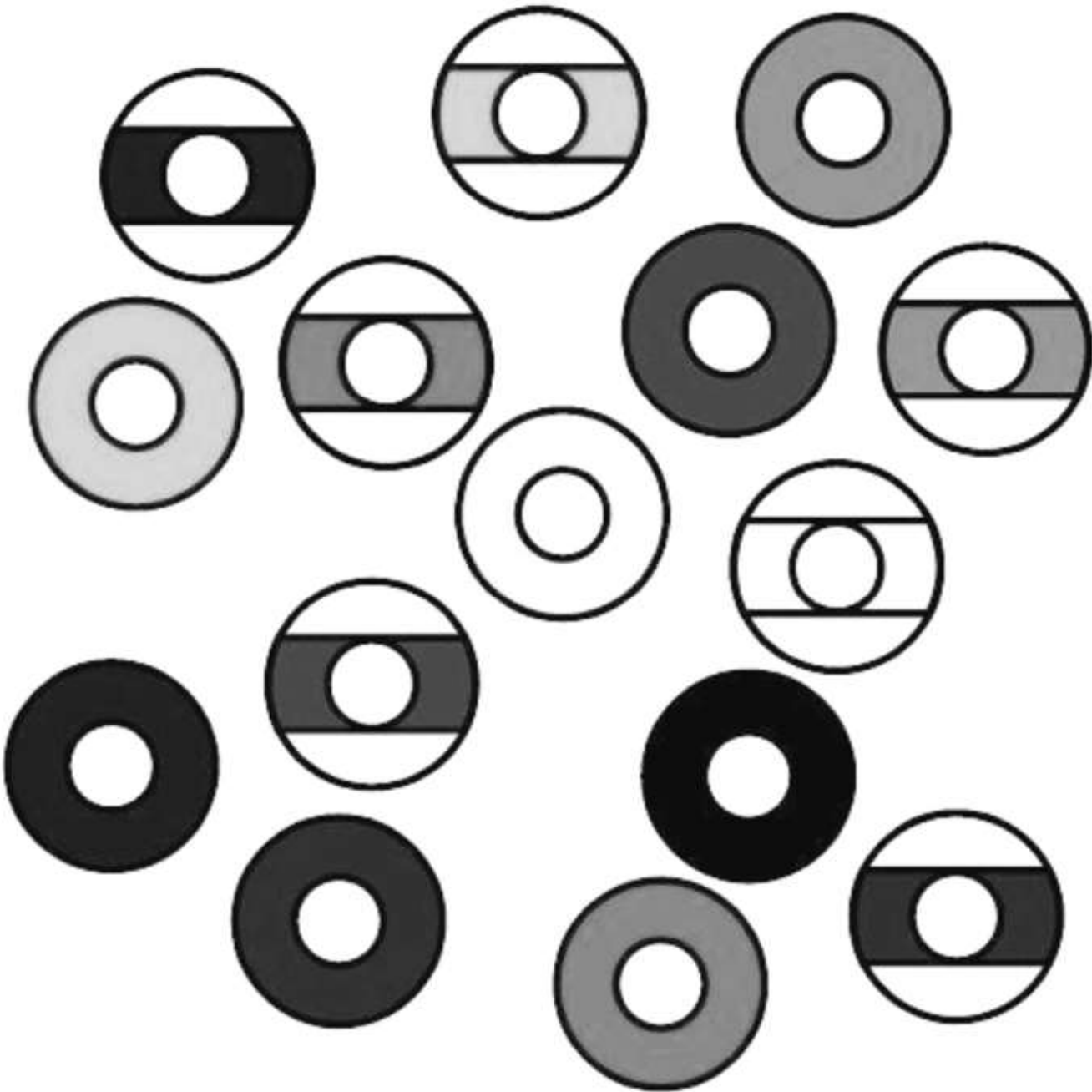

Name: _____

Date: _____

Witness: _____

Score: _____

GOOD BREAK SCORESHEET

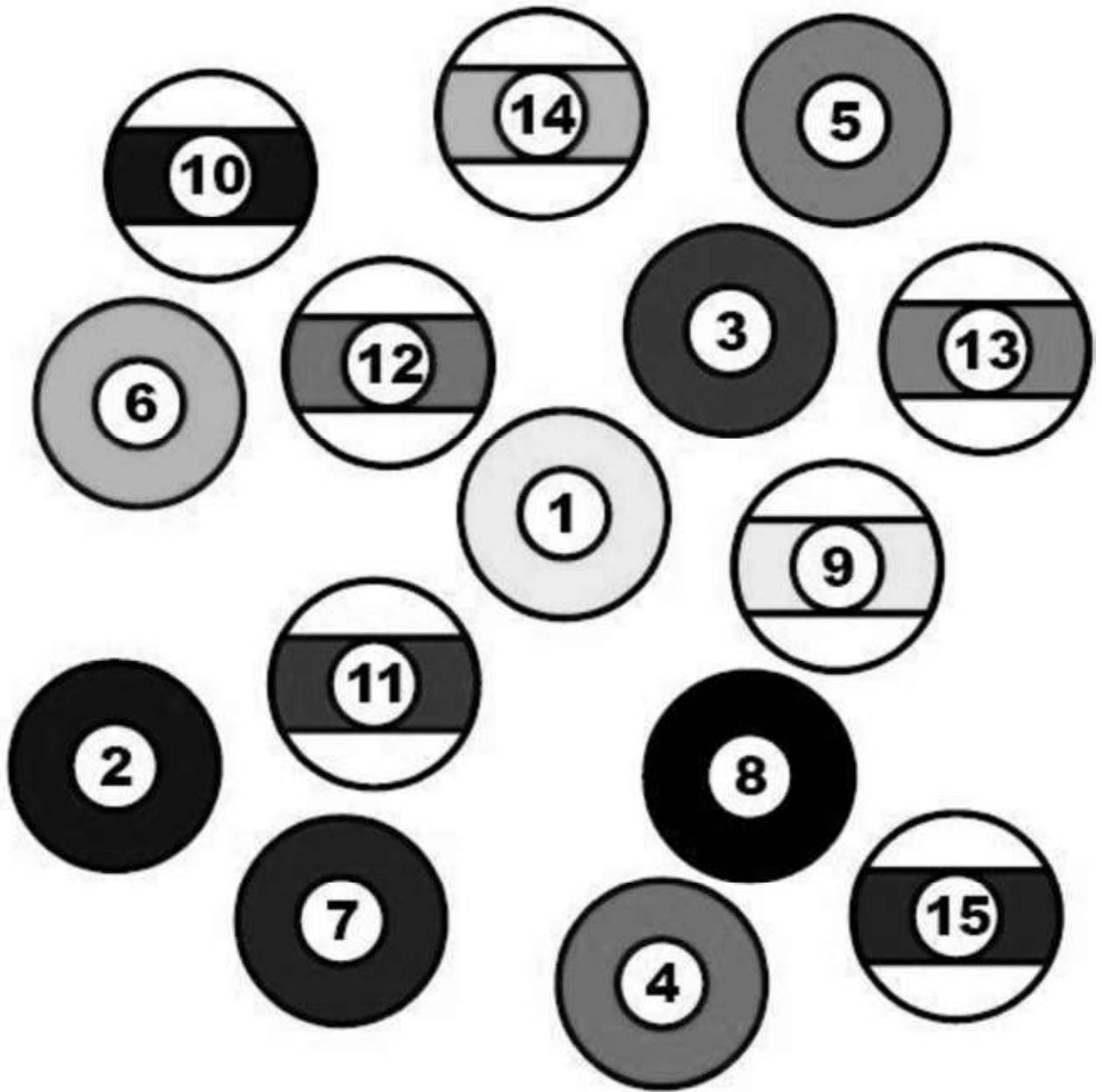

THIS PAGE INTENTIONALLY LEFT BLANK

SIMULATED STAGE 1 CHAMPIONSHIP

Objective: To provide cadets the opportunity to compete in a simulated CCMCS Stage 1 Championship (Match 1.1), intended for team selection by:

- competing as an individual against each other;
- firing at a distance of 10 m;
- firing in the prone unsupported position;
- firing one target per relay;
- loading single pellets only; and
- coaching on the firing line as permitted.

Note: This activity shall be conducted IAW Part 4, Section 3 of A-CR-CCP-177/PT-001, *Canadian Cadet Movement: Cadet Marksmanship Program Reference Manual*.

Scoring: Targets will be scored IAW A-CR-CCP-177/PT-001 *Canadian Cadet Movement: Cadet Marksmanship Program Reference Manual*, to include:

- Each CCM Competition Target has a highest possible score of 100 points (10 diagrams worth 10 points each).
- All pellet holes are scored using the highest value of the scoring ring that it is broken.
- Pellet holes outside the scoring rings are given a value of zero.
- If more than one pellet is fired on a diagram, the pellet hole with the highest value will be discarded until one pellet hole remains on the diagram. A two-point penalty will be applied for each excess pellet hole.
- Only the prescribed number of pellet holes may be fired at each diagram (eg, if two shots were fired at the first diagram, one diagram on the target would remain blank [free of pellet holes]).

Equipment Required:

- Air rifle marksmanship equipment,
- Cadet air rifle,
- Air rifle pellets (10 pellets),
- CCT2001AR853 (CCM Competition Target),
- .177- / .22-scoring magnifier (scoring magnifier),
- Scoring plug,
- Scoring template,
- Target frame,
- Stopwatch.

Optional aids to firing are limited to the following:

- Cadet air rifle sling,
- Marksmanship jacket,
- Marksmanship glove, and
- Hat.

Activity Instructions:

1. Brief the cadets on the activity being conducted including any safety rules or other guidelines pertaining to the activity.
2. Distribute the CCM Competition Target to each cadet.
3. Have the cadets write their name and date on the target and attach it to the target frame.
4. Give the cadets 10 pellets to fire.
5. Have the cadets fire, in relays, following the commands given by the RSO.
6. Give the cadets 15 minutes to complete firing.
7. Have the cadets retrieve their targets.
8. Score the targets using a scoring magnifier and / or scoring template.
9. Allow the cadets to review and keep their targets.

The following are prohibited:

- Alterations, other than those permitted in A-CR-CCP-177/PT-001 Part 4, Section 4, Para 5.3,
- Supports used as a rest for the rifle or the forearm,
- A spotting scope,
- Use of sights not provided with the cadet air rifle, and
- Coaching.

SIMULATED STAGE 2 CHAMPIONSHIP

Objective: To provide cadets the opportunity to compete in a simulated CCMCS Stage 2 Championship (Match 1.2 A), intended for team competition by:

- competing as a team of five competitors;
- firing at a distance of 10 m;
- firing in the prone unsupported position;
- firing two targets per relay;
- firing two relays;
- loading single pellets only; and
- coaching on the firing line as permitted.

Note: This activity shall be conducted IAW Part 4, Section 3 of A-CR-CCP-177/PT-001, *Canadian Cadet Movement: Cadet Marksmanship Program Reference Manual*.

Scoring: Targets will be scored IAW A-CR-CCP-177/PT-001, *Canadian Cadet Movement: Cadet Marksmanship Program Reference Manual*, to include:

- Each member has a highest possible score of 400 points (40 diagrams worth 10 points each).
- The top four competitors will be counted towards the team's highest possible score of 1600 points.
- All shot holes are scored using the highest value of the scoring ring that it is broken.
- Shots outside the scoring rings are given a value of zero.
- If more than the one pellet is fired on a diagram, the shots with the highest value will be discarded until one shot remains on the diagram. A two-point penalty will be applied for each excess shot.
- Only the prescribed number of shots may be fired at each diagram (eg, if two shots were fired at the first diagram, one diagram on the target would remain blank [free of shots]).

Equipment Required:

- Air rifle marksmanship equipment,
- Cadet air rifle,
- Air rifle pellets (40 pellets),
- CCT2001AR853 (air rifle competition target),
- .177- / .22-scoring magnifier (scoring magnifier),
- Scoring plug,
- Scoring template,
- Target frame, and
- Stopwatch.

Activity Instructions:

1. Brief the cadets on the activity being conducted including any safety rules or other guidelines pertaining to the activity.
2. Distribute two CCM Competition Targets to each cadet.
3. Have the cadets write their name and date on the targets and attach them to the target frame.
4. Give the cadets 20 pellets to fire.
5. Have the cadets fire, in relays, following the commands given by the RSO.
6. Give the cadets 30 minutes to complete firing.
7. Have the cadets retrieve their targets.
8. Score the targets using a scoring magnifier and / or scoring template.
9. Allow the cadets to review and keep their targets.
10. Repeat steps 2 to 9.

The following are prohibited:

- Alterations, other than those permitted in A-CR-CCP-177/PT-001 Part 4, Section 4, Para 5.3,
- Supports used as a rest for the rifle or the forearm,
- A spotting scope,
- Use of sights not provided with the cadet air rifle, and
- Coaching.



**COMMON TRAINING
GREEN STAR
INSTRUCTIONAL GUIDE**



SECTION 7

EO C106.02 – CLEAN AND STORE THE CADET AIR RIFLE

Total Time:

30 min

PREPARATION

PRE-LESSON INSTRUCTIONS

Resources needed for the delivery of this lesson are listed in the lesson specification located in A-CR-CCP-701/PG-001, *Green Star Qualification Standard and Plan*, Chapter 4. Specific uses for said resources are identified throughout the instructional guide within the TP for which they are required.

Prior to instructing this lesson the instructor shall:

- review the lesson content, and become familiar with the material; and
- prepare a mock air rifle range to be used in the conduct of the lesson.

PRE-LESSON ASSIGNMENT

Nil.

APPROACH

This lesson will be presented using the demonstration and performance method. The demonstration and performance method was chosen to allow cadets to participate in supervised exploration of practical instructional material. This method provides the instructor the opportunity to introduce the subject matter, demonstrate and explain procedures, and supervise the cadets while they imitate the skill. This method appeals to all learning styles.

INTRODUCTION

REVIEW

Nil.

OBJECTIVES

By the end of this lesson the cadet shall be expected to clean and store the cadet air rifle during a range practice.

IMPORTANCE

Many inaccuracy complaints can be traced back to a dirty bore. Therefore, air rifles must be cleaned and maintained on a regular basis in order to ensure proper operation and sustained accuracy.

Teaching Point 1**Explain and demonstrate the procedure for cleaning the cadet air rifle.**

Time: 15 min

Method: Demonstration and Performance

THE IMPORTANCE OF CLEANING THE AIR RIFLE

No one should attempt to clean a rifle until individual safety precautions have been performed on the rifle, and it is certain that the barrel is clear of any obstructions.

It is important to keep the air rifle clean because a dirty bore will eventually cause accuracy problems. Although air rifles do not suffer from powder deposits as do small bore and large bore rifles, they do experience a build-up of residue in the barrel.

WHEN TO CLEAN THE AIR RIFLE

There are four main times to clean the cadet air rifle:

1. Before firing.
2. After firing.
3. Periodically.
4. Before storage.



Cadets will not actually be cleaning the air rifle during this period of instruction. This may be done after participating in a range practice.

CLEANING PROCEDURE FOR THE AIR RIFLE

When	Action
Before firing	Fire two to three felt cleaning pellets.
After firing	Fire two to three felt cleaning pellets.
Periodically	<ol style="list-style-type: none"> 1. Fire a felt cleaning pellet soaked in SAE 30 motor oil. 2. Wait five minutes. 3. Fire three felt cleaning pellets.
Before storage of three months or more.	<ol style="list-style-type: none"> 1. Fire two to three felt cleaning pellets. 2. Fire one felt cleaning pellet soaked in SAE 30 motor oil. 3. Fire three felt cleaning pellets when taking rifle out of storage.

CONFIRMATION OF TEACHING POINT 1

QUESTIONS

- Q1. What must be done before attempting to clean an air rifle?
- Q2. When are the four times an air rifle must be cleaned?
- Q3. How many felt cleaning pellets are fired before participating in a range practice?

ANTICIPATED ANSWERS

- A1. Individual safety precautions.
- A2. Before firing, after firing, periodically, and before storage for three months or more.
- A3. Two to three cleaning pellets will be fired before participating in a range practice.

Teaching Point 2**Explain and demonstrate the sequence for storing the air rifle.**

Time: 10 min

Method: Demonstration and Performance

STORING THE AIR RIFLE IN THE CASE

The sequence for storing the cadet air rifle is the reverse order of the procedure for removing the air rifle from the case:

- 1. Ensure the open case is pointed in a safe direction.
- 2. Close the action (bolt forward and closed).
- 3. Slide safety rod out of the barrel.
- 4. Place the rifle in the case in the direction of the arrow on the case.
- 5. Confirm pumping lever is partially open.
- 6. Confirm the safety catch is ON.
- 7. Close the case.

CONFIRMATION OF TEACHING POINT 2

QUESTIONS

- Q1. What position is the bolt in for storage?
- Q2. What direction is the rifle placed in the case?
- Q3. What position is the safety catch placed in for storage?

ANTICIPATED ANSWERS

- A1. Forward and closed.
- A2. In the direction of the arrow on the case.
- A3. ON, with no red showing.

END OF LESSON CONFIRMATION

QUESTIONS

- Q1. What must be done before anyone should attempt to clean an air rifle?
- Q2. What types of problems can be caused by a dirty bore?
- Q3. Before storage cleaning is done when a rifle will be stored for how long?

ANTICIPATED ANSWERS

- A1. They perform individual safety precautions.
- A2. It is important to keep the air rifle clean because a dirty bore will eventually cause accuracy problems.
- A3. Three months or more.

CONCLUSION

HOMEWORK/READING/PRACTICE

Nil.

METHOD OF EVALUATION

The instructor will confirm cadets' ability to clean and store the cadet air rifle at the end of a range practice.

CLOSING STATEMENT

A dirty air rifle and bore will cause accuracy and operation problems. Therefore, air rifles must be cleaned and maintained on a regular basis in order to ensure proper operation and sustained accuracy.

INSTRUCTOR NOTES/REMARKS

Emphasis must be placed on the safety aspects of this lesson.

REFERENCES

A0-027 A-CR-CCP-177/PT-001 D Cdts 3. (2001). *Canadian Cadet Movement: Cadet Marksmanship Programme Reference Manual*. Ottawa, ON: Department of National Defence.