



ROYAL CANADIAN SEA CADETS

BOOK 1 OF 2

PHASE THREE INSTRUCTIONAL GUIDES

(ENGLISH)

(Supersedes A-CR-CCP-603/PF-001 dated 2015-12-01)

Cette publication est disponible en français sous le numéro A-CR-CCP-603/PF-002.

Issued on Authority of the Chief of the Defence Staff

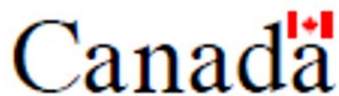



NOTICE

This documentation has been reviewed by the technical authority and does not contain controlled goods. Disclosure notices and handling instructions originally received with the document shall continue to apply.

AVIS

Cette documentation a été révisée par l'autorité technique et ne contient pas de marchandises contrôlées. Les avis de divulgation et les instructions de manutention reçues originalement doivent continuer de s'appliquer.

ROYAL CANADIAN SEA CADETS

BOOK 1 OF 2

PHASE THREE INSTRUCTIONAL GUIDES

(ENGLISH)

(Supersedes A-CR-CCP-603/PF-001 dated 2015-12-01)

Cette publication est disponible en français sous le numéro A-CR-CCP-603/PF-002.

Issued on Authority of the Chief of the Defence Staff

LIST OF EFFECTIVE PAGES

Insert latest changed pages; dispose of superseded pages in accordance with applicable orders.

NOTE

On a changed page, the portion of the text affected by the latest change is indicated by a vertical line in the margin of the page. Changes to illustrations by miniature pointing hands, or black vertical lines.

Dates of issue for original and changed pages are:

Original	0	2016-08-24	Change	3
Change	1		Change	4
Change	2		Change	5

Zero in Change No. column indicates an original page. Total number of pages in this publication is 846, consisting of the following:

Page No.	Change No.	Page No.	Change No.
BOOK 1			
Cover page	0	3O-1 to 3O-48	0
Title	0	3P-1 to 3P-54	0
A to C	0	3Q-1 to 3Q-2	0
i to xviii	0	3R-1 to 3R-2	0
1-X01-1/2	0	3S-1 to 3S-2	0
1-X01-1 to 1-X01-2	0	4-X04-1/2	0
2-X02-1/2	0	4-X04-1 to 4-X04-2	0
2-X02-1 to 2-X02-2	0	5-X05-1/2	0
3-303-1/2	0	5-X05-1 to 5-X05-2	0
3-M303.01-1 to 3-M303.01-12.....	0	6-306-1/2	0
3-M303.02-1 to 3-M303.02-6.....	0	6-M306.01-1 to 6-M306.01-6.....	0
3-M303.03-1 to 3-M303.03-6.....	0	6-C306.01-1 to 6-C306.01-8.....	0
3-M303.04-1 to 3-M303.04-12.....	0	6-C306.02-1 to 6-C306.02-8.....	0
3-M303.05-1 to 3-M303.05-8.....	0	6-C306.03-1 to 6-C306.03-14.....	0
3-M303.06-1 to 3-M303.06-6.....	0	6A-1 to 6A-2	0
3-M303.07-1 to 3-M303.07-14.....	0	6B-1 to 6B-2	0
3-C303.01-1 to 3-C303.01-14.....	0	6C-1 to 6C-2	0
3-C303.02-1 to 3-C303.02-4.....	0	6D-1 to 6D-2	0
3A-1 to 3A-2	0	6E-1 to 6E-2	0
3B-1 to 3B-2	0	6F-1 to 6F-2	0
3C-1 to 3C-2	0	6G-1 to 6G-2	0
3D-1 to 3D-2	0	6H-1 to 6H-2	0
3E-1 to 3E-4	0	6I-1 to 6I-2	0
3F-1 to 3F-4	0	6J-1 to 6J-2	0
3G-1 to 3G-2	0	6K-1 to 6K-2	0
3H-1 to 3H-2	0	6L-1 to 6L-2	0
3I-1 to 3I-2	0	6M-1 to 6M-2	0
3J-1 to 3J-50	0	7-307-1/2	0
3K-1 to 3K-8	0	7-M307.01-1 to 7-M307.01-12.....	0
3L-1 to 3L-24	0	7-M307.02-1 to 7-M307.02-6.....	0
3M-1 to 3M-2	0	7-M307.03-1 to 7-M307.03-8.....	0
3N-1 to 3N-10	0	7-C307.04-1 to 7-C307.04-10.....	0
		7A-1 to 7A-6	0

LIST OF EFFECTIVE PAGES (CONT)

Page No.	Change No.	Page No.	Change No.
12O-1 to 12O-12	0	14J-1 to 14J-2	0
12P-1 to 12P-2	0	14K-1 to 14K-2	0
13-322-1/2	0	14L-1 to 14L-2	0
13-322-1 to 13-322-2	0	14M-1 to 14M-2	0
14-323-1/2	0	15-X24-1/2	0
14-M323.01-1 to 14-M323.01-8	0	15-X24-1 to 15-X24-2	0
14-C323.01-1 to 14-C323.01-16	0	16-X25-1/2	0
14-C323.02-1 to 14-C323.02-4	0	16-X25-1 to 16-X25-2	0
14-C323.03-1 to 14-C323.03-6	0	17-1/2	0
14A-1 to 14A-2	0	17-1 to 17-20	0
14B-1 to 14B-2	0	17A-1 to 17A-10	0
14C-1 to 14C-2	0	17B-1 to 17B-6	0
14D-1 to 14D-2	0	17C-1 to 17C-2	0
14E-1 to 14E-2	0	17D-1 to 17D-4	0
14F-1 to 14F-2	0	17E-1 to 17E-6	0
14G-1 to 14G-2	0	17F-1 to 17F-2	0
14H-1 to 14H-2	0	17G-1 to 17G-2	0
14I-1 to 14I-6	0		

FOREWORD AND PREFACE

1. **Issuing Authority.** This Instructional Guide (IG) A-CR-CCP-603/PF-001 was developed under the authority of the Director Cadets and Junior Canadian Rangers, and issued on the authority of the Chief of Defence Staff.
2. **Development.** Development of this IG was in accordance with the performance oriented concept of training outlined in the A-P9-050 Series, Canadian Forces Individual Training and Education System, with modifications to meet the needs of the Cadet Organization.
3. **Purpose of the IG.** The IG to be used by Royal Canadian Sea Cadet Corps in conjunction with other resources to conduct Phase Three training. The IG provides instructors with the base means from which to deliver training. Individual IGs are to be reviewed in conjunction with the Lesson Specifications (LSs) found in A-CR-CCP-603/PG-001, *Royal Canadian Sea Cadets Phase Three Qualification Standard and Plan*, Chapter 4, before instructing, so that each instructor can adequately plan for and prepare each lesson. Instructors may be required to develop instructional materials to support training in addition to any that may be provided, e.g., posters, videos, handouts, models, etc., supplemental to training control and support documents. Suggested instructional activities are included in most IGs to maximize learning and fun. Instructors are also encouraged to modify and/or enhance the activities, as long as they continue to contribute to enabling objective achievement.
4. **Use of the IG.** Throughout these instructional guides, a series of information boxes are used to highlight information; they include:



Note to the Instructor.



Key information to pass along to cadets.



Refer to the following CF regulations and policies.



Points of interest or special instructions the instructor should pass along to cadets.

5. **Suggested Changes.** Suggested changes to this document may be sent directly to cadettraining@canada.ca.

THIS PAGE INTENTIONALLY LEFT BLANK

TABLE OF CONTENTS

PAGE

BOOK 1

CHAPTER 1	PO X01 – PARTICIPATE IN CITIZENSHIP ACTIVITIES	1-X01-1/2
CHAPTER 2	PO X02 – PERFORM COMMUNITY SERVICE	2-X02-1/2
CHAPTER 3	PO 303 – PERFORM THE ROLE OF A TEAM LEADER	3-303-1/2
Section 1	EO M303.01 – DEFINE THE ROLE OF A TEAM LEADER.....	3-M303.01-1
Section 2	EO M303.02 – PARTICIPATE IN A MENTORING RELATIONSHIP.....	3-M303.02-1
Section 3	EO M303.03 – PRACTICE SELF-ASSESSMENT.....	3-M303.03-1
Section 4	EO M303.04 – COMMUNICATE AS A TEAM LEADER.....	3-M303.04-1
Section 5	EO M303.05 – SUPERVISE CADETS.....	3-M303.05-1
Section 6	EO M303.06 – SOLVE PROBLEMS.....	3-M303.06-1
Section 7	EO M303.07 – LEAD CADETS THROUGH A LEADERSHIP ASSIGNMENT.....	3-M303.07-1
Section 8	EO C303.01 – LEAD A TEAM-BUILDING ACTIVITY.....	3-C303.01-1
Section 9	EO C303.02 – DELIVER A PRESENTATION ABOUT A LEADER.....	3-C303.02-1
Annex A	LEADERSHIP TEAM MODEL.....	3A-1
Annex B	EXPECTATIONS OF A PHASE THREE CADET.....	3B-1
Annex C	SELF-ASSESSMENT RUBRICS.....	3C-1
Annex D	COMMUNICATION PUZZLE.....	3D-1
Annex E	PROBLEM-SOLVING SCENARIOS.....	3E-1
Annex F	POSSIBLE YEAR THREE COMMON LEADERSHIP ASSIGNMENTS.....	3F-1
Annex G	SAMPLE LEADERSHIP ASSIGNMENT.....	3G-1
Annex H	LEADERSHIP ASSIGNMENT FORMAT.....	3H-1
Annex I	AFTER-ASSIGNMENT REPORT AND ASSESSMENT RUBRIC.....	3I-1
Annex J	LEADERSHIP ASSIGNMENTS.....	3J-1
Annex K	SAMPLE STRETCHES.....	3K-1
Annex L	LEADERSHIP ASSIGNMENTS.....	3L-1
Annex M	LEADERSHIP ASSIGNMENT PLANNING GUIDE.....	3M-1
Annex N	LESSON ACTIVITIES.....	3N-1
Annex O	ENERGIZERS AND ICEBREAKERS ACTIVITIES.....	3O-1
Annex P	COMMUNICATION, PROBLEM-SOLVING AND TRUST-BUILDING ACTIVITIES.....	3P-1
Annex Q	TEAM-BUILDING PLANNING GUIDE.....	3Q-1
Annex R	SELF-ASSESSMENT FORM – LEAD A TEAM-BUILDING ACTIVITY.....	3R-1
Annex S	OUTLINE FOR DELIVERING A PRESENTATION ABOUT A LEADER.....	3S-1

TABLE OF CONTENTS (Cont)

		PAGE
CHAPTER 4	PO X04 – TRACK PARTICIPATION IN PHYSICAL ACTIVITIES	4-X04-1/2
CHAPTER 5	PO X05 – PARTICIPATE IN PHYSICAL ACTIVITIES	5-X05-1/2
CHAPTER 6	PO 306 – FIRE THE CADET AIR RIFLE DURING RECREATIONAL MARKSMANSHIP	6-306-1/2
Section 1	EO M306.01 – PARTICIPATE IN A RECREATIONAL MARKSMANSHIP ACTIVITY.....	6-M306.01-1
Section 2	EO C306.01 – IDENTIFY CIVILIAN MARKSMANSHIP ORGANIZATIONS..	6-C306.01-1
Section 3	EO C306.02 – CORRECT MARKSMANSHIP ERROR.....	6-C306.02-1
Section 4	EO C306.03 – ADOPT THE STANDING POSITION WITH THE CADET AIR RIFLE.....	6-C306.03-1
Annex A	CLASSIFICATION ACTIVITY.....	6A-1
Annex B	FUN ACTIVITY – PYRAMID.....	6B-1
Annex C	FUN ACTIVITY – SHOOTING STAR.....	6C-1
Annex D	FUN ACTIVITY – BEACH BALL.....	6D-1
Annex E	FUN ACTIVITY – BALLOONS.....	6E-1
Annex F	TIMED ACTIVITY – CHASE THE DOTS.....	6F-1
Annex G	TIMED ACTIVITY – SPEED GRID.....	6G-1
Annex H	TIMED ACTIVITY – BEAT THE CLOCK.....	6H-1
Annex I	COMPETITIVE ACTIVITY – CORPS/SQUADRON MARKSMANSHIP COMPETITION.....	6I-1
Annex J	COMPETITIVE ACTIVITY – LUNAR LAUNCH.....	6J-1
Annex K	MPI EXAMPLES.....	6K-1
Annex L	SIGHT ADJUSTMENT ACTIVITY.....	6L-1
Annex M	SIGHT ADJUSTMENT ACTIVITY – ANSWER KEY.....	6M-1
CHAPTER 7	PO 307 – SERVE IN A SEA CADET CORPS	7-307-1/2
Section 1	EO M307.01 – IDENTIFY PHASE THREE TRAINING OPPORTUNITIES....	7-M307.01-1
Section 2	EO M307.02 – IDENTIFY YEAR THREE CSTC TRAINING OPPORTUNITIES.....	7-M307.02-1
Section 3	EO M307.03 – RECOGNIZE THE PARTNERSHIP BETWEEN THE NAVY LEAGUE OF CANADA (NLC) AND THE DEPARTMENT OF NATIONAL DEFENCE (DND) IN SUPPORT OF THE CANADIAN CADET MOVEMENT (CCM).....	7-M307.03-1
Section 4	EO C307.04 – PARTICIPATE IN A PRESENTATION ON THE DUKE OF EDINBURGH AWARD PROGRAM.....	7-C307.04-1
Annex A	PHASE THREE POs AND EOs.....	7A-1
Annex B	RESPONSIBILITIES CARDS	7B-1
CHAPTER 8	PO 308 – DIRECT A SQUAD PRIOR TO A PARADE	8-308-1/2
Section 1	EO M308.01 – PREPARE A SQUAD FOR PARADE.....	8-M308.01-1

TABLE OF CONTENTS (Cont)

		PAGE
Section 2	EO M308.02 – DELIVER WORDS OF COMMAND.....	8-M308.02-1
Section 3	EO C308.01 – EXECUTE FLAG DRILL.....	8-C308.01-1
Section 4	EO C308.02 – DELIVER WORDS OF COMMAND.....	8-C308.02-1
Annex A	DRILL SEQUENCE HANDOUT (PREPARING A SQUAD FOR PARADE)...	8A-1
Annex B	AIDE-MÉMOIRE CARD.....	8B-1
CHAPTER 9	PO 309 – INSTRUCT A LESSON	9-309-1/2
Section 1	EO M309.01 – EXPLAIN THE PRINCIPLES OF INSTRUCTION.....	9-M309.01-1
Section 2	EO M309.02 – IDENTIFY METHODS OF INSTRUCTION.....	9-M309.02-1
Section 3	EO M309.03 – DESCRIBE EFFECTIVE-SPEAKING TECHNIQUES.....	9-M309.03-1
Section 4	EO M309.04 – DESCRIBE QUESTIONING TECHNIQUES.....	9-M309.04-1
Section 5	EO M309.05 – SELECT APPROPRIATE INSTRUCTIONAL AIDS.....	9-M309.05-1
Section 6	EO M309.06 – PLAN A LESSON.....	9-M309.06-1
Section 7	EO M309.07 – INSTRUCT A 15-MINUTE LESSON.....	9-M309.07-1
Section 8	EO C309.01 – DELIVER A ONE-MINUTE VERBAL PRESENTATION.....	9-C309.01-1
Section 9	EO C309.04 – IDENTIFY FORMATIONS FOR DRILL INSTRUCTION.....	9-C309.04-1
Section 10	EO C309.05 – PLAN A DRILL LESSON.....	9-C309.05-1
Section 11	EO C309.06 – INSTRUCT A 15-MINUTE DRILL LESSON.....	9-C309.06-1
Annex A	PRINCIPLES OF INSTRUCTION INFORMATION SHEETS.....	9A-1
Annex B	PRINCIPLES OF INSTRUCTION WORKSHEETS.....	9B-1
Annex C	METHODS OF INSTRUCTION.....	9C-1
Annex D	SELECT A METHOD OF INSTRUCTION.....	9D-1
Annex E	POSING QUESTIONS SEQUENCE.....	9E-1
Annex F	QUESTIONS HANDOUT.....	9F-1
Annex G	POSING QUESTIONS RUBRIC.....	9G-1
Annex H	POSING QUESTIONS CHECKLIST.....	9H-1
Annex I	COMMON INSTRUCTIONAL AIDS.....	9I-1
Annex J	INSTRUCTIONAL AIDS WORKSHEETS.....	9J-1
Annex K	LESSON SPECIFICATION AND INSTRUCTIONAL GUIDE HANDOUT.....	9K-1
Annex L	LESSON PLAN.....	9L-1
Annex M	PLAN A LESSON CHECKLIST.....	9M-1
Annex N	LIST OF APPROVED 15-MINUTE TOPICS.....	9N-1
Annex O	MODIFIED LESSON SPECIFICATIONS AND INSTRUCTIONAL GUIDES – TP 1 OF EO M104.01.....	9O-1
Annex P	MODIFIED LESSON SPECIFICATIONS AND INSTRUCTIONAL GUIDES – TP 1 OF EO M106.01.....	9P-1
Annex Q	MODIFIED LESSON SPECIFICATIONS AND INSTRUCTIONAL GUIDES – TP 4 OF EO M106.03.....	9Q-1

TABLE OF CONTENTS (Cont)

	PAGE
Annex R	MODIFIED LESSON SPECIFICATIONS AND INSTRUCTIONAL GUIDES – TP 1 OF EO M203.01..... 9R-1
Annex S	MODIFIED LESSON SPECIFICATIONS AND INSTRUCTIONAL GUIDES – TP 1 OF EO M121.01..... 9S-1
Annex T	MODIFIED LESSON SPECIFICATIONS AND INSTRUCTIONAL GUIDES – TP 3 OF EO M121.01..... 9T-1
Annex U	MODIFIED LESSON SPECIFICATIONS AND INSTRUCTIONAL GUIDES – TP 2 OF EO M121.03..... 9U-1
Annex V	MODIFIED LESSON SPECIFICATIONS AND INSTRUCTIONAL GUIDES – TP 1 OF EO C120.03..... 9V-1
Annex W	MODIFIED LESSON SPECIFICATIONS AND INSTRUCTIONAL GUIDES – TP 1 OF EO M220.03..... 9W-1
Annex X	MODIFIED LESSON SPECIFICATIONS AND INSTRUCTIONAL GUIDES – TP 3 OF EO M221.03..... 9X-1
Annex Y	MODIFIED LESSON SPECIFICATIONS AND INSTRUCTIONAL GUIDES – TP 2 OF EO M221.05..... 9Y-1
Annex Z	MODIFIED LESSON SPECIFICATIONS AND INSTRUCTIONAL GUIDES – TP 2 OF EO M223.02..... 9Z-1
Annex AA	MODIFIED LESSON SPECIFICATIONS AND INSTRUCTIONAL GUIDES – TP 1 OF EO M223.07..... 9AA-1
Annex AB	MODIFIED LESSON SPECIFICATIONS AND INSTRUCTIONAL GUIDES – TPs 1 AND 2 OF EO M224.02..... 9AB-1
Annex AC	MODIFIED LESSON SPECIFICATIONS AND INSTRUCTIONAL GUIDES – TP 1 OF EO C207.01..... 9AC-1
Annex AD	INSTRUCTIONAL TECHNIQUES ASSESSMENT FORM..... 9AD-1
Annex AE	LIST OF TOPICS..... 9AE-1
Annex AF	VERBAL PRESENTATION FEEDBACK FORM..... 9AF-1
Annex AG	THE LESSON PLAN..... 9AG-1
Annex AH	DRILL LESSON PLAN..... 9AH-1
Annex AI	PLAN A DRILL LESSON CHECKLIST..... 9AI-1
Annex AJ	LIST OF APPROVED 15-MINUTE DRILL TOPICS..... 9AJ-1
Annex AK	MODIFIED LESSON SPECIFICATIONS AND INSTRUCTIONAL GUIDES – EO M108.01 (MOVEMENT OF ATTENTION FROM STAND AT EASE, AND STAND AT EASE FROM ATTENTION)..... 9AK-1
Annex AL	MODIFIED LESSON SPECIFICATIONS AND INSTRUCTIONAL GUIDES – EO M108.01 (MOVEMENT OF STAND EASY FROM STAND AT EASE, AND STAND AT EASE FROM STAND EASY)..... 9AL-1
Annex AM	MODIFIED LESSON SPECIFICATIONS AND INSTRUCTIONAL GUIDES – EO M108.02 (SALUTE TO THE FRONT)..... 9AM-1
Annex AN	MODIFIED LESSON SPECIFICATIONS AND INSTRUCTIONAL GUIDES – EO M108.02 (SALUTE TO THE RIGHT [LEFT])..... 9AN-1

TABLE OF CONTENTS (Cont)

		PAGE
Annex AO	MODIFIED LESSON SPECIFICATIONS AND INSTRUCTIONAL GUIDES – EO M108.03 (RIGHT TURN AT THE HALT).....	9AO-1
Annex AP	MODIFIED LESSON SPECIFICATIONS AND INSTRUCTIONAL GUIDES – EO M108.03 (LEFT TURN AT THE HALT).....	9AP-1
Annex AQ	MODIFIED LESSON SPECIFICATIONS AND INSTRUCTIONAL GUIDES – EO M108.03 (ABOUT TURN AT THE HALT).....	9AQ-1
Annex AR	DRILL INSTRUCTIONAL TECHNIQUES ASSESSMENT FORM.....	9AR-1
CHAPTER 10	PO 311 – PARTICIPATE IN A RECREATIONAL SUMMER BIATHLON ACTIVITY	10-311-1/2
Section 1	EO C311.01 – PRACTICE AIMING AND FIRING THE CADET AIR RIFLE FOLLOWING PHYSICAL ACTIVITY.....	10-C311.01-1
Section 2	EO C311.02 – PARTICIPATE IN A RECREATIONAL SUMMER BIATHLON ACTIVITY.....	10-C311.02-1
Annex A	SAMPLE STRETCHES.....	10A-1
Annex B	GUIDELINES TO CONDUCT A RECREATIONAL SUMMER BIATHLON ACTIVITY.....	10B-1
Annex C	BIATHLON SCORESHEET.....	10C-1
Annex D	COURSE CONTROL SHEET.....	10D-1
Annex E	RANGE RECORDING SHEET.....	10E-1
BOOK 2		
CHAPTER 11	PO X20 – PARTICIPATE IN CANADIAN ARMED FORCES (CAF) FAMILIARIZATION ACTIVITIES	11-X20-1/2
CHAPTER 12	PO 321 – RIG A LIFTING DEVICE	12-321-1/2
Section 1	EO M321.01 – DESCRIBE SAFETY PROCEDURES FOR OPERATING LIFTING DEVICES.....	12-M321.01-1
Section 2	EO M321.02 – RIG SHEERS.....	12-M321.02-1
Section 3	EO C321.02 – RIG A STANDING DERRICK.....	12-C321.02-1
Section 4	EO C321.03 – RIG A GYN.....	12-C321.03-1
Section 5	EO C321.04 – MAKE A MONKEY’S FIST.....	12-C321.04-1
Section 6	EO C321.05 – MAKE A TURK’S HEAD.....	12-C321.05-1
Annex A	PARTS CARDS – SHEERS.....	12A-1
Annex B	ASSEMBLED SHEERS.....	12B-1
Annex C	SEQUENCE FOR STATION 3 – OPERATING THE SHEERS.....	12C-1
Annex D	SHEERS SCORESHEET.....	12D-1
Annex E	PARTS CARDS – STANDING DERRICK.....	12E-1
Annex F	STANDING DERRICK.....	12F-1
Annex G	SEQUENCE FOR STATION 3 – OPERATING A STANDING DERRICK.....	12G-1
Annex H	STANDING DERRICK SCORESHEET.....	12H-1

TABLE OF CONTENTS (Cont)

		PAGE
Annex I	PARTS CARDS – GYN.....	12I-1
Annex J	ASSEMBLED GYN.....	12J-1
Annex K	SEQUENCE FOR STATION 3 – OPERATING A GYN.....	12K-1
Annex L	GYN SCORESHEET.....	12L-1
Annex M	ALTERNATIVE METHOD FOR MAKING A MONKEY’S FIST.....	12M-1
Annex N	MONKEY’S FIST PATTERN.....	12N-1
Annex O	ALTERNATIVE METHOD FOR MAKING A TURK’S HEAD.....	12O-1
Annex P	TURKS HEAD PATTERN.....	12P-1
CHAPTER 13	PO 322 – ATTAIN PLEASURE CRAFT OPERATOR COMPETENCY	13-322-1/2
CHAPTER 14	PO 323 – SERVE IN A NAVAL ENVIRONMENT	14-323-1/2
Section 1	EO M323.01 – PERFORM CORPS DUTIES.....	14-M323.01-1
Section 2	EO C323.01 – COMMUNICATE USING FLAGS AND PENNANTS.....	14-C323.01-1
Section 3	EO C323.02 – PIPE WAKEY WAKEY.....	14-C323.02-1
Section 4	EO C323.03 – PIPE HANDS TO DINNER.....	14-C323.03-1
Annex A	FUNCTIONAL ORGANIZATION.....	14A-1
Annex B	DUTY PERSONNEL ORGANIZATION.....	14B-1
Annex C	TRAINING ORGANIZATIONS.....	14C-1
Annex D	QUATERMASTER TERMS OF REFERENCE.....	14D-1
Annex E	QUATERMASTER REFERENCE GUIDE.....	14E-1
Annex F	FLAG FLASH CARDS.....	14F-1
Annex G	FLAG FLASH CARDS RESULTS SHEET.....	14G-1
Annex H	SIGNAL MAST HANDOUT.....	14H-1
Annex I	SIGNAL HOIST CUE CARDS.....	14I-1
Annex J	SIGNAL HOIST RESULTS SHEET.....	14J-1
Annex K	SIGNAL HOIST ANSWER KEY.....	14K-1
Annex L	WAKEY WAKEY DIAGRAM.....	14L-1
Annex M	HANDS TO DINNER DIAGRAM.....	14M-1
CHAPTER 15	PO X24 – SAIL A SAILBOAT IN ACCORDANCE WITH SAIL CANADA CANSAIL LEVEL 1	15-X24-1/2
CHAPTER 16	PO X25 – PARTICIPATE IN A NAUTICAL TRAINING WEEKEND	16-X25-1/2
CHAPTER 17	SIDC	17-1/2
	SEAMANSHIP INTERDIVISIONAL COMPETITION.....	17-1
Annex A	SCORESHEETS.....	17A-1
Annex B	SUGGESTED TRIVIA QUESTIONS.....	17B-1
Annex C	BOATSWAIN’S CALL CARDS.....	17C-1

TABLE OF CONTENTS (Cont)

		PAGE
Annex D	TASK CARDS.....	17D-1
Annex E	TYPES OF SHIPS.....	17E-1
Annex F	MOST LIKE ME ACTIVITY SHEET.....	17F-1
Annex G	SECRET MESSAGE CARDS.....	17G-1

THIS PAGE INTENTIONALLY LEFT BLANK

LIST OF FIGURES

FIGURE	TITLE	PAGE
BOOK 1		
3-1-1	Leadership Team Model.....	3-M303.01-2
3-4-1	Active Listening Examples.....	3-M303.04-4
3-4-2	Chinese Listen Character.....	3-M303.04-5
3A-1	Leadership Team Model.....	3A-1
3D-1	Communication Puzzle.....	3D-1
3J-1	Sample Range Layout.....	3J-2
3J-2	Sample Resource Checklist.....	3J-7
3J-3	Sample Biathlon Range Layout.....	3J-9
3J-4	Sample Resource Checklist.....	3J-14
3J-5	Sample Placement of Chairs.....	3J-22
3J-6	Sample Dais Area.....	3J-24
3J-7	Sample Placement of Flags.....	3J-26
3J-8	Sample Placement of Parade Markers.....	3J-26
3K-1	Neck Stretch.....	3K-1
3K-2	Shoulder Push.....	3K-1
3K-3	Shoulder Shrug.....	3K-1
3K-4	Arm Circles.....	3K-2
3K-5	Shoulder Stretch.....	3K-2
3K-6	Wrist Rotations.....	3K-2
3K-7	Triceps Stretch.....	3K-2
3K-8	Forearm Stretch.....	3K-3
3K-9	Chest Stretch.....	3K-3
3K-10	Side Stretch.....	3K-4
3K-11	Lower Back Stretch.....	3K-4
3K-12	Upper Back Stretch.....	3K-5
3K-13	Hamstring Stretch.....	3K-5
3K-14	Inner Thigh Stretch.....	3K-5
3K-15	Hip Flexor.....	3K-6
3K-16	Ankle Rotations.....	3K-6
3K-17	Calf Stretch.....	3K-6
3K-18	Quadriceps Stretch.....	3K-7
3O-1	Hoop Relay.....	3O-20
3O-2	Coat of Arms Template.....	3O-46
3P-1	Drawing 1.....	3P-4
3P-2	Drawing 2.....	3P-5
3P-3	Balance Beam Set-Up.....	3P-25
3P-4	Traffic Jam Set-Up.....	3P-27

LIST OF FIGURES (Cont)

FIGURE	TITLE	PAGE
3P-5	Swamp Trail Set-Up.....	3P-32
3P-6	Spider Web Set-Up.....	3P-35
3P-7	Swamp Crossing Set-Up.....	3P-40
3P-8	Water Carry Set-Up.....	3P-44
3P-9	Slice and Dice.....	3P-48
6-1-1	Air Rifle Range Commands.....	6-M306.01-4
6-3-1	MPI Examples.....	6-C306.02-3
6-3-2	Rear Sight of the Cadet Air Rifle.....	6-C306.02-5
6-3-3	Sight Adjustment of the Cadet Air Rifle.....	6-C306.02-6
6-4-1	Standing Position.....	6-C306.03-5
6-4-2	Clenched Fist.....	6-C306.03-6
6-4-3	V Shape With the Thumb and Fingers.....	6-C306.03-6
6-4-4	Heel of the Hand.....	6-C306.03-7
6-4-5	Head and Eyes.....	6-C306.03-7
6-4-6	Back and Hip Position.....	6-C306.03-8
6B-1	Pyramid Target.....	6B-2
6C-1	Star Target.....	6C-2
6D-1	Beach Ball Target.....	6D-2
6E-1	Balloon Target.....	6E-2
6F-1	Chase the Dots Target.....	6F-2
6G-1	Speed Grid Target.....	6G-2
6H-1	Clock Target.....	6H-2
6K-1	MPI Examples.....	6K-1
6L-1	Sight Adjustment Activity Targets.....	6L-1
6M-1	Answer Key Targets.....	6M-1
8-1-1	Squad Formations.....	8-M308.01-2
8-1-2	Parade Appointment Symbols.....	8-M308.01-3
8-1-3	Company in Line.....	8-M308.01-4
8-1-4	Company in Column of Threes.....	8-M308.01-4
8-1-5	Company in Column of Route.....	8-M308.01-4
8-2-1	Advance/Retire and Directing Flanks.....	8-M308.02-3
8-3-1	Details of a Flag.....	8-C308.01-2
8-3-2	Details of the Pike and Colour Carrying Belt.....	8-C308.01-3
8-3-3	Flag Party Legend.....	8-C308.01-4
8-3-4	Flag Party for One Flag.....	8-C308.01-4
8-3-5	Flag Party for Two Flags.....	8-C308.01-4
8-3-6	The Order (Attention).....	8-C308.01-6
8-3-7	Stand at Ease.....	8-C308.01-7

LIST OF FIGURES (Cont)

FIGURE	TITLE	PAGE
8-3-8	Carry From the Order.....	8-C308.01-9
8-3-9	Order From the Carry.....	8-C308.01-10
8-3-10	Let Fly From the Carry.....	8-C308.01-11
8-3-11	Catch the Flag From the Let Fly.....	8-C308.01-12
8-3-12	Spiral Countermarch.....	8-C308.01-14
8-3-13	Right Form.....	8-C308.01-15
8-3-14	March on the Flag(s) From the Left Flank.....	8-C308.01-17
9-6-1	Enabling Objective.....	9-M309.06-3
9-6-2	Teaching Points.....	9-M309.06-4
9-6-3	Paragraphs 5. to 7.....	9-M309.06-5
9-6-4	Training Aids and Learning Aids.....	9-M309.06-5
9-6-5	Test Details and Remarks.....	9-M309.06-6
9-6-6	Note Boxes.....	9-M309.06-7
9-6-7	U-Shaped.....	9-M309.06-9
9-6-8	Chevron Shape.....	9-M309.06-10
9-6-9	Horseshoe.....	9-M309.06-10
9-6-10	Semicircle.....	9-M309.06-11
9-6-11	Standard in Line.....	9-M309.06-11
9-6-12	Lesson Plan.....	9-M309.06-15
9-9-1	Forming a Hollow Square.....	9-C309.04-4
9-10-1	Drill Instruction Sequence.....	9-C309.05-3
9K-1	Enabling Objective.....	9K-1
9K-2	Teaching Points.....	9K-2
9K-3	Paragraphs 5. to 7.....	9K-3
9K-4	Training Aids and Learning Aids.....	9K-3
9K-5	Test Details and Remarks.....	9K-4
9K-6	Note Boxes.....	9K-5
10-1-1	Marksmanship Breathing Cycle.....	10-C311.01-2
10-1-2	Instructor in the Centre of a Warm-Up Circle.....	10-C311.01-5
10-1-3	Instructor at the Front With Two Assistant Instructors.....	10-C311.01-6
10-2-1	Instructor in the Centre of a Warm-Up Circle.....	10-C311.02-6
10-2-2	Instructor at the Front with Two Assistant Instructors.....	10-C311.02-6
10A-1	Neck Stretch.....	10A-1
10A-2	Shoulder Push.....	10A-1
10A-3	Shoulder Shrug.....	10A-1
10A-4	Arm Circles.....	10A-2
10A-5	Shoulder Stretch.....	10A-2
10A-6	Wrist Rotations.....	10A-2

LIST OF FIGURES (Cont)

FIGURE	TITLE	PAGE
10A-7	Triceps Stretch.....	10A-2
10A-8	Forearm Stretch.....	10A-3
10A-9	Chest Stretch.....	10A-3
10A-10	Side Stretch.....	10A-3
10A-11	Lower Back Stretch.....	10A-4
10A-12	Upper Back Stretch.....	10A-4
10A-13	Hamstring Stretch.....	10A-4
10A-14	Inner Thigh Stretch.....	10A-5
10A-15	Hip Flexor.....	10A-5
10A-16	Ankle Rotations.....	10A-5
10A-17	Calf Stretch.....	10A-6
10A-18	Quadriceps Stretch.....	10A-6
10B-1	Recreational Summer Biathlon Activity Course Layout.....	10B-1
10B-2	Recreational Summer Biathlon Air Rifle Range Layout.....	10B-2

BOOK 2

12-1-1	Sheers Danger Zones.....	12-M321.01-4
12-1-2	Gyn Danger Zone.....	12-M321.01-5
12-1-3	Standing Derrick Danger Zone.....	12-M321.01-5
12-2-1	Assembled Sheers.....	12-M321.02-2
12-2-2	Assembled Sheers.....	12-M321.02-4
12-2-3	Sheers Head Lashing.....	12-M321.02-5
12-2-4	Strop on a Spar.....	12-M321.02-5
12-2-5	Timber Hitch Step 1.....	12-M321.02-7
12-2-6	Timber Hitch Step 2.....	12-M321.02-8
12-2-7	Timber Hitch Step 3.....	12-M321.02-8
12-2-8	Timber Hitch Step 4.....	12-M321.02-9
12-2-9	Completed Timber Hitch.....	12-M321.02-9
12-2-10	Choking a Luff.....	12-M321.02-10
12-2-11	Topping Lift and Main Purchase Strops.....	12-M321.02-12
12-2-12	Two-Fold Purchase.....	12-M321.02-13
12-2-13	Luff.....	12-M321.02-14
12-2-14	Heel Tackles Rigged to Advantage.....	12-M321.02-14
12-2-15	Mousing a Hook.....	12-M321.02-15
12-2-16	Sheers Run.....	12-M321.02-17
12-3-1	Standing Derrick.....	12-C321.02-3
12-3-2	Parts of a Standing Derrick.....	12-C321.02-4
12-3-3	Snotter.....	12-C321.02-5
12-3-4	Strop on a Spar.....	12-C321.02-5

LIST OF FIGURES (Cont)

FIGURE	TITLE	PAGE
12-3-5	Thumb Piece and Rope Collar.....	12-C321.02-6
12-3-6	Two-Fold Purchase.....	12-C321.02-8
12-3-7	Luff.....	12-C321.02-9
12-3-8	Mousing a Hook	12-C321.02-9
12-3-9	Standing Derrick Run.....	12-C321.02-11
12-4-1	Assembled Gyn.....	12-C321.03-2
12-4-2	Head Lashing.....	12-C321.03-3
12-4-3	Spars.....	12-C321.03-4
12-4-4	Main Purchase and Shoes.....	12-C321.03-4
12-4-5	Strop on a Spar.....	12-C321.03-5
12-4-6	Splay Tackles and Shoes.....	12-C321.03-5
12-4-7	Thumb piece and Rope Collar.....	12-C321.03-6
12-4-8	Head Lashing.....	12-C321.03-8
12-4-9	Head Lashing Strop.....	12-C321.03-9
12-4-10	Two-Fold Purchase.....	12-C321.03-9
12-4-11	Gyn Splay Tackles.....	12-C321.03-10
12-4-12	Luff	12-C321.03-10
12-4-13	Mousing a Hook.....	12-C321.03-11
12-4-14	Assembled Gyn.....	12-C321.03-12
12-4-15	Gyn Run.....	12-C321.03-14
12-5-1	Monkey's Fist Step 1.....	12-C321.04-3
12-5-2	Monkey's Fist Step 2.....	12-C321.04-3
12-5-3	Monkey's Fist Step 3.....	12-C321.04-4
12-5-4	Completed Monkey's Fist.....	12-C321.04-4
12-6-1	Standing Turk's Head.....	12-C321.05-2
12-6-2	Running Turk's Head.....	12-C321.05-2
12-6-3	Steps 1–3.....	12-C321.05-3
12-6-4	Step 4.....	12-C321.05-3
12-6-5	Step 5.....	12-C321.05-4
12-6-6	Step 6.....	12-C321.05-4
12B-1	Assembled Sheers.....	12B-1
12F-1	Standing Derrick.....	12F-1
12J-1	Assembled Gyn.....	12J-1
12M-1	Typical Knot Pattern.....	12M-2
12M-2	Pattern Grid.....	12M-2
12M-3	Pattern Scaling Chart.....	12M-3
12M-4	Step 2.....	12M-4
12M-5	Step 3.....	12M-4

LIST OF FIGURES (Cont)

FIGURE	TITLE	PAGE
12M-6	Steps 4 and 5.....	12M-5
12M-7	Step 7.....	12M-6
12M-8	Step 8.....	12M-6
12M-9	Step 9.....	12M-7
12M-10	Step 10.....	12M-7
12M-11	Step 12.....	12M-8
12N-1	Monkey's Fist Pattern.....	12N-1
12O-1	Typical Knot Pattern–Cylinder Method.....	12O-2
12O-2	Pattern Grid.....	12O-2
12O-3	Pattern Scaling Chart.....	12O-3
12O-4	Step 2.....	12O-4
12O-5	Step 3.....	12O-4
12O-6	Step 4.....	12O-5
12O-7	Step 5.....	12O-6
12O-8	Step 6.....	12O-6
12O-9	Step 7.....	12O-7
12O-10	Step 8.....	12O-7
12O-11	Step 10.....	12O-8
12O-12	Moving a Turn Pin.....	12O-9
12O-13	Step 11.....	12O-10
12O-14	Step 12.....	12O-10
12O-15	Step 13.....	12O-11
12O-16	Finished Turk's Head Bracelet.....	12O-11
12P-1	Turk's Head Pattern.....	12P-1
14-2-1	Common Flags and Pennants.....	14-C323.01-5
14-2-2	Layout for Flag Flash Card Activity.....	14-C323.01-8
14-2-3	Parts of a Signal Mast and Superior Positions.....	14-C323.01-10
14-2-4	Layout for Flag Hoist Activity.....	14-C323.01-13
14-3-1	Wakey Wakey.....	14-C323.02-3
14-4-1	Hands to Dinner.....	14-C323.03-4
14A-1	Functional Organization.....	14A-1
14B-1	Duty Personnel Organization.....	14B-1
14C-1	Training Organization – Option One.....	14C-1
14C-2	Training Organization – Option Two.....	14C-2
14E-1	The General Call.....	14E-2
14E-2	The Still.....	14E-2
14E-3	The Carry On.....	14E-2
14H-1	Parts of a Signal Mast and Superior Positions.....	14H-1

LIST OF FIGURES (Cont)

FIGURE	TITLE	PAGE
14L-1	Wakey Wakey.....	14L-1
14M-1	Hands to Dinner.....	14M-1
17-1	Coil and Heave a Line Activity Layout.....	17-3
17-2	Boatswain's Call Activity Layout.....	17-4
17-3	Knots, Bends and Hitches Activity Layout.....	17-5
17-4	Whipping and Splicing Activity Layout.....	17-7
17-5	Option One Trivia Activity Layout.....	17-9
17-6	Option Two Trivia Activity Layout.....	17-9
17-7	Across the River Activity Layout.....	17-14
17-8	Final Event Layout.....	17-17
17E-1	HMCS Algonquin.....	17E-1
17E-2	HMCS Brandon.....	17E-1
17E-3	HMCS Regina.....	17E-2
17E-4	HMCS Protecteur.....	17E-2
17E-5	Cargo Vessel.....	17E-3
17E-6	Cruise Ship.....	17E-3
17E-7	Car Ferry.....	17E-4
17E-8	Tanker.....	17E-4
17E-9	Tug Handling Supply Vessel.....	17E-5

THIS PAGE INTENTIONALLY LEFT BLANK

CHAPTER 1

PO X01 – PARTICIPATE IN CITIZENSHIP ACTIVITIES



COMMON TRAINING
ALL TRAINING LEVELS
INSTRUCTIONAL GUIDE
CITIZENSHIP



PO X01 – PARTICIPATE IN CITIZENSHIP ACTIVITIES

Total Time:

For the following EOs, refer to the lesson specifications located in A-CR-CCP-601/PG-001, *Royal Canadian Sea Cadets Phase One Qualification Standard and Plan*:

- MX01.01A – Participate in a Citizenship Tour,
- MX01.01B – Attend a Presentation by a Community Organization,
- MX01.01C – Attend a Presentation by a Citizen-of-Interest,
- MX01.01D – Participate in the Canadian Citizenship Challenge,
- MX01.01E – Host a Citizenship Ceremony, and
- CX01.01 – Participate in Citizenship Activities.

For the following EOs, refer to the instructional guides located in A-CR-CCP-601/PF-001, *Royal Canadian Sea Cadets Phase One Instructional Guides*:

- MX01.01F – Participate in an Election,
- MX01.01G – Participate in Heritage Minutes Video Activities, and
- MX01.01H – Participate in Citizenship Learning Stations.

THIS PAGE INTENTIONALLY LEFT BLANK

CHAPTER 2
PO X02 – PERFORM COMMUNITY SERVICE



**COMMON TRAINING
ALL TRAINING LEVELS
INSTRUCTIONAL GUIDE
COMMUNITY SERVICE**



PO X02 – PERFORM COMMUNITY SERVICE

Total Time:

For the following EOs, refer to the instructional guides located in A-CR-CCP-601/PF-001, *Royal Canadian Sea Cadets Phase One Instructional Guides*:

- MX02.01 – Perform Community Service, and
- CX02.01 – Perform Community Service.

THIS PAGE INTENTIONALLY LEFT BLANK

CHAPTER 3

PO 303 – PERFORM THE ROLE OF A TEAM LEADER



COMMON TRAINING
PHASE THREE
INSTRUCTIONAL GUIDE



SECTION 1

EO M303.01 – DEFINE THE ROLE OF A TEAM LEADER

Total Time:

60 min

PREPARATION

PRE-LESSON INSTRUCTIONS

Resources needed for the delivery of this lesson are listed in the lesson specification located in A-CR-CCP-603/PG-001, Chapter 4. Specific uses for said resources are identified throughout the instructional guide within the TP for which they are required.

Review the lesson content and become familiar with the material prior to delivering the lesson.

Photocopy the handouts located at Annexes A and B for each cadet.

PRE-LESSON ASSIGNMENT

N/A.

APPROACH

An interactive lecture was chosen for this lesson to orient the cadets to the leadership team model, core leadership competencies and leadership opportunities for a Phase Three cadet.

INTRODUCTION

REVIEW

N/A.

OBJECTIVES

By the end of this lesson the cadet shall have defined the role of a team leader.

IMPORTANCE

It is important for cadets to define the role of a team leader so they understand how and where they fit within the leadership team model and within the leadership team at the corps. Being aware of the core leadership competencies, and the expectations within each of the competencies, may assist the cadets' developing leadership abilities while adapting to their developing role as a leader in their corps.

Teaching Point 1**Explain the Leadership Team Model and the Position the Year Three Cadet Holds Within the Leadership Team**

Time: 10 min

Method: Interactive Lecture



Distribute the Leadership Team Model handout located at Annex A.

LEADERSHIP TEAM MODEL

Although leadership is usually thought of as an individual pursuit, in the Cadet Program, leadership is based on a team model.



The Leadership Team Model is a fluid model that is dependent on the situation to which it is applied. The personnel in each category of the model will change based on the activity/situation.

During year one, the cadet is expected to be a follower/team member. During year two, the cadet becomes a peer leader. In years three and four, the cadet moves up the model to become a team leader. In years five and beyond, the cadet becomes an activity leader.

The final level of the model is populated by the corps staff, who act as the activity managers.

As each cadet moves through the leadership team model, there are increased expectations of the cadet. Accordingly, there will be an increase in the cadet's leadership responsibilities.

Within the leadership team model, communication moves across each level, and up and down each level. Within this model, cadets on every level should be mentored by someone in the level above.

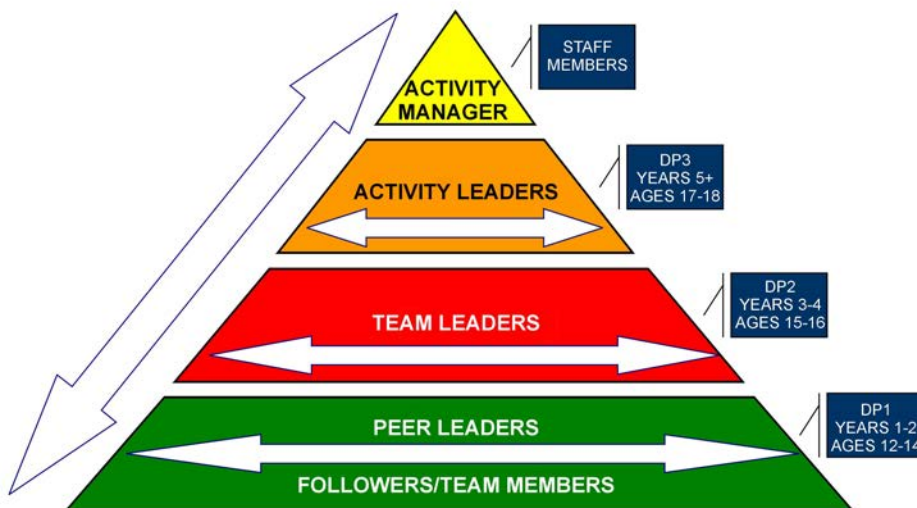
THE LEADERSHIP TEAM MODEL

Director Cadets 3, 2008, Ottawa, ON: Department of National Defence

Figure 3-1-1 Leadership Team Model

CONFIRMATION OF TEACHING POINT 1

QUESTIONS

- Q1. The Cadet Program is based on what kind of leadership model?
- Q2. What is expected of the cadets in the bottom level of the leadership team model?
- Q3. As the cadet moves up the leadership model, what happens to their leadership responsibilities?

ANTICIPATED ANSWERS

- A1. The Cadet Program is based on a leadership team model.
- A2. Cadets are expected to be followers/team members and peer leaders.
- A3. Responsibilities increase as the cadet moves up the leadership team model.

Teaching Point 2

Describe Core Leadership Competencies

Time: 5 min

Method: Interactive Lecture



Distribute the Expectations of a Phase Three cadet handout located at Annex B.

CORE LEADERSHIP COMPETENCIES

To become an effective and capable leader in the Cadet Program, there are six areas where knowledge and skills should be demonstrated. These areas are called core leadership competencies. They include:

- intrapersonal management,
- interpersonal management,
- teamwork,
- effective communication,
- applied leadership, and
- mentorship.

CONFIRMATION OF TEACHING POINT 2

QUESTIONS

- Q1. To become an effective and capable leader in the Cadet Program, there are six areas where knowledge and skills should be demonstrated. What are these called?
- Q2. List the six core leadership competencies.

ANTICIPATED ANSWERS

A1. Core leadership competencies.

A2. The six core leadership competencies are:

- intrapersonal management,
- interpersonal management,
- teamwork,
- effective communication,
- applied leadership, and
- mentorship

Teaching Point 3

Explain the Components of Intrapersonal Management

Time: 5 min

Method: Interactive Lecture



Have cadets follow along using the Expectations of a Phase Three cadet handout for TPs 3–8.

COMPONENTS OF INTRAPERSONAL MANAGEMENT

Intrapersonal management is how cadets maintain control of themselves. There are five parts to intrapersonal management:

Identifying and Satisfying Personal Needs. Cadets should distinguish and accept responsibility for fulfilling their personal needs. Some examples of personal needs include filling basic needs like food and water, feeling safe, feeling like they belong, and having self-confidence. Once cadets know what needs they have, they should work toward satisfying them.

Exercising Self-Control. Cadets should practice self-restraint. It may be difficult but cadets should try not get too upset by situations in which they have no control. When cadets become irate or lose their temper, they give the power in the situation to someone else. If cadets keep their cool, better decisions are usually made.

Exercising Self-Management. Cadets should take charge of their own lives. Cadets need to be organized and direct themselves. Becoming independent (e.g., being punctual, being dressed correctly, etc.) is a natural part of becoming an adult.

Pursuing Self-Improvement. Cadets should strive for self-improvement. Always trying to be better than one was yesterday is a worthwhile goal. Whether one is a better cadet, better at school or a better friend, one should always strive for excellence.

Establishing a Positive Identity. Cadets should gain self-esteem. It is important to be proud of one's accomplishments. Knowing that one is a person that others look up to and want to spend time with, should make one feel proud of oneself.

CONFIRMATION OF TEACHING POINT 3

QUESTIONS

- Q1. What is intrapersonal management?
- Q2. What are the five components of intrapersonal management?
- Q3. How may cadets exercise self-management?

ANTICIPATED ANSWERS

- A1. Intrapersonal management is how cadets control themselves.
- A2. The five components of intrapersonal management are:
- identifying and satisfying personal needs;
 - exercising self-control;
 - exercising self-management;
 - pursuing self-improvement; and
 - establishing a positive identity.
- A3. Cadets may exercise self-management by taking charge of their own lives.

Teaching Point 4**Explain the Components of Interpersonal Management**

Time: 5 min

Method: Interactive Lecture

COMPONENTS OF INTERPERSONAL MANAGEMENT

Interpersonal management is how cadets behave and get along with others. There are three parts of interpersonal management:

Interacting Positively Within the Cadet Community. Cadets should work together with staff, parents, volunteers, etc. in a respectful and helpful manner.

Interacting Positively With Others. Cadets should build positive social relationships by being supportive and encouraging while interacting with other cadets.

Dealing With Interpersonal Conflict in a Respectful Way. Cadets should resolve disagreements with others at the lowest possible level and come up with a mutually satisfactory solution where a “win-win” outcome is achieved.

CONFIRMATION OF TEACHING POINT 4

QUESTIONS

- Q1. What is interpersonal management?
- Q2. What are the three components of interpersonal management?
- Q3. How should cadets resolve disagreements?

ANTICIPATED ANSWERS

- A1. Interpersonal management is how cadets behave and get along with others.
- A2. The three components of interpersonal management are:
- interacting positively within the cadet community;
 - interacting positively with others; and
 - dealing with interpersonal conflict in a respectful way.
- A3. Cadets should resolve disagreements with others at the lowest possible level and come up with a mutually satisfactory solution where a “win-win” outcome is achieved.

Teaching Point 5

Explain the Components of Teamwork

Time: 5 min

Method: Interactive Lecture

COMPONENTS OF TEAMWORK

Teamwork is how cadets create effective and efficient action in a group of people. There are three parts of teamwork:

Participating in the Stages of Team Development. Cadets should take part in the stages of team development. The stages are forming, storming, norming, performing and adjourning.

Displaying Positive Team Dynamics. Cadets should demonstrate positive team dynamics by following the team leader, including all participants, encouraging team members, contributing to team morale and esprit de corps, contributing to the accomplishment of team goals, contributing to group decisions, trusting the team, supporting team members, appreciating team members, and celebrating team successes.

Participating in Team-Building Activities. Cadets should take part in team-building activities. These activities will build positive team dynamics and they allow cadets to practice leadership skills.

CONFIRMATION OF TEACHING POINT 5

QUESTIONS

- Q1. What is teamwork?
- Q2. What are the three components of teamwork?
- Q3. How may cadets display positive team dynamics?

ANTICIPATED ANSWERS

- A1. Teamwork is how cadets create effective and efficient action in a group of people.
- A2. The three components of teamwork are:
- participating in the stages of team development;
 - displaying positive team dynamics; and
 - participating in team-building activities.
- A3. Cadets may display positive team dynamics by following the team leader, including all participants, encouraging team members, contributing to team morale and esprit de corps, contributing to the

accomplishment of team goals, contributing to group decisions, trusting the team, supporting team members, appreciating team members, and celebrating team successes.

Teaching Point 6
Explain the Components of Effective Communication

Time: 5 min

Method: Interactive Lecture

COMPONENTS OF EFFECTIVE COMMUNICATION

Effective communication is how cadets relay information successfully. There are three parts of effective communication:

Receiving Information. Cadets should be given or obtain instructions or facts. This information may be received verbally or in writing.

Interpreting Information. Cadets should comprehend the instructions or facts. To interpret information correctly, questions may be asked to the deliverer of the information to ensure clarity.

Responding to Information. Cadets should react to the instructions or facts. Responding to information may include passing on information to others, solving problems, etc.

CONFIRMATION OF TEACHING POINT 6

QUESTIONS

- Q1. What is effective communication?
- Q2. What are the three components of effective communication?
- Q3. In what ways may information be received?

ANTICIPATED ANSWERS

- A1. Effective communication is how cadets relay information successfully.
- A2. The three components of effective communication are:
- receiving information;
 - interpreting information; and
 - responding to information.
- A3. Information may be received verbally or in writing.

Teaching Point 7
Explain the Components of Applied Leadership

Time: 5 min

Method: Interactive Lecture

COMPONENTS OF APPLIED LEADERSHIP

Applied leadership is how cadets practice influencing and managing others. There are six parts of applied leadership:

Setting an Example for Others to Follow. Cadets should establish themselves as a model for others. If cadets set an example in the core leadership competencies, others will want to imitate them.

Participating in Leadership Assignments. Cadets will take part in given tasks or jobs. This gives cadets chances to practice influencing and managing others. Some of these tasks or jobs will be evaluated by the staff and some will not be evaluated. Cadets should practice reflection and self-assessment after leading each assignment.

Conducting the Leadership Assignment While Supervising the Team. Cadets will observe and guide a team while the leadership assignment is taking place. Supervising others is one of the responsibilities of a leader. Cadets will ensure the leadership assignment is conducted in a safe manner and completed as instructed by the staff.

Leading Team-Building Activities. Cadets should direct team-building or creative games. This gives cadets chances to practice influencing and managing others. Again, cadets should practice reflection and self-assessment after leading team-building activities.

Debriefing the Team. Cadets should review and discuss with the team the completion and outcome of a leadership assignment or a team-building activity. Cadets should practice effective communication while speaking to the team.

Presenting an After-Assignment Report to Their Leader. Cadets should review and discuss with their leader/supervisor the completion and outcome of a leadership assignment or a team-building activity. Cadets should practice effective communication while speaking to their leader/supervisor.

CONFIRMATION OF TEACHING POINT 7

QUESTIONS

- Q1. What is applied leadership?
- Q2. What are the six components or parts of applied leadership?
- Q3. Why is setting an example for others to follow important?

ANTICIPATED ANSWERS

- A1. Applied leadership is how cadets practice influencing and managing others.
- A2. The six components or parts of applied leadership are:
 - setting an example for others to follow;
 - participating in leadership assignments;
 - conducting the leadership assignment while supervising the team;
 - leading team-building activities;
 - debriefing the team; and
 - presenting an after-assignment report to their leader.
- A3. Setting an example for others to follow is important because if cadets establish themselves as a model, others will want to imitate them.

Teaching Point 8**Explain the Components of Mentorship**

Time: 5 min

Method: Interactive Lecture

COMPONENTS OF MENTORSHIP

Mentorship is how cadets participate in a professional association between two people that focuses on self-development. There are two parts to mentorship:

The Role of a Cadet Being Mentored. Cadets will assume the role of a cadet being mentored. This is the trainee in the relationship. Cadets being mentored should enhance their knowledge and skills of leadership. Learning from the mentor's example will be an important element of the mentoring relationship.

The Role of a Mentor. Cadets will assume the role of a mentor. This is the advisor/guide in the relationship. Cadets mentoring should enhance their leadership abilities, coaching skills and communication skills. As a mentor, cadets may see things from a different perspective than the cadet being mentored.

CONFIRMATION OF TEACHING POINT 8

QUESTIONS

- Q1. What is mentorship?
- Q2. What are the two components of mentorship?
- Q3. Who is the trainee in the mentoring relationship?

ANTICIPATED ANSWERS

- A1. Mentorship is how cadets participate in a professional association between two people that focuses on self-development.
- A2. The two components of mentorship are:
- the role of a cadet being mentored; and
 - the role of a mentor.
- A3. The trainee in the mentoring relationship is the cadet being mentored.

Teaching Point 9**Identify the Phase Three Team Leader Opportunities**

Time: 5 min

Method: Interactive Lecture

PHASE THREE TEAM LEADER OPPORTUNITIES

In year three, cadets will have team leader opportunities. These include:

Performing the Role of a Mentor. Performing the role of a mentor may be as simple as partnering up with a year one cadet. This buddy system may help the year one cadet gain skills and knowledge about the corps and should assist the year three cadet in their leadership and communication skills.

Completing a Leadership Assignment. Each year three cadet will be given occasions in which they will complete a leadership assignment. These assignments may include classroom set ups, ensuring building clean up, or assisting with a sailing day. Some of the leadership assignments will be evaluated by the staff.

CONFIRMATION OF TEACHING POINT 9

QUESTIONS

- Q1. What are the Phase Three training opportunities?
- Q2. What is one simple way to perform the role of a mentor?
- Q3. What are some examples of leadership assignments?

ANTICIPATED ANSWERS

- A1. The Phase Three training opportunities include:
- performing the role of a mentor; and
 - completing a leadership assignment.
- A2. One simple way to perform the role of a mentor is to use the buddy system.
- A3. Some examples of leadership assignments include classroom set up, ensuring building clean up, or assisting with a sailing day.

END OF LESSON CONFIRMATION

QUESTIONS

- Q1. What position does a Phase Three cadet hold in the leadership team model?
- Q2. List the six core leadership competencies.
- Q3. What are the Phase Three training opportunities?

ANTICIPATED ANSWERS

- A1. The Phase Three cadet holds the position of team leader.
- A2. The six core leadership competencies are:
- intrapersonal management,
 - interpersonal management,
 - teamwork,
 - effective communication,
 - applied leadership, and
 - mentorship.
- A3. The Phase Three training opportunities include:
- performing the role of a mentor; and
 - completing a leadership assignment.

CONCLUSION

HOMEWORK/READING/PRACTICE

N/A.

METHOD OF EVALUATION

N/A.

CLOSING STATEMENT

Cadets should know and understand their role within the leadership team at the corps. When cadets know what is expected of them it is much easier for them to set and reach their goals. Higher expectations lead to greater results. Being aware of the core leadership competencies and the components for each may assist the cadets' developing leadership abilities while adapting to their developing role as a leader in their corps.

INSTRUCTOR NOTES/REMARKS

N/A.

REFERENCES

- C0-114 (ISBN 0-02-863656-2) Pell, A. R. (1999). *The Complete Idiot's Guide to Team Building*. Indianapolis, IN: Alpha Books.
- C0-115 (ISBN 0-7879-4059-3) van Linden, J. A., & Fertman, C. I. (1998). *Youth Leadership*. San Francisco, CA: Jossey-Bass Inc., Publishers.
- C0-240 (ISBN 0-934387-05-2) Collard, M. (2005). *No Props: Great Games With No Equipment*. Beverly, MA: Project Adventure, Inc.
- C0-245 (ISBN 1-58062-513-4) Adams, B. (2001). *The Everything Leadership Book*. Avon, MA: Adams Media.
- C0-256 (ISBN 0-7894-4863-7) Heller, R. (1999). *Achieving Excellence*. New York, NY: DK Publishing, Inc.
- C0-258 (ISBN 978-1-59869-450-5) Nigro, N. (2008). *The Everything Coaching and Mentoring Book*. (2nd ed.). Avon, MA: F+W Publications Company.
- C0-268 (ISBN 978-1-57542-265-7) MacGregor, M. S. (2008). *Teambuilding With Teens: Activities for Leadership, Decision Making and Group Success*. Minneapolis, MN: Free Spirit Publishing.
- C0-270 Maslow, A. H. (1943). *A Theory of Human Motivation*. *Psychological Review*, Vol. 50, No. 4, pp. 370–396.
- C0-271 Farthing, D. (2001). *Peacebuilders 1: Conflict Resolution Youth Reference Guide*. Ottawa, ON: YouCAN.

THIS PAGE INTENTIONALLY LEFT BLANK



COMMON TRAINING
PHASE THREE
INSTRUCTIONAL GUIDE



SECTION 2

EO M303.02 – PARTICIPATE IN A MENTORING RELATIONSHIP

Total Time:

30 min

PREPARATION

PRE-LESSON INSTRUCTIONS

Resources needed for the delivery of this lesson are listed in the lesson specification located in A-CR-CCP-603/PG-001, Chapter 4. Specific uses for said resources are identified throughout the instructional guide within the TP for which they are required.

Review the lesson content and become familiar with the material prior to delivering the lesson.

Prepare questions for the group discussion.

PRE-LESSON ASSIGNMENT

N/A.

APPROACH

An interactive lecture was chosen for TP 1 to orient the cadets to the mentoring relationship, to generate interest and present basic material.

A group discussion was chosen for TP 2 as it allows the cadets to interact with their peers and share their knowledge, experiences, opinions and feelings about the mentoring relationship.

INTRODUCTION

REVIEW

N/A.

OBJECTIVES

By the end of this lesson the cadet shall be expected to participate in a mentoring relationship.

IMPORTANCE

It is important for cadets to participate in a mentoring relationship to assist in the development of their leadership abilities. The mentoring relationship expands leadership knowledge and skills of participants, enhances communication skills, resolves conflict and promotes constructive feedback, and should aid in the leadership development of all cadets.

Teaching Point 1**Explain the Mentoring Relationship**

Time: 15 min

Method: Interactive Lecture



Begin the lesson by asking the cadets if they know what the word mentoring means. Do the cadets have any examples of mentoring?

THE MENTORING RELATIONSHIP

A mentoring relationship is a professional association between two people that focuses on self-development. One is the mentor; the other is the cadet being mentored. The mentor is the experienced and trusted advisor or guide; however, both individuals are expected to learn from the relationship.

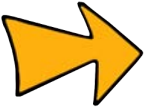

The mentoring relationship for a year three cadet may be as simple as partnering up with a year one cadet. This buddy system may help the year one cadet gain skills and knowledge about the corps and should assist the year three cadet in their leadership and communication skills. A year three cadet may also be mentored by a year five cadet.

Recognizing the Purpose of a Mentoring Relationship

The purpose of the mentoring relationship is to share experiences between the mentor and the cadet being mentored, so the cadet being mentored is better prepared to move forward through the program with knowledge and confidence.

Identifying the Benefits of Participating in a Mentoring Relationship

The benefits of participating in a mentoring relationship are numerous. The basic benefit for a cadet being mentored is to show growth in skills and become a more independent and effective cadet. The most significant benefit for the mentor is the realization that they have inspired the cadet to perform at higher levels than the cadet would have without a mentor.

Contributing to a Mentoring Match

Contributing to a mentoring match means that both the mentor and the one being mentored will have some say with whom they are matched. The mentoring relationship is based on trust; ensure a long-term and valuable connection can be made with the person you choose.

Being Open to New Things

For a mentoring relationship to be successful, both individuals must be willing to try new things. Expanding your horizons and increasing your knowledge are foundations of the mentoring relationship. Being receptive to new ideas and experiences takes courage.

Being Responsive to Suggestions and Constructive Criticism

The cadet being mentored should be responsive to suggestions made by the mentor. The mentor should use constructive criticism and will attempt to provide feedback that will assist the cadet being mentored. This may include feedback that is positive in nature or feedback that assists in finding solutions for poor performance. The task of the cadet being mentored is to be receptive to recommendations being made.

Providing Feedback to the Mentor

Mentoring is a two-way relationship, so it is important that the cadet being mentored provides feedback to the mentor. This feedback should be based on feelings, both positive and negative, and observations. If the cadet being mentored does not express their feelings to their mentor about the relationship, then progress may be hindered.

Learning From the Mentor's Example

It is up to the mentor to set an example that the cadet being mentored would want to emulate. This example should be in all facets of the program (e.g., drill, dress, deportment, leadership, academics, etc.). The cadet being mentored should learn not only from the mentor's successes but from the mentor's failures.



It is important to remember that failure is not necessarily a negative thing. As long as cadets fail forward (learn from their mistakes) there is an advantage to any failure because a learning opportunity has been created.

Participating in Mentoring Activities

To get the most benefit from a mentoring relationship, the cadet being mentored must be prepared to participate in some mentoring activities. These activities may include reflection, self-assessment, and discussions about successes, problems and failures. The mentor must also be prepared for each mentoring session. They need to have an agenda of what will be discussed and ensure that the discussions stay on track.

Appreciating the Mentoring Relationship

An effective mentoring relationship must be respected by both people involved. Each person should have a high regard for the other in the relationship. Appreciating the other person for their effort, time and accomplishments will ensure a long-lasting and mutually beneficial partnership.

CONFIRMATION OF TEACHING POINT 1

QUESTIONS

- Q1. What is the basic benefit of a mentoring relationship for the cadet being mentored?
- Q2. Why should the mentor and the cadet being mentored be open to new things?
- Q3. What are some examples of mentoring activities?

ANTICIPATED ANSWERS

- A1. The basic benefit is that the cadet being mentored will grow in their skills and become a more independent and more effective cadet.
- A2. The mentor and the cadet being mentored should be open to new things because each should wish to expand their horizons and increase their knowledge of the mentoring relationship. Being receptive to new ideas and experiences takes courage.
- A3. Mentoring activities may include reflection, self-assessment and discussions about successes, problems and failures.

Teaching Point 2**Conduct a Group Discussion About Mentoring**

Time: 10 min

Method: Group Discussion

BACKGROUND KNOWLEDGE

The point of the group discussion is to draw information about the mentoring relationship from the group using the tips for answering/facilitating discussion and the suggested questions provided.



This group discussion focuses on self-reflection, self-assessment, recording in a journal, and mentoring sessions.

GROUP DISCUSSION**TIPS FOR ANSWERING/FACILITATING DISCUSSION**

- Establish ground rules for discussion, e.g., everyone should listen respectfully; don't interrupt; only one person speaks at a time; no one's ideas should be made fun of; you can disagree with ideas but not with the person; try to understand others as much as you hope they understand you; etc.
- Sit the group in a circle, making sure all cadets can be seen by everyone else.
- Ask questions that will provoke thought; in other words avoid questions with yes or no answers.
- Manage time by ensuring the cadets stay on topic.
- Listen and respond in a way that indicates you have heard and understood the cadet. This can be done by paraphrasing their ideas.
- Give the cadets time to respond to your questions.
- Ensure every cadet has an opportunity to participate. One option is to go around the group and have each cadet answer the question with a short answer. Cadets must also have the option to pass if they wish.
- Additional questions should be prepared ahead of time.

SUGGESTED QUESTIONS

Q1. What is self-reflection?

Q2. Why do you think self-reflection is useful when participating in a mentoring relationship? Give some examples when self-reflection may be used by the cadet being mentored. Give some examples when self-reflection may be used by the mentor.

Q3. What is self-assessment?

- Q4. Is there a difference between self-assessment and self-reflection?
- Q5. Why do you think self-assessment is useful when participating in a mentoring relationship? Give some examples when self-assessment may be used by the cadet being mentored. Give some examples when self-assessment may be used by the mentor.
- Q6. Why record in a journal?
- Q7. Is there a difference between recording in a journal, self-assessment and self-reflection?
- Q8. Why do you think recording in a journal is useful when participating in a mentoring relationship? Give some examples when recording in a journal may be used by the cadet being mentored. Give some examples when recording in a journal may be used by the mentor
- Q9. When a mentoring session takes place, what do you think it looks like?
- Q10. What does it sound like?
- Q11. What do you think a mentoring session feels like?



Other questions and answers will develop throughout the group discussion. The group discussion should not be limited to only those suggested.



Reinforce those answers given and comments made during the group discussion, ensuring the teaching point has been covered.

CONFIRMATION OF TEACHING POINT 2

The cadets' participation in the group discussion will serve as confirmation of this TP.

END OF LESSON CONFIRMATION

The cadets' participation in the group discussion will serve as confirmation of this lesson.

CONCLUSION

HOMework/READING/PRACTICE

N/A.

METHOD OF EVALUATION

N/A.

CLOSING STATEMENT

Being mentored and mentoring others is one way to enhance skills and knowledge of leadership. The mentoring relationship develops trust and trust is the foundation of leadership. Using self-reflection, self-assessment, and recording in a journal are excellent methods to track advancement through the Cadet Program.

INSTRUCTOR NOTES/REMARKS

After this lesson each year three cadet will choose at least one year one cadet to mentor. Each year three cadet will also be asked which year five cadet they would like to mentor them.

REFERENCES

- C0-258 (ISBN 978-1-59869-450-5) Nigro, N. (2008). *The Everything Coaching and Mentoring Book*. (2nd ed.). Avon, MA: F+W Publications Company.
- C2-109 (ISBN 0-7872-6561-6) Sugarman, D., Doherty, K., Garvey, D., & Gass, M. (2000). *Reflective Learning: Theory and Practice*. Dubuque, IO: Kendall/Hunt Publishing Company.



COMMON TRAINING
PHASE THREE
INSTRUCTIONAL GUIDE



SECTION 3
EO M303.03 – PRACTICE SELF-ASSESSMENT

Total Time:

30 min

PREPARATION

PRE-LESSON INSTRUCTIONS

Resources needed for the delivery of this lesson are listed in the lesson specification located in A-CR-CCP-603/PG-001, Chapter 4. Specific uses for said resources are identified throughout the instructional guide within the TP for which they are required.

Review the lesson content and become familiar with the material prior to delivering the lesson.

Photocopy handout located at Annex C for each cadet.

PRE-LESSON ASSIGNMENT

N/A.

APPROACH

An interactive lecture was chosen for TP 1 to define reflection and self-assessment.

An in-class activity was chosen for TP 2 as an interactive way to provoke thought, to stimulate an interest among cadets and to conduct self-assessments.

A group discussion was chosen for TP 3 as it allows the cadets to interact with their peers and share their knowledge, experiences, opinions and feelings about the benefits of seeking feedback and assistance.

INTRODUCTION

REVIEW

N/A.

OBJECTIVES

By the end of this lesson the cadet shall be expected to practice self-assessment.

IMPORTANCE

It is important for cadets to practice self-assessment as it is an excellent method to identify areas for self-improvement and assessment for learning. Self-assessment is a cornerstone of assessment for learning. It enables cadets and staff to ensure individual and program/organizational goals are being met.

Teaching Point 1**Define Reflection and Self-Assessment**

Time: 5 min

Method: Interactive Lecture



Reflection and self-assessment will be used in many performance objectives of the Cadet Program to enable the cadet and their staff to track your development and progress of different skills and knowledge.

Reflection. Long and careful consideration. Reflection can take place at any time and does not necessarily have to be about oneself. Usually reflection takes places directly after an action is taken.

Self-Assessment. Assessment or evaluation of oneself, or one's actions, attitudes or performance. In order to perform self-assessment correctly, reflection about oneself must take place before the self-assessment.

CONFIRMATION OF TEACHING POINT 1**QUESTIONS**

- Q1. Define reflection.
- Q2. Define self-assessment.
- Q3. In order to perform self-assessment correctly, when must reflection take place?

ANTICIPATED ANSWERS

- A1. Long and careful consideration.
- A2. Assessment or evaluation of oneself, or one's actions, attitudes or performance.
- A3. Reflection about oneself must take place before the self-assessment.

Teaching Point 2**Have the Cadet Conduct Self-Assessment Activities**

Time: 10 min

Method: In-Class Activity



Reflection and self-assessment, in all their forms, are enhanced by providing context for each activity. The objective of this particular reflection and self-assessment is to have cadets find a baseline level of their core leadership qualities and their positive team dynamics.

Providing the time, environment and opportunity for reflection and self-assessment, allows the cadet to complete an assessment for learning and should be the spark that lights the fire of learning.

Ask cadets to reflect on their last three years in the program before completing the rubrics.

ACTIVITY**OBJECTIVE**

The objective of this activity is to have cadets conduct self-assessment activities.

RESOURCES

- Self-assessment rubric for core leadership qualities, and
- Self-assessment rubric for positive team dynamics.

ACTIVITY LAYOUT

N/A.

ACTIVITY INSTRUCTIONS

1. Distribute the self-assessment rubrics located at Annex C to each cadet.
2. Explain that each cadet should reflect on each category on the rubric before completing it.
3. Give cadets eight minutes to complete the two rubrics.

SAFETY

N/A.

CONFIRMATION OF TEACHING POINT 2

The cadets' participation in the in-class activity will serve as the confirmation of this TP.

Teaching Point 3**Conduct a Group Discussion on How and When to Seek Feedback and Assistance**

Time: 10 min

Method: Group Discussion

BACKGROUND KNOWLEDGE



The point of the group discussion is to draw the following information from the group using the tips for answering/facilitating discussion and the suggested questions provided.

Seeking feedback after self-assessment may be necessary. Feedback from others, in the form of advice, should give the cadet ideas to help improve performance.

Assistance after self-assessment may be necessary. Assistance from others, in the form of collaboration, should help the cadet improve performance.

Feedback and assistance should guide the cadet to ensure all goals, both personal (e.g., improving PACER time) and professional (e.g., becoming a better instructor), are being met.

GROUP DISCUSSION



TIPS FOR ANSWERING/FACILITATING DISCUSSION

- Establish ground rules for discussion, e.g., everyone should listen respectfully; don't interrupt; only one person speaks at a time; no one's ideas should be made fun of; you can disagree with ideas but not with the person; try to understand others as much as you hope they understand you; etc.
- Sit the group in a circle, making sure all cadets can be seen by everyone else.
- Ask questions that will provoke thought; in other words avoid questions with yes or no answers.
- Manage time by ensuring the cadets stay on topic.
- Listen and respond in a way that indicates you have heard and understood the cadet. This can be done by paraphrasing their ideas.
- Give the cadets time to respond to your questions.
- Ensure every cadet has an opportunity to participate. One option is to go around the group and have each cadet answer the question with a short answer. Cadets must also have the option to pass if they wish.
- Additional questions should be prepared ahead of time.

SUGGESTED QUESTIONS

- Q1. Should you seek feedback after completing self-assessment? Why or why not?
- Q2. When is a good time to seek feedback? Why?
- Q3. Should you seek assistance after completing self-assessment? Why or why not?
- Q4. When is a good time to seek assistance? What may seeking assistance look like?
- Q5. Is seeking assistance different than seeking feedback? If it is different, how is it different?



Other questions and answers will develop throughout the group discussion. The group discussion should not be limited to only those suggested.



Reinforce the answers given and comments made during the group discussion, ensuring the teaching point has been covered.

CONFIRMATION OF TEACHING POINT 3

The cadets' participation in the group discussion will serve as the confirmation of this TP.

END OF LESSON CONFIRMATION

The cadets' participation in the group discussion will serve as the confirmation of this lesson.



Advise cadets to take their self-assessment rubrics home and place them somewhere safe because they will need to look at these rubrics again to track their progress.

CONCLUSION

HOMEWORK/READING/PRACTICE

N/A.

METHOD OF EVALUATION

N/A.

CLOSING STATEMENT

Self-assessment is one method to help improve leadership skills. Regular practice of reflection and self-assessment will assist the cadet in measuring and tracking improvement of skills and knowledge. Self-assessment also helps cadets set, strive for and maintain goals.

INSTRUCTOR NOTES/REMARKS

N/A.

REFERENCES

- C0-237 (ISBN 0-19-541816-6) Barber, K. (Ed.). (2004). *Canadian Oxford Dictionary* (2nd ed.). Don Mills, ON: Oxford University Press Canada.
- C0-242 (ISBN 978-0-9682160-2-1) Gregory, K., Cameron, C., & Davies, A. (2000). *Knowing What Counts: Self-Assessment and Goal Setting*. Courtenay, BC: Building Connections Publishing Inc.
- C0-258 (ISBN 978-1-59869-450-5) Nigro, N. (2008). *The Everything Coaching and Mentoring Book*. (2nd ed.). Avon, MA: F+W Publications Company.

THIS PAGE INTENTIONALLY LEFT BLANK



COMMON TRAINING
PHASE THREE
INSTRUCTIONAL GUIDE



SECTION 4

EO M303.04 – COMMUNICATE AS A TEAM LEADER

Total Time:

60 min

PREPARATION

PRE-LESSON INSTRUCTIONS

Resources needed for the delivery of this lesson are listed in the lesson specification located in A-CR-CCP-603/PG-001, Chapter 4. Specific uses for said resources are identified throughout the instructional guide within the TP for which they are required.

Review the lesson content and become familiar with the material prior to delivering the lesson.

Photocopy a Communication Puzzle located at Annex D for each cadet. Using half of the copies, cut out the puzzle pieces and place each set of pieces in a resealable plastic bag. With the other half, place each full puzzle in an envelope.

PRE-LESSON ASSIGNMENT

N/A.

APPROACH

An interactive lecture was chosen for TPs 1–4 to orient the cadets to communicating as a team leader.

An in-class activity was chosen for TP 5 as an interactive way to provoke thought and stimulate interest among cadets about the process of communication and the barriers to communication.

INTRODUCTION

REVIEW

N/A.

OBJECTIVES

By the end of this lesson the cadet shall have communicated as a team leader.

IMPORTANCE

It is important for cadets to understand the process of communication. People communicate everyday as a way to share knowledge, interests, attitudes, opinions, feelings and ideas with others. After understanding ways to communicate, cadets must become familiar with the process of communication and when and how to use

it. Communication skills are a fundamental part of leadership because they permit the flow of ideas from one individual to another or to a group, and vice versa. Effective communication helps people break down barriers between themselves and others.

Teaching Point 1
Explain Verbal and Non-Verbal Communication

Time: 5 min

Method: Interactive Lecture

Every form of communication must have a sender and a receiver.

VERBAL COMMUNICATION

When individuals speak to each other, verbal communication is being used. Much of what a person receives from a conversation is picked up through words. Verbal communications are used during conversations, meetings, interviews, speeches and more.

NON-VERBAL COMMUNICATION

When individuals communicate, body language and gestures are very useful. Body language and gestures act as communication shortcuts that convey messages previously learned by both the sender and the receiver.



Have the cadets give examples of body language and gestures. Ensure the examples are non-controversial.

Written communications such as memos and e-mail are considered non-verbal communications. Written communications are used in the cadet organization because they are accessible and usually permanent.

CONFIRMATION OF TEACHING POINT 1

QUESTIONS

- Q1. Every form of communication must have what?
- Q2. When is verbal communication used?
- Q3. List three types of non-verbal communications?

ANTICIPATED ANSWERS

- A1. A sender and a receiver.
- A2. Verbal communications are used during conversations, meetings, interviews, speeches and more.
- A3. Body language, gestures, and written communications.

Teaching Point 2**Explain Hearing and Listening and Their Impact on Communication**

Time: 15 min

Method: Interactive Lecture



Before beginning this TP, ask the cadets if they think there is a difference between hearing and listening.

Do not spend a lot of time on the question since it will be elaborated throughout this TP.

THE DEFINITION OF HEARING

Oxford dictionary defines “hear” as:

- perceive (sound, etc.) with the ear;
- listen to as a member of an audience; and
- be told or informed.

Hearing occurs naturally everyday, whether a person wishes to hear or not.

THE DEFINITION OF LISTENING

Oxford dictionary defines “listen” as:

- to make an effort to hear something;
- pay attention to; and
- give attention with the ear.

When a person listens, they are making an effort to hear something. In order to listen effectively, the listener must pay attention to the person who is speaking.

ACTIVE LISTENING

Active listening is difficult because it demands that the listener put aside any internal reactions and turn their attention to the speaker without judging what is being said.

By withholding judgment, a person communicates respect by acknowledging that the other person is important and deserves to be heard and understood. Active listening encourages people to talk about facts and feelings without a risk of being put down. The goal of active listening is not only to hear what the speaker is saying but also to allow them to focus on themselves so that they can accurately communicate how they feel. There are many situations in which active listening can be used and practiced. Some of these situations are explained in Figure 3-4-1.



Ask the cadets to think about some real-life examples of times when they have tried to be good listeners while sharing some of the comparisons below.

Active Non-Listening	Active Listening
Give the other person your version.	Repeat conversationally back to them, in your own words, your understanding of the meaning.
Give your own opinions and advice. Talk about yourself at every point.	Do not talk about yourself.
Introduce new topics to get off the subject if it is uncomfortable.	Let the speaker take the lead. Encourage them back to the issue when they digress. Do not allow the person to drift to a less significant topic because they feel that you do not understand.
Think of what you are going to say next while the speaker is talking.	Concentrate fully on what the person is saying.
Do not let the speaker know if you do not know what they are talking about.	Ask for clarification when you do not understand.
Reassure by saying "It's not that bad" or talk them out of it.	Let them come to their own answer since your answer may not be theirs. Do not offer advice.
Agree with generalizations such as "Yes, it's hopeless" or "There's nothing you can do."	Let them find their answer. Reflect back to them so that they know you understand but also so they can hear and understand themselves.
Dismiss their feelings by saying things such as "You'll feel better tomorrow" or "It's not the end of the world."	Support their feelings by saying things such as "You feel hopeless about it right now" or "You can't find anything that will fix it yet."
Fill silences.	Allow silences.

E. Colver & M. Reid, Peacebuilders 2: Peer Helping, YouCAN (p. 13)

Figure 3-4-1 Active Listening Examples

POOR LISTENING HABITS

People often need to feel heard before they can hear. When listening, focus on the speaker. Affirmative listening (nodding and giving quick answers) shows the speaker that the listener is paying attention, consequently encouraging them to continue communicating.

Care should be taken to maintain focus and concentration when having a conversation. The following are some examples of poor listening habits:

- formulating replies while the other person is speaking;
- letting the mind wander;
- tuning out a point of view that differs from the listener's preconceived ideas;
- interrupting speakers;
- finishing a speaker's sentence for them;
- talking while other people are speaking;
- jumping to conclusions; and

- hearing only what the listener wants to hear or expects to hear or assuming what will be said.

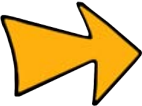

The Chinese character for listen, pronounced *ting*, is made up of four characters: the heart, the mind, the ears and the eyes.



K. Cole, *The Complete Idiot's Guide to Clear Communication*, Pearson Education Inc. (p. 130)

Figure 3-4-2 Chinese Listen Character

THE IMPACT THAT LISTENING AND HEARING HAVE ON COMMUNICATION

Noises are easy to hear but because a person can hear what is happening, does it mean that they are listening? Sometimes the listener must stop the person who is talking and ask them to start over. It is possible to hear a person speak but have no idea what they are saying.



Ask the cadets to think about some lessons or conversations that occurred recently in which they could hear what was happening but were not listening.

In order to communicate effectively, it is vital that those who are receiving the information are listening; a speaker must have the attention and focus of the listeners.

Listeners should involve themselves in communication physically, mentally and verbally. Using body language will help keep the attention of listeners. Those listening should focus their attention solely on the speaker. If the topic is important, a good way to stay focused is to take notes. When the speaker is finished, ask questions to make sure the message you received is right.

CONFIRMATION OF TEACHING POINT 2

QUESTIONS

- Q1. What is the definition of "listen"?
- Q2. List some examples of poor listening habits.
- Q3. In what ways should listeners involve themselves in communication?

ANTICIPATED ANSWERS

A1. Oxford dictionary defines “listen” as:

- to make an effort to hear something;
- pay attention to; and
- give attention with the ear.

A2. The following are examples of poor listening habits:

- formulating replies while the other person is speaking;
- letting the mind wander;
- tuning out a point of view that differs from the listener’s preconceived ideas;
- interrupting speakers;
- finishing a speaker’s sentence for them;
- talking while other people are speaking;
- jumping to conclusions; and
- hearing only what the listener wants to hear or expects to hear or assuming what will be said.

A3. Listeners should involve themselves in communication physically, mentally and verbally.

Teaching Point 3

Describe the Process of Communication

Time: 5 min

Method: Interactive Lecture

PROCESS OF COMMUNICATION

Communication skills are a fundamental part of leadership because they permit the flow of ideas from one individual to another or to a group, and vice versa. Effective communication helps people break down barriers between themselves and others. Giving careful thought, not only to what people want to express but also to how they want to express it, is an important part of communication. Communication involves a complex interaction of habits, attitudes, knowledge, information and bias.

The process of communication consists of three steps:

1. receiving;
2. interpreting; and
3. responding.

Receiving Information

Receiving a message will depend directly on what information was sent by the sender and how it was sent. When receiving, listening is of the utmost importance.

Messages may be simple or complex. When receiving a complex message, the receiver must be prepared to write down important information. If there is a lack of understanding or any confusion, the receiver should ask questions.

Interpreting Information

After a message has been received, it must be reflected on and interpreted. Simple messages may not require much interpretation.

Receivers of a message will translate what they heard based on their own set of definitions, which may differ greatly from those of the sender.

Responding Information

A response will let the sender know that the message has been received and interpreted and is now being acted on. The response may be to the sender or it may be to another person or a group to act on the message. When responding, being able to communicate what was interpreted from the message is important.

CONFIRMATION OF TEACHING POINT 3

QUESTIONS

- Q1. What step of communication occurs after the message has been received?
- Q2. What should be done if there is a lack of understanding or any confusion?
- Q3. Who may receive a response in the communication process?

ANTICIPATED ANSWERS

- A1. Interpreting is the next step.
- A2. Questions should be asked.
- A3. The response may be to the sender or it may be to another person or a group in order to act on the message.

Teaching Point 4

Identify the Barriers to Effective Communication

Time: 10 min

Method: Interactive Lecture

BARRIERS TO COMMUNICATION

When sending a message, the sender must understand that there are barriers to communication—ways in which communicating can lead to misinterpretation. In order to communicate effectively, these barriers must be overcome or managed. Keep in mind that the real communication is the message others receive, not the message intended.

When the receiver has to overcome barriers to communication, there may be effects such as:

- defensiveness, confusion, resistance and resentment;
- dependency on others to explain and inform;
- withdrawal from conversations;
- feelings of defeat or inadequacy; or
- decreased likelihood of problem solving.

Barriers to communication can be divided into three categories: intrapersonal factors, distraction factors and delivery factors.

Intrapersonal Factors

The following barriers to communication are intrapersonal factors:

- **Stress.** When feeling the effects of stress, both the sender and the receiver may easily lose focus of the goal of the message. When experiencing stress, it may be difficult for a person to concentrate on messages.
- **Emotion.** When the sender of a message has high emotion, such as worry, fear or even excitement, the intent of the message may be lost. When the receiver has strong, negative emotions about the sender or disagrees with the message, interpreting may be difficult.
- **Misinterpretation.** The meaning of the message may be misinterpreted by the receiver. Sometimes a word can mean two different things and different words have different meanings for different people. When the sender uses complex words, they must ensure that the receiver is capable of understanding them. Be aware that a person may use a particular word in a different way than others understand it.
- **Poor Listening Habits.** When the receiver has poor listening habits, the meaning and intent of the message may be lost. It is important for the sender to look for cues to make sure that receivers are listening and paying attention.
- **Closed-Mindedness.** People sometimes only hear what they want to hear. When new ideas or change are brought to a situation, some people may have a difficult time accepting the message.
- **Prejudice.** Prejudice can occur between the sender and receiver. When the ability to understand is questioned or the intent is misjudged due to preconceived opinions, the effectiveness of the message may be weakened.

Distraction Factors

The following barriers to communication are distraction factors:

- **Visual.** When sending or receiving a message, it is easy to become distracted by sights in the area. Even when the participants seem extremely focused, seeing something out of the corner of the eye can distract and confuse them.
- **Auditory.** Noise is also a distraction when sending or receiving a message. When noise occurs, participants can become distracted and confused. The sender may have to stop sending the message, wait for the noise to stop and then begin to send again. It is important that the receivers have an environment free of distractions.

Delivery

The following barriers to communication are delivery factors:

- **Language.** The language a person speaks may have a significant affect on the effectiveness of a message. Trying to understand a message that is being sent in another language is extremely difficult. Also, when a person uses complex wording to explain a concept, meaning can be lost. Using simple language to explain concepts will ensure that everyone understands the message and will avoid possible confusion.
- **Mixed Messages.** Mixed messages occur when the sender sends a variety of messages, all indicating different ideas or meanings. Mixed messages may be interpreted through body language and tone of voice used by the sender. If the receiver interprets mixed messages, the intent of the message may become lost.
- **Overload.** When bombarded with information, understanding a message is difficult. When given extra information, the receiver has to sort through and pick out the key pieces. Being overloaded may cause a person to hear only part of a message or distort a message. As a sender, only send the information that the receiver needs to know.

Teaching Point 5**Conduct an Activity That Demonstrates the Barriers to Effective Communication**

Time: 15 min

Method: In-Class Activity

ACTIVITY**OBJECTIVE**

The objective of this activity is to have the cadets experience barriers to communication.

RESOURCES

- Stopwatch,
- Paper,
- Scissors,
- Resealable plastic bags (one per two cadets),
- Envelopes (one per two cadets), and
- Communication puzzle located at Annex D (one per cadet).

ACTIVITY LAYOUT

Set up an area in which the cadets can sit back to back.

ACTIVITY INSTRUCTIONS

1. Divide the cadets into pairs. Within each pair, have the cadets decide who will be “A” and who will be “B”.
2. Explain to the cadets that they will have to sit back to back. Cadet “A” will have to try to get cadet “B” to use cut-out shapes to replicate the given design. There will be three rounds consisting of:
 - (a) During the first round, only Cadet “A” can speak.
 - (b) During the second round, Cadet “B” may ask questions but Cadet “A” can only answer with yes or no.
 - (c) In the third round, both cadets may speak freely.



If at any time the cadets think that the puzzle has been solved, Cadet “A” may look at their partner’s puzzle. If correct, Cadet “A” should rotate (turn) the puzzle so that it is different from previous tries and begin again until time has run out.

3. Distribute the puzzle in an envelope to each Cadet “A”. Distribute the cut-out pieces in a resealable bag to each Cadet “B”.
4. Have the cadets sit back to back and begin the first round. Start the stopwatch.



If there is enough room, have all of the “A” cadets face one direction and all of the “B” cadets face the opposite direction to ensure that none of the “B” cadets can see another cadet’s puzzle.

5. After three minutes, stop the cadets. Have them begin the second round. Start the stopwatch.
6. After three minutes, stop the cadets. Have them begin the third round. Start the stopwatch.
7. After three minutes, have the cadets compare puzzles with other pairs.
8. Bring the cadets together for a debriefing. Ask questions such as:
 - (a) Why was it frustrating not being able to fully communicate throughout the activity?
 - (b) What communication did you have to try to overcome during the activity?
 - (c) Can you think of a real-life situation in which you were trying to solve a problem but did not have all of the “pieces” needed? What would have changed in that situation if you had received more information or if others had communicated more clearly?
 - (d) What happens when one team member has a specific goal in mind but cannot clearly communicate it to the team? How can the team improve the way information is communicated?

SAFETY

N/A.

CONFIRMATION OF TEACHING POINT 5

The cadets participation in the in-class activity will serve as the confirmation of this TP.

END OF LESSON CONFIRMATION

The cadets participation in the in-class activity will serve as the confirmation of this lesson.

CONCLUSION

HOMEWORK/READING/PRACTICE

N/A.

METHOD OF EVALUATION

N/A.

CLOSING STATEMENT

People communicate everyday as a way to share knowledge, interests, attitudes, opinions, feelings and ideas with others. Communication skills are a fundamental part of leadership because they permit the flow of ideas from you to another person or to a group, and vice versa. Communication skills will increase with experience which is why you should take every opportunity to communicate with others.

INSTRUCTOR NOTES/REMARKS

N/A.

REFERENCES

C0-022 (ISBN 0-02864-207-4) Cole, K. (2002). *The Complete Idiot's Guide to Clear Communication*. Indianapolis, IN: Alpha Books.

- C0-115 (ISBN 0-7879-4059-3) van Linden, J. A., & Fertman, C. I. (1998). *Youth Leadership*. San Francisco, CA: Jossey-Bass Inc., Publishers.
- C0-144 (ISBN TBA) Colver, E., & Reid, M. (2001). *Peacebuilders 2: Peer Helping*. Ottawa, ON: YouCAN.
- C0-237 (ISBN 0-19-541816-6) Barber, K. (Ed.). (2004). *Canadian Oxford Dictionary* (2nd ed.). Don Mills, ON: Oxford University Press Canada.
- C0-262 MacDonald, K. (2002). *Interpersonal Conflict Resolution Skills for Youth. Module 1: Fundamentals of Conflict Resolution*. New Westminster, BC: Centre for Conflict Resolution.
- C0-268 (ISBN 1-57542-265-4) MacGregor, M. (2008). *Teambuilding With Teens: Activities for Leadership, Decision Making and Group Success*. Minneapolis, MN: Free Spirit Publishing, Inc.

THIS PAGE INTENTIONALLY LEFT BLANK



COMMON TRAINING
PHASE THREE
INSTRUCTIONAL GUIDE



SECTION 5
EO M303.05 – SUPERVISE CADETS

Total Time:

60 min

PREPARATION

PRE-LESSON INSTRUCTIONS

Resources needed for the delivery of this lesson are listed in the lesson specification located in A-CR-CCP-603/PG-001, Chapter 4. Specific uses for said resources are identified throughout the instructional guide within the TP for which they are required.

Review the lesson content and become familiar with the material prior to delivering the lesson.

PRE-LESSON ASSIGNMENT

N/A.

APPROACH

An interactive lecture was chosen for TPs 1 and 2 to introduce the cadets to supervision.

A group discussion was chosen for TPs 3 and 4 as it allows the cadets to interact with their peers and share their knowledge, experiences, opinions and feelings about supervision.

INTRODUCTION

REVIEW

N/A.

OBJECTIVES

By the end of this lesson the cadet shall be expected to supervise cadets.

IMPORTANCE

It is important for cadets to understand the purpose of supervision and how to supervise because effective supervision is a fundamental element of becoming a leader. Phase Three cadets will be expected to supervise their teams while conducting leadership assignments.

Teaching Point 1**Explain the Purposes of Supervision**

Time: 10 min

Method: Interactive Lecture

THE PURPOSES OF SUPERVISION

There are three main purposes of supervision.

To Provide Protection. Supervision ensures the safety and well-being of personnel.



Safety is the number one issue in every aspect of the Cadet Program. When situations are not safe, they are stopped immediately.



CATO 14-31, *Director Cadets and Junior Canadian Rangers General Safety Program*, outlines the requirements for a general safety program that must be incorporated in every aspect of cadet activities.

To Provide Support. Supervision ensures that all members of the team are assisted, provided for and encouraged during tasks. If cadets are not practicing intrapersonal management, interpersonal management, teamwork and effective communication, the supervisor must act on the situation.

To Provide Quality Assurance. Supervision ensures the outcomes of a task meet expectations for that task. If cadets are not meeting their responsibilities in completing the task, the supervisor must act on the situation.



No one likes to be over-supervised. It is important to not micromanage your team.

CONFIRMATION OF TEACHING POINT 1

QUESTIONS

- Q1. What are the purposes of supervision?
- Q2. How does supervision provide support?
- Q3. How does supervision provide quality assurance?

ANTICIPATED ANSWERS

- A1. The purposes of supervision are to provide protection, to provide support and to provide quality assurance.
- A2. Supervision ensures that all members of the team are assisted, provided for and encouraged during tasks.
- A3. Supervision ensures outcomes of a task meet expectations for that task.

Teaching Point 2**Explain How to Supervise**

Time: 10 min

Method: Interactive Lecture

HOW TO SUPERVISE

As team leaders, cadets will be expected to supervise others. Supervision takes place during the entire task, not just at the beginning or end of the task. Although each situation where supervision takes place is unique, there are some basic responsibilities that must be fulfilled. Team leaders shall meet these responsibilities by:

Ensuring Safety. Ensuring that every situation in the Cadet Program is carried out in a safe manner is the primary concern of all members involved.

Ensuring the Well-Being of Cadets. The welfare of cadets within the Cadet Program is a primary concern in the execution of all training and administrative tasks.

Encouraging Cadets. Encourage cadets to produce satisfactory work because they want to. Inspiring results through praise creates a positive outcome.

Adjusting Responsibilities as Required. Being able to adjust a cadet's responsibilities during tasks is important. Cadets with experience may need less supervision and may be given extra responsibilities.

Maintaining Control of Cadets. Keep cadets on task while they are producing satisfactory work. An effective supervisor will be able to keep cadets focused.

Correcting Errors as Required. If mistakes are made, effective supervisors will communicate this. They will revise what and how it needs to be done and remedy errors.

Reporting Misconduct as Required. When cadets behave in a manner that is inconsistent with the core leadership qualities of a cadet, these behaviours should be reported up the chain of command.

Ensuring Completion of Responsibilities Assigned to Cadets as Required. When supervisors delegate or assign tasks to others, it is the supervisor's responsibility to ensure all delegated tasks are completed.



Successful supervisors are usually successful leaders.

CONFIRMATION OF TEACHING POINT 2

QUESTIONS

- Q1. When does supervision take place?
- Q2. List the supervision responsibilities that a team leader should meet.
- Q3. What is the primary concern of all members involved in the Cadet Program?

ANTICIPATED ANSWERS

- A1. Supervision takes place during the entire task, not just at the beginning or end of the task.
- A2. The supervision responsibilities that a team leader should meet are:
- ensuring safety;
 - ensuring the well-being of cadets;

- encouraging cadets;
- adjusting responsibilities as required;
- maintaining control of cadets;
- correcting errors as required;
- reporting misconduct as required; and
- ensuring completion of responsibilities assigned to cadets as required.

A3. Ensuring that every situation in the Cadet Program is carried out in a safe manner.

Teaching Point 3**Conduct a Group Discussion on Supervision**

Time: 15 min

Method: Group Discussion

GROUP DISCUSSION

**TIPS FOR ANSWERING/FACILITATING DISCUSSION**

- Establish ground rules for discussion, e.g., everyone should listen respectfully; don't interrupt; only one person speaks at a time; no one's ideas should be made fun of; you can disagree with ideas but not with the person; try to understand others as much as you hope they understand you; etc.
- Sit the group in a circle, making sure all cadets can be seen by everyone else.
- Ask questions that will provoke thought; in other words avoid questions with yes or no answers.
- Manage time by ensuring the cadets stay on topic.
- Listen and respond in a way that indicates you have heard and understood the cadet. This can be done by paraphrasing their ideas.
- Give the cadets time to respond to your questions.
- Ensure every cadet has an opportunity to participate. One option is to go around the group and have each cadet answer the question with a short answer. Cadets must also have the option to pass if they wish.
- Additional questions should be prepared ahead of time.

SUGGESTED QUESTIONS

- Q1. What do you think the responsibilities of an effective supervisor are? Are they different from the list in TP 2?
- Q2. Which responsibility is the most important? Why?
- Q3. Which responsibility is used the least? Why?
- Q4. List some examples where you have seen leaders use the various responsibilities.



Other questions and answers will develop throughout the group discussion. The group discussion should not be limited to only those suggested.



Reinforce those answers given and comments made during the group discussion, ensuring the teaching point has been covered.

CONFIRMATION OF TEACHING POINT 3

The cadets' participation in the group discussion will serve as the confirmation of this TP.

Teaching Point 4

Discuss the Supervision Requirements at the Corps

Time: 15 min

Method: Group Discussion



The point of the group discussion is to draw information about supervision at the corps from the group using the tips for answering/facilitating discussion and the suggested questions provided.

Cadets are supervised in various locations at the corps. These locations may include stairways, doorways, hallways, parade square, classrooms, canteen, etc. They are supervised to provide protection and support for cadets and quality assurance during the task.

GROUP DISCUSSION



TIPS FOR ANSWERING/FACILITATING DISCUSSION

- Establish ground rules for discussion, e.g., everyone should listen respectfully; don't interrupt; only one person speaks at a time; no one's ideas should be made fun of; you can disagree with ideas but not with the person; try to understand others as much as you hope they understand you; etc.
- Sit the group in a circle, making sure all cadets can be seen by everyone else.
- Ask questions that will provoke thought; in other words avoid questions with yes or no answers.
- Manage time by ensuring the cadets stay on topic.
- Listen and respond in a way that indicates you have heard and understood the cadet. This can be done by paraphrasing their ideas.
- Give the cadets time to respond to your questions.
- Ensure every cadet has an opportunity to participate. One option is to go around the group and have each cadet answer the question with a short answer. Cadets must also have the option to pass if they wish.

- Additional questions should be prepared ahead of time.

SUGGESTED QUESTIONS

- Q1. Name some locations around the corps where the cadets will need to be supervised for safety reasons.
- Q2. How will you supervise these areas?
- Q3. Is supervision of cadets different in these areas than in the rest of the building?
- Q4. How will you supervise the areas in the rest of the building?
- Q5. Is supervision of cadets different when they are not in the building?
- Q6. Give some examples of how to encourage cadets during supervision.
- Q7. Give some examples of misconduct that you would report up the chain of command.



Other questions and answers will develop throughout the group discussion. The group discussion should not be limited to only those suggested.

Reinforce those answers given and comments made during the group discussion, ensuring the teaching point has been covered.

CONFIRMATION OF TEACHING POINT 4

The cadets' participation in the group discussion will serve as the confirmation of this TP.

END OF LESSON CONFIRMATION

The cadets' participation in the group discussions will serve as the confirmation of this lesson.

CONCLUSION

HOMEWORK/READING/PRACTICE

N/A.

METHOD OF EVALUATION

This EO is assessed IAW A-CR-CCP-603/PG-001, Chapter 3, Annex B, Appendix 1 (303 PC).

CLOSING STATEMENT

Successful supervisors are usually successful leaders. Supervisors safeguard others, encourage others, and empower others to use their skills, expertise and ideas to produce results.

INSTRUCTOR NOTES/REMARKS

N/A.

REFERENCES

- A0-107 Director Cadets 5. (2007). CATO 14-31, *Director Cadets and Junior Canadian Rangers General Safety Program*. Ottawa, ON: Department of National Defence.
- C0-249 (ISBN 0-7894-2890-3) Heller, R. (1998). *How to Delegate*. New York, NY: DK Publishing, Inc.
- C0-272 Coleridge Education, College of St. Mark and St. John. (2002). *A Consultation of Supervision Provision and Training Requirements Across Connexions Partnerships in England*. Retrieved March 17, 2008 from <http://www.connexions.gov.uk/partnerships/publications/uploads/cp/Supervisory%20Skills%20Exec%20Sum.pdf>.
- C0-273 (ISBN 978-1-56414-363-1) Ladew, D. P. (1998). *How to Supervise People: Techniques for Getting Results Through Others*. Franklin Lakes, NJ: Career Press.
- C0-274 (ISBN 1-4134-1294-7) Sargent, G. (2003). *The Little Black Book of Supervision*. USA: Xlibris Corporation.

THIS PAGE INTENTIONALLY LEFT BLANK



COMMON TRAINING
PHASE THREE
INSTRUCTIONAL GUIDE



SECTION 6
EO M303.06 – SOLVE PROBLEMS

Total Time:

60 min

PREPARATION

PRE-LESSON INSTRUCTIONS

Resources needed for the delivery of this lesson are listed in the lesson specification located in A-CR-CCP-603/PG-001, Chapter 4. Specific uses for said resources are identified throughout the instructional guide within the TP for which they are required.

Review the lesson content and become familiar with the material prior to delivering the lesson.

Photocopy the problem-solving scenarios located at Annex E.

PRE-LESSON ASSIGNMENT

N/A.

APPROACH

An interactive lecture was chosen for TPs 1–3 to review logical analysis and orient the cadets to additional problem-solving methods.

An in-class activity was chosen for TP 4 as an interactive way to provoke thought and stimulate interest among cadets about problem solving.

INTRODUCTION

REVIEW

N/A.

OBJECTIVES

By the end of this lesson the cadet shall have solved problems.

IMPORTANCE

One important skill that a team leader must have is the ability to solve problems. As cadets become team leaders, they will use this skill more often. Cadets have a greater chance of success in solving problems if they have a variety of problem-solving methods from which to choose.

Teaching Point 1**Review the Steps for Logical Analysis**

Time: 5 min

Method: Interactive Lecture

LOGICAL ANALYSIS

The eight steps in logical analysis were taught in the previous year. They are:

1. confirming the task;
 2. identifying the problem;
 3. determining the critical factor;
 4. developing alternative solutions;
 5. comparing alternative solutions;
 6. determining the best solution;
 7. implementing the solution; and
 8. evaluating the plan and the implementation.
-

CONFIRMATION OF TEACHING POINT 1

QUESTIONS

- Q1. What is the first step in logical analysis?
Q2. What is the third step in logical analysis?
Q3. What is the last step in logical analysis?

ANTICIPATED ANSWERS

- A1. Confirming the task.
A2. Determining the critical factor.
A3. Evaluating the plan and the implementation.
-

Teaching Point 2**Explain the Steps in the IRISE Method of Problem Solving**

Time: 10 min

Method: Interactive Lecture



The IRISE method of problem solving is much like logical analysis but has fewer steps to remember.

The IRISE method of problem solving was developed for adolescents.

IRISE is an acronym. The IRISE method of problem solving has five steps. They are:

1. **Identifying the Problem.** To be able to solve a problem, cadets must understand what the problem really is. If the problem is not clearly identified, a problem may be solved but it may not be the “real” problem. Questions that should be asked in step one include:

- What do we wish to accomplish?
 - How much time will we need?
 - What resources do we have?
 - What resources do we need?
2. **Researching all of the Options.** This step involves “brainstorming” options to solve the problem. Cadets will have to research each option. Some options will need to be discussed outside the team and some options will need to be critically and methodically investigated. There will be some options which will solve the problem easily and some options will be more difficult. Some questions may need to be asked, such as:
 - Which option is the simplest?
 - Which option is the safest?
 - What is the worst possible outcome?
 - Which option is the most flexible?
 - Which option uses available resources in the most economical manner?
 3. **Identifying the Consequences of the Options.** Each option will have consequences. Ensuring the cadets know what the consequences may be before putting a decision into action, may help to eliminate options with undesirable consequences. There may be consequences to options that will not be known, but these should be very limited.
 4. **Selecting the Most Appropriate Option.** This is the step where the option is selected and implemented. Once an option is selected, a plan for implementation should be created. It is now time to put the plan into action.
 5. **Evaluating the Decision.** Once the plan is implemented, evaluate the decision. Examine the implementation of the option and the needs that may not have been anticipated. Questions may include:
 - Was the option a good one?
 - Was the plan to implement the option a success?
 - What can we do to improve the plan or the implementation for the next time?
 - What lessons were learned?

CONFIRMATION OF TEACHING POINT 2

QUESTIONS

- Q1. For whom was the IRISE method of problem solving developed?
- Q2. The IRISE method of problem solving is similar to what other method of problem solving?
- Q3. What are the steps in the IRISE method of problem solving?

ANTICIPATED ANSWERS

- A1. For adolescents.
- A2. Logical analysis.
- A3. The steps in the IRISE method of problem solving are:

- (1) identifying the problem;
- (2) researching all of the options;
- (3) identifying the consequences of the options;
- (4) selecting the most appropriate option; and
- (5) evaluating the decision.

Teaching Point 3

Explain the Steps in the TEACH Method of Problem Solving

Time: 10 min

Method: Interactive Lecture



The TEACH method of problem solving is much like the IRISE method, which is like logical analysis.

The TEACH method of problem solving was developed for a team approach. The TEACH method of problem solving is another situation where positive team dynamics should be displayed.

TEACH is an acronym. The TEACH method of problem solving has five steps. They are:

1. **Time.** This first step involves spending time to discover the real issue or problem. With the assistance of the team the “real” problem must be identified. Questions that should be asked in the “time” step should be the same as the identifying the problem questions for the IRISE method.
2. **Exposure.** This second step involves uncovering what others have done in a similar situation. By using information gathered from others, the number of options that may be created to solve the problem should increase.
3. **Assistance.** This third step involves having your team study all the information from different perspectives. The team will be a great asset because differing views, based on knowledge and experience of the same issue, will lead to a better result and a more collaborative environment.
4. **Creativity.** This fourth step involves having the team “brainstorm” options and the consequences of those options. Again, the team will be a great asset because of differing views based on knowledge and experience.
5. **Hit it.** This last step involves implementing the best option. The team will help develop a plan to implement the selected option. After the option has been implemented, evaluation of the option and its implementation will need to take place. Questions to evaluate the implementation should be the same as the IRISE method of problem solving.

CONFIRMATION OF TEACHING POINT 3

QUESTIONS

- Q1. For what kind of approach was the TEACH method of problem solving developed?
- Q2. The TEACH method of problem solving is much like what other method of problem solving?
- Q3. List the five steps to the TEACH method of problem solving.

ANTICIPATED ANSWERS

A1. For a team approach.

A2. The IRISE method.

A3. The five steps to the TEACH method of problem solving are:

- time,
- exposure,
- assistance,
- creativity, and
- hit it.

Teaching Point 4**Conduct an Activity Where Cadets Will Select a Problem-Solving Method and Apply it to a Scenario**

Time: 25 min

Method: In-Class Activity



Use all four scenarios located at Annex E. Distribute evenly among cadets (e.g., four cadets receive Scenario 1, four cadets receive Scenario 2, three cadets receive Scenario 3 and three cadet receive Scenario 4).

ACTIVITY**OBJECTIVE**

The objective of this activity is for cadets to select a problem-solving method and apply it to a scenario.

RESOURCES

- Scenario, and
- Pen/pencil.

ACTIVITY LAYOUT

N/A.

ACTIVITY INSTRUCTIONS

1. Distribute one scenario to each cadet.
2. Cadets shall choose a problem-solving method and apply its steps to the scenario. Cadets will write down their method and steps on the scenario paper.



Cadets may choose any method to solve the problem including Logical Analysis, IRISE or TEACH.

3. After 10 minutes, have the cadets find everyone else in the class who has the same scenario. Cadets will share their ideas within the group.
4. After 5 minutes, have each group present their scenario to the class with the problem-solving methods and their possible solutions.

SAFETY

N/A.

CONFIRMATION OF TEACHING POINT 4

The cadets' participation in the activity will serve as the confirmation of this TP.

END OF LESSON CONFIRMATION

The cadets' participation in the problem-solving activity will serve as the confirmation of this lesson.

CONCLUSION

HOMEWORK/READING/PRACTICE

N/A.

METHOD OF EVALUATION

This EO is assessed IAW A-CR-CCP-603/PG-001, Chapter 3, Annex B, Appendix 1 (303 PC).

CLOSING STATEMENT

It is important to practice the skill of problem solving. Learning to solve problems is a leadership skill. Cadets have a greater chance of success in solving problems if they have a variety of problem-solving methods to choose from.

INSTRUCTOR NOTES/REMARKS

N/A.

REFERENCES

- C0-115 (ISBN 0-7879-4059-3) van Linden, J. A., & Fertman, C. I. (1998). *Youth Leadership*. San Francisco, CA: Jossey-Bass Inc., Publishers.
- C0-134 (ISBN 0-7852-7440-5) Maxwell, J. (1999). *The 21 Indispensable Qualities of a Leader: Becoming the Person Others Will Want to Follow*. Nashville, TN: Thomas Nelson Publishers.
- C0-135 (ISBN 0-7645-5176-0) Loeb, M., & Kindel, S. (1999). *Leadership for Dummies*. New York, NY: Hungry Minds, Inc.



COMMON TRAINING
PHASE THREE
INSTRUCTIONAL GUIDE



SECTION 7

EO M303.07 – LEAD CADETS THROUGH A LEADERSHIP ASSIGNMENT

Total Time:

60 min

PREPARATION

PRE-LESSON INSTRUCTIONS

Resources needed for the delivery of this lesson are listed in the lesson specification located in A-CR-CCP-603/PG-001, Chapter 4. Specific uses for said resources are identified throughout the instructional guide within the TP for which they are required.

Review the lesson content and become familiar with the material prior to delivering the lesson.

Review the assessment instructions located at A-CR-CCP-603/PG-001, Chapter 3, Annex B, Appendix 1 (303 PC).

Become familiar with the Rearrange Classroom Space leadership assignment located at Annex G.

Make a sketch of the classroom for the Rearrange Classroom Space leadership assignment which will be used throughout the lesson.

Photocopy the Leadership Assignment Format handout located at Annex H for each cadet.

Photocopy the After-Assignment Report and 303 PC Assessment Rubric located at Annex I for each cadet.

Photocopy the Leadership Assignment Assessment Rubric located at A-CR-CCP-603/PG-001, Chapter 3, Annex B, Appendix 1, for each cadet.

Leadership assignments will require different levels of planning and experience from the cadets. Select a leadership assignment for each cadet based on their ability. Ensure the sample stretches located at Annex K are photocopied for those cadets who are completing leadership assignments involving warming up or cooling down muscles.

Photocopy the Leadership Assignment Planning Guide located at Annex M for each cadet.

PRE-LESSON ASSIGNMENT

N/A.

APPROACH

A demonstration was chosen for TPs 1–4 as it allows the instructor to explain and demonstrate the format of a leadership assignment in a safe, controlled environment.

An interactive lecture was chosen for TP 5 to give direction on the procedure for completing an after-assignment report.

An in-class activity was chosen for TP 6 as it is an interactive way to provoke thought and stimulate interest among cadets.

INTRODUCTION

REVIEW

N/A.

OBJECTIVES

By the end of this lesson the cadet shall be expected to lead peers through a leadership assignment.

IMPORTANCE

It is important for cadets to understand the steps involved in completing leadership assignments as they occur many times throughout cadet training. All cadets will be required to complete at least two leadership assignments during Phase Three. When given an assignment, every cadet must know the steps involved for successful completion. An effective leader will merge together all of the pieces learned throughout leadership training, such as solving problems and supervising, to successfully lead a team through an assignment.



During Phase Three, each cadet will be required to complete at least two leadership assignments. A list of Possible Year Three Leadership Assignments is located at Annex F.

Teaching Point 1

Discuss and Demonstrate the Process of Preparing for a Leadership Assignment

Time: 10 min

Method: Demonstration



Discuss the aspects of preparing for a leadership assignment.

Use the sample leadership assignment located at Annex G to demonstrate the preparation stage.

Distribute copies of the Leadership Assignment Format handout located at Annex H and the After-Assignment Report and the 303 PC Assessment Rubric located at Annex I to each cadet. Distribute copies of the Leadership Assignment Planning Guide located at Annex M. Encourage the cadets to view each section as it is explained throughout this lesson.

PREPARE FOR A LEADERSHIP ASSIGNMENT

Ensure the Goal Is Understood

Always ask questions to the directing staff, especially when there is doubt about any portion of the assignment. Before spending any time planning, the leader must ensure that what they think needs to happen is actually the goal of the assignment.

Ensure the Required Resources are Available

Make sure that all the resources required to complete the assignment are available. Complete a reconnaissance by looking around the area. Try to locate other resources that may be used. If boundaries have been determined, locate them.

Complete a Time Appreciation

Be aware of the time given for the completion of the assignment. If the assignment must be broken down into stages, the leader must determine how much time must be allocated to each. Sometimes tasks can be done concurrently, which will save time in the end.

When completing a time appreciation, check the time. All members involved in the assignment must be aware of the current time and the expected time of completion.

Make a Plan

Using the planning guide (located at Annex M), make a plan to accomplish the goal of the assignment by:

- determining the tasks that need to be completed;
- developing a process to accomplish all tasks; and
- allocating resources.

The plan will include the answers to who, what, when, where, how and why. Who will do what? Who does it involve? What is going to be done? When does it start? When does it end? Where will it take place? How will it take place? Why must it be done? What will happen if it is not done?



Tasks can be assigned to individuals or teams. All members must have something to do.



If the leader is given an unfamiliar assignment, ask questions to the directing staff to help clarify. If the leader has no experience with what is involved in the assignment, they may also ask a fellow cadet to clarify and then continue to make the plan. The more complex tasks may go to a cadet who has had previous experience with the requirements of the assignment.



A sample process for preparing the “Rearrange Classroom Space” leadership assignment could be:

1. Read the assignment.
2. Ask a question or two to ensure the assignment is understood. For example, “Which way will the classroom face?” or “So I can use more than four cadets?”
3. Look around the area to make sure all of the required resources are available.
4. Complete a time appreciation by checking and analyzing the time. For example, it will take three minutes to prepare and introduce the assignment, it will take approximately five minutes to complete the assignment and it will take approximately two minutes to carry out a debriefing.
5. Make a plan for the completion of the leadership assignment. The plan could include:
 - (a) dividing the team members into three teams (Team A, Team B and Team C);

- (b) showing a brief sketch of what the classroom should look like at the end of the assignment;
- (c) assigning Team A to rearrange the chairs;
- (d) assigning Team B to rearrange the desks/tables; and
- (e) assigning Team C to put the whiteboard and any electronic equipment in place.

CONFIRMATION OF TEACHING POINT 1

QUESTIONS

- Q1. How can the leader make sure the goal is understood?
- Q2. What must be considered when completing a time appreciation?
- Q3. When making a plan, what must the leader do in order to accomplish the goal of the assignment?

ANTICIPATED ANSWERS

- A1. Ask questions to the directing staff.
- A2. Be aware of the time given for the completion of an assignment. If the assignment must be broken down into stages, the leader must determine how much time must be allocated to each. Sometimes tasks can be done concurrently, which will save time in the end.
- A3. The leader must determine all tasks, develop a process to accomplish all tasks and allocate resources.

Teaching Point 2

Discuss and Demonstrate the Process of Introducing a Leadership Assignment

Time: 10 min

Method: Demonstration



Discuss the aspects for introducing a leadership assignment.

Use the sample leadership assignment located at Annex G to demonstrate the introduction stage.

INTRODUCE A LEADERSHIP ASSIGNMENT



When giving the introduction, the leader must ensure they have the attention of all of the team members. If one cadet is not paying attention, it could affect the end state of the leadership assignment.

When introducing a leadership assignment, the leader must speak loudly, clearly and concisely, to let everyone know that they have faith in their plan. A leader who speaks with authority will capture the attention of team members and make them want to participate in the assignment.

State the Assignment to be Completed

Tell the team members the “big picture” of what is going to be done.



This statement could simply include the title of the leadership assignment.

State the Goal of the Assignment

What is the end state? If there is a reason for completing the assignment (e.g., a guest speaker is coming, to begin summer biathlon, etc) it should be stated. If a sketch is included, it should be shown here so that everyone has a sense of what the result should be. When stating the goal, time requirements should be included.

Identify the Resources Required for the Assignment

Ensure that all of the cadets are aware of the resources that are required to complete the assignment and where these resources are located.

Communicate the Overall Plan

Explain how the assignment will be conducted. All members should know what is to be done, but will find out what their specific part is in another step. If boundaries exist, include them in the plan.

Assign Tasks to Team Members as Applicable

Assign all team and individual tasks needed to complete the assignment. Every member must have something to do.

Ensure the Team Members Understand the Assignment

Ask the team if they have any questions. The leader should also ask a few questions to various members of the team to ensure comprehension. When members are given specific tasks, it is extremely important that they are completely aware of what is expected of them.



Asking “What are you going to do?” is more effective than “Do you understand?”

Never ask yes/no questions when ensuring that team members understand the assignment. Some may be too embarrassed or timid to admit that they do not completely understand, which will jeopardize the effectiveness of the plan.



After the introduction stage, all of the cadets should know where they fit into the overall plan and how, by working together, they will accomplish much more than they could as individuals.



A sample introduction for the “Rearrange Classroom Space” leadership assignment could be:

1. “Today we will be rearranging this classroom space for a guest speaker presentation.”
2. “The goal of this assignment is to rearrange the classroom by turning it around to face the opposite direction. We have five minutes to complete the assignment once we begin.” Show the sketch to the cadets.
3. “Resources required include chairs, tables, a whiteboard and a liquid crystal display (LCD) projector.”
4. “In order to turn the classroom around, the team will be divided into three teams; A, B and C. One team will be in charge of chair placement, another in charge of table

placement and the other in charge of whiteboard and LCD projector placement. Each team will complete their task concurrently.”

5. Divide the cadets into three teams.
6. “Team A will rearrange the chairs, Team B will rearrange the tables and Team C will put the whiteboard and LCD projector in place.”
7. Ask two or three cadets to state what their task is to ensure understanding.

CONFIRMATION OF TEACHING POINT 2

QUESTIONS

- Q1. What are the steps to introduce a leadership assignment?
- Q2. What is the goal of the assignment?
- Q3. How can the leader make sure team members understand the assignment?

ANTICIPATED ANSWERS

- A1. The steps are:
- state the assignment to be completed;
 - state the goal of the assignment;
 - identify the resources required for the assignment;
 - communicate the overall plan;
 - assign tasks to team members as applicable; and
 - ensure the team members understand the assignment.
- A2. The end state.
- A3. Ask the group if they have any questions. The leader should also ask a few questions to various members of the team.

Teaching Point 3

Discuss and Demonstrate the Process of Conducting a Leadership Assignment

Time: 10 min

Method: Demonstration



Discuss the aspects of conducting a leadership assignment.

Use the sample leadership assignment located at Annex G to demonstrate the conducting stage.

CONDUCT A LEADERSHIP ASSIGNMENT

Supervise Peers

When an assignment is being conducted, the leader must constantly supervise the team members. The most important aspect of supervision is to ensure that the assignment is being conducted safely. If cadets are completing aspects of the assignment unsafely, stop the task immediately.

The cadets must remain focused on the goal. If mistakes occur, correct them as soon as possible. If members are experiencing difficulty, take time to reanalyze and reassign tasks. Asking questions throughout the completion of the assignment will ensure that all team members remain focused and that those (if any) who are experiencing difficulty are identified.

Maintain Team Control

Ensure that all team members understand that the leader is in charge and that everyone is following the plan laid out in the introduction stage. When members are not completing what was asked of them, correct it immediately.

A way to maintain team control is to motivate throughout the task and encourage team members to motivate each other. This will help create a positive environment.

Ensure the Assignment Is Progressing According to the Time Allotted

Keep checking the time. If tasks are not being completed as planned, whether too slow or too fast, the plan may need to be reanalyzed.

Modify the Plan as Required

If the plan is not working, take time to modify it. If help is required from team members, ask for it. Changing aspects of the plan partway through the assignment may benefit the outcome; however always keep time limits in mind. Once a new plan has been developed, have the team stop what they are doing, communicate the new plan to the members and then have them implement it.



A sample process for conducting the “Rearrange Classroom Space” leadership assignment could be:

1. Have the cadets begin the assignment.
2. Supervise the cadets by walking around, visually inspecting work and ensuring the assignment is being completed safely. Correct any mistakes or errors and ask questions (e.g., “Are you having difficulty with your assigned task?”) to ensure everyone remains focused on the assignment.
3. Ensure the teams are working together toward the same goal.
4. Motivate the cadets throughout the assignment.
5. Check the time occasionally to make sure the assignment is progressing according to the time limits set.
6. Modify the plan as required.

CONFIRMATION OF TEACHING POINT 3

QUESTIONS

Q1. What is the most important aspect of supervision?

Q2. What should the leader do if members are not completing what was asked of them?

Q3. If a plan needs to be modified, what should happen once the new plan has been developed?

ANTICIPATED ANSWERS

A1. The most important aspect of supervision is to ensure that the assignment is being conducted safely.

A2. When members are not completing what was asked of them, correct it immediately.

A3. Once a new plan has been developed, have the team stop what they are doing, communicate the new plan to the members and then have them implement it.

Teaching Point 4

Discuss and Demonstrate the Process of Debriefing a Team Following a Leadership Assignment

Time: 10 min

Method: Demonstration



Use the sample leadership assignment located at Annex G to demonstrate the debriefing stage.

DEBRIEF A TEAM FOLLOWING A LEADERSHIP ASSIGNMENT

Review the Goal

After the completion of a leadership assignment, it is important to review what the goal of the assignment was with the cadets.

Provide Feedback

The leader should first ask for feedback on the assignment from the team. This can be done using general questions about leadership assignments, such as:

- Was there anything learned from the assignment?
- How did you feel about the assignment?
- Was the goal met?
- How did everyone interact during the assignment?
- Were there behaviours that helped and/or hindered the assignment?
- Were there any cadets who were not motivated to participate in the activity? How did this affect the morale of the remainder of the team?
- Were there leaders that emerged within the team?



It is important to know how the cadets felt about their participation in the completion of the assignment.

It is also important to give feedback to the cadets. It is vital for the leader to spend time focusing on how the team worked together to achieve a common goal.

Re-Motivate the Team

The final step in debriefing a team after a leadership assignment has been completed is to re-motivate the cadets. The cadets need to be reminded of the importance of working together to accomplish an assignment.



A sample debriefing for the “Rearrange Classroom Space” leadership assignment could be:

1. Bring all of the cadets together.
2. Review the goal. For example “Great job team, we rearranged the classroom. It looks exactly like the sketch!”
3. Ask feedback questions to the team such as:
 - (a) How did you feel about the completion of the assignment?
 - (b) Were there behaviours that helped and/or hindered the assignment?
 - (c) Were there leaders that emerged within the team?
4. Re-motivate the team by reminding them of the importance of working together to accomplish an assignment.

CONFIRMATION OF TEACHING POINT 4

QUESTIONS

- Q1. What are the three steps of a leadership assignment debriefing?
- Q2. What are some questions that can be asked to get the team to provide feedback?
- Q3. Why is it important to re-motivate the team?

ANTICIPATED ANSWERS

- A1. The three steps of a leadership assignment debriefing:
- reviewing the goal;
 - providing feedback; and
 - re-motivating the team.
- A2. Some questions could include:
- Was there anything learned from the assignment?
 - How did you feel about the assignment?
 - Was the goal met?
 - How did everyone interact during the assignment?
 - Were there behaviours that helped and/or hindered the assignment?
 - Were there any cadets who were not motivated to participate in the activity? How did this affect the morale of the remainder of the team?
 - Were there leaders that emerged within the team?

A3. The cadets need to be reminded of the importance of working together to accomplish an assignment.

Teaching Point 5**Explain the After-Assignment Report**

Time: 5 min

Method: Interactive Lecture



It is important for the cadets to construct their own learning and decide the importance of the assignment that was conducted. This may not be the same for every leader.

AFTER-ASSIGNMENT REPORT

The after-assignment report is a tool for cadets to use to reflect on their performance after completing a leadership assignment. It is used by the cadet (the leader) during the feedback session with the directing staff to help guide the discussion. The feedback session will take place the day after the assignment was completed.

Each cadet will complete an after-assignment report before attending the feedback session for the leadership assignment.

LEADERSHIP ASSIGNMENT ASSESSMENT RUBRIC

The leadership assignment Assessment Rubric is the form the directing staff will use to assess each cadet's performance as a peer leader when conducting a leadership assignment.

Each cadet will be required to complete their own leadership assignment assessment in conjunction with their after-assignment report and bring it to the debriefing. This form will be used as a self-assessment tool for reflection and discussion with the directing staff.



The results that a cadet reveals on the assessment form shall not affect the results given by the directing staff.

CONFIRMATION OF TEACHING POINT 5

QUESTIONS

- Q1. What is the after-assignment report?
- Q2. To whom is the after-assignment report presented?
- Q3. How long after the leadership assignment will the debriefing occur?

ANTICIPATED ANSWERS

- A1. The after-assignment report is a tool for cadets to use to reflect on their performance after completing a leadership assignment. It is used by the cadet (the leader) during the debriefing with the directing staff to help guide the discussion.
- A2. The directing staff.
- A3. The debriefing will take place the day after the assignment was completed.

Teaching Point 6**Discuss How to Plan for a Leadership Assignment**

Time: 5 min

Method: In-Class Activity

ACTIVITY

OBJECTIVE

The objective of this activity is for the cadets to complete the preparation stage of a leadership assignment.

RESOURCES

- Leadership assignments located at Annexes J and L,
- Leadership Assignment Planning Guide located at Annex M, and
- Pen/pencil.

ACTIVITY LAYOUT

N/A.

ACTIVITY INSTRUCTIONS

1. Explain that this step is normally completed directly before the leadership assignment is to be conducted. Time will be given to develop a plan for the leadership assignment when each assignment is given. Both leadership assignments will be conducted at a later time.
2. Distribute a leadership assignment to each cadet.
3. Encourage the cadets to ask questions if the goal is not understood.
4. Tell the cadets to assume that all required resources are available.
5. Ensure the cadets are aware that there are aspects of planning that must still be completed when leading a team through the leadership assignment. For example, questions must still be asked to make sure the goal is understood, resources must still be checked and a time appreciation must still be completed. At this point during the actual leadership assignment, some cadets may wish to revisit/reanalyze the plan developed during this activity.
6. Have the cadets develop a plan to conduct their leadership assignment. The cadets may work in small teams if desired for answering questions and assisting with planning.

SAFETY

N/A.

CONFIRMATION OF TEACHING POINT 6

The cadets' participation in the in-class activity will serve as the confirmation of this TP.

END OF LESSON CONFIRMATION

QUESTIONS

- Q1. What are the five main steps to complete a leadership assignment?

Q2. What is one way to maintain team control?

Q3. What is an after-assignment report?

ANTICIPATED ANSWERS

A1. The five main steps are:

- preparing for the assignment;
- introducing the assignment;
- conducting the assignment;
- debriefing the team; and
- presenting an after-assignment report.

A2. A way to maintain team control is to motivate throughout the assignment and encourage team members to motivate each other. This will help create a positive environment.

A3. The after-assignment report is a tool for cadets to use to reflect on their performance after completing a leadership assignment. It is used by the cadet (the leader) during the debriefing with the directing staff to help guide the discussion.

CONCLUSION

HOMEWORK/READING/PRACTICE

Any cadets who did not complete their plans will be required to complete them as homework.

METHOD OF EVALUATION

This EO is assessed IAW A-CR-CCP-603/PG-001, Chapter 3, Annex B, Appendix 1 (303 PC).

CLOSING STATEMENT

Leadership assignments will occur many times throughout cadet training. When given an assignment, all cadets must know and be comfortable performing the steps involved for successful completion. Being able to combine all of the segments of leadership training such as solving problems and supervising, into one cohesive unit in order to lead a team through an assignment is a special achievement for which all cadets should strive.

INSTRUCTOR NOTES/REMARKS

N/A.

REFERENCES

- C0-114 (ISBN 0-02-863656-2) Pell, A. R. (1999). *The Complete Idiot's Guide to Team Building*. Indianapolis, IN: Alpha Books.
- C0-240 (ISBN 0-934387-05-2) Collard, M. (2005). *No Props: Great Games With No Equipment*. Beverly, MA: Project Adventure, Inc.
- C0-243 Clark, D. (2007). *After Action Reviews*. Retrieved February 21, 2008, from <http://www.nwlink.com/~donclark/leader/leadaar.html>.
- C0-243 Clark, D. (2007). *Leadership & Direction*. Retrieved February 21, 2008, from <http://www.nwlink.com/~donclark/leader/leaddir.html>.

- C0-245 (ISBN 1-58062-513-4) Adams, B. (2001). *The Everything Leadership Book*. Avon, MA: Adams Media.
- C0-247 (ISBN 0-14-024272-4) Rosen, R. H., & Brown, P. B. (1997). *Leading People*. New York, NY: Penguin Books.
- C0-248 (ISBN 0-7894-4862-9) Heller, R. (1999). *Learning to Lead*. New York, NY: DK Publishing, Inc.
- C0-253 (ISBN 0-7894-8006-9) Bruce, A., & Langdon, K. (2001). *Do it Now!* New York, NY: DK Publishing, Inc.
- C0-254 (ISBN 0-7894-3244-7) Heller, R. (1998). *Communicate Clearly*. New York, NY: DK Publishing, Inc.
- C0-255 (ISBN 0-7645-5408-5) Brounstein, M. (2002). *Managing Teams for Dummies*. Indianapolis, IN: Wiley Publishing, Inc.
- C0-256 (ISBN 0-7894-4863-7) Heller, R. (1999). *Achieving Excellence*. New York, NY: DK Publishing, Inc.

THIS PAGE INTENTIONALLY LEFT BLANK



COMMON TRAINING
PHASE THREE
INSTRUCTIONAL GUIDE



SECTION 8

EO C303.01 – LEAD A TEAM-BUILDING ACTIVITY

Total Time:

90 min

PREPARATION

PRE-LESSON INSTRUCTIONS

Resources needed for the delivery of this lesson are listed in the lesson specification located in A-CR-CCP-603/PG-001, Chapter 4. Specific uses for said resources are identified throughout the instructional guide within the TP for which they are required.

Review the lesson content and become familiar with the material prior to delivering the lesson.

Photocopy one team-building activity per group from the activities located at Annex N for the activity in TP 7.

Photocopy handouts of two team-building activities for each cadet – one activity from Annex O and one from Annex P.

Photocopy two Team-Building Planning Guides located at Annex Q for each cadet.

Photocopy the Self-Assessment Form located at Annex R for each cadet.

Prepare the activity for TP 3 by:

- gathering two colours of sticky notes and a marker;
- writing each consonant of the alphabet (minus Q, X and Z) on one colour of sticky notes (one letter per note);
- writing each vowel on the second colour of sticky notes (one letter per note); and
- ensuring there are enough letters for every cadet (if there are more cadets than letters, create duplicates of common letters [e.g., A, E, N, R, S, T, etc]).

Ensure one or two assistant instructor(s) are available for the activity in TP 7 (depending on the number of cadets).

PRE-LESSON ASSIGNMENT

N/A.

APPROACH

An in-class activity was chosen for TPs 1, 3 and 5 as it is an interactive way to provoke thought and stimulate interest among cadets.

A group discussion was chosen for TPs 2, 4 and 6 as it allows the cadets to interact with their peers and share their knowledge, experiences, opinions and feelings about the components of team-building activities.

A practical activity was chosen for TP 7 as it is an interactive way to allow the cadets to experience team-building activities in a safe and controlled environment.

INTRODUCTION

REVIEW

N/A.

OBJECTIVES

By the end of this lesson the cadet shall have led team-building activities.

IMPORTANCE

It is important for cadets to know how to lead team-building activities to ensure that they are fun, challenging and achievable for every cadet. Each cadet will be given the opportunity to lead two team-building activities. Team-building activities are a great way to relieve boredom, lift team spirit, increase morale, re-energize cadets and accomplish goals. Therefore, every cadet in a leadership role should be able to lead activities focusing on these things. Once an activity that meets the needs of the group has been selected, it is the role of the leader to ensure the activity is completed in a manner that allows the group to learn. A meaningful and enjoyable team-building experience will occur for every cadet when the right activity is conducted in an appropriate fashion.



There are three components to leading a team-building activity. The individual leading a team-building activity should:

- introduce the activity;
- conduct the activity; and
- debrief the cadets on the activity.

To ensure the cadets understand how to lead a team-building activity, they will participate in each component separately as the instructor leads them through a sample team-building activity. Each component will then be discussed as it is completed to ensure understanding.

TPs 1–6 are to be conducted in the following manner:

- In TP 1 the cadets will participate as the instructor introduces a sample team-building activity.
- In TP 2 the cadets will participate in a group discussion that allows them to analyze the elements of an introduction as it was completed in TP 1.
- In TP 3 the cadets will participate as the instructor conducts a sample team-building activity.
- In TP 4 the cadets will participate in a group discussion that allows them to discuss the responsibilities of the leader while conducting a team-building activity as it was completed in TP 3.
- In TP 5 the cadets will participate as the instructor debriefs the cadets on the sample team-building activity conducted in TP 3.

- In TP 6 the cadets will participate in a group discussion that allows them to discuss the elements of a debriefing as it was completed in TP 5.

Teaching Point 1**Demonstrate and Have the Cadets Participate in an Introduction to a Team-Building Activity**

Time: 5 min

Method: In-Class Activity

ACTIVITY**OBJECTIVE**

The objective of this activity is for the cadets to participate in an introduction to a team-building activity as it is led by the instructor.

RESOURCES

N/A.

ACTIVITY LAYOUT

N/A.

ACTIVITY INSTRUCTIONS

1. Get the attention of the cadets. Inform the cadets that they will be participating in an activity called "Alphabet Soup" (***Get the Team's Attention***).
2. Explain that the goal of the team-building activity is to energize the cadets and get them moving (***Explain the Goal of the Activity***).
3. Explain the activity and allow time for the cadets to ask questions for clarification (***Explain the Activity and Assign Tasks as Necessary***), to include:
 - (a) every cadet gets a letter and sticks it to the front of their shirt;
 - (b) the cadets get a few minutes to form appropriate words using at least four letters; and
 - (c) once the cadets get used to forming small words, create longer words or small sentences.
4. Set a time limit of 10 minutes for the activity (***Set Time Limits***).
5. Motivate the cadets to participate in the activity (***Motivate the Team***).

SAFETY

N/A.

CONFIRMATION OF TEACHING POINT 1

The cadets' participation in the introduction to "Alphabet Soup" will serve as the confirmation of this TP.

Teaching Point 2**Have the Cadets Analyze the Elements of an Introduction**

Time: 10 min

Method: Group Discussion

BACKGROUND KNOWLEDGE



The point of the group discussion is to draw the following information from the group using the tips for answering/facilitating discussion and the suggested questions provided.

ELEMENTS OF AN INTRODUCTION**Getting the Team's Attention**

In order to introduce a new activity, the leader must first get the attention of the team. The leader should get the team's undivided attention before continuing to introduce the activity. If one cadet is not paying attention they could miss an important point that could affect their participation in the activity or the activity's outcome.

Explaining the Goal of the Activity

The goal of the activity should be explained to the team in general terms of what will be learned or accomplished. The context of the activity should be explained so the cadets know why their participation is essential and why the activity is a part of the day's agenda. It is important not to give too much detail at this point, as the leader should draw some points on the purpose of the activity from the cadets after the activity's completion.

Explaining the Activity

The activity must be explained to the team prior to participating in the activity. The rules of the activity must be clearly outlined and understood by all cadets prior to commencement. The leader should give step-by-step instructions to ensure the activity is clearly understood.

Assigning Tasks as Necessary

If any specific tasks need to be performed throughout the activity, the leader should assign cadets to these tasks during the introduction of the activity.

Setting Time Limits

The leader is to set a time limit for the cadets to participate in the activity. The leader must factor in time for debriefing the cadets after completion of the activity. The team must be told how long they have to participate in or complete the assigned activity.

Relaying Safety Concerns as Necessary

If there are any safety concerns, the leader must pass these on to the team prior to the start of the activity.

Motivating the Team

Prior to the start of the activity, the leader must motivate the team. The leader should be enthusiastic and share this enthusiasm with the cadets. The goal of the activity is important and there is a reason the activity is being performed. The cadets should be informed of this reason and be motivated toward achieving the goal.

GROUP DISCUSSION



TIPS FOR ANSWERING/FACILITATING DISCUSSION

- Establish ground rules for discussion, e.g., everyone should listen respectfully; don't interrupt; only one person speaks at a time; no one's ideas should be made fun of; you can disagree with ideas but not with the person; try to understand others as much as you hope they understand you; etc.
- Sit the group in a circle, making sure all cadets can be seen by everyone else.
- Ask questions that will provoke thought; in other words avoid questions with yes or no answers.
- Manage time by ensuring the cadets stay on topic.
- Listen and respond in a way that indicates you have heard and understood the cadet. This can be done by paraphrasing their ideas.
- Give the cadets time to respond to your questions.
- Ensure every cadet has an opportunity to participate. One option is to go around the group and have each cadet answer the question with a short answer. Cadets must also have the option to pass if they wish.
- Additional questions should be prepared ahead of time.

SUGGESTED QUESTIONS

- Q1. What was the first thing that was done in the introduction to "Alphabet Soup"? Are there different ways to start a team-building activity? What is the first thing you should do?
- Q2. Should the goal of the activity be explained prior to commencing the activity? Why or why not? Will the activity be as successful if the goal is not explained?
- Q3. Why is it important to inform the cadets how much time they have to complete the activity? When would you tell them how much time they have?
- Q4. During the introduction to "Alphabet Soup" were you motivated to begin the activity? What effect did this have on you? Did it make you more interested in completing the activity?
- Q5. What other considerations should be passed on during an introduction? Should safety concerns be passed on to the team or should they be left to figure them out as they proceed through the activity?



Other questions and answers will develop throughout the group discussion. The group discussion should not be limited to only those suggested.



Reinforce those answers given and comments made during the group discussion, ensuring the teaching point has been covered.

CONFIRMATION OF TEACHING POINT 2

The cadets' participation in the group discussion will serve as the confirmation of this TP.

Teaching Point 3

**Demonstrate and Have the Cadets Participate in the
Selected Team-Building Activity**

Time: 10 min

Method: In-Class Activity

ACTIVITY

OBJECTIVE

The objective of this activity, "Alphabet Soup", is for the cadets to participate in a team-building activity led by the instructor.

RESOURCES

- A large open space,
- Large sticky notes (two different colours), and
- Marker.

ACTIVITY LAYOUT

N/A.

ACTIVITY INSTRUCTIONS

1. Distribute a letter to each cadet.
2. Have the cadets stick the letter to the front of their shirts.
3. Give the cadets approximately three minutes to form small words, using at least four letters.
4. Check the words the cadets have formed.
5. Give the cadets approximately five minutes to form longer words or small sentences.

SAFETY

N/A.

CONFIRMATION OF TEACHING POINT 3

The cadets' participation in "Alphabet Soup" will serve as the confirmation of this TP.

Teaching Point 4**Discuss the Responsibilities of the Leader While Conducting a Team-Building Activity**

Time: 10 min

Method: Group Discussion

BACKGROUND KNOWLEDGE

The point of the group discussion is to draw the following information from the group using the tips for answering/facilitating discussion and the suggested questions provided.

RESPONSIBILITIES OF THE LEADER WHILE CONDUCTING THE ACTIVITY**Start the Activity**

The leader must inform the cadets when to start the activity.

Supervise the Team

Throughout the duration of the activity, the leader must supervise to ensure the following:

- there are no unsafe practices being followed;
- the cadets remain focused on the activity; and
- the rules are being followed.

Ensure the Goal Is Achieved

It is important that the goal of the activity is achieved. If the goal is not achieved, the team-building activity was not successful as a team-building activity, it just became a game. The goal of the activity can sometimes be met without completing the activity. If the goal is not being achieved, the leader may need to:

- refocus the cadets by clarifying the goal of the activity; or
- redirect the activity by modifying the activity to better suit the group.

Stop the Activity if Required

There are a number of reasons why a leader may be required to stop an activity. The most important reason to stop an activity prior to completion is safety. If an activity has become a safety issue, the leader must stop the activity immediately.

An activity may also be stopped if the goal is not being achieved. If the activity is moving away from the goal, the leader must either stop and refocus the cadets, redirect the activity or move on to another point.

An activity may also be stopped if the goal has been achieved prior to the time allotted for its completion. Stopping an activity as it reaches its peak will allow the leader to draw out more specific key points and concepts. Not stopping an activity that has reached its peak will cause the following:

- the energy of the team to drop;
- interest in the goal to be lost; and
- understanding of the goal to be lost.

End the Activity Within the Time Limit

A leader will need to end an activity once the time limit has been met. If the time limit has been met and the activity is not complete, it may be important to attempt the activity at another time. If the purpose of the activity is for the cadets to learn, then it is hard to end an activity until the learning has occurred. If strict time lines are being enforced, the activity can be stopped but it is very important that the leader explain this during the debriefing and perhaps revisit the activity at a later time.

GROUP DISCUSSION



TIPS FOR ANSWERING/FACILITATING DISCUSSION

- Establish ground rules for discussion, e.g., everyone should listen respectfully; don't interrupt; only one person speaks at a time; no one's ideas should be made fun of; you can disagree with ideas but not with the person; try to understand others as much as you hope they understand you; etc.
- Sit the group in a circle, making sure all cadets can be seen by everyone else.
- Ask questions that will provoke thought; in other words avoid questions with yes or no answers.
- Manage time by ensuring the cadets stay on topic.
- Listen and respond in a way that indicates you have heard and understood the cadet. This can be done by paraphrasing their ideas.
- Give the cadets time to respond to your questions.
- Ensure every cadet has an opportunity to participate. One option is to go around the group and have each cadet answer the question with a short answer. Cadets must also have the option to pass if they wish.
- Additional questions should be prepared ahead of time.

SUGGESTED QUESTIONS

- Q1. As the leader of a team-building activity, what do you think some of your responsibilities will be?
- Q2. Throughout the duration of the activity, what do you think is the one thing that every leader must do to ensure safety and progression of the activity?
- Q3. Under what circumstances would an activity have to be stopped? If an activity is stopped prior to its completion, can it be revisited?



Other questions and answers will develop throughout the group discussion. The group discussion should not be limited to only those suggested.



Reinforce those answers given and comments made during the group discussion, ensuring the teaching point has been covered.

CONFIRMATION OF TEACHING POINT 4

The cadets' participation in the group discussion will serve as the confirmation of this TP.

Teaching Point 5

Demonstrate and Have the Cadets Participate in the Debriefing Component of the Selected Team-Building Activity

Time: 5 min

Method: In-Class Activity

ACTIVITY

OBJECTIVE

The objective of this activity is for the cadets to participate in the debriefing of a team-building activity as it is led by the instructor.

RESOURCES

N/A.

ACTIVITY LAYOUT

N/A.

ACTIVITY INSTRUCTIONS

1. Have the cadets gather and refocus their attention after the completion of the activity.
2. Review that the goal of "Alphabet Soup" was to energize the cadets and get them moving.
3. Provide feedback on the activity such as:
 - (a) how the cadets felt about the activity;
 - (b) what the cadets felt they learned from the activity;
 - (c) if the goal was met;
 - (d) if the activity was completed;
 - (e) how the activity could have been conducted differently;
 - (f) how the cadets interacted during the activity; and
 - (g) what behaviours helped and/or hindered the activity.
4. Re-motivate the team by:
 - (a) discussing the meaning of the activity;
 - (b) discussing how the activity and its outcomes relate to the team's everyday interactions; and
 - (c) discussing how the learning can affect the team on a daily basis.

SAFETY

N/A.

CONFIRMATION OF TEACHING POINT 5

The cadets' participation in a debriefing on "Alphabet Soup" will serve as the confirmation of this TP.

Teaching Point 6

Discuss the Elements of a Debriefing

Time: 10 min

Method: Group Discussion

BACKGROUND KNOWLEDGE



The point of the group discussion is to draw the following information from the group using the tips for answering/facilitating discussion and the suggested questions provided.

ELEMENTS OF A DEBRIEFING



It is important during the debriefing to allow the cadets to construct their own learning and decide the importance of the activity that was conducted. This may not be the same for every group.

Reviewing the Goal

After the completion of a team-building activity it is important to review what the goal of that activity was with the cadets. Cadets always want to know why they had to participate in an activity or learn about a specific topic so reinforce why the learning was important.

Providing Feedback

The leader should first ask for feedback from the group on the activity. This can be done through some preset questions specifically about the activity as well as some general questions about team-building activities. It is important to find out how the cadets felt about the activity (e.g., did they feel it was useful, did they learn anything from participating in the activity, etc). The leader will gain valuable insight from the cadets on the activity itself (e.g., if they would use it again, how it could be conducted differently, what elements of the activity they would not change if they did the activity again, etc). The most important information to elicit from the cadets is if they felt the activity was worthwhile in that they learned something valuable by participating.

The leader must also give feedback to the cadets. Whether the goal was met is an important point to focus on during this stage. Why was the goal met or why not? Was the activity completed and did this have an effect on the goal being met?

The leader should also give and get feedback on how the group interacted throughout the duration of the activity. The leader should tell the cadets how they viewed the groups' interactions and ask how the cadets felt they interacted with each other. The leader could ask questions such as:

- Were there leaders that emerged within the group?
- Were there any individuals who did not interact well with others during the activity?
- Was there an individual who was not motivated to participate in the activity? How did this affect the morale of the remainder of the group?

Re-Motivating the Team

The final step in debriefing a group after a team-building activity has been completed is to re-motivate the cadets. The cadets need to be reminded of the importance of team-building activities and be motivated to continue participating in them to achieve new dynamics within a team environment.

GROUP DISCUSSION



TIPS FOR ANSWERING/FACILITATING DISCUSSION

- Establish ground rules for discussion, e.g., everyone should listen respectfully; don't interrupt; only one person speaks at a time; no one's ideas should be made fun of; you can disagree with ideas but not with the person; try to understand others as much as you hope they understand you; etc.
- Sit the group in a circle, making sure all cadets can be seen by everyone else.
- Ask questions that will provoke thought; in other words avoid questions with yes or no answers.
- Manage time by ensuring the cadets stay on topic.
- Listen and respond in a way that indicates you have heard and understood the cadet. This can be done by paraphrasing their ideas.
- Give the cadets time to respond to your questions.
- Ensure every cadet has an opportunity to participate. One option is to go around the group and have each cadet answer the question with a short answer. Cadets must also have the option to pass if they wish.
- Additional questions should be prepared ahead of time.

SUGGESTED QUESTIONS

- Q1. What should a leader do after the completion of a team-building activity? What should be discussed with the group?
- Q2. What is the purpose of reviewing the goal of the activity after completion of the activity?
- Q3. What feedback should be given from the group to the leader? How can this information be obtained? What feedback should the leader give to the group?



Other questions and answers will develop throughout the group discussion. The group discussion should not be limited to only those suggested.



Reinforce those answers given and comments made during the group discussion, ensuring the teaching point has been covered.

CONFIRMATION OF TEACHING POINT 6

The cadets' participation in the group discussion will serve as the confirmation of this TP.

Teaching Point 7

Have Small Groups of Cadets Share Responsibilities of Leading a Team-Building Activity

Time: 30 min

Method: Practical Activity

ACTIVITY

OBJECTIVE

The objective of this activity is for small groups of cadets to share responsibilities of leading a team-building activity.

RESOURCES

- A flat, open space free from obstacles,
- Team-building activity located at Annex N (one per group),
- Resources IAW the chosen team-building activities located at Annex N, and
- Team-Building Planning Guide located at Annex Q (one per group).

ACTIVITY LAYOUT

N/A.

ACTIVITY INSTRUCTIONS



With the help of assistant instructors, observe the partnered groups and offer feedback for Steps 4. to 6.

1. Divide the cadets into an even number of groups (e.g., four groups for 24 cadets or less, six groups for 30 cadets).
2. Distribute a team-building activity and a Team-Building Planning Guide to each group.
3. Allow each group approximately 10 minutes to prepare their activity. Ensure that each cadet has a role to play in conducting their activity.
4. Have each group partner with another group for the presentation of their activity (e.g., Group 1 will conduct their activity with Group 3 and vice versa).
5. Within the partnered groups, have one group conduct their activity with their partnered group. Allow approximately 15 minutes to conduct the activity. Observe and offer feedback on completion.
6. Within the partnered groups, have the second group conduct their activity with their partnered group. Allow approximately 15 minutes to conduct the activity. Observe and offer feedback on completion.

SAFETY

IAW the chosen team-building activities located at Annex N.

CONFIRMATION OF TEACHING POINT 7

The cadets' participation in conducting team-building activities as a member of a small group will serve as the confirmation of this TP.

END OF LESSON CONFIRMATION

The cadets' participation in the activities will serve as the confirmation of this lesson.

CONCLUSION

HOMEWORK/READING/PRACTICE

N/A.

METHOD OF EVALUATION

N/A.

CLOSING STATEMENT

It is important for you to know how to properly lead team-building activities to ensure that they are fun, challenging and achievable for every cadet. Each of you will be given the opportunity to lead two team-building activities. Team-building activities are a great way to relieve boredom, lift team spirit, increase morale, re-energize cadets and accomplish goals. Once an activity that meets the needs of the group has been selected, it is the role of the leader to ensure the activity is completed in a manner that allows the cadets to learn or to elicit learning from the group. A meaningful and enjoyable team-building experience will occur for every cadet when the right activity is conducted in an appropriate fashion.

INSTRUCTOR NOTES/REMARKS

A self-assessment is to be completed when the cadets lead their team-building activity. The self assessment form located at Annex R.

REFERENCES

- C0-028 (ISBN 0-07-046513-4) Newstrom, J., & Scannell, E. (1998). *The Big Book of Team Building Games*. New York, NY: McGraw-Hill.
- C0-238 (ISBN 0-7879-4835-7) Sugar, S., & Takacs, G. (2000). *Games That Teach Teams: 21 Activities to Super-Charge Your Group!*, San Francisco, CA: Jossey-Bass/Pfeiffer.
- C0-240 (ISBN 0-934387-05-2) Collard, M. (2005). *No Props: Great Games With No Equipment*. Beverly, MA: Project Adventure, Inc.
- C0-268 (ISBN 1-57542-265-4) MacGregor, M. G. (2008). *Teambuilding With Teens*. Minneapolis, MN: Free Spirit Publishing Inc.

THIS PAGE INTENTIONALLY LEFT BLANK



COMMON TRAINING
PHASE THREE
INSTRUCTIONAL GUIDE



SECTION 9

EO C303.02 – DELIVER A PRESENTATION ABOUT A LEADER

Total Time:

60 min

PREPARATION

PRE-LESSON INSTRUCTIONS

Resources needed for the delivery of this lesson are listed in the lesson specification located in A-CR-CCP-603/PG-001, Chapter 4. Specific uses for said resources are identified throughout the instructional guide within the TP for which they are required.

Review the lesson content and become familiar with the material prior to delivering the lesson.

Distribute to cadets the outline for delivering a presentation about a leader, located at Annex S, at least two weeks before the presentation is scheduled.

PRE-LESSON ASSIGNMENT

Using the outline for delivering a presentation about a leader located at Annex S, the cadets will research a leader of their choice (a military leader, political leader, spiritual leader, teacher, etc) prior to the lesson.

Cadets will bring to the class presentation materials and information about the leader they researched in order to deliver their presentation.

Ensure cadets are familiar with material from EO M309.01 (Explain the Principles of Instruction, Chapter 9, Section 1), EO M309.03 (Describe Effective-Speaking Techniques, Chapter 9, Section 3), EO M309.04 (Describe Questioning Techniques, Chapter 9, Section 4) and EO M309.05 (Select Appropriate Instructional Aids, Chapter 9, Section 5).

APPROACH

A practical activity was chosen for this lesson as it is an interactive way to allow cadets to experience giving a presentation in a safe and controlled environment. This activity contributes to the development of leadership skills and knowledge in a fun and challenging setting.

INTRODUCTION

REVIEW

N/A.

OBJECTIVES

By the end of this lesson the cadet shall have delivered a presentation about a leader.

IMPORTANCE

It is important for cadets to deliver a presentation about a leader to assist in their leadership development. By researching and reporting on the core leadership qualities of the leader, cadets may gain an appreciation of how others put these qualities into practice. Having to make a presentation will also give the cadets another opportunity to practice their presentation skills.

Teaching Point 1

Supervise Cadets Delivering a Presentation About a Leader

Time: 50 min

Method: Practical Activity



The cadets will research a leader of their choice (a military leader, political leader, teacher, etc) prior to the lesson. Cadets will bring to the class presentation materials and information about the leader they researched in order to deliver their presentation.

ACTIVITY

OBJECTIVE

The objective of this activity is to have cadets deliver a presentation about a leader.

RESOURCES

- Presentation aids (e.g., whiteboard/flip chart/OHP/multimedia projector), and
- Information about the leader.

ACTIVITY LAYOUT

N/A.

ACTIVITY INSTRUCTIONS

1. Have a cadet volunteer to deliver their presentation.
2. The cadet will set up their presentation materials (if required).
3. The cadet will deliver a presentation to include an introduction of the leader, interesting points in the leader's career, the core leadership qualities displayed by the leader, and a conclusion.
4. Cadets will be encouraged to ask questions at the end of each presentation.
5. Repeat steps 1. to 4. until everyone has delivered a presentation.

SAFETY

N/A.

CONFIRMATION OF TEACHING POINT 1

The cadets' participation in the activity will serve as the confirmation of this TP.

END OF LESSON CONFIRMATION

The cadets' participation in the delivery of a presentation will serve as the confirmation of this lesson.

CONCLUSION

HOMEWORK/READING/PRACTICE

N/A.

METHOD OF EVALUATION

N/A.

CLOSING STATEMENT

Seeing and hearing the example set by other leaders may assist the cadet in becoming a more effective leader. Leaders come from all walks of life and learning about how different leaders display core leadership qualities may help cadets further develop their leadership skills. Being given as many opportunities as possible to speak in front of groups will help develop the cadet's presentation and instructional skills.

INSTRUCTOR NOTES/REMARKS

It is recommended that this lesson be scheduled after all other lessons in PO 309 (Chapter 9).

If the corps has more than five Phase Three cadets, divide the cadets into groups of five, if facilities are available.

REFERENCES

N/A.

THIS PAGE INTENTIONALLY LEFT BLANK

LEADERSHIP TEAM MODEL

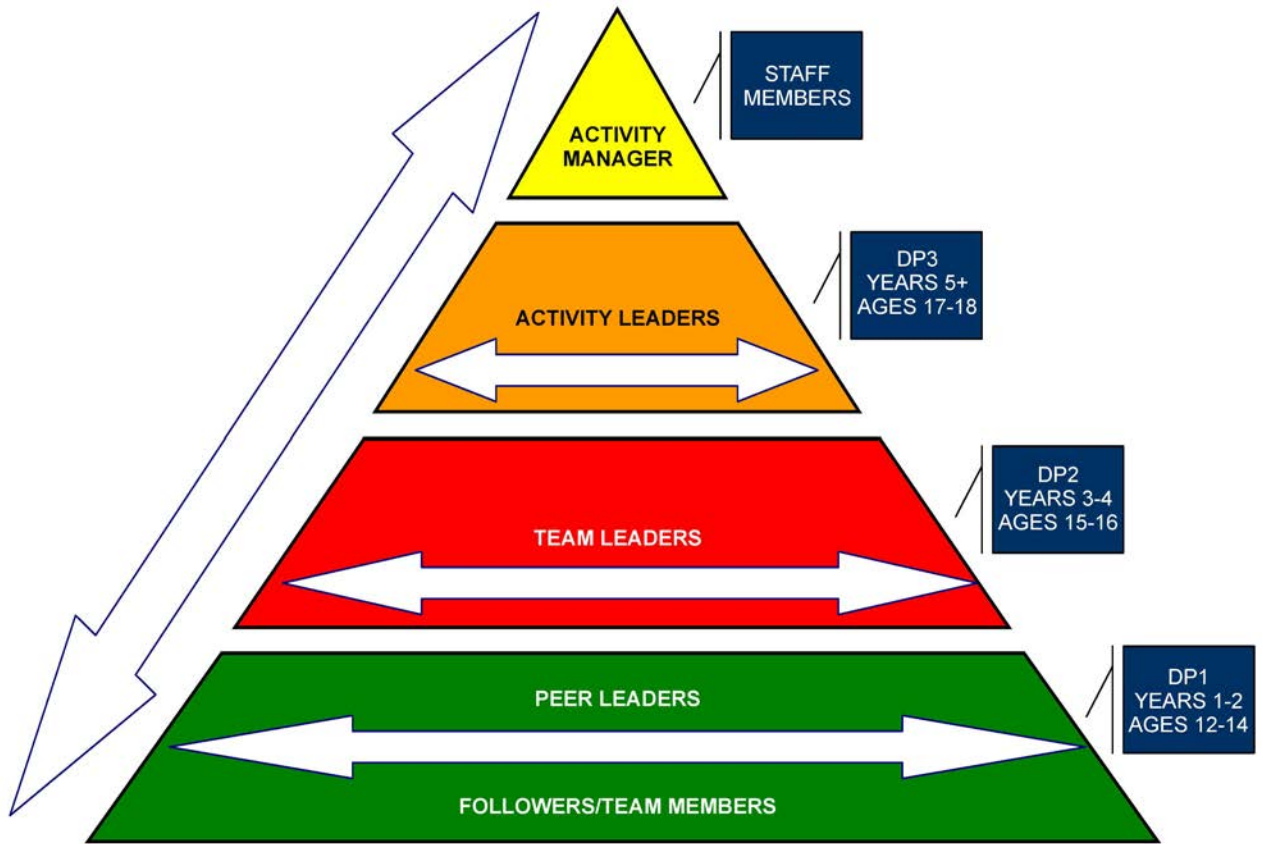

Director Cadets 3, 2008, Ottawa, ON: Department of National Defence

Figure 3A-1 Leadership Team Model

THIS PAGE INTENTIONALLY LEFT BLANK

EXPECTATIONS OF A PHASE THREE CADET

CORE LEADERSHIP COMPETENCIES

Intrapersonal Management
Interpersonal Management
Teamwork
Effective Communication
Applied Leadership
Mentorship

Components of Intrapersonal Management	<ul style="list-style-type: none"> • identifying and satisfying personal needs; • exercising self-control; • exercising self-management; • pursuing self-improvement; and • establishing a positive identity.
Components of Interpersonal Management	<ul style="list-style-type: none"> • interacting positively within the cadet community; • interacting positively with others; and • dealing with interpersonal conflict in a respectful way.
Components of Teamwork	<ul style="list-style-type: none"> • participating in the stages of team development; • displaying positive team dynamics; and • participating in team-building activities.
Components of Effective Communication	<ul style="list-style-type: none"> • receiving information; • interpreting information; and • responding to information.
Components of Applied Leadership	<ul style="list-style-type: none"> • setting an example for others to follow; • participating in leadership assignments; • conducting the leadership assignment while supervising the team; • leading team-building activities; • debriefing the team; and • presenting an after-assignment report to their leader.
Components of Mentorship	<ul style="list-style-type: none"> • fulfilling the role of a mentored cadet; and • fulfilling the role of a mentor.

THIS PAGE INTENTIONALLY LEFT BLANK

SELF-ASSESSMENT RUBRICS

SELF-ASSESSMENT FOR CORE LEADERSHIP QUALITIES OF A CADET

Name: _____ Date: _____

Please rate your core leadership qualities by checking the correct box.

Core Leadership Quality	Never	Seldom	Often	Always
I am honest.				
I am dependable.				
I am loyal.				
I am collaborative.				
I am determined.				
I am courageous.				
I am analytical.				
I am positive.				
I am respectful.				
I am considerate.				
I am sympathetic.				

SELF-ASSESSMENT FOR POSITIVE TEAM DYNAMICS

Name: _____ Date: _____

Please rate your positive team dynamics by checking the correct box.

Positive Team Dynamics	Never	Seldom	Often	Always
I follow the team leader.				
I include all participants.				
I encourage team members.				
I contribute to team morale and esprit de corps.				
I contribute to the accomplishment of team goals.				
I contribute to group decisions.				
I trust the team.				
I support team members.				
I appreciate team members.				
I celebrate team success.				

COMMUNICATION PUZZLE

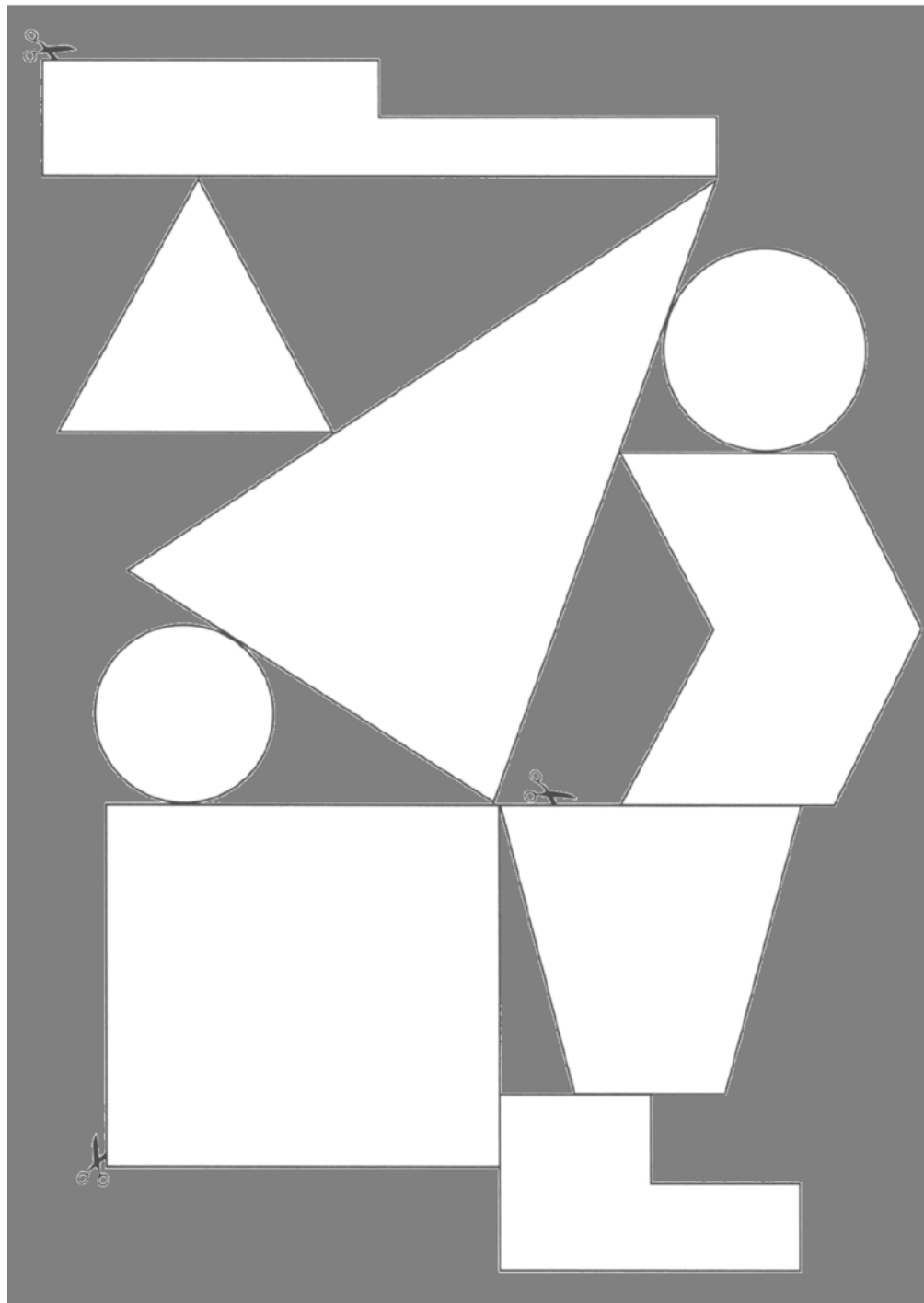

M. G. MacGregor, Teambuilding With Teens, Free Spirit Publishing Inc. (p. 80)

Figure 3D-1 Communication Puzzle

THIS PAGE INTENTIONALLY LEFT BLANK

PROBLEM-SOLVING SCENARIOS

PROBLEM-SOLVING SCENARIO 1

You are a member of your school volleyball team and a member of your cadet corps. This year your team is doing very well and is expected to go to the zone championship three weekends from now. You have just realized that your zone tournament may be the same weekend as your corps tour of a Canadian Forces unit.

What do you do?

PROBLEM-SOLVING SCENARIO 2

Your corps is conducting a tabloid sports meet tomorrow night. You have been assigned to organize the teams before the event begins.

What do you do?

PROBLEM-SOLVING SCENARIO 3

Your parents are going out of town for the weekend on business. You and your younger brother, who is 11 years old, are staying home. Your corps is conducting its annual community service event.

What do you do?

PROBLEM-SOLVING SCENARIO 4

You arrive at your cadet corps and you notice that your friend has extra money this week. You also know that she was working in the cadet canteen earlier that night.

What do you do?

POSSIBLE YEAR THREE COMMON LEADERSHIP ASSIGNMENTS

RECREATIONAL MARKSMANSHIP ASSIGNMENTS

- Set up a range for recreational marksmanship.
- Organize relays for recreational marksmanship.
- Control pellets and issue targets for recreational marksmanship.
- Conduct concurrent activities during recreational marksmanship.
- Tear down a range after recreational marksmanship.

SUMMER BIATHLON ASSIGNMENTS

- Set up range for summer biathlon.
- Conduct a warm-up activity prior to participating in summer biathlon.
- Control pellets for summer biathlon.
- Conduct a cool-down activity after participating in summer biathlon.
- Tear down the range after summer biathlon.

RECREATIONAL SPORTS ASSIGNMENTS

- Set up a recreational sports activity.
- Tear down a recreational sports activity.
- Organize a team for recreational sports.
- Conduct a warm-up prior to recreational sports.
- Conduct a concurrent activity during recreational sports.
- Conduct a cool-down after recreational sports.

WEEKLY PARADE CADET NIGHT ASSIGNMENTS

- Set up chairs for a parade.
- Set up the dais area for a parade.
- Set up flags and parade markers for a parade.
- Tear down chairs after a parade.
- Tear down dais area after a parade.
- Tear down flags and parade markers after a parade.

WEEKLY CADET NIGHT ASSIGNMENTS

- Set up classroom space.
- Rearrange classroom space.
- Tear down classroom space.
- Set up a canteen.

- Staff the canteen.
- Tear down a canteen.
- Set up a presentation area for a guest speaker.
- Tear down a presentation area for a guest speaker.
- Set up for an extracurricular activity.
- Conduct a concurrent activity.

COMMUNITY SERVICE LEADERSHIP ASSIGNMENTS

- Organize a team during a community service activity.
- Conduct a concurrent activity during community service activity.
- Complete a final garbage sweep after a community service activity.

OTHER LEADERSHIP ASSIGNMENT POSSIBILITIES

- Embark and disembark personnel on vehicles during transportation.
- Conduct uniform inspection of year one cadets.
- Collect and dispose of garbage after weekly parade.
- Collect, sort and dispose of recycling after weekly parade.
- Turn off lights and close windows after weekly parade.

PRIOR TO A WEEKEND ACTIVITY

- Distribute personal equipment.
- Label personal equipment.
- Load group equipment and supplies.

SETTING UP FOR WEEKEND TRAINING

- Unload equipment and supplies.
- Set up the first aid station.
- Set up the female sleeping area.
- Set up the male sleeping area.

ROUTINE TASKS THAT MAY OCCUR DURING WEEKEND TRAINING

- Organize the distribution of a meal.
- Clean up the eating area after a meal.
- Launch sailboats.
- Conduct a concurrent activity during weekend training.
- Secure sailboats.
- Organize lights out for the female cadets.
- Organize lights out for the male cadets.
- Organize wakey-wakey for female cadets.
- Organize wakey-wakey for male cadets.

SECURE WEEKEND TRAINING

- Secure the female sleeping area.
- Secure the male sleeping area.
- Secure the first aid station.
- Load group equipment and supplies.
- Complete a final garbage sweep.

AFTER WEEKEND TRAINING

- Unload equipment and supplies.
- Collect personal equipment.

THIS PAGE INTENTIONALLY LEFT BLANK

SAMPLE LEADERSHIP ASSIGNMENT

LEADERSHIP ASSIGNMENT Rearrange Classroom Space
ASSIGNMENT DESCRIPTION Organize a team of cadets to rearrange a classroom as required. Move the chairs and desks/tables to match the diagram (if provided) or as directed.
RESOURCES <ul style="list-style-type: none">• Chairs,• Diagram of placement of chairs (if required),• Desks/tables,• Electronic equipment (if required),• Whiteboards (if required), and• A minimum of four cadets.
TIME A maximum of 10 minutes.
SAFETY CONSIDERATIONS N/A.

THIS PAGE INTENTIONALLY LEFT BLANK

LEADERSHIP ASSIGNMENT FORMAT

1. Prepare for the leadership assignment by:
 - a. ensuring the goal is understood;
 - b. ensuring the required resources are available;
 - c. completing a time appreciation; and
 - d. making a plan.
2. Introduce the leadership assignment by:
 - a. stating the assignment to be completed;
 - b. stating the goal of the assignment;
 - c. identifying the resources required for the assignment;
 - d. communicating the overall plan;
 - e. assigning tasks to team members as applicable; and
 - f. ensuring the team members understand the assignment.
3. Conduct the leadership assignment by:
 - a. supervising peers;
 - b. maintaining team control;
 - c. ensuring the assignment is progressing according to the time allotted; and
 - d. modifying the plan as required.
4. Debrief the team following the leadership assignment by:
 - a. reviewing the goal;
 - b. providing feedback; and
 - c. re-motivating the team.
5. Complete an after-assignment report and a self-assessment.
6. Attend a debriefing with the directing staff.

THIS PAGE INTENTIONALLY LEFT BLANK

AFTER-ASSIGNMENT REPORT AND ASSESSMENT RUBRIC

AFTER-ASSIGNMENT REPORT

1. How did you feel after the assignment was completed?

2. How did you feel about the teamwork among the members? How is teamwork related to the outcome of a leadership assignment?

3. What aspects of the leadership assignment went well?

4. Is there anything you would do differently if you were to complete the same assignment again?

303 PC ASSESSMENT RUBRIC

Cadet's Name: _____

Corps: _____

Date: _____

Division: _____

	Incomplete	Completed With Difficulty	Completed Without Difficulty	Exceeded the Standard
Communicate as a team leader	Did not communicate with team members.	Communicated with team members occasionally. Team members needed clarification on many occasions.	Communicated with team members on many occasions. Team members needed few clarifications.	Communicated to the team throughout the leadership task. Team members did not need clarification.
Supervise cadets	Did not supervise cadets.	Only supervised cadets at the beginning and/or end of the leadership assignment.	Supervised throughout the leadership assignment making some corrections when necessary.	Supervised throughout the leadership assignment making corrections as necessary.
Solve problems	Did not solve the problem(s).		Solved the problem(s).	
Complete the leadership assignment	Did not complete the leadership assignment.		Completed the leadership assignment.	
Perform self-assessment	Did not complete the self-assessment.		Completed the self-assessment.	

This form shall be reproduced locally.

LEADERSHIP ASSIGNMENTS

LEADERSHIP ASSIGNMENT
<p>Set Up a Range for Recreational Marksmanship</p>
<p>ASSIGNMENT DESCRIPTION</p> <p>Organize a team of cadets to set up a range for recreational marksmanship. Determine the equipment required according to the number of firing lanes. Set up the area as per the diagram provided.</p>
<p>RESOURCES</p> <ul style="list-style-type: none">• Range area,• Air rifle targets,• Target frames,• Flags (red and green),• First aid kit,• Stretcher,• Shooting mats,• Safety glasses/goggles,• Cadet air rifles,• Cadet air rifle slings,• Diagram of placement for all resources, and• A minimum of six cadets.
<p>TIME</p> <p>A maximum of 20 minutes.</p>
<p>SAFETY CONSIDERATIONS</p> <p>Ensure safety precautions are being obeyed at all times when handling cadet air rifles.</p>

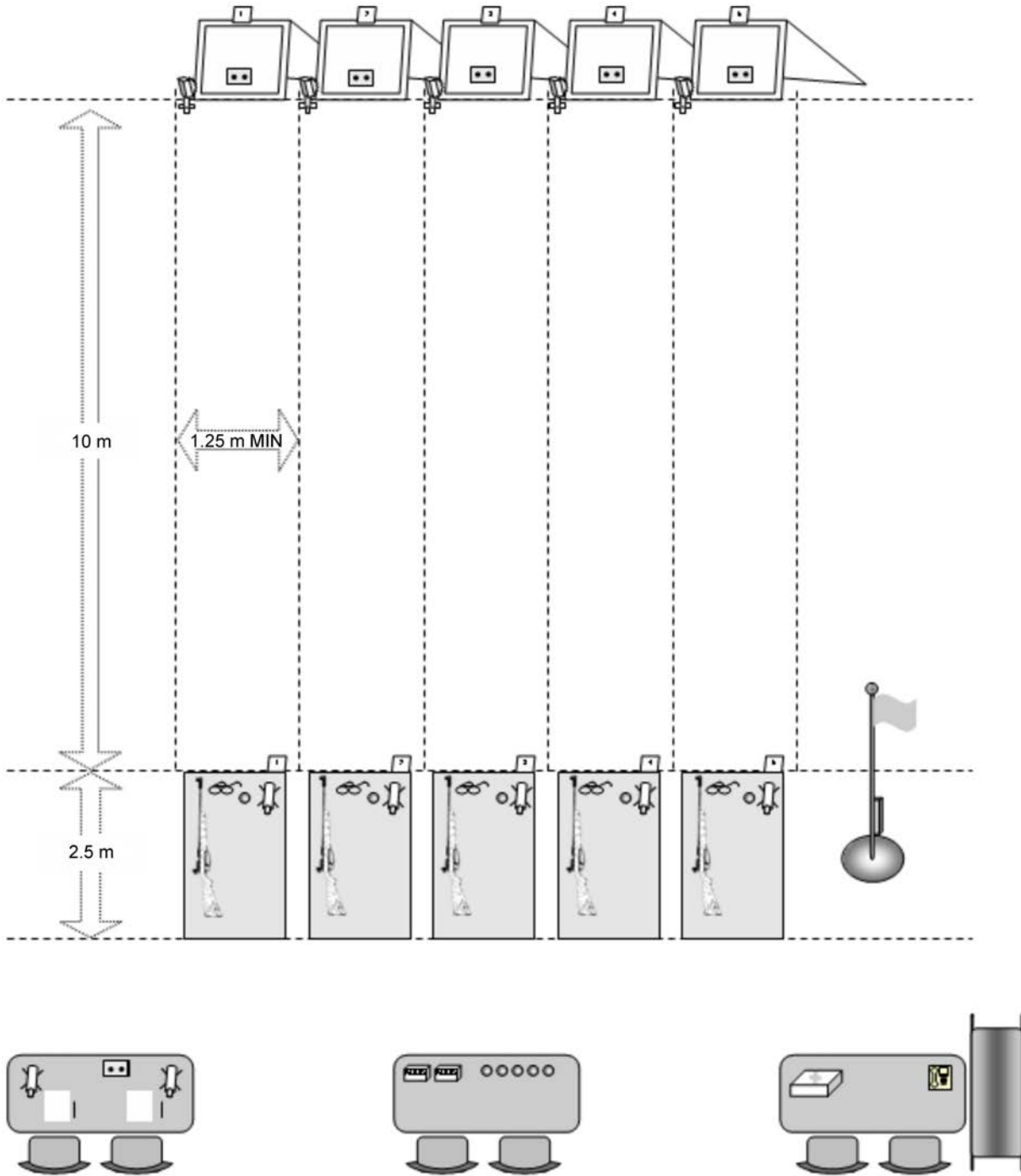

Director Cadets 3, 2008, Ottawa, ON: Department of National Defence

Figure 3J-1 Sample Range Layout

LEADERSHIP ASSIGNMENT Organize Relays for Recreational Marksmanship
ASSIGNMENT DESCRIPTION Organize the cadets into relays for recreational marksmanship according to the number of firing lanes.
RESOURCES All participating cadets.
TIME A maximum of 10 minutes.
SAFETY CONSIDERATIONS N/A.

LEADERSHIP ASSIGNMENT

Control Pellets and Issue Targets for Recreational Marksmanship

ASSIGNMENT DESCRIPTION

Organize a team of cadets to control and distribute pellets and issue targets for recreational marksmanship. Allocate the pellets required, per relay, according to the number of firing lanes.

RESOURCES

- Air rifle pellets,
- Containers to hold pellets,
- Suitable targets, and
- A minimum of two cadets.

TIME

One relay, approximately 10 minutes.

SAFETY CONSIDERATIONS

Ensure all cadets wash their hands after handling pellets.

LEADERSHIP ASSIGNMENT	
Conduct a Concurrent Activity During Recreational Marksmanship	
ASSIGNMENT DESCRIPTION	Organize and conduct a concurrent activity during recreational marksmanship (e.g., ground sweep, team-building activity, etc) for a small team of cadets. Ensure maximum participation of all cadets.
RESOURCES	<ul style="list-style-type: none">• As directed by the directing staff based on the concurrent activity, and• A small team of cadets.
TIME	A maximum of 20 minutes.
SAFETY CONSIDERATIONS	N/A.

LEADERSHIP ASSIGNMENT

Tear Down a Range After Recreational Marksmanship

ASSIGNMENT DESCRIPTION

Organize a team of cadets to tear down a range after recreational marksmanship. Return all equipment to the supply area. Count all equipment and report numbers to the directing staff after completing the assignment.

RESOURCES

- Resource checklist, and
- A minimum of six cadets.

TIME

A maximum of 20 minutes.

SAFETY CONSIDERATIONS

- Ensure safety precautions are being obeyed at all times when handling cadet air rifles.
- Ensure all cadets wash their hands after handling pellets.

Resources	Quantity Returned
Target Frame	
Red Flag	
Green Flag	
First Aid Kit	
Stretcher	
Shooting Mats	
Safety Glasses/Goggles	
Cadet Air Rifle	
Cadet Air Rifle Sling	
Pellets (Boxes)	

Director Cadets 3, 2008, Ottawa, ON: Department of National Defence

Figure 3J-2 Sample Resource Checklist

LEADERSHIP ASSIGNMENT

Set up a Range for Summer Biathlon

ASSIGNMENT DESCRIPTION

Organize a team of cadets to set up a range for summer biathlon as required. Determine the equipment required according to the number of firing lanes. Set up the area as per the diagram provided.

RESOURCES

- Range area,
- Biathlon air rifle targets (BART),
- Flags (red and green),
- First aid kit,
- Stretcher,
- Stopwatch,
- Shooting mats,
- Safety glasses/goggles,
- Cadet air rifles,
- Diagram of placement for all resources, and
- A minimum of six cadets.

TIME

A maximum of 20 minutes.

SAFETY CONSIDERATIONS

Ensure safety precautions are being obeyed at all times when handling cadet air rifles.

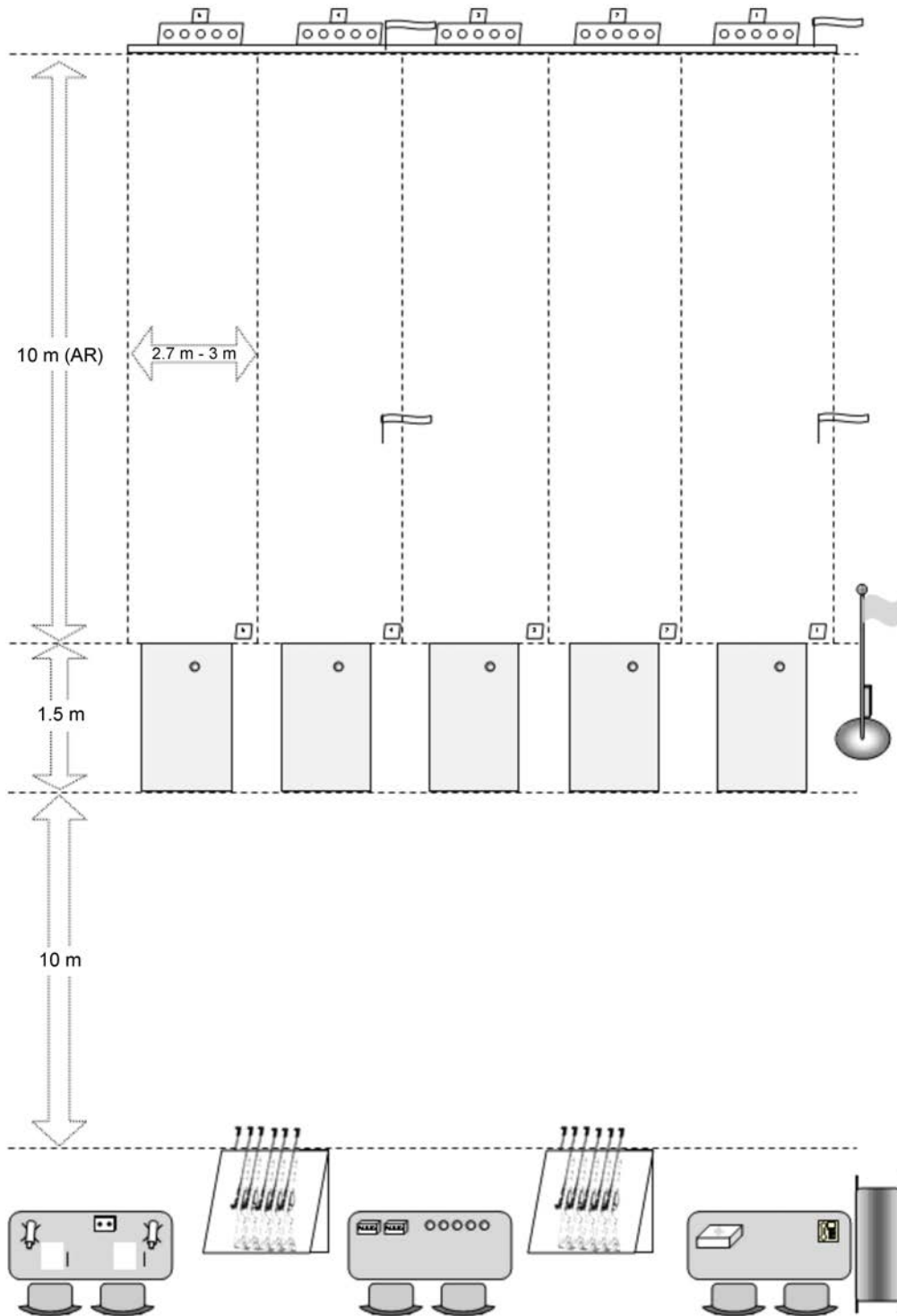

Director Cadets 3, 2008, Ottawa, ON: Department of National Defence

Figure 3J-3 Sample Biathlon Range Layout

LEADERSHIP ASSIGNMENT

Conduct a Warm-Up Activity Prior to Participating in Summer Biathlon

ASSIGNMENT DESCRIPTION

Organize and conduct a warm-up activity for a small team of cadets prior to participating in summer biathlon. Ensure maximum participation of all cadets.

RESOURCES

- Handout of sample stretches (located at Annex K), and
- A small team of cadets.

TIME

A maximum of 20 minutes.

SAFETY CONSIDERATIONS

N/A.

LEADERSHIP ASSIGNMENT
<p>Control Pellets for Summer Biathlon</p>
<p>ASSIGNMENT DESCRIPTION</p> <p>Organize a team of cadets to control and distribute pellets for summer biathlon. Allocate the pellets required, for each firing bout, according to the number of firing lanes.</p>
<p>RESOURCES</p> <ul style="list-style-type: none">• Air rifle pellets,• Containers to hold pellets, and• A minimum of two cadets.
<p>TIME</p> <p>As per activity.</p>
<p>SAFETY CONSIDERATIONS</p> <p>Ensure all cadets wash their hands after handling pellets.</p>

LEADERSHIP ASSIGNMENT

Conduct a Cool-Down Activity After Participating in Summer Biathlon

ASSIGNMENT DESCRIPTION

Organize and conduct a cool-down activity for a team of cadets after participating in summer biathlon. Ensure maximum participation of all cadets in the team.

RESOURCES

- Handout of sample stretches (located at Annex K), and
- A team of cadets.

TIME

A maximum of 20 minutes.

SAFETY CONSIDERATIONS

N/A.

<p style="text-align: center;">LEADERSHIP ASSIGNMENT</p> <p style="text-align: center;">Tear Down a Range After Summer Biathlon</p>
<p>ASSIGNMENT DESCRIPTION</p> <p>Organize a team of cadets to tear down a range after summer biathlon. Return all equipment to supply area. Count all equipment and report numbers to the directing staff after completing the assignment.</p>
<p>RESOURCES</p> <ul style="list-style-type: none">• Resource checklist, and• A minimum of six cadets.
<p>TIME</p> <p>A maximum of 20 minutes.</p>
<p>SAFETY CONSIDERATIONS</p> <ul style="list-style-type: none">• Ensure safety precautions are being obeyed at all times when handling cadet air rifles.• Ensure all cadets wash their hands after handling pellets.

Resources	Quantity Returned
Biathlon Air Rifle Target (BART)	
Red Flag	
Green Flag	
First Aid Kit	
Stretcher	
Stopwatch	
Shooting Mats	
Safety Glasses/Goggles	
Cadet Air Rifle	
Pellets (Boxes)	

Director Cadets 3, 2008, Ottawa, ON: Department of National Defence

Figure 3J-4 Sample Resource Checklist

<p style="text-align: center;">LEADERSHIP ASSIGNMENT</p> <p style="text-align: center;">Set up a Recreational Sports Activity</p>
<p>ASSIGNMENT DESCRIPTION</p> <p>Organize a team of cadets to set up a recreational sports activity as required. Move the scoring tables, stopwatch and any other sports equipment as directed.</p>
<p>RESOURCES</p> <ul style="list-style-type: none">• Scoring tables,• Stopwatch,• Sports equipment (as required), and• A minimum of four cadets.
<p>TIME</p> <p>A maximum of 10 minutes.</p>
<p>SAFETY CONSIDERATIONS</p> <p>N/A.</p>

LEADERSHIP ASSIGNMENT

Tear Down a Recreational Sports Activity

ASSIGNMENT DESCRIPTION

Organize a team of cadets to set up a recreational sports activity as required. Remove the scoring tables, stopwatch and any other sports equipment as directed.

RESOURCES

- Scoring tables,
- Stopwatch,
- Sports equipment (as required), and
- A minimum of four cadets.

TIME

A maximum of 10 minutes.

SAFETY CONSIDERATIONS

N/A.

LEADERSHIP ASSIGNMENT
<p>Organize a Team for Recreational Sports</p>
<p>ASSIGNMENT DESCRIPTION</p> <p>Organize the cadets into teams for recreational sports as directed (e.g., teams, scorekeepers, timekeepers, etc).</p>
<p>RESOURCES</p> <ul style="list-style-type: none">• Stopwatches,• Pens/pencils, and• All participating cadets.
<p>TIME</p> <p>A maximum of 10 minutes.</p>
<p>SAFETY CONSIDERATIONS</p> <p>N/A.</p>

LEADERSHIP ASSIGNMENT

Conduct a Warm-Up Activity Prior to Participating in Recreational Sports

ASSIGNMENT DESCRIPTION

Conduct a warm-up activity for a team of cadets prior to participating in recreational sports. Ensure maximum participation of all cadets in the team.

RESOURCES

- Handout of sample stretches (located at Annex K), and
- A team of cadets.

TIME

A maximum of 20 minutes.

SAFETY CONSIDERATIONS

N/A.

<p style="text-align: center;">LEADERSHIP ASSIGNMENT</p> <p style="text-align: center;">Conduct a Concurrent Activity During Recreational Sports</p>
<p>ASSIGNMENT DESCRIPTION</p> <p>Conduct a concurrent activity during recreational sports (e.g., team-building activity, cheering, etc) for a team of cadets. Ensure maximum participation of all cadets in the team.</p>
<p>RESOURCES</p> <ul style="list-style-type: none">• As directed by the directing staff based on the concurrent activity, and• A team of cadets.
<p>TIME</p> <p>A maximum of 20 minutes.</p>
<p>SAFETY CONSIDERATIONS</p> <p>N/A.</p>

LEADERSHIP ASSIGNMENT

Conduct a Cool-Down Activity After Participating in Recreational Sports

ASSIGNMENT DESCRIPTION

Conduct a cool-down activity for a team of cadets after participating in recreational sports. Ensure maximum participation of all cadets in the team.

RESOURCES

- Handout of sample stretches (located at Annex K), and
- A team of cadets.

TIME

A maximum of 20 minutes.

SAFETY CONSIDERATIONS

N/A.

<p style="text-align: center;">LEADERSHIP ASSIGNMENT</p> <p style="text-align: center;">Set up Chairs for a Parade</p>
<p>ASSIGNMENT DESCRIPTION</p> <p>Organize a team to set up chairs for guests of a parade. Count the chairs, which will already be on-site, then set them up as illustrated in the diagram or as directed.</p>
<p>RESOURCES</p> <ul style="list-style-type: none">• Chairs,• Diagram of placement of chairs (if required), and• A minimum of four cadets.
<p>TIME</p> <p>A maximum of 10 minutes.</p>
<p>SAFETY CONSIDERATIONS</p> <p>N/A.</p>



■ Chair

Director Cadets 3, 2008, Ottawa, ON: Department of National Defence

Figure 3J-5 Sample Placement of Chairs

LEADERSHIP ASSIGNMENT Set up the Dais Area for a Parade
ASSIGNMENT DESCRIPTION Organize a team to set up the dais area for dignitaries attending a parade. Using the resources provided, set up the dais area as illustrated in the diagram or as directed.
RESOURCES <ul style="list-style-type: none">• Dais,• Podium (if required),• Chairs (if required),• Diagram of dais area (if required), and• A minimum of four cadets.
TIME A maximum of 10 minutes.
SAFETY CONSIDERATIONS N/A.

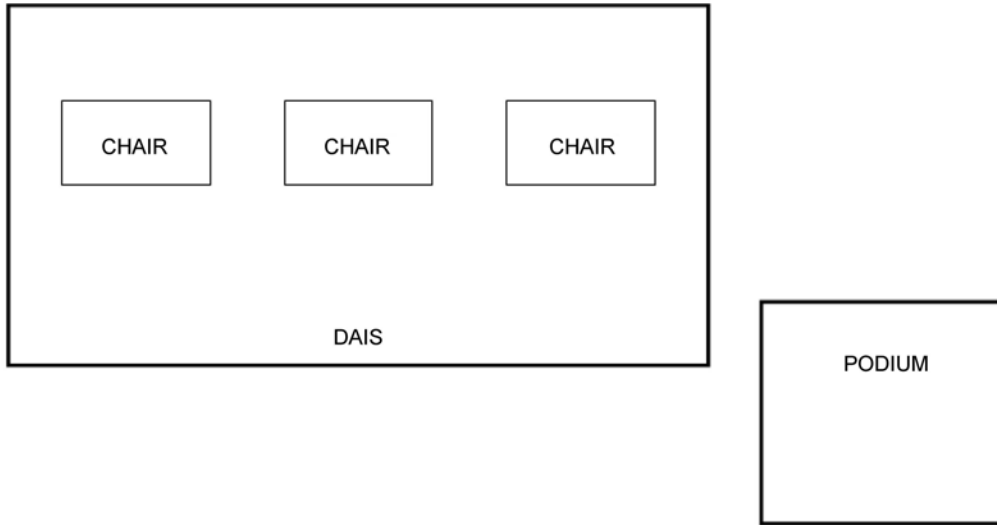

Director Cadets 3, 2008, Ottawa, ON: Department of National Defence

Figure 3J-6 Sample Dais Area

LEADERSHIP ASSIGNMENT

Set up Flags and Parade Markers for a Parade

ASSIGNMENT DESCRIPTION

Organize a team to set up flags and parade markers for a parade. Set them up as illustrated in the diagram or as directed.

RESOURCES

- Provincial and territorial flags,
- Parade markers,
- Diagram of placement of flags and parade markers (if required), and
- A minimum of four cadets.

TIME

A maximum of 15 minutes.

SAFETY CONSIDERATIONS

N/A.

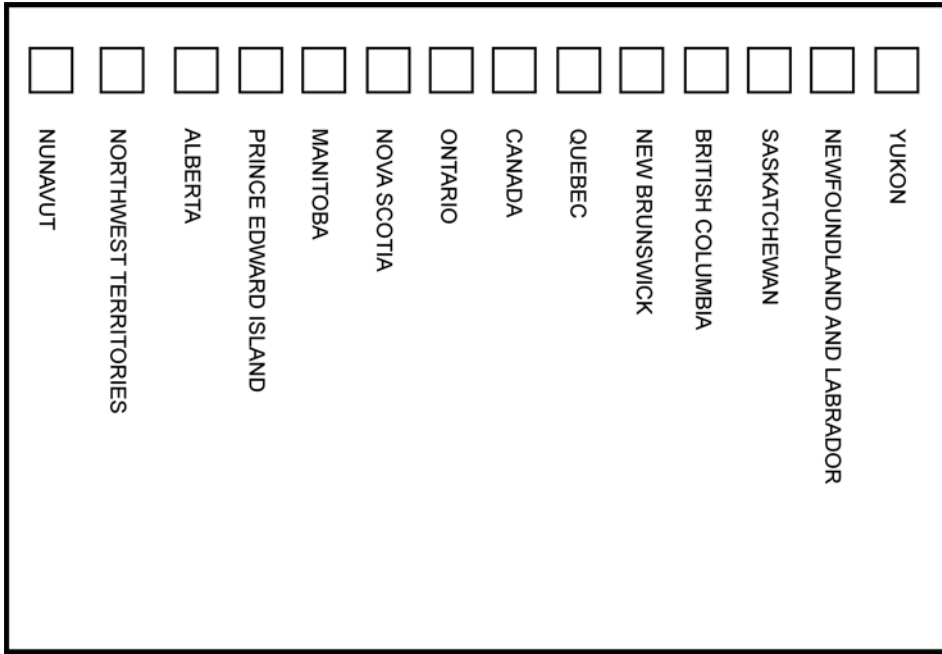

Director Cadets 3, 2008, Ottawa, ON: Department of National Defence

Figure 3J-7 Sample Placement of Flags

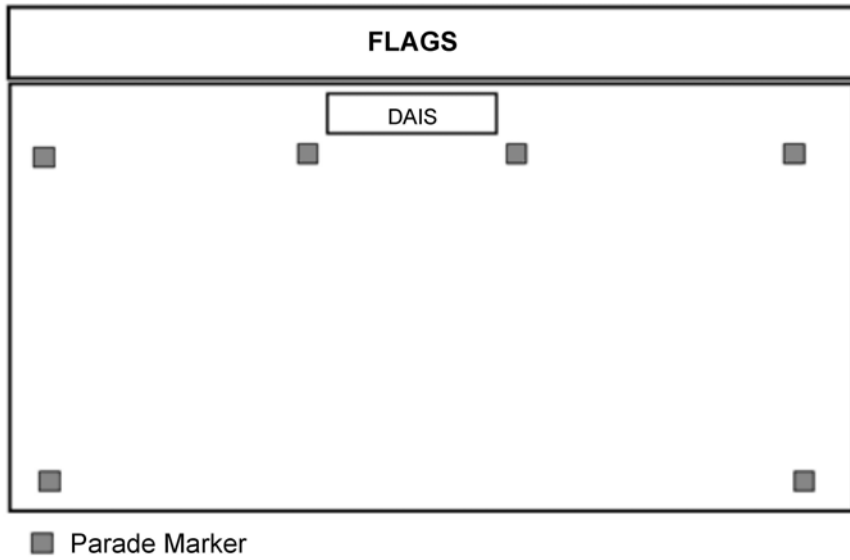

Director Cadets 3, 2008, Ottawa, ON: Department of National Defence

Figure 3J-8 Sample Placement of Parade Markers

LEADERSHIP ASSIGNMENT Tear Down Chairs After a Parade
ASSIGNMENT DESCRIPTION Organize a team to tear down chairs after a parade. Move the chairs to the designated supply area. Count all equipment and report numbers to the directing staff after completing the assignment.
RESOURCES <ul style="list-style-type: none">• Paper,• Pen/pencil, and• A minimum of four cadets.
TIME A maximum of 15 minutes.
SAFETY CONSIDERATIONS N/A.

LEADERSHIP ASSIGNMENT

Tear Down the Dais Area After a Parade

ASSIGNMENT DESCRIPTION

Organize a team to tear down the dais area after a parade. Return all equipment to the designated supply area. Count all equipment and report numbers to the directing staff after completing the assignment.

RESOURCES

- Paper,
- Pen/pencil, and
- A minimum of four cadets.

TIME

A maximum of 15 minutes.

SAFETY CONSIDERATIONS

N/A.

LEADERSHIP ASSIGNMENT

Tear Down Flags and Parade Markers After a Parade

ASSIGNMENT DESCRIPTION

Organize a team to tear down flags and parade markers after a parade. Return all equipment to the designated supply area. Count all equipment and report numbers to the directing staff after completing the assignment.

RESOURCES

- Paper,
- Pen/pencil, and
- A minimum of four cadets.

TIME

A maximum of 15 minutes.

SAFETY CONSIDERATIONS

N/A.

LEADERSHIP ASSIGNMENT

Set up Classroom Space

ASSIGNMENT DESCRIPTION

Organize a team of cadets to set up a classroom as required. Move the chairs, desks/tables and any other equipment as directed.

RESOURCES

- Chairs,
- Desks/tables,
- Electronic equipment (if required),
- Whiteboards (if required), and
- A minimum of four cadets.

TIME

A maximum of 10 minutes.

SAFETY CONSIDERATIONS

N/A.

LEADERSHIP ASSIGNMENT Rearrange Classroom Space
ASSIGNMENT DESCRIPTION Organize a team of cadets to rearrange a classroom as required. Move the chairs and desks/tables to match the diagram (if provided) or as directed.
RESOURCES <ul style="list-style-type: none">• Chairs,• Diagram of placement of chairs (if required),• Desks/tables,• Electronic equipment (if required),• Whiteboards (if required), and• A minimum of four cadets.
TIME A maximum of 10 minutes.
SAFETY CONSIDERATIONS N/A.

LEADERSHIP ASSIGNMENT

Tear Down Classroom Space

ASSIGNMENT DESCRIPTION

Organize a team of cadets to tear down a classroom as required. Remove the chairs and desks/tables to match the diagram (if provided) or as directed.

RESOURCES

- Chairs,
- Diagram of placement of chairs (if required),
- Desks/tables,
- Electronic equipment (if required),
- Whiteboards (if required), and
- A minimum of four cadets.

TIME

A maximum of 10 minutes.

SAFETY CONSIDERATIONS

N/A.

<p style="text-align: center;">LEADERSHIP ASSIGNMENT</p> <p style="text-align: center;">Set up a Canteen</p>
<p>ASSIGNMENT DESCRIPTION</p> <p>Organize a team of cadets to set up a canteen. Move the tables/counters, chairs, stock, cashbox and any other equipment as directed.</p>
<p>RESOURCES</p> <ul style="list-style-type: none">• Chairs,• Tables/counter,• Stock,• Cashbox, and• A minimum of four cadets.
<p>TIME</p> <p>A maximum of 10 minutes.</p>
<p>SAFETY CONSIDERATIONS</p> <p>N/A.</p>

LEADERSHIP ASSIGNMENT

Staff a Canteen

ASSIGNMENT DESCRIPTION

Organize a team of cadets to staff a canteen. Ensure team know the price of each item to be sold.

RESOURCES

- Chairs,
- Tables/counter,
- Stock,
- Cashbox, and
- A minimum of four cadets.

TIME

A maximum of 20 minutes.

SAFETY CONSIDERATIONS

N/A.

<p style="text-align: center;">LEADERSHIP ASSIGNMENT</p> <p style="text-align: center;">Tear Down a Canteen</p>
<p>ASSIGNMENT DESCRIPTION</p> <p>Organize a team of cadets to tear down a canteen. Remove the tables/counters, chairs, stock, cashbox and any other equipment as directed. Ensure cashbox is returned to an area that is secured.</p>
<p>RESOURCES</p> <ul style="list-style-type: none">• Chairs,• Tables/counter,• Stock,• Cashbox, and• A minimum of four cadets.
<p>TIME</p> <p>A maximum of 10 minutes.</p>
<p>SAFETY CONSIDERATIONS</p> <p>N/A.</p>

LEADERSHIP ASSIGNMENT

Set up a Presentation Area for a Guest Speaker

ASSIGNMENT DESCRIPTION

Organize a team to set up a presentation area for a guest speaker. Set up the podium, chairs and electronic equipment (if required) as directed.

RESOURCES

- Podium,
- Chairs,
- Electronic equipment (if required), and
- A minimum of two cadets.

TIME

A maximum of 15 minutes.

SAFETY CONSIDERATIONS

N/A.

LEADERSHIP ASSIGNMENT

Tear Down a Presentation Area After a Guest Speaker

ASSIGNMENT DESCRIPTION

Organize a team to tear down a presentation area after a guest speaker. Return all equipment to supply area. Count all equipment and report numbers to the directing staff after completing the assignment.

RESOURCES

- Paper,
- Pen/pencil, and
- A minimum of two cadets.

TIME

A maximum of 10 minutes.

SAFETY CONSIDERATIONS

N/A.

LEADERSHIP ASSIGNMENT

Set Up for an Extracurricular Activity

ASSIGNMENT DESCRIPTION

Organize a team of cadets to set up for an extracurricular activity (e.g., recreational sports, tour of a facility, field trip, summer biathlon, etc).

RESOURCES

As provided by directing staff.

TIME

A maximum of 20 minutes.

SAFETY CONSIDERATIONS

N/A.

<p style="text-align: center;">LEADERSHIP ASSIGNMENT</p> <p style="text-align: center;">Conduct a Concurrent Activity</p>
<p>ASSIGNMENT DESCRIPTION</p> <p>Conduct a concurrent activity (e.g., ground sweep, team-building activity, singing, etc) for a team of cadets who are awaiting further direction. Ensure maximum participation of all cadets in the team.</p>
<p>RESOURCES</p> <ul style="list-style-type: none">• As directed by the directing staff based on the concurrent activity, and• A team of cadets.
<p>TIME</p> <p>A maximum of 20 minutes.</p>
<p>SAFETY CONSIDERATIONS</p> <p>Cadets should be kept out of high-traffic areas.</p>

LEADERSHIP ASSIGNMENT

Organize a Team During a Community Service Activity

ASSIGNMENT DESCRIPTION

Organize a team of cadets during a community service activity. Move people and equipment as directed.

RESOURCES

A team of cadets.

TIME

A maximum of 20 minutes.

SAFETY CONSIDERATIONS

Cadets should be kept out of high-traffic areas.

LEADERSHIP ASSIGNMENT

Conduct a Concurrent Activity During a Community Service Activity

ASSIGNMENT DESCRIPTION

Conduct a concurrent activity during a community service activity (e.g., ground sweep, team-building activity, singing, etc) for a team of cadets who are awaiting further direction. Ensure maximum participation of all cadets in the team.

RESOURCES

- As directed by the directing staff based on the concurrent activity, and
- A team of cadets.

TIME

A maximum of 20 minutes.

SAFETY CONSIDERATIONS

Cadets should be kept out of high-traffic areas.

LEADERSHIP ASSIGNMENT

Complete a Final Garbage Sweep After a Community Service Activity

ASSIGNMENT DESCRIPTION

Organize a team of cadets to complete a final garbage sweep after a community service activity and ensure all areas used are free of garbage.

RESOURCES

- Garbage bags, and
- A minimum of 10 cadets.

TIME

A maximum of 20 minutes.

SAFETY CONSIDERATIONS

N/A.

LEADERSHIP ASSIGNMENT

Embark and Disembark Personnel on Vehicles During Transportation

ASSIGNMENT DESCRIPTION

Organize a team of cadets to ensure all personnel embark and disembark vehicles in a safe manner. Count all personnel when embarking and disembarking the vehicle. Assist in supervision while personnel are being transported.

RESOURCES

- Vehicle, and
- A minimum of seven cadets.

TIME

Travel time.

SAFETY CONSIDERATIONS

Cadets must sit facing the front of the vehicle and must use seat belts.

LEADERSHIP ASSIGNMENT

Conduct Uniform Inspections of Year One Cadets

ASSIGNMENT DESCRIPTION

Organize a team of cadets to conduct uniform inspections of year one cadets.

RESOURCES

- Uniform inspection rubrics,
- Year one cadets, and
- A team of cadets.

TIME

A maximum of 15 minutes.

SAFETY CONSIDERATIONS

N/A.

UNIFORM INSPECTION RUBRICS

	Incomplete	Completed With Difficulty	Completed Without Difficulty
Headdress	The cadet was not wearing a uniform.	The cadet was wearing headdress, but it was either not correctly positioned or fitted, or had an incorrectly attached cap tally.	The cadet was wearing a properly fitting headdress with a properly attached cap tally.
Uniform	The cadet was not wearing a uniform.	The cadet was wearing a uniform, but it was either not correctly worn or fitting, or had signs of being dirty or not having been properly pressed.	The cadet was wearing a properly fitting and properly pressed uniform.
Badges	The cadet was not wearing a uniform.	The cadet had badges worn on the uniform, but some were either not correctly positioned or had missing badges.	The cadet's rank and all other badges were worn and correctly positioned.
Footwear	The cadet was not wearing a uniform.	The cadet had boots, but they were either poorly maintained or poorly shone.	The cadet had well maintained boots with the entire boot shone equally.
Personal Appearance	The cadet was either not on parade or was not hygienic.	The cadet was on parade, but their personal appearance was somewhat below the standard IAW dress instructions (e.g., hair, shaving, makeup, jewellery, etc.).	The cadet was on parade, and their personal appearance met the standard IAW dress instructions (e.g., hair, shaving, makeup, jewellery, etc.).

UNIFORM INSPECTION CHECKLIST

Name	Headress	Uniform	Badges	Footwear	Personal Appearance	Comments
1.						
2.						
3.						
4.						
5.						
6.						
7.						
8.						
9.						
10.						
11.						
12.						
13.						
14.						
15.						
16.						
17.						
18.						
19.						
20.						
21.						
22.						
23.						
24.						
I – Incomplete D – Completed With Difficulty W – Completed Without Difficulty						

LEADERSHIP ASSIGNMENT	
Collect and Dispose of Garbage After Weekly Parade	
ASSIGNMENT DESCRIPTION	Organize a team of cadets to collect and dispose of garbage and ensure all areas used are free of garbage.
RESOURCES	<ul style="list-style-type: none">• Garbage bags, and• A minimum of five cadets.
TIME	A maximum of 10 minutes.
SAFETY CONSIDERATIONS	N/A.

LEADERSHIP ASSIGNMENT

Collect, Sort and Dispose of Recycling After Weekly Parade

ASSIGNMENT DESCRIPTION

Organize a team of cadets to collect, sort and dispose of material to be recycled. Ensure all areas used are free of material to be recycled.

RESOURCES

- Garbage bags,
- Recycling containers or bags (as required), and
- A minimum of five cadets.

TIME

A maximum of 10 minutes.

SAFETY CONSIDERATIONS

N/A.

LEADERSHIP ASSIGNMENT	
	Turn Off Lights and Close Windows After Weekly Parade
ASSIGNMENT DESCRIPTION	Organize a team of cadets to turn off lights and close windows after weekly parade.
RESOURCES	A minimum of five cadets.
TIME	A maximum of five minutes.
SAFETY CONSIDERATIONS	N/A.

THIS PAGE INTENTIONALLY LEFT BLANK

SAMPLE STRETCHES

a. Neck:

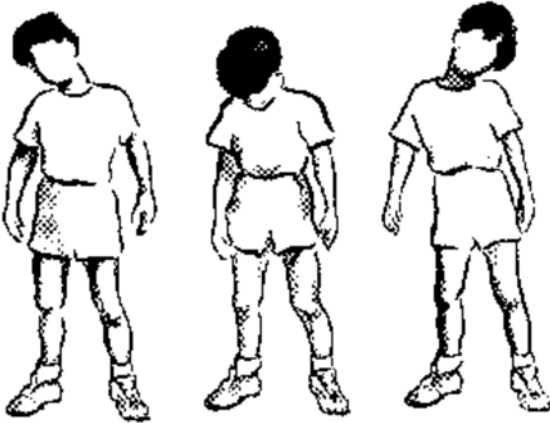
 <p><i>B. Hanson, Moving on the Spot: A Collection of 5 Minute Stretch and Movement Sessions, Toronto Public Health. Retrieved October 26, 2006, from http://www.lin.ca/resource/html/dn3.htm#1</i></p> <p>Figure 3K-1 Neck Stretch</p>	<p>Slowly roll your head across your chest from shoulder to shoulder. Do not roll your head backwards.</p>
--	--

b. Shoulders:

 <p><i>B. Hanson, Moving on the Spot: A Collection of 5 Minute Stretch and Movement Sessions, Toronto Public Health. Retrieved October 26, 2006, from http://www.lin.ca/resource/html/dn3.htm#1</i></p> <p>Figure 3K-2 Shoulder Push</p>	<p>Stand and extend your arms behind you, interlocking your fingers. Push up and back with your shoulders.</p> <p>Hold this position for a minimum of 10 seconds.</p>
---	---

 <p><i>B. Hanson, Moving on the Spot: A Collection of 5 Minute Stretch and Movement Sessions, Toronto Public Health. Retrieved October 26, 2006, from http://www.lin.ca/resource/html/dn3.htm#1</i></p> <p>Figure 3K-3 Shoulder Shrug</p>	<p>Stand and raise your shoulders as high as possible and then lower your shoulders, stretching your neck up.</p> <p>Pull your shoulders back as far as possible and then round your shoulders forward by pushing your shoulders forward as far as possible.</p> <p>Hold each position for a minimum of 10 seconds.</p>
--	---



Warm Ups, by Martha Jefferson Hospital, Copyright 2001 by Martha Jefferson Hospital. Retrieved October 26, 2006, from <http://www.marthajefferson.org/warmup.php>

Figure 3K-4 Arm Circles

Hold your arms straight out, palms up. Make small circles with your arms, gradually increasing the size.

Reverse the direction of your circles.



Smart Start: A Flexible Way to Get Fit. Retrieved October 26, 2006, from <http://www.in-motion.ca/walkingworkout/plan/flexibility/>

Figure 3K-5 Shoulder Stretch

Either standing or sitting, take your right arm in your left hand and bring it across your chest, supporting the joint by holding it behind the elbow. Pull lightly on the elbow towards your chest. You should feel the stretch in your right shoulder.

Hold this position for a minimum of 10 seconds and repeat on the opposite side.

c. Arms:



Exercises. Copyright 1998 by Impacto Protective Products Inc. Retrieved October 26, 2006, from <http://www.2protect.com/home.htm>

Figure 3K-6 Wrist Rotations

Rotate your hands in circular motions at the wrist.

Change direction and repeat on both sides.



Smart Start: A Flexible Way to Get Fit. Retrieved October 26, 2006, from <http://www.in-motion.ca/walkingworkout/plan/flexibility/>

Figure 3K-7 Triceps Stretch

Stand and bring your right arm over your head, bent at the elbow. Use your left hand to gently pull your arm down.

Hold this position for a minimum of 10 seconds and repeat on the opposite side.



Exercise Programme for Squash, Tennis, Softball, Handball. Retrieved October 26, 2006, from <http://www.physionline.co.za/conditions/article.asp?id=49>

Figure 3K-8 Forearm Stretch

In a kneeling position, place your hands on the floor in front of you turned so that your fingers are pointing toward your knees, and your thumbs are pointing out. Keeping your hands flat on the floor, lean back.

Hold this position for a minimum of 10 seconds.

d. Chest and Abdominals:



Smart Start: A Flexible Way to Get Fit. Retrieved October 26, 2006, from <http://www.in-motion.ca/walkingworkout/plan/flexibility/>

Figure 3K-9 Chest Stretch

Stand facing a wall. With your right arm bent and your elbow at shoulder height, place your palm against the wall. Turn your body away from your right arm. You should feel the stretch on the front side of your armpit and across the front of your chest.

Hold this position for a minimum of 10 seconds and repeat on the opposite side.



B. Hanson, Moving on the Spot: A Collection of 5 Minute Stretch and Movement Sessions, Toronto Public Health. Retrieved October 26, 2006, from <http://www.lin.ca/resource/html/dn3.htm#1>

Figure 3K-10 Side Stretch

Stand with your left arm up over your head. Bend at your waist towards the right side of your body.

Hold this position for a minimum of 10 seconds and repeat on the opposite side.

e. Back:



Smart Start: A Flexible Way to Get Fit. Retrieved October 26, 2006, from <http://www.in-motion.ca/walkingworkout/plan/flexibility/>



Figure 3K-11 Lower Back Stretch

Lie on your back and bring your knees toward your chest. Grasp the back of your knees.

Hold this position for a minimum of 10 seconds.

 <p><i>Smart Start: A Flexible Way to Get Fit. Retrieved October 26, 2006, from http://www.in-motion.ca/walkingworkout/plan/flexibility/</i></p> <p>Figure 3K-12 Upper Back Stretch</p>	<p>Extend your arms straight in front of you at shoulder height crossing one arm over the other. With the palms facing each other, intertwine your fingers and press out through your arms. Let your chin fall to your chest as you exhale. You should feel the stretch in the upper back.</p> <p>Hold this position for a minimum of 10 seconds and repeat on the opposite side.</p>
---	---

f. Legs:

 <p><i>Smart Start: A Flexible Way to Get Fit. Retrieved October 26, 2006, from http://www.in-motion.ca/walkingworkout/plan/flexibility/</i></p> <p>Figure 3K-13 Hamstring Stretch</p>	<p>Lie flat on the floor with your knees bent and your back flat on the floor. Slowly raise and straighten one leg, grasping it behind your thigh with both hands.</p> <p>Hold this position for a minimum of 10 seconds.</p>
 <p><i>Smart Start: A Flexible Way to Get Fit. Retrieved October 26, 2006, from http://www.in-motion.ca/walkingworkout/plan/flexibility/</i></p> <p>Figure 3K-14 Inner Thigh Stretch</p>	<p>Sit on the floor with your knees bent and the soles of your feet together. Grab your toes and pull yourself forward while keeping your back and neck straight.</p> <p>Hold this position for a minimum of 10 seconds.</p> <p>Grab your ankles and push your knees down toward the floor with your elbows.</p> <p>Hold this position for a minimum of 10 seconds.</p>



Smart Start: A Flexible Way to Get Fit. Retrieved October 26, 2006, from <http://www.in-motion.ca/walkingworkout/plan/flexibility/>

Figure 3K-15 Hip Flexor

Kneel on your right knee. Position your left foot in front of you, bending your knee and placing your left hand on that leg for stability. Keep your back straight and abdominal muscles tight. Lean forward, shifting more body weight onto your front leg. You should feel the stretch in the front of your hip and the thigh of the leg you are kneeling on. Cushion your kneecap with a folded towel if necessary.

Hold this position for a minimum of 10 seconds and repeat on the opposite side.

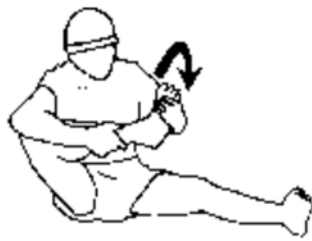

Running Exercises. Retrieved October 26, 2006, <http://www.physionline.co.za/conditions/article.asp?id=46>

Figure 3K-16 Ankle Rotations

From a sitting position, rotate your foot in a clockwise, and then a counter-clockwise, direction.

Switch and repeat on the opposite side.



Smart Start: A Flexible Way to Get Fit. Retrieved October 26, 2006, from <http://www.in-motion.ca/walkingworkout/plan/flexibility/>

Figure 3K-17 Calf Stretch

Stand three steps away from and facing a wall. Step in towards the wall with your right leg, bending your right knee and keeping your left leg straight. Extending your arms with your palms forward, reach out to the wall and let your body fall toward the wall. Keep your toes forward and your heels down. Lean your body into the wall with your left leg straight behind your body. You should feel the stretch in your left calf.

Hold this position for a minimum of 10 seconds and repeat on the opposite side.



Smart Start: A Flexible Way to Get Fit. Retrieved October 26, 2006, from <http://www.in-motion.ca/walkingworkout/plan/flexibility/>

Figure 3K-18 Quadriceps Stretch

Stand with your hand against a wall for balance. Lift your left foot off the ground, bending your knee as if you are trying to kick your bottom with your heel. Do not lean forward at the hips. Grab and hold your ankle with your left hand. You should feel the stretch in your left thigh.

Hold this position for a minimum of 10 seconds and repeat on the opposite side.

THIS PAGE INTENTIONALLY LEFT BLANK

LEADERSHIP ASSIGNMENTS

<p style="text-align: center;">LEADERSHIP ASSIGNMENT Distribute Personal Equipment</p>
<p>ASSIGNMENT DESCRIPTION</p> <p>Organize a team to distribute personal equipment required for weekend training to the members of their.</p>
<p>RESOURCES</p> <ul style="list-style-type: none">• Field pack (one per cadet),• Sleeping bag (one per cadet),• Air mattress (one per cadet), and• A minimum of three cadets.
<p>TIME</p> <p>A maximum of 15 minutes.</p>
<p>SAFETY CONSIDERATIONS</p> <p>N/A.</p>

LEADERSHIP ASSIGNMENT

Label Personal Equipment

ASSIGNMENT DESCRIPTION

Organize the cadets to label their personal equipment that was distributed for the weekend training.

RESOURCES

- Field pack (one per cadet),
- Sleeping bag (one per cadet),
- Air mattress (one per cadet),
- Masking tape,
- Markers, and
- A minimum of eight cadets.

TIME

A maximum of 15 minutes.

SAFETY CONSIDERATIONS

N/A.

LEADERSHIP ASSIGNMENT

Load Team Equipment and Supplies for Weekend Training

ASSIGNMENT DESCRIPTION

Organize a team to load equipment and supplies on the supply vehicle for weekend training.

RESOURCES

- Resources as detailed by the directing staff, such as:
 - first aid kits,
 - fire extinguishers,
 - garbage bags,
 - flashlights,
 - flashlight batteries,
 - radios,
 - radio batteries,
 - personal floatation devices (PFDs),
 - rope,
 - boatswain knives,
 - whipping twine,
 - meals for the weekend training,
 - paper,
 - markers,
 - masking tape, and
 - pens/pencils.
- Supply vehicle,
- Resource checklist,
- Pen/pencil, and
- A minimum of four cadets.

TIME

A maximum of 30 minutes.

SAFETY CONSIDERATIONS

Cadets should be kept out of high-traffic areas.

LEADERSHIP ASSIGNMENT

Unload Team Equipment and Supplies for Weekend Training

ASSIGNMENT DESCRIPTION

Organize a team to unload team equipment and supplies from the supply vehicle.

RESOURCES

- Team equipment and supplies,
- Supply vehicle, and
- A minimum of four cadets.

TIME

A maximum of 20 minutes.

SAFETY CONSIDERATIONS

Equipment should be kept out of high-traffic areas.

<p style="text-align: center;">LEADERSHIP ASSIGNMENT</p> <p style="text-align: center;">Set up the First Aid Station</p>
<p>ASSIGNMENT DESCRIPTION</p> <p>Organize a team to set up the first aid station.</p>
<p>RESOURCES</p> <ul style="list-style-type: none">• First aid equipment, and• A minimum of three cadets.
<p>TIME</p> <p>A maximum of 15 minutes.</p>
<p>SAFETY CONSIDERATIONS</p> <p>Equipment and supplies must be safely handled.</p>

LEADERSHIP ASSIGNMENT

Set Up the Female Sleeping Area

ASSIGNMENT DESCRIPTION

Organize the female cadets into groups. Ensure they are aware of the female sleeping area boundaries. Supervise the cadet and ensure personal equipment is stored.

RESOURCES

All female cadets.

TIME

A maximum of 30 minutes.

SAFETY CONSIDERATIONS

N/A.

<p style="text-align: center;">LEADERSHIP ASSIGNMENT</p> <p style="text-align: center;">Set Up the Male Sleeping Area</p>
<p>ASSIGNMENT DESCRIPTION</p> <p>Organize the male cadets into groups. Ensure they are aware of the male sleeping area boundaries. Supervise the cadets and ensure personal equipment is stored.</p>
<p>RESOURCES</p> <p>All male cadets.</p>
<p>TIME</p> <p>A maximum of 30 minutes.</p>
<p>SAFETY CONSIDERATIONS</p> <p>N/A.</p>

LEADERSHIP ASSIGNMENT

Organize the Distribution of a Meal

ASSIGNMENT DESCRIPTION

Divide the cadets into groups and organize the distribution of a meal.

RESOURCES

N/A.

TIME

A maximum of 30 minutes.

SAFETY CONSIDERATIONS

N/A.

LEADERSHIP ASSIGNMENT
<p>Clean Up the Eating Area After a Meal</p>
<p>ASSIGNMENT DESCRIPTION</p> <p>Organize a team to clean up the eating area after a meal. Ensure all of the dishes are clean and put back in their proper place. Ensure tables are clean and all garbage is disposed of.</p>
<p>RESOURCES</p> <ul style="list-style-type: none">• Garbage bags,• Water, and• A minimum of four cadets.
<p>TIME</p> <p>A maximum of 20 minutes.</p>
<p>SAFETY CONSIDERATIONS</p> <p>N/A.</p>

LEADERSHIP ASSIGNMENT

Launch Sailboats

ASSIGNMENT DESCRIPTION

Organize a team to launch sailboats and secure them alongside a dock.

RESOURCES

- PFDs (one per cadet),
- sailboats, and
- A minimum of 10 cadets.

TIME

A maximum of 30 minutes.

SAFETY CONSIDERATIONS

Ensure A-CR-CCP-030/PT-001, *Water Safety Orders* is adhered to throughout the activity.

LEADERSHIP ASSIGNMENT
Conduct a Concurrent Activity During Weekend Training
ASSIGNMENT DESCRIPTION Conduct a concurrent activity (e.g., ground sweep, team-building activity, singing, etc) for a team of cadets who are awaiting further direction. Ensure maximum participation of all cadets in the team.
RESOURCES <ul style="list-style-type: none">• As directed by the directing staff based on the concurrent activity, and• A team of cadets.
TIME A maximum of 20 minutes.
SAFETY CONSIDERATIONS Cadets should be kept in an area that does not conflict with training.

LEADERSHIP ASSIGNMENT

Secure Sailboats

ASSIGNMENT DESCRIPTION

Organize a team to take sailboats out of the water and secure them ashore.

RESOURCES

- PFDs (one per cadet),
- sailboats, and
- A minimum of 10 cadets.

TIME

A maximum of 30 minutes.

SAFETY CONSIDERATIONS

Ensure A-CR-CCP-030/PT-001 is adhered to throughout the activity.

LEADERSHIP ASSIGNMENT	
	Organize Lights Out for the Female Cadets
ASSIGNMENT DESCRIPTION	Organize lights out for the female cadets. Ensure that all female cadets are accounted for and that all personal equipment is stored.
RESOURCES	A minimum of two cadets.
TIME	A maximum of 20 minutes.
SAFETY CONSIDERATIONS	N/A.

LEADERSHIP ASSIGNMENT

Organize Lights Out for the Male Cadets

ASSIGNMENT DESCRIPTION

Organize lights out for the male cadets. Ensure that all male cadets are accounted for and that all personal equipment is stored.

RESOURCES

A minimum of two cadets.

TIME

A maximum of 20 minutes.

SAFETY CONSIDERATIONS

N/A.

LEADERSHIP ASSIGNMENT	
	Organize Wakey-Wakey for Female Cadets
ASSIGNMENT DESCRIPTION	Ensure female cadets are awake, all personal kit is organized and cadets are ready for morning training.
RESOURCES	All female cadets.
TIME	A maximum of 40 minutes.
SAFETY CONSIDERATIONS	N/A.

LEADERSHIP ASSIGNMENT

Organize Wakey-Wakey for Male Cadets

ASSIGNMENT DESCRIPTION

Ensure male cadets are awake, all personal kit is organized and cadets are ready for morning training.

RESOURCES

All male cadets.

TIME

A maximum of 40 minutes.

SAFETY CONSIDERATIONS

N/A.

LEADERSHIP ASSIGNMENT Secure the Female Sleeping Area
ASSIGNMENT DESCRIPTION Ensure female cadets are awake and all personal kit is packed. Ensure the female sleeping area is clean.
RESOURCES All female cadets.
TIME A maximum of 40 minutes.
SAFETY CONSIDERATIONS N/A.

LEADERSHIP ASSIGNMENT

Secure the Male Sleeping Area

ASSIGNMENT DESCRIPTION

Ensure male cadets are awake and all personal kit is packed. Ensure the male sleeping area is clean.

RESOURCES

All male cadets.

TIME

A maximum of 40 minutes.

SAFETY CONSIDERATIONS

N/A.

<p style="text-align: center;">LEADERSHIP ASSIGNMENT</p> <p style="text-align: center;">Dismantle First Aid Station</p>
<p>ASSIGNMENT DESCRIPTION</p> <p>Organize a team to dismantle the first aid station. Return resources to the supply area as required.</p>
<p>RESOURCES</p> <p>A minimum of six cadets.</p>
<p>TIME</p> <p>A maximum of 10 minutes.</p>
<p>SAFETY CONSIDERATIONS</p> <p>Equipment and supplies must be safely handled.</p>

LEADERSHIP ASSIGNMENT

Load Group Equipment and Supplies After Weekend Training

ASSIGNMENT DESCRIPTION

Organize a team to load equipment and supplies on the supply vehicle after weekend training.

RESOURCES

- Resources as detailed by the instructional staff,
- Supply vehicle, and
- A minimum of four cadets.

TIME

A maximum of 30 minutes.

SAFETY CONSIDERATIONS

Equipment and supplies must be safely handled.

LEADERSHIP ASSIGNMENT Complete a Final Garbage Sweep
ASSIGNMENT DESCRIPTION Organize a team of cadets to complete a final garbage sweep. Conduct a final garbage sweep, ensuring all areas used are free of garbage.
RESOURCES <ul style="list-style-type: none">• Garbage bags, and• A minimum of 10 cadets.
TIME A maximum of 20 minutes.
SAFETY CONSIDERATIONS N/A.

LEADERSHIP ASSIGNMENT

Unload Equipment and Supplies After

ASSIGNMENT DESCRIPTION

Organize a team to unload team equipment and supplies from the supply vehicle. Place the equipment in a designated area.

RESOURCES

- Supply vehicle, and
- A minimum of four cadets.

TIME

A maximum of 20 minutes.

SAFETY CONSIDERATIONS

Equipment should be kept out of high traffic areas.

<p style="text-align: center;">LEADERSHIP ASSIGNMENT</p> <p style="text-align: center;">Collect Personal Equipment</p>
<p>ASSIGNMENT DESCRIPTION</p> <p>Organize a team to collect personal equipment (e.g., sleeping bags and air mattresses) after completing weekend training. Count all equipment and report numbers to the directing staff after completing the assignment.</p>
<p>RESOURCES</p> <ul style="list-style-type: none">• Paper,• Pen/pencil,• Cadets with personal equipment to return, and• A minimum of three cadets for collection.
<p>TIME</p> <p>A maximum of 20 minutes.</p>
<p>SAFETY CONSIDERATIONS</p> <p>N/A.</p>

THIS PAGE INTENTIONALLY LEFT BLANK

LEADERSHIP ASSIGNMENT PLANNING GUIDE

ENSURE GOAL

Questions to the directing staff (e.g., time to complete the task, etc)

REQUIRED RESOURCES

Task assignment to peers/allocating resources (e.g., are all tasks accomplished, etc)

MAKE A PLAN

Reconnaissance of area, etc

COMPLETE THE TIME APPRECIATION

DIAGRAMS

THIS PAGE INTENTIONALLY LEFT BLANK

LESSON ACTIVITIES

LIST OF ACTIVITIES FOR ANNEX N

Title		Page Number
ENERGIZERS	Toe to Toe	3N-2
	Pass the Buck	3N-3
	Toe Tag	3N-4
	Triangle Tag	3N-5
	What Can You Do With This?	3N-6
ICEBREAKERS	Personal Trivia	3N-7
	ESP	3N-8
	One Common Goal	3N-9

TEAM-BUILDING ACTIVITY	ENERGIZER
TOE TO TOE	TIME: 10 min
RESOURCES <ul style="list-style-type: none">• A large, open space free from obstacles, and• Masking tape.	
ACTIVITY LAYOUT <p>Place the masking tape in a straight line approximately 4.5 m (15 feet) long on the ground.</p>	
ACTIVITY INSTRUCTIONS <ol style="list-style-type: none">1. Divide the cadets into pairs.2. Have each pair stand facing each other as if they were standing on a tight rope (on the masking tape line). The cadets are to stand with their right foot in front of the left, with the left foot directly in line with the right and about one foot length behind.3. Have the cadets move toward each other so the toes of their right feet are touching.4. Have the cadets grasp right hands in a handshake.5. Explain the following to the cadets:<ol style="list-style-type: none">(a) The objective of the activity is to try to bring their partner off balance and try to get them to fall off the tight rope (masking tape).(b) At no time may the cadets let go of their partners' hand.(c) They are not permitted to use their feet to try to knock their partner off balance. Feet must remain positioned on the line at all times.(d) All movements must be made in slow motion. They are not permitted to push or shove their partner. There is to be no sharp, thrusting movements or any sudden shifts in movement.6. On the start signal, have the cadets try to knock their partner off balance and step off the tight rope (masking tape).7. As time permits, have the cadets switch partners and attempt the activity again.	
SAFETY <p>N/A.</p>	
REFERENCE <p>(ISBN 0-934387-05-2) Collard, M. (2005). <i>No Props: Great Games With No Equipment</i>. (pp. 77–78). Beverly, MA: Project Adventure, Inc.</p>	

TEAM-BUILDING ACTIVITY	ENERGIZER
PASS THE BUCK	TIME: 10 min
RESOURCES <ul style="list-style-type: none">• A large, open space free from obstacles,• Stopwatch,• First set of objects for passing (e.g., bag of potato chips, air-filled balloon, roll of masking tape, mug, small ball, newspaper, etc), and• Second set of objects for passing (e.g., bag of potatoes, mug full of water, water-filled balloon, pillow, rolled sleeping bag, large ball, large textbook, etc).	
ACTIVITY LAYOUT <p>N/A.</p>	
ACTIVITY INSTRUCTIONS <ol style="list-style-type: none">1. Have the cadets stand in a circle, facing the centre.2. Assign one cadet as the “point”. This cadet will indicate the beginning and end of each cycle.3. Explain the following to the cadets:<ol style="list-style-type: none">(a) The objective of the activity is to pass the set of objects around the circle three times.(b) Each time the last object passes the “point” a cycle is complete.(c) If an object is dropped, all objects must go back to the “point” to begin again.(d) If the objects are successfully passed around the circle three times in one minute, 15 points are awarded. Each additional item that completes a cycle, earns the group one point.4. Start the activity by passing the objects to the “point” one at a time. At this time, start the stopwatch for one minute.5. Continue this activity until time has lapsed or the cadets understand the objective of the activity.6. As time allows, have the cadets follow the directions for the second set of objects.	
SAFETY <p>N/A.</p>	
REFERENCE <p>(ISBN 0-7879-4835-7) Sugar, S., & Takacs, G. (2000). <i>Games That Teach Teams</i>. (pp. 139–142). San Francisco, CA: Jossey-Bass/Pfeiffer.</p>	

TEAM-BUILDING ACTIVITY	ENERGIZER
TOE TAG	TIME: 10 min
RESOURCES A large, open space free from obstacles.	
ACTIVITY LAYOUT N/A.	
ACTIVITY INSTRUCTIONS <ol style="list-style-type: none">1. Divide the cadets into partners.2. Have each set of partners stand apart from the other cadets.3. Have the partners stand with their backs to one another.4. On a start signal, have the cadets spin around in a 180-degree circle and try to “tag” the toe of their partner before they get tagged.5. Each set of partners should attempt this two to three times.6. Have the cadets switch partners and try the activity again.	
SAFETY Ensure the cadets remember the name of the game is “tag”, not “stomp”.	
REFERENCE (ISBN 0-934387-05-2) Collard, M. (2005). <i>No Props: Great Games With No Equipment</i> . (p. 97). Beverly, MA: Project Adventure, Inc.	

TEAM-BUILDING ACTIVITY	ENERGIZER
TRIANGLE TAG	TIME: 10 min
RESOURCES A large, open space free from obstacles.	
ACTIVITY LAYOUT N/A.	
ACTIVITY INSTRUCTIONS <ol style="list-style-type: none">1. Have one cadet volunteer to be “it”.2. Divide the remainder of the cadets into groups of three.3. Have each group form a circle, holding hands and facing the centre of their circle.4. Explain the following to the cadets:<ol style="list-style-type: none">(a) One cadet within each circle will be designated to be tagged—the “tagee”. The other two members of the group will be that cadet’s protectors.(b) On a start signal, the cadet who is “it” must try to tag the cadet within the circle who is designated the “tagee”.(c) The cadets are to protect the “tagee” by spinning in circles to avoid the cadet who is “it”.(d) If a cadet is tagged, they will become “it” and the former cadet who was “it” will join the group with a new cadet being designated the “tagee”.(e) After a couple of minutes if the same cadet is still “it” change the roles of the cadets and give someone else an opportunity to be “it”.5. On a start signal, have the cadets begin to spin to avoid the cadet designated as “it”.	
SAFETY N/A.	
REFERENCE (ISBN 0-934387-05-2) Collard, M. (2005). <i>No Props: Great Games With No Equipment</i> . (p. 98). Beverly, MA: Project Adventure, Inc.	

TEAM-BUILDING ACTIVITY	ENERGIZER
WHAT CAN YOU DO WITH THIS?	TIME: 10 min
RESOURCES <ul style="list-style-type: none">• A large, open space,• An odd object (e.g., staple remover, kitchen tongs, kitchen strainer, plastic container, etc),• Paper, and• Pens/pencils (one per group).	
ACTIVITY LAYOUT <p>N/A.</p>	
ACTIVITY INSTRUCTIONS <ol style="list-style-type: none">1. Divide the cadets into two groups.2. Distribute a piece of paper and a pen/pencil to each group.3. Explain the following to the cadets:<ol style="list-style-type: none">(a) Once they see an item they will have to list as many possible uses for the object as they can.(b) They will have a time limit of five minutes to make the list.(c) After the time is up both groups are to come back together and the lists will be discussed as a full group.4. Pull the object out of the bag and have the cadets begin their lists.5. After five minutes, have the groups come together and present their lists to the other groups.	
SAFETY <p>N/A.</p>	
REFERENCE <p>(ISBN 0-9662341-6-2) Jones, A. (1999). <i>Team-Building Activities for Every Group</i>. (p. 25). Richland, WA: Rec Room Publishing.</p>	

TEAM-BUILDING ACTIVITY	ICEBREAKER
PERSONAL TRIVIA	TIME: 10–15 min
RESOURCES <ul style="list-style-type: none">• A large, open space free from obstacles,• Index cards (one per cadet),• Paper (one sheet per cadet), and• Pens/pencils (one per cadet).	
ACTIVITY LAYOUT <p>N/A.</p>	
ACTIVITY INSTRUCTIONS <ol style="list-style-type: none">1. Distribute an index card and a pen/pencil to each cadet.2. Have each cadet write the following on their index card:<ol style="list-style-type: none">(a) their name, and(b) five little-known facts about themselves (e.g., favourite movie, favourite singer/band, favourite television show, favourite restaurant, favourite sport, etc).3. Collect all of the index cards.4. Distribute a piece of paper to each cadet.5. Read out each index card, one at a time, and have each cadet write down the name of the cadet whose card they think was read.6. After the last card was read, have the cadets read out their guesses and identify which cadets guessed them correctly.	
SAFETY <p>N/A.</p>	
REFERENCE <p>(ISBN 0-9662341-6-2) Jones, A. (1999). <i>Team-Building Activities for Every Group</i>. (p. 26). Richland, WA: Rec Room Publishing.</p>	

TEAM-BUILDING ACTIVITY	ICEBREAKER
ESP	TIME: 10–15 min
RESOURCES A large, open space free from obstacles.	
ACTIVITY LAYOUT N/A.	
ACTIVITY INSTRUCTIONS <ol style="list-style-type: none">Demonstrate three physical gestures that will be used for the activity. The three gestures should be from a similar category. For example, three of the following sports-related gestures could be chosen:<ol style="list-style-type: none">swimming;swinging a golf club;swinging a baseball bat;shooting a hockey puck; orkicking a soccer ball.Divide the cadets into pairs.Have the cadets practice these gestures a couple of times.Have the pairs line up back to back in a straight line with plenty of room between each set of pairs.Explain the following to the cadets:<ol style="list-style-type: none">The objective of the activity is to try to perform the same gesture as your partner, without any clues, as many times as possible.On a start signal from the leader, the cadets will turn around and face their partner while performing one of the three given gestures.After completing each gesture, the partners will stand back to back again without giving any clues to each other as to the next gesture they will perform.The cadets will continue to do this on each start signal from the leader until the time is complete.The cadets should count how many times they successfully performed the same gesture as their partner.Upon completion of the activity, have each group state how many times they were successful.On a given start signal have the cadets turn around to face their partner while performing one of the gestures.Have the cadets continue this until the time has lapsed.Have the cadets state how many times they were successful at performing the same gesture as their partner on completion of the activity.	
SAFETY N/A.	
REFERENCE (ISBN 0-934387-05-2) Collard, M. (2005). <i>No Props: Great Games With No Equipment</i> . (pp. 57–58). Beverly, MA: Project Adventure, Inc.	

TEAM-BUILDING ACTIVITY	ICEBREAKER
ONE COMMON GOAL	TIME: 10–15 min
RESOURCES <ul style="list-style-type: none">• A large, open space,• Paper (one sheet per pair), and• Pens/pencils (one per pair).	
ACTIVITY LAYOUT <p>N/A.</p>	
ACTIVITY INSTRUCTIONS <ol style="list-style-type: none">1. Divide the cadets into pairs.2. Distribute a piece of paper and a pen/pencil to each pair.3. Explain that each pair is to think of as many common traits (e.g., hair colour, number of siblings) between them as they can and write them on the piece of paper.4. After approximately six minutes, have the cadets come together as a group and present their common traits one pair at a time.	
SAFETY <p>N/A.</p>	
REFERENCE <p>(ISBN 0-9662341-6-2) Jones, A. (1999). <i>Team-Building Activities for Every Group</i>. (p. 31). Richland, WA: Rec Room Publishing.</p>	

THIS PAGE INTENTIONALLY LEFT BLANK

ENERGIZERS AND ICEBREAKERS ACTIVITIES

LIST OF ACTIVITIES FOR ANNEX O

Title	Page Number	
ENERGIZERS	Shipwreck	30-2
	Balloons	30-3
	Mirror Image	30-4
	Have You Ever?	30-5
	Zip Zap	30-6
	Tall Ship	30-7
	Chic-a-Boom	30-8
	Pig Personality Profile	30-9
	Circle the Circle	30-10
	Clumps	30-11
	Cadet Feud #1	30-12
	Cadet Feud #2	30-14
	Tiny Teach	30-16
	Four Up	30-17
	Yurt Circle	30-18
	Hoop Relay	30-19
	All Aboard	30-21
	Line Up	30-22
	Pick Pocket	30-23
	About Now	30-25
Mass Stand Up	30-26	
Word Puzzle	30-27	
ICEBREAKERS	Categories	30-30
	Human Scavenger Hunt	30-31
	The Walking Billboard	30-32
	Getting Acquainted	30-33
	Bingo Blast	30-34
	Team Charades	30-36
	Double Take	30-37
	Peculiarities	30-38
	I Like Me Because	30-40
	Group Juggle	30-41
	Meet 'N Greet	30-42
	Who Are You?	30-43
	Birthday Line	30-44
	A Coat of Arms	30-45
Martian Names	30-47	

TEAM-BUILDING ACTIVITY	ENERGIZER
SHIPWRECK	TIME: 10 min
RESOURCES <ul style="list-style-type: none">• A large, open space free from obstacles,• Rope (enough for 0.5 m [1.6 feet] per group), and• Scissors.	
ACTIVITY LAYOUT <p>Cut the rope into 0.5 m (1.6 feet) lengths and tie to make one circle per group.</p>	
ACTIVITY INSTRUCTIONS <ol style="list-style-type: none">1. Divide the cadets into groups of five.2. Give each group a “ship” (rope circle).3. With all members holding on to the sides of the “ship”, the cadets must run back and forth the length of the playing field.4. When the leader yells “SHARK”, all members must lay the “ship” down and jump “on board” (inside the rope circle). The first group with all feet off the ground gains a point.5. Repeat the procedure until a group reaches five points.	
SAFETY <p>N/A.</p>	
REFERENCE <p>(ISBN 0-8403-5682-X) Rohnke, K. (1984). <i>Silver Bullets: A Guide to Initiative Problems, Adventure Games and Trust Activities</i>. (p. 112). Dubuque, IA: Kendall/Hunt Publishing Company.</p>	

TEAM-BUILDING ACTIVITY	ENERGIZER
BALLOONS	TIME: 10 min
RESOURCES <ul style="list-style-type: none">• A large, open space free from obstacles,• Balloons (a minimum of one per group),• Funnel, and• Water.	
ACTIVITY LAYOUT <p>Blow up the balloons and put a small amount of water in each.</p>	
ACTIVITY INSTRUCTIONS <ol style="list-style-type: none">1. Divide the cadets into groups of five.2. Have each group form a circle.3. Give each group a balloon with a small amount of water in it.4. Have the cadets try to keep the balloon off the ground by using their feet to hit it to the other cadets in the group.5. Encourage teams to try to keep the balloon moving from cadet to cadet for as long as possible.	
SAFETY <p>N/A.</p>	
REFERENCE <p>(ISBN 0-8403-5682-X) Rohnke, K. (1984). <i>Silver Bullets: A Guide to Initiative Problems, Adventure Games and Trust Activities</i>. (p. 67). Dubuque, IA: Kendall/Hunt Publishing Company.</p>	

TEAM-BUILDING ACTIVITY	ENERGIZER
MIRROR IMAGE	TIME: 10 min
RESOURCES A large, open space free from obstacles.	
ACTIVITY LAYOUT N/A.	
ACTIVITY INSTRUCTIONS <ol style="list-style-type: none">1. Divide the cadets into pairs (pairs should be close to the same height).2. Within each pair, have one cadet initiate an action and the other imitate it, becoming the “mirror image”.3. Encourage the initiator to make slow movements, stretches and jumps.4. Swap roles after a few minutes.	
SAFETY N/A.	
REFERENCE (ISBN 0-934387-05-2) Collard, M. (2005). <i>No Props: Great Games With No Equipment</i> . (pp. 76–77). Beverly, MA: Project Adventure, Inc.	

TEAM-BUILDING ACTIVITY	ENERGIZER
HAVE YOU EVER?	TIME: 10 min
RESOURCES A large, open space free from obstacles.	
ACTIVITY LAYOUT N/A.	
ACTIVITY INSTRUCTIONS <ol style="list-style-type: none">1. Have the cadets form a circle, either seated or standing.2. Ask for a volunteer to sit or stand in the middle (the “questioner”).3. Have the “questioner” ask an appropriate question to the group that is prefaced with “Have you ever....?” (e.g., Have you ever stayed up for 48 hours straight? Have you ever been to another Cadet Summer Training Centre?). The question that the “questioner” asks must be something that they have actually done.4. If there are cadets in the circle who have experienced what the “questioner” asked, they are to leave their place in the circle and find an empty place somewhere else in the circle. The “questioner” also tries to find an empty space.5. The person who is left without a place in the circle once everyone has moved is the new “questioner”.6. Continue the process with a new “questioner”.	
SAFETY N/A.	
REFERENCE (ISBN 0-934387-05-2) Collard, M. (2005). <i>No Props: Great Games With No Equipment</i> . (pp. 193–194). Beverly, MA: Project Adventure, Inc.	

TEAM-BUILDING ACTIVITY	ENERGIZER
ZIP ZAP	TIME: 10 min
RESOURCES A large, open space free from obstacles.	
ACTIVITY LAYOUT N/A.	
ACTIVITY INSTRUCTIONS <ol style="list-style-type: none">1. Have the cadets stand in a circle.2. Ask for a volunteer to stand in the middle. This cadet is the “zipper”.3. Have the “zipper” approach someone with their hands pressed together and all fingers pointing forward, look them straight in the eye and say “zip”.4. Once “zip” is called, the cadet being pointed at is to duck down—the “ducker”. The two cadets on each side of the “ducker” are to face in toward each other, with their hands clasped and index fingers pointing at the other person. Each cadet is to yell “zap” at the other person (this will usually occur simultaneously). These people are the “zappers”.5. If the “ducker” does not duck quick enough or a cadet gets zapped, that cadet is to go to the middle and become the new “zipper”.6. After two or three rounds, invite another “zipper” to the middle to create more challenge. Continue the activity with two or more “zippers”.	
SAFETY N/A.	
REFERENCE (ISBN 0-934387-05-2) Collard, M. (2005). <i>No Props: Great Games With No Equipment</i> . (pp. 58–59). Beverly, MA: Project Adventure, Inc.	

TEAM-BUILDING ACTIVITY	ENERGIZER
TALL SHIP	TIME: 10 min
RESOURCES A large, open space free from obstacles.	
ACTIVITY LAYOUT Determine the bow, stern, port and starboard sides of the “ship”.	
ACTIVITY INSTRUCTIONS <ol style="list-style-type: none">1. Have the cadets stand in a circle in the centre of the “ship”.2. Demonstrate and explain the seaworthy terms and chores that the cadets will be performing:<ol style="list-style-type: none">(a) “Bow”—move to the front;(b) “Stern”—move to the rear;(c) “Port”—move to the left;(d) “Starboard”—move to the right;(e) “Attention”—cadets stand at attention and salute;(f) “Swab the Deck”—cadets get on their hand and knees and scrub the deck;(g) “Sailor Overboard”—all cadets drop to the deck on either the port or starboard sides;(h) “Lifeboats”—groups of three form a single file line, sit and pretend to row a boat; and(i) “Rig the Sails”—groups of two join hands and pretend to set up the sails.3. As the Captain, issue a series of commands to the cadets.	
SAFETY N/A.	
REFERENCE (ISBN 0-934387-05-2) Collard, M. (2005). <i>No Props: Great Games With No Equipment</i> . (pp. 87–88). Beverly, MA: Project Adventure, Inc.	

TEAM-BUILDING ACTIVITY	ENERGIZER
CHIC-A-BOOM!	TIME: 10 min
RESOURCES A large, open space free from obstacles.	
ACTIVITY LAYOUT Look over the dance moves and the words to the Chic-a-Boom song.	
ACTIVITY INSTRUCTIONS <ol style="list-style-type: none">1. Have the group stand in a circle.2. Teach the group the following moves—with the index fingers, point up to the sky and alternate thrusts of each hand to a beat (e.g., left hand up, then right hand up). Point down with alternating thrusts, point to the left while taking rocking steps and point to the right while taking rocking steps.3. Using the dancing moves, teach the cadets the Chic-a-Boom song: <i>“Hey there (enter name), you’re a real cool cat. You’ve got a lot of this, and you’ve got a lot of that. So come on in and get down... ...aaaand, up chic-a-boom, chic-a-boom, chic-a-boom. And down chic-a-boom, chic-a-boom, chic-a-boom. To the left, chic-a-boom, chic-a-boom, chic-a-boom. To the right, chic-a-boom, chic-a-boom, chic-a-boom.”</i>4. Have one cadet volunteer to be the first cadet to go in the middle of the circle.5. Have the cadets sing the song and complete the dance moves. The cadet in the middle begins to sing while looking directly at someone in the circle. When the song gets to the “<i>come on in and get down</i>” part, have the cadet in the middle sidle up to another cadet, link arms and lead them to the centre of the circle.6. On the next turn, both cadets stay in the middle and bring another cadet in, and so on.7. Encourage cadets to be creative and expressive with their singing and dancing when they are in the middle of the circle. They could bring some attitude or even beat boxing into the circle.8. The activity ends when all cadets are in the middle of the circle.	
SAFETY N/A.	
REFERENCE (ISBN 0-934387-05-2) Collard, M. (2005). <i>No Props: Great Games With No Equipment</i> . (pp. 74–75). Beverly, MA: Project Adventure, Inc.	

TEAM-BUILDING ACTIVITY	ENERGIZER
PIG PERSONALITY PROFILE	TIME: 10 min
RESOURCES <ul style="list-style-type: none">• Paper (one sheet per cadet), and• Pens/pencils (one per cadet).	
ACTIVITY LAYOUT <p>N/A.</p>	
ACTIVITY INSTRUCTIONS <ol style="list-style-type: none">1. Distribute a piece of paper and a pen/pencil to each cadet.2. Read the following out loud, “On a blank piece of paper, draw a pig. Don’t look at your neighbour’s pig. Don’t even glance.”3. Allow approximately three minutes for the cadets to draw a pig.4. When all cadets are finished, allow a few moments for the cadets to look at their neighbours’ pigs.5. Explain that the pig drawings could indicate a person’s personality traits. Share the personality traits of the pig exercise with the group. If the pig is drawn:<ol style="list-style-type: none">(a) toward the top of the paper, you are a positive, cheerful person;(b) toward the middle of the paper (top to bottom), you are a practical person;(c) toward the bottom of the paper, you are gloomy and have a tendency to behave negatively;(d) facing left, you believe in tradition, are friendly and remember dates, including birthdays;(e) facing forward (looking toward you), you are direct, enjoy playing devil’s advocate and neither fear nor avoid discussions;(f) facing right, you are innovative and active but don’t have a strong sense of family, nor do you remember dates;(g) with many details, you are investigative, cautious and distrustful;(h) with few details, you are emotional and naïve, care little for details and are a risk taker;(i) with four legs showing, you are secure, stubborn and stick to your ideals;(j) with less than four legs showing, you are insecure or are living through a period of major change;(k) the size of the pig’s ears indicates how good a listener you are—large is good; and(l) the length of the pig’s tail indicates your energy level—longer indicates more.6. Allow time for the cadets to discuss their pigs with others.	
SAFETY <p>N/A.</p>	
REFERENCE <p>(ISBN 0-943210-44-5) Pike. B., & Busse, C. (1995). <i>101 More Games for Trainers</i>. (pp. 102–103). Minneapolis, MN: Lakewood Publications.</p>	

TEAM-BUILDING ACTIVITY	ENERGIZER
CIRCLE THE CIRCLE	TIME: 10 min
RESOURCES <ul style="list-style-type: none">• A large, open space free from obstacles, and• Hula hoop.	
ACTIVITY LAYOUT N/A.	
ACTIVITY INSTRUCTIONS <ol style="list-style-type: none">1. Have the cadets form a circle and hold hands with the cadet on either side of them.2. Rest a hula hoop on two cadets' grasped hands.3. Have the cadets try to have the hoop travel around the circle, while everyone is still holding hands.4. If the activity is completed quickly, have the cadets try again.	
SAFETY N/A.	
REFERENCE (ISBN 0-8403-5682-X) Rohnke, K. (1984). <i>Silver Bullets: A Guide to Initiative Problems, Adventure Games and Trust Activities</i> . (p. 60). Dubuque, IA: Kendall/Hunt Publishing Company.	

TEAM-BUILDING ACTIVITY	ENERGIZER
CLUMPS	TIME: 10 min
RESOURCES A large, open space free from obstacles.	
ACTIVITY LAYOUT N/A.	
ACTIVITY INSTRUCTIONS <ol style="list-style-type: none">1. Have the cadets gather in the designated space.2. Explain that numbers will be shouted out (e.g., “four”, “seven”, etc). When numbers are shouted out, the cadets are to form groups consisting of that number of people. Those cadets who do not form a group can simply wait until another number is shouted out, and then form a group.3. If the cadets catch on quickly, add a new rule that each cadet cannot form a new group with any cadet who was in their previous group.	
SAFETY N/A.	
REFERENCE (ISBN 0-934387-05-2) Collard, M. (2005). <i>No Props: Great Games With No Equipment</i> . (pp. 32–33). Beverly, MA: Project Adventure, Inc.	

TEAM-BUILDING ACTIVITY	ENERGIZER
CADET FEUD #1	TIME: 10 min
RESOURCES <ul style="list-style-type: none">• Cadet Feud Survey (one per cadet),• Scissors,• Pens/pencils (one per cadet),• Tennis ball,• Chalkboard/whiteboard, and• Chalk or whiteboard markers.	
ACTIVITY LAYOUT <ul style="list-style-type: none">• Photocopy, cut out and have the cadets complete the survey.• Conduct the attached survey.• Tally and rank the top five answers for each question.• Prepare the chalkboard/whiteboard by writing the numbers one through five.	
ACTIVITY INSTRUCTIONS <p>Note: This game is played in the same manner as the television show “Family Feud.”</p> <ol style="list-style-type: none">1. Divide the group into two teams and have them sit facing each other.2. Place a tennis ball on a table or on the floor. Have the first person from each team come forward and sit an equal distance away from the tennis ball (this will serve as the “buzzer”).3. Ask the first question (e.g., “Name five of the top restaurants.”). The first person to grab the ball will get a chance to answer the question. If the ball is grabbed early, stop reading the question and allow for the cadet to give an answer.4. If the cadet gives an answer that is on the list, write it beside the corresponding number. If this person has not guessed the number one answer, the other player may have a turn to guess. The person who guesses the highest answer on the list gets to choose whether his/her team will play or pass.5. After this, each team gets three strikes (wrong answers). The team that is playing gets the chance to guess the remaining answers on the board. Give each person a turn, down the line.6. Once the playing team gets three strikes, the other team decides as a group what one answer they want to give to try to fill in one of the remaining blanks.7. If the first team fills in all the blanks, they win the round, but if the opposing team guesses one of the remaining answers, they win the round.8. Continue with the rest of the questions in the same manner.	
SAFETY <p>N/A.</p>	
REFERENCE <p>(ISBN 0-9662341-6-2) Jones, A. (1999). <i>Team-Building Activities for Every Group</i>. (pp. 36–37). Richland, WA: Rec Room Publishing.</p>	

CADET FEUD SURVEY

Answer the following questions. Be sure to write only one answer.

Questions	Answers
1. What is your favourite restaurant?	
2. What is your favourite type of music?	
3. What is your hair colour?	
4. What is your favourite shampoo?	
5. What is your favourite winter activity?	

CADET FEUD SURVEY

Answer the following questions. Be sure to write only one answer.

Questions	Answers
1. What is your favourite restaurant?	
2. What is your favourite type of music?	
3. What is your hair colour?	
4. What is your favourite shampoo?	
5. What is your favourite winter activity?	

CADET FEUD SURVEY

Answer the following questions. Be sure to write only one answer.

Questions	Answers
1. What is your favourite restaurant?	
2. What is your favourite type of music?	
3. What is your hair colour?	
4. What is your favourite shampoo?	
5. What is your favourite winter activity?	

CADET FEUD SURVEY

Answer the following questions. Be sure to write only one answer.

Questions	Answers
1. What is your favourite restaurant?	
2. What is your favourite type of music?	
3. What is your hair colour?	
4. What is your favourite shampoo?	
5. What is your favourite winter activity?	

TEAM-BUILDING ACTIVITY	ENERGIZER
CADET FEUD #2	TIME: 10 min
RESOURCES REQUIRED <ul style="list-style-type: none">• Cadet Feud Survey (one per cadet),• Scissors,• Pens/pencils (one per cadet),• Tennis ball,• Chalkboard/whiteboard, and• Chalk or whiteboard markers.	
ACTIVITY LAYOUT <ul style="list-style-type: none">• Photocopy, cut out and have the cadets complete the survey.• Conduct the attached survey.• Tally and rank the top five answers for each question.• Prepare the chalkboard or whiteboard by writing the numbers one through five.	
ACTIVITY INSTRUCTIONS <p>Note: This game is played in the same manner as the television show “Family Feud.”</p> <ol style="list-style-type: none">1. Divide the group into two teams and have them sit facing each other.2. Place a tennis ball on a table or on the floor. Have the first person from each team come forward and sit an equal distance away from the tennis ball (this will serve as the “buzzer”).3. Ask the first question (e.g., “Name five of the top celebrities.”). The first person to grab the ball will get a chance to answer the question. If the ball is grabbed early, stop reading the question and allow for the cadet to give an answer.4. If the cadet gives an answer that is on the list, write it beside the corresponding number. If this person has not guessed the number one answer, the other player may have a turn to guess. The person who guesses the highest answer on the list gets to choose whether his/her team will play or pass.5. After this, each team gets three strikes (wrong answers). The team that is playing gets the chance to guess the remaining answers on the board. Give each person a turn, down the line.6. Once the playing team gets three strikes, the other team decides as a group what one answer they want to give to try to fill in one of the remaining blanks.7. If the first team fills in all the blanks, they win the round, but if the opposing team guesses one of the remaining answers, they win the round.8. Continue with the rest of the questions in the same manner.	
SAFETY <p>N/A.</p>	
REFERENCE <p>(ISBN 0-9662341-6-2) Jones, A. (1999). <i>Team-Building Activities for Every Group</i>. (pp. 36–37). Richland, WA: Rec Room Publishing.</p>	

CADET FEUD SURVEY

Answer the following questions. Be sure to write only one answer.

Questions	Answers
1. Who is your favourite celebrity?	
2. Where is your favourite place to shop (store name)?	
3. What is your favourite sport?	
4. What is the colour of your toothbrush?	
5. What is your dream job?	

CADET FEUD SURVEY

Answer the following questions. Be sure to write only one answer.

Questions	Answers
1. Who is your favourite celebrity?	
2. Where is your favourite place to shop (store name)?	
3. What is your favourite sport?	
4. What is the colour of your toothbrush?	
5. What is your dream job?	

CADET FEUD SURVEY

Answer the following questions. Be sure to write only one answer.

Questions	Answers
1. Who is your favourite celebrity?	
2. Where is your favourite place to shop (store name)?	
3. What is your favourite sport?	
4. What is the colour of your toothbrush?	
5. What is your dream job?	

CADET FEUD SURVEY

Answer the following questions. Be sure to write only one answer.

Questions	Answers
1. Who is your favourite celebrity?	
2. Where is your favourite place to shop (store name)?	
3. What is your favourite sport?	
4. What is the colour of your toothbrush?	
5. What is your dream job?	

TEAM-BUILDING ACTIVITY	ENERGIZER
TINY TEACH	TIME: 10 min
RESOURCES A large, open space free from obstacles.	
ACTIVITY LAYOUT N/A.	
ACTIVITY INSTRUCTIONS <ol style="list-style-type: none">1. Divide the cadets into pairs.2. Explain that there will be a series of partner activities announced that the cadets will have to perform.3. Introduce each performance:<ol style="list-style-type: none">(a) Tie a Pair of Shoelaces. Each pair of cadets will untie the laces of the shoe closest to their partner as they stand side by side. The object is for each pair of cadets, using only one hand, to tie the shoelaces (one from each shoe) together with a standard bow.(b) Whistle in Your Hands. Cup the hands tightly together to form an air-tight container, but leave a small gap in the top between the thumbs. Try to make a hollow-pitched whistle sound.(c) Tell a Joke. No matter how long or short, funny or not, pass on an appropriate joke to the other cadet.(d) Let Me Show You. Each cadet will present a skill or talent they choose to their partner (e.g., curl of the tongue, a yoga move, etc).(e) Body Gym. Each pair takes turns showing and teaching the other how to do something completely bizarre with their bodies.4. Call out a performance and have each pair of cadets perform it. Continue calling out different performances.	
SAFETY N/A.	
REFERENCE (ISBN 0-934387-05-2) Collard, M. (2005). <i>No Props: Great Games With No Equipment.</i> (pp. 44–45). Beverly, MA: Project Adventure, Inc.	

TEAM-BUILDING ACTIVITY	ENERGIZER
FOUR UP	TIME: 10 min
RESOURCES A large, open space free from obstacles.	
ACTIVITY LAYOUT N/A.	
ACTIVITY INSTRUCTIONS <ol style="list-style-type: none">1. Have the group sit on the ground, with space between each cadet.2. Explain to the cadets that anyone can stand up when they would like to, but no one can remain standing for longer than five seconds before they sit again.3. Once some cadets begin to stand, tell them that the goal is to have exactly four people standing up at all times.	
SAFETY N/A.	
REFERENCE (ISBN 0-934387-05-2) Collard, M. (2005). <i>No Props: Great Games With No Equipment</i> . (p. 172). Beverly, MA: Project Adventure, Inc.	

TEAM-BUILDING ACTIVITY	ENERGIZER
YURT CIRCLE	TIME: 10 min
RESOURCES A large, open space with a non-slip surface.	
ACTIVITY LAYOUT N/A.	
ACTIVITY INSTRUCTIONS <ol style="list-style-type: none">1. Have the cadets form a circle and grasp the hands or wrists of their neighbours.2. Have the cadets move back and stretch out the circle without letting go (not to the full extent of the arms).3. With everyone's feet together and planted on the ground, instruct everyone to lean backwards.4. Encourage the cadets to adjust the position of their feet if they are uncomfortable.5. Try to get everyone to fully support each other's weight. This may take a few tries!	
SAFETY Ensure cadets look out for the safety of each other so they do not fall backwards.	
REFERENCE (ISBN 0-934387-05-2) Collard, M. (2005). <i>No Props: Great Games With No Equipment</i> . (pp. 91 and 92). Beverly, MA: Project Adventure, Inc.	

TEAM-BUILDING ACTIVITY	ENERGIZER
HOOP RELAY	TIME: 10 min
RESOURCES <ul style="list-style-type: none">• A large, open space free from obstacles, and• Hula hoops (four).	
ACTIVITY LAYOUT <p>N/A.</p>	
ACTIVITY INSTRUCTIONS <ol style="list-style-type: none">1. Have the cadets form a single file, one behind the other.2. Have the cadets hold hands front-to-back by reaching backward through their legs to grasp the free hand of the person behind them.3. Designate one cadet to be the “starter”. Have the “starter” stand in front of the line, holding four hula hoops.4. Explain that when signalled to begin the game, the “starter” will place one of the hula hoops over the head of the first person in line. The cadets will have to try to have the hula hoop travel from cadet to cadet. When the first hoop reaches the third person in line, the “starter” may add another hoop, and so on. If the “starter” wishes to be part of the game, they can simply start the last hoop and become the first person in line.5. Signal to begin the game.6. When the first hoop reaches the last cadet in the line, they will run to the front of the line with the hoop, grab the hand of the now second cadet and start to move the hoop to the end of the line.7. Continue until the original front cadet returns to their original position.	
SAFETY <p>N/A.</p>	
REFERENCE <p>(ISBN 0-8403-5682-X) Rohnke, K. (1984). <i>Silver Bullets: A Guide to Initiative Problems, Adventure Games and Trust Activities</i>. (p. 61). Dubuque, IA: Kendall/Hunt Publishing Company.</p>	

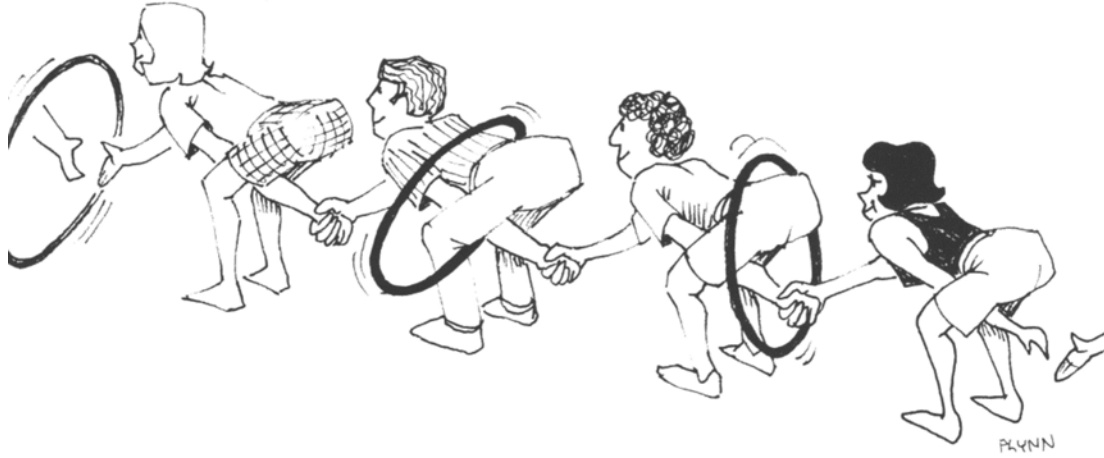

K. Rohnke, Silver Bullets: A Guide to Initiative Problems, Adventure Games and Trust Activities, Kendall/Hunt Publishing Company (p. 61)

Figure 3O-1 Hoop Relay

TEAM-BUILDING ACTIVITY	ENERGIZER
ALL ABOARD	TIME: 10 min
RESOURCES <ul style="list-style-type: none">• A large, open space free from obstacles,• Balloons of varying colours (two per cadet), and• Markers (one per group).	
ACTIVITY LAYOUT <p>N/A.</p>	
ACTIVITY INSTRUCTIONS <ol style="list-style-type: none">1. Divide the cadets into groups of four.2. Distribute deflated balloons of varying colours around the space.3. Have each group get into train formation (together in single file) and give the first person in each line, the “engine”, a marker.4. Explain to the cadets that each group is a passenger “train” that must pick up “passengers”, balloons, two per person. Each person in the train will be a “car”.5. Balloons become “passengers” when they are inflated and have a face. One cadet must inflate the balloon, tie it and paint a face on it with the marker.6. Each train must move around together and pick up “passengers”. “Passengers” must be the same colour and everyone must be carrying two. The train must stay still while a cadet is inflating and drawing. The objective is for each train to have all “passengers” that are the same colour.7. The first “train” to reach the destination point with all “passengers” accounted for (two balloons per cadet) wins the game.	
SAFETY <p>N/A.</p>	
REFERENCE <p>(ISBN 0-07-134984-7) West, E. (1999). <i>The Big Book of Icebreakers</i>. (pp. 135–136). New York, NY: McGraw-Hill.</p>	

TEAM-BUILDING ACTIVITY	ENERGIZER
LINE UP	TIME: 10 min
RESOURCES A large, open space free from obstacles.	
ACTIVITY LAYOUT N/A.	
ACTIVITY INSTRUCTIONS 1. Explain to the cadets that instructions will be given for them to line up in a particular way. 2. Once lined up, the group must sit at the same time, to indicate that they are finished. 3. Possible categories include: (a) order of shoe size; (b) alphabetically by favourite colour; (c) order by the number of siblings each cadet has; (d) order by age, youngest to oldest; (e) order by hair colour, lightest to darkest; (f) alphabetically by first name; and (g) alphabetically by last name.	
SAFETY N/A.	
REFERENCE (ISBN 0-07-134984-7) West, E. (1999). <i>The Big Book of Icebreakers</i> . (pp. 87–89). New York, NY: McGraw-Hill.	

TEAM-BUILDING ACTIVITY	ENERGIZER
PICK POCKET	TIME: 10 min
RESOURCES <ul style="list-style-type: none">• Pick Pocket Activity Sheet (one per group),• Scissors,• Pens/pencils (one per group), and• Stopwatch.	
ACTIVITY LAYOUT <p>Photocopy and cut the survey.</p>	
ACTIVITY INSTRUCTIONS <ol style="list-style-type: none">1. Divide the cadets into two groups.2. Explain to the cadets that they will have five minutes to try and find as many items on the Pick Pocket Activity Sheet as possible.3. Distribute a Pick Pocket Activity Sheet to each group.4. Start the activity.5. Once five minutes have passed, bring the cadets back to one area and compare which items were found by each group.	
SAFETY <p>N/A.</p>	
REFERENCE <p>(ISBN 0-07-134984-7) West, E. (1999). <i>The Big Book of Icebreakers</i>. (pp. 53–55). New York, NY: McGraw-Hill.</p>	

PICK POCKET ACTIVITY SHEET

- _____ A purple pen,
- _____ A piece of gum,
- _____ A pair of sunglasses,
- _____ A comb,
- _____ A padlock key,
- _____ A bobby pin,
- _____ A picture of a friend or relative,
- _____ Money,
- _____ A bank card, and
- _____ A mint.

PICK POCKET ACTIVITY SHEET

- _____ A purple pen,
- _____ A piece of gum,
- _____ A pair of sunglasses,
- _____ A comb,
- _____ A padlock key,
- _____ A bobby pin,
- _____ A picture of a friend or relative,
- _____ Money,
- _____ A bank card, and
- _____ A mint.

PICK POCKET ACTIVITY SHEET

- _____ A purple pen,
- _____ A piece of gum,
- _____ A pair of sunglasses,
- _____ A comb,
- _____ A padlock key,
- _____ A bobby pin,
- _____ A picture of a friend or relative,
- _____ Money,
- _____ A bank card, and
- _____ A mint.

TEAM-BUILDING ACTIVITY	ENERGIZER
ABOUT NOW	TIME: 10 min
RESOURCES <ul style="list-style-type: none">• A large, open space free from obstacles, and• Stopwatch.	
ACTIVITY LAYOUT <p>N/A.</p>	
ACTIVITY INSTRUCTIONS <ol style="list-style-type: none">1. Gather the group in an area.2. Explain to the group that on the command “Now” everyone will try to count 60 seconds in their head and then sit. There is to be no talking and the cadets cannot look at their watches.3. While looking at the stopwatch, yell “Now” to signal the cadets to begin.4. Note the cadet who sits down closest to the 60 second time frame.5. When all cadets are sitting, announce who was the closest.6. Repeat the activity.	
SAFETY <p>N/A.</p>	
REFERENCE <p>(ISBN 0-934387-05-2) Collard, M. (2005). <i>No Props: Great Games With No Equipment</i>. (p. 148). Beverly, MA: Project Adventure, Inc.</p>	

TEAM-BUILDING ACTIVITY	ENERGIZER
MASS STAND UP	TIME: 10 min
RESOURCES A large, open space free from obstacles.	
ACTIVITY LAYOUT N/A.	
ACTIVITY INSTRUCTIONS <ol style="list-style-type: none">1. Divide the cadets into two equal groups.2. Have each group sit in a circle, with their backs to the middle.3. Have the cadets in each group link elbows with the cadets sitting on either side of them.4. Explain that on the command “Go” everyone will try to stand up as one.5. Give the command “Go.” This activity may require a lot of encouragement and many tries.	
SAFETY N/A.	
REFERENCE (ISBN 0-8403-5682-X) Rohnke, K. (1984). <i>Silver Bullets: A Guide to Initiative Problems, Adventure Games and Trust Activities</i> . (p. 100). Dubuque, IA: Kendall/Hunt Publishing Company.	

TEAM-BUILDING ACTIVITY	ENERGIZER
WORD PUZZLE	TIME: 10 min
RESOURCES <ul style="list-style-type: none">• A large space,• Word puzzle sheet (one per cadet),• Pens/pencils (one per cadet), and• Stopwatch.	
ACTIVITY LAYOUT <p>Photocopy a word puzzle sheet for every cadet.</p>	
ACTIVITY INSTRUCTIONS <ol style="list-style-type: none">1. Distribute a word puzzle sheet and a pen/pencil to each cadet.2. Explain to the cadets that they have three minutes to try and complete as many word puzzles as possible.3. After three minutes, have the cadets form groups of three. Among the three cadets, encourage them to come up with as many answers as possible.4. Share the word puzzle answers with the cadets.	
SAFETY <p>N/A.</p>	
REFERENCE <p>(ISBN 0-07-046414-6) Scannel, E., & Newstrom, J. (1994). <i>Even More Games Trainers Play</i>. (pp. 137–177). New York, NY: McGraw-Hill Companies.</p>	

WORD PUZZLE

<p>1</p> 	<p>2</p> <p>NE1410S</p>	<p>3</p> <p>CYCLE CYCLE CYCLE</p>	<p>4</p> <p>BALE</p>
<p>5</p> <p>Jan. Feb. Mar. ----- DUE</p>	<p>6</p> 	<p>7</p> <p>HEAD LO VE HEELS</p>	<p>8</p> <p><i>type</i></p>
<p>9</p> <p>L Bus Term L</p>	<p>10</p> <p>BAN ANA</p>	<p>11</p> <p>T K The R C A</p>	<p>BACK CK K</p> <p>12</p>
<p>13</p> <p>LAL</p>	<p>14</p> <p>I'm nhappy</p>	<p>15</p> <p>ME QUIT</p>	<p>16</p> 
<p>17</p> <p>S P L I T</p>	<p>18</p> <p>PETS A</p>	<p>19</p> <p>CITY</p>	<p>20</p> <p>YOU / JUST / ME</p>

WORD PUZZLE ANSWERS

1. A tall tale.
2. Anyone for tennis?
3. Tricycle.
4. Curve ball.
5. Three months overdue.
6. Hole in one.
7. Head over heels in love.
8. Type written.
9. Bus terminals.
10. Banana split.
11. The inside track.
12. Full back, half back, quarterback.
13. All mixed up.
14. I'm unhappy without you.
15. Quit following me.
16. Domino.
17. Split down the middle.
18. A step backwards.
19. Life in the big city.
20. Just between you and me.

TEAM-BUILDING ACTIVITY	ICEBREAKER
CATEGORIES	TIME: 10 min
RESOURCES A large, open space free from obstacles.	
ACTIVITY LAYOUT N/A.	
ACTIVITY INSTRUCTIONS <ol style="list-style-type: none">1. Have the group gather.2. Explain to the group that they will separate and regroup according to the categories announced.3. Announce a category. Possible categories include:<ol style="list-style-type: none">(a) number of siblings,(b) last digit in home telephone number,(c) position of thumbs when hands are clasped (e.g., left over right or right over left),(d) month of birth,(e) colour of eyes,(f) colour of hair,(g) type of breakfast ate this morning,(h) favourite hot or cold drink, and(i) distance travelled to get here.4. Once groups are formed, announce another category. Continue announcing categories until the time has lapsed.	
SAFETY N/A.	
REFERENCE (ISBN 0-934387-05-2) Collard, M. (2005). <i>No Props: Great Games With No Equipment</i> . (pp. 31–32). Beverly, MA: Project Adventure, Inc.	

TEAM-BUILDING ACTIVITY	ICEBREAKER
HUMAN SCAVENGER HUNT	TIME: 10 min
RESOURCES A large, open space free from obstacles.	
ACTIVITY LAYOUT Create a list of scavenger hunt items if other choices than those listed are preferred.	
ACTIVITY INSTRUCTIONS <ol style="list-style-type: none">1. Have the group stand or sit together.2. Read a point from the human scavenger hunt. The team must send a cadet to the front who fits the description. For example, if the leader says “Two cadets who have the same middle name,” members must talk and find out if there are two cadets in the group who fit the description and then quickly send those cadets to the leader.3. The human scavenger hunt could consist of:<ol style="list-style-type: none">(a) Two cadets who have the same first and last initials.(b) The cadet in the group who was born the furthest away.(c) Two cadets with the same middle name.(d) A group of cadets whose ages add up to 40.(e) Two cadets who were born on the same date (e.g., June 14th and September 14th)(f) Two cadets who were born in the same month.(g) A group of cadets whose shoe sizes add up to 30.(h) The cadet who lives the closest to here.(i) A group of cadets who can spell a word by putting together the first letters of their first names.(j) A group of three cadets who all have different coloured eyes.	
SAFETY N/A.	
REFERENCE (ISBN 0-9662341-6-2) Jones, A. (1999). <i>Team-Building Activities for Every Group</i> . (pp. 18–19). Richland, WA: Rec Room Publishing.	

TEAM-BUILDING ACTIVITY	ICEBREAKER
THE WALKING BILLBOARD	TIME: 10 min
RESOURCES <ul style="list-style-type: none">• A large, open space free from obstacles,• Flip chart paper (one sheet per cadet),• Markers (one per cadet), and• Masking tape (one roll).	
ACTIVITY LAYOUT <p>N/A.</p>	
ACTIVITY INSTRUCTIONS <ol style="list-style-type: none">1. Distribute a piece of flip chart paper and a marker to each cadet. Get all the cadets to place their first and last names at the top.2. Write and post the following questions on a piece of flip chart paper:<ol style="list-style-type: none">(a) What is your favourite food?(b) What is your biggest pet peeve?(c) What is your all-time favourite movie?(d) What is your dream job?3. Allow time for each cadet to write their answers on their piece of flip chart paper.4. Using masking tape, have the cadets help each other attach the flip chart paper to the writer's shoulders, to look like a "walking billboard".	
SAFETY <p>N/A.</p>	
REFERENCE <p>(ISBN 0-07-046501-0) Scannel, E., & Newstrom, J. (1998). <i>The Big Book of Presentation Games</i>. (pp. 125–126). New York, NY: McGraw-Hill.</p>	

TEAM-BUILDING ACTIVITY	ICEBREAKER
GETTING ACQUAINTED	TIME: 10 min
RESOURCES <ul style="list-style-type: none">• A large, open space,• Large sticky notes (one per cadet), and• Pens/pencils (one per cadet).	
ACTIVITY LAYOUT <p>N/A.</p>	
ACTIVITY INSTRUCTIONS <ol style="list-style-type: none">1. Distribute a large sticky note and a pen/pencil to each cadet.2. Have each cadet write their first and last names on their sticky note.3. Allow two or three minutes for each cadet to write down two words or brief phrases that tell something about themselves and can be used as conversation starters (e.g., hometown, hobby, quirk, etc).4. Have the cadets start to mingle and form groups of two or three and discuss their words or phrases with other cadets.5. Once a few minutes have passed, tell the cadets to switch groups while encouraging them to meet and mingle with as many cadets as possible.	
SAFETY <p>N/A.</p>	
REFERENCE <p>(ISBN 0-07-046501-0) Scannel, E., & Newstrom, J. (1998). <i>The Big Book of Presentation Games</i>. (pp. 23–24). New York, NY: McGraw-Hill.</p>	

TEAM-BUILDING ACTIVITY	ICEBREAKER
BINGO BLAST	TIME: 10 min
RESOURCES <ul style="list-style-type: none">• A large, open space,• Bingo Blast cards (one per cadet), and• Pens/pencils (one per cadet).	
ACTIVITY LAYOUT <p>Photocopy a Bingo Blast card for each cadet.</p>	
ACTIVITY INSTRUCTIONS <ol style="list-style-type: none">1. Distribute a bingo card and a pen/pencil to each cadet.2. Allow five minutes for the cadets to roam around the area trying to find a person to fit each description on the card. Once a person is found, that cadet will sign their name on the bingo card. Encourage the cadets to try to fill out the complete card.3. Once time is up, have the cadets gather in one area and sit.4. Read the descriptions out loud and see who fits each description.	
SAFETY <p>N/A.</p>	
REFERENCE <p>(ISBN 0-07-046501-0) Scannel, E., & Newstrom, J. (1998). <i>The Big Book of Presentation Games</i>. (pp. 28–29). New York, NY: McGraw-Hill.</p>	

BINGO BLAST

PLAYS TENNIS _____	HAS TRAVELLED OUTSIDE OF CANADA _____	SPEAKS TWO LANGUAGES _____	HAS BROWN EYES _____	HAS AN OLDER BROTHER _____
HAS BROKEN A BONE _____	HATES BRUSSELS SPROUTS _____	HAS RED HAIR _____	HAS A PET FISH _____	PLAYS AN INSTRUMENT _____
HAS NEVER BEEN TO A CSTC BEFORE _____	HAS CANOED _____	FREE	HAS HAD A CAVITY _____	LOVES PICKLES _____
CAN SWIM _____	HAS A PET DOG _____	HAS BLUE EYES _____	HAS THEIR TOENAILS PAINTED _____	PLAYS VOLLEYBALL _____
HAS BLONDE HAIR _____	LIKES MATH _____	HAS A BIRTHDAY DURING THE COURSE _____	KNOWS A SET OF TWINS _____	KNOWS HOW TO DO THE HOKEY POKEY _____

TEAM-BUILDING ACTIVITY	ICEBREAKER
TEAM CHARADES	TIME: 10 min
RESOURCES A large, open space free from obstacles.	
ACTIVITY LAYOUT N/A.	
ACTIVITY INSTRUCTIONS 1. Divide the cadets into two equal groups. 2. Give each group five minutes to: (a) choose a name for the team that best represents it; and (b) discuss a set of charades or acts that they will use to try to get the others to guess their team name. 3. Allow one minute for each group to act out their group's name, while the rest of the cadets guess.	
SAFETY N/A.	
REFERENCE (ISBN 0-07-046501-0) Scannel, E., & Newstrom, J. (1998). <i>The Big Book of Presentation Games</i> . (p. 161). New York, NY: McGraw-Hill.	

TEAM-BUILDING ACTIVITY	ICEBREAKER
DOUBLE TAKE	TIME: 10 min
RESOURCES A large, open space free from obstacles.	
ACTIVITY LAYOUT N/A.	
ACTIVITY INSTRUCTIONS <ol style="list-style-type: none">1. Have the cadets spread out in the area.2. Have the cadets walk around shaking hands and introducing themselves to other cadets.3. Call out a characteristic and have the cadets form groups with other cadets who share that characteristic. Some characteristics could include:<ol style="list-style-type: none">(a) hair colour,(b) eye colour,(c) shoe size,(d) favourite colour,(e) favourite pizza topping,(f) pet ownership,(g) favourite sport, and(h) favourite music.4. Encourage the cadets to form groups with different cadets as frequently as possible.	
SAFETY N/A.	
REFERENCE (ISBN 0-07-134984-7) West, E. (1999). <i>The Big Book of Icebreakers</i> . (pp. 25–29). New York, NY: McGraw-Hill.	

TEAM-BUILDING ACTIVITY	ICEBREAKER
PECULIARITIES	TIME: 10 min
RESOURCES <ul style="list-style-type: none">• A large, open space,• Peculiarities Activity Sheet (one per cadet), and• Pens/pencils (one per cadet).	
ACTIVITY LAYOUT <p>Photocopy a Peculiarities Activity Sheet for each cadet.</p>	
ACTIVITY INSTRUCTIONS <ol style="list-style-type: none">1. Distribute an activity sheet and a pen/pencil to each cadet.2. Allow five minutes for the cadets to roam around the area trying to find a cadet to fit each description on the card. Once a cadet is found, have the cadet tick their peculiarity off the list and write their name next to the description. Encourage the cadets to try to tick off as many as possible.3. Once time is up, have the cadets join in one area and sit.4. Read the descriptions out loud and see who fits each description.	
SAFETY <p>N/A.</p>	
REFERENCE <p>(ISBN 0-07-134984-7) West, E. (1999). <i>The Big Book of Icebreakers</i>. (pp. 105–107). New York, NY: McGraw-Hill.</p>	

PECULIARITIES ACTIVITY SHEET

1. Who was born on February 29th?
2. Who has or had a dog named Spot, Midnight, Lucky, Shadow or Snoopy?
3. Who competes in sporting activities such as running, basketball, etc?
4. Who likes pizza with anchovies?
5. Who was born in a different province than the one in which they reside?
6. Who was born outside of Canada?
7. Who has been to Nunavut?
8. Who writes songs or poetry?
9. Who has a twin brother or sister?
10. Who has a shoe size greater than 10?
11. Who has milked a cow?
12. Who has been to a concert in the past three months?
13. Who has been on a radio or television show?
14. Who prefers winter to summer?

TEAM-BUILDING ACTIVITY	ICEBREAKER
I LIKE ME BECAUSE	TIME: 10 min
RESOURCES A large, open space free from obstacles.	
ACTIVITY LAYOUT N/A.	
ACTIVITY INSTRUCTIONS <ol style="list-style-type: none">1. Divide the cadets into pairs, preferably two cadets that do not know each other well.2. Have the pairs sit facing each other and decide who will go first and who will go second.3. Have each pair make eye contact and sit with an open body posture (e.g., do not cross arms).4. Explain that each pair will have two minutes each to answer the question “What do I like about myself?” The partner not answering the question cannot talk but must express a keen interest in the cadet through body language.5. Have the first cadet speak about themselves. At the end of the two minutes, have the cadets switch roles.	
SAFETY N/A.	
REFERENCE (ISBN 0-07-046513-4) Newstrom, J., & Scannel, E. (1998). <i>The Big Book of Team Building Games</i> . (pp. 73–74). New York, NY: McGraw-Hill.	

TEAM-BUILDING ACTIVITY	ICEBREAKER
GROUP JUGGLE	TIME: 10 min
RESOURCES <ul style="list-style-type: none">• A large, open space free from obstacles, and• Tennis balls (three).	
ACTIVITY LAYOUT <p>N/A.</p>	
ACTIVITY INSTRUCTIONS <ol style="list-style-type: none">1. Have the cadets stand in a circle.2. Start the activity using one ball. All cadets will begin the game with one arm in the air. The cadet with the ball will call out their own name and the name of the cadet to whom they are going to throw the ball they will then throw the ball to that cadet. The ball must be thrown to a cadet with their arm in the air to ensure each cadet has the opportunity to participate. Once the cadet has caught the ball they are to put their arm down.3. Have the cadet who catches the ball say their own name, say the name of the cadet to whom they are going to throw the ball and then throw the ball to that cadet.4. Continue the game until the cadets seem comfortable using one ball.5. Add more balls. The rules remain the same, only that the cadets have to pay much more attention! Continue until everyone has caught a ball, then all cadets should start again with their arm in the air.	
SAFETY <p>N/A.</p>	
REFERENCE <p>(ISBN 0-07-059532-1) Snow, H. (1997). <i>Indoor/Outdoor Team-Building Games for Trainers</i>. (p. 109). New York, NY: McGraw-Hill Companies, Inc.</p>	

TEAM-BUILDING ACTIVITY	ICEBREAKER
MEET 'N GREET	TIME: 10 min
RESOURCES A large, open space free from obstacles.	
ACTIVITY LAYOUT N/A.	
ACTIVITY INSTRUCTIONS <ol style="list-style-type: none">1. Divide the cadets into groups of three or four.2. Allow two minutes for each group to find three distinctive things that all of the cadets have in common. The only rule is that the three distinctive things cannot be related to the Cadet Program (e.g., won the marksmanship team or received an award at the Annual Ceremonial Review). Some examples could be:<ol style="list-style-type: none">(a) all are from the same province;(b) all have an older brother; and(c) all grew up in a single parent home.3. Once all groups have completed Step 2., have the cadets regroup and share the three commonalities with the remainder of the cadets.4. If time remains, complete the activity again with different groups.	
SAFETY N/A.	
REFERENCE (ISBN 0-07-046414-6) Newstrom, J. (1994). <i>Even More Games Trainers Play</i> . (p. 11). New York, NY: McGraw-Hill Companies.	

TEAM-BUILDING ACTIVITY	ICEBREAKER
WHO ARE YOU?	TIME: 10 min
RESOURCES <ul style="list-style-type: none">• A large, open space,• Index cards (one per cadet), and• Pens/pencils (one per cadet).	
ACTIVITY LAYOUT <p>N/A.</p>	
ACTIVITY INSTRUCTIONS <ol style="list-style-type: none">1. Distribute an index card and a pen/pencil to each cadet.2. Have each cadet write down one thing about themselves that they do not think anyone else would know.3. Collect all the cards and shuffle them. Randomly distribute one card to each cadet.4. Allow five minutes for the cadets to circulate the room and ask questions to the other cadets to try to find out whose card they have.5. Have each cadet sit after they have found the person whose card they have and when the cadet with their card locates them.	
SAFETY <p>N/A.</p>	
REFERENCE <p>(ISBN 0-07-046501-0) Scannel, E., & Newstrom, J. (1998). <i>The Big Book of Presentation Games</i>. (pp. 23–24). New York, NY: McGraw-Hill.</p>	

TEAM-BUILDING ACTIVITY	ICEBREAKER
BIRTHDAY LINE	TIME: 10 min
RESOURCES <ul style="list-style-type: none">• A large, open space free from obstacles, and• Tape/rope (approximately 10 m [32 feet]).	
ACTIVITY LAYOUT <ul style="list-style-type: none">• If using tape, tape two parallel lines 50 cm (20 inches) apart, each approximately 5 m (16 feet) long on the floor.• If using rope, place two parallel lines 50 cm (20 inches) apart, each approximately 5 m (16 feet) long on the ground.	
ACTIVITY INSTRUCTIONS <ol style="list-style-type: none">1. Have all the cadets stand side by side inside the two lines, without their feet touching them.2. Tell the cadets to organize themselves in order of birthday without stepping outside or on the lines.3. If completed quickly, have the cadets organize themselves again using different criteria (e.g., height, shoe size, hair colour).	
SAFETY <p>N/A.</p>	
REFERENCE <p>(ISBN 0-07-059532-1) Snow, H. (1997). <i>Indoor/Outdoor Team-Building Games for Trainers</i>. (p. 57). New York, NY: McGraw-Hill Companies, Inc.</p>	

TEAM-BUILDING ACTIVITY	ICEBREAKER
A COAT OF ARMS	TIME: 10 min
RESOURCES <ul style="list-style-type: none">• A large, open space,• Coat of arms template (one per cadet),• Pens/pencils (one per cadet).	
ACTIVITY LAYOUT <p>Photocopy a coat of arms template for each cadet.</p>	
ACTIVITY INSTRUCTIONS <ol style="list-style-type: none">1. Distribute a coat of arms template and a pen/pencil to each cadet.2. Have the cadets fill in their coat of arms by reading the following aloud, one at a time:<ol style="list-style-type: none">(a) In Space 1, draw something that characterizes a recent peak performance.(b) In Space 2, sketch something about yourself that very few people know about.(c) In Space 3, draw a symbol of how you like to spend your free time.(d) In Space 4, represent something that you are very good at.(e) In Space 5, write or draw something that could be your personal motto.3. When complete, use the remaining the time for the cadets to mingle with others to share their coat of arms.	
SAFETY <p>N/A.</p>	
REFERENCE <p>(ISBN 0-07-046513-4) Newstrom, J., & Scannel, E. (1998). <i>The Big Book of Team Building Games</i>. (pp. 77–79). New York, NY: McGraw-Hill.</p>	

COAT OF ARMS TEMPLATE

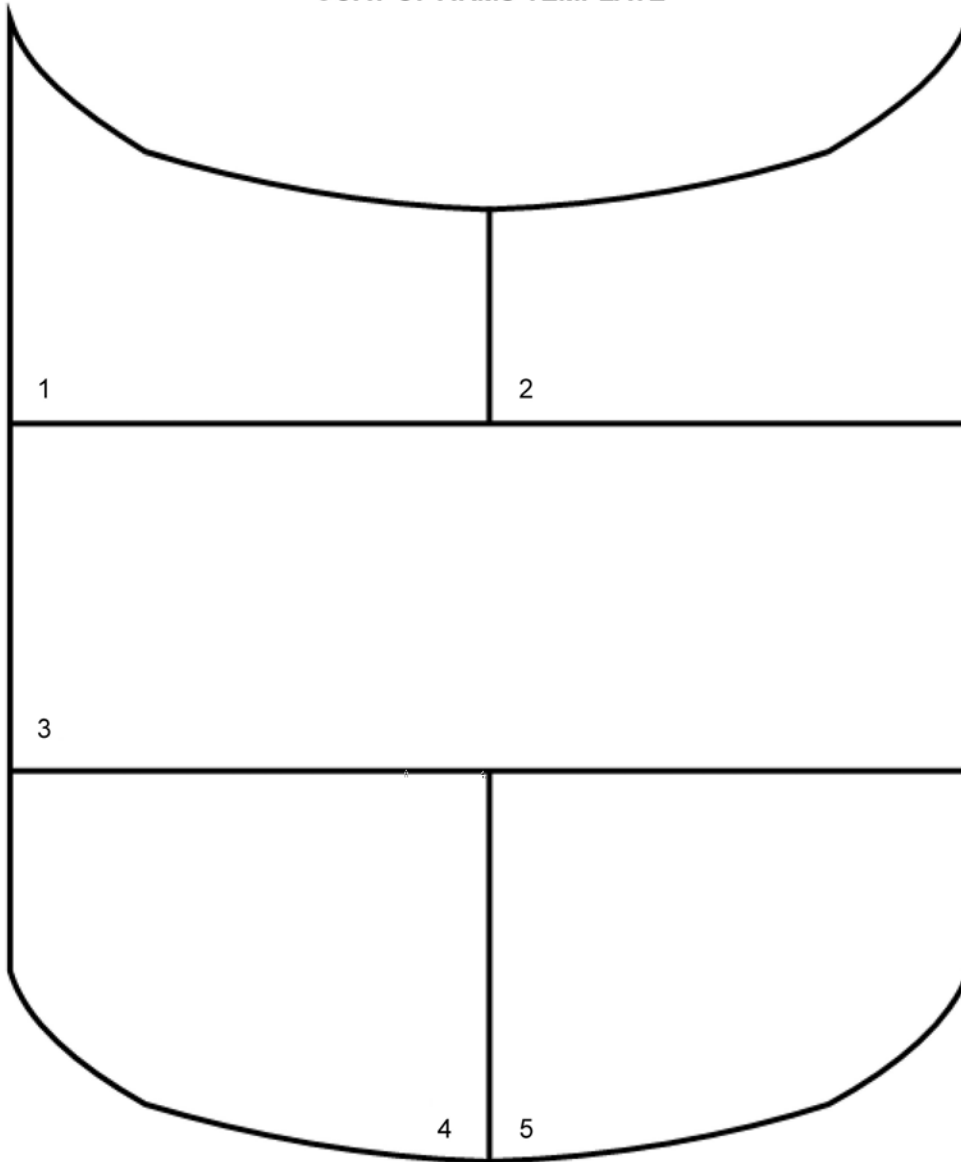

J. Newstrom & E. Scannel, The Big Book of Team Building Games, McGraw-Hill (p. 79)

Figure 3O-2 Coat of Arms Template

TEAM-BUILDING ACTIVITY	ICEBREAKER
MARTIAN NAMES	TIME: 10 min
RESOURCES <ul style="list-style-type: none">• A large, open space,• Paper (one piece per cadet), and• Pens/pencils (one per cadet).	
ACTIVITY LAYOUT <p>Prepare your Martian name and meaning on a piece of paper.</p>	
ACTIVITY INSTRUCTIONS <ol style="list-style-type: none">1. Tell the following story: “Imagine you have just landed on Mars and need to introduce yourself to your Martian tour guide. Language on Mars is the complete reverse of ours. This means you must change your name so it is backward: last name first, first name last and both spelled backward, letter by letter. In addition, every name on Mars means something special and relates to the person who has that name. On your sheet of paper, write your name as it would appear on Mars. Practice pronouncing it. Think about what your Martian name means and be prepared to share it with the group.”2. Show the cadets your Martian name and meaning. For example, Sarah Jones becomes “Senoj Haras,” which means “enjoys taking long trips and hiking with my friends” or Joshua Carew becomes “Werac Auhsoj,” which means “warrior of the desert.”3. Distribute a piece of paper and a pen/pencil to each cadet and allow two minutes for the cadets to complete their Martian names.4. Have the cadets share their Martian names with the group.	
SAFETY <p>N/A.</p>	
REFERENCE <p>(ISBN 1-57542-265-4) MacGregor, M. (2008). <i>Teambuilding With Teens: Activities for Leadership, Decision Making and Group Success</i>. (pp. 8–9). Minneapolis, MN: Free Spirit Publishing, Inc.</p>	

THIS PAGE INTENTIONALLY LEFT BLANK

COMMUNICATION, PROBLEM-SOLVING AND TRUST-BUILDING ACTIVITIES

LIST OF ACTIVITIES FOR ANNEX P

Title	Page Number	
COMMUNICATION	Snowflake	3P-2
	Back-to-Back	3P-3
	Group Construction	3P-6
	Where Do I Go?	3P-7
	Missing Bucket	3P-8
	Charade Line	3P-9
	The Rock	3P-11
	King/Queen Frog	3P-12
	Mute Lineup	3P-13
	Marriage	3P-14
	That Ain't Me!	3P-15
	Blind Shapes	3P-16
	Wink	3P-17
	Minefield	3P-18
	Categories Twist	3P-19
	PROBLEM-SOLVING	Negotiation
Magic Carpet		3P-21
Raft		3P-22
Moonwalk		3P-23
Balance Beam		3P-24
Group Search		3P-26
Traffic Jam		3P-27
Circle Wars		3P-28
Untying Knots		3P-29
Stepping Stones		3P-30
Swamp Trail		3P-31
Human Knot		3P-33
Spider's Web		3P-34
Circle Clap		3P-36
Quick Shuffle		3P-37
TRUST-BUILDING		Tall Tower
	Swamp Crossing	3P-39
	Water Transfer	3P-41
	Egg Construction	3P-42
	Water Carry	3P-43
	Crazy Maze	3P-45
	Everybody Up	3P-46
	Slice & Dice	3P-47
	Hog Call	3P-49
	Hug a Tree	3P-50
Blindfold Build	3P-51	
Lighthouse	3P-52	
Trust Tag	3P-53	

TEAM-BUILDING ACTIVITY	COMMUNICATION
SNOWFLAKE	TIME: 15 min
RESOURCES 8-1/2 x 11 inch sheet of white paper (one per cadet).	
ACTIVITY LAYOUT N/A.	
ACTIVITY INSTRUCTIONS <ol style="list-style-type: none">1. Distribute a piece of paper to each cadet.2. Explain that the cadets are to individually follow the directions you are about to give without asking questions or seeking clarification.3. Give the following directions quickly, with no clarification:<ol style="list-style-type: none">(a) Fold the paper in half and tear off a top corner.(b) Fold it in half again and tear off the top corner.(c) Fold it in half again and tear off the left corner.(d) Rotate the paper to the right three times and tear off the bottom corner.(e) Fold it in half again and tear off the middle piece.4. Instruct the group to unfold their papers and compare their snowflakes with those around them. They will find that their snowflakes may or may not match others depending on how the instructions were understood.	
SAFETY N/A.	
REFERENCE (ISBN 1-57542-265-4) MacGregor, M. G. (2008). <i>Team-Building With Teens</i> . (pp. 67–68). Minneapolis, MN: Free Spirit Publishing Inc.	

TEAM-BUILDING ACTIVITY	COMMUNICATION
BACK-TO-BACK	TIME: 10–15 min
RESOURCES <ul style="list-style-type: none">• Paper,• Pens/pencils (one per group), and• Drawings (two per group).	
ACTIVITY LAYOUT <p>Photocopy both drawings for each group.</p>	
ACTIVITY INSTRUCTIONS <ol style="list-style-type: none">1. Divide the cadets into pairs. Have each pair sit back to back.2. Distribute a copy of Figure 3P-1 to one cadet from each pair. Distribute a piece of paper and pen/pencil to the other cadet.3. On the signal to start, the cadet with the drawing is to guide their partner to draw the figure without letting them see the original. The cadets are to use symbols and metaphors to describe the drawing, but not geometrical shapes. For example, the cadet cannot say draw a square or circle.4. Allow the cadets approximately five minutes to draw the figure. When the time is up, have the cadets compare the drawing to the original drawing.5. Have the cadets reverse roles. Distribute a copy of Figure 3P-2 to the cadet who drew first and a piece of paper and a pen/pencil to the other cadet. Repeat Steps 3. and 4.	
SAFETY <p>N/A.</p>	
REFERENCE <p>(ISBN 0-07-059532-1) Snow, H. (1997). <i>Indoor/Outdoor Team-Building Games for Trainers</i>. (pp. 95–97). New York, NY: McGraw-Hill.</p>	

DRAWING 1

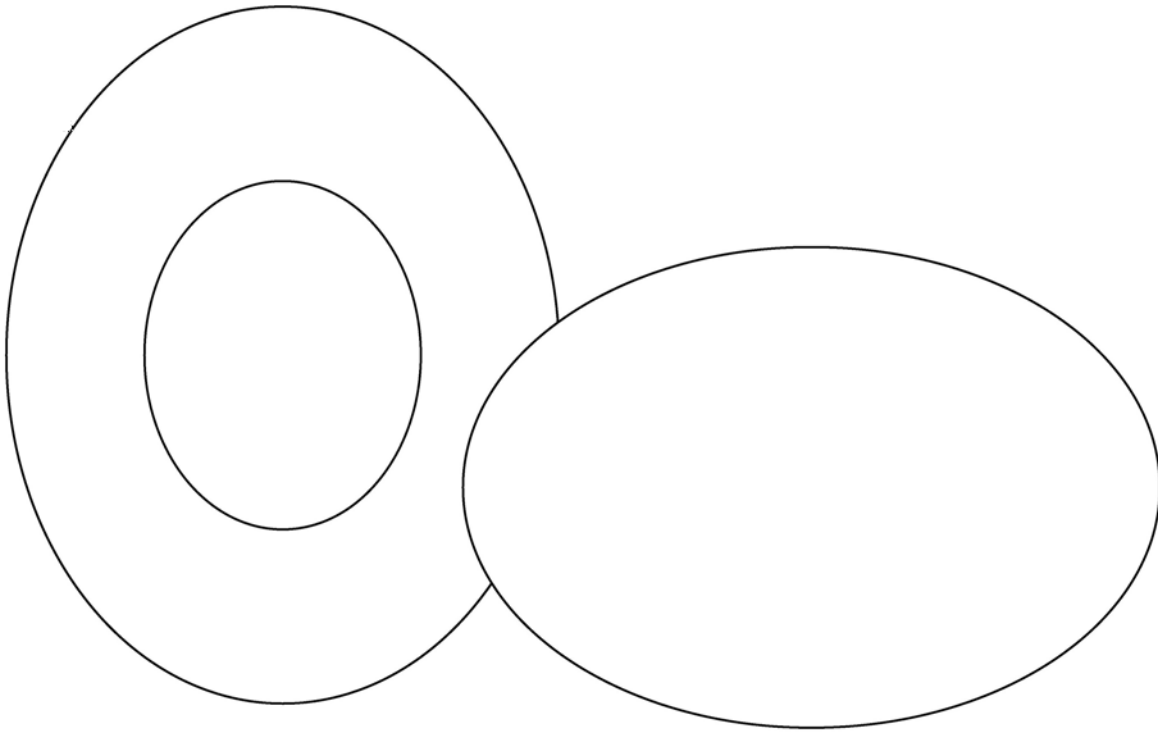

Director Cadets 3, 2008, Ottawa, ON: Department of National Defence

Figure 3P-1 Drawing 1

DRAWING 2

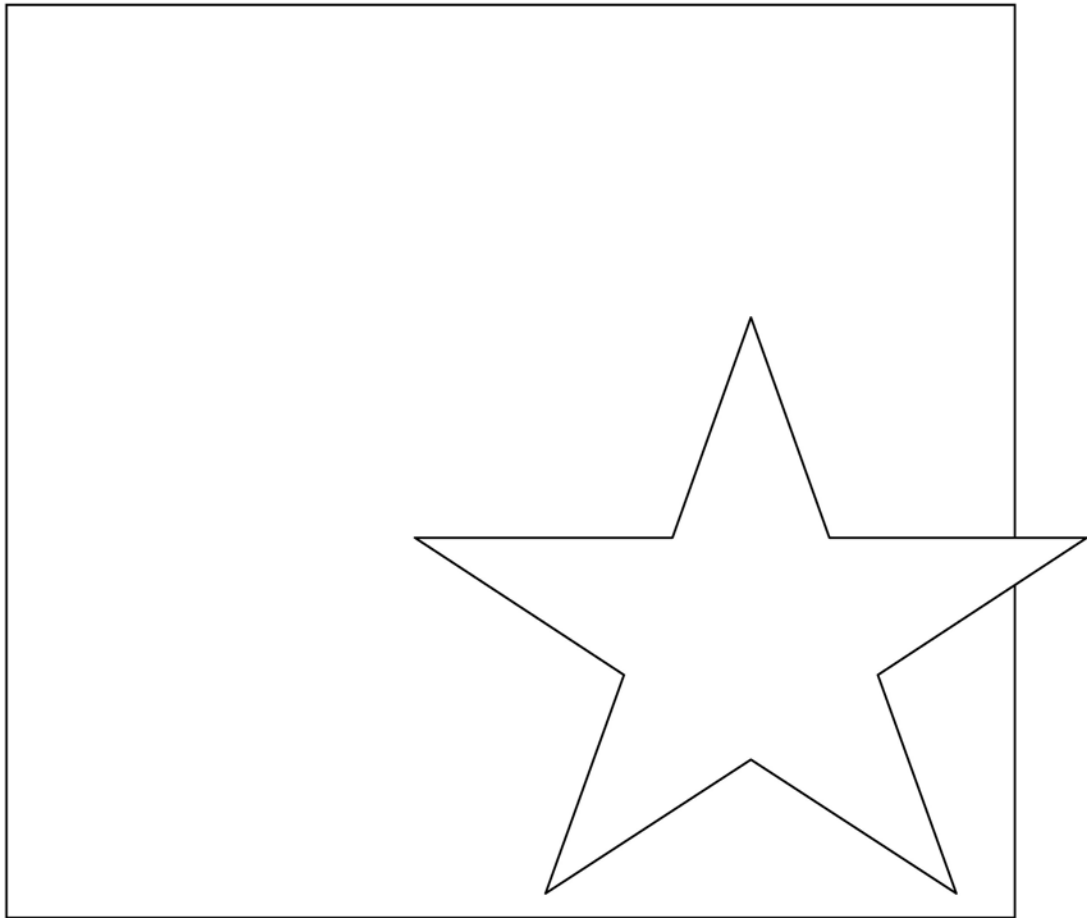

Director Cadets 3, 2008, Ottawa, ON: Department of National Defence

Figure 3P-2 Drawing 2

TEAM-BUILDING ACTIVITY	COMMUNICATION
GROUP CONSTRUCTION	TIME: 15 min
RESOURCES <ul style="list-style-type: none">• A large, open space free from obstacles, and• Toothpicks/popsicle sticks/straws (10 per cadet).	
ACTIVITY LAYOUT <p>N/A.</p>	
ACTIVITY INSTRUCTIONS <ol style="list-style-type: none">1. Have the cadets sit in a semicircle with their backs to the centre. Ensure they are spread out enough that they cannot see the toothpicks/popsicle sticks/straws of the cadets near them.2. Inform the cadets that they are not allowed to speak or look at the other cadets' design throughout the activity.3. Distribute 10 toothpicks/popsicle sticks/straws to each cadet, including yourself.4. As the "construction manager" you will build a design on the floor one toothpick/popsicle stick/straw at a time.5. After placing each toothpick/popsicle stick/straw on the ground, verbally guide the cadets to place their toothpicks/popsicle sticks/straws in the same position.6. When you have placed all 10 toothpicks/popsicle sticks/straws into a design, the designs of the cadets' should mimic your design.7. Upon completion of the activity, look at the cadets' designs to see how close they are to the original.	
SAFETY <p>N/A.</p>	
REFERENCE <p>(ISBN 0-7360-5088-4) Midura, D. W., & Glover, D. R. (2005). <i>Essentials of Team Building</i>. (p. 54). Champaign, IL: Human Kinetics.</p>	

TEAM-BUILDING ACTIVITY	COMMUNICATION
WHERE DO I GO?	TIME: 10-15 min
RESOURCES <ul style="list-style-type: none">• A large, open space free from obstacles,• Two small objects (e.g., coins, paper clips, toothpicks, etc), and• Blindfold.	
ACTIVITY LAYOUT <p>N/A.</p>	
ACTIVITY INSTRUCTIONS <ol style="list-style-type: none">1. Ask one cadet to volunteer to go first in the activity.2. Have the remainder of the cadets sit in a circle approximately 3 m (10 feet) in diameter.3. Blindfold the volunteer and have them stand in the middle of the circle.4. Have a member of the group place the two small objects on the ground, inside the circle, close enough together that the volunteer can simultaneously cover one object with each foot.5. On a start signal, each group member, one at a time, can give one direction to the volunteer (e.g., “Move your left foot forward 6 inches.”).6. Each member can give just one direction with the intent of getting the volunteer to cover one object with each foot.7. As time permits, have more cadets volunteer to participate as the cadet in the middle of the circle.	
SAFETY <p>Ensure cadets look out for the safety of the cadet in the centre of the circle.</p>	
REFERENCE <p>(ISBN 0-7360-5088-4) Midura, D. W., & Glover, D. R. (2005). <i>Essentials of Team Building</i>. (p. 58). Champaign, IL: Human Kinetics.</p>	

TEAM-BUILDING ACTIVITY	COMMUNICATION
MISSING BUCKET	TIME: 10-15 min
RESOURCES <ul style="list-style-type: none">• A large, flat and open space free from obstacles,• Rope/pylons to mark boundaries,• Blindfolds (one per every two cadets),• 20 L (five gallon) bucket,• 4 L (one gallon) jug,• Plastic drinking cups (enough for half the cadets), and• 8–10 objects to use as obstacles.	
ACTIVITY LAYOUT <ul style="list-style-type: none">• Place the rope/pylons to create an area that is approximately 3.5 m (10–12 feet) wide and 7.5 m (25 feet) long.• Set up obstacles throughout the course in a random pattern.• Fill the 20 L (five gallon) bucket with water and place it at the start line.• Place the empty 4 L (one gallon) container (the receiving container) at the finish line.• Place the plastic drinking cups at the start line.	
ACTIVITY INSTRUCTIONS <ol style="list-style-type: none">1. The goal of the activity is for a group of blindfolded cadets to be verbally led through the obstacle course by the non-blindfolded cadets while transferring water. The blindfolded cadets are to transfer the water in the bucket to the receiving container at the finish line without moving the buckets.2. Cadets are to avoid the obstacles as they proceed through the course.3. Non-blindfolded cadets are not allowed to touch the bucket, the receiving container or the drinking cups.4. If anyone breaks a rule or steps on an obstacle, that cadet must return to the starting line without emptying their water into the receiving container.5. The activity is complete when the receiving container is filled to the designated mark.	
SAFETY <p>The cadets must ensure the safety of the blindfolded cadets at all times throughout this activity.</p>	
REFERENCE <p>(ISBN 0-7360-5088-4) Midura, D. W., & Glover, D. R. (2005). <i>Essentials of Team Building</i>. (pp. 126–127). Champaign, IL: Human Kinetics.</p>	

TEAM-BUILDING ACTIVITY	COMMUNICATION
CHARADE LINE	TIME: 15 min
RESOURCES A large, open space free from obstacles.	
ACTIVITY LAYOUT Create sample situations for the activity if you wish to use different ones than the samples given here.	
ACTIVITY INSTRUCTIONS <ol style="list-style-type: none">1. Divide the cadets in two groups.2. Have the first group come to the front (performance area) and the second group be the audience.3. Explain the activity to the cadets, to include:<ol style="list-style-type: none">(a) Line up facing the back of the cadet in front of you.(b) Act out a situation for the cadet in front of you without using any verbal communication.(c) That person will act out the situation for the next person in line and so forth down the line.4. Have the group in the performance area line up with their backs to you. Tap the first cadet on the shoulder and have them turn around.5. Act out a situation. For example, you may mime the following:<ol style="list-style-type: none">(a) you walk in swinging a bag in your hand;(b) you pull up a chair and have a seat;(c) you take a fishing rod out of the bag and cast your line;(d) you pull in the line when you feel a tug on it;(e) you find a rubber boot on your line instead of a fish; and(f) you dump the water out of the boot, put it on your foot and leave.6. That cadet then taps the next cadet, acts out the same situation and so forth down the line. Expect the situation being acted out to change as it passes through the line.7. The group of cadets acting as the audience may laugh but not offer any advice or guidance.8. Once the last cadet has observed the situation they should act it out for you and the initial cadet and the entire group should watch while you perform the original situation once more.9. Have the groups reverse roles so the original audience becomes the actors and vice versa. Have the cadets repeat Steps 4. to 8. with a new situation. For example, you may mime the following:<ol style="list-style-type: none">(a) you pull a lottery ticket out of your back pocket;(b) you pull out a chair and sit;(c) you pull a newspaper out of a bag;(d) you check the numbers on your lottery ticket with the numbers on the newspaper; and(e) you realize all the numbers match and jump up and down in amazement!	
SAFETY N/A.	

REFERENCE

(ISBN 0-934387-05-2) Collard, M. (2005). *No Props: Great Games With No Equipment*. (pp. 202–203). Beverly, MA: Project Adventure, Inc.

TEAM-BUILDING ACTIVITY	COMMUNICATION
THE ROCK	TIME: 15 min
RESOURCES <ul style="list-style-type: none">• A large, open space free from obstacles, and• Small rock (must be small enough to be concealed in a fist).	
ACTIVITY LAYOUT <p>N/A.</p>	
ACTIVITY INSTRUCTIONS <ol style="list-style-type: none">1. Have the cadets stand in a circle, facing the centre.2. Have the cadets close their eyes and stand with both of their hands clenched behind their backs.3. Explain that if they would like to be the cadet holding the rock, they must open one fist into a cupped position, ready to receive the rock. Cadets not wishing to hold the rock should remain with their hands clenched. Once a cadet receives the rock they are to clench their hand into a fist.4. Walk around the circle, as quietly as possible and place the small rock into one of the open hands.5. Continue around the circle to the point from which you started.6. Have all cadets clench their hands, open their eyes and sit in the circle, keeping their hands clenched at all times.7. Every person, including the one holding the rock, will have a chance to guess who is holding the rock.8. After a minute of everyone looking around the circle, allow the group to start making guesses. There is to be no talking among the cadets.9. Ask for a volunteer to guess first. If a cadet guesses wrong they are not allowed to guess again.10. Each cadet is given an opportunity to make one guess until the rock holder is discovered.	
SAFETY <p>N/A.</p>	
REFERENCE <p>(ISBN 0-934387-05-2) Collard, M. (2005). <i>No Props: Great Games With No Equipment</i>. (pp.189–190). Beverly, MA: Project Adventure, Inc.</p>	

TEAM-BUILDING ACTIVITY	COMMUNICATION
KING/QUEEN FROG	TIME: 15 min
RESOURCES	
<ul style="list-style-type: none">• A large, open space free from obstacles, and• Poly spots/chairs (one per cadet).	
ACTIVITY LAYOUT	
N/A.	
ACTIVITY INSTRUCTIONS	
<ol style="list-style-type: none">1. Have the cadets sit in a circle, facing the centre. Mark each position with spots or chairs.2. Every cadet must have a unique action that represents an animal. For example:<ol style="list-style-type: none">(a) a gorilla beating on their chest;(b) a monkey scratching their armpits;(c) a bird fluttering their wings;(d) a dog wagging their tail;(e) a cat grooming their face;(f) a snake slithering through the grass;(g) a penguin waddling;(h) an elephant raising their trunk;(i) a rabbit hopping;(j) a lobster moving their claws; or(k) a chicken clucking.3. Go around the circle and have each cadet demonstrate their action. You may act as the King/Queen Frog or designate one cadet to hold this position. The action for the King/Queen Frog will be a frog leaping.4. Each round will start with the King/Queen Frog. That cadet will perform their gesture and then the gesture of another cadet. This cadet must quickly do their action, followed by another cadet's action and so forth.5. If a cadet is too slow, messes up the action or goes in the wrong sequence the game stops. This cadet will leave their spot and sit directly to the left of the King/Queen Frog. This causes everyone sitting to the right of this cadet to move one seat to the left to fill in the gap.6. When a cadet moves seats, their action does not move with them, it stays with the seat!7. The object of the game is to get into the royal throne. This occurs when the King/Queen Frog makes a mistake and everyone in the circle moves one seat to the left.	
SAFETY	
N/A.	
REFERENCE	
(ISBN 0-934387-05-2) Collard, M. (2005). <i>No Props: Great Games With No Equipment</i> . (pp. 182–183). Beverly, MA: Project Adventure, Inc.	

TEAM-BUILDING ACTIVITY	COMMUNICATION
MUTE LINEUP	TIME: 15 min
RESOURCES A large, open space free from obstacles.	
ACTIVITY LAYOUT N/A.	
ACTIVITY INSTRUCTIONS <ol style="list-style-type: none">1. Explain to the group that from this point on they are all mute—no verbal communication is allowed. The cadets are also not to write anything down on paper, flip charts, etc.2. Have the group line up in a straight line according to set criteria (e.g., height, birth date, number of letters in their first/last name, etc).3. Once the cadets think they are lined up in the correct order, have them sit to signify they are done.4. Go through the lineup verbally to see if they were able to get in the correct sequence with non-verbal communication.5. If time permits, have the group line up using different criteria to see if there were any lessons learned from the first attempt.	
SAFETY N/A.	
REFERENCE (ISBN 0-934387-05-2) Collard, M. (2005). <i>No Props: Great Games With No Equipment</i> . (pp. 145–146). Beverly, MA: Project Adventure, Inc.	

TEAM-BUILDING ACTIVITY	COMMUNICATION
MARRIAGE	TIME: 10-15 min
RESOURCES <ul style="list-style-type: none">• A large, open space free from obstacles, and• Deck of playing cards (Joker included).	
ACTIVITY LAYOUT <p>Based on the number of cadets in the group, pull out a card for each player. Ensure you have a card for each participant, including one Joker. The other cards must be pairs in the same colour and denomination (e.g., three of hearts and three of diamonds, ten of spades and ten of clubs).</p> <p>If there is an even number of cadets participating in the activity, exclude the Joker.</p>	
ACTIVITY INSTRUCTIONS <ol style="list-style-type: none">1. Each cadet is given a card and asked not to show it to anyone.2. Explain that the cadets are to find the person in the room that has their matching card based on colour and denomination (e.g., the queen of hearts would be looking for the queen of diamonds).3. Explain that the cadets are not allowed to show their card at any time and are not allowed to say colours or numbers.4. Have the cadets try to find their match. They may use words such as “I have a fire engine coloured card and like shiny objects in rings” to determine they have a red card that is a diamond.5. When pairs think they have found each other they are to link arms and wait for the other participants to finish.6. The Joker in the room is to do the same thing throughout the activity but will not be able to find their partner as there is only one Joker in the group leaving them as the unmarried card at the end of the activity.	
SAFETY <p>N/A.</p>	
REFERENCE <p>(ISBN 0-7575-4094-5) Cummings, M. (2007). <i>Playing With a Full Deck: 52 Team Activities Using a Deck of Cards</i>. (p. 93). Dubuque, IA: Kendall/Hunt Publishing Company.</p>	

TEAM-BUILDING ACTIVITY	COMMUNICATION
THAT AIN'T ME!	TIME: 10-15 min
RESOURCES A large, open space free from obstacles.	
ACTIVITY LAYOUT N/A.	
ACTIVITY INSTRUCTIONS <ol style="list-style-type: none">1. Divide the cadets into pairs.2. Explain that each cadet will have to mime three things about themselves to their partner enabling their partner to later verbally introduce them to the remainder of the group.3. The cadets are not allowed to use any form of verbal communication. Cadets should be given approximately three minutes to mime their information to their partner.4. Cadets can mime things such as:<ol style="list-style-type: none">(a) part-time jobs,(b) favourite school subject,(c) favourite hobby/pastime, and(d) favourite movie/television show.5. Once everyone has had time to mime their information, gather the group. Each cadet will then have to verbally introduce their partner based on the information that was mimed.6. If cadets introduce something that was misinterpreted from the mime, their partner should state, "That ain't me!". This activity is complete when all the cadets have introduced their partners.	
SAFETY N/A.	
REFERENCE (ISBN 0-934387-05-2) Collard, M. (2005). <i>No Props: Great Games With No Equipment</i> . (pp. 52–53). Beverly, MA: Project Adventure, Inc.	

TEAM-BUILDING ACTIVITY	COMMUNICATION
BLIND SHAPES	TIME: 15 min
RESOURCES <ul style="list-style-type: none">• A large, open space free from obstacles,• Blindfolds (one per cadet), and• Length of rope long enough for all cadets to hold on to at once.	
ACTIVITY LAYOUT <p>Tie the end of the rope in a knot.</p>	
ACTIVITY INSTRUCTIONS <ol style="list-style-type: none">1. Have the cadets stand in a circle and blindfold each of them.2. Place the length of rope on the ground near the feet of the cadets. Explain that the first thing they will have to do is find the rope and pick it up. The cadets are allowed to verbally communicate throughout this activity.3. Tell the cadets to form a square. After a few minutes, ask the cadets if they think they have formed the square. If they say no, allow them to continue, even if they already are in a square. If they say yes, allow them to remove their blindfolds and look at the shape they have formed.4. Continue with other shapes (e.g., triangles, rectangles, ovals, etc) as time allows.	
SAFETY <p>Ensure the safety of all blindfolded cadets.</p>	
REFERENCE <p>(ISBN 0-7872-0107-3) (1995). <i>Youth Leadership in Action</i>. (pp. 63–64). Dubuque, IA: Kendall/Hunt Publishing Company.</p>	

TEAM-BUILDING ACTIVITY	COMMUNICATION
WINK	TIME: 15 min
RESOURCES A large, open space free from obstacles.	
ACTIVITY LAYOUT N/A.	
ACTIVITY INSTRUCTIONS <ol style="list-style-type: none">1. Have the cadets sit in a circle facing the centre.2. Explain that there is a mystery “winker” among the group, but not even that cadet knows who it is yet.3. Have the cadets close their eyes. Secretly assign the “winker” by tapping them on the shoulder.4. Explain that the cadets must mingle with all the others and greet each other. The “winker” will be secretly winking at cadets to get them out of the game.5. Explain that the cadets must wait at least 10 seconds before sitting after they have been winked at by the “winker”. Cadets who have been winked at are to be seated while others continue to mingle.6. If a cadet who is still in the game suspects someone of being the “winker,” they may raise a hand and announce, “I accuse”. Stop the proceedings and ask if there is a seconder, who is a second cadet who suspects they know who the “winker” may be. If there is no seconder the game will continue.7. If a seconder speaks up, the facilitator is to count to three and each accuser must point directly to the person they believe is the “winker”. If they each point to a different person, regardless if one of them is correct, they are both out of the game. If they point to the same wrong person, they are both out of the game. If they are correct the activity is over.8. The activity continues until either everyone is out or two people make a successful accusation.	
SAFETY N/A.	
REFERENCE (ISBN 0-934387-05-2) Collard, M. (2005). <i>No Props: Great Games With No Equipment</i> . (pp. 179–180). Beverly, MA: Project Adventure, Inc.	

TEAM-BUILDING ACTIVITY	COMMUNICATION
MINEFIELD	TIME: 15 min
RESOURCES <ul style="list-style-type: none">• A large, open space free from obstacles,• Large quantity of small balls (e.g., tennis balls, golf balls, ping pong balls, etc),• Stopwatch, and• Blindfolds (two).	
ACTIVITY LAYOUT <ul style="list-style-type: none">• Place the balls around the floor in a random pattern.• Mark off a start and a finish line.	
ACTIVITY INSTRUCTIONS <ol style="list-style-type: none">1. Ask for two volunteers and blindfold them.2. Divide the cadets in two groups. Have each group of cadets place themselves evenly throughout the “minefield”. One group will be responsible for verbally guiding the first blindfolded cadet through the “minefield”. The second group will be responsible for verbally guiding the second blindfolded cadet to try to tag the first blindfolded cadet.3. Explain that the first blindfolded cadet will be the “sidewinder”. This cadet is to aim for the finish line and will be verbally guided through the “minefield” by their group. If the “sidewinder” touches a “mine” (ball) on their way through the “minefield” they must swing both of their arms in a full circle 10 times, counting each revolution aloud.4. One minute after the “sidewinder” is released into the minefield, launch the second blindfolded cadet, the “missile” into the “minefield”. The “missile’s” team is to guide them to try to tag the “sidewinder”.5. If the “missile” tags the “sidewinder” prior to them reaching the finish line, the mission is complete.	
SAFETY <p>Ensure the safety of the blindfolded cadets at all times throughout the duration of the activity.</p>	
REFERENCE <p>(ISBN 0-8403-5682-X) Rohnke, K. (1984). <i>Silver Bullets: A Guide to Initiative Problems, Adventure Games and Trust Activities</i>. (p. 24). Dubuque, IA: Kendall/Hunt Publishing Company.</p>	

TEAM-BUILDING ACTIVITY	COMMUNICATION
CATEGORIES TWIST	TIME: 15 min
RESOURCES A large, open space free from obstacles.	
ACTIVITY LAYOUT N/A.	
ACTIVITY INSTRUCTIONS <ol style="list-style-type: none">1. Divide the cadets into groups of three.2. Have each group go to a quiet area away from the other groups. Allow approximately four minutes for the group to come up with as many categories as possible of things they have in common—the odder the better (e.g., they have all seen a zebra).3. Each group will have to share three things with the rest of the group. One item should not be true.4. Have everyone come back to a common meeting place in the room and sit.5. Have each group, one at a time, come to the front and state their three commonalities with a straight face.6. The remaining groups are to decide which commonality is not true. This activity will allow the cadets to start reading people's non-verbal communication skills.	
SAFETY N/A.	
REFERENCE (ISBN 0-934387-05-2) Collard, M. (2005). <i>No Props: Great Games With No Equipment</i> . (p. 178). Beverly, MA: Project Adventure, Inc.	

TEAM-BUILDING ACTIVITY	COMMUNICATION
NEGOTIATION	TIME: 15 min
RESOURCES A large, open space free from obstacles.	
ACTIVITY LAYOUT N/A.	
ACTIVITY INSTRUCTIONS <ol style="list-style-type: none">1. Divide the cadets into three or four small groups (depending on the number of cadets).2. Explain that each group will go to an area where the other groups can not see them and decide on a physical gesture that they will later have to reveal to the rest of the cadets. Examples of gestures may include:<ol style="list-style-type: none">(a) waving their hands in the air;(b) jumping up and down;(c) performing jumping jacks;(d) flapping their arms like a bird;(e) spinning around in a circle; or(f) rubbing their stomachs while patting their heads.3. After approximately three minutes, have each group come back to the centre of the training area, and stand in a position where every other group can see them. Explain that the cadets are no longer allowed to use any verbal communication.4. On the word “go” have every cadet in each group simultaneously demonstrate their group’s gesture for the remainder of the cadets.5. Explain that the cadets are to now decide on one gesture among all the groups. Remember that the cadets are not allowed to communicate verbally throughout the remainder of this activity.6. The goal is to see how many times it will take to get every group doing the same gesture without any verbal communication. The gesture may be one from of the groups or a combination of the gestures.	
SAFETY N/A.	
REFERENCE (ISBN 0-934387-05-2) Collard, M. (2005). <i>No Props: Great Games With No Equipment</i> . (pp. 150–151). Beverly, MA: Project Adventure, Inc.	

TEAM-BUILDING ACTIVITY	PROBLEM-SOLVING
MAGIC CARPET	TIME: 15 min
RESOURCES <ul style="list-style-type: none">• A large, open space free from obstacles, and• Piece of plastic or material approximately 1.2 m (4 feet) by 1.5 m (5 feet).	
ACTIVITY LAYOUT <p>N/A.</p>	
ACTIVITY INSTRUCTIONS <ol style="list-style-type: none">1. Explain that everyone must stand on the magic carpet and that everyone must maintain contact with the magic carpet at all times throughout the activity.2. Explain that the group is on a magic carpet ride high above the CSTC when suddenly you discover that you are travelling in the wrong direction because the magic carpet is upside down.3. Have the cadets turn the magic carpet over without stepping off. Every cadet must maintain contact with the magic carpet at all times.	
SAFETY <p>Ensure all cadets maintain contact with the magic carpet. This will prevent cadets from being picked up or carried on shoulders.</p>	
REFERENCE <p>(ISBN 0-7872-4532-1) Cain, J., & Jolliff, B. (1998). <i>Teamwork & Teamplay</i>. (pp. 125–126). Dubuque, IA: Kendall/Hunt Publishing Company.</p>	

TEAM-BUILDING ACTIVITY	PROBLEM-SOLVING
RAFT	TIME: 15 min
RESOURCES <ul style="list-style-type: none">• A large, open space free from obstacles, and• Piece of tarp/plywood approximately 1.2 m (4 feet) by 1.2 m (4 feet) depending on the size of the group (should be just large enough for all of the cadets to fit on).	
ACTIVITY LAYOUT <p>N/A.</p>	
ACTIVITY INSTRUCTIONS <ol style="list-style-type: none">1. Explain to the cadets that their cruise ship has hit a reef and they are required to abandon ship.2. Explain that there are a number of sharks in the water nearby and the group must all get aboard the life raft in order to be rescued by the Coast Guard. The rescue helicopter can only pick them up if no one is in the water (touching the ground) for at least 20 seconds.3. The objective is for all the cadets to remain on the life raft for at least 20 seconds in order for the rescue helicopter to come to the rescue.4. Have the cadets participate in the activity.	
SAFETY <p>Ensure the safety of all cadets while on the raft.</p>	
REFERENCE <p>(ISBN 0-07-059532-1) Snow, H. (1997). <i>Indoor/Outdoor Team-Building Games for Trainers</i>. (pp. 113–115). New York, NY: McGraw-Hill.</p>	

TEAM-BUILDING ACTIVITY	PROBLEM-SOLVING
MOONWALK	TIME: 15 min
RESOURCES <ul style="list-style-type: none">• A large, open space free from obstacles,• Hula hoops (minimum of eight), and• Large rubber bands or pieces of soft fabric (one per every two cadets).	
ACTIVITY LAYOUT <p>Place eight or more hula hoops randomly on the ground no more than a foot apart.</p>	
ACTIVITY INSTRUCTIONS <ol style="list-style-type: none">1. Have the cadets assemble on one end of the hula hoops. Place the rubber bands around their ankles, connecting them to each other so that the cadets have to move together as a team.2. Explain that they must move from one hoop to the next without stepping outside.3. Explain that if someone steps outside a hoop the team must go back to the start and begin again, attempting to communicate and decide how to best move through the hula hoops.4. The goal is for the cadets to communicate and problem solve the best method of travelling through the hula hoops from the beginning to the end.5. Have the cadets participate in the activity.	
SAFETY <p>Ensure the rubber bands are large enough not to be too tight on the cadets' ankles.</p>	
REFERENCE <p>(ISBN 0-07-059532-1) Snow, H. (1997). <i>Indoor/Outdoor Team-Building Games for Trainers</i>. (pp. 123–124). New York, NY: McGraw-Hill.</p>	

TEAM-BUILDING ACTIVITY	PROBLEM-SOLVING
BALANCE BEAM	TIME: 15 min
RESOURCES <ul style="list-style-type: none">• A large, open space on grass or soft ground,• 3 m (10 feet) plank of wood approximately 5 cm (2 inches) thick and 20 cm (8 inches) wide,• Cinder block,• Surveyor's tape, and• Eggs (as per Step 2. in Activity Instructions).	
ACTIVITY LAYOUT <ul style="list-style-type: none">• Set up the plank of wood so it is balanced in the middle on the cinder block.• Mark a "V" on the ground in front of the cinder block with the surveyor's tape (as illustrated in Figure 3P-3).	
ACTIVITY INSTRUCTIONS <ol style="list-style-type: none">1. Stand on the plank while you brief the team. Demonstrate how a slight shift in weight causes the plank to turn into a see-saw.2. Explain that all of the cadets are to mount the plank, one at a time, from between the "V" marked on the ground, balance the plank as a group for a minimum of 10 seconds, and dismount, one at a time, between the "V" without causing either end of the plank to touch the ground—an egg can be laid under each end to ensure the plank has not touched the ground on either end.3. Allow the cadets approximately five minutes to plan a strategy. Explain that once the cadets begin to mount the plank, there will be no more verbal communication.4. The activity is complete when all of the cadets have successfully stepped off the plank into the "V".	
SAFETY <ul style="list-style-type: none">• Ensure the activity is set up on grass or soft ground. In situations where this is not possible, have gym mats set up on either side of the plank.• Have one or two assistant instructors to spot the cadets on the plank.• Caution the cadets that if they are about to lose their balance they should step off the plank to avoid causing other cadets to fall or jump.• Ensure the cadets do not jump off the plank as it could cause it to spin.	
REFERENCE <p>(ISBN 0-07-059532-1) Snow, H. (1997). <i>Indoor/Outdoor Team-Building Games for Trainers</i>. (pp. 125–128). New York, NY: McGraw-Hill.</p>	

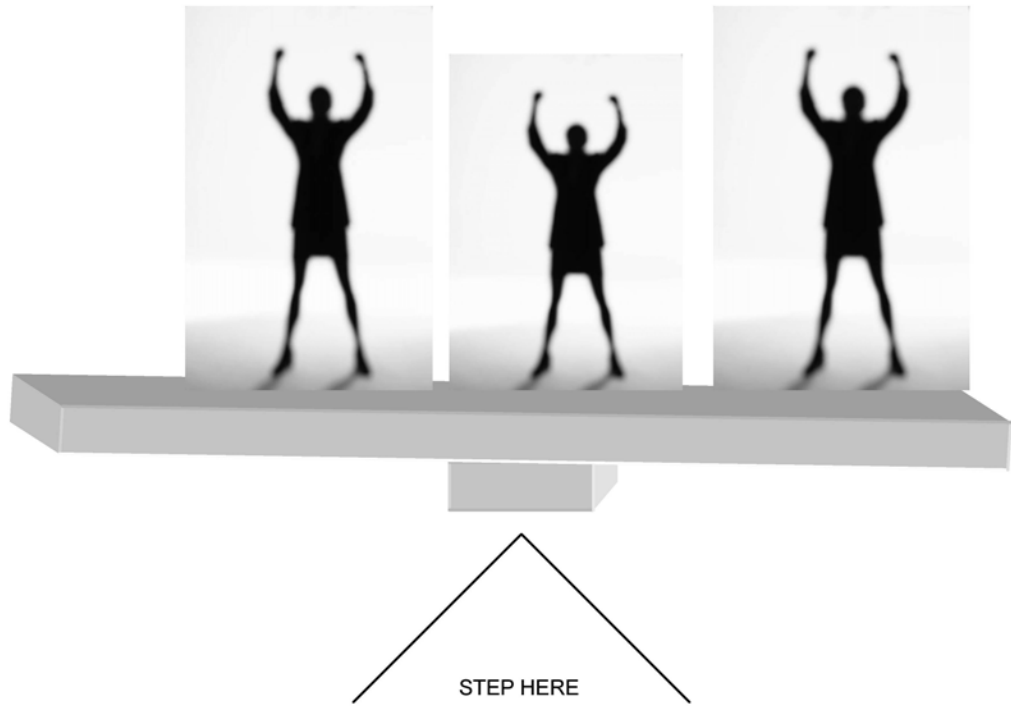

Director Cadets 3, 2008, Ottawa, ON: Department of National Defence

Figure 3P-3 Balance Beam Set-Up

TEAM-BUILDING ACTIVITY	PROBLEM-SOLVING
GROUP SEARCH	TIME: 15 min
RESOURCES <ul style="list-style-type: none">• A large, open space free from obstacles,• Masking tape/long piece of cloth (approximately 1.2 m [4 feet] long),• Blindfolds (one per every two cadets),• Stopwatch, and• Three small toys/objects that will fit in a hand (e.g., plastic dinosaur, plastic boat, plastic plane, plastic tank, doll, ball, etc).	
ACTIVITY LAYOUT <p>N/A.</p>	
ACTIVITY INSTRUCTIONS <ol style="list-style-type: none">1. Divide the cadets into two groups.2. Show the first group the three objects they will have to find.3. Explain that the group, together as a team, will have to find the three objects while blindfolded.4. Put masking tape or a long piece of cloth around the first group to attach them together.5. Blindfold the first group of cadets.6. Place the objects at various places on the ground within approximately 9 m (30 feet) of their location.7. Have the cadets' move to find the three objects with the verbal assistance of the second group. It is the cadets' goal to decide how best to move about the area without breaking the tape/cloth or removing their blindfolds.8. As the cadets find each object they are to identify what it is to the leader.9. Have the groups reverse roles and repeat Steps 2. to 8.10. Time both groups to see which group found and identified all three objects faster.	
SAFETY <p>Ensure the safety of the cadets who are blindfolded and attached to their team. The cadets in the other group should be watching out for any safety concerns and alerting the blindfolded cadets.</p>	
REFERENCE <p>(ISBN 0-07-059532-1) Snow, H. (1997). <i>Indoor/Outdoor Team-Building Games for Trainers</i>. (pp. 133–134). New York, NY: McGraw-Hill.</p>	

TEAM-BUILDING ACTIVITY	PROBLEM-SOLVING
TRAFFIC JAM	TIME: 15 min
RESOURCES	
<ul style="list-style-type: none"> • A large, open space free from obstacles, and • Tape or pieces of cardboard/plywood (there should be one more space than the number of cadets). 	
ACTIVITY LAYOUT	
<ul style="list-style-type: none"> • Mark spaces on the ground (as illustrated in Figure 3P-4) with tape or pieces of cardboard/plywood (there should be one more space than the number of cadets). • Mark the centre space with an “X” (as illustrated in Figure 3P-4). 	
ACTIVITY INSTRUCTIONS	
<ol style="list-style-type: none"> 1. Divide the cadets into two equal groups. 2. Have each group stand on a space facing the middle space. 3. Explain that the group is to attempt to move past each other so that the group to the right of the ‘X’ ends up on the left and vice versa. 4. Explain the following rules: <ol style="list-style-type: none"> (a) Cadets are not allowed to move around someone facing the same direction as them. (b) Cadets are not allowed to move backwards around someone. (c) Cadets are allowed to step forward onto an empty space. (d) Cadets are allowed to step around someone facing them into an empty space. 5. The activity is complete when all cadets have successfully changed sides. 	
SAFETY	
N/A.	
REFERENCE	
(ISBN 0-07-059532-1) Snow, H. (1997). <i>Indoor/Outdoor Team-Building Games for Trainers</i> . (pp. 149–150). New York, NY: McGraw-Hill.	



Director Cadets 3, 2008, Ottawa, ON: Department of National Defence

Figure 3P-4 Traffic Jam Set-Up

TEAM-BUILDING ACTIVITY	PROBLEM-SOLVING
CIRCLE WARS	TIME: 15 min
RESOURCES <ul style="list-style-type: none">• A large, open space free from obstacles, and• 15 rope circles of varying sizes between 0.3–1 m (1–3 feet) in diameter.	
ACTIVITY LAYOUT <p>Place the circles on the ground approximately 0.3–1 m (1–3 feet) apart from each other.</p>	
ACTIVITY INSTRUCTIONS <ol style="list-style-type: none">1. Explain to the cadets that they are to put both of their feet entirely in a circle. More than one cadet can put their feet in a circle at a time.2. On the word “change” have the cadets, when possible, move to another circle and put their feet entirely in that circle.3. After each time you say “change”, casually pick up one or two of the circles. This will cause the cadets to move faster as circles disappear.4. Once you get down to the last one or two circles, remind the cadets that they are not allowed to move them. Remind them that it is problem-solving initiative and they are to work with what they have in order to develop possible solutions.5. This activity is complete when the cadets all have their feet in the last circle.	
SAFETY <p>N/A.</p>	
REFERENCE <p>(ISBN 0-07-059532-1) Snow, H. (1997). <i>Indoor/Outdoor Team-Building Games for Trainers</i>. (pp. 163–165). New York, NY: McGraw-Hill.</p>	

TEAM-BUILDING ACTIVITY	PROBLEM-SOLVING
UNTYING KNOTS	TIME: 15 min
RESOURCES <ul style="list-style-type: none">• A large, open space free from obstacles, and• Soft cloth ropes approximately 2.5 m (8 feet) long (one per every cadet).	
ACTIVITY LAYOUT <p>N/A.</p>	
ACTIVITY INSTRUCTIONS <ol style="list-style-type: none">1. Have the cadets stand in a circle approximately 3 m (10 feet) in diameter.2. Have every cadet hold a piece of rope in their right hand.3. Explain that the cadets must join their free hand with the ropes of other cadets in the circle. Explain that the cadets are not to hold the rope of a cadet standing next to them.4. This process continues until all cadets are holding a piece of rope in each hand and are joined to the rope in one cadet's right hand and a different cadet's left hand. This will create a knot in the cadets through the ropes (much like a human knot).5. Have the cadets untie the knot the ropes have created using the following rules:<ol style="list-style-type: none">(a) cadets are not allowed to let go of their ropes or change hands with the ropes;(b) cadets are to communicate and move around to untie the knot to form a connected circle; and(c) cadets may end up facing outward from the circle.	
SAFETY <p>N/A.</p>	
REFERENCE <p>(ISBN 0-7360-5088-4) Midura, D. W., & Glover, D. R. (2005). <i>Essentials of Team Building</i>. (pp. 56–57). Champaign, IL: Human Kinetics.</p>	

TEAM-BUILDING ACTIVITY	PROBLEM-SOLVING
STEPPING STONES	TIME: 15 min
RESOURCES <ul style="list-style-type: none">• A large, open space free from obstacles, and• One base (e.g., pieces of cardboard/plywood/tape) per cadet plus one extra.	
ACTIVITY LAYOUT <p>Place each base/tape mark in a straight line approximately 30–38 cm (12–15 inches) apart.</p>	
ACTIVITY INSTRUCTIONS <ol style="list-style-type: none">1. Have the cadets stand in a specified order of their choosing, on a base each.2. Have the cadets determine where the extra base goes.3. The objective is for the team to end up standing in reverse order from their starting position.4. The following rules apply:<ol style="list-style-type: none">(a) Only one person may touch a base at a time.(b) When moving bases, a cadet may move in either direction to a neighbouring base.(c) Cadets may move to a new base only if it is empty.(d) The bases cannot be moved.(e) Cadets are not allowed to touch the ground during the activity.(f) If any one cadet breaks a rule, the entire group must start the task over.	
SAFETY <p>Secure the bases to the ground or use tape so that the bases do not move.</p>	
REFERENCE <p>(ISBN 0-7360-5088-4) Midura, D. W., & Glover, D. R. (2005). <i>Essentials of Team Building</i>. (pp. 106–107). Champaign, IL: Human Kinetics.</p>	

TEAM-BUILDING ACTIVITY	PROBLEM-SOLVING
SWAMP TRAIL	TIME: 15 min
RESOURCES <ul style="list-style-type: none">• A large, open space free from obstacles,• Twelve 30-cm (12-inch) bases (e.g., cardboard/poly spots/tape),• Tape, and• Six beanbags.	
ACTIVITY LAYOUT <ul style="list-style-type: none">• Designate a start and finish line approximately 4.5 m (15 feet) apart (the swamp is the area in between the two lines).• Place the bases in two parallel lines between the start and finish lines.• Place a beanbag at various distances, between 0.5–1.5 m (2–4 feet) away from bases 2, 3, 5, 7, 9 and 10 (as illustrated in Figure 3P-5).	
ACTIVITY INSTRUCTIONS <ol style="list-style-type: none">1. Explain to the cadets that they must cross a swamp as a team, holding hands along the way. Each cadet must make it to the other side without stepping into the swamp or letting go of their team members' hands.2. Explain that along the way, the cadets are to pick up the beanbags.3. The following rules apply:<ol style="list-style-type: none">(a) The team must hold hands for the duration of the activity.(b) A cadet who is attempting to pick up a beanbag may let go of their team member's hand but must rejoin hands before moving to a new base.(c) No one may touch the swamp during the trip through to the other side.(d) Each cadet is permitted to pick up and carry only one beanbag.4. Have the cadets participate in the activity.	
SAFETY <ul style="list-style-type: none">• Ensure the bases are secured to the ground or tape is used so that there is no chance of them slipping.• Each cadet must ensure the safety of their fellow team members as they cross the swamp.	
REFERENCE <p>(ISBN 0-7360-5088-4) Midura, D. W., & Glover, D. R. (2005). <i>Essentials of Team Building</i>. (pp. 166–167). Champaign, IL: Human Kinetics.</p>	

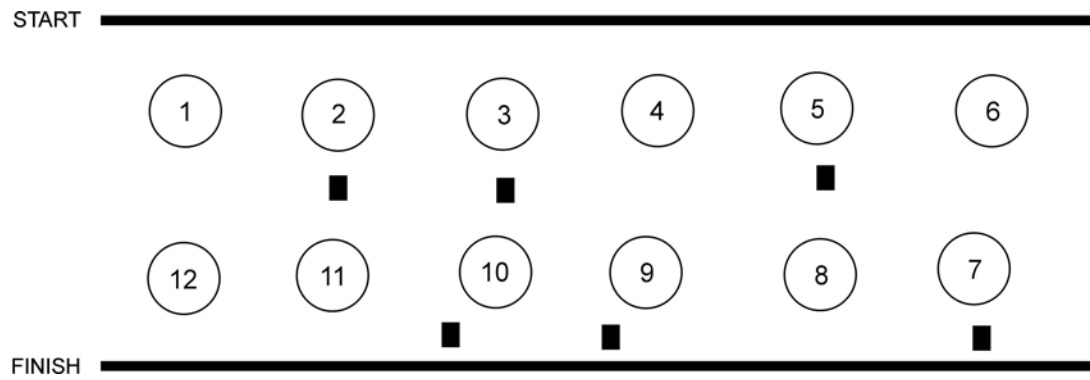

Director Cadets 3, 2008, Ottawa, ON: Department of National Defence

Figure 3P-5 Swamp Trail Set-Up

TEAM-BUILDING ACTIVITY	PROBLEM-SOLVING
HUMAN KNOT	TIME: 15 min
RESOURCES A large, open space free from obstacles.	
ACTIVITY LAYOUT N/A.	
ACTIVITY INSTRUCTIONS <ol style="list-style-type: none">1. Have the cadets form a tight circle facing the centre, raise their arms in the air and grasp the hands of two different cadets. The cadets should not be holding hands with the cadets directly on either side of them.2. Have the cadets untangle themselves without letting go of the other cadets' hands.3. The activity is complete when the cadets have untied the knot and formed a circle.	
SAFETY The cadets are to ensure the safety of their team members at all times throughout the duration of this activity.	
REFERENCE (ISBN 0-934387-05-2) Collard, M. (2005). <i>No Props: Great Games With No Equipment</i> . (pp. 165–166). Beverly, MA: Project Adventure, Inc.	

TEAM-BUILDING ACTIVITY	PROBLEM-SOLVING
SPIDER’S WEB	TIME: 15 min
RESOURCES <ul style="list-style-type: none">• A large, open space free from obstacles,• Poles/trees to tie the spider’s web on,• Rope/twine/para cord (approximately 15 m [50 feet] long), and• Gym mats (approximately four)/soft ground (e.g., grass/sand).	
ACTIVITY LAYOUT <p>Create a spider’s web between two poles/trees on soft ground or place gym mats around the area to be used (as illustrated in Figure 3P-6). The spider’s web should have more openings than there are number of people. The openings must be shapes and sizes that the cadets can pass through with some ease.</p>	
ACTIVITY INSTRUCTIONS <ol style="list-style-type: none">1. Explain that each cadet must pass through a different opening in the spider’s web until all cadets have passed from one side to the other.2. Explain that no cadet may touch the web with any part of the body.3. The cadets may reach through the web to assist a team member but may not touch the web.4. Have the cadets participate in the activity.5. If a cadet touches the web or passes through an opening that another team member has already passed through, that cadet and an already successful team member must go back and attempt the task again.6. The activity is complete when the entire team has passed successfully through the spider’s web to the other side.	
SAFETY <ul style="list-style-type: none">• Cadets are not permitted to dive through the openings.• The cadets must ensure the safety of their team members at all times throughout this activity.	
REFERENCE <p>(ISBN 0-7360-5088-4) Midura, D. W., & Glover, D. R. (2005). <i>Essentials of Team Building</i>. (pp. 154–155). Champaign, IL: Human Kinetics.</p>	

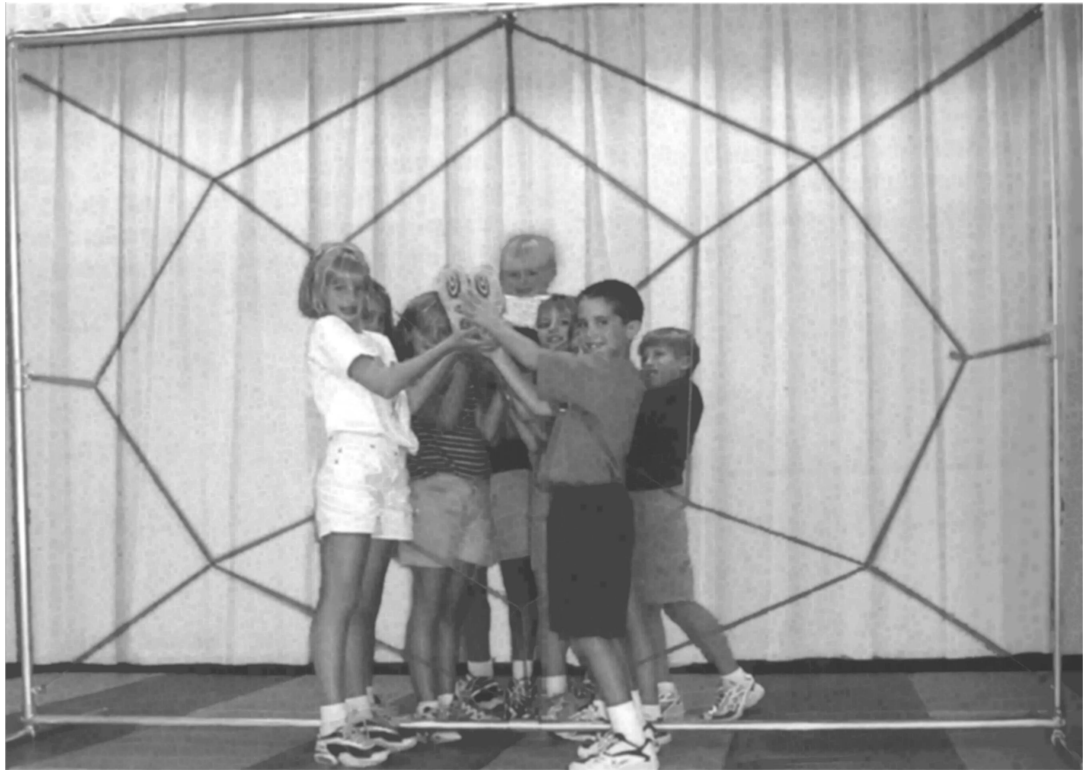

D. W. Midura, & D. R. Glover, Essentials of Team Building, Human Kinetics (p. 154)

Figure 3P-6 Spider Web Set-Up

TEAM-BUILDING ACTIVITY	PROBLEM-SOLVING
CIRCLE CLAP	TIME: 10-15 min
RESOURCES A large, open space free from obstacles.	
ACTIVITY LAYOUT N/A.	
ACTIVITY INSTRUCTIONS <ol style="list-style-type: none">1. Explain that the objective of this activity is for everyone to simultaneously clap hands with the person next to them.2. Have the cadets form a circle. Choose a cadet to begin and have each cadet clap once in succession.3. Next, have the cadets attempt to make one solitary clap, all clapping in unison.4. Once they have achieved this, have the cadets attempt to make one solitary clap—the catch being they cannot clap their own hands together. The cadets must clap their hands with the hands of the cadets on either side of them.5. This activity is complete when the cadets have successfully made one solitary clap by clapping the hands of the cadets on both sides of them.	
SAFETY N/A.	
REFERENCE (ISBN 0-934387-05-2) Collard, M. (2005). <i>No Props: Great Games With No Equipment</i> . (pp. 155–156). Beverly, MA: Project Adventure, Inc.	

TEAM-BUILDING ACTIVITY	PROBLEM-SOLVING
QUICK SHUFFLE	TIME: 10-15 min
RESOURCES A large, open space free from obstacles.	
ACTIVITY LAYOUT N/A.	
ACTIVITY INSTRUCTIONS <ol style="list-style-type: none">1. Divide the cadets into two groups. The cadets should not be evenly divided (e.g., if there are 10 cadets, divide them into a group of seven and a group of three).2. Have the larger group stand in one line, side by side, in front of the smaller group. Note the order of the larger group as a reference at the end of the activity.3. Have the smaller group look at the lineup of cadets for approximately 10 seconds. Then have the cadets close their eyes until directed to open them. While these cadets have their eyes closed, have the larger group quietly shuffle their positions within the lineup.4. Tell the smaller group to open their eyes and try to put the lineup back into their original configuration.5. This activity is complete when the cadets have been put into their original configuration.6. If the cadets complete this activity quickly, rearrange the groups and repeat Steps 1. to 5.	
SAFETY N/A.	
REFERENCE (ISBN 0-934387-05-2) Collard, M. (2005). <i>No Props: Great Games With No Equipment</i> . (p. 147). Beverly, MA: Project Adventure, Inc.	

TEAM-BUILDING ACTIVITY	PROBLEM-SOLVING
TALL TOWER	TIME: 10-15 min
RESOURCES <ul style="list-style-type: none">• A large, open space free from obstacles, and• Supplies for each group to build a tower (e.g., paper, raw spaghetti noodles, marshmallows, toothpicks, straws, paper clips, paper cups, chewing gum, tape, etc).	
ACTIVITY LAYOUT <p>N/A.</p>	
ACTIVITY INSTRUCTIONS <ol style="list-style-type: none">1. Divide the cadets into groups of two to four cadets.2. Distribute an equal amount of the supplies to each group.3. Explain to each group that they are to build the tallest tower they can using only the supplies given to them.4. Allow the groups approximately seven minutes to build their towers. Have each group display their tower for the other groups.5. Determine which group has the tallest tower.	
SAFETY <p>N/A.</p>	
REFERENCE <p>(ISBN 0-9662341-6-2) Jones, A. (1999). <i>Team-Building Activities for Every Group</i>. (pp. 92–93). Richland, WA: Rec Room Publishing.</p>	

TEAM-BUILDING ACTIVITY	PROBLEM-SOLVING
SWAMP CROSSING	TIME: 15 min
RESOURCES <ul style="list-style-type: none">• A large, open space free from obstacles,• Pieces of cardboard about 30 cm (12 inches) square (two fewer pieces than there are cadets), and• Three 2-L plastic jugs with lids, and• Water.	
ACTIVITY LAYOUT <ul style="list-style-type: none">• Fill the plastic jugs with water and put the lids on them.• Designate the start and finish lines for the swamp and place the plastic jugs at the finish.	
ACTIVITY INSTRUCTIONS <ol style="list-style-type: none">1. Tell the cadets the following story: “Your group is stranded on an island and you need fresh water. The only water is in jugs on the other side of the salt-water, alligator-infested swamp. You must go and get it. You must do this as a group because the island gorillas are on the other side and are protective of their water but are afraid of a large group. You may use these special floating stepping stones (give them one or two fewer pieces of cardboard than there are cadets) that you can move across the water. The stones may be moved only by being picked up and set back down. You may not slide them because this will cause them to sink into the swamp.”2. Explain that the cadets may not make a bridge with the stones but must move the last one to the front in order to advance through the swamp.3. Have the cadets cross the swamp, get the jugs of water and return safely to the start of the swamp with the jugs.	
SAFETY N/A.	
REFERENCE (ISBN 0-9662341-6-2) Jones, A. (1999). <i>Team-Building Activities for Every Group</i> . (pp. 104–105). Richland, WA: Rec Room Publishing.	

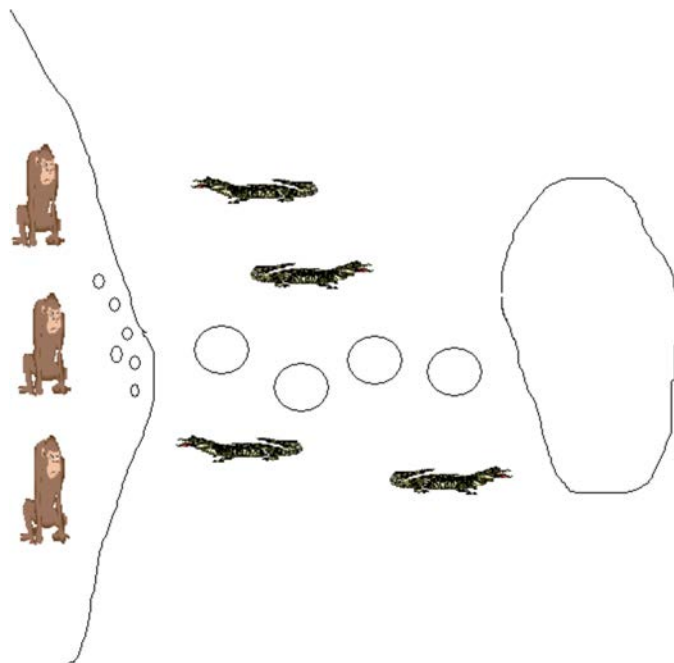

Director Cadets 3, 2008, Ottawa, ON: Department of National Defence

Figure 3P-7 Swamp Crossing Set-Up

TEAM-BUILDING ACTIVITY	PROBLEM-SOLVING
WATER TRANSFER	TIME: 10-15 min
RESOURCES <ul style="list-style-type: none">• A large, open space free from obstacles,• Four old bicycle tire inner tubes/three hula hoops,• Chalk/tape,• Two large coffee cans, and• Water.	
ACTIVITY LAYOUT <ul style="list-style-type: none">• In a large, open area draw/tape a circle on the ground that is approximately 4.5 m (15 feet) in diameter.• Place one large coffee can, half-filled with water, in the centre of the circle.	
ACTIVITY INSTRUCTIONS <ol style="list-style-type: none">1. Explain to the cadets that they are to get the can of water out of the circle without spilling any of the water.2. Give the cadets either four old bicycle inner tubes or three hula hoops.3. Explain that the following rules apply:<ol style="list-style-type: none">(a) Cadets are not allowed to cross into the circle with any part of their body.(b) The extra coffee can may be used for practice before moving the coffee can holding the water.(c) Once the cadets have retrieved the can of water they are to pour it into the empty can without the two cans touching.4. Have the cadets participate in the activity.5. This activity is complete when the cadets have successfully retrieved the can with water out of the circle and poured it into the second can without spilling any water.	
SAFETY <p>N/A.</p>	
REFERENCE <p>(ISBN 0-9662341-6-2) Jones, A. (1999). <i>Team-Building Activities for Every Group</i>. (pp. 114–115). Richland, WA: Rec Room Publishing.</p>	

TEAM-BUILDING ACTIVITY	PROBLEM-SOLVING
EGG CONSTRUCTION	TIME: 15 min
RESOURCES <ul style="list-style-type: none">• Raw eggs (one per group), and• Supplies to build an egg protection cover (e.g., straws, tape, paper, popsicle sticks, glue, etc).	
ACTIVITY LAYOUT <p>N/A.</p>	
ACTIVITY INSTRUCTIONS <ol style="list-style-type: none">1. Divide the cadets into two groups.2. Distribute a raw egg and an equal amount of supplies to each group.3. Have the cadets build an egg protection cover for their egg which will be dropped from a height of at least 2 m (6 feet).4. Explain that once each group has their covers built they are to gather as a complete group and drop their eggs to see if they break or are protected.5. Have the groups drop their eggs, one group at a time, to see if they are adequately protected.	
SAFETY <p>N/A.</p>	
REFERENCE <p>(ISBN 0-9662341-6-2) Jones, A. (1999). <i>Team-Building Activities for Every Group</i>. (p. 116). Richland, WA: Rec Room Publishing.</p>	

TEAM-BUILDING ACTIVITY	PROBLEM-SOLVING
WATER CARRY	TIME: 15 min
RESOURCES <ul style="list-style-type: none">• A large, open space free from obstacles,• Ten paper cups,• Cafeteria-style tray, and• Water, and• Paper towels/mop.	
ACTIVITY LAYOUT <ul style="list-style-type: none">• Fill the 10 paper cups with water, about three-quarters full.• Place five paper cups at one end of the space and five at the opposite end (the space should be a minimum of 4.5 m [15 feet] apart).• Place the cafeteria-style tray in the middle of the area (as illustrated in Figure 3P-8).• Have an extra jug of water to refill cups and paper towel or a mop to clean up spills.	
ACTIVITY INSTRUCTIONS <ol style="list-style-type: none">1. Explain that the cadets are to start in the middle of the space where the cafeteria-style tray is placed.2. Have the cadets retrieve all 10 cups and place them onto the tray without spilling any of the water. The following rules apply:<ol style="list-style-type: none">(a) Cadets may only get one cup at a time.(b) Before getting a second cup from that side of the room, the cadets must travel to the other side of the room with the tray and retrieve a cup from that side.(c) When cadets have retrieved all 10 cups of water, they are to place the tray on the floor in the centre of the space.(d) Each cadet can only use one foot and one hand for the duration of this activity.3. Explain that if any water is spilled the whole group must start over.4. This activity is complete when the 10 cups have been successfully placed on the tray in the centre of the space.	
SAFETY <p>N/A.</p>	
REFERENCE <p>(ISBN 0-9662341-6-2) Jones, A. (1999). <i>Team-Building Activities for Every Group</i>. (pp. 146–147). Richland, WA: Rec Room Publishing.</p>	

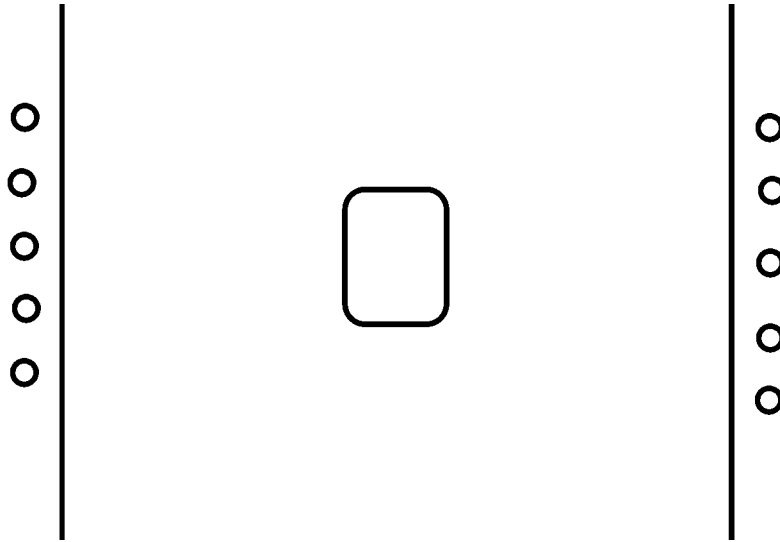

Director Cadets 3, 2008, Ottawa, ON: Department of National Defence

Figure 3P-8 Water Carry Set-Up

TEAM-BUILDING ACTIVITY	TRUST-BUILDING
CRAZY MAZE	TIME: 15 min
RESOURCES <ul style="list-style-type: none">• A large, open space,• Chairs (minimum of 10),• Yarn, string or thin rope (approximately 15 m [50 feet] long) for each group, and• Blindfolds (two).	
ACTIVITY LAYOUT <p>N/A.</p>	
ACTIVITY INSTRUCTIONS <ol style="list-style-type: none">1. Divide the cadets into two groups.2. Distribute a minimum of five chairs and yarn, string or thin rope to each group.3. Have the two groups go to separate parts of the training area.4. Have each group create a maze with the chairs and yarn, string or rope, with as many twists and turns as possible and perhaps even some dead ends along the way.5. Once each group has completed their maze, have a blindfolded volunteer from each group walk through the other group's maze. The mazes will be completed one at a time.6. The blindfolded cadet will be verbally led through the maze by their group. Members of the group that constructed the maze may try to confuse the cadet by giving opposing directions. At no time may the groups touch the blindfolded cadet to help them through the maze.	
SAFETY <p>The cadets must ensure the safety of the blindfolded cadets at all times throughout this activity.</p>	
REFERENCE <p>(ISBN 0-9662341-6-2) Jones, A. (1999). <i>Team-Building Activities for Every Group</i>. (pp. 136–137). Richland, WA: Rec Room Publishing.</p>	

TEAM-BUILDING ACTIVITY	TRUST-BUILDING
EVERYBODY UP	TIME: 15 min
RESOURCES A large, open space free from obstacles.	
ACTIVITY LAYOUT N/A.	
ACTIVITY INSTRUCTIONS <ol style="list-style-type: none">1. Divide the cadets into pairs (the first time this activity is done it may be best to try to pair the cadets by size).2. Have the cadets sit in two straight lines, facing their partners, with the soles of their shoes pressed against their partner's shoes.3. Have the cadets grab their partner's hands.4. On your count, have the cadets try to pull each other up to a standing position without letting go of each other's hands.5. If time allows, the cadets can switch partners and attempt this activity with a new partner of a different size.	
SAFETY The cadets must ensure the safety of their partners at all times throughout this activity by maintaining a solid grasp of one another and staff members must supervise carefully to ensure proper procedures are being followed.	
REFERENCE (ISBN 0-7872-0107-3) (1995). <i>Youth Leadership in Action</i> . (pp. 86–87). Dubuque, IA: Kendall/Hunt Publishing Company.	

TEAM-BUILDING ACTIVITY	TRUST-BUILDING
SLICE & DICE	TIME: 10-15 min
RESOURCES A large, open space free from obstacles.	
ACTIVITY LAYOUT N/A.	
ACTIVITY INSTRUCTIONS <ol style="list-style-type: none">1. Have the cadets line up in two separate lines facing each other approximately 1–1.5 m (3.5–5 feet) apart.2. Select a volunteer to be the first walker.3. Explain that upon starting the activity the cadets in the lines should start to swing their arms full stretch in front of them in a chopping motion, bringing the arms up and down in succession (as illustrated in Figure 3P-9). This activity should be started slowly and may pick up speed as the cadets get used to the motion.4. Have the walker walk through the line of swinging arms at a steady pace.5. As time allows, have as many walkers go through the line as possible.	
SAFETY Explain the following safety considerations to the group: <ul style="list-style-type: none">• Members swinging their arms are to ensure they do not touch the walker.• Walkers are to ensure they keep their eyes open.• Walkers are to ensure they keep a steady pace while walking through the lines.	
REFERENCE (ISBN 0-934387-05-2) Collard, M. (2005). <i>No Props: Great Games With No Equipment</i> . (pp. 136–137). Beverly, MA: Project Adventure, Inc.	

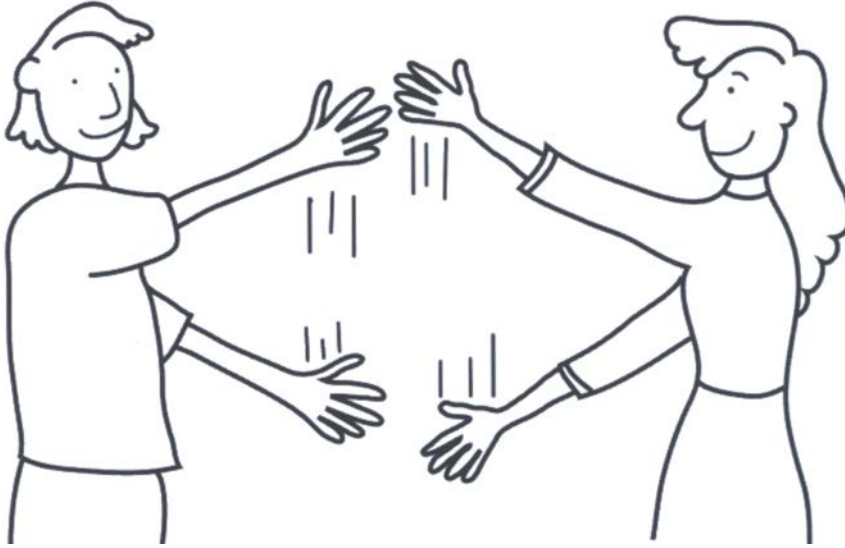

M. Collard, No Props: Great Games With No Equipment, Project Adventure, Inc. (p. 136)

Figure 3P-9 Slice and Dice

TEAM-BUILDING ACTIVITY	TRUST-BUILDING
HOG CALL	TIME: 10-15 min
RESOURCES <ul style="list-style-type: none">• A large, open space free from obstacles, and• Blindfolds (one per cadet).	
ACTIVITY LAYOUT <p>N/A.</p>	
ACTIVITY INSTRUCTIONS <ol style="list-style-type: none">1. Have the cadets form two lines facing each other. The cadets facing each other will become partners. If there is an odd number, form one group of three.2. Assign each group a matching set of words from the following list (or have cadets quickly come up with their own set of appropriate words):<ol style="list-style-type: none">(a) peanut-butter,(b) Coca-Cola,(c) salt-pepper,(d) bubble-gum,(e) french-fry,(f) Ken-Barbie,(g) Power-Rangers,(h) Batman-Robin,(i) snap-crackle-pop, and(j) Larry-Curly-Moe.3. Have each line move to opposite ends of the training space. Have each group turn away from the other and blindfold all of the cadets. Each group of cadets will mix themselves up among the other participants.4. On a signal, have the cadets start the activity by shouting their partner's word. For example, if your word was peanut, you would shout "butter" and your partner would shout "peanut" until you found each other.5. Once partners find each other have them sit together and remove their blindfolds until all cadets have found their partners.	
SAFETY <p>All cadets are asked to place their hands in front of their torso with palms facing forward and elbows tucked in to avoid running into anything. The cadets are to move around the space cautiously to avoid running into anyone or anything.</p>	
REFERENCE <p>(ISBN 0-934387-05-2) Collard, M. (2005). <i>No Props: Great Games With No Equipment</i>. (pp. 126–127). Beverly, MA: Project Adventure, Inc.</p>	

TEAM-BUILDING ACTIVITY	TRUST-BUILDING
HUG A TREE	TIME: 15 min
RESOURCES	
<ul style="list-style-type: none">• A large, open space (preferably outdoors with lots of obstacles), and• Blindfolds (one per two cadets).	
ACTIVITY LAYOUT	
N/A.	
ACTIVITY INSTRUCTIONS	
<ol style="list-style-type: none">1. Divide the cadets into pairs.2. Blindfold one partner at a time and have the other cadet verbally guide them to an object that is at least 40–50 m (130–160 feet) away from the point from which they started.3. Once led to the object (e.g., a distinctive tree, fallen log, rock, etc) have the blindfolded cadet spend up to one minute getting acquainted with the object. The cadet should be encouraged to feel and smell the object.4. Have the cadet who is not blindfolded guide the blindfolded cadet back to the starting point—preferably not using a direct line.5. Upon arriving back at the starting point remove the blindfold.6. Have the cadet who was blindfolded attempt to find the object that they were introduced to while they were blindfolded. Have their partner accompany them while they attempt to find the object but should not offer them any clues.7. As time allows, have the cadets reverse roles.	
SAFETY	
The cadet who is not blindfolded is to ensure the safety of the blindfolded cadet at all times throughout this activity.	
REFERENCE	
(ISBN 0-934387-05-2) Collard, M. (2005). <i>No Props: Great Games With No Equipment</i> . (pp. 122–123). Beverly, MA: Project Adventure, Inc.	

TEAM-BUILDING ACTIVITY	TRUST-BUILDING
BLINDFOLD BUILD	TIME: 15 min
RESOURCES <ul style="list-style-type: none">• A large, open space free from obstacles,• Blindfolds (one per two cadets), and• Building blocks (minimum 40).	
ACTIVITY LAYOUT <p>N/A.</p>	
ACTIVITY INSTRUCTIONS <ol style="list-style-type: none">1. Divide the cadets into two even groups. Blindfold the cadets from one group.2. Use the building blocks to build a structure with half of the blocks while the non-blindfolded cadets watch. Give them one minute to study the structure.3. Hide the structure and scatter the other half of the pieces around the space.4. Have the non-blindfolded cadets guide the blindfolded cadets to build the same structure. The non-blindfolded cadets must not touch any building blocks.5. Once the structure is complete, have the cadets remove their blindfolds. Inform the group how close they were to the original.6. As time allows, have the cadets reverse roles.	
SAFETY <p>N/A.</p>	
REFERENCE <p>(ISBN 0-9662341-6-2) Jones, A. (1999). <i>Team-Building Activities for Every Group</i>. (pp. 66–67). Richland, WA: Rec Room Publishing.</p>	

TEAM-BUILDING ACTIVITY	TRUST-BUILDING
LIGHTHOUSE	TIME: 10-15 min
RESOURCES <ul style="list-style-type: none">• A large, open space,• Various obstacles (e.g., desks, chairs, boxes, crates, pylons, etc),• Blindfold, and• Pieces of wrapped candy (one piece per lighthouse).	
ACTIVITY LAYOUT <p>Set up obstacles around the training area.</p>	
ACTIVITY INSTRUCTIONS <ol style="list-style-type: none">1. Have one cadet volunteer to be the “cargo ship”. Blindfold this cadet.2. Have three or four cadets stand at various points among the obstacles. These cadets will be the “lighthouses”.3. Give the “cargo ship” three or four pieces of the wrapped candy.4. Explain that the job of each “lighthouse” is to guide the “cargo ship” through the rough waters (obstacle course) so the cargo (wrapped candy) can be delivered to each “lighthouse” safely.5. Have the “lighthouse” closest to the start point verbally guide the “cargo ship” safely to their “lighthouse”. If successful, the “cargo ship” should deliver the cargo (a piece of candy) to that person.6. Have each “lighthouse” guide the “cargo ship” to them in succession as the “cargo ship” makes their way through the rough water (obstacles).7. The only “lighthouse” allowed to give directions at a given time is the one the “cargo ship” is headed toward. If the “cargo ship” is in danger of crashing into an obstacle the guiding lighthouse does not receive their shipment of cargo. As well if the “lighthouse” is unable to successfully guide them to the “lighthouse” and the “cargo ship” passes by, they do not receive their shipment of cargo and the next “lighthouse” takes over the directions.8. As time allows, have the cadets change positions and assume different roles.	
SAFETY <p>The cadets acting as lighthouses are to ensure the safety of the cargo ship throughout the activity.</p>	
REFERENCE <p>(ISBN 0-9662341-6-2) Jones, A. (1999). <i>Team-Building Activities for Every Group</i>. (pp. 88–89). Richland, WA: Rec Room Publishing.</p>	

TEAM-BUILDING ACTIVITY	TRUST-BUILDING
TRUST TAG	TIME: 15 min
RESOURCES <ul style="list-style-type: none">• A large, open space free of obstacles, and• Blindfolds (one per two cadets).	
ACTIVITY LAYOUT <p>Mark off a playing area.</p>	
ACTIVITY INSTRUCTIONS <ol style="list-style-type: none">1. Divide the cadets into pairs. Blindfold one cadet from each pair.2. Designate one pair to be “it”.3. Have the blindfolded cadets play a game of tag while their partners verbally guide them through the game. The cadets are to walk for this activity, not run. The non-blindfolded cadet of the team who is “it” must attempt to guide their partner to tag someone. The non-blindfolded cadets of the other partners must attempt to guide their partners away from the cadet who is “it”.4. Halfway through the time, have the cadets reverse roles.	
SAFETY <ul style="list-style-type: none">• The cadets who are not blindfolded are to ensure the safety of the blindfolded cadets at all times throughout this activity.• Cadets are not permitted to run.	
REFERENCE <p>(ISBN 0-9662341-6-2) Jones, A. (1999). <i>Team-Building Activities for Every Group</i>. (pp. 102–103). Richland, WA: Rec Room Publishing.</p>	

THIS PAGE INTENTIONALLY LEFT BLANK

TEAM-BUILDING PLANNING GUIDE

TEAM-BUILDING ACTIVITY	Type: _____
Name of Activity: _____	Time: _____ minutes
QUESTIONS TO THE INSTRUCTOR	
TIME APPRECIATION	
Introduction:	
Conduct of Activity:	
Debriefing:	
ACTIVITY LAYOUT	
ACTIVITY INSTRUCTIONS	
SAFETY	
DEBRIEFING QUESTIONS	

THIS PAGE INTENTIONALLY LEFT BLANK

SELF-ASSESSMENT FORM – LEAD A TEAM-BUILDING ACTIVITY

1. How did you feel after leading a team-building activity?

2. How did you feel about the teamwork among the members? How did this affect your experience in leading the activity?

3. Which aspects did you feel went well while leading the activity? Which aspects did you feel did not go so well? Why?

4. What would you do differently given another opportunity lead a team-building activity?

THIS PAGE INTENTIONALLY LEFT BLANK

OUTLINE FOR DELIVERING A PRESENTATION ABOUT A LEADER

Use the information and techniques discussed from PO 309 (Instruct a Lesson, Chapter 9) while delivering this presentation.

This presentation is another opportunity to practice presentation skills.

This presentation is to be no less than 7 minutes and no more than 10 minutes long. Notes may be used to deliver this presentation. Presentation aids may be used during the delivery of the presentation (e.g., whiteboard/flip chart/OHP/multimedia projector/handouts).

This presentation will not be evaluated for delivery or content, however each cadet should do their best.

INTRODUCTION

- Name of the leader,
- Date and place of birth,
- Date of death (if applicable),
- Display a picture of the leader (if available), and
- Information about the childhood of the leader.

BODY

- Interesting points of the leader's career, to include:
 - positions of responsibility (if applicable); and
 - incidents where they used their influence;
- How and where the core leadership qualities were displayed by the leader, and
- Other interesting facts about the leader.

CONCLUSION

- Why you chose this leader,
- Three questions to ensure confirmation of the presentation, and
- A final summary sentence about the leader.

THIS PAGE INTENTIONALLY LEFT BLANK

CHAPTER 4

PO X04 – TRACK PARTICIPATION IN PHYSICAL ACTIVITIES



COMMON TRAINING
ALL TRAINING LEVELS
INSTRUCTIONAL GUIDE
PERSONAL FITNESS
AND HEALTHY LIVING



PO X04 – TRACK PARTICIPATION IN PHYSICAL ACTIVITIES

Total Time:

For the following EOs, refer to the lesson specifications located in A-CR-CCP-601/PG-001, *Royal Canadian Sea Cadets Phase One Qualification Standard and Plan*:

- CX04.01 – Participate in the Cadet Fitness Assessment and Identify Strategies for Improving Personal Physical Fitness,
- CX04.03 – Participate in a Cooking Class,
- CX04.04 – Attend a Personal Fitness and Healthy Living Presentation, and
- CX04.05 – Attend a Local Amateur Sporting Event.

For the following EOs, refer to the instructional guides located in A-CR-CCP-601/PF-001, *Royal Canadian Sea Cadets Phase One Instructional Guides*:

- MX04.01 – Participate in 60 Minutes of Moderate- to Vigorous-Intensity Physical Activity (MVPA) and Track Participation in Physical Activities,
- MX04.02 – Identify Strategies to Improve Participation in Physical Activities and Participate in the Cadet Fitness Assessment,
- MX04.03 – Participate in the Cadet Fitness Assessment and Identify Strategies for Improving Personal Physical Fitness, and
- CX04.02 – Participate in Activities that Reinforce the Three Components of Physical Fitness.

THIS PAGE INTENTIONALLY LEFT BLANK

CHAPTER 5

PO X05 – PARTICIPATE IN PHYSICAL ACTIVITIES



**COMMON TRAINING
ALL TRAINING LEVELS
INSTRUCTIONAL GUIDE
PHYSICAL ACTIVITIES**



PO X05 – PARTICIPATE IN PHYSICAL ACTIVITIES

Total Time:

For the following EOs, refer to the instructional guides located in A-CR-CCP-601/PF-001, *Royal Canadian Sea Cadets Phase One Instructional Guides*:

- MX05.01 – Participate in Physical Activities,
- CX05.01 – Participate in Physical Activities, and
- CX05.02 – Participate in a Tournament.

THIS PAGE INTENTIONALLY LEFT BLANK

CHAPTER 6

PO 306 – FIRE THE CADET AIR RIFLE DURING RECREATIONAL MARKSMANSHIP



COMMON TRAINING
PHASE THREE
INSTRUCTIONAL GUIDE



SECTION 1

EO M306.01 – PARTICIPATE IN A RECREATIONAL MARKSMANSHIP ACTIVITY

Total Time:

90 min

PREPARATION

PRE-LESSON INSTRUCTIONS

Resources needed for the delivery of this lesson are listed in the lesson specification located in A-CR-CCP-603/PG-001, Chapter 4. Specific uses for said resources are identified throughout the instructional guide within the TP for which they are required.

Review the lesson content, unit range standing orders, and become familiar with the material prior to delivering the lesson.

Photocopy the targets located at Annexes B to J as required.

Construct a range IAW A-CR-CCP-177/PT-001, *Canadian Cadet Movement: Cadet Marksmanship Program Reference Manual*.

PRE-LESSON ASSIGNMENT

N/A.

APPROACH

A practical activity was chosen for this lesson as it is an interactive way to allow the cadet to experience recreational marksmanship in a safe and controlled environment. This activity contributes to the development of marksmanship skills and knowledge in a fun and challenging setting.

INTRODUCTION

REVIEW

The review for this lesson will be from EO M106.02 (Carry Out Safety Precautions on the Cadet Air Rifle, A-CR-CCP-601/PF-001, Chapter 6, Section 2).

QUESTIONS

- Q1. Why do we follow safety regulations?
- Q2. How would you verify the safety catch is ON?
- Q3. What are the four "ACTS" of firearm safety?

ANTICIPATED ANSWERS

A1. We follow safety regulations to prevent accidents with the cadet air rifle.

A2. When the safety is ON, no red can be seen.

A3. The mnemonic "ACTS" stands for:

- Assume every firearm is loaded.
- Control the muzzle direction at all times.
- Trigger finger must be kept off the trigger and out of the trigger guard.
- See that the firearm is unloaded (prove it safe).

OBJECTIVES

By the end of this lesson the cadet shall have participated in a recreational marksmanship activity.

IMPORTANCE

It is important for cadets to participate in a recreational marksmanship activity because it allows them to experience marksmanship in a fun, dynamic and safe setting.

Teaching Point 1

Supervise the Participation of the Cadet in a Recreational Marksmanship Activity

Time: 80 min

Method: Practical Activity



A range briefing is conducted to pass on vital information and answer any questions the cadets may have prior to participating in a marksmanship activity. The range briefing is required to ensure the safe execution of a marksmanship activity.

CONDUCT A RANGE BRIEFING

1. Explain pertinent sections of the local range standing orders.
2. Review general rules observed on all ranges, to include:
 - (a) proving that rifles are safe prior to being picked up, handed to or received from another person;
 - (b) never pointing rifles at people;
 - (c) inserting safety rods into the barrels of rifles when not in use on the range;
 - (d) never horseplaying on a range;
 - (e) always pointing rifles down range; and
 - (f) following the Range Safety Officer's (RSO) directions and orders at all times.



Review range commands with an explanation and demonstration for each command.
All loading/firing is to be simulated.

3. Review commands used on an air rifle range (as illustrated in Figure 6-1-1).

Command	Action to Be Taken
Cover off your firing point	Stand up, move behind the firing point and await further commands.
Place your equipment down and stand back	Lay the equipment down on the mat and stand back when finished.
Adopt the prone position	Adopt the prone position, pick up the rifle, ready the equipment and put on hearing and eye protection.
Type of firing (GRIT)	<p>GRIT is the acronym for:</p> <ol style="list-style-type: none"> 1. Group (relay), 2. Range (distance), 3. Indication (number of rounds), and 4. Type (grouping, scored).
Relay, load	<ol style="list-style-type: none"> 1. Pick up and hold the rifle with the dominant hand. 2. Ensure the safety catch is in the “ON” position. 3. Pump the rifle, observing a three second pause. 4. Load a pellet (flat end forward). 5. Close the bolt.
Relay, fire	<ol style="list-style-type: none"> 1. Place the safety catch in the “OFF” position. 2. Aim the rifle at the target. 3. Squeeze the trigger. 4. Open the bolt. 5. Repeat the following sequence for each shot: <ol style="list-style-type: none"> (a) Pump the rifle, observing a three second pause. (b) Load a pellet (flat end forward). (c) Close the bolt. (d) Aim the rifle at the target. (e) Squeeze the trigger. (f) Open the bolt. 6. Place the safety in the “ON” position. 7. Partially open the pump lever. 8. Lay down the rifle.

Director Cadets 3, 2006, Ottawa, ON: Department of National Defence

Figure 6-1-1 Air Rifle Range Commands

4. Describe the layout of the air rifle range.
5. Review hand-washing procedures on completion of firing. This is important because each time a person handles pellets, a small trace of lead is left on their hands. To decrease the risk of lead poisoning, it is important that all persons wash their hands thoroughly after handling pellets.

ACTIVITY

OBJECTIVE

The objective of this activity is to provide the cadet the opportunity to participate in a recreational marksmanship activity.

RESOURCES

- Cadet air rifle (one per firing lane),
- Cadet air rifle sling (one per cadet),
- Air rifle pellets,
- Target frame,
- Suitable target,
- Shooting mat,
- Safety glasses/goggles, and
- Pen/pencil.



Additional resources required for specific marksmanship activities may be found in the annexes.

ACTIVITY LAYOUT

N/A.

ACTIVITY INSTRUCTIONS

1. Brief cadets on safety rules or any other guidelines pertaining to the activity.
2. Divide the cadets into relays according to the number of firing lanes.
3. Conduct a recreational marksmanship activity, choosing from the following categories:
 - (a) classification (see Annex A),
 - (b) fun activities (see Annexes B to E),
 - (c) timed activities (see Annexes F to H), or
 - (d) competitive team/individual activities (see Annexes I and J).



If EO C306.03 (Adopt the Standing Position With the Cadet Air Rifle, Section 4) has been taught prior to this marksmanship activity, this EO may be conducted in the standing position.

SAFETY

Range activities will be conducted IAW A-CR-CCP-177/PT-001.

END OF LESSON CONFIRMATION

The cadets' participation in the activity will serve as the confirmation of this lesson.

CONCLUSION

HOMEWORK/READING/PRACTICE

N/A.

METHOD OF EVALUATION

N/A.

CLOSING STATEMENT

Marksmanship is a fun and exciting activity that requires personal discipline and teamwork skills. This activity has also developed into highly competitive levels at the provincial, regional, and national levels.

INSTRUCTOR NOTES/REMARKS

Hand-washing stations must be available for cleanup after the activity is completed.

Cadets may fire in the standing position if they have previously received the training during C306.03 (Adopt the Standing Position With the Cadet Air Rifle, Section 4).

REFERENCES

- A0-027 A-CR-CCP-177/PT-001 Director Cadets 3. (2005). *Canadian Cadet Movement: Cadet Marksmanship Program Reference Manual*. Ottawa, ON: Department of National Defence.
- A0-041 Director Cadets 4. (2007). CATO 14-41, *Marksmanship, Rifles and Ammunition*. Ottawa ON: Department of National Defence.



COMMON TRAINING
PHASE THREE
INSTRUCTIONAL GUIDE



SECTION 2

EO C306.01 – IDENTIFY CIVILIAN MARKSMANSHIP ORGANIZATIONS

Total Time:

30 min

PREPARATION

PRE-LESSON INSTRUCTIONS

Resources needed for the delivery of this lesson are listed in the lesson specification located in A-CR-CPP-603/PG-001, Chapter 4. Specific uses for said resources are identified throughout the instructional guide within the TP for which they are required.

Review the lesson content and become familiar with the material prior to delivering the lesson.

Consult the Internet or local telephone directory to identify the national, provincial and local civilian marksmanship organizations applicable to the corps.

PRE-LESSON ASSIGNMENT

N/A.

APPROACH

An interactive lecture was chosen for this lesson to orient the cadet to opportunities available to enhance their marksmanship training with civilian organizations.

INTRODUCTION

REVIEW

N/A.

OBJECTIVES

By the end of this lesson the cadet shall have identified opportunities to enhance their marksmanship training with civilian organizations.

IMPORTANCE

It is important for the cadets to identify local civilian marksmanship organizations and understand that the activities available through these organizations are personal and not supported by the Cadet Program. Civilian marksmanship organizations assist people who are interested in marksmanship.

Teaching Point 1**Discuss Local Civilian Marksmanship Organizations**

Time: 5 min

Method: Interactive Lecture



Inform the cadets of a local civilian marksmanship organization and identify available activities and requirements for membership.

Civilian marksmanship organizations and rifle associations are popular throughout the world and are found in many countries. Traditionally formed to augment the military, marksmanship organizations now have become governing bodies for civilians interested in marksmanship.

Local civilian marksmanship organizations exist in most major cities in Canada. These organizations can include the city or regional rifle associations or local rod and gun clubs. These organizations usually have a small calibre rifle range available for their members' use. To find local civilian marksmanship organizations, refer to the Internet or the local telephone listings.

CONFIRMATION OF TEACHING POINT 1

QUESTIONS

- Q1. Why were civilian marksmanship organizations traditionally formed?
- Q2. What are some examples of these organizations?
- Q3. How would you find some organizations in your area?

ANTICIPATED ANSWERS

- A1. They were traditionally formed to augment the military.
- A2. City or regional rifle associations or local rod and gun clubs.
- A3. Refer to the internet or local telephone listings.

Teaching Point 2**Discuss the Applicable Provincial Rifle Organizations**

Time: 10 min

Method: Interactive Lecture

PROVINCIAL RIFLE ORGANIZATIONS

Select the rifle association for the province in which the cadet corps is located.



Civilian marksmanship organizations assist people interested in marksmanship to advance their skills in marksmanship. These activities are not supported by the Cadet Program.

Provincial rifle associations are the provinces' governing bodies on fullbore and smallbore target shooting. These associations exist to promote marksmanship within the province by organizing events and competitions. Provincial rifle associations also provide competitions for cadet units within their province. Provincial associations include:

Alberta Provincial Rifle Association. The Alberta Provincial Rifle Association (APRA) was created in 1902, as the Territorial Rifle Association, before the Province of Alberta was created. The objectives of the APRA are:

- to promote in every lawful way the interests of small arms marksmanship in the Province of Alberta;
- to promote annual prize meetings for individuals and teams and to offer prizes for skill in shooting;
- to encourage the establishment and maintenance of suitable ranges through legislation and private means;
- to assist in the formation of shooting clubs; and
- to create public interest for the encouragement of small arms shooting both as a sport and as a necessary means of national defence;

The APRA can be found on the Internet at www.albertarifle.com

British Columbia Rifle Association. The British Columbia Rifle Association (BCRA) was created in 1874, incorporated in 1910, and is one of the oldest members of the British Columbia Societies Act. The objectives of the BCRA are:

- to create a public sentiment for the encouragement of small arms shooting as a sport; and
- the control and safe handling of firearms and as a necessary part of national defence.

Through the Department of National Defence, members are permitted to participate in shooting events held on military rifle ranges in British Columbia.

The BCRA can be found on the Internet at www.bcrifle.org

Manitoba Provincial Rifle Association. The Manitoba Provincial Rifle Association Inc. (MPRA) was created in 1872, for the purpose of encouraging rifle shooting among the militia and citizens of Manitoba. The objectives of the MPRA are:

- to enhance the perception of shooting as a sport by encouraging and supporting all athletes involved in shooting to achieve their maximum performance levels; and
- to promote safe firearms handling.



The Honourable D.A. Smith (Lord Strathcona) was a patron of the MPRA for 40 years. He took an interest in shooting and donated many prizes, especially to cadets.

The MPRA can be found on the Internet at www.manitobarifle.ca

Newfoundland Provincial Rifle Association. The Newfoundland Provincial Rifle Association can be contacted through the Dominion of Canada Rifle Association (DCRA).

Nova Scotia Rifle Association. The Nova Scotia Rifle Association (NSRA) was created in 1861, and is the oldest provincial rifle association. The objectives of the NSRA are:

- to foster the safe and responsible use of firearms, and
- to develop marksmanship skills.

The NSRA can be found on the Internet at www.nsrifle.org

Ontario Provincial Rifle Association. The Ontario Provincial Rifle Association (ORA) was created in 1868. The objectives of the ORA are:

- to provide opportunities for shooting with different types of rifles; and
- offer programs for marksman from beginner to world class.

The ORA can be found on the Internet at www.ontariorifleassociation.org

Prince Edward Island Rifle Association. The Prince Edward Island Rifle Association can be contacted through the DCRA.

Province of Quebec Rifle Association. The Province of Quebec Rifle Association (PQRA) was created in 1869 and supports various shooting clubs and associations. The objective of the PQRA is to teach and promote marksmanship in competitive and recreational environments, where safety is first and foremost.

The PQRA can be found on the Internet at www.pqra.org

Royal New Brunswick Rifle Association. The Royal New Brunswick Rifle Association (RNBRA) was created in 1866 to serve all shooting and related disciplines in New Brunswick. The objectives of the RNBRA are to promote:

- good sportsmanship,
- safe, efficient and practical arms handling, and
- good marksmanship by civilians, civic police and the military.

The RNBRA can be found on the Internet at www.rnbra.ca

Saskatchewan Provincial Rifle Association. The Saskatchewan Provincial Rifle Association (SPRA) is the governing body for fullbore target rifle shooting in Saskatchewan. The objectives of the SPRA are to promote:

- the pursuit of excellence in marksmanship; and
- the safe and responsible handling of firearms.

The SPRA can be found on the Internet at www.saskrifle.ca

CONFIRMATION OF TEACHING POINT 2

QUESTIONS

- Q1. What is the objective of provincial rifle associations?
- Q2. How do these rifle associations meet this objective?
- Q3. How do these associations support the cadet movement?

ANTICIPATED ANSWERS

- A1. To promote marksmanship within the province.
- A2. By organizing marksmanship events and competitions.
- A3. By providing competitions for cadet units within their province.

Teaching Point 3**Discuss National Marksmanship Organizations**

Time: 5 min

Method: Interactive Lecture

NATIONAL MARKSMANSHIP ORGANIZATIONS**The DCRA**

The DCRA, headquartered at Connaught Ranges Primary Training Centre, Ottawa, Ont., is Canada's national governing body for fullbore and smallbore target shooting. The DCRA was founded in 1868 and incorporated by parliament in 1890, to encourage marksmanship training in response to the departure of the British military and the Fenian Raids in 1866.



The Fenian Raids were attacks on British targets in Canada between 1866 and 1871, to pressure Britain to withdraw from Ireland. Most of the raids were successfully repelled by British forces and local militias.

The DCRA continues to promote excellence in civilian and military marksmanship.

The DCRA works with the CCM by organizing events and competitions including postal championships held for cadet units across the country and summer matches for the National Rifle Team (NRT) and Canadian and British army cadets on CSTC courses at Connaught NACSTC.

The DCRA can be found on the internet at www.dkra.ca



Section One of the DCRA postal championships are matches that are restricted to sea, army and air cadets. Section Two is open to any junior team and cadets are encouraged to enter.

The Shooting Federation of Canada (SFC)

The SFC, headquartered at Connaught Ranges Primary Training Centre, Ottawa, Ont., is Canada's national sport governing body for recreational and competitive target shooting in Canada. The SFC is the authority for the marksmanship technical training portion of the National Coaching Certification Program (NCCP).

The SFC can be found on the internet at www.sfc-ftc.ca

CONFIRMATION OF TEACHING POINT 3**QUESTIONS**

- Q1. What are the two National Marksmanship Organizations in Canada?
- Q2. How does the DCRA work with the NRT?
- Q3. How does the DCRA work with cadet units across Canada?

ANTICIPATED ANSWERS

- A1. The Dominion of Canada Rifle Association and the Shooting Federation of Canada.
- A2. The DCRA works with the NRT by organizing events and competitions during the summer.
- A3. The DCRA conducts postal matches held for cadet units across the country.

Teaching Point 4**Identify the Applicable National/Provincial Biathlon Organizations**

Time: 5 min

Method: Interactive Lecture

BIATHLON CANADA

Biathlon Canada is the governing body for the sport of biathlon within Canada. Biathlon Canada organizes many events, competitions and programs, including the Biathlon Bears Program, which is a community program, offered across Canada. The Biathlon Bears program is open to novices and the training is tailored to the athlete's skill level. This program offers training to develop both skiing and marksmanship skills. As skills are learned and mastered, the biathlete progresses to the next Biathlon Bear level.

PROVINCIAL AND TERRITORIAL BIATHLON ORGANIZATIONS

Divisions of Biathlon Canada are located within many of the provinces and territories. These division offices run training and offer support to the local resorts/clubs. These divisions include:

- Biathlon Alberta,
- Biathlon British Columbia,
- Biathlon Manitoba,
- Biathlon New Brunswick,
- Biathlon Nova Scotia,
- Biathlon Newfoundland and Labrador,
- Biathlon Ontario,
- Biathlon Quebec,
- Biathlon Saskatchewan,
- Biathlon Yukon, and
- Northwest Territories Biathlon.

CONFIRMATION OF TEACHING POINT 4

QUESTIONS

- Q1. What organization is the governing body for the sport of biathlon within Canada?
- Q2. What community biathlon program is offered across Canada?
- Q3. What are the objectives of the provincial and territorial organizations?

ANTICIPATED ANSWERS

- A1. Biathlon Canada is the governing body within Canada.
- A2. Biathlon Bears is offered across Canada.
- A3. To run training and offer support to the local resorts/clubs.

END OF LESSON CONFIRMATION

QUESTIONS

- Q1. What are the Canadian national marksmanship organizations?
- Q2. What marksmanship organizations are in your province/territory?
- Q3. Which of these organizations is your cadet corps active with?

ANTICIPATED ANSWERS

- A1. The DCRA, SFC and Biathlon Canada.
- A2. Answers will vary by province/territory.
- A3. Answers will depend on cadet corps.

CONCLUSION

HOMEWORK/READING/PRACTICE

N/A.

METHOD OF EVALUATION

N/A.

CLOSING STATEMENT

Identifying opportunities with civilian marksmanship organizations, one will know where they can acquire additional marksmanship training that is not supported by the Cadet Program. The opportunities provided by these organizations could enhance one's sense of accomplishment through improved marksmanship skills and allow them to choose activities in which they would like to participate.

INSTRUCTOR NOTES/REMARKS

Have the cadets identify only the applicable national, provincial and local marksmanship organizations.

REFERENCES

- A0-119 Shooting Federation of Canada. (2007). *Shooting Federation of Canada*. Retrieved November 2, 2007, from www.sfc-ftc.ca/document.cfm?sectionID=39.
- C0-149 Biathlon Canada. (2005). *Biathlon Bears: Community Coaching*. Ottawa, ON: Biathlon Canada.
- C2-086 Dominion of Canada Rifle Association. (2007). *History*. Retrieved October 4, 2007, from www.dkra.ca/history.htm.

THIS PAGE INTENTIONALLY LEFT BLANK



COMMON TRAINING
PHASE THREE
INSTRUCTIONAL GUIDE



SECTION 3

EO C306.02 – CORRECT MARKSMANSHIP ERROR

Total Time:

60 min

PREPARATION

PRE-LESSON INSTRUCTIONS

Resources needed for the delivery of this lesson are listed in the lesson specification located in A-CR-CCP-603/PG-001, Chapter 4. Specific uses for said resources are identified throughout the instructional guide within the TP for which they are required.

Review the lesson content and become familiar with the material prior to delivering the lesson.

Photocopy Annexes K and L for each cadet.

Photocopy the answer key located at Annex M for the instructor and assistant instructors.

Set up a mock firing point.

PRE-LESSON ASSIGNMENT

N/A.

APPROACH

An interactive lecture was chosen for TPs 1–3 to give an overview of the theories and the practice of adjusting sights.

A practical activity was chosen for TP 4 as it is an interactive way to introduce and allow cadets to experience adjusting sights on the cadet air rifle in a controlled environment. This activity contributes to the development of sight adjustment skills and knowledge in a fun and challenging setting.

INTRODUCTION

REVIEW

N/A.

OBJECTIVES

By the end of this lesson the cadet is expected to correct marksmanship error by adjusting elevation and windage on the cadet air rifle.

IMPORTANCE

It is important for the cadets to learn how to correct marksmanship error in order to zero the cadet air rifle when participating in a marksmanship activity. A zeroed rifle will give the marksman the assurance that the centre of the target is properly aligned with themselves and their rifle. Having a zeroed rifle and knowing how to zero a rifle is important to every marksman in order to achieve a higher score in application activities.

Teaching Point 1

Explain Centring the Group

Time: 10 min

Method: Interactive Lecture

THE THEORY OF A GROUP

When a series of three or more shots are fired from the same point of aim, they will seldom pass through the same point on the target. The pattern that is produced from the shot holes in the target is called a group.

Factors Affecting the Group

There are three factors that affect the shape and size of the group:

- **The Ammunition.** Even though every pellet is manufactured to be exactly the same, slight variations in each pellet will result in slight variations in results when firing. The number of pellets used will also affect the group size.
- **The Rifle.** Each rifle will fire a pellet with its own slight variation due to small differences in the barrel and firing mechanisms.
- **The Marksman.** Factors associated with the marksman's aiming, holding, breathing and follow-through techniques will affect each shot.

MEAN POINT OF IMPACT (MPI)



Ensure the handout located at Annex K is passed out to the cadets during this portion of the lesson to allow the cadets to see how the MPI moves as more pellets are shot into the target.

The MPI is the point on the target which is the average centre between all shots on the target. As each shot is fired, the MPI changes as the group develops. To centre the group correctly, corrections should be based on the MPI.

To determine the MPI, each shot must be evaluated. It takes at least two shots for an MPI to be determined. For two shots, the MPI will be the point centred between the two shots. After firing three shots, the MPI will change so that the MPI is centred between all three shots (as illustrated in Figure 6-3-1).

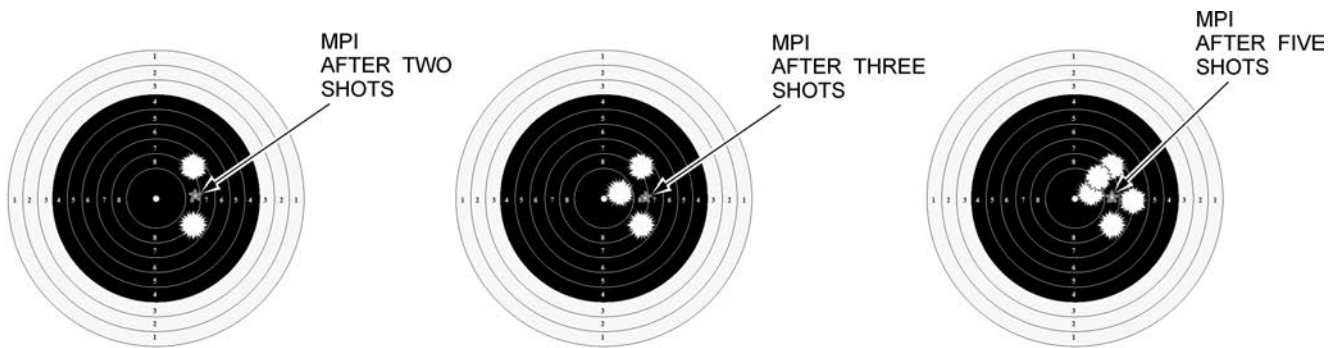

Director Cadets 3, 2007, Ottawa, ON: Department of National Defence

Figure 6-3-1 MPI Examples

CONFIRMATION OF TEACHING POINT 1

QUESTIONS

- Q1. Define the term group.
- Q2. What are the three factors that affect the size and shape of the group?
- Q3. What is the definition of MPI?

ANTICIPATED ANSWERS

- A1. The pattern that is produced from the shot holes in a target.
- A2. The three factors that affect the shape and size of the group:
- the ammunition,
 - the rifle, and
 - the marksman.
- A3. The MPI is the point on the target which is the average centre between all shots on the target.

Teaching Point 2

Explain Sight Adjustment

Time: 10 min

Method: Interactive Lecture

THE PURPOSE OF SIGHT ADJUSTMENT

Sight adjustment is used to ensure that the rifle is zeroed to the marksman. Sight adjustment will not make up for poor marksmanship skills, but may aid the proficient marksman in aligning their grouping to a target. There are two different ways a sight can be adjusted in order to zero the rifle: the windage and the elevation.

ELEVATION

Elevation affects the pellet by moving its vertical position, which moves the point of impact up or down the target. It compensates for the trajectory drop of the pellet.

WINDAGE

Windage affects the pellet by moving its horizontal position, which moves the point of impact left or right. It compensates for the direction and force of the wind on the pellet.

A ZEROED CADET AIR RIFLE

A zeroed cadet air rifle is accurate for a particular marksman at a particular position and distance from the target. A zeroed cadet air rifle has a particular sight setting that will be perfectly aimed, by putting pellets directly into the centre of the target.

CONFIRMATION OF TEACHING POINT 2

QUESTIONS

- Q1. What is the purpose of adjusting the sights on a rifle?
- Q2. What does the elevation adjustment refer to?
- Q3. What does the windage adjustment refer to?

ANTICIPATED ANSWERS

- A1. Sight adjustment is used to ensure the rifle is zeroed to the marksman.
- A2. Elevation adjustment refers to the adjustment required to compensate for the trajectory drop of the pellet.
- A3. Windage adjustment refers to the adjustment required to compensate for the direction and force of the wind on the pellet.

Teaching Point 3

Explain the Increments of Sight Adjustment

Time: 5 min

Method: Interactive Lecture



Ensure the cadets have a cadet air rifle in front of them during this portion of the lesson in order to see the actual sight of the cadet air rifle and the means in which it functions.

SIGHT ADJUSTMENT OF THE CADET AIR RIFLE

Sight adjustment of the cadet air rifle is achieved by turning the knobs of the rear sight. The elevation adjustment knob is found on the top of the rear sight and the windage elevation knob is found on the right-hand side of the rear sight. They are used to move the MPI of the shot either left or right and up or down. The adjustment of these knobs is measured in clicks that can be felt as the knob is turned. It takes three clicks to move the point of impact approximately one pellet width in any direction.

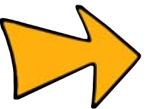

At a distance of 10 m, each click equals approximately a 1.219 mm shift of the MPI.

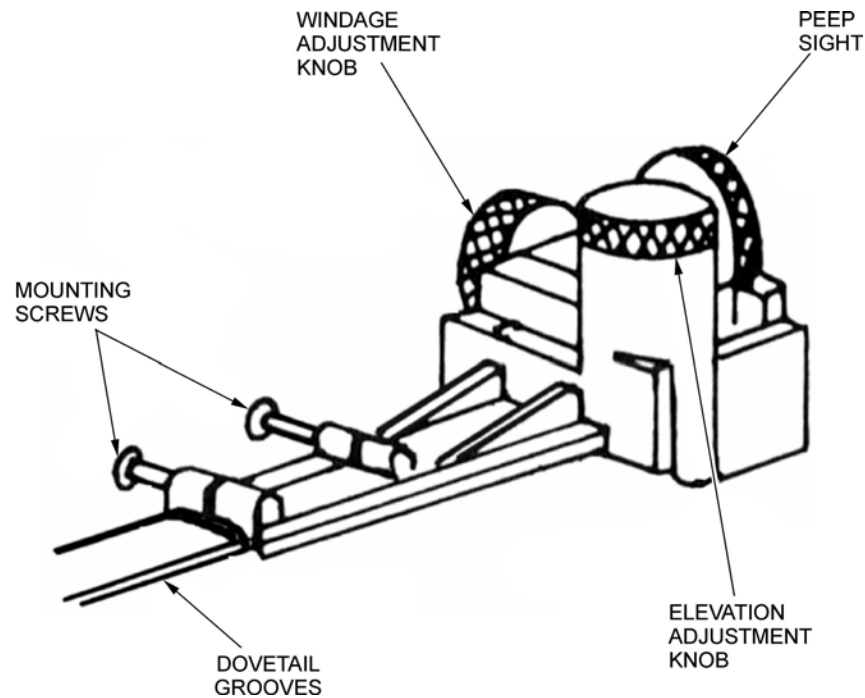

Daisy Outdoor Products, AVANTI Competition Pellet Rifle: Operation Manual: AVANTI Legend Model 853, Daisy Outdoor Products (p. 6)

Figure 6-3-2 Rear Sight of the Cadet Air Rifle

LOWERING AND RAISING THE ELEVATION

To lower the elevation of the MPI, turn the elevation knob counter-clockwise (to the left). To raise the elevation of the MPI, turn the elevation knob clockwise (to the right), as per the arrow and the word "UP" located on the knob.

MOVING THE WINDAGE LEFT AND RIGHT

To move the MPI left, turn the windage knob counter-clockwise (to the left). To move the MPI to the right, turn the windage knob clockwise (to the right), as per the arrow and the letter "R" located on the knob.



In order to move the MPI up and to the right turn the elevation and windage knobs clockwise.

In order to move the MPI down and left turn the elevation and windage knobs counter-clockwise.

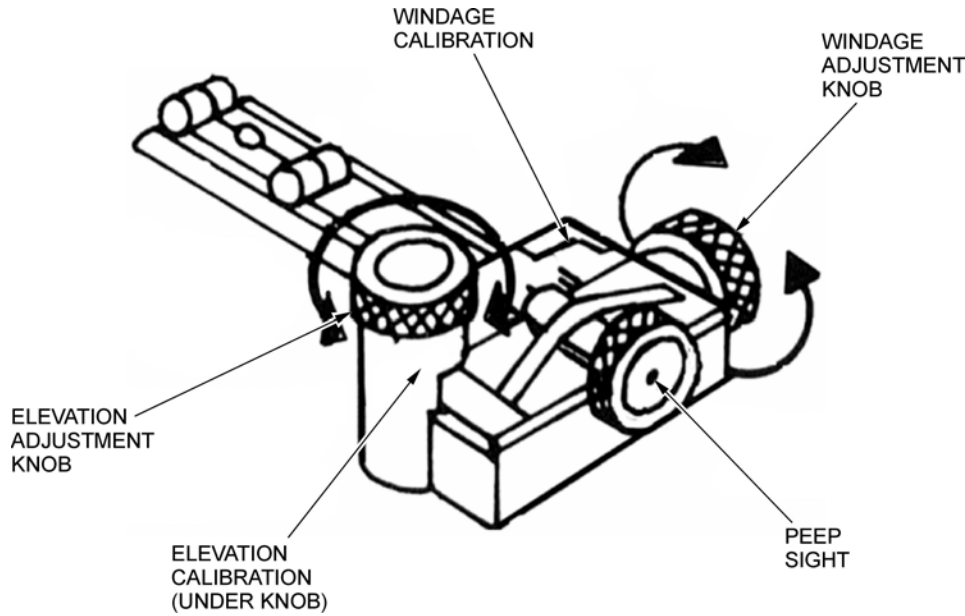

Daisy Outdoor Products, AVANTI Competition Pellet Rifle: Operation Manual: AVANTI Legend Model 853, Daisy Outdoor Products (p. 6)

Figure 6-3-3 Sight Adjustment of the Cadet Air Rifle

CONFIRMATION OF TEACHING POINT 3

QUESTIONS

- Q1. How many clicks on the adjustment knob will move the MPI on the target one pellet width in any direction?
- Q2. What direction does the marksman turn the elevation adjustment knob in order to raise the MPI?
- Q3. What direction does the marksman turn the windage adjustment knob in order to move the MPI to the left?

ANTICIPATED ANSWERS

- A1. In order to move the MPI on the target one pellet width, three clicks are required.
- A2. The marksman turns the elevation adjustment knob clockwise (to the right) in order to raise the MPI.
- A3. The marksman turns the windage adjustment knob counter-clockwise (to the left) in order to move the MPI to the left.

Teaching Point 4

Conduct a Sight Adjustment Exercise

Time: 30 min

Method: Practical Activity



Each pair of cadets will complete the exercise located at Annex L and then practice adjusting their sights.

An assistant instructor may be used to aid the cadets in the completion of this activity.

ACTIVITY

OBJECTIVE

The objective of this activity is to confirm that each cadet can determine the MPI and adjust sights accordingly on the cadet air rifle.

RESOURCES

- Cadet air rifle (one per firing lane),
- Sight adjustment activity targets located at Annex L, and
- Pen/pencil.

ACTIVITY LAYOUT

A mock firing point.

ACTIVITY INSTRUCTIONS

1. Divide the cadets into pairs.
2. Distribute the exercise located at Annex L to each cadet.
3. Have the cadets, in pairs, determine the MPI of all five shots for each scoring diagram.
4. Have the cadets put an asterisk to indicate the MPI.
5. Have the cadets determine the vertical and horizontal distance, in clicks, that the MPI must move to be aimed at the centre of the target.
6. Have the cadets write the number of clicks required for the windage and elevation, marking whether to turn the knob clockwise (cw) or counter-clockwise (ccw).
7. Have the cadets practice adjusting the sights on the cadet air rifle for each scoring diagram.
8. Correct using the answer key located at Annex M.

SAFETY

Ensure the following:

- the cadet air rifles are safe by performing individual safety precautions IAW A-CR-CCP-177/PT-001;
- all cadet air rifles are pointed in a safe direction throughout the lesson;
- no pellets or cleaning pellets are present in the training area; and
- all other applicable safety regulations are followed IAW local range standing orders.

CONFIRMATION OF TEACHING POINT 4

The cadets' participation in the activity will serve as the confirmation of this TP.

END OF LESSON CONFIRMATION

The cadets' participation in the sight adjustment exercise will serve as the confirmation of this lesson.

CONCLUSION

HOMEWORK/READING/PRACTICE

N/A.

METHOD OF EVALUATION

N/A.

CLOSING STATEMENT

Correcting marksmanship error is necessary to achieve success in marksmanship activities. It ensures that the marksman, the rifle and the target are aligned and that the centre of aim is in the centre of the target. It is important for each marksman to understand how to adjust their sights in order to achieve a completely aligned rifle.

INSTRUCTOR NOTES/REMARKS

N/A.

REFERENCES

- A0-027 A-CR-CCP-177/PT-001 Director Cadets 3. (2001). *Canadian Cadet Movement: Cadet Marksmanship Program Reference Manual*. Ottawa, ON: Department of National Defence.
- C2-097 Ontario Rifle Association. (2003). *Ontario Rifle Association Handbook for New Member*. Haliburton County, ON: MilCun Marksmanship Complex.
- C2-098 (ISBN 1-931220-05-0) Constantine, R. (1998). *Modern Highpower Competition: From Beginner to Master*. Manchester, CT: Precision Shooting Inc.



COMMON TRAINING
PHASE THREE
INSTRUCTIONAL GUIDE



SECTION 4

EO C306.03 – ADOPT THE STANDING POSITION WITH THE CADET AIR RIFLE

Total Time:

60 min

PREPARATION

PRE-LESSON INSTRUCTIONS

Resources needed for the delivery of this lesson are listed in the lesson specification located in A-CR-CCP-603/PG-001, Chapter 4. Specific uses for said resources are identified throughout the instructional guide within the TP for which they are required.

Review the lesson content and become familiar with the material prior to delivering the lesson.

PRE-LESSON ASSIGNMENT

N/A.

APPROACH

An interactive lecture was chosen for TP 1 to give an overview of the objectives of the standing position.

Demonstration was chosen for TPs 2–4 as it allows the instructor to explain and demonstrate aspects of the standing position.

A practical activity was chosen for TP 5 as it is an interactive way to allow the cadet to experience the standing position in a safe and controlled environment. This activity contributes to the development of marksmanship skills and knowledge in a fun and challenging setting.

INTRODUCTION

REVIEW

N/A.

OBJECTIVES

By the end of this lesson the cadet shall be expected to adopt the standing position with the cadet air rifle.

IMPORTANCE

It is important for cadets to adopt the standing position with the cadet air rifle as this position is used in both biathlon and civilian air rifle competitions. As the standing position is the only position for the international air rifle competitions, it is seen as a progression for cadet recreational marksmanship.

Teaching Point 1**Explain the Objectives of the Standing Position**

Time: 5. min

Method: Interactive Lecture



Explain to the cadets that the standing position is more technical, physically demanding and harder to master than the prone position. The information presented in this TP is required to understand the demonstrations prior to practicing the standing position.

The first principle of marksmanship is to find a comfortable firing position. The standing position is the easiest and quickest position to assume and does not require any artificial support, like the use of the sling in the prone position. It is the most difficult position in which to remain steady as it has the smallest area of support and it has a high centre of gravity. Cadets must accept that when firing in the standing position, they may never achieve complete immobility.

OBTAINING A GOOD POSITION

Obtaining a good position is the most important principle of marksmanship; this is especially true when firing in the standing position. A good position helps to maintain balance, comfort and stability during firing. Cadets should wear comfortable flat sole shoes or boots to add stability to the position and stand on the firmest surface possible. Although an excellent position will not guarantee an excellent performance, a poor position can almost assure a substantially negative effect on one's score.

The objective of a good position is to obtain a stable, balanced, uniform platform in the most efficient way possible, allowing holding and aiming to be achieved with as little movement and muscular tension as possible.

The standing position should be:

- natural,
- without strain,
- comfortable,
- stable,
- balanced in such a way that body weight is equally distributed between both feet, and
- consistent throughout the relay.

USING A RIFLE REST

An excellent way for a cadet to learn the standing position is to practice with the use of a rifle rest. Since the movements of the cadet air rifle are amplified from the lack of support points with the standing position, a rifle rest is very helpful. A rest allows the cadet air rifle to remain steady while allowing the cadet to understand and perfect the marksmanship skills being practiced. Once these skills are learned, the rifle rest should be removed. Some examples of rifle rests for the standing position are a tripod stand, a stool on top of a table or simply a flat surface on the end of a broom stick.

MAINTAINING A CENTRE OF GRAVITY



The instructions given are based on a right-handed marksman. For a left-handed marksman, substitute the left for right and right for left throughout the points.

The centre of gravity is the point where the weight of the rifle and the cadet's body weight are evenly distributed between the feet. In order to compensate for the weight of the rifle, the cadet's back is bent rearward and rotated to the left in order to gain bone support and stability.

If the cadet stands straight, the weight of the cadet air rifle will pull their body to the front. Muscle strain will be felt in the back as the cadet attempts to keep their body from falling forward. By bending backward and rotating the back to the left, a shift in body weight will occur slightly towards the right foot. At a certain point, the weight of the body on the right foot will equal the weight on the left foot. The body-rifle combination then reaches a state of balance, with the centre of gravity located between the cadet's two feet.

CONFIRMATION OF TEACHING POINT 1

QUESTIONS

- Q1. What is the first principle of marksmanship?
- Q2. What is an excellent way for a cadet to learn the standing position?
- Q3. What is the centre of gravity in relation to the standing position?

ANTICIPATED ANSWERS

- A1. Obtaining a good position.
- A2. With the use of a rifle rest.
- A3. The centre of gravity is the point where the weight of the rifle and the cadet's body weight are evenly distributed between the feet.

Teaching Point 2

Explain and Demonstrate Adopting the Standing Position

Time: 5 min

Method: Demonstration



For this TP, it is recommended that instruction take the following format:

1. Explain and demonstrate the complete skill while cadets observe.
2. Explain and demonstrate each step required to complete the skill.

Note: Assistant instructors may be employed to demonstrate the skill as it is explained.



No two bodies are exactly the same, not even twins; therefore, no two bodies will look alike in any shooting position. Building the best position for your performance, means your standing position will differ from the person standing beside you.

ADOPTING THE STANDING POSITION

The following guidelines should be adhered to when adopting the standing position:

1. the body should face to the right, approximately 90 degrees to the target;
2. the feet should be:
 - (a) positioned shoulder width apart,
 - (b) pointed straight ahead in relation to the body, or
 - (c) turned slightly outward for comfort;



The weight of the body and the rifle should be equally distributed between both feet.

3. the legs should be straight with knees unlocked, as locked knees affect circulation, causing increased discomfort and unsteadiness;
4. the hips should be 90 degrees to the target and should not thrust forward;

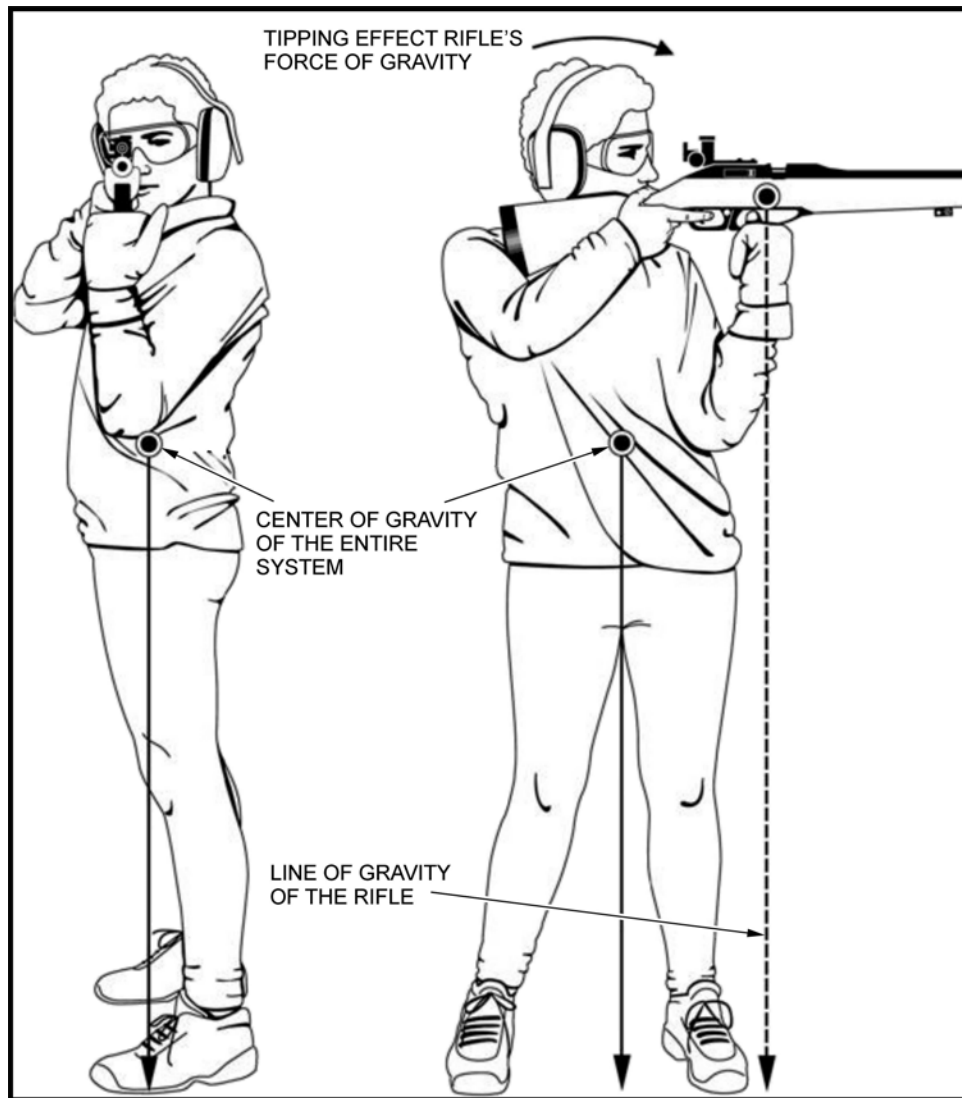

A-CR-CCP-177/PT-001 (p. 2-9)

Figure 6-4-1 Standing Position

5. the back should be bent rearward to gain bone support and stability;
6. the left arm, without muscles used for support, should rest against the ribcage with the elbow almost directly under the rifle, resting against the ribcage or hipbone;
7. the left hand is used to support the rifle and should be positioned on the pump handle, using one of the following methods:
 - (a) forming a clenched fist;

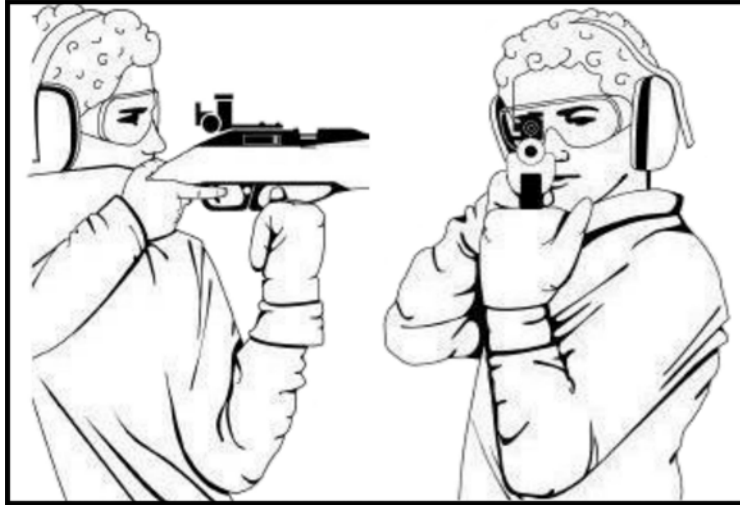

A-CR-CCP-177/PT-001 (p. 1-6-3)

Figure 6-4-2 Clenched Fist

(b) forming a V shape with the thumb and fingers; or

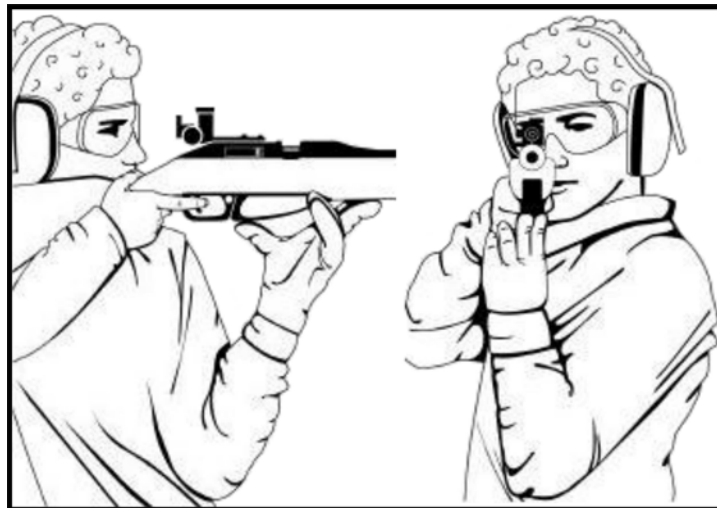

A-CR-CCP-177/PT-001 (p. 1-6-3)

Figure 6-4-3 V Shape With the Thumb and Fingers

- (c) using the heel of the hand with relaxed fingers;



A-CR-CCP-177/PT-001 (p. 1-6-4)

Figure 6-4-4 Heel of the Hand

8. the right arm should drop naturally to the side with the right hand placed comfortably, but firmly on the small of the butt;
9. the head should remain in an upright and natural position to allow the eyes to look forward through the sights; and

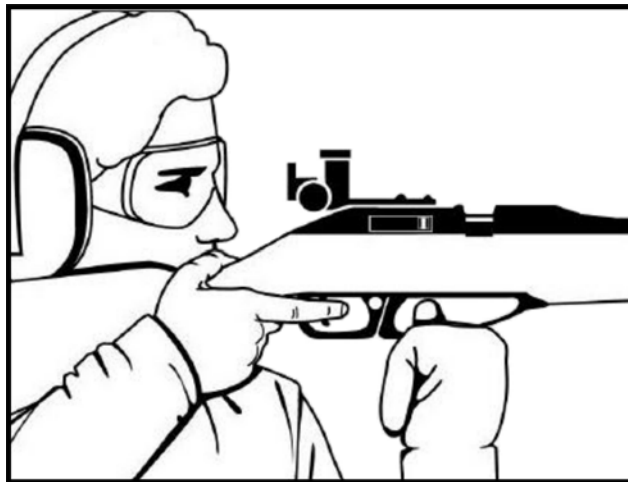

A-CR-CCP-177/PT-001 (p. 1-6-4)

Figure 6-4-5 Head and Eyes

10. the butt should rest slightly high on the shoulder, allowing the cadet air rifle to rest naturally across the chest with the cheek resting on the stock and the sights at eye level.



The standing position allows for a more natural and relaxed position that is more comfortable than prone, as it places less pressure and weight on the spine.

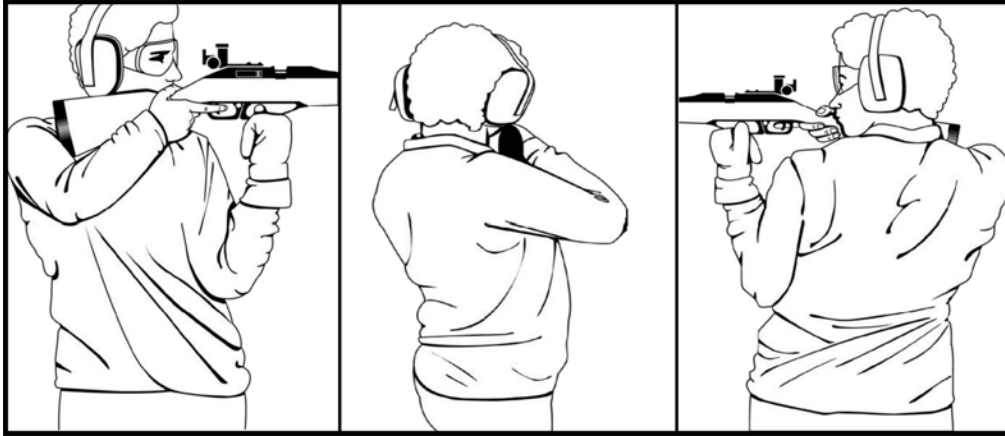

A-CR-CCP-177/PT-001 (p. 2-9)

Figure 6-4-6 Back and Hip Position

CONFIRMATION OF TEACHING POINT 2

QUESTIONS

- Q1. Why is the back bent rearward?
- Q2. Why should the head remain in an upright and natural position?
- Q3. Where should the butt of the cadet air rifle rest?

ANTICIPATED ANSWERS

- A1. The back is bent rearward to gain bone support and stability.
- A2. The head should remain in an upright and natural position to allow the eyes to look forward through the sights.
- A3. The butt resting slightly high on the shoulder, allowing the cadet air rifle to rest naturally across the chest with the cheek resting on the stock and the sights at eye level.

Teaching Point 3**Explain and Demonstrate Adjusting the Aim**

Time: 5 min

Method: Demonstration



When firing in the standing position, the larger of the two front apertures should be selected to provide the best sight picture. The aperture size should appear 1-1/2 times bigger than the aiming mark to allow the cadet to see the aiming mark that will be shifting around more than in the prone position.

When aiming the cadet air rifle in the standing position, the aiming process is the same as it is for the prone position. It is achieved by adopting a comfortable position, ensuring body alignment with the target, sight alignment and obtaining a sight picture. The only thing that varies from the prone position is that the front aperture should be larger and eye relief may be longer, but still between 5–15 cm (2–6 inches).



For this TP, it is recommended that instruction take the following format:

1. Explain and demonstrate the complete skill while cadets observe.
2. Explain and demonstrate each step required to complete the skill.

Note: Assistant instructors may be employed to demonstrate the skill as it is explained.

HIGHER

To adjust the aim higher in the standing position, move the left hand rearward, closer to the trigger guard.

LOWER

To adjust the aim lower in the standing position, move the left hand forward, away from the trigger guard.



When smaller adjustments higher or lower are required, they can be achieved by adjusting when to hold a breath during the breathing cycle.

LEFT AND RIGHT

To adjust the aim to the left or right, adjustments are made by moving both feet in such a way as to keep them in the same position in relation to each other. The result should be as if the position was rotated in a disc, turned to the left or right as required.



When smaller adjustments left or right are required, they can be achieved by adjusting the position of the left hand and forearm. Adjusting the aim by this method may result in having to acquire a new firing position.

CONFIRMATION OF TEACHING POINT 3

QUESTIONS

- Q1. How does aiming in the standing position vary from the prone position?
- Q2. How is aiming adjusted higher or lower in the standing position?
- Q3. How is aiming adjusted to the left or right in the standing position?

ANTICIPATED ANSWERS

- A1. The front aperture should be larger and eye relief may be longer, but still between 5–15 cm (2–6 inches).
- A2. By moving the left hand rearward or forward of the trigger guard.
- A3. By moving both feet in such a way as to keep them in the same position in relation to each other, as if on a rotating disc.

Teaching Point 4**Explain and Demonstrate Natural Alignment**

Time: 5 min

Method: Demonstration



Natural alignment is the same procedure for the standing position as it is for the prone position.

Natural alignment describes the direction that the cadet air rifle is aimed when the marksman is in a comfortable standing position with the cadet air rifle at the ready. In a comfortable position, the cadet air rifle should not be forced to point at the target. Even with a comfortable standing position and sight alignment, forcing the cadet air rifle can cause muscle tension and will affect the accuracy of each shot.



For this TP, it is recommended that instruction take the following format:

1. Explain and demonstrate the complete skill while cadets observe.
2. Explain and demonstrate each step required to complete the skill.

Note: Assistant instructors may be employed to demonstrate the skill as it is explained.

Natural alignment is obtained by:

1. adopting the standing position;
2. acquiring a sight picture;
3. closing both eyes;
4. taking 3–4 normal breaths to relax the muscles;
5. after 10 seconds, opening the eyes to inspect the sight picture; and
6. adjusting body position to acquire a sight picture.



The purpose of closing the eyes and relaxing is to allow the muscles to return to a natural position. This allows the position to be adjusted and avoids having to force the cadet air rifle to aim at the target.

CONFIRMATION OF TEACHING POINT 4**QUESTIONS**

- Q1. Natural alignment has a marksman in what type of position?
- Q2. How long are the eyes closed, and how many breaths are taken to obtain natural alignment?
- Q3. What negative effect can forcing the cadet air rifle have?

ANTICIPATED ANSWERS

- A1. In a comfortable standing position with the cadet air rifle at the ready.

A2. The eyes are closed for 10 seconds and 3–4 natural breaths are taken.

A3. It can cause muscle tension and will affect the accuracy of each shot.

Teaching Point 5**Have the Cadets Adopt the Standing Position**

Time: 30 min

Method: Practical Activity

ACTIVITY

OBJECTIVE

The objective of this activity is to have cadets adopt the standing position, position the cadet air rifle into the shoulder, obtain natural alignment and adjust their position as required.

RESOURCES

- Cadet air rifle (one per firing lane),
- Rifle rest (one per firing lane),
- Target frame (one per firing lane),
- Suitable target (one per firing lane),
- Raised target platform (one per firing lane),
- Safety glasses/goggles.

ACTIVITY LAYOUT

Construct an air rifle range IAW A-CR-CCP-177/PT-001, Part 1, Section 8.

ACTIVITY INSTRUCTIONS

1. Divide cadets into equal relays according to the number of firing lanes.
2. Have the relays take turns assuming the standing position using the cadet air rifle.
3. With assistance, allow the cadets to practice the standing position as taught.
4. Have cadets adjust their standing position, to include:
 - (a) the body should face 90 degrees to the target;
 - (b) the feet should be:
 - (1) positioned shoulder width apart,
 - (2) pointed straight ahead in relation to the body, or
 - (3) turned slightly outward for comfort,
 - (c) the legs should be straight with knees unlocked;
 - (d) the hips should be 90 degrees to the target and not thrust forward;
 - (e) the back should be bent rearward;

- (f) the left arm should rest against the ribcage with the elbow under the rifle, resting against the ribcage or hipbone;
- (g) the left hand supporting the rifle, should be positioned on the pump handle;
- (h) the right arm should drop naturally to the side with the right hand placed on the small of the butt;
- (i) the head should remain upright and in a natural position to allow the eyes to look through the sights; and
- (j) the butt should rest slightly high on the shoulder, allowing the cadet air rifle to rest naturally across the chest with the cheek resting on the stock and the sights at eye level.

5. Inspect each cadet for a comfortable position.

6. Repeat steps as required, within the allotted time.

SAFETY

Ensure that the cadet air rifles are pointed in a safe direction at all times. Cadets will treat air rifles as though they are loaded.

CONFIRMATION OF TEACHING POINT 5

The cadets' participation in the standing position activity will serve as the confirmation of this TP.

END OF LESSON CONFIRMATION

The cadets' participation in the activity in TP 5 will serve as the confirmation of this lesson.

CONCLUSION

HOMEWORK/READING/PRACTICE

N/A.

METHOD OF EVALUATION

N/A.

CLOSING STATEMENT

The standing position is the least stable position due to its high centre of gravity and small support area. It requires a great amount of concentration and practice. The standing position is seen as a progression for cadet recreational marksmanship and is the only position for the international air rifle competitions.

INSTRUCTOR NOTES/REMARKS

Cadets who have completed this lesson will participate in EO M306.01 (Participate in a Recreational Marksmanship Activity, Section 1) from the standing position.

REFERENCES

A0-027 A-CR-CCP-177/PT-001 Director Cadets 3. (2001). *Canadian Cadet Movement: Cadet Marksmanship Program Reference Manual*. Ottawa, ON: Department of National Defence.

C2-146 (ISBN 0-9655780-0-3) Pullum, B. & Hanenkrat, F. (1997). *The New Position Rifle Shooting: A Comprehensive Guide to Better Target Shooting*. Oak Harbor, OH: Target Sports Education Center.

THIS PAGE INTENTIONALLY LEFT BLANK

CLASSIFICATION ACTIVITY

CLASSIFICATION ACTIVITY
Objective: To provide cadets the opportunity to obtain marksmanship classifications.
Scoring: The standard for the classification levels that are: <ol style="list-style-type: none">1. Marksman: Two five-round groupings within a circle of 3 cm in diameter.2. First Class Marksman: Two five-round groupings within a circle of 2.5 cm in diameter.3. Expert Marksman: Two five-round groupings within a circle of 2 cm in diameter.4. Distinguished Marksman: Two five-round groupings within a circle of 1.5 cm in diameter.
Equipment Required: <p>Mandatory:</p> <ul style="list-style-type: none">• CCT200GRTD Canadian Cadet Movement (CCM) Air Rifle Grouping Target (one per cadet),• Air Rifle Grouping Template from A-CR-CCP-177/PT-001 (p. B1-1), and• A stopwatch. <p>Optional aids to firing are limited to the following:</p> <ul style="list-style-type: none">• Cadet air rifle sling,• Marksmanship jacket,• Shooting glove, and• Hat.
Activity Instructions: <ol style="list-style-type: none">1. Distribute an Air Rifle Grouping Target to each cadet.2. Have the cadets write their name and date on the target and attach it to the target frame.3. Give the cadets five pellets to fire into the centre of the target.4. Have the cadets fire in relays following the commands given by the RSO.5. Give the cadets 15 minutes to complete firing.6. Have the cadets retrieve their targets.7. Score the targets using the Air Rifle Grouping Template.8. Record the scores and allow the cadets to keep their targets. <p>The following is prohibited:</p> <ul style="list-style-type: none">• Alterations made to the rifles.• A pellet-loading clip.• Supports used as a rest for the rifle or the forearm.• A spotting scope.• Use of sights not provided with the cadet air rifle.• Coaching.

THIS PAGE INTENTIONALLY LEFT BLANK

FUN ACTIVITY – PYRAMID

PYRAMID
Objective: To fire pellets into each point on the pyramid.
Scoring: One point is awarded for each point on the pyramid that is hit by a pellet.
Equipment Required: Mandatory: Pyramid Target (one per cadet). Optional aids to firing are limited to the following: <ul style="list-style-type: none">• Cadet air rifle sling,• Marksmanship jacket,• Shooting glove, and• Hat.
Activity Instructions: <ol style="list-style-type: none">1. Distribute one Pyramid Target to each cadet.2. Have the cadets write their name and date on the target and attach it to the target frame.3. Give the cadets three pellets to fire, one pellet into each corner of the pyramid.4. Have the cadets fire in relays following the commands given by the RSO.5. Give the cadets three minutes to complete firing.6. Score the targets awarding one point for each corner hit on the pyramid.7. Allow the cadets to review and keep their targets. The following actions are prohibited: <ul style="list-style-type: none">• Alterations made to the rifles.• A pellet-loading clip.• Supports used as a rest for the rifle or the forearm.• A spotting scope.• Use of sights not provided with the cadet air rifle.

PYRAMID TARGET

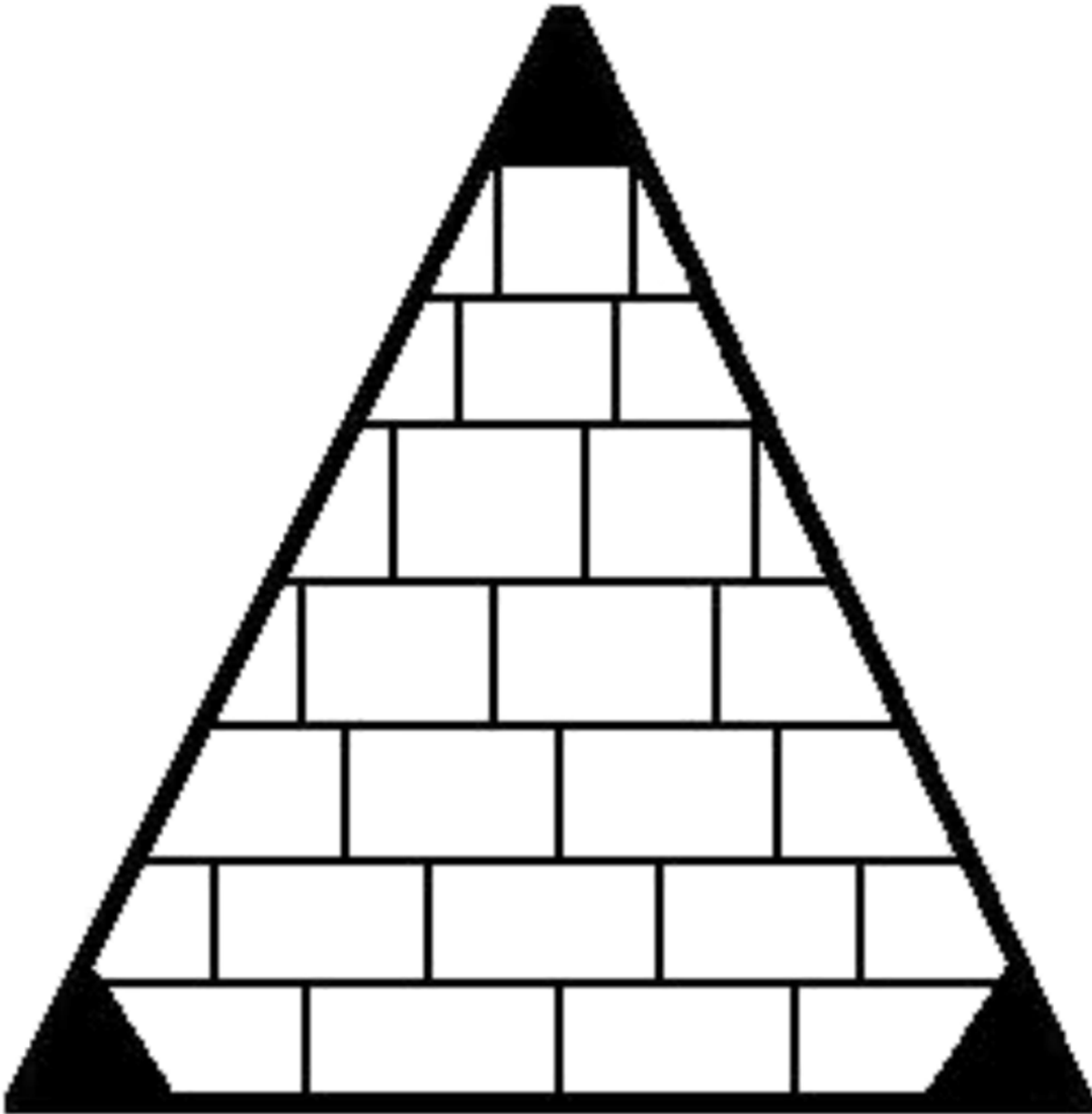

Name: _____ Date: _____

Director Cadets 3, 2007, Ottawa, ON: Department of National Defence

Figure 6B-1 Pyramid Target

FUN ACTIVITY – SHOOTING STAR

SHOOTING STAR
Objective: To fire a pellet into each point on the star.
Scoring: One point is awarded for each point on the star that is hit by a pellet.
Equipment Required: Mandatory: Star Target (one per cadet). Optional aids to firing are limited to the following: <ul style="list-style-type: none">• Cadet air rifle sling,• Marksmanship jacket,• Shooting glove, and• Hat.
Activity Instructions: <ol style="list-style-type: none">1. Distribute one Star Target to each cadet.2. Have the cadets write their name and date on the target and attach it to the target frame.3. Give the cadets five pellets to fire, one pellet into each point on the star.4. Have the cadets fire in relays following the commands given by the RSO.5. Give the cadets five minutes to complete firing.6. Score the targets awarding one point for a pellet hit within each point on the star.7. Allow the cadets to review and keep their targets. The following is prohibited: <ul style="list-style-type: none">• Alterations made to the rifles.• A pellet-loading clip.• Supports used as a rest for the rifle or the forearm.• A spotting scope.• Use of sights not provided with the cadet air rifle.

STAR TARGET

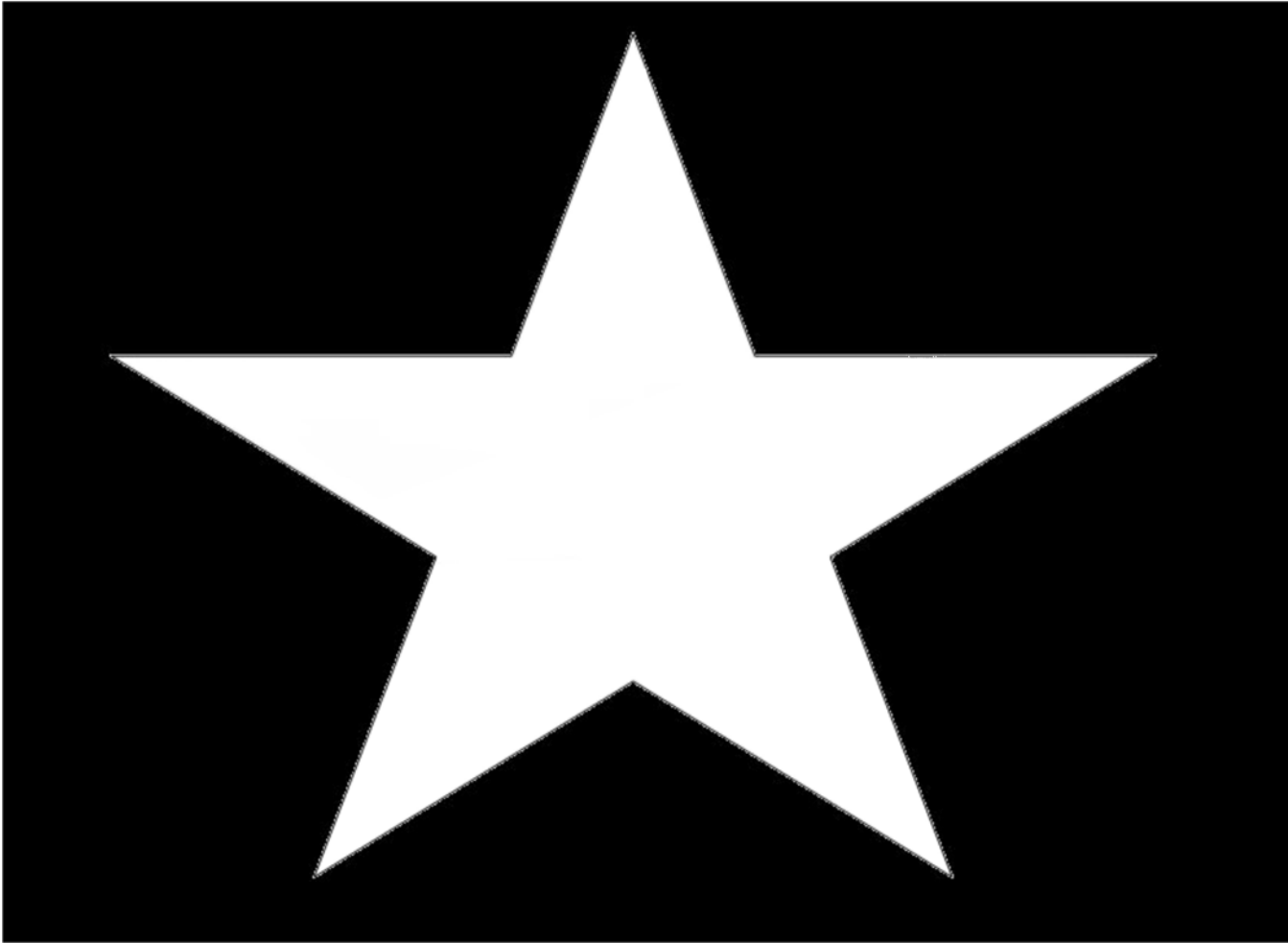

Name: _____ Date: _____

Director Cadets 3, 2007, Ottawa, ON: Department of National Defence

Figure 6C-1 Star Target

FUN ACTIVITY – BEACH BALL

BEACH BALL
Objective: To fire 10 pellets into the black circle on the beach ball.
Scoring: One point is awarded for each successful hit in the black circle.
Equipment Required: Mandatory: Beach Ball Target (one per cadet). Optional aids to firing are limited to the following: <ul style="list-style-type: none">• Cadet air rifle sling,• Marksmanship jacket,• Shooting glove, and• Hat.
Activity Instructions: <ol style="list-style-type: none">1. Distribute one Beach Ball Target to each cadet.2. Have the cadets write their name and date on the target and attach it to the target frame.3. Give the cadets 10 pellets to fire into the black circle of the beach ball.4. Have the cadets fire in relays following the commands given by the RSO.5. Give the cadets 10 minutes to complete firing.6. Score the targets awarding one point for each pellet hit within the black circle.7. Allow the cadets to review and keep their targets. The following is prohibited: <ul style="list-style-type: none">• Alterations made to the rifles.• A pellet-loading clip.• Supports used as a rest for the rifle or the forearm.• A spotting scope.• Use of sights not provided with the cadet air rifle.

BEACH BALL TARGET



Name: _____ Date: _____

Director Cadets 3, 2006, Ottawa, ON: Department of National Defence

Figure 6D-1 Beach Ball Target

FUN ACTIVITY – BALLOONS

BALLOONS
Objective: To fire pellets into balloons on the target.
Scoring: One point is awarded for each balloon hit by a pellet.
Equipment Required: Mandatory: Balloon Target (one per cadet). Optional aids to firing are limited to the following: <ul style="list-style-type: none">• Cadet air rifle sling,• Marksmanship jacket,• Shooting glove, and• Hat.
Activity Instructions: <ol style="list-style-type: none">1. Distribute one Balloon Target to each cadet.2. Have the cadets write their name and date on the target and attach it to the target frame.3. Give the cadets five pellets to fire, one pellet into each balloon.4. Have the cadets fire in relays following the commands given by the RSO.5. Give the cadets five minutes to complete firing.6. Score the targets awarding one point for each balloon hit.7. Allow the cadets to review and keep their targets. The following is prohibited: <ul style="list-style-type: none">• Alterations made to the rifles.• A pellet-loading clip.• Supports used as a rest for the rifle or the forearm.• A spotting scope.• Use of sights not provided with the cadet air rifle.
Note: Actual balloons may be used in place of the paper targets.

BALLOON TARGET

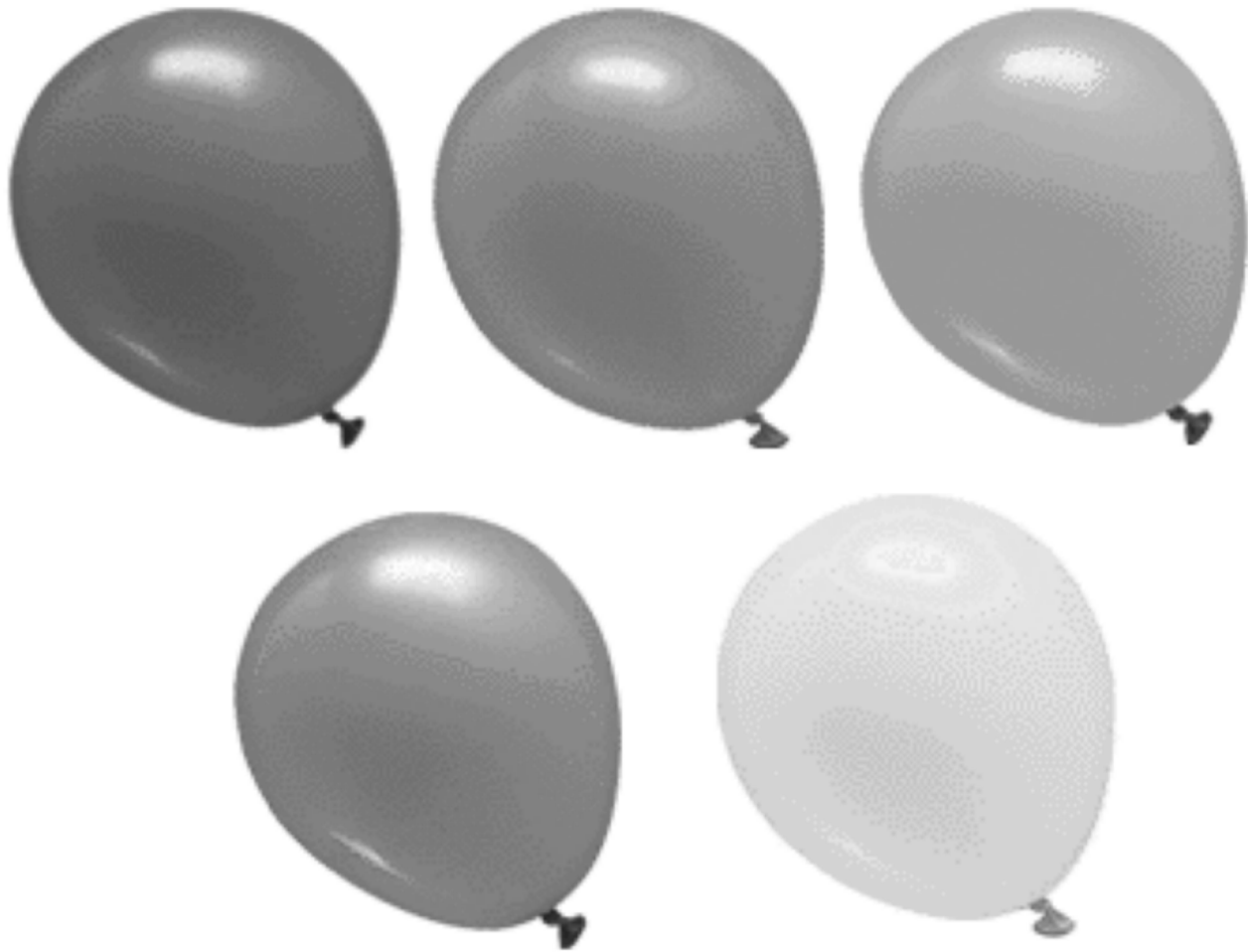

Name: _____ Date: _____

Director Cadets 3, 2007, Ottawa, ON: Department of National Defence

Figure 6E-1 Balloon Target

TIMED ACTIVITY – CHASE THE DOTS

CHASE THE DOTS
Objective: To fire pellets into the dots on the target in a clockwise direction, within a time limit.
Scoring: One point is awarded for each black dot that is hit by a pellet within the time allotted.
Equipment Required: Mandatory: <ul style="list-style-type: none">• Chase the Dots Target (one per cadet), and• A stopwatch. Optional aids to firing are limited to the following: <ul style="list-style-type: none">• Cadet air rifle sling,• Marksmanship jacket,• Shooting glove, and• Hat.
Activity Instructions: <ol style="list-style-type: none">1. Distribute one Chase the Dots Target to each cadet.2. Have the cadets write their name and date on the target and attach it to the target frame.3. Give the cadets eight pellets to fire, one pellet into each black dot, in a clockwise direction.4. Have the cadets fire in relays following the commands given by the RSO.5. Give the cadets eight minutes to complete firing.6. Score the targets awarding one point for each black dot hit.7. Allow the cadets to review and keep their targets. The following is prohibited: <ul style="list-style-type: none">• Alterations made to the rifles.• A pellet-loading clip.• Supports used as a rest for the rifle or the forearm.• A spotting scope.• Use of sights not provided with the cadet air rifle.• Coaching.
Note: To make this activity more difficult, shorten the time allowance.

CHASE THE DOTS TARGET

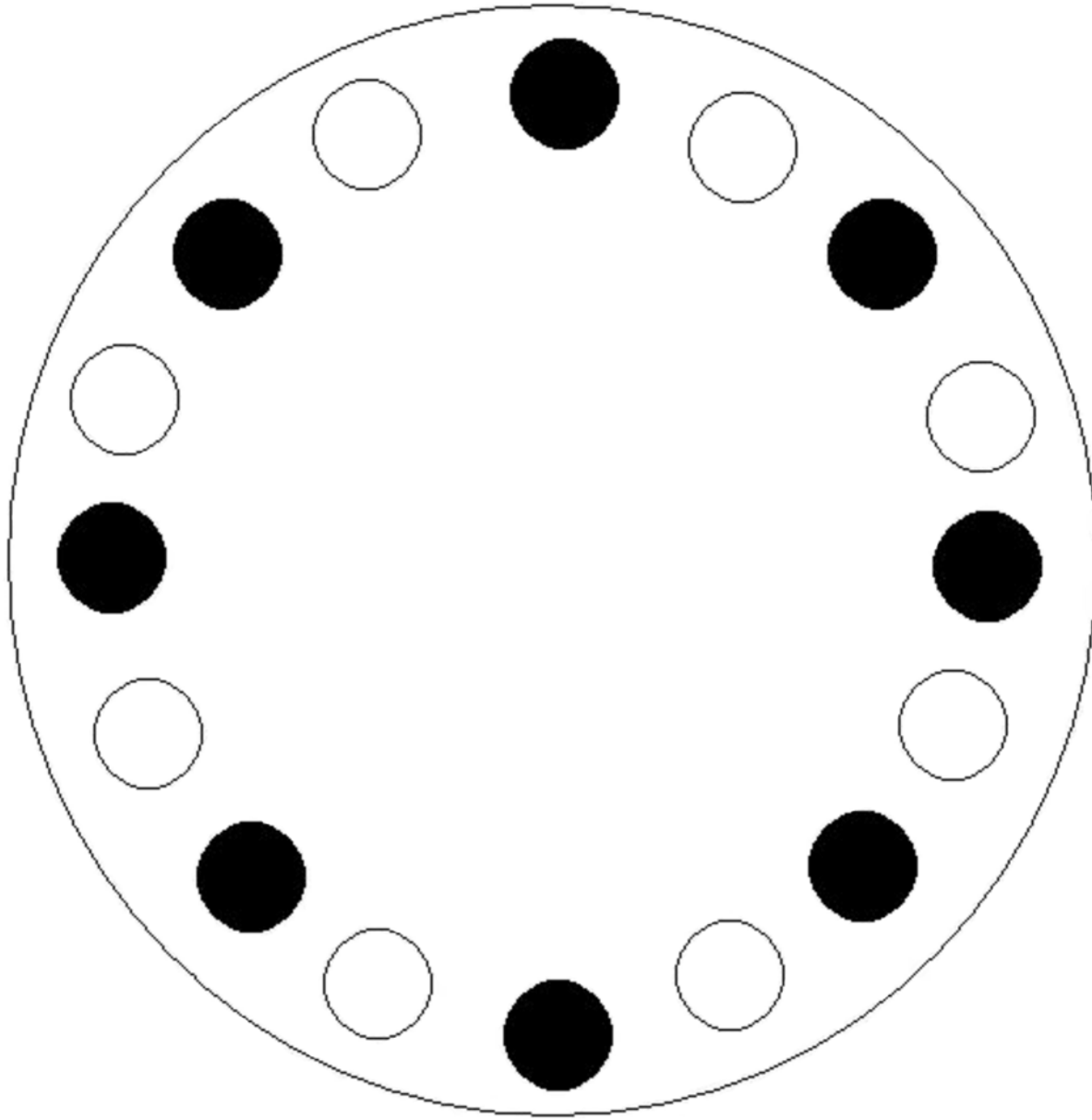

Name: _____ Date: _____

Director Cadets 3, 2007, Ottawa, ON: Department of National Defence

Figure 6F-1 Chase the Dots Target

TIMED ACTIVITY – SPEED GRID

SPEED GRID
Objective: To fire pellets into the circles on the target, within a time limit.
Scoring: One point is awarded for each circle that is hit by a pellet within the time allotted.
Equipment Required: Mandatory: <ul style="list-style-type: none">• Cadet air rifle five-pellet clip (three per firing lane),• Speed Grid Target (one per cadet), and• A stopwatch. Optional aids to firing are limited to the following: <ul style="list-style-type: none">• Cadet air rifle sling,• Marksmanship jacket,• Shooting glove, and• Hat.
Activity Instructions: <ol style="list-style-type: none">1. Distribute one Speed Grid Target to each cadet.2. Have the cadets write their name and date on the target and attach it to the target frame.3. Give the cadets 15 pellets, pre-loaded into three five pellet clips.4. Have the cadets fire one pellet into each circle on the target.5. Have the cadets fire in relays following the commands given by the RSO.6. Give the cadets 15 minutes to complete firing.7. Score the targets awarding one point for each circle hit.8. Allow the cadets to review and keep their targets. The following is prohibited: <ul style="list-style-type: none">• Alterations made to the rifles.• Supports used as a rest for the rifle or the forearm.• A spotting scope.• Use of sights not provided with the cadet air rifle.• Coaching.
Note: To make this activity more difficult, shorten the time allowance.

SPEED GRID TARGET

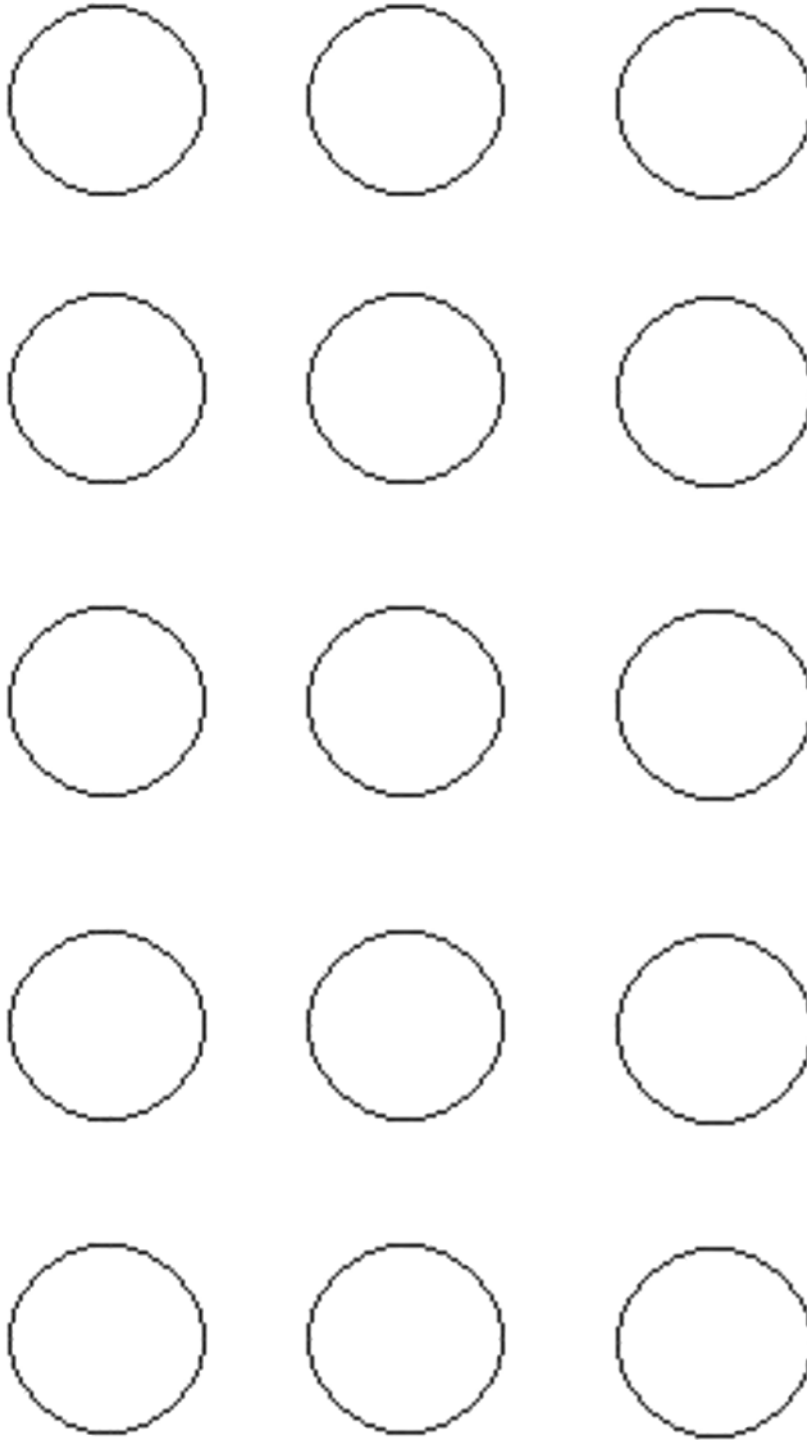

Name: _____ Date: _____

Director Cadets 3, 2007, Ottawa, ON: Department of National Defence

Figure 6G-1 Speed Grid Target

TIMED ACTIVITY – BEAT THE CLOCK

BEAT THE CLOCK	
Objective:	To fire pellets into the designated hours (numbers) within a time limit.
Scoring:	One point is awarded for each correct hour (number) hit by a pellet within the time allotted.
Equipment Required:	<p>Mandatory:</p> <ul style="list-style-type: none">• Beat the Clock Target (one per cadet), and• A stopwatch. <p>Optional aids to firing are limited to the following:</p> <ul style="list-style-type: none">• Cadet air rifle sling,• Marksmanship jacket,• Shooting glove, and• Hat.
Activity Instructions:	<ol style="list-style-type: none">1. Distribute one Beat the Clock Target to each cadet.2. Have the cadets write their name and date on the target and attach it to the target frame.3. Have the cadets fire in relays following the commands given by the RSO.4. Have the RSO using the 12-hour clock, call out one number every 20 second for a total of six numbers.5. Give the cadets six pellets to fire, one pellet at each hour (number) as it is called.6. Score the targets awarding one point for each correct number hit on the target.7. Allow the cadets to review and keep their targets. <p>The following is prohibited:</p> <ul style="list-style-type: none">• Alterations made to the rifles.• Supports used as a rest for the rifle or the forearm.• A spotting scope.• Use of sights not provided with the cadet air rifle.• Coaching.
Note:	To make this activity more difficult, shorten the time allowance.

BEAT THE CLOCK TARGET

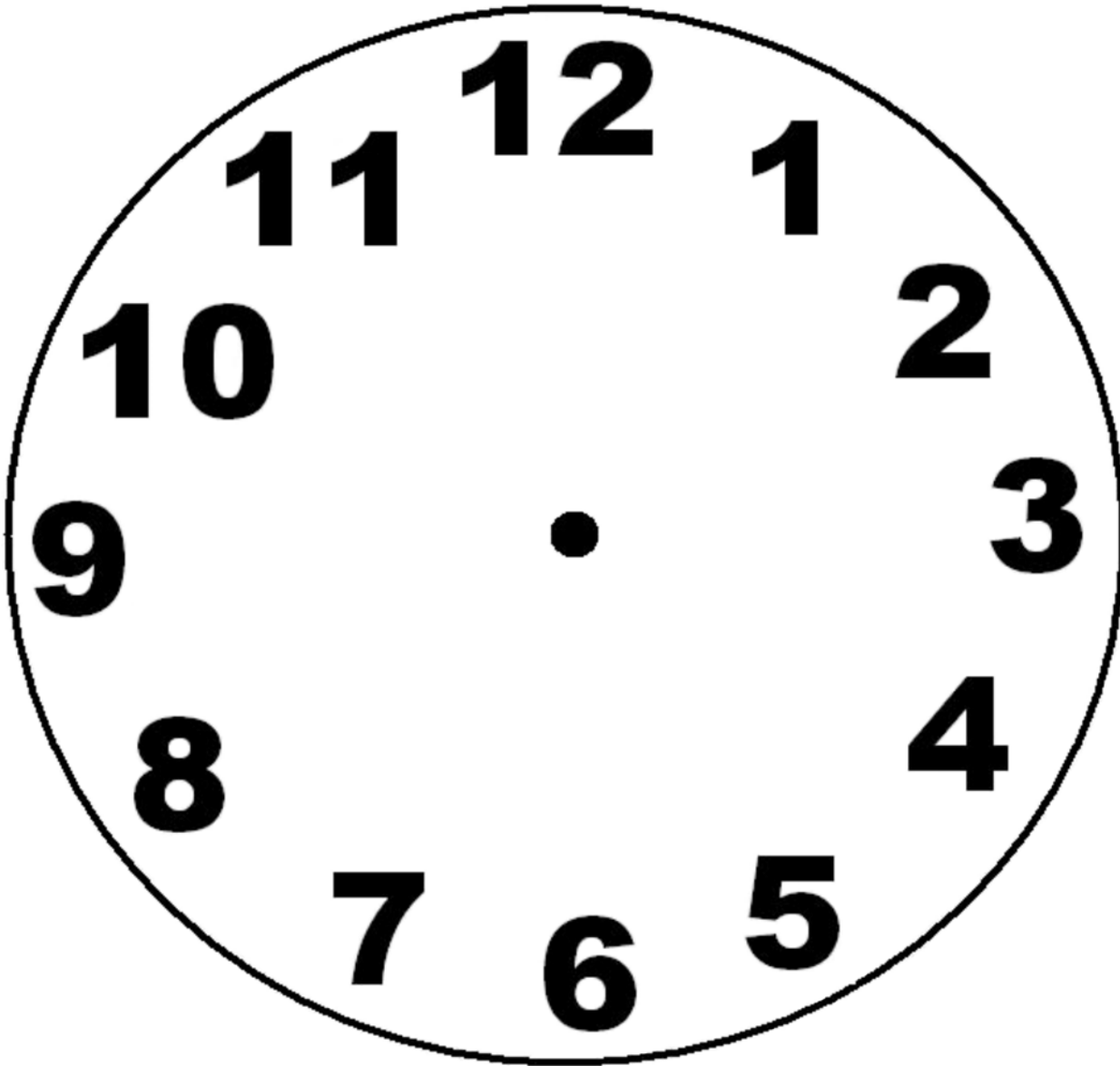

Name: _____ Date: _____

Director Cadets 3, 2007, Ottawa, ON: Department of National Defence

Figure 6H-1 Clock Target

COMPETITIVE ACTIVITY – CORPS/SQUADRON MARKSMANSHIP COMPETITION

CORPS/SQUADRON MARKSMANSHIP COMPETITION
<p>Objective: To provide cadets the opportunity to compete within the corps.</p>
<p>Scoring: Targets will be scored IAW A-CR-CCP-177/PT-001, to include:</p> <ul style="list-style-type: none">• Each target has a highest possible score of 100 points (10 diagrams worth 10 points each).• All shot holes are scored using the highest value of the scoring ring that it is broken.• Shots outside the scoring rings are given a value of zero.• If more than the one pellet is fired on a target, the shots with the highest value will be discarded until one shot remain on the target. Also, a two-point penalty will be deducted for each excess shot.• If more than one shot is fired at a scoring diagram, only the prescribed number of shots may be fired at the remaining diagrams (e.g., if two shots were fired at the first diagram, one diagram on the target would remain blank [free of shots]). If this occurs more than twice, a two-point penalty will be deducted for each excess shot.• This activity may be conducted as individuals or teams of four.
<p>Equipment Required:</p> <p>Mandatory: CCT2001AR853 CCM Competition Targets (two per cadet).</p> <p>Optional aids to firing are limited to the following:</p> <ul style="list-style-type: none">• Cadet air rifle sling,• Marksmanship jacket,• Shooting glove, and• Hat.
<p>Activity Instructions:</p> <ol style="list-style-type: none">1. Distribute two CCT2001AR853 CCM Competition Targets to each cadet.2. Have the cadets write their name and date on each target and attach them to the target frame.3. Give the cadets 20 scoring pellets to fire, one pellet at each scoring diagram (additional zeroing pellets are permitted).4. Have the cadets fire in relays, following the commands given by the RSO.5. Give the cadets 30 minutes to complete firing.6. Have the RSO collect the targets, score as described above and record the results.7. Allow the cadets to review and keep their targets. <p>The following is prohibited:</p> <ul style="list-style-type: none">• Crossfiring.• Alterations made to the rifles.• Supports used as a rest for the rifle or the forearm.• A spotting scope.• Use of sights not provided with the cadet air rifle.

THIS PAGE INTENTIONALLY LEFT BLANK

COMPETITIVE ACTIVITY – LUNAR LAUNCH

LUNAR LAUNCH			
Objective: To provide cadets the opportunity to compete within the corps.			
Scoring: The average distance from the earth to the moon is 384 400 km. All targets from marksmanship activities conducted during marksmanship training will be added together to calculate a distance from earth and achieve a position on the space shuttle crew. The four scoring levels/positions must meet the following standards:			
1.	Mission Commander:	A score of 100 plus:	384 400 km from earth, lunar landing!
2.	Mission Specialist:	A score of 75 to 99:	288 300 km from earth.
3.	Chief Engineer:	A score of 50 to 74:	192 200 km from earth.
4.	Science Officer:	A score of 25 to 49:	96 100 km from earth, lunar launch!
Equipment Required:			
Mandatory: Scores for all targets used in marksmanship activities during the training year.			
Activity Instructions:			
1. Add the scores from the targets used by each cadet during the training year.			
2. Use the scoring method described above to assign the cadets levels/positions on the space shuttle crew.			
Notes:			
1. A record must be kept of each cadet's scores from all marksmanship activities.			
2. This activity may be conducted over multiple training years.			
3. The certificate found in this annex may be awarded to cadets who achieve levels/positions in this activity.			

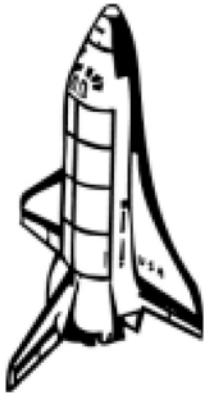

This is to certify that _____

has achieved the position of _____

in the



Lunar Launch Marksmanship Activity

_____ Date

_____ Range Safety Officer

MPI EXAMPLES

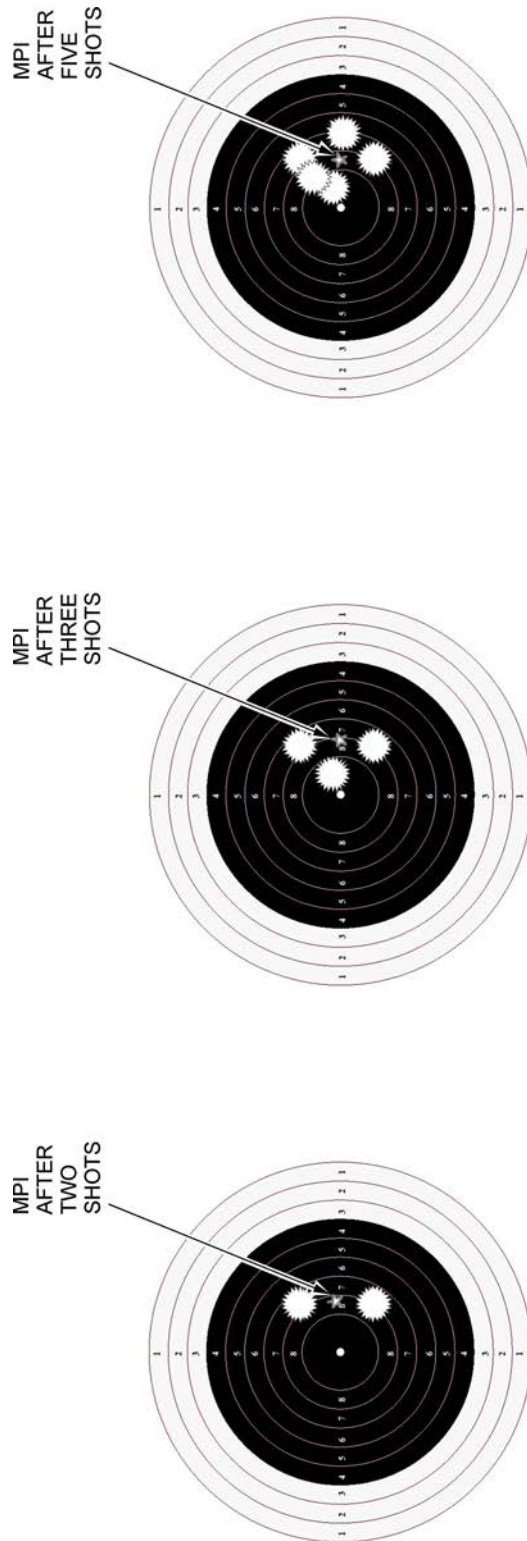

Director Cadets 3, 2007, Ottawa, ON: Department of National Defence

Figure 6K-1 MPI Examples

THIS PAGE INTENTIONALLY LEFT BLANK

SIGHT ADJUSTMENT ACTIVITY

Name: _____ Date: _____



ELEVATION: _____
WINDAGE: _____



ELEVATION: _____
WINDAGE: _____



ELEVATION: _____
WINDAGE: _____



ELEVATION: _____
WINDAGE: _____



ELEVATION: _____
WINDAGE: _____



ELEVATION: _____
WINDAGE: _____

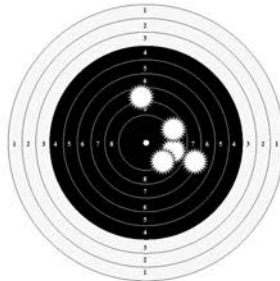

ELEVATION: _____
WINDAGE: _____



ELEVATION: _____
WINDAGE: _____



ELEVATION: _____
WINDAGE: _____

Director Cadets 3, 2007, Ottawa, ON: Department of National Defence

Figure 6L-1 Sight Adjustment Activity Targets

THIS PAGE INTENTIONALLY LEFT BLANK

SIGHT ADJUSTMENT ACTIVITY – ANSWER KEY



ELEVATION: 1 CCW
 WINDAGE: 4 CCW



ELEVATION: 2 CCW
 WINDAGE: 1 CW



ELEVATION: 5 CW
 WINDAGE: 6 CCW



ELEVATION: 6 CW
 WINDAGE: NONE



ELEVATION: 9 CW
 WINDAGE: 12 CCW

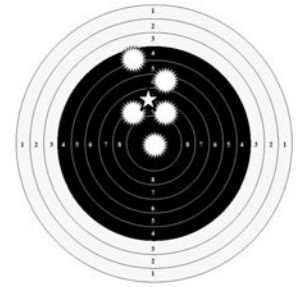

ELEVATION: 6 CCW
 WINDAGE: 1 CW



ELEVATION: 1 CCW
 WINDAGE: 6 CCW



ELEVATION: 8 CCW
 WINDAGE: 4 CCW



ELEVATION: 0 CLICKS
 WINDAGE: 0 CLICKS

Director Cadets 3, 2007, Ottawa, ON: Department of National Defence

Figure 6M-1 Answer Key Targets

THIS PAGE INTENTIONALLY LEFT BLANK

CHAPTER 7
PO 307 – SERVE IN A SEA CADET CORPS



ROYAL CANADIAN SEA CADETS

PHASE THREE

INSTRUCTIONAL GUIDE



SECTION 1

EO M307.01 – IDENTIFY PHASE THREE TRAINING OPPORTUNITIES

Total Time: 30 min

PREPARATION

PRE-LESSON INSTRUCTIONS

Resources needed for the delivery of this lesson are listed in the lesson specification located in A-CR-CCP-603/PG-001, Chapter 4. Specific uses for said resources are identified throughout the instructional guide within the TP for which they are required.

Review the lesson content and become familiar with the material prior to delivering the lesson.

Photocopy Annex A for each cadet.

PRE-LESSON ASSIGNMENT

N/A.

APPROACH

An in-class activity was chosen for TPs 1 and 3 as it is an interactive way to provoke thought and stimulate an interest in Phase Three training opportunities among the cadets.

An interactive lecture was chosen for TP 2 to orient the cadets and generate an interest in Phase Three complementary training opportunities.

INTRODUCTION

REVIEW

N/A.

OBJECTIVES

By the end of this lesson the cadet shall have identified the training opportunities they will receive in Phase Three.

IMPORTANCE

It is important for cadets to know what training will be conducted during Phase Three to give them an overview of what the training year will entail. This lesson will prepare the cadets for the training year and help generate interest in the topics.

Teaching Point 1**Identify Phase Three Mandatory Training Opportunities**

Time: 10 min

Method: In-Class Activity

OVERVIEW

The training program is broken into performance objectives (POs), which are the overall subjects, and enabling objectives (EOs), which are the topics within each PO. Training is conducted as mandatory and complementary components.

MANDATORY TRAINING

Mandatory training encompasses the EOs that all cadets must complete throughout the training year.

ACTIVITY**OBJECTIVE**

The objective of this activity is to have the cadets participate in a gallery walk of information for each PO.

RESOURCES

Resources will be IAW with each PO as listed below.

ACTIVITY LAYOUT

Set up a station for each PO with information, pictures, videos and other training aids at each station that will exemplify what the cadet will learn in each PO.

PO 301 – Citizenship (Chapter 1)

Citizenship provides the cadets with an opportunity to identify the role of service groups within Canada.



An example of information/training aids that could be set up at this station is information about local service groups.

PO 302 – Community Service (Chapter 2)

Community service provides the cadets with an opportunity to perform community service. The community service should provide a direct benefit to the community and promote good citizenship.



An example of information/training aids that could be set up at this station is pictures from various community service activities in which the corps has participated.

PO 303 – Leadership (Chapter 3)

Leadership provides the cadets with an opportunity to perform the role of a team leader. The cadets will:

- define the role and responsibilities of a team leader;

- participate in a mentoring relationship;
- practice self-assessment;
- communicate as a team leader;
- supervise cadets;
- solve problems; and
- lead a team through a leadership assignment.



Examples of information/training aids that could be set up at this station include:

- pictures of famous leaders,
- leadership quotes, and
- pictures of cadets from the corps participating in leadership activities/taskings.

PO 304 – Personal Fitness and Healthy Living (Chapter 4)

Personal fitness and healthy living provides the cadets with an opportunity to update their personal physical activity plans (from Phase Two) for the training year. The cadets will:

- describe well-being;
- participate in the Cadet Fitness Assessment;
- set new short-term and long-term goals for the training year; and
- evaluate their personal activity plan.

This PO gives the cadets some of the tools required to make informed choices in order to follow a healthy lifestyle. This is important as physical fitness is one of the aims of the Cadet Program.



Examples of information/training aids that could be set up at this station include:

- the DVD included in The Cooper Institute, *Fitnessgram 8.0 Stand-Alone Test Kit*, Human Kinetics,
- a CD/cassette player with the audio recording of the *PACER* beeps, and
- copies of the Cadet Fitness Assessment Scoresheet.

PO 305 – Recreational Sports (Chapter 5)

Recreational sports provide the cadets with an opportunity to participate in organized recreational team sports. This is important as physical fitness is one of the aims of the Cadet Program.



Examples of information/training aids that could be set up at this station include:

- soccer ball,
- volleyball,
- floor hockey ball,
- hockey sticks,

- Frisbees, and
- pictures of cadets at the corps participating in recreational sports.

PO 306 – Air Rifle Marksmanship (Chapter 6)

Air rifle marksmanship provides the cadets with an opportunity to participate in a recreational marksmanship activity.



A miniature range could be set up at this station, to include:

- a mat,
- a cadet air rifle,
- sample targets,
- a scope,
- a sling, and
- safety goggles/glasses.

PO 307 – General Cadet Knowledge

General cadet knowledge provides the cadets with the information required to serve as a member of a sea cadet corps. Cadets will:

- identify the training opportunities available in Phase Three; and
- recognize the partnership between the Navy League of Canada and the Department of National Defence in support of the Canadian Cadet Movement.



Examples of information/training aids that could be set up at this station include:

- information sheets/poster on year three summer training opportunities, and
- information about the Navy League of Canada.

PO 308 – Drill (Chapter 8)

Drill provides the cadets with an opportunity to direct a squad on the parade square. The cadets will:

- prepare a squad for a parade; and
- deliver words of command.



Examples of information/training aids that could be set up at this station include:

- a copy of A-PD-201-000/PT-000, *Canadian Forces Manual of Drill and Ceremonial*,
- a video of cadets participating in drill, and
- pictures of the cadets in the corps participating in drill.

PO 309 – Instructional Techniques (Chapter 9)

Instructional techniques provides the cadets with an opportunity to instruct a lesson. The cadets will:

- explain principles of instruction;
- identify methods of instruction;
- describe effective speaking techniques;
- describe questioning techniques;
- select appropriate instructional aids;
- plan a lesson; and
- instruct a 15-minute lesson.



Examples of information/training aids that could be set up at this station include:

- copies of completed lesson plans, and
- various types of instructional aids.

PO 320 – Canadian Navy and Maritime Community (Chapter 11)

Canadian Navy and maritime community provides the cadets with an opportunity to describe aspects of the Canadian Navy. The cadets will:

- identify classes of Canadian naval ships;
- describe the domestic role of the Canadian Forces; and
- describe the role of the Canadian Forces in international institutions.



Examples of information/training aids that could be set up at this station include:

- pictures of various HMC ships,
- pictures of HMC ship mascots,
- pictures of Canadian naval bases,
- articles about domestic operations in which the Canadian Forces were involved, and
- information about the United Nations, North Atlantic Treaty Organization and the North American Aerospace Defence Command.

PO 321 – Ropework (Chapter 12)

Ropework provides the cadets with an opportunity to rig a lifting device. The cadets will:

- describe safety procedures for operating lifting devices; and
- rig sheers.



A model sheers could be set up at this station.

PO 323 – Ship's Operations (Chapter 14)

Ship's operations provides the cadets with an opportunity to learn to serve in a naval environment. The cadets will perform the duties of the quartermaster.



Examples of information/training aids that could be set up at this station include:

- a description of corps duties, and
- pictures/videos of cadets performing the duties of the quartermaster.

PO 324 – Sailing (Chapter 15)

Sailing provides the cadets with an opportunity to participate in a sailing weekend IAW the Canadian Yachting Association (CYA) White Sail Level II.



Examples of information/training aids that could be set up at this station include:

- pictures/videos of cadets sailing, and
- a model sailboat.

Seamanship Inter-Divisional Competition (Chapter 16)

The seamanship inter-divisional competition (SIDC) provides the cadets with an opportunity to compete with their peers in activities, such as:

- trivia questions from Phase training,
- ropework,
- ship's operations, and
- team building.



Examples of information/training aids that could be set up at this station include:

- a model sheers,
- examples of ropework,
- pictures/models of ships, and
- pictures/videos of cadets participating in the SIDC.

ACTIVITY INSTRUCTIONS

Have the cadets walk around the classroom, visiting each station.

SAFETY

N/A.

CONFIRMATION OF TEACHING POINT 1

The cadets' participation in the activity will serve as the confirmation of this TP.

Teaching Point 2

Identify Phase Three Complementary Training Opportunities

Time: 5 min

Method: Interactive Lecture



Discuss the complementary training opportunities that will be taught for each PO. The following information is a summary of the complementary training offered in Phase Three.

PHASE THREE COMPLEMENTARY TRAINING

Complementary training provides corps staff with a variety of EOs they can choose to instruct. These lessons are used to complement mandatory training.

PO 301 – Citizenship (Chapter 1)

Complementary training for citizenship provides the cadets an opportunity to:

- discuss the three branches of the Canadian government;
- discuss current events;
- tour a local community service group; and
- participate in a presentation given by a guest speaker from a local community service group.

PO 302 – Community Service (Chapter 2)

Complementary training for community service provides the cadets an opportunity to:

- participate in a ceremonial parade; and
- perform additional community service.

PO 303 – Leadership (Chapter 3)

Complementary training for leadership provides the cadets an opportunity to:

- lead team-building activities; and
- deliver a presentation about a leader.

PO 304 – Personal Fitness and Healthy Living (Chapter 4)

Complementary training for personal fitness and healthy living provides the cadets an opportunity to:

- participate in the Cadet Fitness Assessment and evaluate a personal activity plan at the mid-point of the training year;
- describe stress; and
- create team goals.

PO 305 – Recreational Sports (Chapter 5)

Complementary training for recreational sports provides the cadets an opportunity to:

- participate in an organized sports tabloid;
- participate in an organized intramural sports event; and
- participate in an orienteering event.

PO 306 – Air Rifle Marksmanship (Chapter 6)

Complementary training for air rifle marksmanship provides the cadets an opportunity to:

- identify civilian marksmanship organizations;
- correct marksmanship error;
- adopt the standing position with the cadet air rifle;
- practice holding techniques;
- practice aiming techniques; and
- practice firing techniques.

PO 307 – General Cadet Knowledge

Complementary training for general cadet knowledge provides the cadets an opportunity to:

- participate in a presentation given by a guest speaker from the Regional Cadet Support Unit;
- participate in a presentation given by the Cadet Liaison Officer; and
- participate in a presentation given by a guest speaker from the Navy League of Canada.

PO 308 – Drill (Chapter 8)

Complementary training for drill provides the cadets an opportunity to:

- execute flag drill;
- practice delivering words of command;
- practice ceremonial drill as a review; and
- execute drill with arms.

PO 309 – Instructional Techniques (Chapter 9)

Complementary training for instructional techniques provides the cadets an opportunity to:

- deliver a one-minute verbal presentation;
- identify formations for drill instruction;
- plan a drill lesson; and
- instruct a 15-minute drill lesson.

PO 311 – Biathlon (Chapter 10)

Complementary training for biathlon provides the cadets an opportunity to:

- practice aiming and firing the cadet air rifle following physical activity;

- participate in a recreational summer biathlon activity;
- identify civilian biathlon opportunities;
- run on alternate terrain;
- fire the cadet air rifle using a sling following physical activity;
- participate in a competitive summer biathlon activity;
- participate in a biathlon briefing;
- run wind sprints; and
- fire the cadet air rifle following physical activity.

PO 320 – Canadian Navy and Maritime Community (Chapter 11)

Complementary training for Canadian Navy and maritime community provides the cadets an opportunity to:

- attend a presentation on a naval commemorative event;
- describe the Women's Royal Naval Services; and
- describe naval aviation.

PO 321 – Ropework (Chapter 12)

Complementary training for ropework provides the cadets an opportunity to:

- rig a standing derrick;
- rig a gyn;
- make a monkey's fist; and
- make a turk's head.

PO 322 – Small Craft Operations (Chapter 13)

Complementary training for small craft operations provides the cadets an opportunity to attain a pleasure craft operator competency card, to include:

- describing acts, codes and regulations;
- describing personal safety;
- describing vessel safety; and
- describing navigation safety.

PO 323 – Ship's Operations (Chapter 14)

Complementary training for ship's operations provides the cadets an opportunity to:

- communicate using flags and pennants;
- pipe Wakey Wakey; and
- pipe Hands to Dinner.

PO 325 – Nautical Training (Chapter 15)

Complementary training for nautical training offers two options that provide the cadets an opportunity to:

- perform small craft/vessel duties while underway; or
- participate in a nautical activity that will reinforce mandatory and/or complementary training, allow cadets to participate in naval aspects of the CF or maritime community/industry, and provide a hands-on opportunity that introduces new skills/knowledge.

CONFIRMATION OF TEACHING POINT 2

QUESTIONS

- Q1. What is the purpose of complementary training?
- Q2. What complementary training is associated with PO 303 – Leadership (Chapter 3)?
- Q3. What complementary training is associated with PO 321 – Ropework (Chapter 12)?

ANTICIPATED ANSWERS

- A1. Complementary training is used to complement the mandatory training.
- A2. Complementary training for leadership includes:
- lead team-building activities; and
 - deliver a presentation about a leader.
- A3. Complementary training for ropework includes:
- rig a standing derrick;
 - rig a gyn;
 - make a monkey's fist; and
 - make a turk's head.

Teaching Point 3

Conduct an Activity Where the Cadets Will Identify Phase Three Training Opportunities

Time: 10 min

Method: In-Class Activity

ACTIVITY

OBJECTIVE

The objective of this activity is to have the cadets identify Phase Three training opportunities.

RESOURCES

- Phase Three POs and EOs handout,
- Flip chart paper, and
- Markers/pencil crayons.

ACTIVITY LAYOUT

N/A.

ACTIVITY INSTRUCTIONS

This activity may be conducted in groups of no more than three cadets or individually.

1. Distribute the Phase Three POs and EOs handout located at Annex A.
2. Distribute a piece of flip chart paper and markers/pencil crayons to each group/cadet.
3. Have the cadets design a poster that illustrates what they are most excited to do in Phase Three training.
4. Have each group/cadet present their poster to the class.

SAFETY

N/A.

CONFIRMATION OF TEACHING POINT 3

The cadets' participation in the activity will serve as the confirmation of this TP.

END OF LESSON CONFIRMATION

The cadets' identifying Phase Three training opportunities in the activity in TP 3 will serve as the confirmation of this lesson.

CONCLUSION

HOMEWORK/READING/PRACTICE

N/A.

METHOD OF EVALUATION

N/A.

CLOSING STATEMENT

Being aware of the topics to be covered during Phase Three training will help generate interest in the training year. Being aware of the opportunities available throughout the training year may stimulate an interest in specific areas of training.

INSTRUCTOR NOTES/REMARKS

For Phase Three complementary training opportunities in TP 2, refer to the corps' annual training plan.

This EO should be scheduled as early as possible in the training year.

REFERENCES

A0-096 Director Cadets 3. (2007). CATO 11-04, *Cadet Program Outline*. Ottawa, ON: Department of National Defence.

THIS PAGE INTENTIONALLY LEFT BLANK



ROYAL CANADIAN SEA CADETS

PHASE THREE

INSTRUCTIONAL GUIDE



SECTION 2

EO M307.02 – IDENTIFY YEAR THREE CSTC TRAINING OPPORTUNITIES

Total Time:

30 min

PREPARATION

PRE-LESSON INSTRUCTIONS

Resources needed for the delivery of this lesson are listed in the lesson specification located in A-CR-CCP-603/PG-001, Chapter 4. Specific uses for said resources are identified throughout the instructional guide within the TP for which they are required.

Review the lesson content and become familiar with the material prior to delivering the lesson.

Review year three CSTC training opportunities found at CATO 31-03, *Sea Cadet Program Outline*, as the prerequisites for courses may change.

PRE-LESSON ASSIGNMENT

N/A.

APPROACH

A group discussion was chosen for TP 1 as it allows the cadets to interact with their peers and share their experiences, opinions and feelings about year three CSTC training opportunities.

An interactive lecture was chosen for TP 2 to orient the cadets to year three CSTC training opportunities and to generate interest.

INTRODUCTION

REVIEW

N/A.

OBJECTIVES

By the end of this lesson the cadet shall have identified year three CSTC training opportunities.

IMPORTANCE

It is important for cadets to identify year three CSTC training opportunities available to them because they must decide which course they would like to attend.

Teaching Point 1

**Conduct a Group Discussion on Specialty Areas for Year
Three CSTC Training**

Time: 10 min

Method: Group Discussion

BACKGROUND KNOWLEDGE



The purpose of the group discussion is to draw the following information from the group using the tips for answering/facilitating discussion and the suggested questions provided.

Write the specialty areas on a whiteboard/flip chart and discuss the activities associated with each area. Cadets may already know which area they would like to pursue and have a general idea of the activities.

AIR RIFLE MARKSMANSHIP

Cadets will develop marksmanship and biathlon knowledge and skills. Activities include:

- participating in advanced air rifle marksmanship training;
- participating in recreational marksmanship and biathlon activities;
- performing range assistant duties; and
- learning marksmanship instructional techniques.

FITNESS AND SPORTS

Cadets will improve individual fitness and sports knowledge and skills. Activities include:

- playing and developing skills in sports;
- participating in personal fitness activities; and
- learning fitness and sports instructional techniques.

MUSIC

Cadets will develop music knowledge and skills. Activities include:

- learning music theory;
- playing an instrument as part of an ensemble;
- playing an instrument as part of a military band;
- developing individual music skills; and
- learning music instructional techniques.

SAIL

Cadets will develop sailing skills and knowledge IAW Canadian Yachting Association (CYA) Bronze Sail Level 4. Sailing is the primary activity of this course.

SEAMANSHIP

Cadets will develop seamanship knowledge and skills. Activities include:

- operating small boats;
- communicating in a naval environment;
- performing ropework; and
- performing coastal navigation.

DRILL AND CEREMONIAL

Cadets will develop the knowledge and skills required to improve leadership and drill and ceremonial knowledge and skills. Activities include:

- developing leadership skills;
- performing naval ceremonial drill;
- performing advanced foot drill;
- delivering words of command;
- performing cutlass drill;
- performing flag drill;
- executing ceremonies; and
- learning drill instructional techniques.

GROUP DISCUSSION



TIPS FOR ANSWERING/FACILITATING DISCUSSION

- Establish ground rules for discussion, e.g., everyone should listen respectfully; don't interrupt; only one person speaks at a time; no one's ideas should be made fun of; you can disagree with ideas but not with the person; try to understand others as much as you hope they understand you; etc.
- Sit the group in a circle, making sure all cadets can be seen by everyone else.
- Ask questions that will provoke thought; in other words avoid questions with yes or no answers.
- Manage time by ensuring the cadets stay on topic.
- Listen and respond in a way that indicates you have heard and understood the cadet. This can be done by paraphrasing their ideas.
- Give the cadets time to respond to your questions.
- Ensure every cadet has an opportunity to participate. One option is to go around the group and have each cadet answer the question with a short answer. Cadets must also have the option to pass if they wish.
- Additional questions should be prepared ahead of time.

SUGGESTED QUESTIONS

- Q1. Which summer training activities interest you?
- Q2. Who is interested in applying for summer training this year? Why?
- Q3. What specialty area are you interested in pursuing? Why?



Other questions and answers will develop throughout the group discussion. The group discussion should not be limited to only those suggested.



Reinforce those answers given and comments made during the group discussion, ensuring the teaching point has been covered.

CONFIRMATION OF TEACHING POINT 1

The cadets' participation in the group discussion will serve as the confirmation of this TP.

Teaching Point 2

Describe Year Three CSTC Courses

Time: 15 min

Method: Interactive Lecture



A cadet who has attended one of these courses could be asked to speak about their experience during this TP.

COMMON COURSES



Common courses are available to air, army and sea cadets.

Air Rifle Marksmanship Instructor. The aim of this course is to improve the cadets' marksmanship and biathlon knowledge and skills, and to prepare the cadets to assist in the delivery of marksmanship and biathlon training. The prerequisite for this course is completion of the Phase Three qualification.

Fitness and Sports Instructor. The aim of this course is to improve the cadets' fitness and sports knowledge and skills, and to prepare the cadets to assist in the delivery of fitness and sports training. The prerequisite for this course is completion of the Phase Three qualification.

Military Band – Intermediate Musician. The aim of this course is to improve the cadets' music knowledge and skills, and to prepare the cadets to assist in the delivery of music training. The prerequisites for this course are Music Proficiency Level Basic and completion of the Phase Three qualification.

ELEMENTAL COURSES

Intermediate Sail. The aim of this course is for the cadets to become proficient in intermediate sailing skills, to achieve CYA Bronze Sail Level 4, Small Craft Operations (SCOP) Module 2 and SCOP Module 4, and be introduced to CYA Bronze Sail Level 5. The prerequisites for this course are completion of the Phase Three qualification and CYA White Sail Level III.

Ship's Boat Operator. The aim of this course is to introduce the cadets to coastal navigation, to develop naval communication skills and to become a qualified small boat operator. The prerequisite for this course is completion of the Phase Three qualification.

Drill and Ceremonial Instructor. The aim of this course is for the cadets to become proficient in organizing and leading parades and ceremonies, to improve leadership skills and knowledge, and to become a drill and ceremonial instructor. The prerequisite for this course is completion of the Phase Three qualification.

CONFIRMATION OF TEACHING POINT 2

QUESTIONS

- Q1. What common CSTC courses are available in year three?
- Q2. What is the prerequisite for the Fitness and Sports Instructor course?
- Q3. What elemental CSTC courses are available in year three?

ANTICIPATED ANSWERS

- A1. Air Rifle Marksmanship Instructor, Fitness and Sports Instructor and Military Band–Intermediate Musician.
- A2. Completion of the Phase Three corps training program.
- A3. Intermediate Sail, Ship's Boat Operator and Drill and Ceremonial Instructor.

END OF LESSON CONFIRMATION

The cadets' participation in the group discussion will serve as the confirmation of this lesson.

CONCLUSION

HOMEWORK/READING/PRACTICE

N/A.

METHOD OF EVALUATION

N/A.

CLOSING STATEMENT

Summer training is a fun and exciting aspect of the Cadet Program, which offers training in specialty areas that may not be accessible at the corps. Summer training centres are places to meet other cadets and to make new friends from across Canada. It is important to be familiar with the summer training courses offered so cadets may apply for the course that interests them and receive the maximum benefit from attending that course.

INSTRUCTOR NOTES/REMARKS

This EO should be conducted before the summer training application deadline.

It is recommended that the summer training application forms be completed during a training session after this EO has been conducted.

REFERENCES

- A0-010 Director Cadets 2. (2006). CATO 11-03, *Cadet Program Mandate*. Ottawa, ON: Department of National Defence.
- A0-033 Director Cadets 3. (2004). CATO 14-21, *Music Training and Education With the Canadian Cadet Organizations*. Ottawa, ON: Department of National Defence.
- A1-019 Director Cadets 3. (2006). CATO 31-03, *Sea Cadet Program Outline*. Ottawa, ON: Department of National Defence



ROYAL CANADIAN SEA CADETS

PHASE THREE

INSTRUCTIONAL GUIDE



SECTION 3

EO M307.03 – RECOGNIZE THE PARTNERSHIP BETWEEN THE NAVY LEAGUE OF CANADA (NLC) AND THE DEPARTMENT OF NATIONAL DEFENCE (DND) IN SUPPORT OF THE CANADIAN CADET MOVEMENT (CCM)

Total Time:

30 min

PREPARATION

PRE-LESSON INSTRUCTIONS

Resources needed for the delivery of this lesson are listed in the lesson specification located in A-CR-CCP-603/PG-001, Chapter 4. Specific uses for said resources are identified throughout the instructional guide within the TP for which they are required.

Review the lesson content and become familiar with the material prior to delivering the lesson.

Photocopy and cut out the responsibilities cards located at Annex B.

PRE-LESSON ASSIGNMENT

N/A.

APPROACH

An interactive lecture was chosen for TPs 1 and 2 to introduce the cadets to the three levels of the NLC and the responsibilities of the NLC and DND in support of the CCM, as it allows the instructor to deliver new information while encouraging the cadets to become actively involved by asking and responding to questions.

An in-class activity was chosen for TP 3 as it is an interactive way to involve the cadets in describing the partnership between the NLC and DND in support of the CCM.

INTRODUCTION

REVIEW

N/A.

OBJECTIVES

By the end of this lesson the cadet shall have recognized the partnership between the NLC and DND in support of the CCM.

IMPORTANCE

It is important for cadets to recognize the partnership between the NLC and DND in support of the CCM because these two organizations work together to ensure the success of the CCM which impacts the cadets directly.

Teaching Point 1**Describe the Three Levels of the NLC**

Time: 5 min

Method: Interactive Lecture

THE NATIONAL LEVEL OF THE NLC

There are a number of components of the NLC at the national level. These include:

- **National Board of Directors.** The governing body of the NLC.
- **National Executive Committee.** Oversees operations between meetings of the Board of Directors.
- **National Advisory Council.** Comprised of three past national presidents, it acts as an advisory group for the president, the nominating committee for the election of officers and members of the board and undertakes projects as requested by the president.
- **National Office.** Located in Ottawa, Ont. and headed by the Executive Director. Its responsibility is to manage the day-to-day affairs of the NLC.

THE DIVISIONS OF THE NLC

With a few exceptions, there is a NLC division for each province. The divisions provide guidance and support to the branches.

THE BRANCHES OF THE NLC

The branches of the NLC are groups of people in local areas who conduct NLC affairs. A Branch Council comprised of a President, one or more Vice-Presidents, a Secretary, a Treasurer and Chairs of committees oversees the various branch activities. Branch Committees may include Sea Cadet, Navy League Cadet, Fundraising or Public Relations. The Sea Cadet Chair is the liaison between the branch and the corps.

CONFIRMATION OF TEACHING POINT 1

QUESTIONS

- Q1. What are two components of the NLC at the national level?
- Q2. What is the purpose of the divisions of the NLC?
- Q3. What is the purpose of the Sea Cadet Chair?

ANTICIPATED ANSWERS

- A1. Components of the NLC at the national level are:
- National Board of Directors,
 - National Executive Committee,
 - National Advisory Council, and
 - National Office.
- A2. The divisions provide guidance and support to the branches.
- A3. The Sea Cadet Chair is the liaison between the branch and the corps.

Teaching Point 2**Describe the Responsibilities of the NLC and DND**

Time: 10 min

Method: Interactive Lecture

RESPONSIBILITIES OF THE NLC

Recruiting Cadets. The Branch Council must organize and implement a plan for recruiting cadets.

Recruiting Cadet Instructor Cadre (CIC) Officers. The NLC is responsible for recommending suitable people to be enrolled into the Canadian Forces (CF) as cadet instructors.

Fundraising. The Branch Council must organize fundraising activities that support the corps.

Providing Awards and Medals. The NLC provides awards to cadets and officers, such as:

- **Navy League Award of Commendation.** Awarded by the National Board of Directors to a navy league/sea cadet who performs an outstanding act or deed in attempting to save the life or property of another.
- **National Sea Cadet of the Year.** Awarded annually by the National Board of Directors to the most proficient sea cadet in Canada.
- **Division Sea Cadet of the Year.** Awarded annually by each division to the most proficient sea cadet in that division.
- **Navy League Medal of Excellence.** Awarded annually by each division to the most proficient navy league/sea cadets in each division (usually one per corps).
- **Sea Cadet Service Medal.** Awarded by each division to sea cadets with continuous cadet service of at least four years.
- **Perfect Attendance (Program).** Awarded by branches to sea cadets with perfect attendance at all training parades during their time as a cadet.
- **Perfect Attendance (Year).** Awarded by branches to sea cadets with perfect attendance at all training parades during the training year.

Providing Corps Training Facilities. The NLC Branch provides office and training facilities for the corps, when not provided by DND.

Organizing/Conducting Recreational Programs. The NLC is responsible for organizing and conducting the Royal Canadian Sea Cadet National Regatta.

Providing Funds for Optional Training Activities. The NLC Branch provides funds for optional training activities.

Providing Equipment to Cadet Corps. The NLC Branch is responsible for providing equipment for optional training activities.

RESPONSIBILITIES OF DND

Training CIC Officers. DND is responsible for analyzing, designing and developing course curriculum, approving training according to regional requirements and consulting with the NLC with respect to CIC officer course content.

Providing Qualification Standards and Plans (QSPs) and Instructional Guides (IGs) for Cadet Training. DND develops and provides QSPs and IGs that direct cadet training.

Providing Funds for Mandatory Training and Support Activities. Mandatory training and support activities are funded by DND.

Developing Policy Regarding CIC Officers, Civilian Instructors (CIs) and Cadets. DND is responsible for developing, implementing and enforcing policy regarding CIC officer, CIs and cadets.

Issuing Equipment to Cadet Corps IAW Scales of Issue. All equipment required for mandatory training, mandatory support activities and directed optional training is provided by DND.

Providing Pay for CIC Officers and CIs. DND is responsible for developing, implementing and enforcing pay policy as well as providing pay for CIC officers and CIs.

Selecting Cadets for Cadet Summer Training Centres (CSTCs). DND is responsible for ensuring that cadets meet prerequisites and selecting cadets for summer training courses.

Providing Facilities and Staff for CSTCs. DND is responsible for ensuring adequate facilities and selecting staff for CSTCs.

RESPONSIBILITIES OF BOTH THE NLC AND DND

Forming or Disbanding Cadet Corps. The NLC and DND work collaboratively to form new cadet corps and disband non-effective cadet corps.

Developing Community and Media Relationships. Media relationships are maintained at all levels of the NLC and DND. DND has regionally and nationally appointed public affairs officers that maintain media relationships at their level. It is the responsibility of the local NLC branch and corps' Commanding Officers to ensure good relations with the local community and media.

Supervising and Administering Cadet Corps. The local NLC branch and corps' staff work collaboratively to ensure that there is adequate supervision and administration within the cadet corps.

Providing Reviewing Parties for Annual Ceremonial Reviews (ACRs). The NLC and DND work collaboratively to provide reviewing parties for corps' ACRs.

CONFIRMATION OF TEACHING POINT 2

QUESTIONS

- Q1. What are the responsibilities of the NLC?
- Q2. What are the responsibilities of DND?
- Q3. What is one responsibility of both the NLC and DND?

ANTICIPATED ANSWERS

- A1. The NLC is responsible for:
 - recruiting cadets;
 - recruiting CIC officers;
 - fundraising;
 - providing awards and medals;
 - providing corps training facilities;
 - organizing/conducting recreational programs;
 - providing funds for directed optional/optional training activities; and
 - providing equipment to cadet corps.

A2. DND is responsible for:

- training CIC officers;
- providing QSPs and IGs for cadet training;
- providing funds for mandatory training and support activities;
- developing policy regarding CIC officers, CIs and cadets;
- issuing equipment to cadet corps IAW with scales of issue;
- providing pay for CIC officers and CIs;
- selecting cadets for CSTCs; and
- providing facilities and staff for CSTCs.

A3. Both the NLC and DND are responsible for:

- forming or disbanding cadet corps;
- developing community and media relationships;
- supervising and administering cadet corps; and
- providing reviewing parties for Annual Ceremonial Reviews (ACRs).

Teaching Point 3

Conduct an Activity Where the Cadets Will Describe the Partnership Between the NLC and DND in Support of the CCM

Time: 10 min

Method: In-Class Activity

ACTIVITY

OBJECTIVE

The objective of this activity is to have the cadets describe the partnership between the NLC and DND in support of the CCM.

RESOURCES

- Flip chart paper,
- Responsibilities cards, and
- Tape.

ACTIVITY LAYOUT

1. Label three flip chart pages, each with one of the following titles:
 - (a) NLC Responsibilities,
 - (b) DND Responsibilities, and
 - (c) Shared Responsibilities.
2. Put the flip chart pages up on the wall.

3. Place the responsibilities cards face down on a table at the front of the room.

ACTIVITY INSTRUCTIONS

1. Divide the cadets into two teams.
2. Have a cadet from each team move to the front of the room and take a card from the top of the stack.
3. Provide the groups one minute to discuss where their responsibility belongs (NLC Responsibilities, DND Responsibilities or Shared).
4. Have the cadet place their card under the appropriate category.
5. Keep score for each team. Each correctly placed card is awarded one point.
6. Tally the final score when all the cards are placed on the flip chart pages.

SAFETY

N/A.

CONFIRMATION OF TEACHING POINT 3

The cadets' participation in the activity will serve as the confirmation of this TP.

END OF LESSON CONFIRMATION

The cadets' participation in the activity in TP 3 will serve as the confirmation of this lesson.

CONCLUSION

HOMEWORK/READING/PRACTICE

N/A.

METHOD OF EVALUATION

N/A.

CLOSING STATEMENT

Recognizing the partnership between the NLC and DND in support of the CCM is important because these two organizations work together to ensure the success of the CCM.

INSTRUCTOR NOTES/REMARKS

It is recommended that this EO be scheduled early in the training year.

REFERENCES

- A0-040 2005-113124 Director Cadets. (2005). *Memorandum of Understanding Between DND and the Leagues*. Ottawa, ON: Department of National Defence.
- C1-069 Navy League of Canada. (2002). *Guide for Local Branches: Part Two*. Ottawa, ON: Navy League of Canada.

C1-097 Navy League of Canada. (2008). *Scholarships & Awards*. Retrieved April 7, 2008, from <http://www.navyleague.ca/eng/seacadets/awards.asp>.

THIS PAGE INTENTIONALLY LEFT BLANK



ROYAL CANADIAN SEA CADETS

PHASE THREE

INSTRUCTIONAL GUIDE



SECTION 4

EO C307.04 – PARTICIPATE IN A PRESENTATION ON THE DUKE OF EDINBURGH AWARD PROGRAM

Total Time: 30 min

PREPARATION

PRE-LESSON INSTRUCTIONS

Resources needed for the delivery of this lesson are listed in the lesson specification located in A-CR-CCP-603/PG-001, Chapter 4. Specific uses for said resources are identified throughout the instructional guide within the TP for which they are required.

Review the lesson content and become familiar with the material prior to delivering the lesson.

Contact the local Duke of Edinburgh Award program division and gather presentation material about the Duke of Edinburgh Award program.

A member of the corps staff may present this lesson if a Duke of Edinburgh Award program representative is unavailable.

PRE-LESSON ASSIGNMENT

N/A.

APPROACH

An interactive lecture was chosen for this lesson to introduce, clarify, emphasize and summarize the objectives of the Duke of Edinburgh Award program.

INTRODUCTION

REVIEW

N/A.

OBJECTIVES

By the end of this lesson the cadet shall have participated in a presentation on the Duke of Edinburgh Award program.

IMPORTANCE

It is important for cadets to know all opportunities for growth available to them. The Duke of Edinburgh Award program is one opportunity that is widely available to cadets. By knowing what the program entails and what the rewards are, cadets will have a better understanding of the program and be able to decide if they wish to become a participant.

Teaching Point 1**Outline a Short History of the Award**

Time: 5 min

Method: Interactive Lecture



The material for this lesson will be gathered from the provincial office of the Duke of Edinburgh Award program. Videos, brochures and activities used to present the information can be found at www.dukeofed.org.

The program was founded in 1956 by His Royal Highness Prince Philip, The Duke of Edinburgh K.G. K.T. in London, England, as a means to encourage and motivate youth. The goal of the Duke of Edinburgh Award program is to encourage young people's participation in activities they already enjoy and to develop personal goals and encourage achievement based on individual effort and improvement.

The Duke of Edinburgh Award program is about personal challenge, and aims to encourage and stimulate:

1. self-reliance and self-discipline,
2. perseverance and determination,
3. initiative and creativity,
4. community involvement and social responsibility,
5. value orientation and value-oriented decision making,
6. the spirit of adventure,
7. fitness of body and mind,
8. vocational, cultural and family life skills, and
9. international understanding and awareness.

The award is a lapel pin or brooch, and an inscribed certificate of achievement. Upon completion of the Gold award, the individual will be presented the award by HRH Prince Philip.

More than 30 000 young Canadians are currently participating in the Duke of Edinburgh Award program; many within the Canadian Cadet Movement.

CONFIRMATION OF TEACHING POINT 1

QUESTIONS

- Q1. When was the Duke of Edinburgh Award program founded?
- Q2. What is the goal of the program?
- Q3. What does the program aim to encourage?

ANTICIPATED ANSWERS

- A1. The program was founded in 1956.
- A2. The goal of the program is to encourage young people's participation in activities they already enjoy and to develop personal goals and encourage achievement.

A3. The program aims to encourages:

- self-reliance and self-discipline,
- perseverance and determination,
- initiative and creativity,
- community involvement and social responsibility,
- value orientation and value-oriented decision making,
- the spirit of adventure,
- fitness of body and mind;
- vocational, cultural and family life skills, and
- international understanding and awareness.

Teaching Point 2

Describe the Different Levels of the Program

Time: 5 min

Method: Interactive Lecture

There are three levels within the Duke of Edinburgh Award program. Each successive level requires more commitment and becomes more demanding. The levels are Bronze, Silver and Gold. A young person may choose to participate at any time and any level, keeping in mind the prescribed age requirements.

Bronze. For youth over the age of 14. There is a minimum 6-month period of participation.

Silver. For youth over the age of 15. There is a minimum 12-month period of participation.

Gold. For youth over the age of 16. There is a minimum 18-month period of participation.

If a participant has completed a prior level, the period of participation is decreased by six months. (e.g., a cadet who has completed the Bronze level can complete the Silver level in six months).

CONFIRMATION OF TEACHING POINT 2

QUESTIONS

- Q1. What are the three levels of the program?
- Q2. What is the age requirement for the program?
- Q3. When can a person start the Gold level?

ANTICIPATED ANSWERS

- A1. The three levels of the program are Bronze, Silver and Gold.
- A2. The age requirement is a minimum of 14, although each subsequent level has an age minimum if a participant is just beginning the program.
- A3. The Gold level can be started at age 16.

Teaching Point 3**Explain the Five Sections of the Program**

Time: 5 min

Method: Interactive Lecture

The Award's activities are arranged into sections, and within each section there are many choices. There are five sections to the program. The four common sections are:

- service,
- adventurous journey,
- skills, and
- physical recreation.

At the Gold level, participants have to complete a residential project.

SERVICE

Service is a commitment to the needs of others without pay.

The goal of the service section is to encourage participants to realize that as members of a community, they have a responsibility to others and that their help is needed. By helping others, it is hoped that participants will find satisfaction sparking a commitment to community service for life.

ADVENTUROUS JOURNEY

The goal of the adventurous journey is to develop self-reliance by undertaking a journey of discovery. The adventurous journey encourages participants to develop an awareness of the natural environment, and the importance of protecting it.

The distance the cadet must travel and the duration of the journey varies for each level of the Award:

- Bronze – two days including one night away,
- Silver – three days including two nights away, and
- Gold – four days including three nights away.

The hours the cadet must spend on planned activities varies for each level:

- Bronze – an average of six hours per day,
- Silver – an average of seven hours per day, and
- Gold – an average of eight hours per day.

There are three types of journeys that can be undertaken:

- **Explorations.** A purpose with a trip. During this journey, participants must spend a minimum of 10 hours on journeying (moving without motorized assistance). The remainder of the time is spent on a special activity, (e.g., historic site exploration, or studying flora and fauna). Explorations must involve pre-journey research, on-site study, and a report on the findings.
- **Expeditions.** A trip with a purpose. An Expedition is a journey where participants stay at a different campsite each night. The required hours will be spent on journeying, navigating and route finding. This may include tasks related to the purpose of the expedition.
- **Adventurous Projects.** An Adventurous Project is a journey that does not fit the above descriptions exactly, or may be a combination of the two. This type of journey would be used by those with medical restrictions or who require more challenges.

All Explorations, Expeditions and Adventurous Projects must have a clearly defined and a preconceived purpose.

SKILLS

The goal of the skills section is to encourage the discovery of personal interests and development of social and practical skills. Participants are encouraged to take up interests within a range of practical, social and cultural activities. Skills can be either a progressive activity such as stamp collecting, playing a musical instrument, a study of a topic of personal interest such as money matters, or a definite task such as building something.

PHYSICAL RECREATION

The goal of the physical recreation section is to encourage participation in physical activity and provide an opportunity to improve performance and learn to appreciate physical recreation as an important component of a healthy lifestyle.

Participation in one or more physical activities for the required number of weeks:

- Bronze – 30 hours over a minimum of 15 weeks,
- Silver – 40 hours over a minimum of 20 weeks, and
- Gold – 50 hours over a minimum of 25 weeks.

Improvement of overall performance is essential for qualification in this section.

RESIDENTIAL PROJECT

The goal of the residential project is to develop social adaptability through involvement in a group setting. It involves participants in projects or training in the company of peers who are not their everyday companions.

The residential project is applied only at the Gold level, but can be completed at any time during award participation.

CONFIRMATION OF TEACHING POINT 3

QUESTIONS

- Q1. What are the five sections of the Duke of Edinburgh Award program?
- Q2. What is the goal of the skills section?
- Q3. When is the residential project completed?

ANTICIPATED ANSWERS

- A1. The five sections of the program are:
- service,
 - adventurous journey,
 - skills,
 - physical recreation, and
 - residential project.

- A2. The goal of the skills section is to encourage the discovery of personal interests and development of social and practical skills. Participants are encouraged to take up interests within a range of practical, social and cultural activities.
- A3. The residential project can be completed at any time during award participation.

Teaching Point 4
Describe the Relationship Between the Sea Cadet Program and the Duke of Edinburgh Award Program

Time: 5 min

Method: Interactive Lecture



This TP is designed to inform the cadet about the opportunities within the Award that correspond with activities within the Canadian Cadet Organization (CCO).

The CCO offers many opportunities for participants to work toward completing their respective level.

Within the Sea Cadet program, many opportunities exist for cadets to meet the requirements of the Award. Beyond the opportunities listed, many other opportunities may also exist, especially in very active cadet corps. Some examples of cadet activities that meet the Award requirements are:

- **Service**
 - participating in community service activities as part the Phase Training program;
 - participating in opportunities as a senior cadet when instructing junior cadets during the corps program;
 - helping with the corps newsletter;
 - volunteering to help the Royal Canadian Legion during poppy days; and
 - participating in a band demonstration where the corps does not receive funds in return.
- **Adventurous Journey**
 - participating in a tall ship deployment;
 - participating in overnight whaler/cutter exercises as part of CSTC training; and
 - participating in any other overnight exercise aboard a sailing vessel as part the corps' nautical training weekend or regional/national directed activities.
- **Skill**
 - participating in the sailing team;
 - participating in the corps band;
 - participating in the marksmanship team; and
 - participating in the drill team.
- **Physical Fitness**
 - participating in recreational sports at the corps;
 - participating in cadet fitness assessments; and

- participating in recreational sports as part of the CSTC Program.
- **Residential Project**
 - participation in any qualification at a CSTC.



CATO 13-19, *The Duke of Edinburgh's Award*, outlines the participation requirements of a youth as a member of the Sea Cadet program.

In addition to all the award requirements that are recognized as part of the Cadet Program, many activities cadets participate in outside the corps also count toward the award, such as:

- volunteer activities,
- extracurricular sports teams,
- school clubs, and
- hobbies.



Duke of Edinburgh Award pins may be worn on the cadet uniform in accordance with A-CR-005-001/AG-001, *Royal Canadian Sea Cadets Dress Instructions*.



After cadets have been informed of the Duke of Edinburgh Award program, and displayed interest in participation, discuss participation with the CO.

Contact the divisional office of the Duke of Edinburgh Award program. Contact information for the offices can be found at www.dukeofed.org.

After the Division office has been contacted:

1. Collect the registration fee from each cadet who wants to participate in the program.
2. If there are only a few cadets who wish to participate, register them as individuals.
3. If the corps will be participating as a whole, register as a group.

CONFIRMATION OF TEACHING POINT 4

QUESTIONS

- Q1. What activities at the corps can be completed as part of the service section of the award?
- Q2. What other activities within the Sea Cadet Program can be used for the skill section?
- Q3. When is the residential project completed?

ANTICIPATED ANSWERS

- A1. As part of the service section, the following can be completed at the home corps:

- participating in community service activities as part the Phase Training program;
- participating in opportunities as a senior cadet when instructing junior cadets during the corps program;
- helping with the corps newsletter;
- volunteering to help the Royal Canadian Legion during poppy days; and
- participating in a band demonstration where the corps does not receive funds in return.

A2. Participating in the cadet corps band, the marksmanship team, and the drill team may be used to complete the skill section.

A3. The residential project is completed with any qualification at a CSTC.

Teaching Point 5

Facilitate a Question and Answer Period

Time: 5 min

Method: Interactive Lecture



Allow cadets time to ask questions and discuss participation in the program.

CONFIRMATION OF TEACHING POINT 5

The cadets' participation in a question and answer period will serve as the confirmation of this TP.

END OF LESSON CONFIRMATION

The cadets' participation in the presentation on the Duke of Edinburgh Award program will serve as the confirmation of this lesson.

CONCLUSION

HOMEWORK/READING/PRACTICE

N/A.

METHOD OF EVALUATION

N/A.

CLOSING STATEMENT

The Duke of Edinburgh Award program is one of the largest award programs for youth across the world. Informing cadets about the program will encourage them to participate in the program. It will give them positive experiences to move toward in both the Cadet Program and in life.

INSTRUCTOR NOTES/REMARKS

Training aids should be determined by contacting the speaker prior to the presentation.

Cadets may participate in the Duke of Edinburgh Award program as an optional activity.

A member of the corps staff may present this lesson if a Duke of Edinburgh Award representative is unavailable.

REFERENCES

- C0-196 Duke of Edinburgh Award. (2008). *The Award*. Retrieved February 12, 2008, from <http://www.dukeofed.org/Award.htm>.
- C0-197 Duke of Edinburgh Award. (2007). *Participant's Record Book*. Markham, ON: Langstaff Reed Printing Ltd.

THIS PAGE INTENTIONALLY LEFT BLANK

PHASE THREE POS AND EOS

PO 301 – Citizenship Recognize the Purpose of Service Groups Within Canada	
M301.01	Discuss Community Service Groups
C301.01	Discuss the Three Branches of the Canadian Government
C301.02	Discuss Current Events
C301.03	Tour a Local Community Service Group
C301.04	Participate in a Presentation Given by a Guest Speaker From a Local Community Service Group
PO 302 – Community Service Perform Community Service	
M302.01	Perform Community Service
C102.01	Participate in a Ceremonial Parade
C102.02	Perform Community Service
PO 303 – Leadership Perform the Role of a Team Leader	
M303.01	Define the Role of a Team Leader
M303.02	Participate in a Mentoring Relationship
M303.03	Practice Self-Assessment
M303.04	Communicate as a Team Leader
M303.05	Supervise Cadets
M303.06	Solve Problems
M303.07	Lead Cadets Through a Leadership Assignment
C303.01	Lead Team-Building Activities
C303.02	Deliver a Presentation About a Leader
C203.01	Record Entries in a Reflective Journal
C203.02	Employ Problem Solving
C203.04	Participate in a Presentation Given by a Leader
C203.05	Participate in Trust-Building Activities
C203.06	Participate in Problem-Solving Activities
C103.03	Participate in Teambuilding Activities

PO 304 – Personal Fitness and Healthy Living Update Personal Activity Plan	
M304.01	Describe the Components of Physical Fitness
M304.02	Participate in the Cadet Fitness Assessment
M304.03	Update Personal Activity Plan
M304.04	Evaluate Personal Activity Plan
C304.01	Participate in the Cadet Fitness Assessment
C304.02	Evaluate Personal Activity Plan
C304.03	Describe Stress
C204.02	Develop a Personal Nutrition Plan
C104.01	Create Team Goals
PO 305 – Recreational Sports Participate in Recreational Sports	
M305.01	Participate in Organized Recreational Team Sports
C105.01	Participate in an Organized Sports Tabloid
C105.02	Participate in an Organized Intramural Sports Event
C105.03	Participate in an Orienteering Event
PO 306 – Air Rifle Marksmanship Fire the Cadet Air Rifle During Recreational Marksmanship	
M306.01	Participate in a Recreational Marksmanship Activity
C306.01	Identify Civilian Marksmanship Organizations
C306.02	Correct Marksmanship Error
C306.03	Fire the Cadet Air Rifle From the Standing Position
C206.01	Practice Holding Techniques
C206.02	Practice Aiming Techniques
C206.03	Practice Firing Techniques
C106.01	Participate in a Recreational Marksmanship Activity
PO 307 – General Cadet Knowledge Serve in a Sea Cadet Corps	
M307.01	Identify Phase Three Training Opportunities
M307.02	Identify Year Three CSTC Training Opportunities
M307.03	Recognize the Partnership Between the Navy League and DND in Support of the CCM

C307.01	Participate in a Presentation Given by a Guest Speaker From the Regional Cadet Support Unit (RCSU)
C307.02	Participate in a Presentation Given by the Cadet Liaison Officer (CLO)
C307.03	Participate in a Presentation Given by a Guest Speaker From the Navy League of Canada (NLC)
PO 308 – Drill Direct a Squad Prior to a Parade	
M308.01	Prepare a Squad for Parade
M308.02	Deliver Words of Command
C308.01	Execute Flag Party Drill
C308.02	Deliver Words of Command
C208.01	Practice Ceremonial Drill as a Review
C208.02	Execute Drill With Arms
PO 309 – Instructional Techniques Instruct a Lesson	
M309.01	Explain Principles of Instruction
M309.02	Identify Methods of Instruction
M309.03	Describe Effective Speaking Techniques
M309.04	Describe Questioning Techniques
M309.05	Select Appropriate Instructional Aids
M309.06	Plan a Lesson
M309.07	Instruct a 15-Minute Lesson
C309.01	Deliver a One-Minute Verbal Presentation
C309.02	Plan a Lesson
C309.03	Instruct a 15-Minute Lesson
C309.04	Identify Formations for Drill Instruction
C309.05	Plan a Drill Lesson
C309.06	Instruct a 15-Minute Drill Lesson
PO 311 – Summer Biathlon Participate in Competitive Summer Biathlon Activities	
C311.01	Practice Aiming and Firing the Cadet Air Rifle Following Physical Activity
C311.02	Participate in a Recreational Summer Biathlon Activity
C211.01	Identify Civilian Biathlon Opportunities

C211.02	Run on Alternate Terrain
C211.03	Fire the Cadet Air Rifle Using a Sling Following Physical Activity
C211.04	Participate in a Competitive Summer Biathlon Activity
C111.01	Participate in a Biathlon Briefing
C111.02	Run Wind Sprints
C111.03	Fire the Cadet Air Rifle Following Physical Activity
C111.04	Participate in a Recreational Summer Biathlon Activity
PO 320 – Canadian Navy and Maritime Community Describe Aspects of the Canadian Navy	
M320.01	Identify Classes of Canadian Naval Ships
M320.02	Describe the Domestic Role of the Canadian Forces (CF)
M320.03	Describe the Role of the CF in International Institutions
C320.01	Participate in a Discussion/Presentation on a Naval Commemorative Event
C320.02	Describe the Women’s Royal Canadian Naval Services
C320.03	Describe Canadian Naval Aviation
C220.01	Recognize the Role of the Merchant Navy
C220.02	Recognize Canada’s Role in the Battle of the Atlantic
C220.03	Recognize World War Two (WWII) Naval Activities
C120.01	Explore Canadian Naval Websites
C120.02	Identify Types of Civilian Vessels
C120.03	Explore Canadian Naval History
PO 321 – Ropework Rig a Lifting Device	
M321.01	Describe Safety Procedures for Operating Lifting Devices
M321.02	Rig Sheers
C321.01	Rig Sheers
C321.02	Rig a Standing Derrick
C321.03	Rig a Gyn
C321.04	Make a Monkey’s Fist
C321.05	Make a Turk’s Head
C221.01	Make a Back Splice
C221.02	Make an Eye Splice

C221.03	Make a Long Splice
C121.01	Whip the End of a Line Using West Country Whipping
C121.02	Whip the End of a Line Using a Sailmaker's Whipping
C121.03	Complete a Rolling Hitch
C121.04	Complete a Marlin Hitch
PO 322 – Small Craft Operations Attain a Pleasure Craft Operator Competency Card	
C322.01	Describe Acts, Codes and Regulations
C322.02	Describe Personal Safety
C322.03	Describe Vessel Safety
C322.04	Describe Navigation Safety
N/A	PCOC Written Test
PO 323 – Ship's Operations Serve in a Naval Environment	
M323.01	Perform Corps Duties
C323.01	Communicate Using Flags and Pennants
C323.02	Pipe Wakey Wakey
C323.03	Pipe Hands to Dinner
C223.01	Define Naval Terminology
C223.02	Pipe the Side
C123.01	Read the 24-Hour Clock
C123.02	Recite the Phonetic Alphabet
C123.03	Participate in a Semaphore Exercise
PO 324 – Sailing Sail a Sailboat IAW Canadian Yachting Association (CYA) White Sail Level Two	
M324.01	Prepare for a Sail Weekend
M324.02	Prepare for Sailing
M324.03	Tie a Hitch and a Bend
M324.04	Rig a Sailboat
M324.05	Dock a Sailboat
M324.06	Beach a Sailboat
M324.07	Right a Turtled Sailboat

M324.08	Adjust to Points of Sail
M324.09	Sail Upwind
M324.10	Sail Downwind
M324.11	Moor a Sailboat
PO 325 – Nautical Training Participate in a Nautical Training Weekend	
C225.01	Prepare for a Nautical Training Weekend
C225.02A	Perform Small Craft/Vessel Duties While Underway
C225.02B	Participate in a Nautical Activity

RESPONSIBILITIES CARDS

Recruiting cadets.	Recruiting CIC officers.
Fundraising.	Providing awards and medals.
Providing corps training facilities.	Organizing/conducting recreational programs.
Providing funds for directed optional/optional training activities.	Providing equipment to cadet corps.
Training CIC officers.	Providing QSPs and IGs for cadet training.

Providing funds for mandatory training and support activities.	Developing policy regarding CIC officers and CIs.
Issuing equipment to cadet corps IAW scales of issue.	Providing pay for CIC officers and CIs.
Selecting cadets for CSTCs.	Providing facilities and staff for CSTCs.
Forming or disbanding cadet corps.	Developing community and media relationships.
Supervising and administering cadet corps.	Providing reviewing parties for ACRs.

CHAPTER 8

PO 308 – DIRECT A SQUAD PRIOR TO A PARADE



COMMON TRAINING
PHASE THREE
INSTRUCTIONAL GUIDE



SECTION 1

EO M308.01 – PREPARE A SQUAD FOR PARADE

Total Time:

90 min

PREPARATION

PRE-LESSON INSTRUCTIONS

Resources needed for the delivery of this lesson are listed in the lesson specification located in A-CR-CCP-603/PG-001, Chapter 4. Specific uses for said resources are identified throughout the instructional guide within the TP for which they are required.

Review the lesson content and become familiar with the material prior to delivering the lesson.

Photocopy the drill sequence handout at Annex A and the aide-mémoire card at Annex B as required.

PRE-LESSON ASSIGNMENT

N/A.

APPROACH

An interactive lecture was chosen for TP 1 to introduce drill theory to the cadet.

Demonstration and performance was chosen for TP 2 as it allows the instructor to explain and demonstrate preparing a squad for a parade while providing an opportunity for the cadets to practice the skill under supervision.

INTRODUCTION

REVIEW

N/A.

OBJECTIVES

By the end of this lesson the cadet shall be expected to prepare a squad for parade.

IMPORTANCE

It is important for cadets to be able to prepare a squad for parade as they will be in placed in a team leader role and will need to know the formations and locations of all members on the parade square.

Teaching Point 1

Explain Drill Theory

Time: 20 min

Method: Interactive Lecture

SQUAD FORMATIONS



The term squad is a generic name for a group of cadets. This term can be interchanged with platoon, flight, division or any other applicable elemental or regimental term.



The squad formation should be implemented when there is a parade strength of less than 32 cadets.

Squad formations are essential to maintain control and ensure uniformity. The instructor shall determine the formation to be used, based on the number of cadets present, to include:

Single Rank. A single rank shall be formed when there are five or fewer cadets.

Two Ranks. Two ranks shall be formed when there are six to nine cadets.

Three Ranks. Three ranks shall be formed when there are 10 or more cadets.

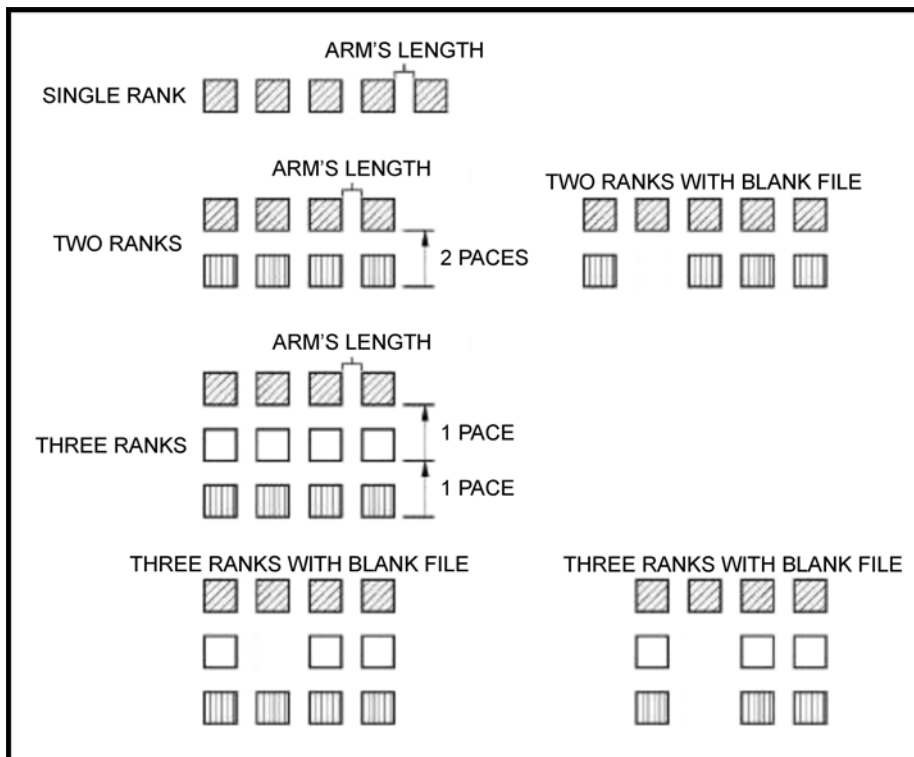





A-PD-201-000/PT-000 (p. 2-2)

Figure 8-1-1 Squad Formations



When there are not enough cadets to form complete files, a file shall be left blank (as illustrated in Figure 8-1-1). The file blank shall be the second file from the left.

In two ranks, this blank file is without a rear rank cadet, and in three ranks, this blank file is without a centre and/or rear rank cadet.

The symbol for the Coxswain (Coxn) is:	
The symbol for the Regulating Petty Officer (RPO) is:	
The symbol for Divisional Petty Officer (DPO) is:	
The symbol for the Assistant DPO (ADPO) is:	
The symbol Division Marker (Marker) is:	

Director Cadets 3, 2008, Ottawa, ON: Department of National Defence

Figure 8-1-2 Parade Appointment Symbols

COMPANY FORMATIONS

A company consists of two or more divisions. The aim of company drill is to manoeuvre the company as one under the command of a Coxn and assistance of a CPO2. Other senior non-commissioned officers (NCOs) not directly involved with the divisions, shall be supernumeraries and form supernumerary ranks as directed by the Coxn. There shall be seven paces between divisions for all formations.



When space is limited, intervals and distances between divisions may be decreased.

There are three company formations used by cadets, to include:

Line. A company is formed in line when divisions are formed up side-by-side, seven paces apart and aligned facing the front, with parade appointments located in the front and rear of the formation (as illustrated in Figure 8-1-3).



To be formed in threes and in line is the common formation when a squad forms up.

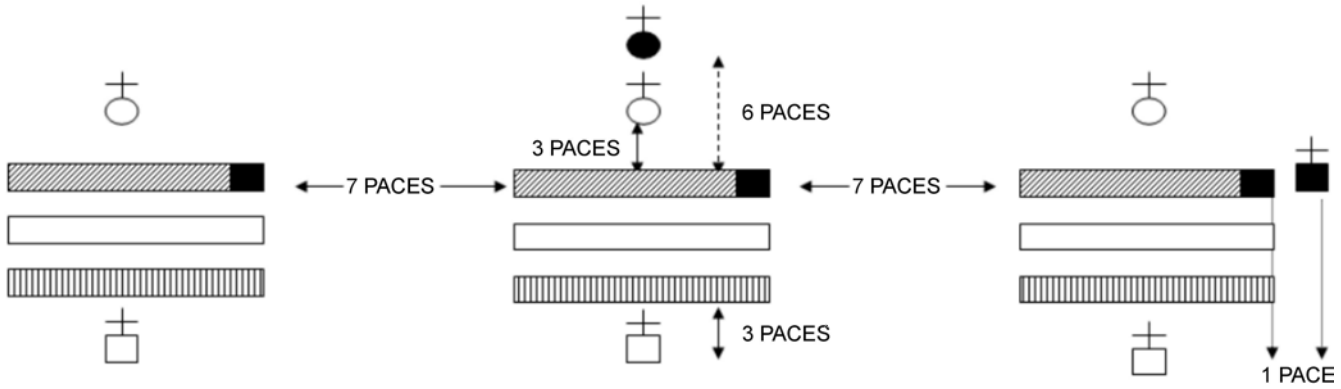

Director Cadets 3, 2008, Ottawa, ON: Department of National Defence

Figure 8-1-3 Company in Line

Column of Threes. A company is formed in column of threes when divisions are turned to the right or left of the front, with parade appointments located in their positions in the front and rear of the formation and turned to the right or left with the division (as illustrated in Figure 8-1-4).

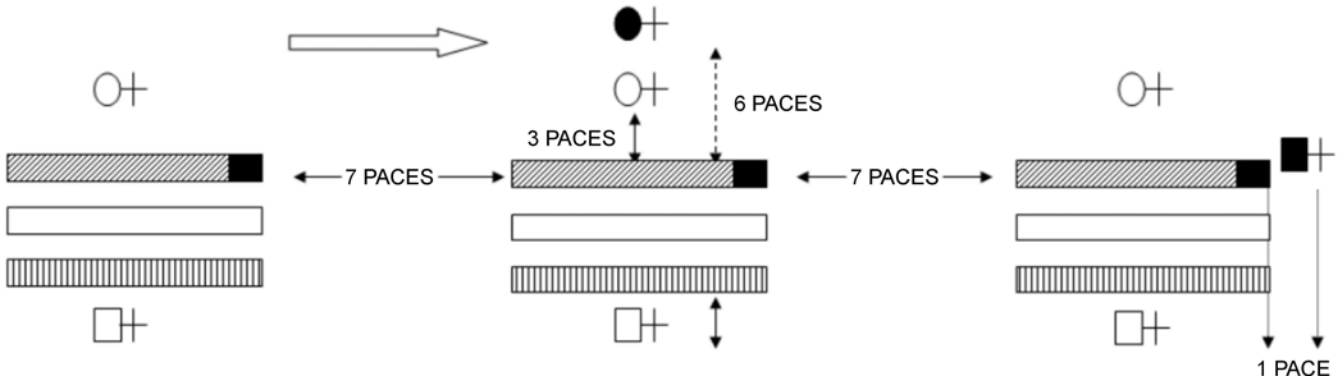

Director Cadets 3, 2008, Ottawa, ON: Department of National Defence

Figure 8-1-4 Company in Column of Threes

Column of Route. A company is formed in column of route when divisions are turned to the right or left, with parade appointments positioned to lead or follow the formation (as illustrated in Figure 8-1-5).

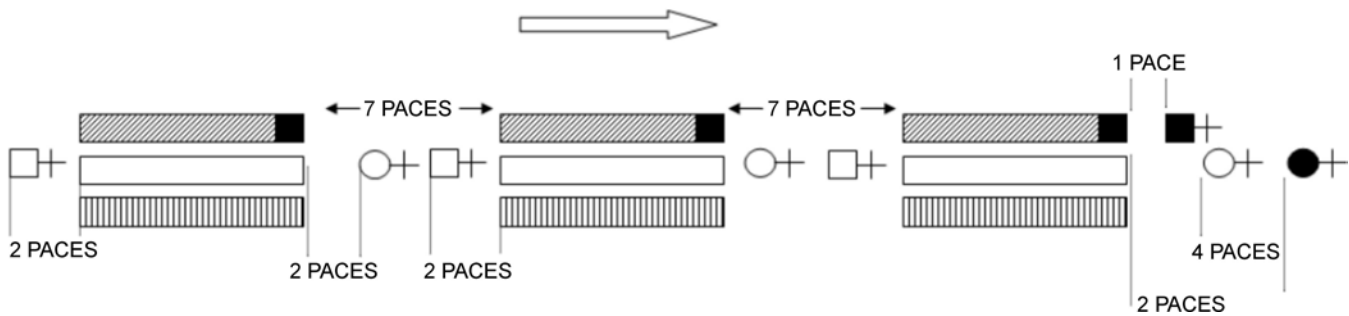

Director Cadets 3, 2008, Ottawa, ON: Department of National Defence

Figure 8-1-5 Company in Column of Route

LOCATION OF PARADE APPOINTMENTS

The unique nature of the cadet unit allows for the adjustment of parade positions to be filled by cadet POs and cadet senior NCOs. The following parade positions are normally filled by cadets when conducting a formal parade:

Coxswain (Coxn). With a company in line or in column of threes, the Coxn is centred three paces in front of the line of division commanders, facing the same direction as the divisions except when addressing the company. With a company in column of route, the Coxn is centred four paces in front of the leading division.

Chief Petty Officer Second Class (CPO2). The CPO2 is an appointment that is seldom assigned in a cadet corps. If applicable, the CPO2 is centred three paces in front of the second single file from the right flank of the company and in line with the CPO2.

Divisional Petty Officer (DPO). With a company in line or in column of threes, the DPO is centred three paces in front of the division. With a company in column of route, the DPO is centred two paces in front of their division.

Assistant Divisional Petty Officer (ADPO). With a company in line or in column of threes, the ADPO is centred three paces in rear of the division. With a company in column of route, the ADPO is centred two paces in the rear of their division.



Prior to handing over to the DPO, the ADPO will be centred three paces in front of the platoon. After handing over to the DPO, the ADPO assumes their position as stated above.

Division Marker (Marker). The marker is the individual placed in the first rank of the first file to indicate the position which a body of cadets will occupy when covering and falling in. In all squad and company formations, the marker remains in the same location.

CONFIRMATION OF TEACHING POINT 1

QUESTIONS

- Q1. What are the three squad formations?
- Q2. What are the three company formations?
- Q3. Where is the DPO located when the formation is in line?

ANTICIPATED ANSWERS

- A1. The three squad formations are:
- single rank,
 - two ranks, and
 - three ranks.
- A2. The three company formations are:
- line,
 - column of threes, and
 - column of route.
- A3. The DPO is located three paces in front and centre of the division.

Teaching Point 2

Explain, Demonstrate and Have the Cadet Assume the Role of a Team Leader in Preparing a Squad for Parade

Time: 60 min

Method: Demonstration and Performance

When preparing a squad for parade, the team leader, acting as the ADPO, is responsible to ensure the squad is ready for parade by:

1. having the squad on the parade square by falling in a squad;
2. knowing who is present or absent by calling the roll;
3. ensuring uniformity of the squad by sizing in single rank and reforming threes (twos);
4. ensuring the squad is properly spaced by dressing a squad;
5. ensuring all cadets are well turned out by inspecting a squad; and
6. continuing with the parade by handing over the squad.



The purpose of this TP is to aid the cadets' comprehension of the process they have executed during Phase One and Two when preparing for parade during a training sessions.



If the time allotted is not sufficient for all cadets to assume the role of a team leader in preparing a squad for parade, additional time during colours and sunset shall be used to provide all cadets the opportunity for performance.

ACTIVITY

OBJECTIVE

The objective of this activity is to confirm the ability of a Phase Three cadet, as a team leader, to assume the position of a DPO and prepare a squad for parade.

RESOURCES

N/A.

ACTIVITY LAYOUT

N/A.

ACTIVITY INSTRUCTIONS

Distribute a copy of the drill sequence handout at Annex A and an aide-mémoire card at Annex B to each cadet.

This activity will be conducted IAW Annex A.



For this activity, it is recommended that instruction take the following format:

1. Explain and demonstrate the complete skill while cadets observe.
2. Explain and demonstrate each step required to complete the skill.
3. Select a cadet to assume the role of team leader and practice the complete skill.

Note: Assistant instructors may be employed for demonstration purposes.

SAFETY

N/A.

CONFIRMATION OF TEACHING POINT 2

The cadets' participation in the activity will serve as the confirmation of this TP.

END OF LESSON CONFIRMATION

The cadets' participation in preparing a squad for parade will serve as the confirmation of this lesson.

CONCLUSION

HOMEWORK/READING/PRACTICE

N/A.

METHOD OF EVALUATION

This EO is assessed IAW A-CR-CCP-603/PG-001, Chapter 3, Annex B, Appendix 2 (308 PC).

CLOSING STATEMENT

When preparing a squad for parade with confidence and determination, it will affect how cadets respond to the orders given. Delivering words of command can allow a squad to move as a team in an organized and efficient manner as all members learn to work together.

INSTRUCTOR NOTES/REMARKS

Cadets shall perform these skills and be given feedback during weekly colours and sunset parades, and ceremonial parades.

Assistant instructors may be required for this lesson.

REFERENCES

A0-002 A-PD-201-000/PT-000 Director History and Heritage 3-2. (2005). *The Canadian Forces Manual of Drill and Ceremonial*. Ottawa, ON: The Department of National Defence.

THIS PAGE INTENTIONALLY LEFT BLANK



COMMON TRAINING
PHASE THREE
INSTRUCTIONAL GUIDE



SECTION 2
EO M308.02 – DELIVER WORDS OF COMMAND

Total Time:

30 min

PREPARATION

PRE-LESSON INSTRUCTIONS

Resources needed for the delivery of this lesson are listed in the lesson specification located in A-CR-CCP-603/PG-001, Chapter 4. Specific uses for said resources are identified throughout the instructional guide within the TP for which they are required.

Review the lesson content and become familiar with the material prior to delivering the lesson.

Photocopy, cut out, fold and laminate the aide-mémoire cards with the words of command located at Annex A for each cadet.

PRE-LESSON ASSIGNMENT

N/A.

APPROACH

An interactive lecture was chosen for TP 1 to orient the cadets to the parts of a command and to generate interest.

Demonstration was chosen for TP 2 as it allows the instructor to demonstrate the voice techniques the cadets are expected to acquire.

INTRODUCTION

REVIEW

N/A.

OBJECTIVES

By the end of this lesson the cadet shall be expected to deliver words of command.

IMPORTANCE

It is important for cadets to know how to deliver words of command. Words of command that are delivered in a clear and concise manner, with confidence and determination, will affect how cadets respond to orders. Words of command are required to move a division in an organized and efficient manner.

Teaching Point 1**Explain the Parts of a Command**

Time: 10 min

Method: Interactive Lecture

CAUTIONARY COMMAND

A cautionary command shall be given at the beginning of every command to warn the squad that a movement will be performed. It includes additional instructions to the command such as “advance” or “retire”.



The direction of the movements are indicated based on the initial front rank.

The additional instructions are based on the direction a squad falls in (as illustrated in Figure 8-2-1). In general:

- **Advance.** Indicates a turn or movement in the direction of the front rank (is used whenever turning into line).
- **Retire.** Indicates a turn or movement in the direction of the rear rank (is used whenever turning into line).
- **Move to the Right/Left.** Indicates a turn or movement in the direction of the indicated flank (e.g., the right/left markers).

EXECUTIVE COMMAND

An executive command is to signal that the movement is to be carried out.

When written, a dash shall separate the cautionary command from the executive command.

The following are examples of words of command. In these examples, the word “TURN” indicates the executive command.

- “SQUAD RETIRE, RIGHT—TURN,”
- “SQUAD ADVANCE, LEFT—TURN,” and
- “SQUAD MOVE TO THE RIGHT IN COLUMN OF ROUTE, RIGHT—TURN.”

On the march, the cautionary command should be drawn out over at least two paces of quick time and the interval between the cautionary and executive commands should be two paces.

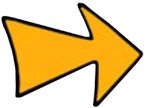

The order, “As You Were”, should only be given when another word of command cannot be given to have a squad adopt a previous position or to cancel an incorrect order before it has been completed.

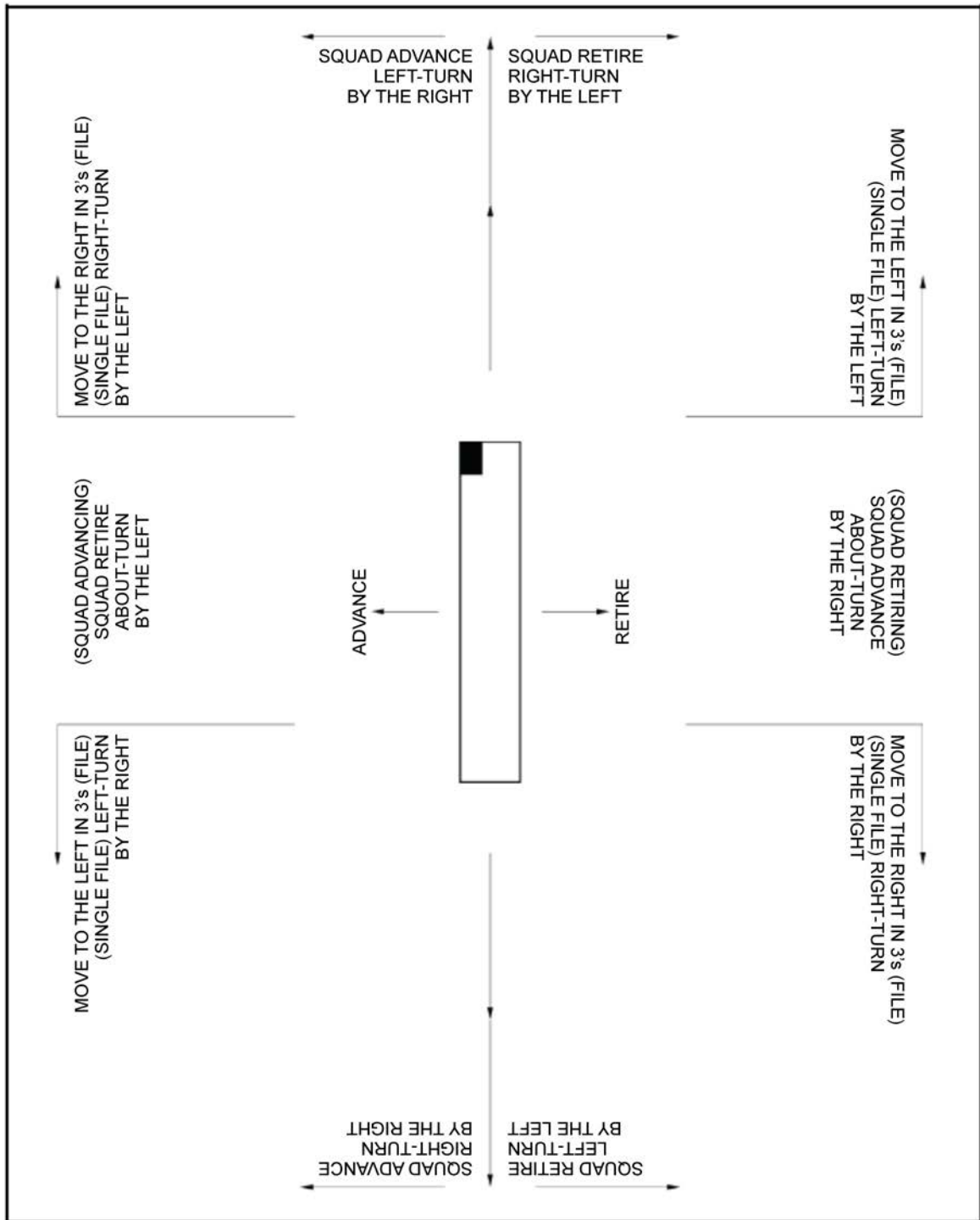

A-PD-201-000/PT-000 (p. 3-4)

Figure 8-2-1 Advance/Retire and Directing Flanks

CONFIRMATION OF TEACHING POINT 1

QUESTIONS

- Q1. Why are cautionary commands given?
- Q2. What is the purpose of the executive command?
- Q3. When commands are written, what is the purpose of the dash?

ANTICIPATED ANSWERS

- A1. To warn the squad that a movement will be performed.
- A2. To signal that the movement is to be carried out.
- A3. To separate the cautionary from the executive command.

Teaching Point 2

Demonstrate and Explain the Requirements for a Well-Delivered Command

Time: 15 min

Method: Demonstration



As each point is discussed, give an example of a command being delivered correctly and incorrectly, using the specified technique.

VOICE

The voice used to deliver commands has a strong effect on how others will respond. The following points should be considered:

Volume. The volume used to deliver a command is very important in drill. Often, commands must be presented to a group over a band or over other cadets giving commands to another group. The volume should be adjusted based on the number of individuals, the distance the command must carry and whether there is a band or not.

Projection. The projection of the voice is its ability to reach a desired distance. Erect posture, proper breathing, a relaxed throat and an open mouth will help a voice project.

Distinctness. How clearly and distinctly a command is pronounced will affect how others respond. If a command is not clear and distinct some cadets may not understand the command and perform the wrong movement. Clear enunciation and pronunciation of commands is key in distinctness.

Inflection. Inflection is the change in pitch of the voice. The cautionary command is usually started with a pitch near the level of the normal speaking voice and rising toward the end. The executive command should not have any change in inflection but should be delivered with a higher pitch than the cautionary command.

Snap. The snap of a command is the quality that demands an immediate response. It expresses the confidence and decisiveness of the commander.

ACCURACY

Commands must be given with accuracy at all times. Proper use of cautionary commands will alert the cadets to what is coming. The executive command will signal the cadets that the movement is to be carried out. When delivering executive commands on the march, it is important that it be delivered on the correct foot.

CONFIDENCE

All words of command must be given with confidence. This portrays that it is an order that must be promptly and smartly obeyed. A command delivered with confidence will help build a sense of security in the commander from the members of the squad.

CORRECT POSTURE

Poor posture restricts the ability to breathe deeply as it restricts the movement of the diaphragm. Maintaining good posture will allow a cadet to breathe deeply allowing the command to come deep from the diaphragm instead of from the throat causing less strain on the throat and allowing the command to be given with more volume.

BREATHING CONTROL

Breathe deeply and relax the muscles in the neck and vocal cords in order to give the voice more control and a higher volume. This will allow the voice to come from deep in the diaphragm instead of higher in the throat.

CONFIRMATION OF TEACHING POINT 2

QUESTIONS

- Q1. If a command is not pronounced clearly and distinctly, what affect may it have on the squad being commanded?
- Q2. Why should commands be delivered with confidence?
- Q3. How does poor posture affect delivering commands?

ANTICIPATED ANSWERS

- A1. Cadets may not understand the command and perform the wrong movement.
- A2. It portrays that it is an order that must be promptly and smartly obeyed.
- A3. It restricts the ability to breathe deeply, restricting the movement of the diaphragm, which will cause commands to come from the throat.

END OF LESSON CONFIRMATION

QUESTIONS

- Q1. What order is given to cancel an incorrect order before it has been completed?
- Q2. What are the five points of voice to be considered for a well-delivered command?
- Q3. What gives the voice more control and a higher volume?

ANTICIPATED ANSWERS

- A1. The order, "As You Were".

A2. Volume, projection, distinction, inflection and snap.

A3. Breathing deeply and relaxing the muscles in the neck and vocal cords.

CONCLUSION

HOMEWORK/READING/PRACTICE

N/A.

METHOD OF EVALUATION

N/A.

CLOSING STATEMENT

When words of command are delivered in a clear and concise manner and with confidence and determination, it will affect how cadets respond to the order. Delivering words of command can allow a division to move as a team in an organized and efficient manner as all members learn to work together.

INSTRUCTOR NOTES/REMARKS

Cadets shall be provided the opportunity to deliver words of command and be given feedback during weekly colours and sunset parades, and ceremonial parades.

Additional time for this EO is available in EO C308.02 (Deliver Words of Command, Section 4).

REFERENCES

- A0-002 A-PD-201-000/PT-000 Director History and Heritage 3-2. (2005). *The Canadian Forces Manual of Drill and Ceremonial*. Ottawa, ON: Department of National Defence.
- C0-022 (ISBN 0-02-864207-4) Cole, K. (2002). *The Complete Idiot's Guide to Clear Communication*. Indianapolis, IN: Alpha Books.
- C0-241 Optimal Breathing. (2007). *Posture and Breathing*. Retrieved February 12, 2008, from <http://breathing.com/articles/posture.htm>.
- C0-269 AFMAN 36-2203 Department of the Air Force. (1996). *Drill and Ceremonies*. Lackland, AFB, TX: Secretary of the Air Force.



COMMON TRAINING
PHASE THREE
INSTRUCTIONAL GUIDE



SECTION 3
EO C308.01 – EXECUTE FLAG DRILL

Total Time:

180 min

PREPARATION

PRE-LESSON INSTRUCTIONS

Resources needed for the delivery of this lesson are listed in the lesson specification located in A-CR-CCP-603/PG-001, Chapter 4. Specific uses for said resources are identified throughout the instructional guide within the TP for which they are required.

Review the lesson content and become familiar with the material prior to delivering the lesson.

For further direction and information on cadet flags and banners, refer to CATO 12-05, *Cadet Flags and Banners*, Paragraphs 1. to 9.

PRE-LESSON ASSIGNMENT

N/A.

APPROACH

An interactive lecture was chosen for TP 1 to present basic background material on flags and flag parties.

Demonstration and performance was chosen for TPs 2–6 as it allows the instructor to demonstrate and explain the skills the cadets are expected to acquire while providing an opportunity for the cadets to practice flag drill under supervision.

INTRODUCTION

REVIEW

N/A.

OBJECTIVES

By the end of this lesson the cadet, as a member of a flag party, shall have executed flag drill.

IMPORTANCE

It is important for cadets to execute flag drill so they are able to take part in ceremonies and parades as members of the flag party at the corps, cadet summer training centre (CSTC) and other community events as

required. Colours and flags have many meanings and are symbols of such things as achievements, nationality and identity. It is considered an honour to be a member of the flag party.

Teaching Point 1

Explain Details of Flags, the Pike, the Colour Carrying Belt and the Composition of a Flag Party

Time: 10 min

Method: Interactive Lecture

FLAGS

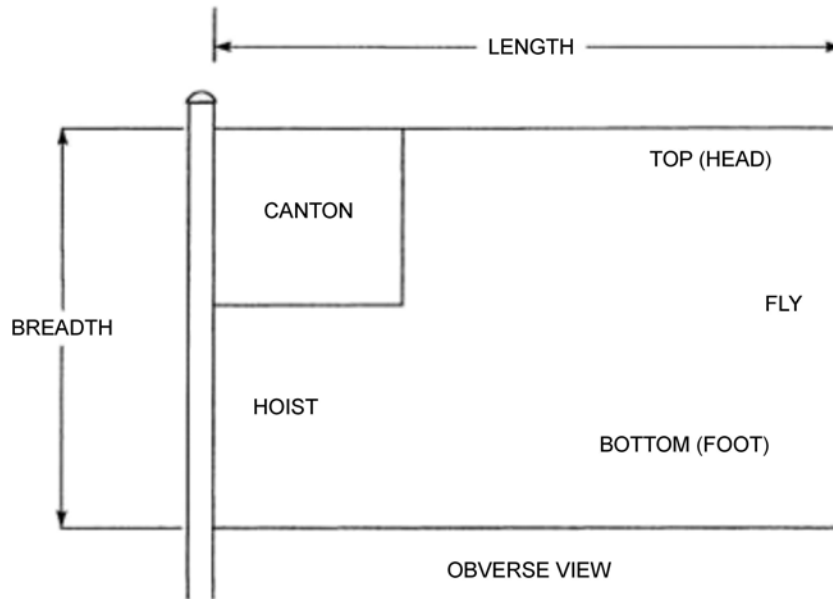

A-AD-200-000/AG-000, *The Honours, Flags and Heritage Structure of the Canadian Forces* (p. 4-1-8)

Figure 8-3-1 Details of a Flag

Flags. As a generic term (including colours), flags are pieces of bunting or other material, attachable to a pike, staff or halyard, and used as a means of identification or for signalling.

Canton. The upper half of the hoist. It is also called the First Quarter and sometimes the Upper Hoist. The canton is considered the place of honour on a flag.

Hoist. The half of the flag nearest to the halyard.

Halyard. The rope that raises or lowers a flag.

Fly. The half of the flag furthest from the halyard.

Staff (Flagstaff). A pole on which a flag is mounted for display.



Colours are consecrated ceremonial flags carried to mark the identity of Canadian Forces (CF) formations and units. They belong to a separate class and are not paraded with other flags. Cadet flags are not consecrated (made sacred and devoted to service by the Chaplain General as symbols of honour and duty), therefore shall not be referred to as colours.

Commanding Officers of cadet corps and CSTCs shall ensure that flags and banners are not referred to as colours, adorned with honours or consecrated and not issued at public expense.

Flags are used to identify individuals and groups. Many flags which originated as the insignia of individuals gradually came to represent the state or agencies within the state.

Authorized Flags and Banners

The following is a list of flags and banners that may be carried on parade by cadet units:

1. the Royal Canadian Sea Cadets Ensign,
2. the Royal Canadian Army Cadets Flag,
3. the Royal Canadian Air Cadets Ensign, and
4. the Royal Canadian Air Cadets Squadron Banner.

The following is a list of flags and banners that should only be carried on ceremonial parades to indicate a cadet formation:

1. the Royal Canadian Army Cadets Banner,
2. the Royal Canadian Army Cadets Trumpet Banner,
3. the Royal Canadian Army Cadets Pipe Banner,
4. the Royal Canadian Air Cadets Banner, and
5. the Royal Canadian Air Cadets Pipe Banner.

THE PIKE

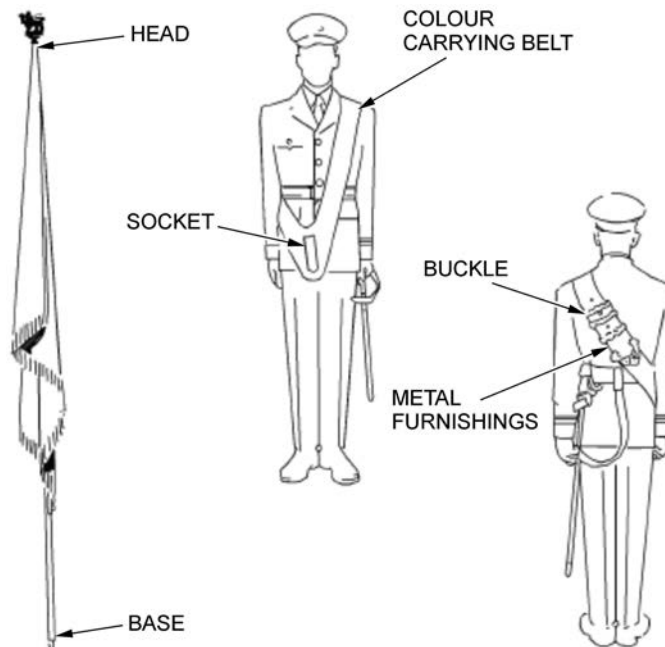

A-PD-201-000/PT-000 (p. 8-2-3)

Figure 8-3-2 Details of the Pike and Colour Carrying Belt

Pike. A pole on which colours or other flags are mounted for carrying or displaying.

Pike Head. The decorative ornament (finial) on the top of a pike, staff or pole.

COLOUR CARRYING BELT

The colour carrying belt is worn over the left shoulder by members of the flag party carrying flags. The socket is the “pocket” where the pike base is placed while the flag is in the carry position.

COMPOSITION OF A FLAG PARTY

LEGEND

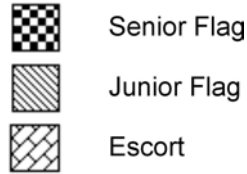

Director Cadets 3, 2008, Ottawa, ON: Department of National Defence

Figure 8-3-3 Flag Party Legend

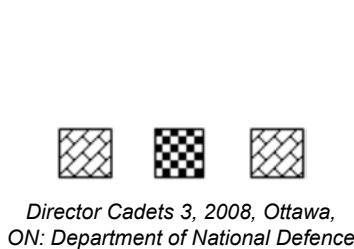

Figure 8-3-4 Flag Party for One Flag

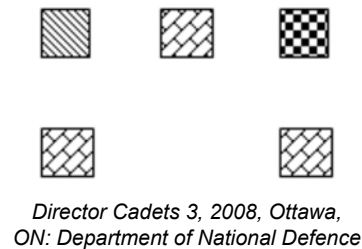

Figure 8-3-5 Flag Party for Two Flags

The composition of a flag party carrying one flag (as illustrated in Figure 8-3-3) consists of the flag party commander (cadet carrying the flag) and two escorts (cadets on either side of the flag).

The composition of a flag party carrying two flags (as illustrated in Figure 8-3-4) consists of one senior escort (cadet between the flags), the flag party commander and one flag bearer (cadets carrying the flags) and two senior NCOs (cadets directly behind the flags).

The flag party commander and/or flag bearer is appointed to carry, handle and protect the flags.

The senior escort and/or escort are appointed to safeguard the flags. They remain with the flags and may or may not carry drill-purpose rifles.



When a flag party carries the national flag and either the CF Ensign or a command flag, the national flag occupies the position of honour on the right (on the left from the spectators view) and is normally carried by a senior cadet.

Normally, the national flag does not have an escort. It may be given an escort with a drill-purpose rifle if the cadets on parade are carrying drill-purpose rifles.

CONFIRMATION OF TEACHING POINT 1

QUESTIONS

Q1. What is a pike?

Q2. Over which shoulder is the colour carrying belt worn?

Q3. How many members are in a flag party with only one flag?

ANTICIPATED ANSWERS

A1. A pike is a pole on which colours or other flags are mounted for carrying or displaying.

A2. The colour carrying belt is worn over the left shoulder.

A3. There are three members in a flag party with only one flag: the flag party commander and two escorts.

Teaching Point 2

Demonstrate, Explain and Have the Cadets Practice Adopting the Order, Stand at Ease From the Order, Stand Easy From the Stand at Ease, Stand at Ease From the Stand Easy and Order From the Stand at Ease With a Flag

Time: 15 min

Method: Demonstration and Performance



Develop and use a vocabulary of short, concise words to impress on the cadets that the movements must be performed smartly. For example, the words “crack”, “drive”, “seize” and “grasp” suggest the degree of smartness required. Profanity or personal sarcasm shall never be used.

Proper drill movements shall be combined with a professional demeanour throughout the period of instruction.

Check for faults and correct them immediately as they occur.



Each TP is to be conducted as follows:

1. Have the cadets fall in, in an effective squad formation (e.g., hollow square, semi-circle or single rank).
2. Demonstrate and explain each movement, as time allows.
3. Give the cadets time to practice each movement on their own.
4. After all movements have been demonstrated and practiced, deliver commands and have all the cadets perform them as a squad.



Capitalization indicates the words of command for each movement.

Cadence is to be maintained while completing these movements.

THE ORDER (ATTENTION)



The position for the Order is the same as Attention.



A-PD-201-000/PT-000 (p. 8-3-2)

Figure 8-3-6 The Order (Attention)

To assume the position of the order (attention), the cadets shall:

1. Stand with heels together and in line, with the feet turned out to form an angle of 30 degrees.
2. Maintain balance and distribute weight evenly on both feet.
3. Keep the shoulders squared and to the front.
4. Hold the head erect with the neck touching the back of the collar, eyes steady, looking directly to the front.
5. Hold the pike vertical in the right hand, along the right side.
6. Keep the base of the pike on the ground at the right foot in line with the small toe.
7. Hold the pike and flag with an all-round grasp with the right hand, with the back of the hand pointed outwards at the point of the pike where the lowest corner of the flag hangs.
8. Ensure the flag hangs naturally down the pike and is not pulled taut.
9. Keep the right elbow at the side.
10. Hold the left arm at the position of attention.

STAND AT EASE FROM THE ORDER

A-PD-201-000/PT-000 (p. 8-3-2)

Figure 8-3-7 Stand at Ease

On the command, STAND AT—EASE, the cadets shall:

1. bend the left knee and place the left foot smartly on the ground 25 cm (approximately 10 inches) to the left;
2. maintain the left arm in the position of attention; and
3. maintain the pike and flag in the position of the order.



Timing for this movement is one.

STAND EASY FROM STAND AT EASE

On the command, STAND—EASY, the cadets shall:

1. maintain the feet at the position of stand at ease;
2. keep the left arm at the side; and
3. relax the body.



Timing for this movement is one.

STAND AT EASE FROM STAND EASY

On the command, SQUAD, the cadets shall resume the position of stand at ease.



Timing for this movement is one.

ORDER FROM STAND AT EASE

On the command, ATTEN—TION, the cadets shall:

1. bend the left knee and bring the left foot to the position of attention, keeping the left arm at the side; and
2. maintain the pike and flag in the position of the order.



Timing for this movement is one.

CONFIRMATION OF TEACHING POINT 2

The cadets' practicing of the order, stand at ease and stand easy, with a flag, will serve as the confirmation of this TP.

Teaching Point 3**Demonstrate, Explain and Have the Cadets Practice Adopting the Carry From the Order, Order From the Carry, Let Fly From the Carry and Catch the Flag From the Let Fly**

Time: 25 min

Method: Demonstration and Performance

CARRY FROM THE ORDER*A-PD-201-000/PT-000 (p. 8-3-4)*

Figure 8-3-8 Carry From the Order

On the command, CARRY—FLAGS, the cadets shall:

1. on the first movement:
 - (a) with the right hand, carry the flag to a vertical position in front of the centre of the body, keeping the right forearm along the side of the pike, and keeping the base of the pike just over the socket of the carrying belt; and
 - (b) simultaneously, bring the left hand to the socket and guide in the base of the pike; and
2. on the second movement:
 - (a) cut the left hand to the side in the position of attention; and
 - (b) simultaneously, bring the right forearm parallel to the ground so that upon completion of the movement, the right hand is opposite the mouth with the back of the right hand facing out, the wrist straight and the forearm parallel to the ground.

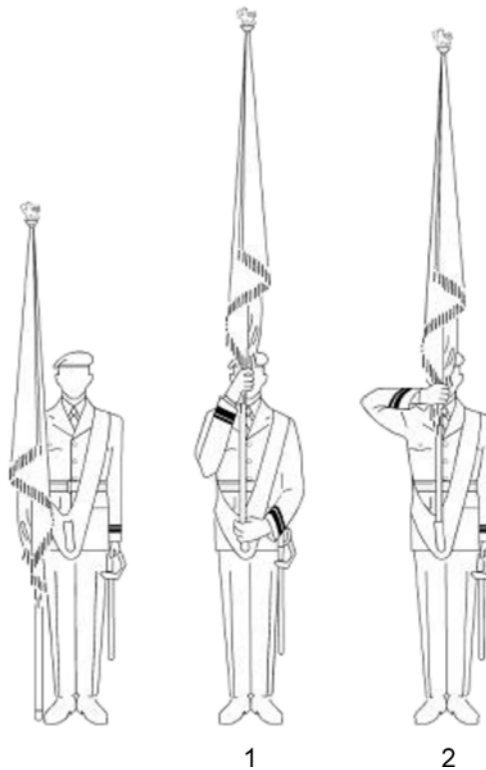

Timing for this movement is one-two-three, one.

ORDER FROM THE CARRY

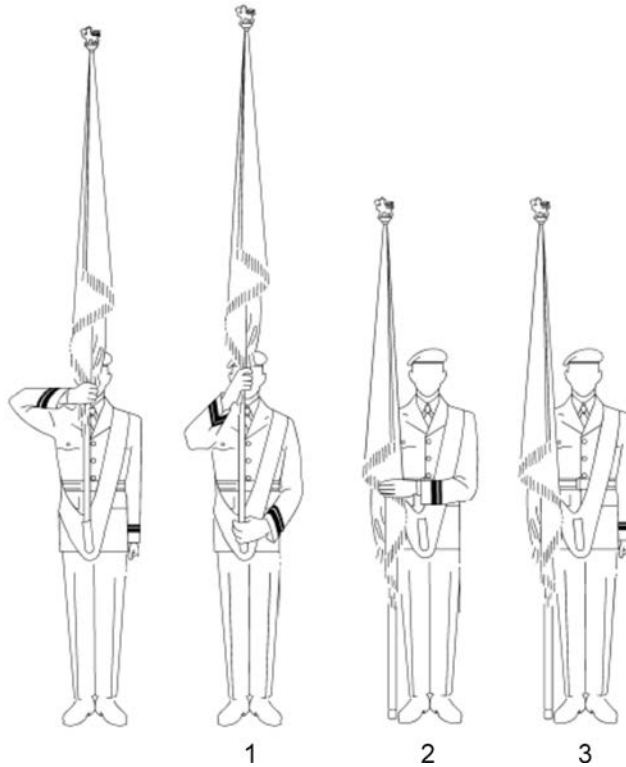

A-PD-201-000/PT-000 (p. 8-3-6)

Figure 8-3-9 Order From the Carry

On the command, ORDER—FLAGS, the cadets shall:

1. on the first movement:
 - (a) bring the right forearm from a horizontal to a vertical position along the pike and with the right hand, raise the pike clear of the socket of the carrying belt; and
 - (b) simultaneously, bring the left hand to the socket to steady the pike and the carrying belt; and
2. on the second movement:
 - (a) carry the flag with the right hand to the position of the order; and
 - (b) simultaneously, move the left hand across the body to steady the pike with the forearm parallel to the ground, the back of the hand facing out, and the fingers of the left hand together, extended and pointing to the right; and
3. on the third movement, cut the left hand to the side in the position of attention.



Timing for this movement is one-two-three, one-two-three, one.

LET FLY FROM THE CARRY

Let fly is used either as a salute to dignitaries or to allow for the identification of the flag.



A-PD-201-000/PT-000 (p. 8-3-17)

Figure 8-3-10 Let Fly From the Carry

On the command LET FLY THE—FLAG(S), the cadets shall:

1. maintain the grip of the pike; and
2. simultaneously release the flag with a downward movement of the right hand.

This drill movement is also used on the commands:

- GENERAL SALUTE—SALUTE; and
- EYES—RIGHT during a march past (the flag is let fly on the next left foot).



Timing for this movement is one.

CATCH THE FLAG FROM THE LET FLY

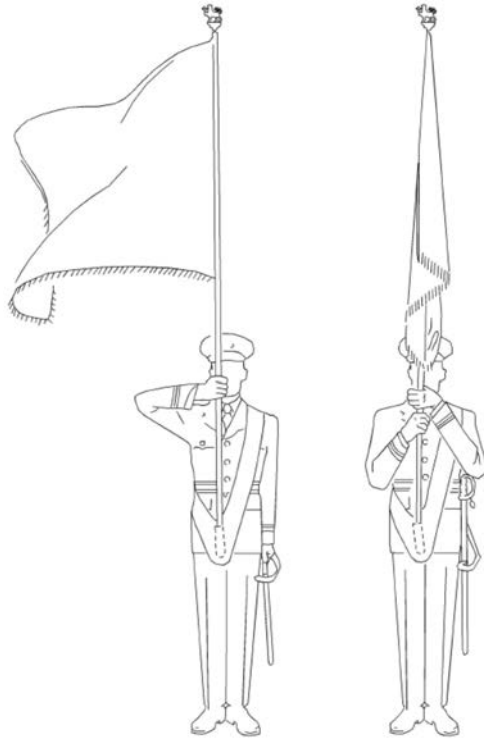

A-PD-201-000/PT-000 (p. 8-3-18)

Figure 8-3-11 Catch the Flag From the Let Fly

On the command, CATCH THE— FLAG(S), the cadets shall:

1. on the first movement:
 - (a) grasp the flag with the left hand and bring it in to the pike; and
 - (b) simultaneously, grasp the corner of the flag with the right hand, back of the hand outwards, at the point of the pike where the lowest corner of the flag reached; and
2. on the second movement, cut the left hand to the side to the position of attention and raise the right forearm to the horizontal position.

This drill movement is also used on the commands:

- ATTEN—TION following the General Salute; and
- EYES—FRONT during the march past.



Timing for this movement is one-two-three, one.



Depending on the wind direction, the flag may be grasped with the right hand after securing the pike in the left hand. If, because of wind strength, the flag cannot be caught, the flag shall be brought to the position of the order, the flag secured and returned to the carry.

CONFIRMATION OF TEACHING POINT 3

The cadets' practicing of carry from the order, order from the carry, let fly and catch the flag will serve as the confirmation of this TP.

Teaching Point 4

**Demonstrate, Explain and Have the Cadets Practice
Marching and Halting in Quick Time and Spiral
Countermarching With Flags**

Time: 35 min

Method: Demonstration and Performance

MARCHING AND HALTING IN QUICK TIME WITH FLAGS

On the command, QUICK—MARCH, the cadets shall:

1. shoot the left foot forward one half pace (35 cm [14 inches]), with the toe up;
2. strike the heel on the ground first and keep the toe pointed directly forward;
3. simultaneously, swing the left arm back waist high;
4. maintain the right arm in the position of the carry; and
5. continue to march with subsequent standard paces (75 cm [30 inches]).



Timing for this movement is left-right-left.

On the command, SQUAD—HALT, the cadets shall:

1. place the right foot flat on the ground naturally, using the heel as a brake;
2. simultaneously swing the left arm forward, breast-pocket high;
3. take a half pace (35 cm [14 inches]) with the left foot, placing it flat on the ground, swinging the left arm back;
4. bend the right knee and straighten it in double time; and
5. simultaneously, cut the left arm to the side as quickly as possible and assume the position of attention.



The command SQUAD—HALT is given as the left foot is on the ground.



Timing for this movement is one-one-two.



Practice the movements with:

- the **instructor** calling the time;
- the **squad** calling the time; and

- the squad **judging** the time.

Emphasize any movements that the cadets had difficulty with during the lesson.

SPIRAL COUNTERMARCHING WITH FLAGS

An adapted form of the spiral countermarch is used to reverse the direction that the flag party is facing without using as much space as is required for a double wheel by the flag party.

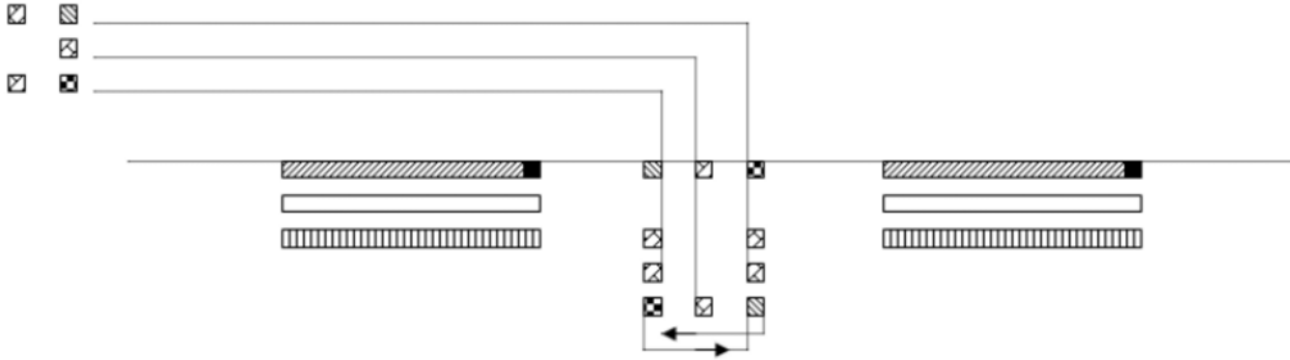

Director Cadets 3, 2008, Ottawa, ON: Department of National Defence

Figure 8-3-12 Spiral Countermarch

On the command, FLAG PARTY, SPIRAL COUNTER—MARCH:

1. all cadets shall maintain the same cadence;
2. the cadets in the file on the right shall perform two consecutive left wheel movements;
3. the cadets in the centre and the file on the left shall perform two consecutive right wheel movements; and
4. the escorts in the rear rank shall follow the flag bearer to their front into position while maintaining dressing.



It is recommended to end this lesson here and teach TPs 5 and 6 during a second session.

CONFIRMATION OF TEACHING POINT 4

The cadets' participation in practicing marching and halting, and spiral countermarching with flags will serve as the confirmation of this TP.

Teaching Point 5

Demonstrate, Explain and Have the Cadets Practice Forming to the Right and Left With Flags

Time: 40 min

Method: Demonstration and Performance



A form changes the direction faced by a flag party in line while maintaining its formation.

CHANGE DIRECTION BY FORMING AT THE HALT

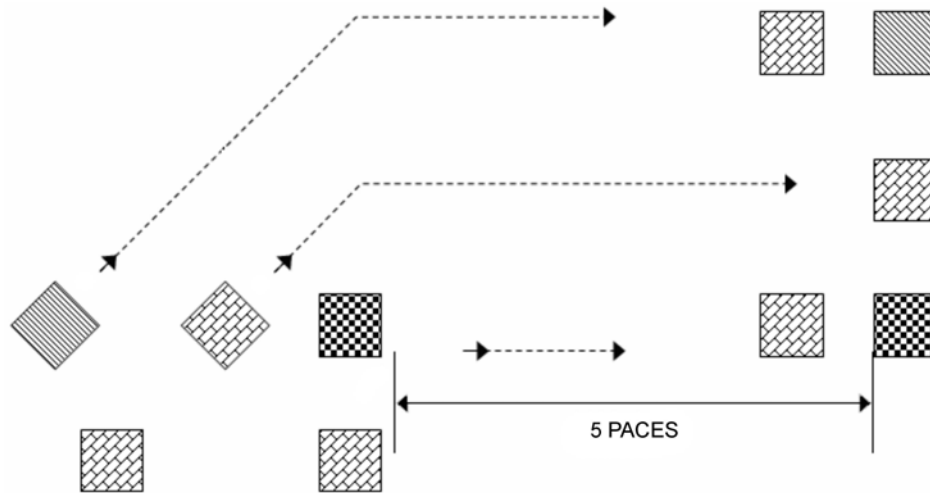

Director Cadets 3, 2008, Ottawa, ON: Department of National Defence

Figure 8-3-13 Right Form

To change direction by forming at the halt to the halt, the following movements shall occur:

On the command AT THE HALT, CHANGE DIRECTION RIGHT (LEFT), RIGHT (LEFT)—FORM:

1. the leading person on the directing flank turns right (left);
2. simultaneously, the remainder of the front rank makes a right (left) incline; and
3. the rear ranks stand fast.

On the command QUICK—MARCH:

1. the leading person of the directing flank marches forward five paces and halts;
2. simultaneously, the remainder of the squad steps off, wheeling as necessary to regain their original position to the left (right) of the directing flank; and
3. each successive file halts in succession from right to left (left to right), facing the new direction.

CHANGE DIRECTION BY FORMING ON THE MARCH



The command CHANGE DIRECTION RIGHT (LEFT), RIGHT (LEFT)—FORM is given as the left (right) foot is on the ground.

To change direction by forming on the march, the following movements shall occur:

On the command CHANGE DIRECTION RIGHT (LEFT), RIGHT (LEFT)—FORM:

1. the leading person of the directing flank makes a right (left) turn, marches forward six paces and marks time;
2. simultaneously, the remainder of the front rank makes a right (left) incline and steps off toward the new position in line with the right (left) flag;

3. the remainder of the squad wheels as necessary to regain their original position to the left (right) of the directing flank; and
4. each successive file marks time, in succession from right to left (left to right), facing the new direction.

On the command FOR—WARD or FLAG PARTY—HALT, the squad acts as ordered.



The commands FOR—WARD and FLAG PARTY—HALT are given as the left foot is on the ground.



Practice the movements with:

- the **instructor** calling the time;
- the **squad** calling the time; and
- the squad **judging** the time.

Emphasize any movements that the cadets had difficulty with during the lesson.

CONFIRMATION OF TEACHING POINT 5

The cadets' practicing of change direction by forming at the halt and on the march will serve as the confirmation of this TP.

Teaching Point 6

Demonstrate, Explain and Have the Cadets Practice Marching On and Marching Off the Flags

Time: 45 min

Method: Demonstration and Performance



The flag party shall march on and march off the parade from the same flank, either left or right.

MARCHING ON THE FLAG(S)

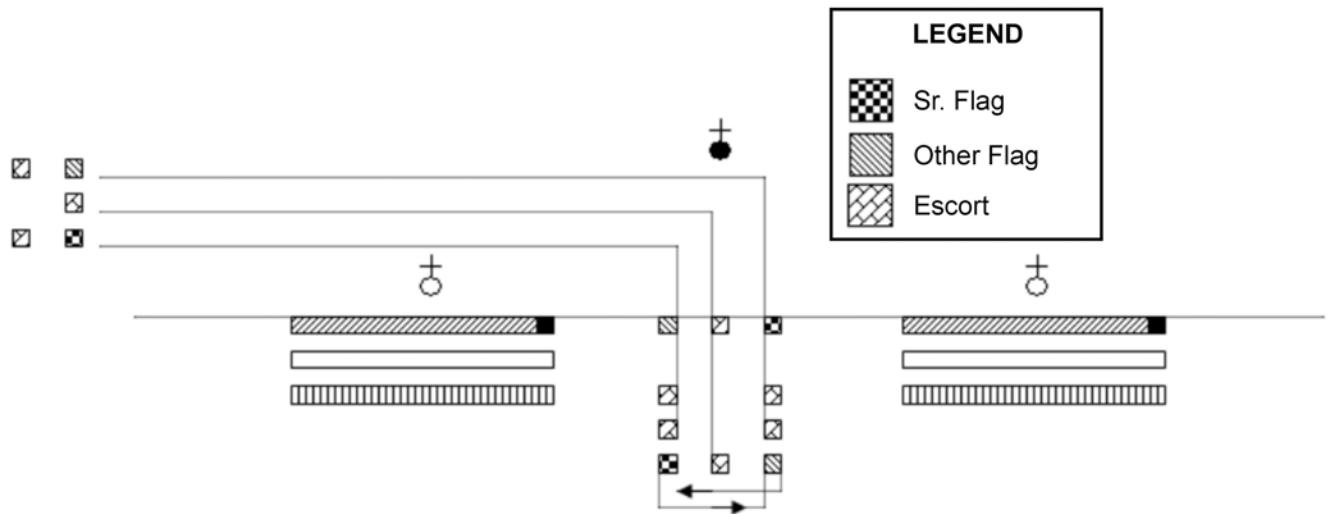

Director Cadets 3, 2008, Ottawa, ON: Department of National Defence

Figure 8-3-14 March on the Flag(s) From the Left Flank

On the command, MARCH ON THE—FLAG(S), members of the flag party shall perform the following:

1. the flag party commander shall order the cautionary FLAG PARTY;
2. the parade commander shall order TO THE FLAG(S)—SALUTE; and
3. the flag party commander shall order BY THE RIGHT (CENTRE), QUICK—MARCH.

The flag party shall march to its position by a series of forms (as illustrated in Figure 8-3-14).

On the command, FLAG PARTY, SPIRAL COUNTER—MARCH:

1. all cadets shall maintain the same cadence;
2. the cadets in the file on the right shall perform two consecutive left wheel movements;
3. the cadets in the centre and the file on the left shall perform two consecutive right wheel movements; and
4. the escorts in the rear rank shall follow the flag bearer to their front into position while maintaining dressing.

The series of forms shall be conducted as follows:

1. On the command FLAG PARTY, QUICK—MARCH, the flag party shall move as a unit to a location on the parade square centred on the parade commander.
2. On the command FLAG PARTY, CHANGE DIRECTION RIGHT (LEFT), RIGHT (LEFT)—FORM, the flag party shall perform a right (left) form on the march. Upon completion of the form, the cadets shall mark time.
3. The flag party shall resume marching on the command FOR—WARD.
4. The flag party shall perform a spiral countermarch.
5. Upon completion of the spiral countermarch, the flag party shall move to a predetermined location on the parade square.

6. Upon halting in its parade position, the flag party commander orders FLAG PARTY, TO THE FLAG(S) —SALUTE.



If the flag party is armed, the flag party commander will order FLAG PARTY, TO THE FLAG(S), PRESENT—ARMS.

Once the flag escort is at the present, the parade commander will order SLOPE—ARMS, and the parade, now including the flag party will slope arms.

Until the flag party is ordered off at the conclusion of the parade, it shall execute the parade commander's commands rather than the flag party commander's commands, except in the following circumstances:

- During an inspection, the flag shall remain in the carry position when the parade commander orders the squadron AT—EASE.
- When required to move to a flank independently, the flag party shall do so under command of its flag party commander by executing forms at the halt or on the march.

MARCHING OFF THE FLAG(S)

On the command, MARCH OFF THE—FLAG(S), members of the flag party shall perform the following:

1. the flag party commander shall order the cautionary FLAG PARTY;
2. the parade commander shall order TO THE FLAG(S)—SALUTE; and
3. the flag party commander shall order BY THE RIGHT (CENTRE), QUICK—MARCH.

The series of forms shall be conducted as follows:

1. On the command FLAG PARTY, QUICK—MARCH, the flag party shall move as a unit to a location on the parade square centred on the parade commander.
2. On the command FLAG PARTY, CHANGE DIRECTION LEFT (RIGHT), LEFT (RIGHT)—FORM, the flag party shall perform a left (right) form on the march. Upon completion of the form, the cadets shall mark time.
3. The flag party shall resume marching on the command FOR—WARD.
4. The flag party shall move to the left (right) flank and march off the parade square.

CONFIRMATION OF TEACHING POINT 6

The cadets' participation in practicing marching on and off as members of a flag party will serve as the confirmation of this TP.

END OF LESSON CONFIRMATION

Have the cadets execute flag drill on the march while judging the time.

Continue delivering commands as time allows, focusing on movements with which the cadets experience difficulty.

CONCLUSION

HOMEWORK/READING/PRACTICE

N/A.

METHOD OF EVALUATION

This EO is assessed IAW A-CR-CCP-603/PG-001, Chapter 3, Annex B, Appendix 2 (308 PC).

CLOSING STATEMENT

Flag drill is the foundation for all other flag drill movements. Drill develops many qualities through self-discipline and practice. Drill that is well-rehearsed, closely supervised and precise is an exercise in obedience and alertness that creates teamwork.

INSTRUCTOR NOTES/REMARKS

It is recommended that this lesson be conducted in two separate sessions. Conduct TPs 1 to 4 in the first session and TPs 5 and 6 in the second session.

REFERENCES

- A0-002 A-PD-201-000/PT-000 Director History and Heritage 3-2. (2005). *The Canadian Forces Manual of Drill and Ceremonial*. Ottawa, ON: Department of National Defence.
- A0-031 A-PD-202-001/FP-000 Director Ceremonial 2. (1993). *Canadian Forces Military Bands and Marches: Band Instructions*. Ottawa, ON: Department of National Defence.
- A0-099 A-AD-200-000/AG-000 Director History and Heritage. (1999). *The Honours, Flags and Heritage Structure of the Canadian Forces*. Ottawa, ON: Department of National Defence.
- A0-102 Director Cadets 5. (1999). CATO 12-05, *Cadet Flags and Banners*. Ottawa, ON: Department of National Defence.

THIS PAGE INTENTIONALLY LEFT BLANK



COMMON TRAINING
PHASE THREE
INSTRUCTIONAL GUIDE



SECTION 4
EO C308.02 – DELIVER WORDS OF COMMAND

Total Time:

60 min

PREPARATION

PRE-LESSON INSTRUCTIONS

Resources needed for the delivery of this lesson are listed in the lesson specification located in A-CR-CCP-603/PG-001, Chapter 4. Specific uses for said resources are identified throughout the instructional guide within the TP for which they are required.

Review the lesson content and become familiar with the material prior to delivering the lesson.

Photocopy, cut out, fold and laminate the aide-mémoire cards with the words of command located at Annex B for each cadet.

PRE-LESSON ASSIGNMENT

N/A.

APPROACH

A practical activity was chosen for this lesson as it is an interactive way to allow the cadets to experience delivering words of command in a safe, controlled environment.

INTRODUCTION

REVIEW

The review associated with this lesson is from EO M308.02 (Deliver Words of Command, Section 2), to include:

QUESTIONS

- Q1. Why are cautionary commands given?
- Q2. What is the purpose of the executive command?
- Q3. If a command is not pronounced clearly and distinctly, what affect may it have on the squad being commanded?
- Q4. How does poor posture affect delivering commands?

ANTICIPATED ANSWERS

- A1. To warn the squad that a movement will be performed.
- A2. To signal that the movement is to be carried out.
- A3. Cadets may not understand the command and perform the wrong movement.
- A4. It restricts the ability to breathe deeply, restricting the movement of the diaphragm, which will cause commands to come from the throat.

OBJECTIVES

By the end of this lesson the cadet shall have delivered words of command.

IMPORTANCE

It is important for cadets to know how to deliver words of command, as words of command that are delivered in a clear, concise manner, with confidence and determination, will affect how cadets respond to orders. Words of command are required to move a division in an organized and efficient manner.

Teaching Point 1

Demonstrate and Have the Cadets Practice Delivering Words of Command

Time: 50 min

Method: Practical Activity

ACTIVITY

OBJECTIVE

The objective of this activity is for each cadet to practice delivering words of command.

RESOURCES

Aide-mémoire cards located at Annex B.

ACTIVITY LAYOUT

N/A.

ACTIVITY INSTRUCTIONS

1. Demonstrate delivering words of command.
2. Distribute the aide-mémoire cards to each cadet.
3. Divide the cadets into groups of no more than four cadets.
4. Have each cadet, within their group, practice delivering words of command with emphasis on voice, accuracy, confidence, correct posture and breathing control. Have the cadets practice commands at the halt and on the march with the other members of the group acting as the squad. Each cadet will be allotted approximately 10 minutes in front of their group.
5. Circulate among the groups and assist the cadets as necessary, offering suggestions and advice for improvement.

SAFETY

N/A.

CONFIRMATION OF TEACHING POINT 1

The cadets' participation in the activity will serve as the confirmation of this TP.

END OF LESSON CONFIRMATION

The cadets' participation in delivering words of command will serve as the confirmation of this lesson.

CONCLUSION

HOMEWORK/READING/PRACTICE

N/A.

METHOD OF EVALUATION

N/A.

CLOSING STATEMENT

When words of command are delivered in a clear and concise manner and with confidence and determination, it will affect how cadets respond to the order. Delivering words of command can allow a division to move as a team in an organized and efficient manner as all members learn to work together.

INSTRUCTOR NOTES/REMARKS

Cadets shall be provided the opportunity to deliver words of command and be given feedback during weekly colours and sunset parades, and ceremonial parades.

This EO will be used as additional practice time for EO M308.02 (Deliver Words of Command, Section 2).

REFERENCES

- A0-002 A-PD-201-000/PT-000 Director History and Heritage 3-2. (2005). *The Canadian Forces Manual of Drill and Ceremonial*. Ottawa, ON: Department of National Defence.
- C0-022 (ISBN 0-02-864207-4) Cole, K. (2002). *The Complete Idiot's Guide to Clear Communication*. Indianapolis, IN: Alpha Books.
- C0-241 Optimal Breathing. (2007). *Posture and Breathing*. Retrieved February 12, 2008, from <http://breathing.com/articles/posture.htm>.
- C0-269 AFMAN 36-2203 Department of the Air Force. (1996). *Drill and Ceremonies*. Lackland, AFB, TX: Secretary of the Air Force.

THIS PAGE INTENTIONALLY LEFT BLANK

DRILL SEQUENCE HANDOUT (PREPARING A SQUAD FOR PARADE)

SQUAD IN LINE

When a squad is formed in line, the team leader, assuming the role of the ADPO, shall be positioned three paces in front and centred on the squad.

STEPS TO PREPARING A SQUAD FOR PARADE

The steps to preparing a squad for parade include:

1. The squad shall form up in three ranks at the edge of the parade square and stand at ease.
2. The team leader shall carry on with forming up a squad as detailed below.

Item	Command	Given By	Execution	Observation
a.		Team Leader	The Team Leader shall march to a position three paces in front of, and facing, the position the marker is to occupy.	The squad is formed up just off the parade square, standing easy. The right hand cadet of the front rank is the designated "Marker".
b.	MARKER	Team Leader	The Marker shall come to attention, answer by rank, observe the standard pause, march in a direct line to, and halt three paces in front of and facing, the Team Leader. The Marker shall remain at attention.	The platoon shall come to the position of stand at ease. The Team Leader, after placing the Marker, shall turn right and march to a position three paces in front of and centre facing where the squad shall fall in.
c.	Squad FALL —IN	Team Leader	The squad shall come to attention, observe the standard pause and march onto the parade ground. It shall halt on the left of and covering off the marker and remain at attention.	A direct route shall be taken by the squad.

3. The team leader shall carry on with calling the roll as detailed below.

Item	Command	Given By	Execution	Observation
a.	ANSWER TO YOUR NAME, STAND AT— EASE	Team Leader	Each squad member shall come to attention as their name is called, answer accordingly and stand at ease.	The team leader shall read each name from a roll and mark the attendance for each cadet.

4. The team leader shall carry on with sizing in a single rank and reforming threes (twos) as detailed below.

Item	Command	Given By	Execution	Observation
a.	TALLEST ON THE RIGHT, SHORTEST ON THE LEFT, IN A SINGLE RANK— SIZE	Team Leader	The squad shall turn right, observe the standard pause, then arrange themselves according to height, with tallest on the right and shortest on the left in one single rank, shoulder to shoulder dressing and covering off front to rear.	The team leader shall ensure the cadets are arranged as ordered before proceeding.
b.	SQUAD— NUMBER	Team Leader	The squad shall call out their number in sequence from the right.	The team leader shall ensure that no numbers are missed.
c.	ODD NUMBERS ONE PACE FORWARD, EVEN NUMBERS ONE PACE STEP BACK —MARCH	Team Leader	The squad shall act as ordered.	
d.	NUMBER ONE STAND FAST, ODD NUMBERS RIGHT, EVEN NUMBERS LEFT— TURN	Team Leader	The squad shall act as ordered.	
e.	REFORM THREES (TWOS), QUICK— MARCH	Team Leader	The squad reform ranks with Number 1 as the marker and remainder filling in the next open position.	When each person arrives in their new position, they shall halt, at arm's-length interval, observe the standard pause, turn left and remain at attention.

5. The team leader shall carry on with dressing a squad as detailed below.

Item	Command	Given By	Execution	Observation
a.	RIGHT— DRESS	Team Leader	The squad shall act as ordered.	
b.	EYES— FRONT	Team Leader	The squad shall act as ordered.	Squad members shall snap the head and eyes to the front, cut the right arm behind the cadet on the right and return to the position of attention.

6. The team leader shall carry on with inspecting a squad as detailed below.

Item	Command	Given By	Execution	Observation
a.	OPEN ORDER— MARCH	Team Leader	The squad shall act as ordered.	
b.	RIGHT— DRESS	Team Leader	The squad shall act as ordered.	
c.	EYES— FRONT	Team Leader	The squad shall act as ordered.	
d.		Team Leader	The team leader will inspect the front and rear of each cadet, starting at the right marker and proceeding around each rank in turn. The inspection of a cadet shall start at the head and work down to the feet.	The purpose of an inspection is to ensure a standard of personal hygiene and grooming, and that each cadet is properly dressed, with all clothing, badges, etc, are worn correctly, clean, and in good repair.
e.	CLOSE ORDER— MARCH	Team Leader	The squad shall act as ordered.	
f.	RIGHT— DRESS	Team Leader	The squad shall act as ordered.	
g.	EYES— FRONT	Team Leader	The squad shall act as ordered.	
h.	STAND AT— EASE	Team Leader	The squad shall act as ordered.	

7. As the platoon commander approaches, the team leader shall carry on with handing over a squad as detailed below.

Item	Command	Given By	Execution	Observation
a.	ATTEN— TION	Team Leader	The squad shall act as ordered.	The team leader calls the squad to attention as the DPO approaches.
b.		Team Leader		The DPO halts two paces in front of the team leader, who reports the squads strength and condition.
c.		Team Leader		Upon being ordered to fall in, the team leader turns right, by a series of wheels proceeds around the right flank and takes their position behind the squad.
d.		DPO		The DPO marches forward two paces to take up their position.

AIDE-MÉMOIRE CARD



PREPARING A SQUAD FOR PARADE	
FALLING IN: <ul style="list-style-type: none">• MARKER.• SQUAD FALL—IN.	DRESSING: <ul style="list-style-type: none">• RIGHT—DRESS.• EYES—FRONT.
CALLING THE ROLL: <ul style="list-style-type: none">• ANSWER TO YOUR NAME, STAND AT—EASE.	PRE-INSPECTING: <ul style="list-style-type: none">• OPEN ORDER—MARCH.• RIGHT—DRESS.• EYES—FRONT.
SIZING IN A SINGLE RANK: <ul style="list-style-type: none">• TALLEST ON THE RIGHT, SHORTEST ON THE LEFT, IN A SINGLE RANK—SIZE.• SQUAD—NUMBER.• ODD NUMBERS ONE PACE FORWARD, EVEN NUMBERS ONE PACE STEP BACK—MARCH.• NUMBER ONE STAND FAST, ODD NUMBERS RIGHT, EVEN NUMBERS LEFT—TURN.• REFORM THREES (TWOS), QUICK—MARCH.	POST-INSPECTING: <ul style="list-style-type: none">• CLOSE ORDER—MARCH.• RIGHT—DRESS.• EYES—FRONT.• STAND AT—EASE.
	HANDING OVER: <ul style="list-style-type: none">• ATTEN—TION.



PREPARING A SQUAD FOR PARADE	
FALLING IN: <ul style="list-style-type: none">• MARKER.• SQUAD FALL—IN.	DRESSING: <ul style="list-style-type: none">• RIGHT—DRESS.• EYES—FRONT.
CALLING THE ROLL: <ul style="list-style-type: none">• ANSWER TO YOUR NAME, STAND AT—EASE.	PRE-INSPECTING: <ul style="list-style-type: none">• OPEN ORDER—MARCH.• RIGHT—DRESS.• EYES—FRONT.
SIZING IN A SINGLE RANK: <ul style="list-style-type: none">• TALLEST ON THE RIGHT, SHORTEST ON THE LEFT, IN A SINGLE RANK—SIZE.• SQUAD—NUMBER.• ODD NUMBERS ONE PACE FORWARD, EVEN NUMBERS ONE PACE STEP BACK—MARCH.• NUMBER ONE STAND FAST, ODD NUMBERS RIGHT, EVEN NUMBERS LEFT—TURN.• REFORM THREES (TWOS), QUICK—MARCH.	POST-INSPECTING: <ul style="list-style-type: none">• CLOSE ORDER—MARCH.• RIGHT—DRESS.• EYES—FRONT.• STAND AT—EASE.
	HANDING OVER: <ul style="list-style-type: none">• ATTEN—TION.

THIS PAGE INTENTIONALLY LEFT BLANK

CHAPTER 9
PO 309 – INSTRUCT A LESSON



COMMON TRAINING
PHASE THREE
INSTRUCTIONAL GUIDE



SECTION 1

EO M309.01 – EXPLAIN THE PRINCIPLES OF INSTRUCTION

Total Time:

60 min

PREPARATION

PRE-LESSON INSTRUCTIONS

Resources needed for the delivery of this lesson are listed in the lesson specification located in A-CR-CCP-603/PG-001, Chapter 4. Specific uses for said resources are identified throughout the instructional guide within the TP for which they are required.

Review the lesson content and become familiar with the material prior to delivering the lesson.

The activity in TP 2 uses learning stations. Learning stations are a form of group work where the cadets learn by sorting through the information presented. When setting up learning stations, ensure there is enough room for each cadet to be comfortable and have adequate space for writing down information. When the cadets arrive at a learning station, all required information shall be available. These stations should be placed close together to minimize time for movement; however far enough apart to avoid interruptions from other groups. For this lesson, choose and set up six learning stations for the principles of instruction.

Photocopy the Principles of Instruction Information Sheets located at Annex A and the Principles of Instruction Worksheets located at Annex B for each station.

PRE-LESSON ASSIGNMENT

N/A.

APPROACH

An interactive lecture was chosen for TP 1 to present the principles of instruction and to generate interest.

An in-class activity was chosen for TP 2 as it is an interactive way for the cadets to apply the principles of instruction.

INTRODUCTION

REVIEW

N/A.

OBJECTIVES

By the end of this lesson the cadet shall have explained the principles of instruction and how they are applied when planning and instructing a lesson.

IMPORTANCE

It is important for the cadets to explain the principles of instruction and how they are applied when planning and instructing a lesson to make training enjoyable and successful and to help the instructor make informed decisions while in front of a class. The ability to keep a class interested, motivated and eager to learn are invaluable skills that will provide a positive learning experience for the cadets.

Teaching Point 1

Describe the Principles of Instruction

Time: 10 min

Method: Interactive Lecture

THE PRINCIPLES OF INSTRUCTION



Principle. A fundamental truth or law as the basis of reasoning or action.

In order to create an environment that promotes participation and learning, an instructor follows a set of guidelines or principles to plan and instruct a lesson. The following are the fundamental guidelines known as the principles of instruction:

- **Interest.** Cadets are more receptive to learning when they are curious and have an emotional connection to a topic. The instructor must arouse, create and maintain the interest of the cadets. Without interest, the cadets will be less inclined to listen and will not learn.
- **Comprehension.** Comprehension or understanding relates to the cadet's ability to understand the material taught. The cadets' readiness to learn new material is influenced by what has previously been taught; new content should not exceed the knowledge level of the cadets. If the cadets do not understand, they are unable to learn.
- **Emphasis.** During a period of instruction, there will be some information that may be of particular importance. The instructor can emphasize this important information through the use of voice control, training aids and in-class activities.
- **Participation.** Cadets are more likely to retain information if they are both mentally and physically involved in learning. The instructor should conduct activities that contain action, activity and excitement. Cadets learn by doing.
- **Accomplishment.** The lesson must impart a sense of accomplishment to each cadet. The cadets should leave the class with the satisfaction that they were able to accomplish something in the lesson.
- **Confirmation.** Confirmation is an essential part of learning and instructing. It gives both the instructor and the cadet the opportunity to see how well the information is understood.



The acronym ICEPAC is useful for remembering the principles of instruction.

CONFIRMATION OF TEACHING POINT 1

QUESTIONS

- Q1. List the principles of instruction.
- Q2. What will occur if a lesson lacks interest?
- Q3. What is the acronym that can be used to remember the principles of instruction?

ANTICIPATED ANSWERS

A1. The principles of instruction are:

- interest,
- comprehension,
- emphasis,
- participation,
- accomplishment, and
- confirmation.

A2. Without interest the cadets will be less inclined to listen and will not learn.

A3. The acronym that can be used to remember the principles of instruction is ICEPAC.

Teaching Point 2
Conduct an Activity Where the Cadets Will Apply the Principles of Instruction

Time: 40 min

Method: In-Class Activity

ACTIVITY

OBJECTIVE

The objective of this activity is to have the cadets practice the application of the principles of instruction.

RESOURCES

- Principles of instruction information sheets,
- Principles of instruction worksheets, and
- Pens/pencils.

ACTIVITY LAYOUT

Set up six learning stations, to include:

- principles of instruction information sheets,
- principles of instruction worksheets, and
- pens/pencils.

ACTIVITY INSTRUCTIONS

1. Divide the cadets into six groups and place each group at one of the principles of instruction learning stations.
2. Assign each group a leader. Have the group leader assign a recorder and a reader.
3. Using the principle and topic at the top of the page, have the groups fill out the principle of instruction worksheet (it is necessary for each group to fill out only one worksheet).
4. After five minutes, have the groups rotate clockwise to the next station. Have the cadets complete the next principle of instruction worksheet.



Have the groups bring their worksheets with them as they rotate through the stations.



It is important to circulate around the room to facilitate the activities and help the cadets as required. If possible, assign other instructors to aid with supervision and facilitation.

5. Rotate the groups through the remaining stations.
6. Have the cadets share the information they recorded with the rest of the cadets. In most cases the groups will have recorded the same information for each station. If a group has listed different information it will be shared after the presentation is finished.

SAFETY

N/A.

CONFIRMATION OF TEACHING POINT 2

The cadets' participation in the activity will serve as the confirmation of this TP.

END OF LESSON CONFIRMATION

The cadets' participation in the principles of instruction learning stations will serve as the confirmation of this lesson.

CONCLUSION

HOMEWORK/READING/PRACTICE

N/A.

METHOD OF EVALUATION

N/A.

CLOSING STATEMENT

Describing the principles of instruction and knowing how to apply them when planning and instructing a lesson assists in making training enjoyable and successful and helps the instructor make informed decisions while in front of a class. The ability to keep a class interested, motivated and eager to learn are invaluable skills that will provide a positive learning experience.

INSTRUCTOR NOTES/REMARKS

The learning stations must be set up prior to beginning this lesson.

The cadets will be divided into six groups and will rotate through the stations during the in-class activity in TP 2.

REFERENCES

A0-055 A-P9-050-000/PT-006 Canadian Forces Individual Training and Education System. (1997). *Conduct of Instructional Programmes* (Vol. 6). Ottawa, ON: Department of National Defence.

THIS PAGE INTENTIONALLY LEFT BLANK



COMMON TRAINING
PHASE THREE
INSTRUCTIONAL GUIDE



SECTION 2

EO M309.02 – IDENTIFY METHODS OF INSTRUCTION

Total Time:

60 min

PREPARATION

PRE-LESSON INSTRUCTIONS

Resources needed for the delivery of this lesson are listed in the lesson specification located in A-CR-CCP-603/PG-001, Chapter 4. Specific uses for said resources are identified throughout the instructional guide within the TP for which they are required.

Review the lesson content and become familiar with the material prior to delivering the lesson.

Photocopy Annexes C and D for each cadet.

PRE-LESSON ASSIGNMENT

N/A.

APPROACH

An interactive lecture was chosen for TP 1 to describe types of lessons as it allows the instructor to deliver new information while encouraging the cadets to actively participate by asking and responding to questions.

An in-class activity was chosen for TPs 2 and 3 as it is an interactive way to reinforce the topic and confirm the cadets' comprehension of types of lessons and methods of instruction.

INTRODUCTION

REVIEW

N/A

OBJECTIVES

By the end of this lesson the cadet shall have identified a method of instruction appropriate for a specific type of lesson and given topic.

IMPORTANCE

It is important for cadets to know that there are many methods of instruction that can be used for knowledge and skill lessons. Varying the method of instruction is one way for instructors to create interest and encourage learning.

Teaching Point 1**Describe Types of Lessons**

Time: 5 min

Method: Interactive Lecture

TYPES OF LESSONS

Knowledge and skill are the two types of lessons.



The main differences between a knowledge lesson and a skill lesson are how the cadets participate during the lesson and how the instructor confirms learning at the end of a teaching point or lesson.

In a knowledge lesson, the cadets participate by asking and responding to questions and discussing lesson content. The instructor confirms learning by posing questions to the class or conducting an activity.

In a skill lesson, the cadets participate by practicing and performing a skill while the instructor observes the cadets' performance to confirm learning.

Knowledge Lesson

A knowledge lesson gives the cadets the theoretical aspects of a subject. The instructor presents basic information about a topic, typically following the who, what, where, when and why (5 Ws) format. Delivering an effective knowledge lesson requires the instructor to:

1. select an instructional method;
2. research the lesson information thoroughly;
3. summarize the information;
4. prepare questions to encourage class participation;
5. prepare questions for confirmation; and
6. prepare training aids.



All lessons require the instructor to create and maintain interest. It is especially important that instructors ensure that knowledge lessons are interesting because they are not hands-on.

Skill Lesson

A skill lesson demonstrates the skill to be learned in a step-by-step sequence. Conducting an effective demonstration requires the instructor to:

1. plan carefully;
2. breakdown the skill to be taught into sequential steps;
3. rehearse the sequence to ensure that it is accurate and clear;
4. prepare a written lesson plan;
5. prepare and/or obtain all material needed to demonstrate and practice the skill in advance;
6. organize the class so the demonstration can be seen;

7. allow the cadets to practice the steps under supervision;
8. provide assistance or re-demonstrate as necessary; and
9. allow the cadets to continue to practice under supervision until all have achieved the skill.



Mastery of a particular skill may require practice beyond class time depending upon the learners and difficulty of the skill.

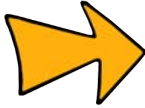

Learning is a combination of knowledge, attitudes and skills that promote the development of a cadet.

CONFIRMATION OF TEACHING POINT 1

QUESTIONS

- Q1. What are the main differences between knowledge and skill lessons?
- Q2. How do instructors confirm learning in a skill lesson?
- Q3. Why is it more difficult to create and maintain interest in a knowledge lesson?

ANTICIPATED ANSWERS

- A1. Knowledge and skill lessons differ mainly in how cadets participate during the lesson and how instructors confirm learning at the end of a teaching point or lesson.
- A2. Instructors confirm learning in a skill lesson by observing the cadets perform the skill.
- A3. It is more difficult to create and maintain interest in a knowledge lesson because it is not hands-on.

Teaching Point 2

Conduct an Activity Where the Cadets Will Describe Methods of Instruction

Time: 25 min

Method: In-Class Activity

BACKGROUND KNOWLEDGE

INSTRUCTIONAL METHODS

Instructors should be familiar with and able to use a variety of methods of instruction. Some of the more widely used instructional methods are described and located at Annex C.

ACTIVITY

OBJECTIVE

The objective of this activity is to have the cadets describe methods of instruction.

RESOURCES

- Methods of instruction information sheets,
- Flip chart paper,
- Coloured markers, and
- Pens/pencils.

ACTIVITY LAYOUT

Set up four work stations and label them “description”, “pre-lesson preparation”, “typical applications” and “lesson development”. At each station have:

- three sheets of flip chart paper, and
- coloured markers.

ACTIVITY INSTRUCTIONS

1. Divide the cadets into four groups and place each group at one of the labelled work stations.
2. Give the cadets a copy of Annex C.
3. Assign each group a leader. The group leader will be responsible for assigning a recorder and reader.
4. Have each group research their information (description, pre-lesson preparation, typical applications, or lesson development) from Annex C for each method of instruction and record the key points on the flip chart paper. (10 minutes)
5. Have the groups share their information with the class. (10 minutes)

SAFETY

N/A.

CONFIRMATION OF TEACHING POINT 2

The cadets' participation in the activity will serve as the confirmation of this TP.

Teaching Point 3

Conduct an Activity Where the Cadets Will Select an Appropriate Method of Instruction for a Given Topic

Time: 20 min

Method: In-Class Activity



The instructional method is determined by the:

- lesson material,
- environment in which the training will take place,
- resources available to the instructor,
- time available to the instructor, and
- needs of the cadets.

ACTIVITY

OBJECTIVE

The objective of this activity is to have the cadets consider criteria and select an appropriate method of instruction for each topic.

RESOURCES

List of lesson topics located at Annex D.

ACTIVITY LAYOUT

N/A.

ACTIVITY INSTRUCTIONS

1. Give the cadets a copy of Annex D.
2. Introduce the objective of the activity and have the cadets work individually for 10 minutes matching the lesson topics to the instructional methods described in TP 2.
3. Stress that some topics can be taught using more than one method of instruction but they are to chose the one they consider to be the most appropriate.
4. Have the cadets share their work with the class by identifying and explaining their choice of instructional method for a topic.

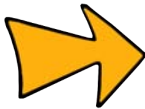

No single instructional method is best for all objectives. Providing instruction using a variety of methods can often enhance learning.

SAFETY

N/A.

CONFIRMATION OF TEACHING POINT 3

The cadets' participation in the activity will serve as the confirmation of this TP.

END OF LESSON CONFIRMATION

QUESTIONS

- Q1. What is one application of the interactive lecture?
- Q2. How does the instructor confirm learning when using the demonstration and performance instructional method?
- Q3. What instructional method is being used when the cadets participate in "real life" operations that illustrate what was discussed or learned in the classroom?
- Q4. Give two examples of in-class activities?
- Q5. Games create variety and arouse interest. It is critical they do what?

Q6. Which instructional method is being used when cadets produce a product, carry out an application or demonstrate a process?

ANTICIPATED ANSWERS

- A1. Interactive lectures can be used to review previously taught material, present background information, introduce a new subject, give instructions on procedures, illustrate the application of rules, principles or concepts and introduce a demonstration, discussion or performance.
- A2. During a demonstration and performance, the instructor confirms learning by observing the cadet perform the operation, skill or movement.
- A3. Field trip.
- A4. In-class activities include learning stations, videos, brainstorming, debating and group work.
- A5. It is critical that games support learning.
- A6. Practical activity.

CONCLUSION

HOMEWORK/READING/PRACTICE

N/A.

METHOD OF EVALUATION

This EO is assessed IAW A-CR-CCP-603/PG-001, Chapter 3, Annex B, Appendix 3 (309 PC).

CLOSING STATEMENT

Being able to select a method of instruction appropriate for a given lesson is an important skill for an instructor. Cadets will be more likely to pay attention, participate in classroom activities, answer questions and generally have a positive learning experience if instructors select an appropriate instructional method and plan the learning activities.

INSTRUCTOR NOTES/REMARKS

N/A.

REFERENCES

- A0-055 A-P9-050-000/PT-006 Director Training and Education Policy. (2002). *Canadian Forces Individual Training and Education System* (Vol. 6). Ottawa, ON: Department of National Defence.
- A0-056 A-P9-050-000/PT-005 Director Training and Education Policy. (2001). *Canadian Forces Individual Training and Education System* (Vol. 5). Ottawa, ON: Department of National Defence.



**COMMON TRAINING
PHASE THREE
INSTRUCTIONAL GUIDE**



SECTION 3

EO M309.03 – DESCRIBE EFFECTIVE-SPEAKING TECHNIQUES

Total Time:

30 min

PREPARATION

PRE-LESSON INSTRUCTIONS

Resources needed for the delivery of this lesson are listed in the lesson specification located in A-CR-CCP-603/PG-001, Chapter 4. Specific uses for said resources are identified throughout the instructional guide within the TP for which they are required.

Review the lesson content and become familiar with the material prior to delivering the lesson.

PRE-LESSON ASSIGNMENT

N/A.

APPROACH

An interactive lecture was chosen for TPs 1 and 3 to present basic material and to orient the cadets to aspects of voice control and how to prepare for effective-speaking.

A group discussion was chosen for TP 2 as it allows the cadets to interact with their peers and share their knowledge, experiences, opinions and feelings about physical presence while speaking in front of a group.

INTRODUCTION

REVIEW

N/A.

OBJECTIVES

By the end of this lesson the cadet shall have described elements of voice control, elements of physical presence and effective-speaking preparation.

IMPORTANCE

It is important for the cadets to describe elements of voice control and physical presence to be a confident instructor. The ability to effectively prepare for a presentation and control nervousness are invaluable skills that help to provide a positive learning experience for both the instructor and the trainee.

Teaching Point 1**Explain Elements of Voice Control**

Time: 10 min

Method: Interactive Lecture



The cadets may have been exposed to people from other communities, provinces and even countries with accents different from their own. Brainstorm with the cadets how elements of voice control can affect how the message is received and write down the responses. After the brainstorming is complete, compare the class list to the list below.

ELEMENTS OF VOICE CONTROL

One of the most important and effective tools of communication is voice control. The ability to use voice control to communicate effectively and place emphasis on important information is a fundamental skill that will be used while in front of an audience.

Pitch. How high or low a voice is. A change in pitch usually does not add any significance to a message. However a pitch change will be noticed by the audience and will keep people involved.

Tone. The quality of the sound of a voice. Effective communicators will often change the tone of their voice to give emphasis to a single word or phrase to convey emotion and conviction.



Monotone. A sound without change of pitch or tone.

Volume. The quantity or power of sound or fullness of tone. A change in volume often signifies emphasis on a particular phrase or point. Environmental factors such as outside noise and room size must be taken into consideration to ensure the audience can hear the message being sent.

Speed. The rate or rapidity in which words are spoken. Speaking too fast or too slow can be distracting to an audience. It is important to communicate at a pace that ensures the audience can understand every word being said.

Pause. A break in speaking or reading. A pause is an important part of the communication process. A pause gives the audience an opportunity to digest what has been said and to ask questions. A pause is also an effective way to announce a change in subject or an important point.

Articulation. The clear and distinct pronunciation of a word. It is important to properly pronounce and articulate words to ensure the audience can understand the message being sent.

CONFIRMATION OF TEACHING POINT 1**QUESTIONS**

- Q1. Name the six elements of voice control.
- Q2. What can a change in volume signify when sending a message?
- Q3. What is the purpose of pausing while speaking?

ANTICIPATED ANSWERS

- A1. The six elements of voice control are:

- pitch,
- tone,
- volume,
- speed,
- pause, and
- articulation.

A2. A change in volume can signify emphasis on a particular phrase or point.

A3. A pause gives the audience an opportunity to digest what has been said and to ask questions. A pause is also an effective way to announce a change in subject or an important point.

Teaching Point 2

Discuss Elements of Physical Presence

Time: 10 min

Method: Group Discussion

BACKGROUND KNOWLEDGE



The purpose of the group discussion is to draw the following information from the group using the tips for answering/facilitating discussion and the suggested questions provided.

ELEMENTS OF PHYSICAL PRESENCE

It is estimated that 93 percent of the total meaning of a message comes from non-verbal communication and only 7 percent of meaning comes from the words themselves. Being aware of physical presence and its effect on a message being sent is an important element of effective communication.

Body Language

Body language or non-verbal communication is the process of communicating through conscious and unconscious gestures and expressions. Understanding that body language affects how a message is received and interpreted is an important tool for communicating effectively.

Facial Expressions. While 93 percent of the total meaning of a message comes from non-verbal communication, most of that meaning is communicated by the eyes, eyebrows and mouth. The movement of the eyes, eyebrows and mouth can result in an infinite variety of expressions to complement the spoken word. It is important that facial expressions match the tone of the message being sent to create emphasis and believability. A smile is the most important of all facial expressions. A smile adds sincerity to a message and will add to the likeability of the individual in front of the audience.

Eye Contact. Maintaining eye contact is an effective way of engaging an audience and building interest. Pausing two or three seconds on each member of the audience will make them feel as though they are involved in a one-on-one conversation. It is important to look at the entire room and scan from left to right, back to front.



Look for friendly, sympathetic faces to gain confidence and ease nervousness.

Gestures. The combination of hand, arm and shoulder movements can make a wide variety of gestures that can help add meaning to a message. Effective communicators will let their hands and arms move naturally to help give emphasis and emotion to a message. It is important not to point directly at members of the audience or let gestures become distracting.

Movement. Being aware of movement while in front of an audience is very important to communication. Movement will keep listeners engaged and interested in what is being said. Moving around the front of the room, toward and away from an audience and from side to side can help emphasize points. Too much or frantic movement can become distracting and will affect how a message is received.

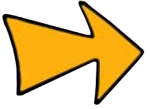

Hands placed in pockets are typically a sign of nervousness or overconfidence.

Dress and Deportment. Effective communicators are aware of their dress and deportment. Audiences will react differently to an individual who is well dressed and acts professionally, than an individual who is poorly dressed and acts unprofessionally.

Dress. Effective communicators will always appear in clean, well-pressed and appropriate attire. Dressing appropriately for the event will help create confidence and credibility.

Deportment. An audience that sees an individual as being prepared, on time, appropriately dressed and confident will be much more receptive, than to an individual who is unprepared, late, poorly dressed and nervous. The most important element of deportment is displaying an interest in the subject; this will be noticed by the audience and will generate interest in the presentation.

GROUP DISCUSSION



TIPS FOR ANSWERING/FACILITATING DISCUSSION

- Establish ground rules for discussion, e.g., everyone should listen respectfully; don't interrupt; only one person speaks at a time; no one's ideas should be made fun of; you can disagree with ideas but not with the person; try to understand others as much as you hope they understand you; etc.
- Sit the group in a circle, making sure all cadets can be seen by everyone else.
- Ask questions that will provoke thought; in other words avoid questions with yes or no answers.
- Manage time by ensuring the cadets stay on topic.
- Listen and respond in a way that indicates you have heard and understood the cadet. This can be done by paraphrasing their ideas.
- Give the cadets time to respond to your questions.
- Ensure every cadet has an opportunity to participate. One option is to go around the group and have each cadet answer the question with a short answer. Cadets must also have the option to pass if they wish.
- Additional questions should be prepared ahead of time.

SUGGESTED QUESTIONS

Q1. How could you use facial expressions to emphasize something that is funny?

- Q2. As an effective-speaker how could you make the audience feel like they are part of the presentation?
- Q3. How would you expect an instructor to present themselves in terms of dress and deportment?
- Q4. What is one of the most important elements of deportment?



Other questions and answers will develop throughout the group discussion. The group discussion should not be limited to only those suggested.



Reinforce the answers given and comments made during the group discussion, ensuring the teaching point has been covered.

CONFIRMATION OF TEACHING POINT 2

The cadets' participation in the group discussion will serve as the confirmation of this TP.

Teaching Point 3

Explain Effective-Speaking Preparation

Time: 5 min

Method: Interactive Lecture

Effective-speaking preparation is the most critical component of effective communication. Preparation will help to ensure confidence, control nervousness and increase the likelihood of success when in front of an audience.

The following are the steps to effective-speaking preparation:

1. **Practicing.** Proper rehearsal will aid in memorizing content, which will allow for more eye contact and movement while in front of an audience. Memorizing the introduction and conclusion are the two most critical elements; a strong introduction will aid in gaining confidence and will draw the interest of the audience, a strong conclusion will aid in leaving a lasting impression on the audience. If possible, practice in front of a small group, speak aloud even when practicing alone and always practice while standing.
2. **Controlling Nervousness.** The feeling of nervousness prior to speaking in front of a group is normal and often can help if channeled effectively. The following actions can be taken to control nervousness:
 - (a) **Room Layout.** Become familiar with the layout of the room prior to speaking.
 - (b) **Materials.** Ensure notes, handouts and presentation aids are organized.
 - (c) **Equipment.** Ensure any equipment being used is in working order and ready to use.
 - (d) **Practice.** Spend time going over notes and rehearsing content.
 - (e) **Attitude.** Enter the room with a smile and a positive and confident attitude.
 - (f) **Breathing.** Take a deep breath before entering the room. Slow down the delivery if necessary and breathe from the diaphragm while speaking, not from the chest.
3. **Identifying a Friendly Face.** While walking in front of an audience, identify a friendly face. Making eye contact with a friendly face while beginning to speak will often give confidence while beginning the introduction and ultimately lead to success when addressing an audience.

CONFIRMATION OF TEACHING POINT 3

QUESTIONS

- Q1. What are the three steps to effective-speaking preparation?
- Q2. What actions can be taken to control nervousness?
- Q3. What is the benefit of identifying a friendly face?

ANTICIPATED ANSWERS

- A1. The three steps to effective-speaking preparation are:
- (1) practice,
 - (2) control nervousness, and
 - (3) identify a friendly face.
- A2. The actions that can be taken to control nervousness are:
- become familiar with the layout of the room prior to speaking,
 - ensure notes, handouts and presentation aids are well organized,
 - ensure any equipment being used is in working order and ready to use,
 - spend time going over notes and rehearse content,
 - enter the room with a smile and a positive and confident attitude, and
 - take a deep breath before entering the room.
- A3. Making eye contact with a friendly face while beginning to speak will often give confidence while beginning the introduction and ultimately lead to success when addressing an audience.

END OF LESSON CONFIRMATION

QUESTIONS

- Q1. What is meant by tone?
- Q2. What are the two elements of physical presence?
- Q3. What are the four aspects of body language?

ANTICIPATED ANSWERS

- A1. The quality of the sound of a voice.
- A2. The two elements of physical presence are:
- body language, and
 - dress and deportment.
- A3. The four aspects of body language are:
- facial expressions,

- eye contact,
- gestures, and
- movement.

CONCLUSION

HOMEWORK/READING/PRACTICE

N/A.

METHOD OF EVALUATION

N/A.

CLOSING STATEMENT

Knowing how to apply elements of voice control and physical presence will make instructing enjoyable and successful by helping develop presence while in front of an audience. The ability to effectively prepare for a presentation and control nervousness are invaluable skills that may help to develop a more confident instructor.

INSTRUCTOR NOTES/REMARKS

N/A.

REFERENCES

C0-192 (ISBN 0-9695066-2-7) Bender, P. (2000). *Secrets of Power Presentations*. Toronto, ON: The Achievement Group.

THIS PAGE INTENTIONALLY LEFT BLANK



COMMON TRAINING
PHASE THREE
INSTRUCTIONAL GUIDE



SECTION 4

EO M309.04 – DESCRIBE QUESTIONING TECHNIQUES

Total Time:

30 min

PREPARATION

PRE-LESSON INSTRUCTIONS

Resources needed for the delivery of this lesson are listed in the lesson specification located in A-CR-CCP-603/PG-001, Chapter 4. Specific uses for said resources are identified throughout the instructional guide within the TP for which they are required.

Review the lesson content and become familiar with the material prior to delivering the lesson.

Arrange for officers or senior cadets to assist in conducting the activity and recording data regarding the cadets' performance.

Review the activity instructions with the officers and senior cadets assisting with the activity.

Photocopy Annexes E, F, G, and H for the officers and senior cadets assisting with the activity.

Photocopy Annex E for each cadet.

Assign spaces in the training area for workstations to conduct the activity if more than one group is used.

Make photocopies of Annex F for each station if necessary.

PRE-LESSON ASSIGNMENT

N/A.

APPROACH

An interactive lecture was chosen for TPs 1–3 as it allows the instructor to describe the purposes, qualities and types of questions while encouraging the cadets to actively participate by asking and responding to questions.

An in-class activity was chosen for TP 4 as it is an interactive way to reinforce the topic and confirm the cadets' comprehension of questioning techniques.

INTRODUCTION

REVIEW

N/A.

OBJECTIVES

By the end of this lesson the cadet shall have described questioning techniques by listing the purposes of questioning, listing the qualities of a good question, defining types of questions and by listing the steps to posing questions while instructing.

IMPORTANCE

Asking questions throughout a lesson helps the instructor to determine the cadets' level of comprehension of previously taught material, to create interest in the lesson and to confirm the cadets' comprehension of new material. Proper questioning techniques will help instructors ask questions properly to accomplish these goals and to develop confidence in their instructional abilities.

Teaching Point 1

Describe the Purposes of Questioning

Time: 5 min

Method: Interactive Lecture

PURPOSES OF QUESTIONING

Questions that are carefully developed and incorporated into a lesson plan may improve learning. In fact, instructors' use of questions has such an impact on learning that it can be considered an indicator of their overall effectiveness. Instructors may improve their questioning technique by carefully planning what questions to ask, when and how to ask them so as to improve their instructional ability.

Questions can be posed throughout a lesson to:

- determine the cadets' level of comprehension of previously taught related material;
- create and maintain interest by keeping the cadets mentally alert and making them feel more involved in the lesson;
- guide and provoke thinking by carefully selecting questions and following answers with other questions as the lesson progresses; and
- confirm learning, especially for knowledge lessons, by asking questions at the end of each TP and at the end of the lesson.

CONFIRMATION OF TEACHING POINT 1

QUESTIONS

- Q1. Why is questioning such an important aspect of instruction?
- Q2. How can instructors improve their questioning technique?
- Q3. What are four purposes of questioning?

ANTICIPATED ANSWERS

- A1. Questioning has a big impact on learning and is considered an indicator of an instructor's effectiveness.
- A2. By planning what questions to ask and when and how to ask them.
- A3. To determine comprehension of previously learned material, create and maintain interest, guide and provoke thinking, and to confirm learning.

Teaching Point 2**Describe the Qualities of a Good Question**

Time: 5 min

Method: Interactive Lecture

QUALITIES OF A GOOD QUESTION

Questions used during a lesson should be written out ahead of time. Instructors who consistently pay attention to writing good quality questions will improve their instruction and learn to instinctively phrase good questions when the situation demands it during a lesson.

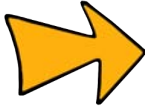

Often the cadets who are being instructed ask questions for clarification. Effective instructors create a classroom atmosphere that encourages cadets to ask questions, which are relevant to the lesson.

The exact wording of a question is determined by its purpose and the situation in which it is asked. While the wording may vary, all questions should be:

- brief, complete and easily understood;
- stated clearly using simple language;
- a challenge to cadets to apply their knowledge;
- not so difficult that only a few cadets can answer; and
- relevant to the lesson by reinforcing and supporting the teaching points.

CONFIRMATION OF TEACHING POINT 2**QUESTIONS**

Q1. Why should questions be written out ahead of time?

Q2. How can instructors learn to ask better quality questions while instructing?

Q3. What are five qualities of good questions?

ANTICIPATED ANSWERS

A1. Questions written out ahead of time are of better quality and will improve instruction.

A2. By crafting good quality questions, the question-making process will become instinctive.

A3. Brief and complete, clearly stated, challenging, not too difficult, and relevant.

Teaching Point 3**Describe Types of Questions**

Time: 5 min

Method: Interactive Lecture



All questions may be categorized as either participatory or evaluative. Participatory questions are used during a lesson to create and maintain interest, to keep cadets mentally alert and to guide thought. Evaluative questions are used at the beginning of a lesson to

determine retention of previously taught material or at the end of a TP or lesson to confirm comprehension of new material.

There are many types of questions but those most commonly recognized include:

Lead-Off. Questions, which are used to begin a lecture or start a discussion. This type of question does not necessarily require a verbal or written response and is designed to get the cadets thinking about the topic of the lesson or the issue being discussed.

Example: “What does being a good cadet mean to you?”

Follow-Up. Questions that are used to further stimulate the cadets’ thinking about the topic of the lesson or point of discussion. As the name suggests they are supplementary questions related to the initial lead-off question or are questions, which are phrased on the spot to probe an answer to a previous question or extend a point of discussion.

Example: “Identify an item, just mentioned in question one, that can be considered both a good and bad cadet quality.”

Overhead. Questions that are asked to the whole group without indicating who is to reply. There will be several answers to this type of question and everyone should be given a chance to respond.

Example: “Identify one factor that can determine if a cadet quality is good or bad.”

Direct. Questions that are the opposite of overhead questions because someone is directed to answer. These questions can be used to draw in those who are reluctant to take part in discussions, to prompt cadets who are inattentive or to get a discussion back on track.

Example: “Cadet I.M. Reluctant, can you think of another factor which determines if a cadet quality is good or bad?”

Reverse or Relay. Questions are used to keep the discussion in the hands of the cadets. Instead of answering a question posed by a cadet the instructor can reverse the question and return it to the person who asked it or relay it to another member of the class.

Example: “Cadet C. Legs, can you answer Cadet I.M. Reluctant’s question?”

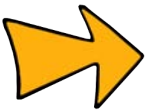

Never use reverse or relay as an escape mechanism for questions you cannot answer. Always admit that you don’t know the answer and follow up later rather than use reverse and relay.

CONFIRMATION OF TEACHING POINT 3

QUESTIONS

- Q1. Which type of question does not necessarily require a response?
- Q2. Which type of question can be used to encourage cadets to take part in a discussion?
- Q3. What is one thing to avoid when using reverse and relay questions?

ANTICIPATED ANSWERS

- A1. Lead-off.
- A2. Direct.

A3. Trying to hide the fact that an instructor doesn't know the answer to a question.

Teaching Point 4

Conduct an Activity Where the Cadets Will Practice Posing Questions Using the Pose, Pause, Pounce, Ponder and Praise Sequence

Time: 10 min

Method: In-Class Activity

ACTIVITY

OBJECTIVE

The objective of this activity is to introduce cadets to a posing questions sequence that they can follow when asking questions while instructing, particularly during M309.07 (Instruct a 15-Minute Lesson, Section 7).

RESOURCES

- Posing questions sequence handout located at Annex E,
- Questions handout located at Annex F,
- Posing questions rubric located at Annex G, and
- Posing questions checklist located at Annex H.

ACTIVITY LAYOUT

Set up work stations, if necessary, labelled A, B, C, etc. and place the following at each station:

- a copy of the posing questions sequence handout,
- a copy of the questions, and
- pens/pencils.



If possible brief the assisting staff and the cadets prior to the lesson.



The activity can be used with one group of five to ten cadets or several smaller groups if numbers warrant. The objective is to have each cadet follow the question posing sequence for at least one question but they can ask more than one if necessary. If the group is larger than five other questions can be devised using the children's story, "Goldilocks and the Three Bears."

ACTIVITY INSTRUCTIONS

Divide cadets into groups, if necessary, and assign a supervisor and letter name to each group.

1. Brief the assisting staff that they will be expected to:
 - (a) assign each cadet in their group a number from one to five indicating the order in which they will take part in the activity;

- (b) move their groups to the appropriately named area to conduct the activity;
 - (c) read the introduction to the children’s story, “Goldilocks and the Three Bears” to the cadets;
 - (d) ask Cadet # 1 to pose the first question from Annex F and record information on the checklist describing their performance;
 - (e) carry out the same procedure for each succeeding cadet;
 - (f) provide feedback to each cadet regarding their performance;
 - (g) return the group to the main area; and
 - (h) give the completed posing questions checklist to the instructor.
2. Ensure that assisting staff have a copy of Annexes E to H.
 3. Brief the cadets that they will:
 - (a) listen to a short introduction to the children’s story, “Goldilocks and the Three Bears”;
 - (b) use a question posing sequence to ask one question to their group based on the children’s story, “Goldilocks and the Three Bears”; and
 - (c) be supervised and corrected on the spot if they do not follow the posing questions sequence properly.
 4. Have the cadets begin the activity.
 5. Circulate throughout the training area observing the groups as they take part in the activity.
 6. Debrief the cadets on their performance.

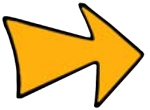

Remind cadets that the activity was designed to introduce a posing questions sequence that they can follow when asking questions while instructing, particularly during M309.07 (Instruct a 15-Minute Lesson, Section 7).

SAFETY

N/A.

CONFIRMATION OF TEACHING POINT 4

The cadets’ participation in the activity will serve as the confirmation of this TP.

END OF LESSON CONFIRMATION

QUESTIONS

- Q1. What are the four purposes for asking questions?
- Q2. List two qualities of a good question.
- Q3. List two types of questions most commonly recognized.
- Q4. List the five parts of the question posing sequence.

ANTICIPATED ANSWERS

- A1. The four purposes of questions are:
- to determine the cadets' level of comprehension of previously taught material;
 - to create and maintain interest;
 - to guide and provoke thinking; and
 - to confirm learning of new material.
- A2. Good questions should be brief and complete, written clearly using simple language, challenging, not too difficult and relevant to the lesson.
- A3. The types of questions most commonly recognized are lead-off questions, follow-up questions, overhead questions, direct questions and reverse or relay questions.
- A4. The five parts of the question posing sequence are pose, pause, point, ponder and praise.

CONCLUSION

HOMEWORK/READING/PRACTICE

N/A.

METHOD OF EVALUATION

N/A.

CLOSING STATEMENT

The question is an important tool for the instructor. It is useful for instructors to know the purposes, qualities and types of questions but should keep in mind that this knowledge alone will not necessarily improve questioning technique. Carefully writing out questions before hand and asking them properly are just as important when using questions while instructing a lesson.

INSTRUCTOR NOTES/REMARKS

N/A.

REFERENCES

- A0-055 A-P9-050-000/PT-006 Director Training and Education Policy. (2002). *Canadian Forces Individual Training and Education System* (Vol. 6). Ottawa, ON: Department of National Defence.
- A0-056 A-P9-050-000/PT-005 Director Training and Education Policy. (2001). *Canadian Forces Individual Training and Education System* (Vol. 5). Ottawa, ON: Department of National Defence.
- A0-057 A-CR-CCP-913/PT-001 Cadet Instructors List Training School. (1978). *Technique of Instruction*. Ottawa, ON: Department of National Defence.

THIS PAGE INTENTIONALLY LEFT BLANK



COMMON TRAINING
PHASE THREE
INSTRUCTIONAL GUIDE



SECTION 5

EO M309.05 – SELECT APPROPRIATE INSTRUCTIONAL AIDS

Total Time:

60 min

PREPARATION

PRE-LESSON INSTRUCTIONS

Resources needed for the delivery of this lesson are listed in the lesson specification located in A-CR-CCP-603/PG-001, Chapter 4. Specific uses for said resources are identified throughout the instructional guide within the TP for which they are required.

Review the lesson content and become familiar with the material prior to delivering the lesson.

The activity in TP 2 uses learning stations. Learning stations are a form of group work where the cadets learn by sorting through the information presented. When setting up learning stations, ensure there is enough room for each cadet to be comfortable and have adequate space for writing down information. When the cadets arrive at a learning station, all required information shall be available. These stations should be placed close together to minimize time for movement; however far enough apart to avoid interruptions from other groups. For this lesson, choose and set up five learning stations.

Photocopy the handouts located at Annexes I and J and place a copy of each at the appropriate learning station.

Samples of instructional aids available at the corps should be used during this lesson.

PRE-LESSON ASSIGNMENT

N/A.

APPROACH

An interactive lecture was chosen for TP 1 to introduce instructional aids, as it allows the instructor to deliver new information while encouraging the cadets to actively participate by asking and responding to questions.

An in-class activity was chosen for TP 2 as it is an interactive way to introduce the cadets to the different types of instructional aids and to confirm the cadets' comprehension of the material presented.

INTRODUCTION

REVIEW

N/A.

OBJECTIVES

By the end of this lesson the cadet shall have identified and selected appropriate instructional aids for a given topic.

IMPORTANCE

It is important for cadets to know that selecting appropriate instructional aids is an important part of pre-lesson preparation. Using instructional aids during a lesson helps stimulate the cadets' interest and helps them comprehend and recall the new material.

Teaching Point 1

Describe Instructional Aids

Time: 5 min

Method: Interactive Lecture

INSTRUCTIONAL AIDS

Instructional aids consist of various types of learning support that emphasize and clarify teaching points. Instructional aids include handouts, verbal support, audiovisual aids, simulators and real equipment. Instructional aids can be produced locally or purchased externally but must:

- be relevant to the teaching point;
- support learning; and
- be appropriate to the cadets' background and needs.

Instructional aids can be categorized as:

- **Training Aids.** Training aids refer to all types of learning support instructors use to instruct the lesson.
- **Learning Aids.** Learning aids refer to all the materials the cadets use to participate in the lesson and comprehend the material.

CONFIRMATION OF TEACHING POINT 1

QUESTIONS

- Q1. How can instructional aids support learning?
- Q2. How can instructional aids be obtained?
- Q3. What is the difference between a training aid and a learning aid?

ANTICIPATED ANSWERS

- A1. Instructional aids support learning by emphasizing and clarifying teaching points.
- A2. Instructional aids can be produced locally or purchased externally.
- A3. A training aid is used by the instructor to instruct the lesson and a learning aid is used by the cadet to participate in the lesson and comprehend the material.

Teaching Point 2**Conduct an Activity Where the Cadets Will Identify Types of Instructional Aids and Select an Instructional Aid Appropriate for a Given Topic**

Time: 45 min

Method: In-Class Activity

BACKGROUND KNOWLEDGE

The saying “a picture is worth a thousand words”, describes the effectiveness of instructional aids. New instructional aids are being developed all the time and it is important for instructors to know what aids are available, when to use them and how to use them. Some of the more common instructional aids are described in Annex I.



“Show 'em as well as tell 'em!” Cadets will remember more for longer periods of time.

ACTIVITY**OBJECTIVE**

The objective of this activity is to have cadets identify types of instructional aids and select an instructional aid appropriate for a given topic.

RESOURCES

- Instructional aids information sheets,
- Worksheets,
- Stopwatch,
- Signalling device,
- Flip chart paper,
- Coloured markers, and
- Pens/pencils.

ACTIVITY LAYOUT

Set up and label five learning stations “Instructional Aids”, “Verbal Support”, “Audiovisual Aids”, “Simulators and Training Equipment” and “Select an Instructional Aid.”

ACTIVITY INSTRUCTIONS

1. Divide the cadets into five groups and place one group at each learning station.
2. Assign each group a leader. Have the group leader assign a recorder and a reader.
3. Have the cadets read the information sheets and fill out a worksheet on each aspect of instructional aids. It is necessary for each group to fill out only one worksheet.
4. After eight minutes, have the groups rotate clockwise to the next station, where they will have another eight minutes to complete a worksheet.

5. Rotate the groups through the remaining stations.
6. Have the cadets share the information they recorded from each station.

SAFETY

N/A.

CONFIRMATION OF TEACHING POINT 2

The cadets' participation in the activity will serve as the confirmation of this TP.

END OF LESSON CONFIRMATION

The cadets' participation in the instructional aids activity in TP 2 will serve as the confirmation of this lesson.

CONCLUSION

HOMEWORK/READING/PRACTICE

N/A.

METHOD OF EVALUATION

This EO is assessed IAW A-CR-CCP-603/PG-001, Chapter 3, Annex B, Appendix 3 (309 PC).

CLOSING STATEMENT

Instructional aids appeal to all five senses but mainly to our senses of sight and hearing. It has often been reported that 75 percent of all learning happens through sight and that you remember 50 percent more when you both see and hear the information. It naturally follows therefore, that learning is enhanced when instructional aids are used.

INSTRUCTOR NOTES/REMARKS

Samples of instructional aids available at the corps should be used during this lesson.

REFERENCES

- A0-055 A-P9-050-000/PT-006 Director Training and Education Policy. (2002). *Canadian Forces Individual Training and Education System*. (Vol. 6). Ottawa, ON: Department of National Defence.
- A0-056 A-P9-050-000/PT-005 Director Training and Education Policy. (2001). *Canadian Forces Individual Training and Education System*. (Vol. 5). Ottawa, ON: Department of National Defence.
- A0-057 A-CR-CCP-913/PT-001 Cadet Instructors List Training School. (1978). *Technique of Instruction*. Ottawa, ON: Department of National Defence.
- A0-058 A-P9-050-000/PT-004 Director Training and Education Policy. (1999). *Canadian Forces Individual Training and Education System*. (Vol. 4). Ottawa, ON: Department of National Defence.
- C0-194 Dynamic Flight, Inc. *Instructional Aids and Training Technologies*. (2003). Retrieved March 20, 2008, from http://www.dynamicflight.com/avcfibook/inst_aids/.



COMMON TRAINING
PHASE THREE
INSTRUCTIONAL GUIDE



SECTION 6
EO M309.06 – PLAN A LESSON

Total Time:

60 min

PREPARATION

PRE-LESSON INSTRUCTIONS

Resources needed for the delivery of this lesson are listed in the lesson specification located in A-CR-CCP-603/PG-001, Chapter 4. Specific uses for said resources are identified throughout the instructional guide within the TP for which they are required.

Review the lesson content and become familiar with the material prior to delivering the lesson.

Photocopy the lesson specification and instructional guide handout located at Annex K, the blank lesson plan located at Annex L and the plan a lesson checklist located at Annex M for each cadet.

Photocopy the lesson specifications and instructional guides located at Annexes O to AC as required.

PRE-LESSON ASSIGNMENT

N/A.

APPROACH

An interactive lecture was chosen for TPs 1–3 to present basic material on how to research lesson content and how to prepare for a lesson.

A practical activity was chosen for TP 4 to allow the cadets to plan a lesson in a structured and controlled environment. This activity contributes to the development of lesson-planning skills and will serve as preparation for EO M309.07 (Instruct a 15-Minute Lesson, Section 7).

INTRODUCTION

REVIEW

N/A.

OBJECTIVES

By the end of this lesson the cadet shall be expected to research lesson content and develop a lesson plan.

IMPORTANCE

It is important for cadets to research lesson content, prepare a lesson location and plan a lesson because these are critical steps to the success of a period of instruction. The preparation of a lesson location sets the tone for the lesson and a well-developed lesson plan provides structure and organization, guides the instructor through each stage of the lesson and ensures that all essential information is delivered.

Teaching Point 1

Explain How to Research Lesson Content

Time: 10 min

Method: Interactive Lecture



Some common abbreviations and terms used by training officers and instructors:

- **QSP.** Qualification Standard and Plan.
- **PO.** Performance Objective.
- **EO.** Enabling Objective.
- **TP.** Teaching Point.
- **PC.** Performance Check.
- **EC.** Enabling Check.
- **IG.** Instructional Guide.



Distribute the lesson specification and instructional guide handout located at Annex K to each cadet.

ENABLING OBJECTIVE AND LESSON SPECIFICATION

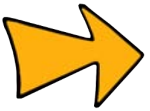

Enabling objectives and lesson specifications can be found in the Qualification Standard and Plan (QSP), Chapter 4.

Performance objectives are broken down into a series of enabling objectives and lesson specifications. The enabling objective consists of Paragraphs 1. to 3. (as illustrated in Figure 9-6-1). The information in these paragraphs will answer three questions:

1. What will the cadet be expected to be able to do by the end of this lesson?
2. Under what conditions will the cadet be expected to carry out the performance?
3. How well or to what standard will the cadet be expected to perform?

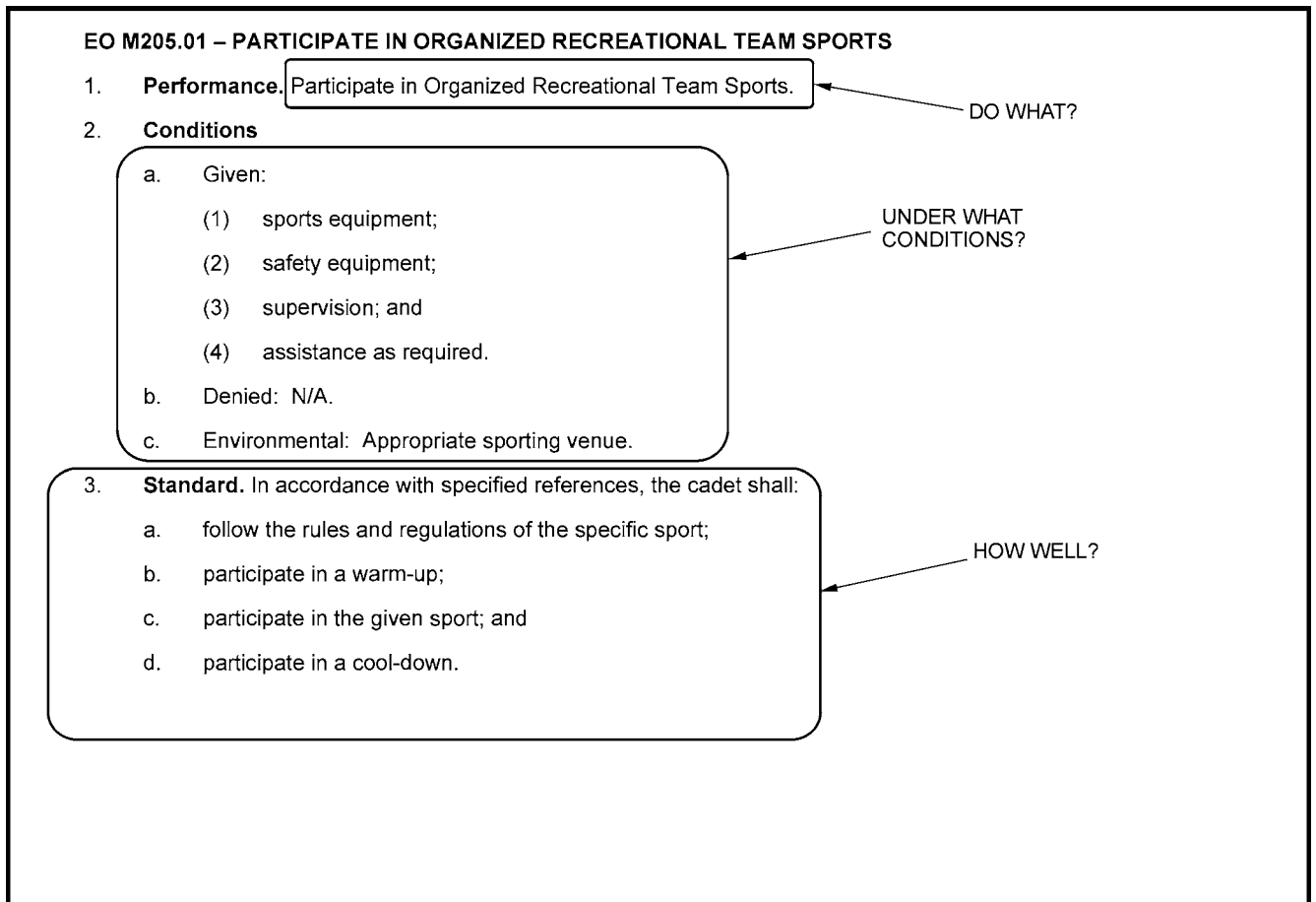

Director Cadets 3, 2008, Ottawa, ON: Department of National Defence

Figure 9-6-1 Enabling Objective

Paragraphs 4. to 11. are known as the lesson specification. The lesson specification provides information about the content to be taught, teaching methods, time, references, training aids, learning aids, test details and remarks.

In Paragraph 4., the TPs are usually described in a table where information is provided on the content taught in each TP, the suggested teaching method, the time for each TP and references (as illustrated in Figure 9-6-2).

4. Teaching Points

TP	Description	Method	Time	Ref
TP1	Introduce cadets to a specific sport's rules and regulations, to include: a. an overview of how to play the sport; and b. rules and regulations of the sport.	Interactive Lecture	10 min	C0-001
TP2	Conduct a warm-up session, composed of light cardiovascular exercises, meant to: a. stretch the muscles; b. gradually increase respiratory action and heart rate; c. expand the muscles' capillaries to accommodate the increase in blood circulation; and d. raise muscle temperature to facilitate reactions in muscle tissue.	Practical Activity	10 min	C0-002 (pp. 109 to 113) C0-089
TP3	Supervise the cadets' participation in a given sports activity.	Practical Activity	50 min	

Director Cadets 3, 2008, Ottawa, ON: Department of National Defence

Figure 9-6-2 Teaching Points

Paragraph 5. outlines how much time is spent on the introduction/conclusion and the different teaching methods. Paragraph 6. offers substantiation or reasons why certain teaching methods were recommended for each TP. Paragraph 7. provides a list of references used to compile the content in Paragraph 4. (as illustrated in Figure 9-6-3).

5.	Time	
a.	Introduction/Conclusion:	10 min
b.	Interactive Lecture:	10 min
c.	Practical Activity:	70 min
d.	Sub-total:	90 min
e.	Total (three sessions):	270 min
6.	Substantiation	
a.	An interactive lecture was chosen for TP1 to illustrate the application of rules, principles, or concepts of the specific sport to be played.	
b.	A practical activity was chosen for TP2-4 as it allows cadets to participate in sports activities in a safe and controlled environment. This activity contributes to the development of sports skills in a fun and challenging setting.	
7.	References	
a.	C0-001 (ISBN 0-88011-807-5) Hanlon, T. (1998). <i>The Sports Rules Book: Essential Rules for 54 Sports</i> . USA: Human Kinetics Publishers, Inc.	
b.	C0-002 (ISBN 0-88962-630-8) LeBlanc, J., and Dickson, L. (1997). <i>Straight Talk About Children and Sport: Advice for Parents, Coaches, And Teachers</i> . Oakville, ON and Buffalo, NY: Mosaic Press.	

Director Cadets 3, 2008, Ottawa, ON: Department of National Defence

Figure 9-6-3 Paragraphs 5. to 7.

Paragraphs 8. and 9. list the training aids and learning aids required for the lesson. Training aids are the materials that are required by the instructor to instruct the lesson and learning aids are the materials that will be required by the cadet to participate in the lesson (as illustrated in Figure 9-6-4).

8.	Training Aids
a.	Sports/safety equipment appropriate for the activity;
b.	First aid kit;
c.	Whistles; and
d.	Stopwatch.
9.	Learning Aids. Sports equipment.

Director Cadets 3, 2008, Ottawa, ON: Department of National Defence

Figure 9-6-4 Training Aids and Learning Aids

Paragraph 10. is test details, which is information about the evaluation to be conducted. Paragraph 11. is remarks, which describe any other information that may be useful to the Training Officer or instructor (as illustrated in Figure 9-6-5).

10. **Test Details.** N/A.

11. **Remarks**

- a. The CCO list of approved sports is located at A-CR-CCP-602/PF-001, Chapter 5, Annex A.
- b. Recreational sports can be carried out as nine periods during a supported day or over three sessions of three periods each.

Director Cadets 3, 2008, Ottawa, ON: Department of National Defence

Figure 9-6-5 Test Details and Remarks



Test details will be described in one of the following ways:

- **N/A.** No evaluation for this EO.
- **This EO is assessed IAW Chapter 3, Annex B, Appendix 3 (209 PC).** There is a performance check (PC) associated with this EO, refer to Chapter 3, Annex B, Appendix 3 for details.
- **This EO is assessed IAW Chapter 3, Annex B, Appendix 3 (209 EC 01).** There is an enabling check (EC) associated with this EO, refer to Chapter 3, Annex B, Appendix 3 for details.

INSTRUCTIONAL GUIDE

The IG is used in conjunction with the QSP and other resources to conduct training. IGs should be reviewed in conjunction with lesson specifications so that the instructor can adequately plan and prepare their lesson. IGs do not replace lesson plans but offer written content, supporting figures and suggestions on how to instruct a lesson. The following are the six sections of an IG:

1. preparation,
2. introduction,
3. body,
4. conclusion,
5. references, and
6. annexes.

Preparation





The preparation section provides information about where to find the lesson specification and any instructions to the instructor such as reviewing lesson content, photocopying handouts, pre-lesson assignments and the approach and substantiation as to why certain teaching methods were recommended for each TP.

Introduction

The introduction section provides information to the instructor about review that may be necessary, what the cadet will be expected to do by the end of the lesson and why the knowledge/skills are important.

The Body

The body of the IG contains all of the TPs and content listed in Paragraph 4. of the lesson specification in greater detail. The body provides suggested teaching methods, note boxes with special instructions or information (as illustrated in Figure 9-6-6), lesson content, figures, activities and confirmation questions.

Note Boxes:	
	Special note to the instructor.
	Key information to pass along to the cadets.
	Refer to the following CF regulations and policies.
	Points of interest or special instructions the instructor should pass along to the cadets.

Director Cadets 3, 2008, Ottawa, ON: Department of National Defence

Figure 9-6-6 Note Boxes

The Conclusion

The conclusion section states any homework/reading/practice that may be required of the cadet and the method of evaluation as stated in the lesson specification. The conclusion section also provides a closing statement to be spoken aloud to the cadets and any additional instructor notes/remarks.

References

The reference section lists the references used to create the lesson specification and instructional guide. In some cases, an IG may direct the instructor to a specific reference to be used during a lesson. In most cases this section is only used to identify where the content of the lesson has been drawn from.

Annexes

The annex section contains information that may range from pre-made training aids, learning aids such as handouts and additional information for activities.

RESEARCHING LESSON CONTENT

To plan for a lesson, the cadets will need to research lesson content and become familiar with the conditions, standard, TPs, lesson content and the time allocated for the EO and TPs.

The Canadian Forces employs an acronym that is used to provide a framework for the instructor to gather and organize the reference material into an efficient and practical lesson plan. The initialism is CCSAM.

Collect. During this step, the instructor researches the material to be covered in the period of instruction using course documents such as the lesson specification, IG and listed references. In situations where no course documents exist, the instructor will research the material to be taught using whatever references exist.

Consider. During this step, the instructor sifts through all of the material found in the collection step and determines what is relevant and current.

Select. During this step, instructor selects the material that is appropriate for the lesson. The instructor also selects the method of instruction to be used.

Arrange. During this step, the instructor arranges the material into stages that allow for the information to be presented in a logical sequence.

Master. During this step, the instructor writes the lesson plan.



The use of CCSAM is a good general practice. In most cases for cadet training these steps have been completed during the development of the lesson specifications and IGs. The instructor may need to only transpose the information into the pertinent parts of their lesson plan.

CONFIRMATION OF TEACHING POINT 1

QUESTIONS

- Q1. Where can a lesson specification be found?
- Q2. What information can be found in the preparation section of an instructional guide?
- Q3. What information can be found in the body of an instructional guide?

ANTICIPATED ANSWERS

- A1. In the Qualification Standard and Plan (QSP), Chapter 4.
- A2. The preparation section provides information about where to find the lesson specification and any instructions to the instructor such as reviewing lesson content, photocopying handouts, pre-lesson assignments and the approach and substantiation as to why certain teaching methods were recommended for each TP.
- A3. The body of the IG contains all of the TPs and content listed in Paragraph 4. of the lesson specification in greater detail. The body provides suggested teaching methods, note boxes with special instructions or information (as illustrated in Figure 9-6-6), lesson content, figures, activities and confirmation questions.

Teaching Point 2

Explain How to Prepare for a Lesson

Time: 5 min

Method: Interactive Lecture

PREPARING FOR A LESSON

A well-prepared and positive learning environment can enhance a lesson and the learning experience. The cadets' attention will not only be focused on the instructor but also on the environment around them. Effort put into lesson preparation and presentation can be wasted if the environment is not prepared for optimal learning.

Selecting a Lesson Location

When selecting a lesson location the instructor should consider the following:

- the type of training to be conducted (e.g., general cadet knowledge versus ropework);
- any activities outlined in the instructional guide;
- the size of the group being trained;
- the size of the location;
- the lighting of the location;
- the ventilation of the location;
- the suitability of the location regarding noise distractions; and
- the suitability of the location regarding the use of visual aids.

Setting Up the Location

After selecting a lesson location, the instructor must take steps to ensure the location is clean and arranged properly for an optimal training environment.

Cleanliness. A clean training area will prevent distractions and will positively affect motivation. Cadets will notice a messy, disorganized area immediately and will be distracted before the class begins. The room must be clean and well-organized with the boards wiped clean, debris picked up, garbage cans empty, etc.

Seating Arrangements. Cadets must be able to see the instructor, the visual aids and each other to achieve maximum participation. Some arrangements will not be possible given the allotted space. The following descriptions and diagrams depict possible seating arrangements:

- **U-Shaped.** Allows the instructor to see all cadets easily and also allows trainees to see each other.

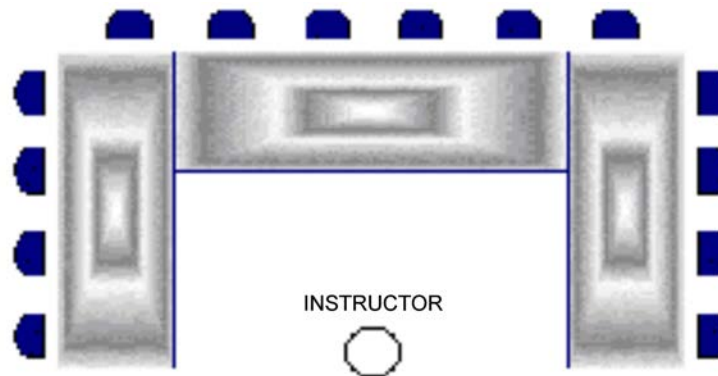

E. Jenson, Super Teaching: Mastering Strategies for Building Trainee Success, The Brain Store Inc. (p. 109)

Figure 9-6-7 U-Shaped

- **Chevron Shape.** Found mostly in auditorium-style rooms and can accommodate large groups.

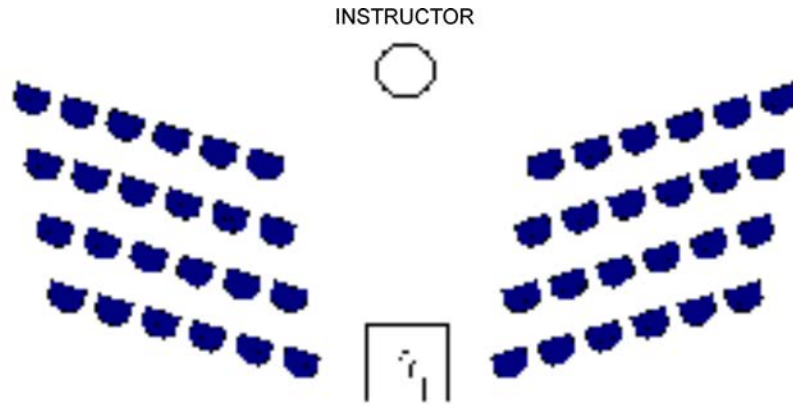

E. Jenson, Super Teaching: Mastering Strategies for Building Trainee Success, The Brain Store Inc. (p. 109)

Figure 9-6-8 Chevron Shape

- **Horseshoe.** Can be employed for two groups. This set-up works well during debates and in-class activities.

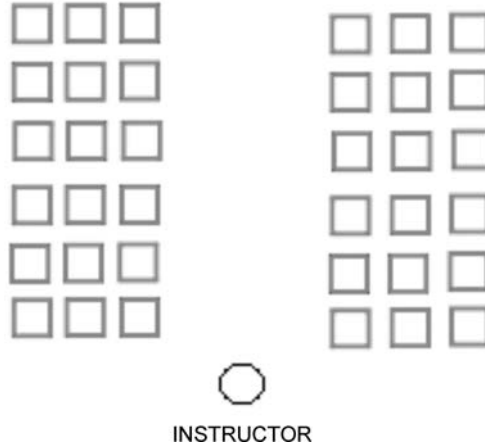

E. Jenson, Super Teaching: Mastering Strategies for Building Trainee Success, The Brain Store Inc. (p. 109)

Figure 9-6-9 Horseshoe

- **Semicircle.** Instructor has a good view of the cadets.

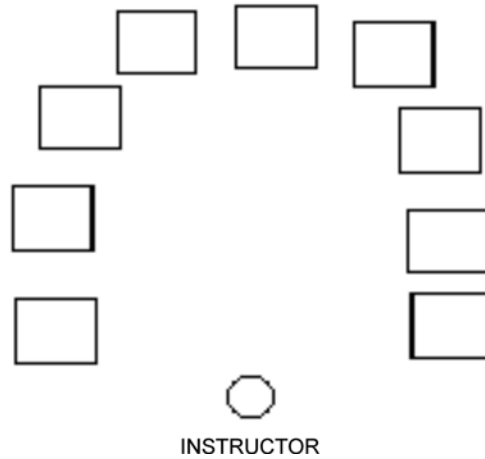

E. Jenson, Super Teaching: Mastering Strategies for Building Trainee Success, The Brain Store Inc. (p. 109)

Figure 9-6-10 Semicircle

- **Standard in Line.** Allows for more frontal coverage with less depth front to back.

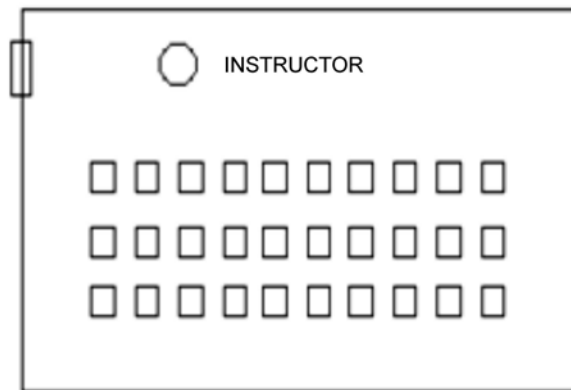

E. Jenson, Super Teaching: Mastering Strategies for Building Trainee Success, The Brain Store Inc. (p. 109)

Figure 9-6-11 Standard in Line

CONFIRMATION OF TEACHING POINT 2

QUESTIONS

- Q1. What should the instructor consider when selecting a lesson location?
- Q2. Why is it important to have a clean lesson location?
- Q3. What are three seating arrangements?

ANTICIPATED ANSWERS

- A1. When selecting a lesson location the instructor should consider the following:
- the type of training to be conducted (e.g., general cadet knowledge versus ropework);
 - any activities outlined in the instructional guide;
 - the size of the group being trained;
 - the size of the location;

- the lighting of the location;
- the ventilation of the location;
- the suitability of the location regarding noise distractions; and
- the suitability of the location regarding the use of visual aids.

A2. Cadets will notice a messy, disorganized area immediately and will be distracted before the class begins.

A3. Seating arrangements are:

- u-shaped,
- chevron shape,
- horseshoe,
- semicircle, and
- standard in line.

Teaching Point 3

Describe the Lesson Plan Format

Time: 10 min

Method: Interactive Lecture

LESSON PLAN FORMAT

The lesson plan is a way for the instructor to organize the lesson and summarize the information included in the lesson specification, the IG and their personal ideas. Lesson plans provide a set of detailed directions for delivering one or more periods of instruction.

The lesson plan is arranged in this specific order:

Part	Purpose
1. Introduction	Builds the cadets' interest and motivation.
2. Body	Presents and explains each TP.
3. End of Lesson Confirmation	Confirms cadets' comprehension of the lesson.
4. Conclusion	Summarizes key points and identifies future lessons.

Introduction

The introduction is the instructor's first verbal interaction with the cadets. It should capture the cadets' interest. The following should be included in the introduction of a lesson plan:

- **What.** A description of what the cadets will be expected to accomplish at the end of the lesson.
- **Where.** A description of how and where the lesson fits into the Cadet Program.
- **Why.** A description of why it is important for the cadets to achieve the objectives.



Read the Objective and Importance paragraphs in the IG for help in writing the introduction of the lesson plan.

Body

The body of the lesson plan is where the content is presented, explained and supported. Each TP directs the instructor and the cadets.

Each TP in the lesson includes:

- **Introduction.** Briefly introduce the content to be taught during the TP.
- **Teaching Method.** Identify which teaching method has been chosen for the TP.
- **Lesson Content.** Present the content of the TP in a clear and logical order, from easy to difficult, known to unknown and simple to complex.
- **Confirmation.** May be oral questions, games, role play, in-class activities or practical activities. IGs offer suggestions for how to confirm TPs. Instructors may choose to use those confirmation suggestions or develop their own.

End of Lesson Confirmation

The lesson plan should outline procedures to be used to confirm the learning of the TP. End of lesson confirmations are carried out to ensure that the cadets have understood the whole lesson and that any weaknesses in performance are identified so they can be corrected.

Confirmation activities are based on the lesson objectives. The end of lesson confirmation may be oral questions, games, role-play, in-class activities or practical activities. IGs offer suggestions for how to conduct end of lesson confirmations. Instructors may choose to use those confirmation suggestions or develop their own.

Conclusion

The conclusion of a lesson summarizes the key points and links them to the coming lessons and their practical use.

A Summary of Important Points and Weak Areas. The summary reviews the main TPs. The depth of the summary will be determined by the lesson objectives and the results of the cadets' end of lesson confirmation. If the cadets achieved the objectives successfully, the summary may be brief. If they experienced some difficulties, the instructor should identify them here and indicate how the issue will be addressed.

Re-Motivation Statement. The re-motivation statement restates the importance of the lesson (the "why") and re-motivates the cadets. The instructor should also take this time to address any precautions the cadets should be aware of when applying the knowledge in a practical setting and give an overview of the next lesson.



Read the Closing Statement paragraph in the IG for help in writing the conclusion of the lesson plan.

CONFIRMATION OF TEACHING POINT 3

QUESTIONS

- Q1. What are the four sections of a lesson plan?
- Q2. What three questions are answered in the introduction?
- Q3. What are the four sections of a teaching point?

ANTICIPATED ANSWERS

A1. The four sections of a lesson plan are:

- introduction,
- body,
- end of lesson confirmation, and
- conclusion.

A2. The three questions answered in the introduction are:

- what,
- where, and
- why.

A3. The four sections of a teaching point are:

- introduction,
- teaching method,
- lesson content, and
- confirmation.

Teaching Point 4

Supervise and Provide Assistance While the Cadets Plan a Lesson

Time: 25 min

Method: Practical Activity

In EO M309.07 (Instruct a 15-Minute Lesson, Section 7) the cadets will be expected to instruct a lesson using a lesson plan, an instructional aid and the appropriate instructional method. The lesson plan created in this EO will be used to instruct that lesson.



Distribute the blank lesson plan located at Annex L and the plan a lesson checklist located at Annex M to each cadet.



As the cadets begin to place information in the lesson plan, they will need to know what information to place in the two columns not discussed in the previous TP.

Time. This column reminds the instructor how long to spend on each section of the lesson.

Notes. The instructor can place information in this column as a reminder of when to distribute a handout, to pass along special information to the class or information about a confirmation activity.

INSTRUCTIONS AND REMINDERS

LESSON PLAN

EO #:		Title of the EO:	
Instructor:		Location:	Total Time: min
TIME	INTRODUCTION		NOTES
3 min	What: Where: Why:		Distribute handouts here.
TIME	BODY		NOTES
10 min	TP1 Teaching Method: TP 2:		Use analogy here.

EXPECTED TIME

Director Cadets 3, 2008, Ottawa, ON: Department of National Defence

Figure 9-6-12 Lesson Plan

ACTIVITY

OBJECTIVE

The objective of this activity is to have the cadets plan a 15-minute lesson.

RESOURCES

- List of approved 15-minute topics located at Annex N, and
- Modified lesson specifications and instructional guides located at Annexes O to AC.

ACTIVITY LAYOUT

N/A.

ACTIVITY INSTRUCTIONS

1. Have each cadet choose a topic from the list of approved 15-minute topics.
2. Have the cadets use the lesson specification and IG for their chosen topic to help develop their lesson plan. Cadets shall be expected to teach their chosen lesson as part of M309.07 (Instruct a 15-Minute Lesson, Section 7).
3. Circulate around the room facilitating the activity and helping the cadets as required.



Ensure that cadets request all resources required to instruct their lesson.

SAFETY

N/A.

CONFIRMATION OF TEACHING POINT 4

The cadets' participation in the activity will serve as the confirmation of this TP.

END OF LESSON CONFIRMATION

The cadets' completion of a lesson plan will serve as the confirmation of this lesson.

CONCLUSION

HOMEWORK/READING/PRACTICE

The cadets should be prepared to instruct their lesson at the beginning of M309.07 (Instruct a 15-Minute Lesson, Section 7).

METHOD OF EVALUATION

This EO is assessed IAW A-CR-CCP-603/PG-001, Chapter 3, Annex B, Appendix 3 (309 PC).

CLOSING STATEMENT

Researching lesson content, preparing a lesson location and planning a lesson are critical steps in preparing a period of instruction. The preparation of a lesson location sets the tone for the lesson to be taught and a well-developed lesson plan provides structure and organization, guides the instructor through each stage of the lesson and ensures that all essential information is delivered.

INSTRUCTOR NOTES/REMARKS

EO M309.06 (Plan a Lesson, Section 6) should be scheduled at least one week prior to EO M309.07 (Instruct a 15-Minute Lesson, Section 7).

EO C309.02 (Plan a Lesson, A-CR-CCP-603/PG-001, Chapter 4, Section 10) may be scheduled as additional time for this EO.

REFERENCES

- A0-056 A-P9-050-000/PT-005 Director Training and Education Policy. (2001). *Canadian Forces Individual Training & Education System* (Vol. 5). Ottawa, ON: Department of National Defence.
- C0-192 (ISBN 0-9695066-2-7) Bender, P. (2000). *Secrets of Power Presentations*. Toronto, ON: The Achievement Group.
- C0-193 (ISBN 1-890460-02-8) Jenson, E. (1999). *Super Teaching: Mastering Strategies for Building Trainee Success*. San Diego, CA: The Brain Store Inc.



COMMON TRAINING
PHASE THREE
INSTRUCTIONAL GUIDE



SECTION 7

EO M309.07 – INSTRUCT A 15-MINUTE LESSON

Total Time:

90 min

PREPARATION

PRE-LESSON INSTRUCTIONS

Resources needed for the delivery of this lesson are listed in the lesson specification located in A-CR-CCP-603/PG-001, Chapter 4. Specific uses for said resources are identified throughout the instructional guide within the TP for which they are required.

Review the lesson content and become familiar with the material prior to delivering the lesson.

Photocopy the Instructional Techniques Assessment Form located at Annex AD for each cadet.

Ensure that all resources requested by the cadets are available.

PRE-LESSON ASSIGNMENT

N/A.

APPROACH

A practical activity was chosen for this lesson as it is an interactive way for cadets to develop instructional skills in a safe and controlled environment.

INTRODUCTION

REVIEW

N/A.

OBJECTIVES

By the end of this lesson the cadet shall have instructed a 15-minute lesson using a lesson plan, an appropriate method of instruction and an appropriate instructional aid.

IMPORTANCE

It is important for cadets to instruct a 15-minute lesson as it gives them the opportunity to practice instructional techniques in a peer setting and to receive feedback to further develop their confidence.

Teaching Point 1**Have the Cadets Instruct a 15-Minute Lesson**

Time: 85 min

Method: Practical Activity

ACTIVITY**OBJECTIVE**

The objective of this activity is to have the cadets instruct a 15-minute lesson in a peer setting using a lesson plan, an appropriate method of instruction and an appropriate instructional aid.

RESOURCES

- Presentation aids (e.g., whiteboard/flip chart/OHP) appropriate for the classroom/training area, and
- Instructional Techniques Assessment Form.

ACTIVITY LAYOUT

N/A.

ACTIVITY INSTRUCTIONS

1. Have the cadets provide a copy of their lesson plan to the assessor.
2. Determine the order in which cadets will instruct their lessons.
3. Have one cadet prepare the classroom/training area for their lesson.
4. Have one cadet instruct a 15-minute lesson using a written lesson plan, an appropriate method of instruction and an appropriate instructional aid (as prepared in EO M309.06 [Plan a Lesson, Section 6]).
5. Assess the cadet's lesson using the Instructional Techniques Assessment Form.
6. Upon completion of the lesson, provide feedback to the cadet.
7. Repeat Steps 3. to 6. until all cadets have instructed a lesson.



The Instructional Techniques Assessment Form located at Annex AD is used to provide feedback on the cadet's lesson and to introduce the cadet to the type of instructional techniques assessment they will receive in their future phase training. The grey areas of the form are those applicable to the 309 PC (A-CR-CCP-603/PG-001, Chapter 3, Annex B, Appendix 3) (e.g., the standard required for the achievement of PO 309). The remainder of the form is intended solely for the purposes of assessment for learning, providing the cadets with the feedback they need to improve their skills.

8. Debrief the cadets by providing feedback, focusing on:
 - (a) best practices,
 - (b) general trends and key areas for improvement, and
 - (c) re-motivation, highlighting the effort and accomplishments of the group.



If the group of cadets is large, divide them up into smaller groups and assign other instructors to aid with assessment and feedback.

SAFETY

N/A.

CONFIRMATION OF TEACHING POINT 1

The cadets' participating in the activity will serve as the confirmation of this TP.

END OF LESSON CONFIRMATION

The cadets' instructing a 15-minute lesson will serve as the confirmation of this lesson.

CONCLUSION

HOMEWORK/READING/PRACTICE

N/A.

METHOD OF EVALUATION

This EO is assessed IAW A-CR-CCP-603/PG-001, Chapter 3, Annex B, Appendix 3 (309 PC).

CLOSING STATEMENT

Practicing instructional skills in a peer setting allows for the development of skills necessary to become a competent instructor while further developing confidence and a sense of accomplishment.

INSTRUCTOR NOTES/REMARKS

Additional time for this EO is available in EO C309.03 (Instruct a 15-Minute Lesson, A-CR-CCP-603/PG-001, Chapter 4, Section 10).

REFERENCES

A0-055 A-P9-050-000/PT-006 Director Training and Education Policy. (2002). *Canadian Forces Manual of Individual Training and Education* (Vol. 6). Ottawa, ON: Department of National Defence.

THIS PAGE INTENTIONALLY LEFT BLANK



COMMON TRAINING
PHASE THREE
INSTRUCTIONAL GUIDE



SECTION 8

EO C309.01 – DELIVER A ONE-MINUTE VERBAL PRESENTATION

Total Time:

60 min

PREPARATION

PRE-LESSON INSTRUCTIONS

Resources needed for the delivery of this lesson are listed in the lesson specification located in A-CR-CCP-603/PG-001, Chapter 4. Specific uses for said resources are identified throughout the instructional guide within the TP for which they are required.

Review the lesson content and become familiar with the material prior to delivering the lesson.

Photocopy the list of topics located at Annex AE and the Verbal Presentation Feedback Form located at Annex AF for each cadet.

PRE-LESSON ASSIGNMENT

N/A.

APPROACH

A group discussion was chosen for TP 1 as it allows the cadets to interact with their peers and share their knowledge, experiences, opinions and feelings about public speaking.

An interactive lecture was chosen for TP 2 as it allows the instructor to explain the expectations of the cadets for the one-minute verbal presentation.

A practical activity was chosen for TP 3 as it is an interactive way to help the cadets develop effective-speaking skills in a safe and controlled environment.

INTRODUCTION

REVIEW

Review EO M309.03 (Describe Effective-Speaking Techniques, Section 3).

OBJECTIVES

By the end of this lesson the cadet shall have delivered a one-minute verbal presentation.

IMPORTANCE

It is important for cadets to practice effective-speaking techniques because this will develop the skills required to present information and build the self-confidence needed to speak in front of others.

Teaching Point 1

Review Effective-Speaking Techniques

Time: 15 min

Method: Group Discussion

BACKGROUND KNOWLEDGE



The purpose of the group discussion is to draw the following information from the group using the tips for answering/facilitating discussion and the suggested questions provided.

ELEMENTS OF VOICE CONTROL

One of the most important and effective tools of communication is voice control. The ability to use voice control to communicate effectively and place emphasis on important information is a fundamental skill that will be used while in front of an audience.

Pitch. How high or low a voice is. A change in pitch usually does not add any significance to a message however a pitch change will be noticed by the audience and will keep people involved.

Tone. The quality of the sound of a voice. Effective communicators will often change the tone of their voice to give emphasis to a single word or phrase to convey emotion and conviction.



Monotone. A sound without change of pitch or tone.

Volume. The quantity or power of sound or fullness of tone. A change in volume often signifies emphasis on a particular phrase or point. Environmental factors such as outside noise and room size must be taken into consideration to ensure the audience can hear the message being sent.

Speed. The rate or rapidity in which words are spoken. Speaking too fast or too slow can be distracting to an audience. It is important to communicate at a pace that ensures the audience can understand every word being said.

Pause. A break in speaking or reading. A pause is an important part of the communication process. A pause gives the audience an opportunity to digest what has been said and to ask questions. A pause is also an effective way to announce a change in subject or an important point.

Articulation. The clear and distinct pronunciation of a word. It is important to properly pronounce and articulate words to ensure the audience can understand the message being sent.

ELEMENTS OF PHYSICAL PRESENCE

It is estimated that 93 percent of the total meaning of a message comes from non-verbal communication and only 7 percent of meaning comes from the words themselves. Being aware of physical presence and its effect on a message being sent is an important element of effective communication.

Body Language

Body language or non-verbal communication is the process of communicating through conscious and unconscious gestures and expressions. Understanding that body language affects how a message is received and interpreted is an important tool for communicating effectively.

Facial Expressions. While 93 percent of the total meaning of a message comes from non-verbal communication, most of that meaning is communicated by the eyes, eyebrows and mouth. The movement of the eyes, eyebrows and mouth can result in an infinite variety of expressions to complement the spoken word. It is important that facial expressions match the tone of the message being sent to create emphasis and believability. A smile is the most important of all facial expressions. A smile adds sincerity to a message and will add to the likeability of the individual in front of the audience.

Eye Contact. Maintaining eye contact is an effective way of engaging an audience and building interest. Pausing two or three seconds on each member of the audience will make them feel as though they are involved in a one-on-one conversation. It is important to look at the entire room and scan from left to right, back to front.



Look for friendly, sympathetic faces to gain confidence and ease nervousness.

Gestures. The combination of hand, arm and shoulder movements can make a wide variety of gestures that can help add meaning to a message. Effective communicators will let their hands and arms move naturally to help give emphasis and emotion to a message. It is important not to point directly at members of the audience or let gestures become distracting.

Movement. Being aware of movement while in front of an audience is very important to communication. Movement will keep listeners engaged and interested in what is being said. Moving around the front of the room, toward and away from an audience and from side to side can help emphasize points. Too much or frantic movement can become distracting and will affect how a message is received.



Hands placed in pockets are typically a sign of nervousness or overconfidence.

Dress and Deportment

Effective communicators are constantly aware of their dress and deportment. Audiences will react differently to an individual who is well dressed and acts professionally when in front of them, than an individual who is poorly dressed and acts unprofessionally.

Dress. Effective communicators will always appear in clean, well-pressed and appropriate attire. Dressing appropriately for the event will help create confidence and credibility.

Deportment. An audience that sees an individual as being prepared, on time, appropriately dressed and confident will be much more receptive, than to an individual who is unprepared, late, poorly dressed and nervous. The most important element of deportment is displaying an interest in the subject; this will be noticed by the audience and will generate interest in the presentation.

PREPARATION

Effective speaking preparation is the most critical component of effective communication. Preparation will help ensure confidence, control nervousness and increase the likelihood of success when in front of an audience.

The following are the steps to effective-speaking preparation:

1. **Practicing.** Proper rehearsal will aid in memorizing content, which will allow for more eye contact and movement while in front of an audience. Memorizing the introduction and conclusion are the two most critical elements; a strong introduction will aid in gaining confidence and will draw the interest of the audience, a strong conclusion will aid in leaving a lasting impression on the audience. If possible, practice in front of a small group, speak aloud even when practicing alone and always practice while standing.
2. **Controlling Nervousness.** The feeling of nervousness prior to speaking in front of a group is normal and often can help if channeled effectively. The following actions can be taken to control nervousness:
 - (a) **Room Layout.** Become familiar with the layout of the room prior to speaking.
 - (b) **Materials.** Ensure notes, handouts and presentation aids are organized.
 - (c) **Equipment.** Ensure any equipment being used is in working order and ready to use.
 - (d) **Practice.** Spend time going over notes and rehearsing content.
 - (e) **Attitude.** Enter the room with a smile and a positive and confident attitude.
 - (f) **Breathing.** Take a deep breath before entering the room. Slow down the delivery if necessary and breathe from the diaphragm while speaking, not from the chest.
3. **Identifying a Friendly Face.** While walking in front of an audience, identify a friendly face. Making eye contact with a friendly face while beginning to speak will often give confidence while beginning the introduction and ultimately lead to success when addressing an audience.

GROUP DISCUSSION



TIPS FOR ANSWERING/FACILITATING DISCUSSION

- Establish ground rules for discussion, e.g., everyone should listen respectfully; don't interrupt; only one person speaks at a time; no one's ideas should be made fun of; you can disagree with ideas but not with the person; try to understand others as much as you hope they understand you; etc.
- Sit the group in a circle, making sure all cadets can be seen by everyone else.
- Ask questions that will provoke thought; in other words avoid questions with yes or no answers.
- Manage time by ensuring the cadets stay on topic.
- Listen and respond in a way that indicates you have heard and understood the cadet. This can be done by paraphrasing their ideas.
- Give the cadets time to respond to your questions.
- Ensure every cadet has an opportunity to participate. One option is to go around the group and have each cadet answer the question with a short answer. Cadets must also have the option to pass if they wish.
- Additional questions should be prepared ahead of time.

SUGGESTED QUESTIONS

- Q1. How can voice be varied to maintain class interest?
- Q2. How does physical presence affect how a message is received?

Q3. What is one of the most important elements of department?

Q4. What are some ways for controlling nervousness?



Other questions and answers will develop throughout the group discussion. The group discussion should not be limited to only those suggested.



Reinforce those answers given and comments made during the group discussion, ensuring the teaching point has been covered.

Teaching Point 2

Explain the Expectations of the One-Minute Verbal Presentation

Time: 10 min

Method: Interactive Lecture

EXPECTATIONS OF THE ONE-MINUTE VERBAL PRESENTATION

The expectations of the one-minute verbal presentation are to practice the following skills:

1. using effective speaking techniques to communicate ideas; and
2. speaking clearly and confidently in front of a group of peers.

Instructions

1. Each cadet is required to deliver a one-minute verbal presentation on a topic chosen from the list located at Annex AE.
2. Each cadet is permitted to use one piece of paper not larger than 8 1/2 inches by 11 inches for outline notes. Cadets are not permitted to read their presentations directly from the paper.
3. Cadets will not be given assistance during their presentations other than the signal from the timekeeper.
4. Cadets will be given feedback using the feedback form located at Annex AF. The feedback positively emphasizes what the cadet did well and areas for improvement.
5. Aids such as a podium, OHP or flip charts should be made available (where possible), if requested by the cadet, prior to the presentation.
6. A timekeeper will be present to signal the cadet when they are nearing the one-minute mark.



Hand out the list of topics located at Annex AE and have the cadets choose what topic they will speak about.

Hand out the Verbal Presentation Feedback Form located at Annex AF to each cadet and discuss how it will be used.

CONFIRMATION OF TEACHING POINT 2

QUESTIONS

- Q1. What is the aim of the one-minute verbal presentation?
- Q2. When should aids required for the presentation be requested?

ANTICIPATED ANSWERS

- A1. To practice the skills for effectively communicating ideas by speaking clearly and confidently.
- A2. Prior to the presentation.

Teaching Point 3

Conduct an Activity Where the Cadets Will Deliver a One-Minute Verbal Presentation

Time: 25 min

Method: Practical Activity



This activity should be conducted on a separate training night TP 1 and 2 to allow the cadets an opportunity to prepare their verbal presentations.

ACTIVITY

OBJECTIVE

The objective of this activity is to have the cadets deliver a one-minute verbal presentation.

RESOURCES

- Presentation aids (e.g., whiteboard/flip chart/OHP) appropriate for the classroom/training area,
- Other presentation aids as requested by the cadets, and
- Verbal Presentation Feedback Form.

ACTIVITY LAYOUT

N/A.

ACTIVITY INSTRUCTIONS



During the activity:

- Use the Verbal Presentation Feedback Form located at Annex AF to record feedback on what the cadet has done well and areas for improvement.
- Ensure that the requested presentation aids are available prior to the start of the activity.
- Ensure that a timekeeper is present to signal the cadets when they near the one-minute mark. If the cadets go over time, note this in their feedback. Abruptly cutting them off may be more damaging than the negative feedback.

1. Brief the cadets on the following instructions for this activity:
 - (a) Each cadet is required to deliver a one-minute verbal presentation on a chosen topic.
 - (b) Each cadet is permitted to use one piece of paper not larger than 8 1/2 inches by 11 inches for outline notes. Cadets are not permitted to read their presentations directly from the paper.
 - (c) No assistance will be provided.
2. Determine the order in which the cadets will deliver their presentations.
3. Have each cadet deliver a presentation. At the end of the presentation, provide one-on-one feedback to the cadet using the Verbal Presentation Feedback Form. Have the next cadet prepare for their presentation while the one-on-one feedback interview is in progress.



Instructions for the one-on-one feedback interview:

1. Conduct in a private setting.
2. Put the cadet at ease.
3. Ask how they think they did.
4. Ask what they think went well. Discuss two positive points about their presentation.
5. Ask what they think needs improvement. Discuss two areas for improvement.
6. Finish the feedback interview on a positive note.

Positive feedback is essential and should take into account that this may be the first time the cadet has delivered a prepared presentation in front of a group.

4. Continue until all the cadets have had the opportunity to present.
5. Summarize the common feedback for the group and discuss how to improve the presentations.



It is essential that the cadets leave the lesson with a positive attitude.

SAFETY

N/A.

CONFIRMATION OF TEACHING POINT 3

The cadets' participation in a one-minute verbal presentation will serve as confirmation for this TP.

END OF LESSON CONFIRMATION

The cadets' participation in a one-minute verbal presentation will serve as confirmation for this lesson.

CONCLUSION

HOMEWORK/READING/PRACTICE

N/A.

METHOD OF EVALUATION

N/A.

CLOSING STATEMENT

Practicing effective speaking techniques in front of peers will build self-confidence and develop presentation skills needed for instructing cadets.

INSTRUCTOR NOTES/REMARKS

TP 3 should be scheduled on a separate training night after TPs 1 and 2 have been conducted.

This EO should be scheduled after EO M309.03 (Describe Effective-Speaking Techniques, Section 3) and before EO M309.06 (Plan a Lesson, Section 6).

REFERENCES

- C0-195 (ISBN 1-890460-03-6) Jensen, E. (1998). *Trainer's Bonanza: Over 1000 Fabulous Tips & Tools*. San Diego, CA: The Brain Store.
- C0-192 (ISBN 0-9695066-2-7) Bender, P. (2000). *Secrets of Power Presentations*. Toronto, ON: The Achievement Group.



COMMON TRAINING
PHASE THREE
INSTRUCTIONAL GUIDE



SECTION 9

EO C309.04 – IDENTIFY FORMATIONS FOR DRILL INSTRUCTION

Total Time:

30 min

PREPARATION

PRE-LESSON INSTRUCTIONS

Resources needed for the delivery of this lesson are listed in the lesson specification located in A-CR-CCP-603/PG-001, Chapter 4. Specific uses for said resources are identified throughout the instructional guide within the TP for which they are required.

Review the lesson content and become familiar with the material prior to delivering the lesson.

PRE-LESSON ASSIGNMENT

N/A.

APPROACH

An interactive lecture was chosen for TP 1 to introduce the formations used for drill instruction.

A demonstration was chosen for TP 2 as it allows the instructor to demonstrate the procedures for forming a hollow square and reforming the squad.

INTRODUCTION

REVIEW

N/A.

OBJECTIVES

By the end of this lesson the cadet shall have identified the formations for drill instruction.

IMPORTANCE

It is important for cadets to identify formations for drill instruction to be able to select the most effective formation for the lesson being taught. The choice of formation is important because it allows all of the cadets to see the instructor.

Teaching Point 1**Describe the Formations for Drill Instruction**

Time: 5 min

Method: Interactive Lecture

FORMATIONS FOR DRILL INSTRUCTION

The choice of formation is important because it allows all of the cadets to see the instructor. The three formations that are recommended are a single file, a semicircle and a hollow square.

Single File. Used for groups of five cadets or less which can form up into one rank.

Semicircle. Used for groups of six to nine cadets which can be formed up in two ranks. There is no formal drill command for forming a semicircle.

Hollow Square. Used for groups of 10 or more cadets which are formed up in three ranks.

CONFIRMATION OF TEACHING POINT 1

QUESTIONS

- Q1. When is a single file formation used?
- Q2. What formation should be used for a squad in two ranks?
- Q3. How many ranks must the squad be in to form a hollow square?

ANTICIPATED ANSWERS

- A1. Groups of five cadets or less.
- A2. Semicircle.
- A3. Three ranks.
-

Teaching Point 2**Demonstrate the Procedure for Forming a Hollow Square and Reforming a Squad**

Time: 20 min

Method: Demonstration



Proper drill movements shall be combined with a professional demeanour throughout the period of instruction.

Check for faults and correct them immediately when they occur.



Capitalization indicates the words of command for each movement.

FORM HOLLOW SQUARE



The squad shall be in line in three ranks prior to forming the hollow square.

The following procedure is used to form a hollow square (as illustrated in Figure 9-9-1):

1. On the command FORM HOLLOW SQUARE, CENTRE RANK RIGHT, REAR RANK LEFT-TURN, the squad acts as ordered.
2. On the command CENTRE RANK LEFT WHEEL, REAR RANK RIGHT WHEEL, QUICK-MARCH, the squad acts as ordered.
3. The command MARK-TIME shall be given when the rear individuals of the centre and rear ranks are one pace in front of the front rank.
4. On the command SQUAD-HALT, the squad acts as ordered.
5. On the command CENTRE RANK LEFT, REAR RANK RIGHT-TURN, the squad acts as ordered.



Where new cadets may not yet know the movements listed for the forming of a hollow square, instructors should give instructions such as: "*Centre rank turn to your right, rear rank turn to your left*" and then guide the cadets into the correct formation. The use of drill commands where the cadets are unaware of the actions they should take will only serve to create a negative atmosphere for the class.

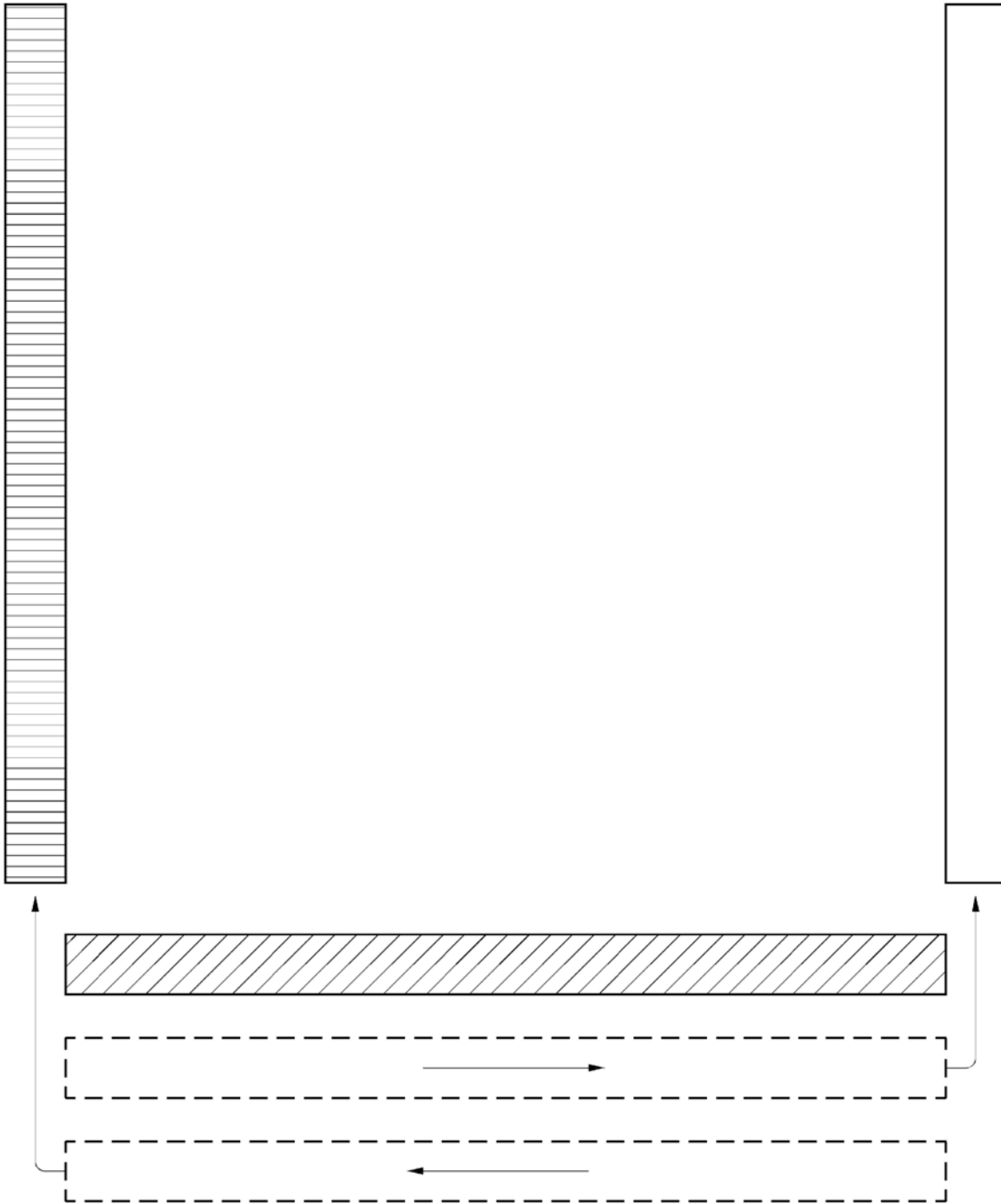

A-PD-201-000/PT-000 (p. 3-23)

Figure 9-9-1 Forming a Hollow Square

REFORM THREE RANKS



The reverse procedure to forming a hollow square is used to reform a squad into three ranks.

The following procedure is used to reform three ranks:

1. On the command REFORM THREE RANKS, CENTRE RANK LEFT, REAR RANK RIGHT-TURN, the squad acts as ordered.
2. On the command CENTRE RANK RIGHT WHEEL, REAR RANK LEFT WHEEL, QUICK-MARCH, the squad acts as ordered.
3. The command MARK-TIME shall be given when the squad has reformed three ranks.
4. On the command SQUAD-HALT, the squad acts as ordered.
5. On the command CENTRE RANK RIGHT, REAR RANK LEFT-TURN, the squad acts as ordered.



If time permits, have the cadets practice forming a hollow square with their peers. Simulate three ranks for groups less than 10 cadets.

CONFIRMATION OF TEACHING POINT 2

QUESTIONS

- Q1. How must a squad be formed before forming a hollow square?
- Q2. When should the instructor give the command to mark time when forming a hollow square?
- Q3. What procedure is used to reform three ranks?

ANTICIPATED ANSWERS

- A1. In three ranks.
- A2. The rear individuals of the centre and rear ranks are one pace in front of the front rank.
- A3. The reverse procedure to forming a hollow square.

END OF LESSON CONFIRMATION

QUESTIONS

- Q1. What three formations are used for drill instruction?
- Q2. What formation should be used for a group of seven cadets?
- Q3. How many cadets are needed to form a hollow square?

ANTICIPATED ANSWERS

- A1. Single file, semicircle and hollow square.

A2. Semicircle.

A3. 10 or more.

CONCLUSION

HOMEWORK/READING/PRACTICE

N/A.

METHOD OF EVALUATION

N/A.

CLOSING STATEMENT

Drill instruction requires the instructor to demonstrate each individual squad of a movement so the cadets can see what is expected. The choice of formation is important because it allows all of the cadets to see the instructor.

INSTRUCTOR NOTES/REMARKS

N/A.

REFERENCES

A0-002 A-PD-201-000/PT-000 Director History and Heritage 3-2. (2005). *The Canadian Forces Manual of Drill and Ceremonial*. Ottawa, ON: Department of National Defence.



COMMON TRAINING
PHASE THREE
INSTRUCTIONAL GUIDE



SECTION 10
EO C309.05 – PLAN A DRILL LESSON

Total Time:

60 min

PREPARATION

PRE-LESSON INSTRUCTIONS

Resources needed for the delivery of this lesson are listed in the lesson specification located in A-CR-CCP-603/PG-001, Chapter 4. Specific uses for said resources are identified throughout the instructional guide within the TP for which they are required.

Review the lesson content and become familiar with the material prior to delivering the lesson.

Photocopy Annexes AG to AJ for each cadet.

Photocopy the lesson specifications and instructional guides located at Annexes AK to AQ as required.

PRE-LESSON ASSIGNMENT

N/A.

APPROACH

An interactive lecture was chosen for TPs 1 and 2 to present the drill instruction sequence and to stimulate an interest in planning a drill lesson.

A practical activity was chosen for TP 3 to guide the cadets through the process of planning a drill lesson.

INTRODUCTION

REVIEW

N/A.

OBJECTIVES

By the end of this lesson the cadet shall have identified the drill instruction sequence and written a drill lesson plan.

IMPORTANCE

It is important for cadets to know the essential elements of a drill lesson and be able to develop a written drill lesson plan as it allows them to be better prepared to deliver drill instruction. Drill that is well taught and executed develops individual pride, mental alertness, precision and esprit de corps.

Teaching Point 1**Describe the Drill Instruction Sequence**

Time: 10 min

Method: Interactive Lecture

INTRODUCTION

The lesson shall be introduced as follows:

1. Order the squad into a suitable formation such as a single rank, hollow square or semicircle.
2. Review the previous lesson.
3. Describe the new movement.
4. Describe why it is important to learn the movement.
5. Describe where and when the movement will be used.
6. Describe how the cadets will be assessed.

BODY

The lesson shall be taught using the following process:

1. Demonstrate the complete movement, calling out the time.
2. Explain the complete movement.
3. Demonstrate the first part of the movement.
4. Explain the first part of the movement.
5. Give the squad the opportunity to ask questions.
6. Practice the first movement (collectively, individually, collectively) (as illustrated in Figure 9-10-1).
7. Demonstrate and explain the second part of the movement and any subsequent parts of the movement following Steps 3. to 6.
8. Give two complete demonstrations.
9. Practice the complete movement with:
 - (a) the instructor calling the time;
 - (b) the squad calling the time; and
 - (c) the squad judging the time.

DEMONSTRATE THE COMPLETE MOVEMENT WITH TIMING

The instructor shall provide a complete demonstration of the drill movement, with timing. A practiced assistant instructor may carry out this demonstration.

The demonstration shall be provided from various vantage points, as required.

DEMONSTRATE FIRST PART OF MOVEMENT (FIRST NUMBER)

For ease of instruction, drill commands have been broken down into individual movements, or numbers. The instructor(s) shall demonstrate and explain each number.

In order to adopt the position of attention from stand at ease, the cadet shall:

On the command ATTENTION BY NUMBERS, SQUAD – ONE, bend the left knee and shift the balance to the right foot.

PRACTICE THE SQUAD ON THE FIRST MOVEMENT

Practice the squad on the first movement collectively, individually and collectively.

Director Cadets 3, 2008, Ottawa, ON: Department of National Defence

Figure 9-10-1 Drill Instruction Sequence

END OF LESSON CONFIRMATION

The end of lesson confirmation must meet the following criteria:

1. It shall be a performance of the movement taught.
2. It shall be conducted as a squad.
3. It will emphasize any aspects of the movement that the cadets experienced difficulty with during the lesson.

CONCLUSION

The lesson shall be summarized as follows:

1. Restate the movement taught and where or when it will be used;
2. Re-motivate the cadets by:
 - (a) commenting on the cadets' progress; and
 - (b) re-stating why the drill movement just learned is important.
3. Describe the next lesson.

CONFIRMATION OF TEACHING POINT 1

QUESTIONS

- Q1. Describe one action an instructor shall take during the introduction of a drill lesson.
- Q2. List the sequence for practicing drill movements.

Q3. What shall an instructor do in the conclusion of a drill lesson?

ANTICIPATED ANSWERS

A1. During the beginning of a drill lesson, an instructor shall:

- (1) Order the squad into a suitable formation.
- (2) Review the previous lesson.
- (3) Describe the new movement.
- (4) Describe why it is important to learn it.
- (5) Describe where and when the movement will be used.
- (6) Describe how the cadets will be assessed.

A2. The sequence for practicing drill movements is to practice the squad collectively, individually, collectively.

A3. In the conclusion the instructor shall:

- (1) Restate the movement taught and where or when it will be used.
- (2) Re-motivate the cadets by commenting on the cadets' progress and by re-stating the reason for learning the movement.
- (3) Describe the next lesson.

Teaching Point 2

Review the Lesson-Planning Process

Time: 10 min

Method: Interactive Lecture

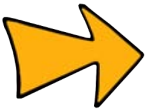

Before beginning the activity for planning a drill lesson, review the lesson-planning process taught in M309.06 (Plan a Lesson, Section 6) summarized below.



Distribute the lesson plan handout located at Annex AG to each cadet.

THE LESSON-PLANNING PROCESS

The Canadian Forces employs an initialism that is used to provide a framework for the instructor to gather and organize the reference material into an efficient and practical lesson plan. The initialism is CCSAM.

Collect. During this step, the instructor researches the material to be covered in the period of instruction using course documents such as the lesson specification, IG and listed references. In situations where no course documents exist, the instructor will research the material to be taught using whatever references exist.

Consider. During this step, the instructor sifts through all of the material found in the collection step and determines what is relevant and current.

Select. During this step, the instructor selects the material that is appropriate for the lesson. The instructor also selects the method of instruction to be used.

Arrange. During this step, the instructor arranges the material into stages that allow for the information to be presented in a logical sequence.

Master. During this step, the instructor writes the lesson plan.

LESSON SPECIFICATION

Lesson specifications are found in the Qualification Standard and Plan (QSP), Chapter 4. The two sections of a lesson specification are the enabling objective (EO) and the lesson specification.

Enabling Objective

The EO is the first three paragraphs of the lesson specification and will answer three questions:

- What will the cadet be expected to be able to do by the end of this lesson?
- Under what conditions will the cadet be expected to carry out the performance?
- How well or to what standard will the cadet be expected to perform?

Lesson Specification

The lesson specification, (paragraphs 4. to 11.), contains information about:

- the content to be taught broken down into teaching points;
- the teaching method(s) to be used and why they were chosen;
- the time for each teaching point (TP);
- the references used;
- the training aids to be used;
- the learning aids to be used;
- the test details; and
- remarks for the instructor.

INSTRUCTIONAL GUIDE (IG)

The IG is used in conjunction with the QSP and other resources to conduct training. IGs should be reviewed in conjunction with lesson specifications so that the instructor can adequately plan and prepare their lesson. The following are the six sections of an IG:

Preparation. This section provides information to the instructor regarding:

- pre-lesson instructions;
- pre-lesson assignment; and
- instructional approach or method.

Introduction. This section provides information to the instructor regarding:

- any review that may be necessary;
- what the cadet will be expected to do by the end of the lesson; and
- why the knowledge/skill is important.

Body. This section provides information to the instructor regarding:

- the TPs and their content as listed in paragraph 4. of the lesson specification in greater detail;
- suggested teaching methods;
- note boxes with special instructions or information;
- lesson content;
- figures;
- activities; and
- confirmation questions or activities.

Conclusion. This section provides information to the instructor regarding:

- any homework/reading/practice that may be required of the cadet;
- the method of evaluation to be used as stated in the lesson specification;
- a closing statement to be spoken aloud to the cadet; and
- any additional instructor notes/remarks.

References. This section lists the sources of information used to create the lesson specification and instructional guide.

Annexes. This section contains background information for the TPs, pre-made instructional aids and additional information for activities.

CONFIRMATION OF TEACHING POINT 2

QUESTIONS

- Q1. List the five parts of the lesson-planning process.
- Q2. What is included in the EO portion of a lesson specification?
- Q3. What are the six sections of an instructional guide?

ANTICIPATED ANSWERS

- A1. The five parts of the lesson planning process are collect, consider, select, arrange and master.
- A2. The information included in the EO is what the cadet will be expected to learn, what materials, supervision and equipment will be available to the cadet and what standard the cadet will be expected to achieve.
- A3. The six sections of an IG are preparation, introduction, body, conclusion, references and annexes.

Teaching Point 3

Supervise and Provide Assistance While the Cadets Plan a Drill Lesson

Time: 30 min

Method: Practical Activity

In EO C309.06 (Instruct a 15-Minute Drill Lesson, Section 11), the cadets shall be expected to instruct a drill lesson using a lesson plan, the drill instruction sequence and the appropriate drill formation. The lesson plan created in this EO will be used to instruct that drill lesson.



Distribute the blank lesson plan located at Annex AH and the plan a drill lesson checklist located at Annex AI to each cadet.

ACTIVITY

OBJECTIVE

The objective of this activity is to have the cadets plan a 15-minute drill lesson.

RESOURCES

- List of approved 15-minute drill topics located at Annex AJ, and
- Modified lesson specifications and instructional guides located at Annexes AK to AQ.

ACTIVITY LAYOUT

N/A.

ACTIVITY INSTRUCTIONS

1. Have each cadet choose a topic from the list of approved 15-minute drill topics.
2. Have the cadets use the lesson specification and IG for their chosen topic to help develop their drill lesson plan. Cadets shall be expected to teach their chosen lesson as part of C309.06 (Instruct a 15-Minute Drill Lesson, Section 11).
3. Circulate around the room facilitating the activity and helping the cadets as required.



Ensure that cadets request all resources required to instruct their lesson.

SAFETY

N/A.

CONFIRMATION OF TEACHING POINT 3

The cadets' participation in the activity will serve as the confirmation of this TP.

END OF LESSON CONFIRMATION

The cadets' planning a drill lesson will serve as the confirmation of this lesson.

CONCLUSION

HOMEWORK/READING/PRACTICE

The cadets shall be prepared to instruct their lesson at the beginning of C309.06 (Instruct a 15-Minute Lesson, Section 11).

METHOD OF EVALUATION

N/A.

CLOSING STATEMENT

Instructors must continually work to improve the quality of instruction. Being able to plan drill lessons is a critical step in boosting the instructor's confidence and improving the quality of drill instruction.

INSTRUCTOR NOTES/REMARKS

EO C309.05 (Plan a Drill Lesson) should be scheduled at least one week prior to EO C309.06 (Instruct a 15-Minute Drill Lesson, Section 11).

REFERENCES

A0-002 A-PD-201-000/PT-000 Director History and Heritage 3-2. (2005). *The Canadian Forces Manual of Drill and Ceremonial*. Ottawa, ON: Department of National Defence.



COMMON TRAINING
PHASE THREE
INSTRUCTIONAL GUIDE



SECTION 11

EO C309.06 – INSTRUCT A 15-MINUTE DRILL LESSON

Total Time:

90 min

PREPARATION

PRE-LESSON INSTRUCTIONS

Resources needed for the delivery of this lesson are listed in the lesson specification located in A-CR-CCP-603/PG-001, Chapter 4. Specific uses for said resources are identified throughout the instructional guide within the TP for which they are required.

Review the lesson content and become familiar with the material prior to delivering the lesson.

Photocopy the Drill Instructional Techniques Assessment Form located at Annex AR for each cadet.

Ensure that all resources requested by the cadets are available.

PRE-LESSON ASSIGNMENT

N/A.

APPROACH

A practical activity was chosen for this lesson as it is an interactive way for cadets to develop drill instructional skills in a safe and controlled environment.

INTRODUCTION

REVIEW

N/A.

OBJECTIVES

By the end of this lesson the cadet shall have instructed a 15-minute drill lesson using a written lesson plan and the drill instruction sequence.

IMPORTANCE

It is important for cadets to instruct a 15-minute drill lesson as it gives them the opportunity to practice drill instructional skills in a peer setting and to receive feedback to further develop instructional skills and confidence.

Teaching Point 1**Supervise While the Cadets Instruct a 15-Minute Drill Lesson**

Time: 85 min

Method: Practical Activity

ACTIVITYTime: 85 min

OBJECTIVE

The objective of this activity is to have cadets instruct a 15-minute drill lesson in a peer setting using a written lesson plan and the drill instruction sequence.

RESOURCES

Drill Instructional Techniques Assessment Form.

ACTIVITY LAYOUT

N/A.

ACTIVITY INSTRUCTIONS

1. Have the cadets provide a copy of their lesson plan to the assessor.
2. Determine the order in which cadets will instruct their lessons.
3. Have one cadet form up the squad for their drill lesson.
4. Have one cadet instruct a 15-minute drill lesson using a written lesson plan and the drill instruction sequence (as prepared in EO C309.05 [Plan a Drill Lesson, Section 10]).
5. Assess the cadet's lesson using the Drill Instructional Techniques Assessment Form.
6. Upon completion of the lesson, provide feedback to the cadet.
7. Repeat Steps 3. to 6. until all cadets have instructed a lesson.



The Drill Instructional Techniques Assessment Form located at Annex AR is used to provide feedback on the cadet's lesson and to introduce the cadet to the type of instructional techniques assessment they will receive in their future phase training. The form is intended solely for the purposes of assessment for learning, providing the cadets with the feedback they need to improve upon their own skills.

8. Debrief the cadets by providing feedback, focusing on:
 - (a) best practices,
 - (b) general trends and key areas for improvement, and
 - (c) re-motivation, highlighting the effort and accomplishments of the group.



If the group of cadets is large, divide them up into smaller groups and assign other instructors to aid with assessment and feedback.

SAFETY

N/A.

CONFIRMATION OF TEACHING POINT 1

The cadets' participation in the activity will serve as the confirmation of this TP.

END OF LESSON CONFIRMATION

The cadet's instructing a 15-minute drill lesson will serve as the confirmation of this lesson.

CONCLUSION

HOMEWORK/READING/PRACTICE

N/A.

METHOD OF EVALUATION

N/A.

CLOSING STATEMENT

Practicing drill instructional skills in a peer setting allows for the development of fundamental skills necessary to become a drill instructor while further developing confidence and providing a sense of accomplishment.

INSTRUCTOR NOTES/REMARKS

This EO shall be conducted after EO C309.04 (Identify Formations for Drill Instruction, Section 9) and EO C309.05 (Plan a Drill Lesson, Section 10).

Additional time may be required for class sizes greater than five cadets.

REFERENCES

A0-002 A-PD-201-000/PT-000 Director Heritage and History 3-2 (2005). *The Canadian Forces Manual of Drill and Ceremonial*. Ottawa, ON: Department of National Defence.

THIS PAGE INTENTIONALLY LEFT BLANK

PRINCIPLES OF INSTRUCTION INFORMATION SHEETS

INTEREST

Cadets are more receptive to learning when they are curious and have an emotional connection to a topic. The instructor must arouse, create and maintain the interest of the cadets. Without interest, the cadets will be less inclined to listen and will not learn.

- **Principle.** People learn when they are interested in the material or skill.
- **Action.** Instructors must arouse, create and maintain the cadets' interest. The instructor should employ imaginative means to keep curiosity, while taking into account experience and interests.

Ensure Interest	Technique
Information	Inform the cadets why they are learning the skill or knowledge. Explain all of the benefits of this new knowledge or skill.
Enthusiasm	Show enthusiasm. Smile and have fun. Make eye contact. Vary the pitch, resonance, articulation, speed, volume, inflection and rhythm of your speech.
Variety	Use more than one instructor. Use verbal support to back up a statement or to clarify an idea. Use a variety of different training aids. Try different teaching methods.
Realism	Try a different location for your class. If you are teaching wind direction for sailing, go outside and feel the wind.
Participation	Involve the cadets by asking questions. Ensure cadets participate early in a skill lesson. Use speed and/or ability competitions or games to reinforce learning.

COMPREHENSION

Comprehension or understanding relates to the cadet's ability to understand the material taught. The cadets' readiness to learn new material is influenced by what has previously been taught; new content should not exceed the knowledge level of the cadets. If the cadets do not understand, they are unable to learn.

- **Principle.** People learn when instruction starts at their level of understanding and proceeds at the rate of their comprehension.
- **Action.** Instructors must determine the cadet's level of knowledge and only progress with new material when the cadets have full understanding of the material previously taught.

Ensure Comprehension	Technique
Research	Examine the Qualification Standard and Plan (QSP) to determine what material the cadets have already been taught.
Plan	Organize lesson material in a logical order. Proceed from the known to the unknown. Move from simple material to the more difficult.
Question	Ask review questions at the start of the lesson to determine the level of understanding. Continue to ask questions throughout the lesson to ensure understanding. Assure cadets early in the lesson that questions are welcome.
Observe	Watch for expressions of body language that may indicate difficulty with parts of the lesson. Observe cadets when they practice a skill and correct error as they occur.

EMPHASIS

During a period of instruction there will be some information, which may be of particular importance. The instructor can emphasize this important information through the use of voice control, training aids and in-class activities.

- **Principle.** People retain more important information when the instructor uses repetition and emphasis.
- **Action.** Instructors must stress essential points.

Ensure Emphasis	Technique
Process	Teach the material step by step. Re-cap each area (stress key points). Have the cadets take notes.
In-Class Review	Review the key points from the past lesson. Repeat the key points during the lesson.
Reinforcement	For a knowledge lesson, ask questions on the key points. For a skill lesson, allow sufficient practice time for the cadets to ask questions and receive corrective action. Do not over demonstrate. Try saying "This is important, remember it." Use verbal support by giving examples, to include: <ul style="list-style-type: none"> • comparisons, • reasons, • restatement and repetition, • examples, • statistics, and • testimonials. Use training aids.
Post Lesson	Distribute handouts covering key points.

PARTICIPATION

Cadets are more likely to retain information if they are both mentally and physically involved in learning. The instructor should conduct activities that contain action, activity and excitement. Cadets learn by doing.

- **Principle.** People learn best when they have an opportunity to participate actively in the learning process. People learn by doing.
- **Action.** The instructor creates class participation in the form of a physical or mental activity.

Ensure Participation in a Knowledge Lesson	Technique
Involvement	Ask open-ended questions that will encourage individual thought and generate a discussion.
Group Work	Select teaching methods that allow the cadets to share ideas and knowledge.
Learning Activity	Organize teaching points to contain such things as: <ul style="list-style-type: none"> • puzzles, • crosswords, • trivia games, • board games, • word searches, • discussions, • case studies, • competitions, • experiments, or • problem solving.
Application	Allow the cadets to apply the knowledge through case studies and problem-based learning.

Ensure Participation in a Skill Lesson	Technique
Involvement	Ensure early involvement by cadets. Have as many cadets as possible working on the skills at the same time.
Practice	Ensure ample practice time. Maintain close supervision during practice

Ensure Participation in a Skill Lesson	Technique
Detection and Correction	Be aware of commonly made errors while practicing a new skill. Observe cadets closely when they practice a skill. Correct errors as they occur. Correct one error at a time.
Competition	Allow the cadets to practice new skills by conducting friendly competitions and contests.

ACCOMPLISHMENT

The lesson must impart a sense of accomplishment to each cadet. The cadets should leave the class with the satisfaction that they were able to achieve something in the lesson.

- **Principle.** People learn most effectively when their performance results in a sense of accomplishment.
- **Action.** The instructor must tell the cadets what they are doing well and what needs improvement. The objective is to offer feedback that will reinforce desired performance and correct undesired performance.

Ensure Accomplishment	Technique
Expectations	Inform cadets of the lesson objectives. Ensure the cadets understand what will be expected of them at the end of the lesson.
Learner Satisfaction	Explain lessons clearly using simple words. The cadets will learn easily creating fulfillment.
Learner Responsibility	Keep cadets informed of their progress. Just by saying “Now that you have all correctly tied the reef knot, let’s practice the bowline” will indicate the cadets’ progress.
Encouragement	Reassure cadets that they will be successful. Compliment cadets on work that is well done.
Perseverance	Encourage cadets who may be having difficulty. Allow cadets to practice skills they have difficulty with. Offer extra help if necessary.

CONFIRMATION

Confirmation is an essential part of learning and instructing. It gives both the instructor and the cadet the opportunity to see how well the information is understood.

- **Principle.** Confirm that learning has occurred and knowledge has been retained.
- **Action.** Instructors must confirm that the cadets' learning meets established standards and ensure that the skills can be performed safely and competently.

Ensure Confirmation	Technique
Practice	Observe as the cadets practice the skills.
Exercise	Have the cadets perform the skill. If you are teaching cadets how to pipe the still, listen to each cadet perform the pipe. Anyone who cannot do it may need extra instruction. Provide exercises or guide discussions that stress the key points of the lesson.
Questions	Ask questions at the end of the lesson to assess how well the cadets are learning. Listen carefully to the cadets' answers. You may be able to identify weak areas that may need to be re-taught.
Assignments	Review assignments completed outside class to determine the extent of learning.
Tests	Conduct confirmation for teaching points and enabling checks. This will also reinforce learning.
Observations	Note and provide feedback on cadet behaviour.

THIS PAGE INTENTIONALLY LEFT BLANK

PRINCIPLES OF INSTRUCTION WORKSHEETS

PRINCIPLES OF INSTRUCTION Worksheet

NAME OF PRINCIPLE: Interest.

TOPIC: How to eat an apple.

TECHNIQUES FOR APPLYING THE PRINCIPLE TO THIS TOPIC:

PRINCIPLES OF INSTRUCTION

Worksheet

NAME OF PRINCIPLE: Comprehension.

TOPIC: How to tie a shoe.

TECHNIQUES FOR APPLYING THE PRINCIPLE TO THIS TOPIC:

PRINCIPLES OF INSTRUCTION

Worksheet

NAME OF PRINCIPLE: Emphasis.

TOPIC: How to cross the street.

TECHNIQUES FOR APPLYING THE PRINCIPLE TO THIS TOPIC:

PRINCIPLES OF INSTRUCTION

Worksheet

NAME OF PRINCIPLE: Participation.

TOPIC: How to walk down the stairs.

TECHNIQUES FOR APPLYING THE PRINCIPLE TO THIS TOPIC:

METHODS OF INSTRUCTION

INTERACTIVE LECTURE

Description	Pre-Lesson Preparation	Typical Applications	Lesson Development
<p>Interactive lecture is an instructor-driven method, which combines both lecture and interaction to meet lesson objectives. The lecture portions of the lesson are offset with relevant activities such as videos with discussion, games, learning stations, brainstorming, debating, group work or the completion of handouts.</p>	<p>Use attention-getters such as interesting facts, statistics or rhetorical questions to begin the lecture or to introduce new teaching points.</p> <p>Prepare participatory questions to encourage cadet participation.</p> <p>Prepare evaluative questions for confirmation of teaching points.</p> <p>Obtain or develop training aids to clarify main points.</p> <p>Prepare an in-class activity to avoid lecturing too long.</p> <p>Practice delivering the material.</p>	<p>Interactive lectures can be used with different sizes of groups to:</p> <ul style="list-style-type: none"> • introduce a subject; • present background information; • review previously taught material; • give instructions on procedures; • illustrate the application of rules, principles or concepts; or • introduce a demonstration, discussion or performance. 	<p>Begin the lesson and each new TP with an attention-getter.</p> <p>Use presentation aids such as:</p> <ul style="list-style-type: none"> • flip chart, • whiteboard, and/or • electronic media. <p>Pay attention to signals of alertness, such as:</p> <ul style="list-style-type: none"> • cadets' facial expressions, and • cadets' body language. <p>Deal with alertness problems by:</p> <ul style="list-style-type: none"> • asking for questions; and • posing questions to the group. <p>Use visual training aids at opportune moments.</p> <p>Integrate interesting facts with lesson material to maintain interest.</p> <p>Use participatory questions or a short activity to avoid lecturing too long.</p> <p>Use questions to confirm each teaching point.</p> <p>Confirm the lesson using questions or an activity.</p>

DEMONSTRATION AND PERFORMANCE

Description	Pre-Lesson Preparation	Typical Applications	Lesson Development
<p>Demonstration and Performance During demonstration and performance the cadets observe the instructor performing the task in a demonstration, and rehearse it under the supervision of the instructor.</p> <p>Demonstration Method A method of instruction where the instructor, by actually performing an operation or doing a job, shows the cadet what to do, how to do it and explains why, where and when it is done.</p> <p>Performance Method A method in which the cadet is required to perform, under controlled conditions, the operations, skill or movement being taught.</p>	<p>The instructor must be skilled in the task.</p> <p>Gather all materials necessary to instruct the lesson.</p> <p>Break the task down into smaller sequential steps.</p> <p>Practice the lesson to ensure that steps are accurate and clear.</p> <p>Prepare a handout outlining the steps, if necessary.</p> <p>Organize the training area so that all cadets can:</p> <ul style="list-style-type: none"> • see the demonstration, and • perform the task. 	<p>Demonstration Method Demonstration can be used to:</p> <ul style="list-style-type: none"> • teach hands-on operations or procedures; • teach troubleshooting; • illustrate principles; • teach operation or functioning of equipment; • set standards of workmanship; • explain a theory or concept; or • teach safety procedures. <p>Performance Method Performance can be used to:</p> <ul style="list-style-type: none"> • teach hands-on operations or procedures; • teach operation or functioning of equipment; • teach team skills; or • teach safety procedures. 	<p>Introduce the lesson by demonstrating what the cadets will be able to do at the end.</p> <p>Explain where the skill can be applied and why it is important.</p> <p>Provide a handout outlining the steps if the process is complex.</p> <p>Explain and demonstrate each step in a sequential manner.</p> <p>Allow cadets maximum time to practice the steps as soon as possible.</p> <p>Positively reinforce everything the cadets do correctly.</p> <p>Supervise the cadets as they practice, providing assistance or re-demonstrations when necessary.</p> <p>Have cadets perform the skill as confirmation.</p> <p>Encourage the cadets to practice beyond class time.</p>

IN-CLASS ACTIVITY

Description	Pre-Lesson Preparation	Typical Applications	Lesson Development
<p>In-class activities encompass a wide variety of activity-based learning opportunities that can be used to reinforce and practice instructional topics or to introduce cadets to new experiences. In-class activities should stimulate interest among cadets and encourage their participation, while maintaining relevance to the performance objectives. Examples of in-class activities include learning stations, videos, brainstorming, debating, and group work.</p>	<p>Create an activity that involves all cadets, which can be conducted within the time allocated.</p> <p>Clearly specify the objective of the activity.</p> <p>Obtain all materials necessary to complete the activity.</p> <p>Write out specific instructions describing what participants are supposed to do.</p> <p>Write out specific directions for conducting the activity.</p> <p>Arrange for assisting staff, if necessary, to help conduct the activity.</p> <p>Prepare handouts for cadets containing background information.</p> <p>Organize the training area into work/learning stations.</p>	<p>An in-class activity can be used for both knowledge and skill lessons to:</p> <ul style="list-style-type: none"> • reinforce instructional objectives; • introduce a subject and generate interest; • present background information; • give direction on procedures; • introduce a demonstration, discussion or performance; • illustrate the application of rules, principles or concepts; • to create interactivity during a lecture; or • to review, clarify or summarize information. 	<p>Introduce the activity to the whole group.</p> <p>Brief participants on what will be expected of them.</p> <p>Stress timings.</p> <p>Ensure all resources are available.</p> <p>Begin the activity.</p> <p>Supervise and assist the groups as required.</p> <p>Conclude the activity.</p> <p>Confirm the TP or lesson.</p> <p>Debrief the cadets.</p>

PRACTICAL ACTIVITY

Description	Pre-Lesson Preparation	Typical Applications	Lesson Development
<p>Practical activities encompass a wide variety of activity-based learning opportunities that can be used to reinforce and practice instructional topics or to introduce cadets to new experiences. Practical activities should stimulate interest among cadets and encourage their participation, while maintaining relevance to the performance objective.</p>	<p>The instructor must be skilled in the task.</p> <p>Gather all materials necessary to instruct the lesson.</p> <p>Organize the training area so that all cadets will have space to perform the task safely.</p> <p>Ensure there is enough time to conduct the complete activity or breakdown the task into smaller stages.</p> <p>Prepare a handout outlining the steps, if necessary.</p> <p>Arrange for assisting staff, if necessary.</p> <p>Divide cadets into small groups.</p>	<p>The objective of the practical activity method is to reinforce and practice instructional topics or to introduce the cadets to new experiences.</p> <p>If it is used to teach new material it must be combined with other methods to ensure cadets have the necessary background information to complete the activity.</p> <p>The practical activity method can be used to:</p> <ul style="list-style-type: none"> • carry out an application; • demonstrate a process; • verify an explanation; • produce a product; • introduce a subject; • teach manipulative operations; • teach procedures; • teach troubleshooting; • illustrate principles; • teach equipment operation; or • teach safety. 	<p>Review background information.</p> <p>Distribute the handout, if necessary.</p> <p>Introduce the activity to the group.</p> <p>Stress safety.</p> <p>Brief the cadets on what they will be expected to do.</p> <p>Brief assisting staff on what they will be expected to do.</p> <p>Begin the activity.</p> <p>Supervise the cadets and provide assistance, if necessary.</p> <p>Watch for safety infractions and stop the activity, if necessary.</p> <p>Conclude the activity.</p> <p>Debrief the cadets.</p>

GAME

Description	Pre-Lesson Preparation	Typical Applications	Lesson Development
<p>Games are used with one or more participants to practice skills, apply strategies and enhance teams. It is critical that the game supports learning through a challenging activity that allows for skill practice or knowledge confirmation.</p>	<p>Develop a simple game with the following characteristics:</p> <ul style="list-style-type: none"> • fast to play, • easy and quick to organize, • has few rules, • uses minimal equipment, and • involves maximum participation. <p>If possible use variations of games cadets know from childhood or television.</p> <p>Determine the following when developing the rules of the game:</p> <ul style="list-style-type: none"> • individual or team play, • how to change leaders, • what the leader will do, • what the followers will do, • timings for the game, • how to signal the start and stop of the game, • how to ensure safety. <p>Obtain the resources needed to play the game.</p> <p>Organize the training area to play the game.</p>	<p>Games create variety and arouse interest but must also support learning.</p> <p>Games can be used to:</p> <ul style="list-style-type: none"> • introduce a topic; • discover concepts and principles; • learn terminology; • recall terms; • recognize equipment parts; • develop strategies and tactics; • carry out an application; • demonstrate a process; • practice interpersonal skills; and/or • confirm learning 	<p>Brief the cadets on the following:</p> <ul style="list-style-type: none"> • the objective of the game, and • rules of the game. <p>Play the game.</p> <p>Supervise closely to:</p> <ul style="list-style-type: none"> • ensure that the game is played in the manner expected; • ensure that the game is played safely; and • ensure maximum participation. <p>End the game.</p> <p>Debrief the cadets.</p>

FIELD TRIP

Description	Pre-Lesson Preparation	Typical Applications	Lesson Development
<p>Theoretical knowledge is reinforced through participation in an activity in a real-life setting. Prior planning helps to ensure all pre-training and safety standards are met. Field trip activities are planned and carried out to achieve clear instructional objectives that are understood by the cadets. Examples include trips to areas of local interest, flying/gliding, hiking and/or sailing.</p>	<p>Specify the objective(s) of the field trip.</p> <p>Determine the time and location of the field trip.</p> <p>Obtain necessary authorizations.</p> <p>Determine the timings.</p> <p>Determine the activities or demonstrations needed to achieve the objectives.</p> <p>Determine if trained personnel will be available to assist.</p> <p>Arrange the following, if necessary:</p> <ul style="list-style-type: none"> • transportation, • supervision, and • meals. <p>Determine if the cadets will be allowed to use equipment or participate in a training activity.</p> <p>Determine if all cadets can take part at once or if they need to be rotated through.</p> <p>Divide the cadets into groups, if necessary.</p> <p>Ensure safety.</p>	<p>The field trip is used to:</p> <ul style="list-style-type: none"> • introduce/illustrate and confirm topics; • reinforce and clarify classroom learning; • inject variety into the training situation; or • allow cadets to view operations or equipment that cannot easily be shown in the classroom. 	<p>Inform cadets as soon as possible of the following:</p> <ul style="list-style-type: none"> • time of the field trip, • location of the field trip, and • timings for departure. <p>Brief cadets on the following prior to departure:</p> <ul style="list-style-type: none"> • objectives of the field trip, • timings and groupings for activities and demonstrations, and • how they will participate during the field trip. <p>During the field trip ensure the following:</p> <ul style="list-style-type: none"> • the safety of all cadets, • maximum participation, and • the objectives are met. <p>After the field trip:</p> <ul style="list-style-type: none"> • debrief the cadets; and • confirm that objectives have been met. <p>Express appreciation to the facilitators of the field trip.</p>

SELECT A METHOD OF INSTRUCTION

Lesson Topic	Method of Instruction	Explanation
Participate in a Discussion on Hygienic Practices During Physical Activity		
Identify the Parts and the Characteristics of the Daisy 853C Air Rifle		
Apply Basic Marksmanship Techniques		
Participate in a Discussion on Phase One Training		
Wear the Sea Cadet Uniform		
Participate in a Discussion of Year One Summer Training Opportunities		
Tie Knots, Bends and Hitches (Reef Knot and Figure of Eight)		
Tie Knots, Bends and Hitches (Round Turn and Two Half Hitches)		
Coil and Heave a Line		
Explore Canadian Naval History		
Discuss Leadership Within a Peer Setting		
Identify Year Two CSTC Training Opportunities		
Recognize Naval Ship's Traditions		
Reeve Blocks		
Identify the Rank Structure of the Royal Canadian Sea, Army and Air Cadets		

THIS PAGE INTENTIONALLY LEFT BLANK

POSING QUESTIONS SEQUENCE

Question Sequence	Action
Pose the Question	The instructor must ensure that they have the full attention of the class and ask a question that is clearly heard by all.
Pause	The instructor must allow cadets time to think of a response. Do not waste time, but avoid answering the question for the cadets just to break the silence.
Pounce	When using a direct question the instructor must indicate which cadet will answer.
Ponder	The instructor must allow the cadets time to answer fully, listen carefully to the response, confirm the correct response and explain why it is correct. If an answer is incomplete, the instructor must emphasize what is correct and ask a follow-up question to complete the response or simply provide additional information. If an answer is incorrect the instructor must point that out as well, in a manner that does not embarrass the cadet and explain why the answer is incorrect. There may be a need to reword the question to get a better response.
Praise	The instructor must praise all cadets for participating and confirm/summarize all correct responses so as to avoid confusion regarding which responses were correct or incorrect.

THIS PAGE INTENTIONALLY LEFT BLANK

QUESTIONS HANDOUT

Read the short passage to the group and ask them to remember the children's story "Goldilocks and the Three Bears."

Once upon a time there was a little girl named Goldilocks. She went for a walk in the forest. Pretty soon, she came upon a house. She knocked and, when no one answered, she walked right in.

Use the questions below to have each cadet use the question posing sequence at least once.

- Q. Who do you think lived in the house in the forest?
- A. The three bears.
- Q. What did Goldilocks first do when she entered the house?
- A. She tasted the porridge.
- Q. Whose chair did Goldilocks break?
- A. Little bear's chair.
- Q. Why did Goldilocks go upstairs to the bedroom?
- A. She felt tired.
- Q. Did Goldilocks ever return to the house in the forest?
- A. No.

THIS PAGE INTENTIONALLY LEFT BLANK

POSING QUESTIONS RUBRIC

STANDARD

Effective Questioner: Follows posing questions sequence when asking questions.

PERFORMANCE TASK

Ask a recall question to the group about the children’s story, “Goldilocks and the Three Bears” using the posing questions sequence.

Performance Element	Met the Standard (Level 3)	Met the Standard With Difficulty (Level 2)	Did Not Meet the Standard (Level 1)
Pose the question	Had the attention of the group. Asked the question clearly.	Had the attention of the group. Did not ask the question clearly.	Did not get the attention of the group. Did not ask the question carefully.
Pause	Allowed cadets ample time to think of a response. Did not waste time. Did not answer the question for the cadets.	Unsure of how much time to allow for a response.	Allowed too much/too little time for a response. Answered the question for the cadet.
Pounce	Pointed to a cadet.	Had to be told to point to a cadet.	Allowed anyone to answer.
Ponder	Allowed cadet to answer fully. Confirmed correct response. Explained incorrect answer.	Allowed cadet to answer fully. Confirmed correct response after being prompted. Explained incorrect response after being prompted.	Did not allow cadet to answer fully. Did not confirm correct response after being prompted. Did not explain incorrect response after being prompted.
Praise	Ensured all cadets participated. Praised correct response appropriately. Clarified any confusion regarding responses.	Ensured all cadets participated. Had to be prompted to praise correct response. Had to be prompted to clarify confusion regarding responses.	Did not ensure all cadets participated. Failed to praise correct responses. Did not clarify lingering confusion regarding responses.

THIS PAGE INTENTIONALLY LEFT BLANK

POSING QUESTIONS CHECKLIST

Place a check mark in the appropriate box.

Name	Pose the Question			Pause			Pounce			Ponder			Praise			
	Level 1	Level 2	Level 3	Level 1	Level 2	Level 3	Level 1	Level 2	Level 3	Level 1	Level 2	Level 3	Level 1	Level 2	Level 3	

THIS PAGE INTENTIONALLY LEFT BLANK

COMMON INSTRUCTIONAL AIDS

INSTRUCTIONAL AIDS

HOW INSTRUCTIONAL AIDS WORK

During the communication process, the brain filters the important pieces of information from the less significant pieces. What is considered to be the most important information is passed to the short-term memory for possible storage into the long-term memory. Instructional aids support learning by highlighting and emphasizing the most important pieces of information for the brain to store in memory.

Instructional aids also:

- attract and hold the cadets' attention;
- involve the two most important senses—sight and sound; and
- help instructors teach more in less time.

CHARACTERISTICS OF INSTRUCTIONAL AIDS

Instructional aids should:

- support the lesson by emphasizing and clarifying important information;
- keep the cadets' attention on the topic;
- contain quality pictures, graphs or text;
- be simple and easy to use; and
- be large enough to be seen and loud enough to be heard.

GUIDELINES FOR USING INSTRUCTIONAL AIDS

During the lesson planning stage the following process can be used to determine if and where instructional aids are necessary:

- clearly establish the lesson objective—the information to be communicated or the task to be accomplished;
- research supporting material to achieve the lesson objective;
- organize the material into a lesson plan; and
- select the important points to be supported by instructional aids.

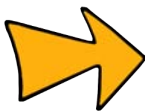

Instructional aids should be used only if they support learning and should not be made visible until the appropriate time during a lesson so as not to become a distraction.

VERBAL SUPPORT

Almost all ideas need some sort of clarification, explanation or proof to be understood. If cadets are learning something new, they want proof to support what is being said. The lesson topic, the instructional method, the cadets' background knowledge and the size of the group are factors that determine how much learning support is required.

Verbal support is one type of support instructors use to clarify, prove, illustrate, emphasize or to add variety and interest to information during a lesson. Types of verbal support include:

- **COMPARISONS**

A comparison is a bridge built by the instructor between the known and the unknown. New information can be clarified by pointing out its **similarity** to a familiar topic, idea or situation. A factual comparison clarifies by highlighting how two or more related things are **similar**. For example, a factual comparison is used when the similarities between two or more different classes of ships are highlighted. A contrast clarifies by highlighting how two or more things are **different**. A contrast is used when the **differences** between two or more types of uniforms are highlighted. Figurative comparisons use similes and metaphors to add variety and gain attention. A figurative comparison is used when expressions such as the "ship cut through the water like a knife" or "the ship knifed through the water" are used to indicate the ship's speed.

- **REASONS**

Reasons are logical explanations that satisfy the question "why". Explaining the reason for something often makes it easier for the cadets to accept what is being explained. When instructors cite "safety concerns" as the reason why a task must be completed a certain way, they are using reasons as verbal support.

- **RESTATEMENT AND REPETITION**

Instructors can emphasize main ideas or key points by repeating them. One way to repeat something is to restate it in a different way. Skillful repetition can also persuasively help cadets accept an idea or point of view. Sometimes directions or instructions need to be repeated many times without change for clarity.

- **EXAMPLES**

An example is a specific instance of a general idea used to clarify or simplify information. It should be short and specific and in the cadets' background knowledge so that the cadets can associate new information with something already known.

- **STATISTICS**

Statistics are a summary of numerical information about an event or thing. If properly used, statistics help instructors prove or emphasize main points and create interest in the information. Do not assume, however, that verbal support is being used every time a number or figure is quoted. For example, saying "last year's national budget for cadets was approximately \$180 million" is a statement of fact but saying "last year's cadet budget was approximately \$3 000.00 for every cadet in Canada" is using statistics to emphasize the point that the cadet budget is large.

- **TESTIMONY**

Testimony is simply using the experiences, words and thoughts of others to emphasize or prove points. Testimonials are believable because they are offered by experts or people with first-hand knowledge. For

example, simply saying, “the cadet organization offers many advantages to youth” is not as powerful as quoting or hearing from cadets who have gone through the program and realized its benefits.

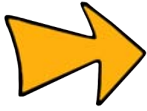

The acronym **CRREST** can be used to remember the different types of verbal support.

AUDIOVISUAL AIDS

Instructional aids appeal to all five senses. Audiovisual aids are particularly effective because individuals learn and retain over 50 percent of what they both see and hear.

MODELS

A model is a copy of a real object and can be an enlargement, a reduction or the same size as the original. Two types of models are:

- the scale model which is an exact reproduction of the original, and
- the simplified model, which does not represent reality in all details.

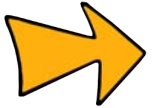

As instructional aids, models are usually more practical than the real object because they are lightweight and easy to manipulate.

Mock-Ups

A mock-up is a three dimensional or specialized type of working model and is used for study, training or testing in place of the real object, which may be too costly, too dangerous or impossible to obtain. The advantage of the mock-up over the real thing is that the mock-up may emphasize the essential elements to be learned by distinguishing them from non-essential elements.

Cut-Aways

Some models are solid and show only the outline of the object while others can be manipulated or operated. Specialized models, called cut-aways, are built in sections and can be taken apart to reveal an internal structure. Whenever possible, the various parts should be labelled and coloured to clarify relationships.



Production and equipment costs are limiting factors in developing and using models, mock-ups and cut-aways. If a two-dimensional representation will satisfy the instructor's needs it should be used.

THE REAL OBJECT AND REALISTIC IMAGES

The real object is often the most effective visual aid. To be effectively used the real object should be safe and big enough for everyone to see or small enough and available enough for each cadet to have one. Realistic images, including quality photographs or drawings of the real object, are suitable replacements if the real object cannot be obtained or effectively used.



Realistic images and objects are most effective when they are used after a teaching point has been introduced.

GRAPHICS

Graphics, which include charts, graphs, maps, diagrams, drawings and cartoons, can be used to clarify relationships between concepts or effectively explain a concept that would otherwise require a lengthy description.

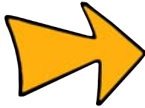

Graphics catch the cadets' attention and stimulate thinking by:

- presenting one idea;
- avoiding too many details; and
- using colours, which contrast with the background to emphasize main points.

PROJECTED MATERIAL

Projected material includes videotapes, DVDs and slides projected by an overhead projector or computer. Short, high-quality video presentations have become one of the most popular instructional aids.

Passive video, which includes VHS, DVDs and slides, provides motion, colour, sound and in some cases special advanced graphic and animation techniques. The availability, low cost and user-friendly characteristics are important advantages of passive video but instructors should be aware it is often difficult for instructional video to compete with the action-packed entertainment videos and is often considered less exciting and stimulating by cadets. This, in addition to the cadets' often passive viewing style for entertainment videos, can diminish the instructional value of the video.

To increase the value of passive video for instructional purposes, instructors should follow these basic guidelines:

- preview the video to determine the important points and concepts;
- prepare the cadets for viewing the video by stressing what is important to watch; and
- summarize the presentation and answer any questions the cadets may have.



Video presentations are not designed to replace the instructor.

Videotapes and DVDs are generally purchased but slides can easily be developed by hand or by using a computer.

Guidelines for developing slides are:

- illustrate key points;
- use key words or phrases as headers for each slide;
- include a maximum of six words per line and six lines per slide; and
- use lettering large enough to be clearly read from the back of the classroom.



Use of projected materials requires planning and practice. Instructors should set up and adjust the equipment and lighting beforehand and always preview the presentation.

Interactive video refers to software that responds to choices and commands by the user. A typical system consists of a combination of a compact disk and computer with video presentation capability. The software may include image banks of colour photos and graphics as well as questions or directions, which are programmed to create interactivity for students as they progress through the course.

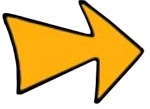

Interactive video solves one of the main problems of passive video in that it increases the cadets' involvement in the learning process. Each cadet receives a customized learning experience.

SIMULATORS

Simulators are mechanical or electronic devices that act like the actual equipment or systems and provide the cadets with realistic practice in a safe and controlled environment. They may have various capabilities such as jump, freeze, record and replay which can capture and playback information for instructional feedback. Simulators replicate the real thing at a fraction of the cost.

Some concerns include:

- the need for the provision of background information,
- the requirement for hardware and software maintenance,
- the need for expertise to run the simulator, and
- the need for specialized facilities.

Some of the more commonly recognized simulators include flight simulators, driver training simulators and marine simulators, which simulate normal and emergency situations, which would otherwise be encountered in real life.

TRAINING EQUIPMENT

Training equipment refers to the use of actual equipment such as boats, air rifles, or gliders for training purposes. The main advantage of this type of aid is that it is the actual piece of equipment or system that the cadet will be expected to use. Despite the benefits of simulators, training is not complete without intensive training in or with the real thing.

Some concerns include:

- the need for subject matter experts,
- the high maintenance costs,
- the need for modifications for instructional purposes, and
- scheduling difficulties caused by external factors such as weather and the availability of the resources.

In short, cadets will only learn to sail, fly or complete an expedition by using a sailboat or glider or travelling to the field.

SELECT AN INSTRUCTIONAL AID

GUIDELINES FOR SELECTING INSTRUCTIONAL AIDS

During the lesson planning stage the following process can be used to determine if and where instructional aids are necessary:

- clearly establish the lesson objective—the information to be communicated or the task to be accomplished;
- research supporting material to achieve the lesson objective;
- organize the material into a lesson plan; and
- select the important points to be supported by instructional aids. Instructional aids are appropriate when:
 - long segments of technical description are necessary;
 - a point is complex and difficult to put into words;
 - instructors find themselves forming visual images; and
 - students are puzzled by an explanation or description.

The selection of instructional aids depends on several factors, which include:

- **Availability.** Which ready-made aids are available? What resources are available to make instructional aids?
- **Facilities.** Does the training area or equipment available allow the instructor to use certain instructional aids?
- **Cost.** Are the instructional aids too expensive to purchase or produce?
- **Class Size.** Does the number of people in the class make the use of the instructional aid practical? Does the instructional aid encourage cadet participation?

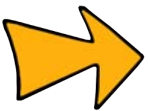

Instructional aids should be used only if they support learning and should not be a distraction.

INSTRUCTIONAL AIDS WORKSHEETS

INSTRUCTIONAL AIDS Worksheet

1. How do instructional aids support learning?

2. In your opinion, what is the most important characteristic of instructional aids?

3. When should instructional aids be used during a lesson?

VERBAL SUPPORT Worksheet

Match Column A with Column B by placing the correct number from Column B opposite the correct phrase from Column A.

Column A

- a. a bridge between the known and unknown _____
- b. numerical information about an event or thing _____
- c. can be used to persuade the cadets to accept an idea _____
- d. a specific instance of a general idea _____
- e. logical explanations that satisfy the question "why" _____
- f. using the words of others to prove a point _____
- g. highlighting how two or more things are different _____

Column B

- 1. testimony
- 2. reasons
- 3. comparison
- 4. statistics
- 5. repetition
- 6. example
- 7. contrast

AUDIOVISUAL AIDS

Worksheet

COMPLETE THE CROSSWORD PUZZLE.

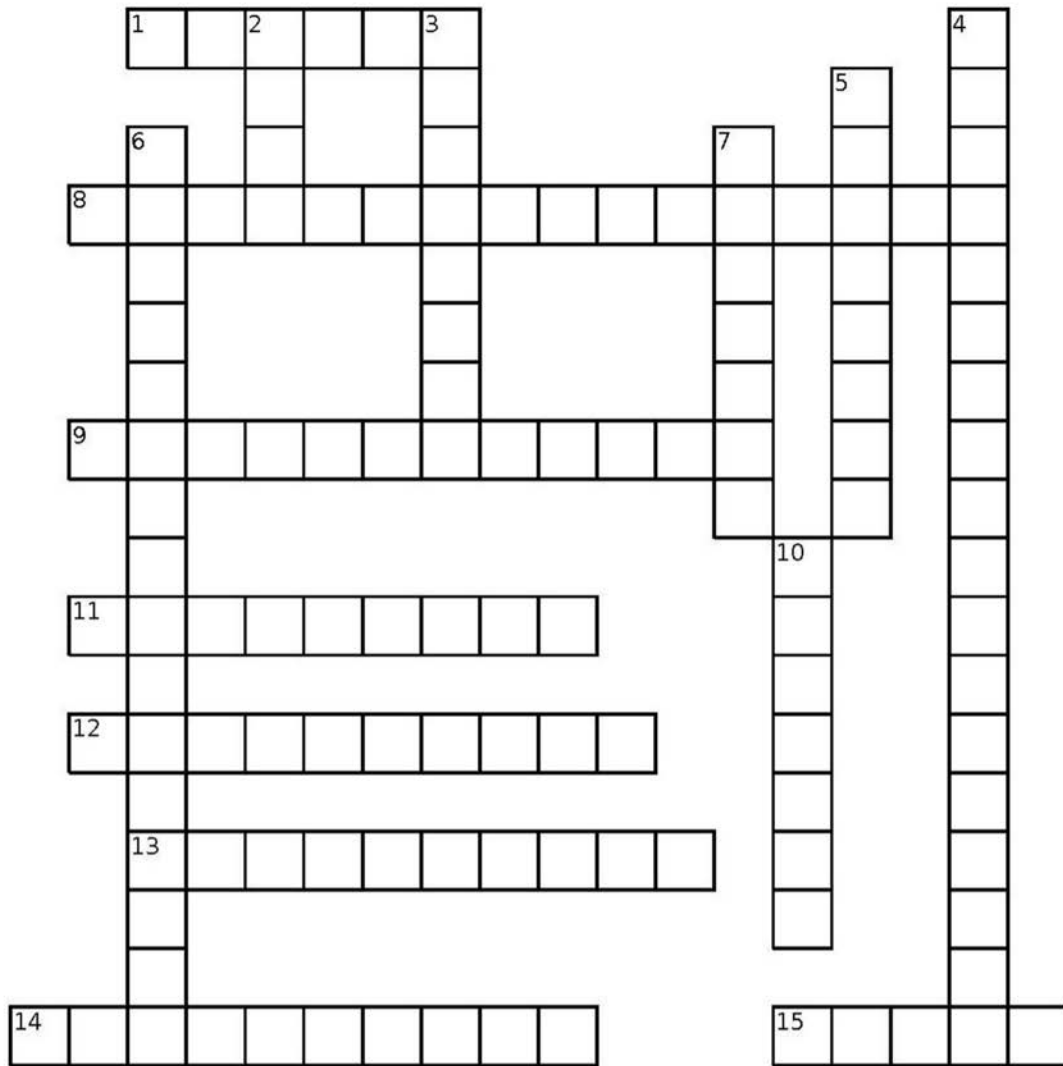

CROSSWORD PUZZLE CLUES

ACROSS

1. a specialized type of working model (2 words)
8. appeals to all five senses (2 words)
9. video, which lacks cadet involvement (2 words)
11. one type of projected material (2 words)
12. the most effective visual aid (2 words)
13. video presentations should not replace the ...
14. an example of a realistic image
15. copy of the real object

DOWN

2. a limiting factor in developing models
3. use of projected material requires planning and ...
4. instructional aids are most effective when they are ... (5 words)
5. can effectively replace a lengthy explanation
6. software that responds quickly to commands (2 words)
7. an example of a graphic instructional aid
10. a model that can be taken apart (2 words)

ANSWER KEY

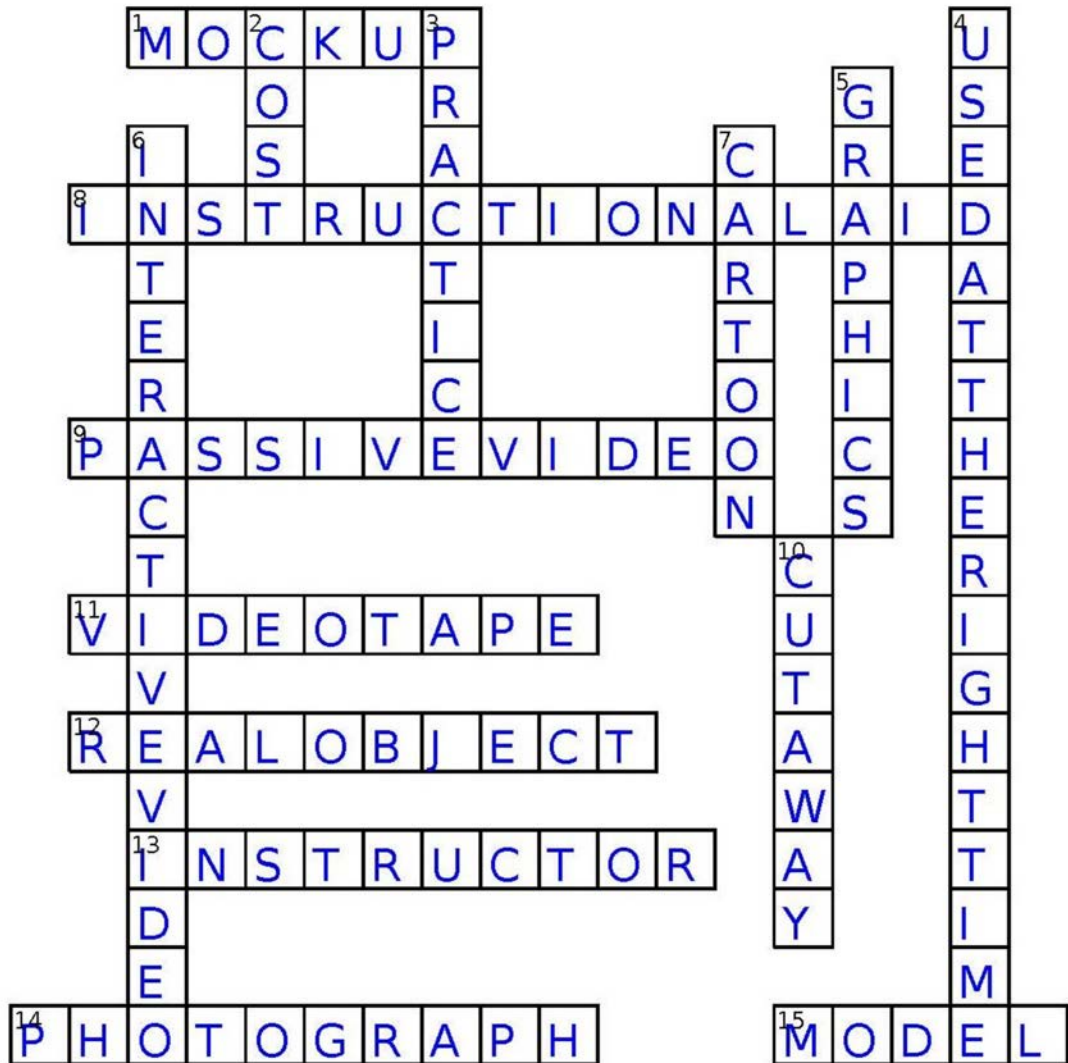

SIMULATORS AND TRAINING EQUIPMENT

Worksheet

1. What do simulators provide the cadets?

2. List four concerns about simulators.

3. What is the main advantage of training equipment as an instructional aid?

4. List four concerns about training equipment.

SELECT AN INSTRUCTIONAL AID Worksheet

Using the "Select an Instructional Aid" information sheet, select an instructional aid you would consider appropriate for each of the topics listed below.

Lesson Topic	Type of Instructional Aid
Participate in a Discussion on Hygienic Practices During Physical Activity	
Identify the Parts and the Characteristics of the Daisy 853C Air Rifle	
Apply Basic Marksmanship Techniques	
Participate in a Discussion on Phase One Training	
Wear the Sea Cadet Uniform	
Participate in a Discussion of Year One Summer Training Opportunities	
Tie Knots, Bends and Hitches (Reef Knot and Figure of Eight)	
Tie Knots, Bends and Hitches (Round Turn and Two Half Hitches)	
Coil and Heave a Line	
Explore Canadian Naval History	
Discuss Leadership Within a Peer Setting	
Identify Year Two CSTC Training Opportunities	
Recognize Naval Ship's Traditions	
Reeve Blocks	
Identify the Rank Structure of the Royal Canadian Sea, Army and Air Cadets	

THIS PAGE INTENTIONALLY LEFT BLANK

LESSON SPECIFICATION AND INSTRUCTIONAL GUIDE HANDOUT

ENABLING OBJECTIVE AND LESSON SPECIFICATION

Performance objectives are broken down into a series of enabling objectives and lesson specifications. The enabling objective consists of Paragraphs 1. to 3. (as illustrated in Figure 9K-1). The information in these paragraphs will answer three questions:

1. What will the cadet be expected to be able to do by the end of this lesson?
2. Under what conditions will the cadet be expected to carry out the performance?
3. How well or to what standard will the cadet be expected to perform?

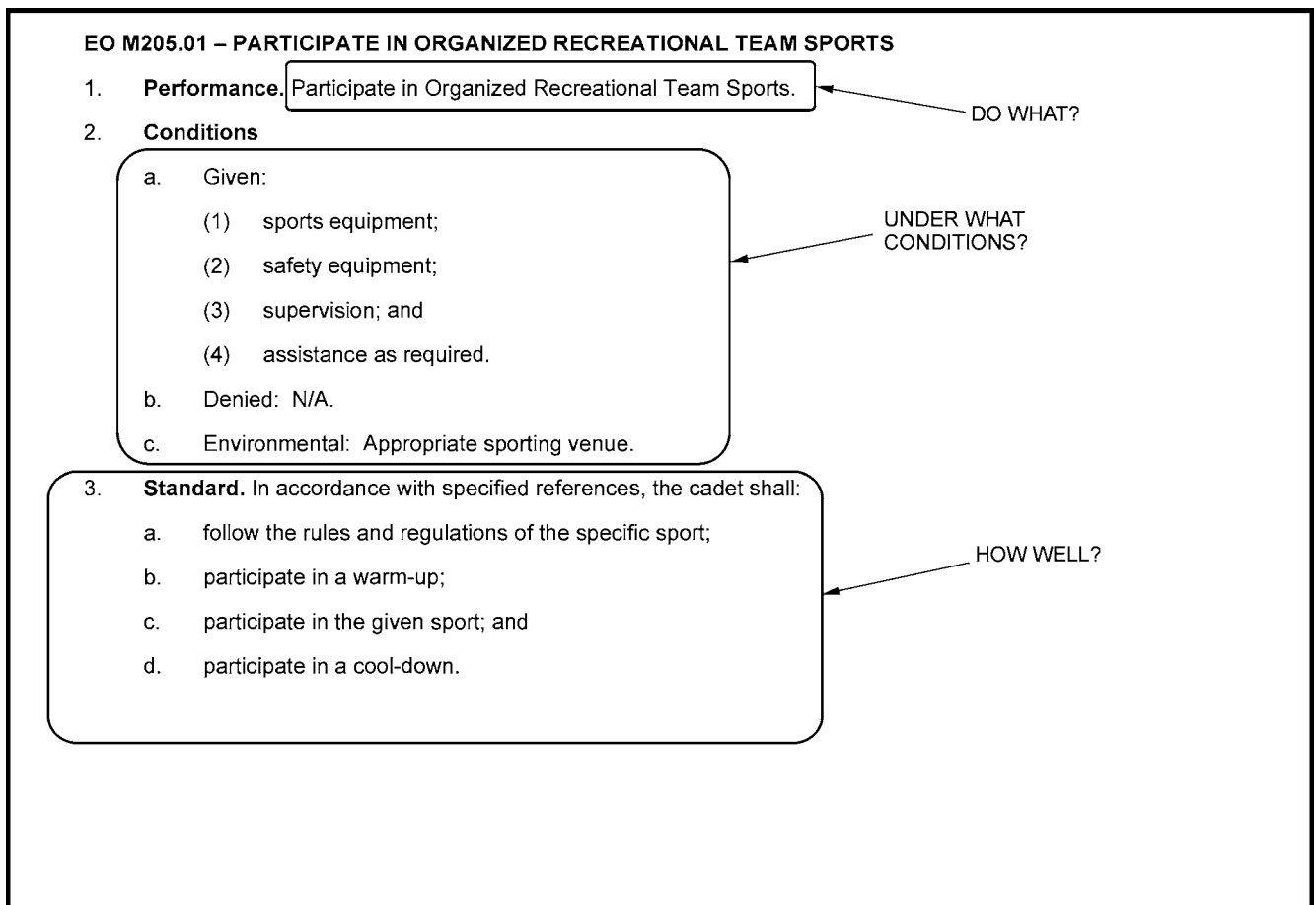

Director Cadets 3, 2008, Ottawa, ON: Department of National Defence

Figure 9K-1 Enabling Objective

Paragraphs 4. to 11. are known as the lesson specification. The lesson specification provides information about the content to be taught, teaching methods, time, references, training aids, learning aids, test details and remarks.

In Paragraph 4., the TPs are usually described in a table where information is provided on the content taught in each TP, the suggested teaching method, the time for each TP and references (as illustrated in Figure 9K-2).

4. Teaching Points

TP	Description	Method	Time	Ref
TP1	Introduce cadets to a specific sport's rules and regulations, to include: a. an overview of how to play the sport; and b. rules and regulations of the sport.	Interactive Lecture	10 min	C0-001
TP2	Conduct a warm-up session, composed of light cardiovascular exercises, meant to: a. stretch the muscles; b. gradually increase respiratory action and heart rate; c. expand the muscles' capillaries to accommodate the increase in blood circulation; and d. raise muscle temperature to facilitate reactions in muscle tissue.	Practical Activity	10 min	C0-002 (pp. 109 to 113) C0-089
TP3	Supervise the cadets' participation in a given sports activity.	Practical Activity	50 min	

Director Cadets 3, 2008, Ottawa, ON: Department of National Defence

Figure 9K-2 Teaching Points

Paragraph 5. outlines how much time is spent on the introduction/conclusion and the different teaching methods. Paragraph 6. offers substantiation or reasons why certain teaching methods were recommended for each TP. Paragraph 7. provides a list of references used to compile the content in Paragraph 4. (as illustrated in Figure 9K-3).

<p>5. Time</p> <p>a. Introduction/Conclusion: 10 min</p> <p>b. Interactive Lecture: 10 min</p> <p>c. Practical Activity: 70 min</p> <p>d. Sub-total: 90 min</p> <p>e. Total (three sessions): 270 min</p> <p>6. Substantiation</p> <p>a. An interactive lecture was chosen for TP1 to illustrate the application of rules, principles, or concepts of the specific sport to be played.</p> <p>b. A practical activity was chosen for TP2-4 as it allows cadets to participate in sports activities in a safe and controlled environment. This activity contributes to the development of sports skills in a fun and challenging setting.</p> <p>7. References</p> <p>a. C0-001 (ISBN 0-88011-807-5) Hanlon, T. (1998). <i>The Sports Rules Book: Essential Rules for 54 Sports</i>. USA: Human Kinetics Publishers, Inc.</p> <p>b. C0-002 (ISBN 0-88962-630-8) LeBlanc, J., and Dickson, L. (1997). <i>Straight Talk About Children and Sport: Advice for Parents, Coaches, And Teachers</i>. Oakville, ON and Buffalo, NY: Mosaic Press.</p>
--

Director Cadets 3, 2008, Ottawa, ON: Department of National Defence

Figure 9K-3 Paragraphs 5. to 7.

Paragraphs 8. and 9. list the training aids and learning aids required for the lesson. Training aids are the materials that are required by the instructor to instruct the lesson and learning aids are the materials that will be required by the cadet to participate in the lesson (as illustrated in Figure 9K-4).

<p>8. Training Aids</p> <p>a. Sports/safety equipment appropriate for the activity;</p> <p>b. First aid kit;</p> <p>c. Whistles; and</p> <p>d. Stopwatch.</p> <p>9. Learning Aids. Sports equipment.</p>
--

Director Cadets 3, 2008, Ottawa, ON: Department of National Defence

Figure 9K-4 Training Aids and Learning Aids

Paragraph 10. is test details, which is information about the evaluation to be conducted. Paragraph 11. is remarks, which describe any other information that may be useful to the Training Officer or instructor (as illustrated in Figure 9K-5).

10. **Test Details.** N/A.

11. **Remarks**

- a. The CCO list of approved sports is located at A-CR-CCP-602/PF-001, Chapter 5, Annex A.
- b. Recreational sports can be carried out as nine periods during a supported day or over three sessions of three periods each.

Director Cadets 3, 2008, Ottawa, ON: Department of National Defence

Figure 9K-5 Test Details and Remarks

INSTRUCTIONAL GUIDE

The IG is used in conjunction with the QSP and other resources to conduct training. IGs should be reviewed in conjunction with lesson specifications so that the instructor can adequately plan and prepare their lesson. IGs do not replace lesson plans but offer written content, supporting figures and suggestions on how to instruct a lesson. The following are the six sections of an IG:

1. preparation,
2. introduction,
3. body,
4. conclusion,
5. references, and
6. annexes.

Preparation



The preparation section provides information about where to find the lesson specification and any instructions to the instructor such as reviewing lesson content, photocopying handouts, pre-lesson assignments and the approach and substantiation as to why certain teaching methods were recommended for each TP.

Introduction

The introduction section provides information to the instructor about review that may be necessary, what the cadet will be expected to do by the end of the lesson and why the knowledge/skills are important.

The Body

The body of the IG contains all of the TPs and content listed in Paragraph 4. of the lesson specification in greater detail. The body provides suggested teaching methods, note boxes with special instructions or information (as illustrated in Figure 9K-6), lesson content, figures, activities and confirmation questions.

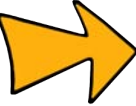
Note Boxes:	
	Special note to the instructor.
	key information to pass along to the cadets.
	Refer to the following CF regulations and policies.
	Points of interest or special instructions the instructor should pass along to the cadets.

Director Cadets 3, 2008, Ottawa, ON: Department of National Defence

Figure 9K-6 Note Boxes

The Conclusion

The conclusion section states any homework/reading/practice that may be required of the cadet and the method of evaluation as stated in the lesson specification. The conclusion section also provides a closing statement to be spoken aloud to the cadets and any additional instructor notes/remarks.

References

The reference section lists the references used to create the lesson specification and instructional guide. In some cases, an IG may direct the instructor to a specific reference to be used during a lesson. In most cases this section is only used to identify where the content of the lesson has been drawn from.

Annexes

The annex section contains information that may range from pre-made training aids, learning aids such as handouts and additional information for activities.

THIS PAGE INTENTIONALLY LEFT BLANK

PLAN A LESSON CHECKLIST

PREPARATION	NOTES
<p>Have you:</p> <ul style="list-style-type: none"> <input type="checkbox"/> Selected an appropriate lesson location? <input type="checkbox"/> Selected an appropriate method of instruction? <input type="checkbox"/> Provided for a review of previous lesson materials? 	
INTRODUCTION	
<p>Does your introduction:</p> <ul style="list-style-type: none"> <input type="checkbox"/> State what the cadets will learn? <input type="checkbox"/> Describe why the information is important to learn? <input type="checkbox"/> Describe where and when the information/skill can be used? 	
BODY	
<p>Does the body of your lesson:</p> <ul style="list-style-type: none"> <input type="checkbox"/> Include the different principles of instruction? <input type="checkbox"/> Include questions? <input type="checkbox"/> Provide for the use of instructional aids? <input type="checkbox"/> Used explanation and demonstration? (skill lesson only) <input type="checkbox"/> Confirm each TP? 	
END OF LESSON CONFIRMATION	
<ul style="list-style-type: none"> <input type="checkbox"/> Did you conduct an end of lesson confirmation by using questions or by conducting an activity? 	
CONCLUSION	
<p>Does your conclusion:</p> <ul style="list-style-type: none"> <input type="checkbox"/> Summarize the lesson? <input type="checkbox"/> Re-motivate the cadets by: <ul style="list-style-type: none"> <input type="checkbox"/> commenting on their progress; and <input type="checkbox"/> re-stating why the information learned is important? <input type="checkbox"/> Describe the next lesson? 	

THIS PAGE INTENTIONALLY LEFT BLANK

LIST OF APPROVED 15-MINUTE TOPICS

- TP 1 of M104.01 (Identify Activities That Will Help Achieve a Healthy Active Lifestyle, A-CR-CCP-601/PG-001, Chapter 4, Section 4 and A-CR-CCP-601/PF-001, Chapter 4, Section 1)
- TP 1 of M106.01 (Identify the Parts and the Characteristics of the Daisy 853C Air Rifle, A-CR-CCP-601/PG-001, Chapter 4, Section 6 and A-CR-CCP-601/PF-001, Chapter 6, Section 1)
- TP 4 of M106.03 (Apply Basic Marksmanship Techniques, A-CR-CCP-601/PG-001, Chapter 4, Section 6 and A-CR-CCP-601/PF-001, Chapter 6, Section 3)
- TP 1 of M203.01 (Discuss Leadership Within a Peer Setting, A-CR-CCP-602/PG-001, *Royal Canadian Sea Cadets Phase Two Qualification Standard and Plan*, Chapter 4, Section 3 and A-CR-CCP-602/PF-001, Chapter 3, Section 1)
- TP 1 of M121.01 (Tie Knots, Bends and Hitches [Reef Knot and Figure of Eight], A-CR-CCP-601/PG-001, Chapter 4, Section 10 and A-CR-CCP-601/PF-001, Chapter 10, Section 1)
- TP 3 of M121.01 (Tie Knots, Bends and Hitches [Round Turn and Two Half Hitches], A-CR-CCP-601/PG-001, Chapter 4, Section 10 and A-CR-CCP-601/PF-001, Chapter 10, Section 1)
- TP 2 of M121.03 (Coil and Heave a Line, A-CR-CCP-601/PG-001, Chapter 4, Section 10 and A-CR-CCP-601/PF-001, Chapter 10, Section 3)
- TP 1 of C120.03 (Explore Canadian Naval History, A-CR-CCP-601/PG-001, Chapter 4, Section 9 and A-CR-CCP-601/PF-001, Chapter 9, Section 6)
- TP 1 of M220.03 (Recognize Naval Ship's Traditions, A-CR-CCP-602/PG-001, Chapter 4, Section 10 and A-CR-CCP-602/PF-001, Chapter 10, Section 3)
- TP 3 of M221.03 (Reeve Blocks, A-CR-CCP-602/PG-001, Chapter 4, Section 11 and A-CR-CCP-602/PF-001, Chapter 11, Section 3)
- TP 2 of M221.05 (Rig Tackles, A-CR-CCP-602/PG-001, Chapter 4, Section 11 and A-CR-CCP-602/PF-001, Chapter 11, Section 5)
- TP 2 of M223.02 (Identify the Watch System, A-CR-CCP-602/PG-001, Chapter 4, Section 12 and A-CR-CCP-602/PF-001, Chapter 12, Section 2)
- TP 1 of M223.07 (Identify the Procedure for Berthing a Ship, A-CR-CCP-602/PG-001, Chapter 4, Section 12 and A-CR-CCP-602/PF-001, Chapter 12, Section 7)
- TPs 1 and 2 of M224.02 (Prepare for Sail Training, A-CR-CCP-602/PG-001, Chapter 4, Section 13 and A-CR-CCP-602/PF-001, Chapter 13, Section 2)
- TP 1 of C207.01 (Identify the Rank Structure of the Royal Canadian Army and Air Cadets, A-CR-CCP-602/PG-001, Chapter 4, Section 7 and A-CR-CCP-602/PF-001, Chapter 7, Section 5)

<p>Note: The TPs in this list were selected because they best fit into the 15-minute format. The selected EOs are a variety of knowledge and skill-based lessons.</p>
--

THIS PAGE INTENTIONALLY LEFT BLANK

MODIFIED LESSON SPECIFICATIONS AND INSTRUCTIONAL GUIDES – TP 1 OF EO M104.01

A-CR-CCP-601/PG-001

EO M104.01 – IDENTIFY ACTIVITIES THAT WILL HELP ACHIEVE A HEALTHY ACTIVE LIFESTYLE

1. **Performance.** Identify Activities that will Help Achieve a Healthy Active Lifestyle.
2. **Conditions**
 - a. Given:
 - (1) a copy of *Canada’s Physical Activity Guide to Healthy Active Living*;
 - (2) supervision; and
 - (3) assistance as required.
 - b. Denied: N/A.
 - c. Environmental: Suitable classroom facilities/training area large enough to accommodate entire group.
3. **Standard.** In accordance with *Canada’s Physical Activity Guide to Healthy Active Living*, the cadet shall identify activities that will help achieve a healthy and active lifestyle.
4. **Teaching Points**

TP	Description	Method	Time	Ref
TP1	Introduce cadets to <i>Canada’s Physical Activity Guide to Healthy Active Living</i> , to include: <ol style="list-style-type: none"> a. page 4 – Check Out What You Are Doing Now; b. page 5 – Benefits of Physical Activity; c. page 6 – What Are You Into; d. page 8 – Let’s Get Active; and e. page 10 – Crank Up Your Activity. 	Interactive Lecture	10 min	C0-020 (pp. 4 to 10)

5. **Time**
 - a. Introduction/Conclusion: 5 min
 - b. Interactive Lecture: 10 min
 - c. Total: 15 min
6. **Substantiation.** For TP1, the interactive lecture method was chosen as it allows the instructor to make a semi-formal presentation of the material where the cadets can participate by asking or responding to questions and commenting on the material. For this lesson, this method is most effective as it matches well the taxonomic level of the material and is age-appropriate by virtue of its participatory nature.
7. **References.** C0-020 (ISBN 0-662-32899) Minister of Health. (2002). *Canada’s Physical Activity Guide to Healthy Active Living* [Brochure].
8. **Training Aids**
 - a. Presentation aids (i.e. whiteboard/flipchart/OHP) appropriate for classroom/training area; and
 - b. *Canada’s Physical Activity Guide to Healthy Active Living*.

9. **Learning Aids.** *Canada's Physical Activity Guide to Healthy Active Living.*
10. **Test Details.** N/A.
11. **Remarks.** N/A.

A-CR-CCP-601/PF-001



COMMON TRAINING
PHASE ONE
INSTRUCTIONAL GUIDE



SECTION 1

EO M104.01 – IDENTIFY ACTIVITIES THAT WILL HELP ACHIEVE A HEALTHY ACTIVE LIFESTYLE

Total Time: 15 min

PREPARATION

PRE-LESSON INSTRUCTIONS

A complete list of resources needed for the instruction of this EO is located at Chapter 4 of the QSP. Specific uses for said stores are identified throughout the Instructional Guide, within the teaching point for which they are required.

The instructor shall review the lesson content and become familiar with the material prior to the instruction of the lesson.

PRE-LESSON ASSIGNMENT

N/A.

APPROACH

For TP1, the interactive lecture method was chosen as it allows the instructor to make a semi-formal presentation of the material where the cadets can participate by asking or responding to questions and commenting on the material. For this lesson, this method is most effective as it matches well the taxonomic level of the material and is age-appropriate by virtue of its participatory nature.

INTRODUCTION

REVIEW

N/A.

OBJECTIVES

By the end of this lesson the cadet shall be expected to identify activities that will help them achieve a healthy and active lifestyle.

IMPORTANCE

Physical fitness is one of the three aims of the cadet program. Teaching the cadets what activities contribute to an active lifestyle will help them achieve physical fitness.

A-CR-CCP-601/PF-001

Teaching Point 1

Introduce Cadets to *Canada's Physical Activity Guide to Healthy Active Living*

Time: 10 min

Method: Interactive Lecture

CANADA'S PHYSICAL ACTIVITY GUIDE TO HEALTHY ACTIVE LIVING

Hand out *Canada's Physical Activity Guide to Healthy Active Living*, highlighting the following pages and information detailed there:

- **Page 4 – Check Out What You Are Doing Now.** Is your exercise time more than 90 minutes per day? Less than 90 minutes but more than 60? Less than 60 but more than 30? Have each cadet write down their activities from yesterday and two days ago to add up their total time.
- **Page 5 – Benefits of Physical Activity.** Meet new friends, improve physical self-esteem, achieve a healthy weight, build strong bones and strengthen muscles, maintain flexibility, promote good posture and balance, improve fitness, strengthen the heart, increase relaxation and promote healthy growth and development.
- **Page 6 – What Are You Into.** Walking, running, hiking, cycling, swimming, jogging, gymnastics, ice-skating, skiing, basketball, volleyball, tobogganing, soccer, football, tennis, baseball, softball, dancing, yoga, climbing, bowling, hockey, skateboarding, badminton, etc. Have the cadets brainstorm all the activities they can think of that they may be interested in.
- **Page 8 – Let's Get Active.** Increase the time currently spent on physical activity and reduce non-active time.
- **Page 10 – Crank Up Your Activity.** Walking instead of taking the bus, playing ball at breaks, walking the dog, raking leaves, shovelling snow, carrying groceries, etc. Brainstorm ideas that will help increase current physical activity.

The purpose of highlighting these pages is to fuel the discussion for the next teaching point. The cadets may take home the guides and explore them further afterwards.

END OF LESSON CONFIRMATION

The confirmation of this lesson will occur in EO M104.02 (Section 2) as the cadets develop a personal activity plan.

CONCLUSION

HOMEWORK/READING/PRACTICE

N/A.

METHOD OF EVALUATION

There is no formal assessment of this EO.

CLOSING STATEMENT

As physical fitness is one of the aims of the cadet program, it is important that cadets learn what activities contribute to an active lifestyle to help them achieve physical fitness.

A-CR-CCP-601/PF-001

INSTRUCTOR NOTES/REMARKS

N/A.

REFERENCES

- C1-011 (ISBN 0-662-32899) Minister of Health (2002). *Canada's Physical Activity Guide to Healthy Active Living* [Brochure].
- C3-024 (ISBN 0-7627-0476-4) Roberts, H. (1989). *Basic Essentials Backpacking*. Guildford, CT: The Globe Pequot Press.

THIS PAGE INTENTIONALLY LEFT BLANK

MODIFIED LESSON SPECIFICATIONS AND INSTRUCTIONAL GUIDES – TP 1 OF EO M106.01

A-CR-CCP-601/PG-001

EO M106.01 – IDENTIFY THE PARTS AND CHARACTERISTICS OF THE DAISY 853C AIR RIFLE

1. **Performance.** Identify the Parts and Characteristics of the Daisy 853C Air Rifle.
2. **Conditions**
 - a. Given:
 - (1) Daisy 853C air rifle;
 - (2) assistance as required; and
 - (3) supervision.
 - b. Denied: N/A.
 - c. Environmental: Suitable classroom facility and/or air rifle range constructed IAW A-CR-CCP-177/PT-001, Chapter 1, sect 8.
3. **Standard.** In accordance with A-CR-CCP-177/PT-001, the cadet shall identify the parts and list the characteristics of the Daisy 853C air rifle.
4. **Teaching Points**

TP	Description	Method	Time	Ref
TP1	Identify the parts of the Daisy 853C air rifle, to include: <ol style="list-style-type: none"> a. butt plate; b. spacers; c. small of the butt; d. stock; e. fore end; f. sling bracket; g. trigger; h. trigger guard; i. safety catch; j. bolt; k. pump handle; l. front sight; m. rear sight; n. muzzle; o. barrel with barrel weight; p. bore; q. feed track; r. chamber; s. sling; t. single shot adapter; and 	Interactive Lecture	10 min	A0-027 (p. 2-5, Diagram)

TP	Description	Method	Time	Ref
	u. five-shot clip. Note: The instructor shall ensure that the cadet can identify the parts of the cadet air rifle by physically pointing to the proper part on the rifle or on an unlabeled diagram.			

5. **Time**

- a. Introduction/Conclusion: 5 min
- b. Interactive Lecture: 10 min
- c. Total: 15 min

6. **Substantiation.** The interactive lecture method was chosen as it best allows the instructor to make a semi-formal presentation of the material allowing the cadets to participate by asking or responding to questions, commenting on the material, or participating in short activities. This method appeals to auditory learners, with the potential for active participation in activities that appeal to tactile/kinaesthetic learners.

7. **References.** A0-027 A-CR-CCP-177/PT-001 D Cds 3. (2001). *Canadian Cadet Movement: Cadet Marksmanship Programme Reference Manual*. Ottawa, ON: Department of National Defence.

8. **Training Aids**

- a. Daisy 853C air rifle; and
- b. Presentation aids (i.e. whiteboard/flipchart/OHP) appropriate for classroom/training area.

9. **Learning Aids.** Daisy 853C air rifle.

10. **Test Details.** Assessment of this EO shall be carried out during the end of lesson check. While there is no formal assessment of this EO, every cadet is required to successfully complete the Cadet Air Rifle Handling Test provided at Chapter 3, Annex C.

11. **Remarks.** N/A.

A-CR-CCP-601/PF-001



COMMON TRAINING
PHASE ONE
INSTRUCTIONAL GUIDE



SECTION 1

EO M106.01 – IDENTIFY THE PARTS AND THE CHARACTERISTICS OF THE DAISY 853C AIR RIFLE

Total Time: 15 min

PREPARATION

PRE-LESSON INSTRUCTIONS

A complete list of resources needed for the instruction of this EO is located at Chapter 4 of the QSP. Specific uses for said stores are identified throughout the Instructional Guide, within the teaching point for which they are required.

Prior to instructing this lesson the instructor shall:

- review the lesson content, and become familiar with the material;
- carry out a safety precaution check on all rifles to be used during this lesson; and
- state to cadets that the rifles have been inspected and are safe to handle.

PRE-LESSON ASSIGNMENT

N/A.

APPROACH

This lesson will be presented using the interactive lecture method. The interactive lecture method was chosen as it best allows the instructor to make a semi-formal presentation of the material allowing the cadets to participate by asking or responding to questions, commenting on the material, or participating in short activities. This method appeals to auditory learners, with the potential for active participation in activities that appeal to tactile/ kinaesthetic learners.

INTRODUCTION

REVIEW

N/A.

OBJECTIVES

By the end of this lesson the cadet shall be expected to identify the parts, and list the characteristics of the cadet air rifle.

A-CR-CCP-601/PF-001

IMPORTANCE

Cadets must have a basic knowledge of the cadet air rifle in order to understand how the rifle works and to safely follow directions given on the range.

Teaching Point 1

Identify the Parts of the Daisy 853C Air Rifle

Time: 10 min

Method: Interactive Lecture

PARTS



- Depending on the number of rifles available, distribute them with an optimum ratio of one rifle for every two cadets.
- When possible, have a second instructor in the room to assist.
- **For safety purposes, maintain strict class control at all times.**

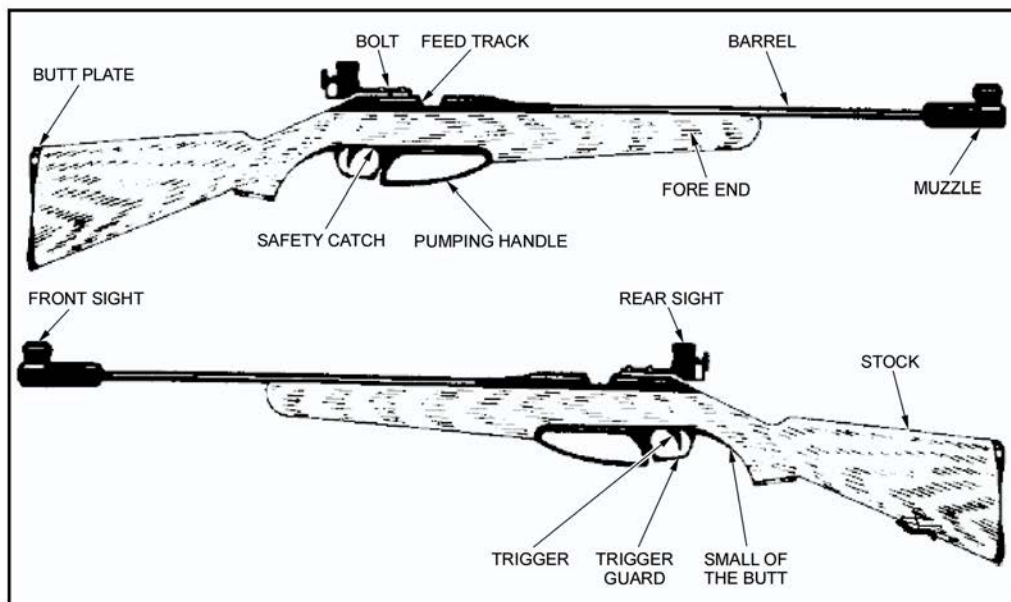

A-CR-CCP-177/PT-001

Figure 6-1-1 Parts of the Cadet Air Rifle

Butt Plate (End of the Butt). It is the part of the rifle directly in contact with the marksman's shoulder. When fitted properly, the butt plate aids in achieving a snug fit, and a consistent placement of the rifle into the shoulder. The addition of butt spacers allows for this adjustment in length.

Spacers. Plastic inserts that can be added or removed from the butt plate to vary its length. To add or take away butt spacers, use a Phillips screwdriver to loosen the butt plate and slide in/out the amount of spacers desired.

A-CR-CCP-601/PF-001

Small of the Butt (Pistol Grip). Curved area directly behind the trigger guard where the hand controlling the trigger grips the rifle.

Stock. Complete wooden portion of the rifle (from the butt plate end forward).

Fore End (of the Stock). Wooden portion of the stock from the trigger guard forward, in which the barrel and the rifle mechanism are encased.

Sling. It is a web sling made of nylon. Links the rifle to the marksman's arm to support most of the weight of the rifle. One end attaches to the sling bracket and the other to the upper arm.

Sling Bracket (Hand Stop). Adjustable metal clasp attached to the fore stock used to affix the sling to the rifle. It also acts as a hand stop, used to rest the left hand to prevent it from moving.

Trigger. Movable device that releases a spring and releases the rifle mechanism. This rifle has a single stage trigger that cannot be adjusted for weight.

Trigger Guard. Metal band that surrounds and protects the trigger.

Safety Catch. This is a mechanism that, once engaged, prevents the rifle from firing by locking the trigger in place. It is a cross bolt type device located on the trigger guard. The black side indicates that the rifle is unable to fire; the red side indicates the rifle is ready to fire. It should be ON (no red) at all times, unless firing.

Bolt. Metal lever used for opening or closing the rifle mechanism. It must be in the closed position in order to fire. For maximum safety when the rifle is uncased and not firing, the bolt should be kept open.

Pump Handle. Metal lever used to compress the air required to fire the pellet. Whenever the rifle is in a "safe rifle status", the pump lever should be left partially open.

Front Sight. Global front sight that uses aperture inserts.

Rear Sight. Micrometer sight adjustable for windage and elevation. It is easily attached to a metal rail located above the action. This rail allows for adjustment of the sight forward or backward, in order to maintain proper eye relief. The sight is attached using a small flat-blade screwdriver.

Muzzle. Front end of the barrel equipped with attachable barrel weight.

Barrel With Barrel Weight. Steel tube through which the pellet travels, extending from the muzzle to the chamber. The barrel weight ensures that the rifle's weight is evenly distributed and that the rifle's balance is maintained.

Bore. Interior of the barrel has spiral grooves cut into it. The lands are the ridges of metal between the grooves. Together, the grooves and lands are called rifling.

Feed Track. Delicate area where the pellet is inserted manually onto a single pellet adapter, or with a five-shot clip.

Single Shot Adapter. Plastic clip that aids in placing a pellet in the chamber.

Five-shot Clip. Plastic clip that holds a maximum of five pellets and used to place the pellets in the chamber.

Chamber. Location where the pellet is held before firing.

CONFIRMATION OF TEACHING POINT 1

The instructor shall ensure that the cadet can identify the parts of the cadet air rifle by physically pointing to the parts, and having the cadets properly name the part.

A-CR-CCP-601/PF-001

END OF LESSON CONFIRMATION

This EO may be confirmed with the handout found at Annex A. Allow cadets a few minutes to complete the annex, then have cadets switch sheets for correcting.



Correctly labelled diagram is located at page 6A-2.

CONCLUSION

HOMEWORK/READING/PRACTICE

Cadets are to take home the corrected handout to study the parts of the cadet air rifle.

METHOD OF EVALUATION

The instructor will confirm cadets' ability to identify the parts and characteristics of the cadet air rifle by asking questions during the end of lesson confirmation, and with the handout found at Annex A.

CLOSING STATEMENT

Knowing the parts and characteristics of the cadet air rifle is important in understanding how the rifle works. This allows the cadet to be able to follow directions given on the range, and properly perform a handling test whenever an air rifle is to be used.

INSTRUCTOR NOTES/REMARKS

Emphasis must be placed on the safety aspect of this lesson.

REFERENCES

A0-027 A-CR-CCP-177/PT-001 D Cdts 3. (2001). *Canadian Cadet Movement: Cadet Marksmanship Programme Reference Manual*. Ottawa, ON: Department of National Defence.

PARTS AND CHARACTERISTICS OF THE CADET AIR RIFLE

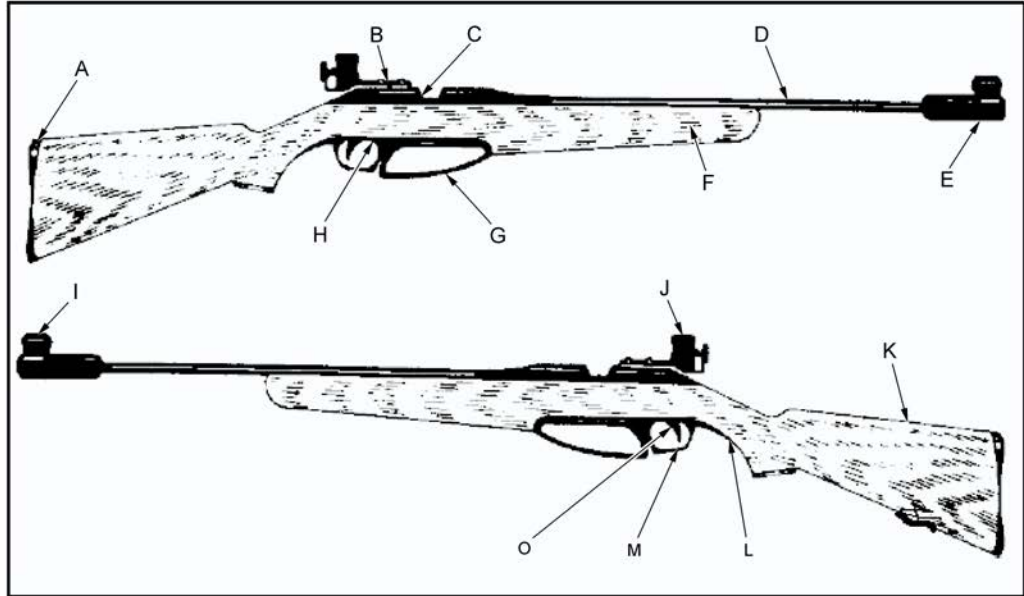

Put the letter next to the matching name of the part of the cadet air rifle.

- | | | | |
|----------------------|-------|-------------------|-------|
| 1. Feed Track | _____ | 8. Safety Catch | _____ |
| 2. Small of the Butt | _____ | 9. Muzzle | _____ |
| 3. Barrel | _____ | 10. Pump Lever | _____ |
| 4. Fore End | _____ | 11. Front Sight | _____ |
| 5. Rear Sight | _____ | 12. Trigger Guard | _____ |
| 6. Trigger | _____ | 13. Butt Plate | _____ |
| 7. Bolt | _____ | 14. Stock | _____ |

A-CR-CCP-601/PF-001
 Chapter 6, Annex A

ANSWER KEY

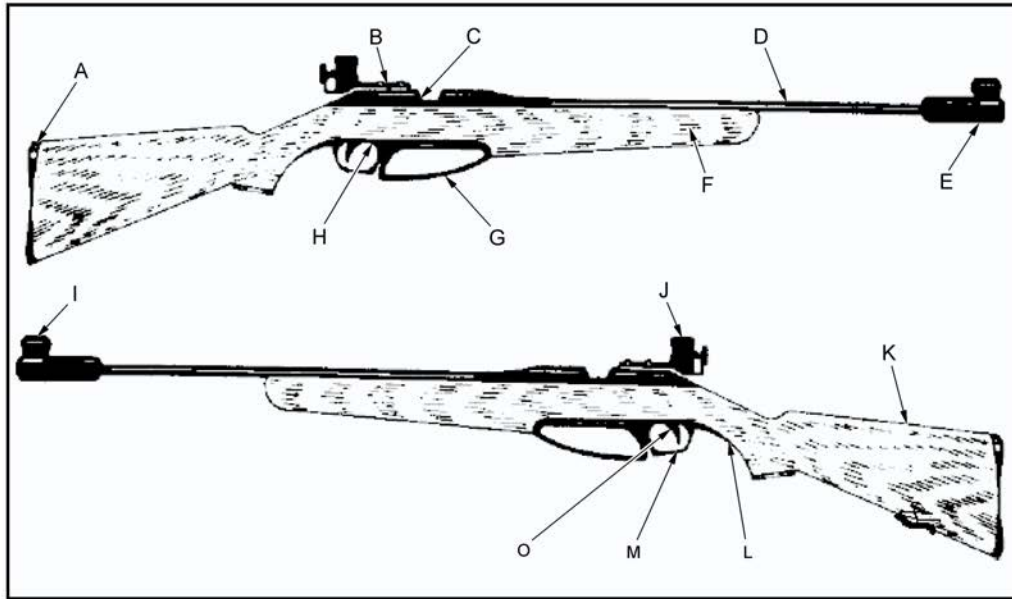

Put the letter next to the matching name of the part of the cadet air rifle.

- | | | | |
|----------------------|------------------------------|-------------------|------------------------------|
| 1. Feed Track | <u> C </u> | 8. Safety Catch | <u> H </u> |
| 2. Small of the Butt | <u> L </u> | 9. Muzzle | <u> E </u> |
| 3. Barrel | <u> D </u> | 10. Pump Lever | <u> G </u> |
| 4. Fore End | <u> F </u> | 11. Front Sight | <u> I </u> |
| 5. Rear Sight | <u> J </u> | 12. Trigger Guard | <u> M </u> |
| 6. Trigger | <u> O </u> | 13. Butt Plate | <u> A </u> |
| 7. Bolt | <u> B </u> | 14. Stock | <u> K </u> |

MODIFIED LESSON SPECIFICATIONS AND INSTRUCTIONAL GUIDES – TP 4 OF EO M106.03

A-CR-CCP-601/PG-001

EO M106.03 – APPLY BASIC MARKSMANSHIP TECHNIQUES

1. **Performance.** Apply Basic Marksmanship Techniques.
2. **Conditions**
 - a. Given:
 - (1) cadet air rifle;
 - (2) single pellet adaptor;
 - (3) assistance as required; and
 - (4) supervision.
 - b. Denied: N/A.
 - c. Environmental: Suitable classroom facility and/or air rifle range constructed IAW A-CR-CCP-177/PT-001, Chapter 1, sect 8.
3. **Standard.** In accordance with A-CR-CCP-177/PT-001, the cadet shall apply basic marksmanship techniques, to include:
 - a. loading;
 - b. unloading; and
 - c. preparing for inspection.
4. **Teaching Points**

TP	Description	Method	Time	Ref
TP4	<p>Explain, demonstrate, and have the cadets load, unload, and prepare for inspection the cadet air rifle, as follows:</p> <ol style="list-style-type: none"> a. loading the cadet air rifle, to include: <ol style="list-style-type: none"> (1) picking up the rifle with the left hand; (2) ensuring safety catch is in the ON position; (3) pumping the air rifle, pausing for three seconds; (4) bringing pump handle back to closed position; (5) loading a pellet; and b. unloading the cadet air rifle, to include: <ol style="list-style-type: none"> (1) opening the bolt (do not insert a pellet); (2) pumping the air rifle, pausing for three seconds; (3) closing the bolt (do not insert a pellet); 	Demonstration and Performance	10 min	A0-027 (p. 2-16)

A-CR-CCP-601/PG-001

TP	Description	Method	Time	Ref
	(4) placing the safety catch in the OFF position; (5) aiming the rifle at the target; (6) squeezing the trigger; (7) placing the safety catch in the ON position; and c. preparing for inspection, to include: (1) opening the bolt; (2) opening the pump handle slightly; (3) placing the rifle on the shoulder, muzzle pointed down range; (4) waiting to be cleared by the RSO; and (5) laying the rifle down. Note: Cadets will be required to perform these skills during their air rifle handling test. The pellet guide shall be used for training, although cadets may be introduced to the five-round clip prior to actual firing.			

5. **Time**

- a. Introduction/Conclusion: 5 min
- b. Demonstration and Performance: 10 min
- c. Total: 15 min

6. **Substantiation.** The demonstration-performance method was chosen to allow cadets to participate in supervised exploration of practical instructional material. This method provides the instructor the opportunity to introduce the subject matter, demonstrate and explain procedures, and supervise the cadets while they imitate the skill. This method appeals to all learning styles.

7. **References.** A0-027 A-CR-CCP-177/PT-001 D Cdts 3. (2001). *Canadian Cadet Movement: Cadet Marksmanship Programme Reference Manual*. Ottawa, ON: Department of National Defence.

8. **Training Aids**

- a. Presentation aids (i.e. whiteboard/flipchart/OHP) appropriate for classroom/training area; and
- b. Cadet air rifle.

9. **Learning Aids.** Cadet air rifle.

10. **Test Details.** N/A.

11. **Remarks.** N/A.

A-CR-CCP-601/PF-001



COMMON TRAINING
PHASE ONE
INSTRUCTIONAL GUIDE



SECTION 3

EO M106.03 – APPLY BASIC MARKSMANSHIP TECHNIQUES

Total Time: 15 min

PREPARATION

PRE-LESSON INSTRUCTIONS

Resources needed for the delivery of this lesson are listed in the lesson specification located in Chapter 4 of the QSP. Specific uses for said resources are identified throughout the Instructional Guide, within the teaching point for which they are required.

Review the lesson content, and become familiar with the material prior to delivering the lesson.

PRE-LESSON ASSIGNMENT

N/A.

APPROACH

This lesson will be presented using the demonstration and performance method. The demonstration-performance method was chosen to allow cadets to participate in supervised exploration of practical instructional material. This method provides the instructor the opportunity to introduce the subject matter, demonstrate and explain procedures, and supervise the cadets while they imitate the skill. This method appeals to all learning styles.



This lesson may be better presented using a round robin format for those units with large first year groups.

INTRODUCTION

REVIEW

The pertinent review for this lesson, from EO M106.02 (Section 2), will include:

QUESTIONS

- Q1. Why are the individual safety precautions performed?
- Q2. What is the purpose of the "safety catch"?

A-CR-CCP-601/PF-001

ANTICIPATED ANSWERS

- A1. To confirm a rifle is safe.
A2. It prevents a rifle from firing by locking its trigger into place.

OBJECTIVES

By the end of this lesson the cadet shall be expected to apply basic marksmanship techniques to include:

- prone position;
- basic holding;
- basic aiming;
- loading;
- firing; and
- unloading.

Cadets will apply the knowledge gained during this lesson when they participate in any range practice.

IMPORTANCE

These techniques must all be applied in harmony. Improving one while not working on another will not produce the best results in the long run. Perfecting these techniques takes time and concentration. Cadets should remember – PRACTICE MAKES PERFECT!

Teaching Point 4

Explain and Demonstrate How To Load and Unload the Cadet Air Rifle

Time: 10 min

Method: Demonstration and Performance

LOADING THE AIR RIFLE



The instructor shall provide an EXPLANATION and DEMONSTRATION of the complete skill.

The instructor shall also provide an EXPLANATION and DEMONSTRATION of each step required to effectively complete the skill.

This will be conducted as a DRY FIRE EXERCISE ONLY.

Loading procedure:

1. Pick up the rifle with the left hand.
2. Ensure the safety catch is in the ON position.
3. Pump the air rifle, pausing for 3 seconds.
4. Bring the pump handle back to closed position.
5. Simulate loading a pellet, or load an auto indexing five-pellet clip into the feed track.

A-CR-CCP-601/PF-001

6. Close the bolt.



Cadets will IMITATE the demonstration provided by the instructor for each step within the skill. The instructor(s) will SUPERVISE the cadets during this imitation.



The following methods may be used when pumping the air rifle:

- **Option 1.** Grasp the pistol grip with the right hand. Grasp the pump handle with the left hand. Push downward with the left hand until the pump handle is fully extended. Wait for a few seconds. Using the left hand, bring the pump handle back to the stock of the rifle. The rifle should remain stationary during the pumping process and always point towards the targets.
- **Option 2.** Grasp the pistol grip with the right hand. Grasp the pump handle with the left hand. Place the butt of the rifle under the right arm or shoulder for support. Push downward with the left hand until the pump handle is fully extended. Wait for a few seconds. Using the left hand, bring the pump handle back to the stock of the rifle allowing the underarm and shoulder to help hold the rifle steady when closing the pump handle. Remember that the rifle must always point towards the targets.
- **Option 3 – Coach Assistance.** Point the rifle in a safe direction and request the assistance from a coach. The coach should move in and pump the rifle using both hands. This should be used as last resorts as any cadet can easily do the above two options.

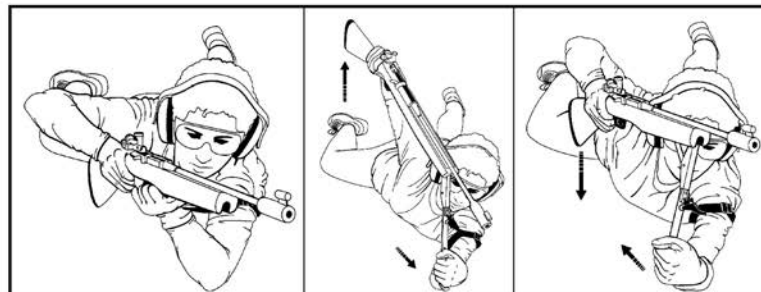

Cadet Marksmanship Program Reference Manual

Figure 6-3-7 Pumping the Air Rifle



Do not pump the rifle more than once per shot. This air rifle is designed to withstand the pressure based on a single pump stroke.



The instructor shall provide an EXPLANATION and DEMONSTRATION of the complete skill.

The instructor shall also provide an EXPLANATION and DEMONSTRATION of each step required to effectively complete the skill.

A-CR-CCP-601/PF-001

UNLOADING THE CADET AIR RIFLE

Follow the unloading sequence of the cadet air rifle, to include:

UNLOAD

1. Pick up the air rifle.
2. Remove five-pellet clip (if used).
3. Open the bolt (do not insert a pellet).
4. Pump the air rifle, pausing for 3 seconds.
5. Close the bolt (do not insert a pellet).
6. Place the safety catch in the OFF position.
7. Aim the rifle at the target.
8. Squeeze the trigger.
9. Place the safety catch in the ON position.

PREPARE FOR INSPECTION

1. Open the bolt.
2. Open the pump handle slightly.
3. Place the rifle on shoulder, muzzle pointed down range.
4. Wait to be cleared by the RSO.
5. Lay the rifle down.



Cadets will IMITATE the demonstration provided by the instructor for each step within the skill. The instructor(s) will SUPERVISE the cadets during this imitation.

CONFIRMATION OF TEACHING POINT 4



The instructor will divide the group into two, or by the number of air rifles available. The instructor shall have one group imitate the actions of the sequence as demonstrated, while the remainder observe. Have them trade places, and repeat.

END OF LESSON CONFIRMATION

The instructor will divide the group into two, or by the number of air rifles available. The instructor shall have one group imitate the actions of the sequence for all teaching points as demonstrated, while the remainder observe, and then have them trade places, and repeat.

A-CR-CCP-601/PF-001

CONCLUSION

HOMEWORK/READING/PRACTICE

N/A.

METHOD OF EVALUATION

N/A.

CLOSING STATEMENT

The first principle of marksmanship is to find a comfortable shooting position. A comfortable shooting position will enable cadets to shoot safely and with much better results. The prone position is the most stable shooting position to use.

INSTRUCTOR NOTES/REMARKS

1. Emphasis must be placed on the safety aspects of this lesson.
2. Ensure thorough confirmation by stages.

REFERENCES

A0-027 A-CR-CCP-177/PT-001 D Cdts 3. (2001). *Canadian Cadet Movement: Cadet Marksmanship Programme Reference Manual*. Ottawa, ON: Department of National Defence.

THIS PAGE INTENTIONALLY LEFT BLANK

MODIFIED LESSON SPECIFICATIONS AND INSTRUCTIONAL GUIDES – TP 1 OF EO M203.01

A-CR-CCP-602/PG-001

EO M203.01 – DISCUSS LEADERSHIP WITHIN A PEER SETTING

1. **Performance.** Discuss Leadership Within a Peer Setting.
2. **Conditions**
 - a. Given:
 - (1) supervision; and
 - (2) assistance as required.
 - b. Denied: N/A.
 - c. Environmental: Suitable classroom facilities or training area large enough to accommodate the entire group.
3. **Standard.** The cadet shall discuss leadership within a peer setting.

4. **Teaching Points**

TP	Description	Method	Time	Ref
TP1	Explain leadership within a peer setting, to include: <ol style="list-style-type: none"> a. responsibilities of a Phase Two cadet, to include: <ol style="list-style-type: none"> (1) following the chain of command; (2) setting the example; (3) being firm, fair and friendly; (4) being respectful to superiors and subordinates; (5) being aware of safety hazards; (6) displaying initiative; and (7) setting goals; and b. corps specific Phase Two cadet responsibilities. 	Interactive Lecture	10 min	C0-134

5. **Time**
 - a. Introduction/Conclusion: 5 min
 - b. Interactive Lecture: 10 min
 - c. Total: 15 min
6. **Substantiation.** An interactive lecture was chosen for TP1 to orient the cadets to junior leadership, to generate interest and present basic material.
7. **References.** C0-134 (ISBN 0-7852-7440-5) Maxwell, J. (1999). *The 21 Indispensable Qualities of a Leader: Becoming the Person Others Will Want to Follow*. Nashville, TN: Thomas Nelson Publishers.
8. **Training Aids.** Presentation aids (e.g. whiteboard/flipchart/OHP) appropriate for the classroom/training area.
9. **Learning Aids.** N/A.

10. **Test Details.** N/A.
11. **Remarks.** The list of responsibilities in TP1 is not exhaustive. For each corps Phase Two cadet responsibilities may vary.

A-CR-CCP-602/PF-001



**COMMON TRAINING
PHASE TWO
INSTRUCTIONAL GUIDE**



SECTION 1

EO M203.01 – DISCUSS LEADERSHIP WITHIN A PEER SETTING

Total Time: 15 min

PREPARATION

PRE-LESSON INSTRUCTIONS

Resources needed for the delivery of this lesson are listed in the lesson specification located in A-CR-CCP-602/PG-001, Chapter 4. Specific uses for said resources are identified throughout the Instructional Guide within the TP for which they are required.

Review the lesson content and become familiar with the material prior to delivering the lesson.

The list of responsibilities of Phase Two cadets will vary for each corps. Information about the specific responsibilities should be available in the corps Standing Orders or by speaking to the corps Commanding Officer/Training Officer.

PRE-LESSON ASSIGNMENT

N/A.

APPROACH

An interactive lecture was chosen for TP1 to orient the cadets to leadership within a peer setting, to generate interest and to present basic material.

INTRODUCTION

REVIEW

N/A.

OBJECTIVES

By the end of this lesson the cadet shall be expected to discuss leadership within a peer setting.

IMPORTANCE

It is important for cadets to learn about leadership within a peer setting because there are responsibilities for second year cadets. Being aware of the responsibilities Phase Two cadets perform will assist them in setting achievable goals and adapting to their new role as leaders in the corps.

A-CR-CCP-602/PF-001

Teaching Point 1

Explain Leadership Within a Peer Setting

Time: 10 min

Method: Interactive Lecture

Within junior leadership, there are responsibilities for a Phase Two cadet at the corps. To make the second year of cadets a fun, challenging and dynamic experience, second year cadets should know their responsibilities.



Have cadets brainstorm a list of what they think the responsibilities of a Phase Two cadet are. As you teach each of the following points, try to match them to the cadet generated list.

There are some responsibilities common to every Phase Two cadet in the corps. They are:

- **Following the Chain of Command.** Following the chain of command ensures that all information that must be passed up and down the chain is delivered. Following the chain of command prevents gaps in the information flow.
- **Setting the Example.** A Phase Two cadet must set a personal example in dress and deportment. A good leader will never ask more of their followers and teammates than they are willing to give themselves.
- **Being Firm, Fair and Friendly with Everyone, Especially New Recruits.** No one is impressed with a Phase Two cadet who yells, least of all new cadets. A highly influential and respected Phase Two cadet is one who is consistent in their approach to people and each situation. Being approachable at all times should enable the cadet to fulfill all duties and responsibilities in an effective manner.
- **Being Respectful to Superiors and Subordinates.** Using a proper tone of voice, looking people in the eyes when they speak and standing up straight is a physical way to show respect. If the Phase Two cadet wishes to be treated with respect, they must display respect toward others.
- **Being Aware of Safety Hazards.**
- **Displaying Initiative.** Undertaking small matters, like cleaning up, before being told to do so is an example of using initiative. Superiors notice when small tasks are completed without any request to do so.
- **Setting Goals.** Every leader needs to set goals. Goals allow people the opportunity to turn ideas into results. A goal is a glimpse of the future. Setting goals like improving their drill, dress and deportment, gives Phase Two cadets something to strive for. By setting goals, and working towards them, a Phase Two cadet will show commitment.



If the corps has no specific duties for Phase Two cadets, do not teach the following point.

There are specific responsibilities of a Phase Two cadet in this corps.



Explain the corps specific Phase Two cadet responsibilities.

A-CR-CCP-602/PF-001

CONFIRMATION OF TEACHING POINT 1

QUESTIONS

- Q1. List the responsibilities of Phase Two cadets in the corps.
- Q2. Why is setting goals important for a Phase Two cadet?
- Q3. List the specific Phase Two cadet duties and responsibilities for your corps.

ANTICIPATED ANSWERS

- A1. The responsibilities of every Phase Two cadet in the corps are:
- following the chain of command;
 - setting the example;
 - being firm, fair and friendly with everyone, especially new recruits;
 - being respectful towards your superiors and subordinates;
 - being aware of safety hazards;
 - displaying initiative; and
 - setting goals.
- A2. By setting goals and working towards them, the Phase Two cadet will show commitment.
- A3. Answers will vary.

END OF LESSON CONFIRMATION

The cadets' participation in TP1 will serve as the confirmation of this lesson.

CONCLUSION

HOMEWORK/READING/PRACTICE

N/A.

METHOD OF EVALUATION

N/A.

CLOSING STATEMENT

In order for a cadet to be successful in the role of a Phase Two, they must know their responsibilities. By setting personal short and long term goals, cadets have something to work toward and may be more motivated to complete the tasks ahead.

INSTRUCTOR NOTES/REMARKS

N/A.

A-CR-CCP-602/PF-001

REFERENCES

C0-134 (ISBN 0-7852-7440-5) Maxwell, J. (1999). *The 21 Indispensable Qualities of a Leader: Becoming the Person Others Will Want to Follow*. Nashville, TN: Thomas Nelson Publishers.

MODIFIED LESSON SPECIFICATIONS AND INSTRUCTIONAL GUIDES – TP 1 OF EO M121.01

A-CR-CCP-601/PG-001

EO M121.01 – TIE KNOTS, BENDS AND HITCHES

1. **Performance.** Tie Knots, Bends and Hitches.
2. **Conditions**
 - a. Given:
 - (1) one metre of line;
 - (2) spar/horizontal pole;
 - (3) supervision; and
 - (4) assistance as required.
 - b. Denied: N/A.
 - c. Environmental: Suitable classroom facilities/training area large enough to accommodate entire group and ropework.
3. **Standard.** In accordance with specified references, the cadet shall describe the use of and tie knots, bends and hitches to include the following:
 - a. reef knot;
 - b. figure of eight;

4. **Teaching Points**

TP	Description	Method	Time	Ref
TP1	Demonstrate and have the cadets practice tying the following knots: a. reef knot – a knot used to tie the two ends of a binding together around an object; and b. figure eight – a stopper knot, used to tie off the end of a line (e.g. to prevent a rope from pulling through a block or fairlead).	Demonstration and Performance	10 min	C1-002 (pp. 45, 98, 104, 112, 130, 132 and 162)

5. **Time**
 - a. Introduction/Conclusion: 5 min
 - b. Demonstration and Performance: 10 min
 - c. Total: 15 min
6. **Substantiation.** The demonstration and performance methods were chosen due to the practical nature of the subject matter. These methods provide the instructor the opportunity to introduce the subject matter, demonstrate procedures and observe the cadets practicing and performing the skill. The demonstration and performance methods must always be used when the taxonomic level of the material requires a performance of a skill. These methods are highly developmentally appropriate for young cadets.
7. **References.** C1-002 (ISBN 0-7858-1446-9) Pawson, D. (2001). *Pocket Guide to Knots and Splices*. Edison, NJ: Charwell Books, Inc.

8. **Training Aids**
 - a. A completed reef knot;
 - b. A completed figure eight knot; and
 - c. Line.
9. **Learning Aids.** Line.
10. **Test Details.** N/A.
11. **Remarks.** N/A.



ROYAL CANADIAN SEA CADETS

PHASE ONE

INSTRUCTIONAL GUIDE



SECTION 1

EO M121.01 – TIE KNOTS, BENDS AND HITCHES

Total Time: 15 min

PREPARATION

PRE-LESSON INSTRUCTIONS

A complete list of resources needed for the instruction of this EO is located at Chapter 4 of the QSP. Specific uses for said stores are identified throughout the Instructional Guide, within the teaching point for which they are required.

The instructor shall review the lesson content, and become familiar with the material prior to instruction of this lesson.

PRE-LESSON ASSIGNMENT

N/A.

APPROACH

The demonstration and performance method was chosen due to the practical nature of the subject matter. This method provides the instructor the opportunity to introduce the subject matter, demonstrate procedures and observe the cadets practicing and performing the skill. The demonstration and performance method must always be used when the taxonomic level of the material requires a performance of a skill. This method is highly developmentally appropriate for young cadets.

INTRODUCTION

REVIEW

N/A.

OBJECTIVES

By the end of this lesson the cadet shall be expected to tie and know where to use the following knots, bends and hitches:

- reef knot; and
- figure eight.

IMPORTANCE

Knowledge of the effective use of different knots, bends and hitches is one of the foundations of the sea cadet program and will be used in a variety of future training and activities such as rigging sailboats and lifting devices.

A-CR-CCP-601/PF-001

Teaching Point 1

Explain the Use of, Demonstrate and Have the Cadets Practice Tying a Reef Knot and the Figure of Eight

Time: 10 min

Method: Interactive Lecture/Demonstration and Performance



The following are some suggestions to make the class more enjoyable for the cadets:

- Use different coloured line to teach the knots.
- Have licorice for the cadets to tie their knots with. Once the knots are completed correctly, the cadets can eat the licorice.
- It may be useful to put the accompanying diagrams on overheads for the cadets to refer to.
- Instructors should make every effort to demonstrate all knots in a realistic way; try using simulated sail corners, or use spars and posts to tie bowlines and hitches to.
- Have senior cadets circulate through the class to check the cadets' progress.

DEFINITION OF KNOTS

A knot is something tied at the end of a line, or using a line itself. It is the term often applied to anything that is not a bend, splice or hitch.

REEF KNOT

The reef knot is commonly used to tie two lines of equal diameter together, or it can be used to tie off the two ends of a line around an object (e.g. parcels, or sails). It got its name from being the knot used to tie up or reduce the reefs or panels of sails.



An easy way to remember how to tie a reef knot is that the ends must be crossed in opposite directions each time they are knotted (e.g. right over left then left over right, or vice versa).

The knot is made using the following method:

1. Put the left-hand working end of the line on top of the right-hand working end.
2. Bring the left-hand working end of the line under the right-hand working end.
3. Put the working end that is now on the right on top of the working end that is now on the left.
4. Bring the working end that is on top over and then under the other working end so that the working end in your left hand comes out of the same space through which it entered the knot.

A-CR-CCP-601/PF-001

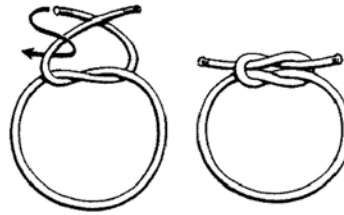

CFCD 105 Seamanship Rigging and Procedures Manual

Figure 10-1-1 Reef Knot

FIGURE OF EIGHT

The figure of eight is a stopper knot, used to tie off the end of a line. It is commonly used to prevent the ends of the sheets of sails from pulling through blocks, eyebolts or fairleads.

The knot is made using the following method:

1. Hold the standing end in one hand, and make a crossing turn with the working end passing under the standing part of the rope.
2. Bring the working end over the standing part.
3. Tuck the working end up through the loop from behind, forming a figure eight.
4. Pull tight on the working part.

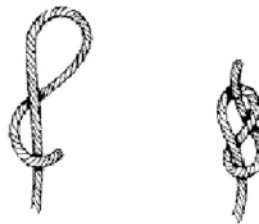

CIC Sea Environmental Training Instructor Guide 2005

Figure 10-1-2 Figure of Eight

CONFIRMATION OF TEACHING POINT 1

QUESTIONS

- Q1. If you are rigging a sailboat, what knot would you use to stop the line from running all the way through the fairleads?
- Q2. What is a reef knot commonly used for?

ANTICIPATED ANSWERS

- A1. A figure of eight knot.
- A2. To tie together two lines of equal diameter.

A-CR-CCP-601/PF-001

END OF LESSON CONFIRMATION

The cadets' ability to tie the reef knots and figure of eight knot will have been confirmed by the end of TP1.

CONCLUSION

HOMEWORK/READING/PRACTICE

The cadets should be encouraged to practice the knots, bends and hitches on their own time.

METHOD OF EVALUATION

There is no formal assessment of this EO. Ongoing monitoring will take place during subsequent classes on ropework and during training activities at the corps, with instructors providing direction/feedback as required.

CLOSING STATEMENT

These knots, bends and hitches will be used in a variety of cadet training activities so it is important that the cadets become proficient in these basic knots, bends and hitches.

INSTRUCTOR NOTES/REMARKS

N/A.



The following Websites provide excellent additional material or animation in ropework:

- www.realknots.com
- www.readyayeready.com
- www.grogono.com

REFERENCES

C1-002 (ISBN 0-7858-1446-9) Pawson, D. (2001). *Pocket Guide to Knots and Splices*. Edison, NJ: Charwell Books, Inc.

MODIFIED LESSON SPECIFICATIONS AND INSTRUCTIONAL GUIDES – TP 3 OF EO M121.01

A-CR-CCP-601/PG-001

EO M121.01 – TIE KNOTS, BENDS AND HITCHES

1. **Performance.** Tie Knots, Bends and Hitches.
2. **Conditions**
 - a. Given:
 - (1) one metre of line;
 - (2) spar/horizontal pole;
 - (3) supervision; and
 - (4) assistance as required.
 - b. Denied: N/A.
 - c. Environmental: Suitable classroom facilities/training area large enough to accommodate entire group and ropework.
3. **Standard.** In accordance with specified references, the cadet shall describe the use of and tie knots, bends and hitches to include the following:
 - a. reef knot;
 - b. figure of eight;

4. **Teaching Points**

TP	Description	Method	Time	Ref
TP3	Explain the use of, demonstrate and have the cadets practice the following hitches: <ol style="list-style-type: none"> a. clove hitch – used to temporarily secure a rope’s end to a post or spar; and b. round turn and two half hitches – used to secure a line (e.g., from a ship, to a spar, post or ring). 	Demonstration and Performance	10 min	C1-002 (pp. 45, 98, 104, 112, 130, 132 and 162)

5. **Time**
 - a. Introduction/Conclusion: 5 min
 - b. Demonstration and Performance: 10 min
 - c. Total: 15 min
6. **Substantiation.** The demonstration and performance methods were chosen due to the practical nature of the subject matter. These methods provide the instructor the opportunity to introduce the subject matter, demonstrate procedures and observe the cadets practicing and performing the skill. The demonstration and performance methods must always be used when the taxonomic level of the material requires a performance of a skill. These methods are highly developmentally appropriate for young cadets.
7. **References.** C1-002 (ISBN 0-7858-1446-9) Pawson, D. (2001). *Pocket Guide to Knots and Splices*. Edison, NJ: Charwell Books, Inc.

8. **Training Aids**

- a. A completed round turn and two half hitches;
- b. A completed clove hitch; and
- c. Line.

9. **Learning Aids.** Line.

10. **Test Details.** N/A.

11. **Remarks.** N/A.

A-CR-CCP-601/PF-001



ROYAL CANADIAN SEA CADETS

PHASE ONE

INSTRUCTIONAL GUIDE



SECTION 1

EO M121.01 – TIE KNOTS, BENDS AND HITCHES

Total Time: 15 min

PREPARATION

PRE-LESSON INSTRUCTIONS

A complete list of resources needed for the instruction of this EO is located at Chapter 4 of the QSP. Specific uses for said stores are identified throughout the Instructional Guide, within the teaching point for which they are required.

The instructor shall review the lesson content, and become familiar with the material prior to instruction of this lesson.

PRE-LESSON ASSIGNMENT

N/A.

APPROACH

The demonstration and performance method was chosen due to the practical nature of the subject matter. This method provides the instructor the opportunity to introduce the subject matter, demonstrate procedures and observe the cadets practicing and performing the skill. The demonstration and performance method must always be used when the taxonomic level of the material requires a performance of a skill. This method is highly developmentally appropriate for young cadets.

INTRODUCTION

REVIEW

N/A.

OBJECTIVES

By the end of this lesson the cadet shall be expected to tie and know where to use the following knots, bends and hitches:

- clove hitch; and
- round turn and two half hitches.

IMPORTANCE

Knowledge of the effective use of different knots, bends and hitches is one of the foundations of the sea cadet program and will be used in a variety of future training and activities such as rigging sailboats and lifting devices.

A-CR-CCP-601/PF-001

Teaching Point 3

Explain the Use of, Demonstrate and Have the Cadets Practice Tying the Clove Hitch and Two Half Hitches

Time: 10 min

Method: Interactive Lecture/Demonstration and Performance

DEFINITION OF HITCHES

A hitch is tied around or to something, such as a ring, spar or post. They are generally quick to tie and easy to untie.

CLOVE HITCH

The clove hitch can be used to secure a line temporarily to a post or spar, such as securing a small sailboat.

To make this hitch at the end of a line, use the following steps:

1. With the running end, make a turn around a spar.
2. To the left of the first turn, make another turn.
3. Pass the running end between the two turns, so that it comes up in the opposite direction from the standing part.

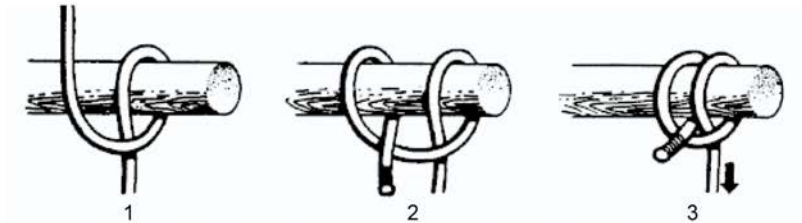

CFCD 105 Seamanship Rigging and Procedures Manual

Figure 10-1-5 Clove Hitch

ROUND TURN AND TWO HALF HITCHES

The round turn and two half hitches is another way to secure a sailboat to a post or ring. It will never jam and can be untied quickly. The hitches should always be made with the running end of the line going in one direction.

The knot is made using the following method:

1. Bring the working end of the line around the post or ring two turns, making a full round turn.
2. Take the working end around the standing end, and tuck it behind itself.
3. Bring the working end around the standing end again and tuck to make a second half hitch.
4. Pull tight to finish the knot.

A-CR-CCP-601/PF-001



CFC D 105 Seamanship Rigging and Procedures Manual
Figure 10-1-6 Round Turn and Two Half Hitches

CONFIRMATION OF TEACHING POINT 3

QUESTIONS

- Q1. What can you use a clove hitch for?
- Q2. Can you make the hitches for a round turn and two half hitches in opposite directions?

ANTICIPATED ANSWERS

- A1. You can use it to tie up a small sailboat.
- A2. No, they should be made in the same direction.

END OF LESSON CONFIRMATION

The cadets' ability to tie the clove hitch and round turn and two half hitches will have been confirmed by the end of TP3.

CONCLUSION

HOMEWORK/READING/PRACTICE

The cadets should be encouraged to practice the knots, bends and hitches on their own time.

METHOD OF EVALUATION

There is no formal assessment of this EO. Ongoing monitoring will take place during subsequent classes on ropework and during training activities at the corps, with instructors providing direction/feedback as required.

CLOSING STATEMENT

These knots, bends and hitches will be used in a variety of cadet training activities so it is important that the cadets become proficient in these basic knots, bends and hitches.

INSTRUCTOR NOTES/REMARKS

N/A.

A-CR-CCP-601/PF-001



The following Websites provide excellent additional material or animation in ropework:

- www.realknots.com
- www.readyayeready.com
- www.grogon.com

REFERENCES

- C1-002 (ISBN 0-7858-1446-9) Pawson, D. (2001). *Pocket Guide to Knots and Splices*. Edison, NJ: Charwell Books, Inc.

MODIFIED LESSON SPECIFICATIONS AND INSTRUCTIONAL GUIDES – TP 2 OF EO M121.03

A-CR-CCP-601/PG-001

EO M121.03 – COIL AND HEAVE A LINE

1. **Performance.** Coil and Heave a Line.
2. **Conditions**
 - a. Given:
 - (1) heaving line;
 - (2) supervision; and
 - (3) assistance as required.
 - b. Denied: N/A.
 - c. Environmental: Suitable classroom facilities/training area large enough to accommodate entire group and ropework.
3. **Standard.** In accordance with the *Admiralty Manual of Seamanship*, the cadet shall coil and heave a line, to include:
 - a. describing the characteristics of a heaving line;
 - b. tying a heaving knot on a heaving line; and
 - c. coiling and throwing a heaving line.

4. **Teaching Points**

TP	Description	Method	Time	Ref
TP2	Explain the importance of, demonstrate and have cadets practice coiling a line, to include: <ol style="list-style-type: none"> a. proper storage of line will ensure ease of use for the next person; and b. that it keeps a line from getting tangled. 	Demonstration and Performance	10 min	C1-003 (p. 119)

5. **Time**
 - a. Introduction/Conclusion: 5 min
 - b. Demonstration and Performance: 10 min
 - c. Total: 15 min
6. **Substantiation.** Demonstration and performance was chosen for this lesson due to the practical nature of the subject matter.
7. **References.** C1-003 (ISBN 11-770973-5). (1972). *Admiralty Manual of Seamanship. 1964 Volume 1.* London, England: Her Majesty's Stationery Office.
8. **Training Aids**
 - a. Presentation aids (i.e. whiteboard/flipchart/OHP) appropriate for classroom/training area; and
 - b. Line.
9. **Learning Aids.** Line.

10. **Test Details.** N/A.
11. **Remarks.** N/A.



ROYAL CANADIAN SEA CADETS

PHASE ONE

INSTRUCTIONAL GUIDE



SECTION 3

EO M121.03 – COIL AND HEAVE A LINE

Total Time: 15 min

PREPARATION

PRE-LESSON INSTRUCTIONS

A complete list of resources needed for the instruction of this EO is located at Chapter 4 of the QSP. Specific uses for said stores are identified throughout the Instructional Guide, within the teaching point for which they are required.

The instructor shall review the lesson content, and become familiar with the material prior to instruction of this lesson.

PRE-LESSON ASSIGNMENT

N/A.

APPROACH

The demonstration and performance method was chosen for TP3 due to the practical nature of the subject matter. This method provides the instructor the opportunity to introduce the subject matter, demonstrate procedures and observe the cadets practicing and performing the skill. The demonstration and performance method must always be used when the taxonomic level of the material requires a performance of a skill. This method is highly developmentally appropriate for young cadets.

INTRODUCTION

REVIEW

N/A.

OBJECTIVES

By the end of this lesson the cadet shall be expected to coil a line.

IMPORTANCE

Coiling a line is a traditional way of completing line-handling tasks in the navy, as well as being an important aspect of maintaining equipment in a good state of repair.

A-CR-CCP-601/PF-001

Teaching Point 2

Explain and Demonstrate the Method of Coiling a Line

Time: 10 min

Method: Interactive Lecture/Demonstration and Performance

IMPORTANCE OF COILING A LINE

Explain the importance of coiling a line, to include:

- Proper storage of the line will ensure ease of use for the next person.
- Increases the distance a line can be thrown.
- Allows a line to feed smoothly through a block.
- Allows a line to be tossed cleanly.
- It keeps a line from tangling.

Provide cadets with time to practice their coiling skills.

CONFIRMATION OF TEACHING POINT 2

SUGGESTED QUESTIONS

Q1. What is the importance of coiling a line?

ANTICIPATED ANSWERS

A1. Proper storage of the line will ensure ease of use for the next person, it keeps a line from tangling, increases the distance a line can be thrown, allows a line to be tossed cleanly, and allows a line to feed smoothly through a block.

END OF LESSON CONFIRMATION

The cadets' ability to coil a line will have been confirmed by the end of TP2.

CONCLUSION

HOMEWORK/READING/PRACTICE

The cadets should be encouraged to practice coiling a line on their own time.

METHOD OF EVALUATION

There is no formal assessment of this EO. Ongoing monitoring will take place during subsequent cadet training activities, with instructors providing direction/feedback as required.

CLOSING STATEMENT

Coiling a line will be used in a variety of cadet training activities so it is important that the cadets become proficient in these skills.

INSTRUCTOR NOTES/REMARKS

N/A.

A-CR-CCP-601/PF-001

REFERENCES

A1-004 B-GN-181-105/FP-E00 Maddison, G.R., Chief of Maritime Staff (1997). *CFCD 105 Fleet Seamanship Rigging and Procedures Manual*. Ottawa, ON.

THIS PAGE INTENTIONALLY LEFT BLANK

MODIFIED LESSON SPECIFICATIONS AND INSTRUCTIONAL GUIDES – TP 1 OF EO C120.03

A-CR-CCP-601/PG-001

EO C120.03 – EXPLORE CANADIAN NAVAL HISTORY

1. **Performance.** Explore Canadian Naval History.
2. **Conditions**
 - a. Given:
 - (1) supervision; and
 - (2) assistance as required.
 - b. Denied: N/A.
 - c. Environmental: Suitable classroom facilities/training area large enough to accommodate entire group.
3. **Standard.** The cadet shall participate in a discussion of Canadian naval history.

4. **Teaching Points**

TP	Description	Method	Time	Ref
TP1	Provide a brief introduction of the historical development of Canada's Navy, to include: <ol style="list-style-type: none"> a. creation of the Navy in 1910; b. development during World War One (WWI); c. activities between the wars; and d. growth during World War Two (WWII). 	Interactive Lecture	10 min	A1-011 (Retrieved 24 March 2006) A1-007 (pp. 8-22 to 8-64)

5. **Time**
 - a. Introduction/Conclusion: 5 min
 - b. Interactive Lecture: 10 min
 - c. Total: 15 min
6. **Substantiation.** The interactive lecture method was chosen as it allows the instructor to make a semi-formal presentation of the material where the cadets can participate by asking or responding to questions and commenting on the material.
7. **References**
 - a. A1-007 A-CR-CCP-004/PT-002 D Cds. (1983). *Royal Canadian Sea Cadets Manual Volume 2*. Ottawa, ON.
 - b. A1-011 Department of National Defence Canadian Forces. www.forces.gc.ca/site/Community/insignia/nava_e.asp.
8. **Training Aids**
 - a. Presentation aids (i.e. whiteboard/flipchart/OHP) appropriate for classroom/training area;
 - b. Handout consisting of historical information on the Canadian Navy, to include significant dates and events, development, personnel strength, types of ships, and ship strength; and
 - c. Handout briefly outlining the development of the Canadian Navy.

9. **Learning Aids**

- a. Handouts briefly outlining the development of the Canadian Navy.
- b. Handout consisting of historical information on the Canadian Navy, to include significant dates and events, development, personnel strength, types of ships, and ship strength.

10. **Test Details.** N/A.

11. **Remarks.** N/A.

A-CR-CCP-601/PF-001



ROYAL CANADIAN SEA CADETS

PHASE ONE

INSTRUCTIONAL GUIDE



SECTION 6

EO C120.03 – EXPLORE CANADIAN NAVAL HISTORY

Total Time: 15 min

PREPARATION

PRE-LESSON INSTRUCTIONS

A complete list of resources needed for the instruction of this EO is located at Chapter 4 of the QSP. Specific uses for said stores are identified throughout the Instructional Guide, within the teaching point for which they are required.

The instructor shall review the lesson content, and become familiar with the material prior to instruction of this lesson.

PRE-LESSON ASSIGNMENT

N/A.

APPROACH

The interactive lecture method was chosen as it allows the instructor to make a semi-formal presentation of the material where the cadets can participate by asking or responding to questions and commenting on the material. For this lesson, this method is most effective as it matches well the taxonomic level of the material and is age-appropriate by virtue of its participatory nature.

INTRODUCTION

REVIEW

N/A.

OBJECTIVES

By the end of this lesson the cadet shall be expected to be familiar with Canadian naval history.

IMPORTANCE

Exploring Canadian naval history will promote an awareness of the Canadian navy, which is one of the aims of the cadet program.

A-CR-CCP-601/PF-001

Teaching Point 1

Explore Canadian Naval History

Time: 10 min

Method: Interactive Lecture

CREATION OF CANADA'S NAVY

Until 1910, Canada did not have a naval service of its own; instead, it relied upon Britain's Royal Navy (RN) to look after the defence of Canadian shores. Even without its own navy, there were many naval engagements that took place on Canada's shores, including on the Great Lakes and the Atlantic and Pacific Coasts, between the British and the French and the British and the Americans.

The requirement for a strong naval force belonging to Canada became evident as the need to protect the country's shores increased and as the importance of trade on the seas increased.

Canada's navy, the Royal Canadian Navy (RCN), was formed May 4th, 1910; the first director of the navy was Canadian born Rear-Admiral Sir Charles E. Kingsmill.

WORLD WAR ONE (WWI)

After Germany ignored the British government's demand to observe Belgian neutrality and pull out of that country, the British Admiralty sent a war telegram, which said to "Commence hostilities against Germany", to ships and establishments under the White Ensign all over the world, including those in Canadian waters.

When war was declared in 1914, Canada did not have much of a navy, but the ships **Rainbow** and **Niobe** were put at the RN's disposal. Rainbow lasted until 1917 and did patrol work on the West Coast, while Niobe lasted only a year into the war before becoming unseaworthy, and then became a depot ship in Halifax. Although minor patrol boats and other vessels were on anti-submarine duty patrolling Canadian coastal waters, most of the resources Canada offered for WWI went into the army.

POST-WWI – CANADA, A SMALL SHIP NAVY

In 1921 a change of government dealt the RCN a severe blow; the whole world was tired of war, and navies were being cut back. The navy had acquired several vessels since its creation. Shortly after the war, however, the Canadian government that had been in power during WWI was defeated and the new one decided to do away with all ships but two destroyers.

The Royal Canadian Naval Volunteer Reserve (RCNVR) was established in 1923. The role of the RCNVR was similar to that of today's Naval Reserve.

WORLD WAR TWO (WWII)

Until 1939, Canada had mostly destroyers and trawlers. This was to simplify training as destroyers were the type of ship best suited to Canadian needs and defending our complicated coastline.

Canada began WWII with 13 vessels: six destroyers, four minesweepers, one auxiliary schooner, two smaller vessels, and approximately 1800 personnel. When the war ended, it had the third largest navy in the world, with over 600 vessels and over 90 000 members, including 6500 women who served in the Women's Royal Canadian Naval Services (WRNS).

It is interesting to note that Canada declared war on Germany shortly after Britain; the declaration was in large part due to the fact that so much of our export and import trade was moved by sea. The oceans of the world had to be in friendly hands or the commerce of Canada would come to a halt.

The RCN's contribution during WWII, and specifically during the Battle of the Atlantic, was nothing short of heroic. Winning this battle was of vital importance to the overall war effort in order to resupply the battlefields

A-CR-CCP-601/PF-001

with fuel, food, munitions or metal parts. The Battle of the Atlantic was a fight to the death against a highly trained enemy for supremacy of the Atlantic Ocean. It was the longest battle of WWII, and was fought for the entire war.

Protection and escort of the merchant ship convoys from German submarines, or "U-boat wolf packs", between North America and Europe and back was the RCN's chief responsibility. It employed tens of thousands of ships and hundreds of thousands of sailors. By mid-1942, the RCN, with support from the Royal Canadian Air Force (RCAF), was providing nearly half the convoy escorts, and after that, carried out the lion's share of escort duty.

During WWII the RCN lost over 2000 sailors and 32 ships, with more than 300 sailors wounded. Twenty-six thousand (26 000) merchant ship voyages, which provided 90 000 tons of war supplies a day to the battlefields of Europe, were made during the 2060 days of WWII.

CONFIRMATION OF TEACHING POINT 1

QUESTIONS

- Q1. When was the Royal Canadian navy formed?
- Q2. What happened to the Canadian navy between the two world wars?
- Q3. Describe what happened to convoys during the Battle of the Atlantic.

ANTICIPATED ANSWERS

- A1. 1910.
- A2. The number of ships was drastically cut, and then eventually began to increase again.
- A3. Various responses: U-boats attacked, sailors were lost, ships were lost, cargo was lost, etc.

CONCLUSION

HOMEWORK/READING/PRACTICE

N/A.

METHOD OF EVALUATION

There is no formal assessment of this EO.

CLOSING STATEMENT

Promoting an awareness of the Canadian navy is one of the aims of the cadet program, and knowledge of Canadian naval history will complement this.

INSTRUCTOR NOTES/REMARKS

N/A.

REFERENCES

- A1-007 A-CR-CCP-004/PT-002 D Cdts (1983). *Royal Canadian Sea Cadets Manual Volume 2*. Ottawa, ON.
- A1-011 Department of National Defence Canadian Forces. www.forces.gc.ca/site/Community/insignia/nava_e.asp.

THIS PAGE INTENTIONALLY LEFT BLANK

MODIFIED LESSON SPECIFICATIONS AND INSTRUCTIONAL GUIDES – TP 1 OF EO M220.03

A-CR-CCP-602/PG-001

EO M220.03 – RECOGNIZE NAVAL SHIP’S TRADITIONS

1. **Performance.** Recognize Naval Ship’s Traditions.
2. **Conditions**
 - a. Given:
 - (1) supervision; and
 - (2) assistance as required.
 - b. Denied: N/A.
 - c. Environmental: Suitable classroom facilities or training area large enough to accommodate the entire group.
3. **Standard.** In accordance with specified references, the cadet shall recognize naval ship’s traditions, to include:
 - a. ship’s commissioning;
 - b. naval toasts; and
 - c. naval customs.

4. **Teaching Points**

TP	Description	Method	Time	Ref
TP1	Explain how a naval vessel is brought into service with the Royal Canadian Navy (RCN), to include: <ol style="list-style-type: none"> a. keel laying; b. naming and launching; and c. commissioning. 	Interactive Lecture	10 min	A1-028 C1-053 (pp. 168 to 178)

5. **Time**
 - a. Introduction/Conclusion: 5 min
 - b. Interactive Lecture: 10 min
 - c. Total: 15 min
6. **Substantiation.** An interactive lecture was chosen for TPs 1-3 to present background information while allowing the cadets to become involved in ship’s traditions by asking and responding to questions.
7. **References**
 - a. A1-028 The Department of National Defence. (2006). *Hmcs Montreal-About the Ship*. Retrieved 29 March 2007, from http://navy.dnd.ca/Montreal/home/index_e.asp.
 - b. C1-053 (ISBN 0-88879-027-9) Russell, E.C. (1980). *Customs and Traditions of the Canadian Armed Forces*. Ottawa, ON: Deneau and Greenberg.
8. **Training Aids.** Presentation aids (e.g. whiteboard/flipchart/OHP) appropriate for the classroom/training area.

- 9. **Learning Aids.** N/A.
- 10. **Test Details.** N/A.
- 11. **Remarks.** N/A.



ROYAL CANADIAN SEA CADETS

PHASE TWO

INSTRUCTIONAL GUIDE



SECTION 3

EO M220.03 – RECOGNIZE NAVAL SHIP'S TRADITIONS

Total Time: 15 min

PREPARATION

PRE-LESSON INSTRUCTIONS

Resources needed for the delivery of this lesson are listed in the lesson specification located in A-CR-CCP-602/PG-001, Chapter 4. Specific uses for said resources are identified throughout the instructional guide within the TP for which they are required.

Review the lesson content and become familiar with the material prior to delivering the lesson.

Assign cadets roles as described in [Annex E](#). Photocopy the handout at [Annex E](#) for cadets in advance of the lesson.

Ensure that the training area is set up in accordance with [Annex F](#).

PRE-LESSON ASSIGNMENT

Cadets shall read [Annex E](#) to become familiar with their assigned roles prior to this lesson.

APPROACH

An interactive lecture was chosen for TP1 to TP3 to present background information while allowing the cadets to become involved in ship's traditions by asking and responding to questions.

INTRODUCTION

REVIEW

N/A.

OBJECTIVES

By the end of this lesson the cadet shall be expected to recognize the naval traditions associated with bringing a vessel into service, proposing toasts, and observing customs.

IMPORTANCE

It is important for cadets to learn about naval ship's traditions because they are interesting and informative. Recognizing traditions of the Canadian Navy can help cadets better value their membership in the Canadian Cadet Movement (CCM) by helping them develop a sense of belonging and pride.

A-CR-CCP-602/PF-001

Teaching Point 1

**Explain How a Naval Vessel Is Brought Into Service With the
Royal Canadian Navy (RCN)**

Time: 10 min

Method: Interactive Lecture

BRINGING A NAVAL VESSEL INTO SERVICE

There are three events which take place before a naval vessel can be brought into service.

Keel Laying

The first step in bringing a vessel into service is the keel laying, which originally consisted of laying a large wooden beam, the ship's backbone, on a building berth. Today's modern ship construction method involves erecting several modules or building blocks which are then welded together. The keel is considered laid when the first of the modules is in place on the building berth. At this point, the new ship is simply referred to as Hull # (dependent on the number of ships built by that shipyard).



*Department of National Defence. (2006). HMCS Montreal—About the Ship.
Retrieved 29 March 2007, from http://www.navy.dnd.ca/montreal/home/index_e.asp*

Figure 10-3-1 HMCS Montreal Forecastle Module

A-CR-CCP-602/PF-001



Department of National Defence. (2006). HMCS Montreal—About the Ship. Retrieved 29 March 2007, from http://www.navy.dnd.ca/montreal/home/index_e.asp

Figure 10-3-2 HMCS Montreal Bridge Module

Naming and Launching

The second event is the naming and launching ceremony. The naming and launching ceremony are religiously symbolic and, in fact, naming a ship was once referred to as a ship's christening. The blessing of the ship by the clergy is a prayer for guidance and protection of the ship and her crew. The breaking of a bottle of wine or champagne against the bow of the ship is similar to a baptism.

Since the beginning of the Canadian Navy in 1910, naval ships have been named for Canadian cities, towns, provinces, lakes, bays, rivers, and regions. The newest of Canadian ships, the Halifax Class Patrol Frigates, and the Kingston Class Maritime Coastal Defence Vessels (MCDV), have continued that tradition and are all named for cities in every province and territory.

The naming and launching ceremony includes:

- a short speech by the builder;
- the blessing of the ship by a member of the clergy;
- the traditional breaking of a bottle of wine or champagne on the ship's bow;
- the formal naming of the ship by a representative of the builder, who is almost always a woman, using the traditional words: "I name you Her/His Majesty's Canadian Ship (local town). Bless this ship and all who sail in her"; and
- the launching of the ship into the water.

Commissioning

The commissioning ceremony is the last of the three events that bring a naval vessel into service. The modern commissioning ceremony is based on the tradition whereby captains were commissioned by the sovereign to take over a specific ship, make it ready, and then carry out a particular expedition on behalf of the crown. It was the responsibility of the appointed captain to see to it that the ship was fit for sea in all respects and provided with a ship's company who may or may not have been volunteers.

A-CR-CCP-602/PF-001

Modern commissioning ceremonies usually take place inside the shipyard with the new ship secured alongside the jetty and includes:

- the ship's company fallen in on the jetty next to the ship;
- speeches by representatives of the builders, the Department of Supply and Service, and the Department of National Defence (DND);
- the signing of documents by the builder, government officials, senior officers of the Canadian Forces (CF), and the newly appointed ship's commanding officer;
- the symbolic presentation of the ship's keys to the commanding officer;
- a commissioning service conducted by the chaplain service of National Defence Headquarters (NDHQ);
- the hoisting of the naval ensign, Canadian flag, and the ship's pennant to the masthead;
- a speech by a guest of honour;
- an address by the commanding officer to the ship's company concluding with the order: "Man Her/His Majesty's Canadian Ship (name of ship)"; and
- piping the commanding officer aboard after the ship has been taken over by the officers and crew.
- After commissioning, the ship is ready to join the fleet.

CONFIRMATION OF TEACHING POINT 1

QUESTIONS

- Q1. What is the first step in bringing a vessel into service with the Canadian Navy?
- Q2. Since the beginning of the Canadian Navy in 1910, what have naval vessels been named after?
- Q3. What is the last step in commissioning a ship?

ANTICIPATED ANSWERS

- A1. The keel laying.
- A2. They have been named after cities and towns, provinces, lakes, bays, rivers, and regions.
- A3. After the ship's company has taken over the ship, the commanding officer is piped aboard.

END OF LESSON CONFIRMATION

The cadets' participation in TP1 will serve as the confirmation of this lesson.

CONCLUSION

HOMEWORK/READING/PRACTICE

N/A.

METHOD OF EVALUATION

N/A.

A-CR-CCP-602/PF-001

CLOSING STATEMENT

Recognizing naval ship's traditions is not just an interesting study of the way things used to be. Recognizing traditions can help us understand modern day customs and develop a sense of pride.

INSTRUCTOR NOTES/REMARKS

N/A.

REFERENCES

- A1-028 The Department of National Defence. (2006). *HMCS Montreal – About the Ship*. Retrieved 29 March 2007, from http://www.navy.dnd.ca/Montreal/home/index_e.asp.
- C1-053 (ISBN 0-88879-027-9) Russell, E.C. (1980). *Customs and Traditions of the Canadian Armed Forces*. Ottawa, ON: Deneau and Greenberg.

THIS PAGE INTENTIONALLY LEFT BLANK

MODIFIED LESSON SPECIFICATIONS AND INSTRUCTIONAL GUIDES – TP 3 OF EO M221.03

A-CR-CCP-602/PG-001

EO M221.03 – REEVE BLOCKS

1. **Performance.** Reeve Blocks.
2. **Conditions**
 - a. Given:
 - (1) line;
 - (2) single block;
 - (3) double block;
 - (4) supervision; and
 - (5) assistance as required.
 - b. Denied: N/A.
 - c. Environmental: Suitable classroom facilities or training area large enough to accommodate the entire group.
3. **Standard.** In accordance with specified references, the cadet shall reeve blocks, to include:
 - a. identifying the parts of a block; and
 - b. identifying the types of blocks.

4. **Teaching Points**

TP	Description	Method	Time	Ref
TP3	Demonstrate and have the cadets practice reeving a line through a block.	Demonstration and Performance	10 min	A1-004 (p. 5-94) C1-003 (p. 216)

5. **Time**
 - a. Introduction/Conclusion: 5 min
 - b. Demonstration and Performance: 10 min
 - c. Total: 15 min
6. **Substantiation.** Demonstration and performance was chosen for TP3 as it allows the instructor to explain and demonstrate reeving a rope through a block while providing an opportunity for the cadets to practice this skill under supervision.
7. **References**
 - a. A1-004 B-GN-181-105/FP-E00 Chief of the Maritime Staff. (1997). *CFCD 105 Fleet Seamanship Rigging and Procedures Manual*. Ottawa, ON: Department of National Defence.
 - b. C1-003 (ISBN 0-11770973-5) Royal Navy. (1972). *Admiralty Manual of Seamanship 1964 (Vol. 1)*. London, England: Her Majesty's Stationery Office.
8. **Training Aids**
 - a. Presentation aids (e.g. whiteboard/flipchart/OHP) appropriate for the classroom/training area.

- b. Line;
- c. Single block;
- d. Double block; and
- e. Cutting tool.

9. **Learning Aids**

- a. Line;
- b. Single block; and
- c. Double block.

10. **Test Details.** N/A.

11. **Remarks.** N/A.

A-CR-CCP-602/PF-001



ROYAL CANADIAN SEA CADETS

PHASE TWO

INSTRUCTIONAL GUIDE



SECTION 3

EO M221.03 – REEVE BLOCKS

Total Time: 15 min

PREPARATION

PRE-LESSON INSTRUCTIONS

Resources needed for the delivery of this lesson are listed in the lesson specification located in A-CR-CCP-602/PG-001, Chapter 4. Specific uses for said resources are identified throughout the Instructional Guide within the TP for which they are required.

Review the lesson content and become familiar with the material prior to delivering the lesson.

PRE-LESSON ASSIGNMENT

N/A.

APPROACH

Demonstration and performance was chosen for TP3 as it allows the instructor to explain and demonstrate reeving a rope through a block while providing an opportunity for the cadets to practice this skill under supervision.

INTRODUCTION

REVIEW

N/A.

OBJECTIVES

By the end of this lesson the cadet shall have reeved blocks.

IMPORTANCE

It is important for cadets to know how to reeve blocks as it is the first step in constructing pulley systems which will be introduced in future lessons. This skill will provide cadets with alternative options when lifting or moving heavy objects from one place to another.

A-CR-CCP-602/PF-001

Teaching Point 3

Demonstrate and Have the Cadets Practice Reeving a Line Through a Block

Time: 10 min

Method: Demonstration and Performance



Explain and demonstrate how to reeve a line through a block.

REEVING

Lines are reeved through the sheave of the block.

When reeving blocks the line should be checked for kinks and tangles. Coiling or faking out the line will help prevent this from occurring.

Take one end of the line and feed it through the sheave of the block. When the line has been reeved through the block a figure eight knot shall be tied in the end.

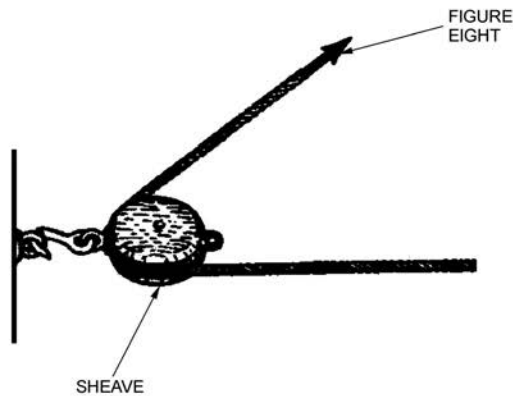

Royal Navy, Admiralty Manual of Seamanship 1964, Her Majesty's Stationery Office (p. 216)

Figure 11-3-4 Reeving a Block



Allow the cadets to practice reeving a single block. The block should be attached to a wall or object to prevent the block from moving while reeving.

CONFIRMATION OF TEACHING POINT 3

The cadet's participation in reeving blocks will serve as the confirmation of this TP.

A-CR-CCP-602/PF-001

END OF LESSON CONFIRMATION

The cadets' participation in the activity in TP3 will serve as the confirmation of this lesson.

CONCLUSION

HOMEWORK/READING/PRACTICE

N/A.

METHOD OF EVALUATION

N/A.

CLOSING STATEMENT

For a block to work efficiently the line must move freely; therefore lines should be free of kinks and tangles when reeving blocks. This skill will be applied in future rigging tasks.

INSTRUCTOR NOTES/REMARKS

N/A.

REFERENCES

A1-004 B-GN-181-105/FP-E00 Chief of Maritime Staff. (1997). *CFCD 105 Fleet Seamanship Rigging and Procedures Manual*. Ottawa, ON: Department of National Defence.

THIS PAGE INTENTIONALLY LEFT BLANK

MODIFIED LESSON SPECIFICATIONS AND INSTRUCTIONAL GUIDES – TP 2 OF EO M221.05

A-CR-CCP-602/PG-001

EO M221.05 – RIG TACKLES

1. **Performance.** Rig Tackles.

2. **Conditions**

a. Given:

- (1) twenty-six metres of line;
- (2) single blocks;
- (3) double blocks;
- (4) a load of 22 kg (50 pounds [lbs]) or less;
- (5) a strop;
- (6) supervision; and
- (7) assistance as required.

b. Denied: N/A.

c. Environmental: Suitable classroom facilities or training area large enough to accommodate the entire group.

3. **Standard.** In accordance with specified references, the cadet shall rig tackles, to include:

- a. a single whip;
- b. a double whip;
- c. a luff; and
- d. a two-fold purchase.

4. **Teaching Points**

TP	Description	Method	Time	Ref
TP2	Explain the use of, demonstrate, and have the cadets rig a double whip, to include: a. determining mechanical advantage; b. rigging to advantage; and c. rigging to disadvantage.	Demonstration and Performance	10 min	C1-047 (pp. 3-150 to 3-153)

5. **Time**

- a. Introduction/Conclusion: 5 min
- b. Demonstration and Performance: 10 min
- c. Total: 15 min

6. **Substantiation.** Demonstration and performance was chosen for TP2 as it allows the instructor to explain and demonstrate how to rig a double whip while providing an opportunity for the cadets to practice this skill under supervision.

A-CR-CCP-602/PG-001

7. **References.** C1-047 (ISBN 0-11-772695-8)/BON-050-002/PT-004 Command of the Defence Council. (1995). *BR 67 Admiralty Manual of Seamanship*. London, England: HMSO Publications Centre.
8. **Training Aids**
 - a. Line;
 - b. Single blocks;
 - c. Double blocks;
 - d. A load of 22 kg (50 lbs) or less; and
 - e. A cutting tool.
9. **Learning Aids**
 - a. Line;
 - b. Single blocks;
 - c. Double blocks;
 - d. A load of 22 kg (50 lbs) or less; and
 - e. A cutting tool.
10. **Test Details.** Cadets will rig tackles to lift a load of 22 kg (50 lbs) or less.
11. **Remarks.** If spring clip hooks are not available, the hook shall be moused prior to hoisting the load.



ROYAL CANADIAN SEA CADETS

PHASE TWO

INSTRUCTIONAL GUIDE



SECTION 5

EO M221.05 – RIG TACKLES

Total Time: 15 min

PREPARATION

PRE-LESSON INSTRUCTIONS

Resources needed for the delivery of this lesson are listed in the lesson specification located in A-CR-CCP-602/PG-001, Chapter 4. Specific uses for said resources are identified throughout the Instructional Guide within the TP for which they are required.

Review the lesson content and become familiar with the material prior to delivering the lesson.

PRE-LESSON ASSIGNMENT

N/A.

APPROACH

Demonstration and performance was chosen for TP2 as it allows the instructor to explain and demonstrate how to rig a double whip while providing an opportunity for the cadets to practice this skill under supervision.

INTRODUCTION

REVIEW

N/A.

OBJECTIVES

By the end of this lesson the cadet shall rig tackles.

IMPORTANCE

It is important for cadets to know how to rig tackles to be able to perform tasks that would be otherwise too difficult to complete. This knowledge will provide assistance when completing future ropework tasks.

A-CR-CCP-602/PF-001

Teaching Point 2

Explain the Use of, Demonstrate, and Have the Cadets Rig a Double Whip

Time: 10 min

Method: Demonstration and Performance



Explain and demonstrate how to rig a double whip.

DOUBLE WHIP

A double whip consists of two single blocks and is used for hoisting.

STEPS TO RIGGING

1. Lay two single blocks on their cheeks with the becket toward each other.
2. Label one block A and the other block B.
3. Starting with block A, secure the line to the becket with a bowline.
4. Reeve the other end of the line through the sheave of block B.
5. Reeve the line through the sheave of block A.
6. Finish rigging by tying a figure eight knot in the line's end.
7. Secure the standing block to a deckhead/post, etc.
8. Secure the load to block B.
9. Mouse all hooks.
10. Raise the load by hauling in on the hauling part.

A-CR-CCP-602/PF-001

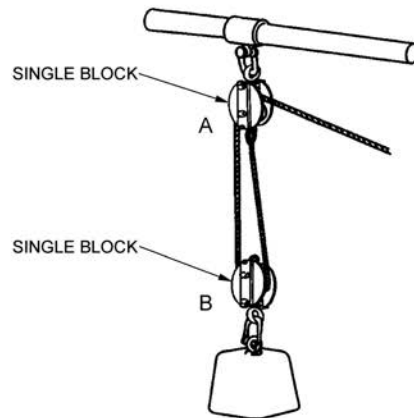

Command of Defence Council, BR 67 Admiralty Manual of Seamanship, Her Majesty's Stationery Office (p. 3-154)

Figure 11-5-2 Double Whip

MECHANICAL ADVANTAGE

The double whip provides a mechanical advantage of two or three depending on the number of lines coming from the moving block. In Figure 11-5-2 the MA equals two (rigged to disadvantage). If this tackle was reversed, it would result in three lines coming from the moving block, changing the MA to three (rigged to advantage).



Allow the cadets to practice rigging a double whip to both advantage and disadvantage.

CONFIRMATION OF TEACHING POINT 2

The cadets' rigging of a double whip will serve as the confirmation of this TP.

END OF LESSON CONFIRMATION

The cadets' rigging of a double whip will serve as the confirmation of this lesson.

CONCLUSION

HOMEWORK/READING/PRACTICE

N/A.

METHOD OF EVALUATION

N/A.

A-CR-CCP-602/PF-001

CLOSING STATEMENT

Rigging tackles free of twists and tangles will enable the line to move freely through the blocks ensuring the tackle works efficiently. The ability to rig tackles will provide the necessary assistance to perform tasks that require the movement of heavy loads, with little difficulty.

INSTRUCTOR NOTES/REMARKS

N/A.

REFERENCES

C1-047 (ISBN 0 11 772695 8) B-ON-050-002/PT-004 Command of the Defence Council. (1995). *BR 67 Admiralty Manual of Seamanship*. London, England: HMSO Publications Centre.

MODIFIED LESSON SPECIFICATIONS AND INSTRUCTIONAL GUIDES – TP 2 OF EO M223.02

A-CR-CCP-602/PG-001

EO M223.02 – IDENTIFY THE WATCH SYSTEM

1. **Performance.** Identify the Watch System.
2. **Conditions**
 - a. Given:
 - (1) supervision; and
 - (2) assistance as required.
 - b. Denied: N/A.
 - c. Environmental: Suitable classroom facilities or training area large enough to accommodate the entire group.
3. **Standard.** In accordance with specified references, the cadet shall identify the watch system, to include:
 - a. the organization of the watch system;
 - b. the duty personnel positions; and
 - c. the responsibilities of duty personnel.
4. **Teaching Points**

TP	Description	Method	Time	Ref
TP2	Describe the division of time for the watch system, to include: <ol style="list-style-type: none"> a. timings, to include: <ol style="list-style-type: none"> (1) middle watch (0000 hrs to 0400 hrs); (2) morning watch (0400 hrs to 0800 hrs); (3) forenoon watch (0800 hrs to 1200 hrs); (4) afternoon watch (1200 hrs to 1600 hrs); (5) first dog watch (1600 hrs to 1800 hrs); (6) last dog watch (1800 hrs to 2000 hrs); and (7) first watch (2000 hrs to 0000 hrs); and b. bells. 	Interactive Lecture	10 min	A1-024 (p. 7-2)

5. **Time**
 - a. Introduction/Conclusion: 5 min
 - b. Interactive Lecture: 10 min
 - c. Total: 15 min
6. **Substantiation.** An interactive lecture was chosen for this lesson to present basic material and orient the cadets to the watch system.

7. **References.** A1-024 Venture Naval Officer Training Centre. (2005). *Naval Environmental Training Programme - Officers Handbook*. Esquimalt, BC: Venture Naval Officer Training Centre.
8. **Training Aids.** Presentation aids (e.g. whiteboard/flipchart/OHP) appropriate for the classroom/training area.
9. **Learning Aids.** N/A.
10. **Test Details.** N/A.
11. **Remarks.** N/A.



ROYAL CANADIAN SEA CADETS

PHASE TWO

INSTRUCTIONAL GUIDE



SECTION 2

EO M223.02 – IDENTIFY THE WATCH SYSTEM

Total Time: 15 min

PREPARATION

PRE-LESSON INSTRUCTIONS

Resources needed for the delivery of this lesson are listed in the lesson specification located in A-CR-CCP-602/PG-001, Chapter 4. Specific uses for said resources are identified throughout the Instructional Guide within the TP for which they are required.

Review the lesson content and become familiar with the material prior to delivering the lesson.

PRE-LESSON ASSIGNMENT

N/A.

APPROACH

An interactive lecture was chosen for this lesson to present basic material and to orient the cadets to the watch system.

INTRODUCTION

REVIEW

N/A.

OBJECTIVES

By the end of this lesson the cadet shall be expected to identify the watch system.

IMPORTANCE

It is important for cadets to identify the watch system because it is used throughout Sea Cadet training and cadets may be required to stand watch during training exercises.

A-CR-CCP-602/PF-001

Teaching Point 2

Describe the Division of Time for the Watch System

Time: 10 min

Method: Interactive Lecture

TIMINGS FOR WATCHES

Each watch will be assigned a time that they will be on duty (e.g. port assigned the middle watch/blue assigned the morning watch), depending on the watch system being used. The timings for the watches are outlined in the table below.

Watch	Timings
Middle watch	0000hrs to 0400hrs
Morning watch	0400hrs to 0800hrs
Forenoon watch	0800hrs to 1200hrs
Afternoon watch	1200hrs to 1600hrs
First dog watch	1600hrs to 1800hrs
Last dog watch	1800hrs to 2000hrs
First watch	2000hrs to 0000hrs



The dog watches are only half the time of the others to create a seventh watch, ensuring that personnel do not stand the same watch every day.

BELLS AND WATCHES

Each watch begins and ends with eight bells being rung, with the exception of the first dog watch, which ends with four bells, and the last dog watch, which begins with four bells. The bell is rung every half hour increasing the number of rings consecutively from the start of the watch resulting with eight bells at the end of the watch (with the exception of the dog watches). For example the bells rung during the forenoon watch would be as follows:

- eight bells at 0800hrs,
- one bell at 0830hrs,
- two bells at 0900hrs,
- three bells at 0930hrs,
- four bells at 1000hrs,
- five bells at 1030hrs,
- six bells at 1100hrs,
- seven bells at 1130hrs, and
- eight bells at 1200hrs.

A-CR-CCP-602/PF-001



It is not common practice for bells to be used to indicate time aboard a ship today, as it was in the past. Currently the bell is only struck at colours, at anchor in fog/bad visibility, or to sound the general alarm in the event of an emergency.

CONFIRMATION OF TEACHING POINT 2

QUESTIONS

- Q1. What are the timings for the first watch?
Q2. Why are dog watches half the time of the other watches?
Q3. How many bells are rung at the end of the first dog/beginning of the last dog watch?

ANTICIPATED ANSWERS

- A1. 2000hrs to 0000hrs.
A2. To ensure that personnel are not standing the same watch every day.
A3. Four.

END OF LESSON CONFIRMATION

QUESTIONS

- Q1. What are the two watch systems called?

ANTICIPATED ANSWERS

- A1. Port and starboard, and red, white and blue.

CONCLUSION

HOMEWORK/READING/PRACTICE

N/A.

METHOD OF EVALUATION

N/A.

CLOSING STATEMENT

The watch system is used during many Sea Cadet activities (e.g. Sea Cadet Training Vessel activities [SCTV]). Cadets are responsible for numerous positions within the watch. This ensures the safety and 24-hour operation of cadet training activities. The watch system is an aspect of serving within a naval environment.

INSTRUCTOR NOTES/REMARKS

N/A.

A-CR-CCP-602/PF-001

REFERENCES

A1-024 Venture Naval Officer Training Centre. (2005). *Naval Environmental Training Programme – Officers Handbook*. Esquimalt, BC: Venture Naval Officer Training Centre.

MODIFIED LESSON SPECIFICATIONS AND INSTRUCTIONAL GUIDES – TP 1 OF EO M223.07

A-CR-CCP-602/PG-001

EO M223.07 – IDENTIFY THE PROCEDURE FOR BERTHING A SHIP

1. **Performance.** Identify the Procedure for Berthing a Ship.
2. **Conditions**
 - a. Given:
 - (1) line;
 - (2) supervision; and
 - (3) assistance as required.
 - b. Denied: N/A.
 - c. Environmental: Suitable classroom facilities or training area large enough to accommodate the entire group.
3. **Standard.** In accordance with specified references, the cadet shall identify the procedure for berthing a ship, to include:
 - a. berthing lines; and
 - b. line handling.
4. **Teaching Points**

TP	Description	Method	Time	Ref
TP1	Identify berthing lines, to include: <ol style="list-style-type: none"> a. the types of lines, and b. the locations of lines. 	Interactive Lecture	10 min	A1-004 (pp. 6-10 and 6-11)

5. **Time**
 - a. Introduction/Conclusion: 5 min
 - b. Interactive Lecture: 10 min
 - c. Total: 15 min
6. **Substantiation.** An interactive lecture was chosen for TP1 to introduce the cadets to berthing lines and to give an overview of the procedure for berthing and slipping a ship.
7. **References**
 - a. A1-004 B-GN-181-105/FP-E00 Chief of the Maritime Staff. (1997). *CFCD 105 Fleet Seamanship Rigging and Procedures Manual*. Ottawa, ON: Department of National Defence.
 - b. C1-047 (ISBN 0-11-772695-8)/BON-050-002/PT-004 Command of the Defence Council. (1995). *BR 67 Admiralty Manual of Seamanship*. London, England: HMSO Publications Centre.
8. **Training Aids.** Presentation aids (e.g. whiteboard/flipchart/OHP) appropriate for the classroom/training area.

- 9. **Learning Aids.** N/A.
- 10. **Test Details.** N/A.
- 11. **Remarks.** N/A.



ROYAL CANADIAN SEA CADETS

PHASE TWO

INSTRUCTIONAL GUIDE



SECTION 7

EO M223.07 – IDENTIFY THE PROCEDURE FOR BERTHING A SHIP

Total Time: 15 min

PREPARATION

PRE-LESSON INSTRUCTIONS

Resources needed for the delivery of this lesson are listed in the lesson specification located in A-CR-CCP-602/PG-001, Chapter 4. Specific uses for said resources are identified throughout the Instructional Guide within the TP for which they are required.

Review the lesson content and become familiar with the material prior to delivering the lesson.

PRE-LESSON ASSIGNMENT

N/A.

APPROACH

An interactive lecture was chosen for TP1 to introduce the cadets to berthing lines and to give an overview of the procedure for berthing and slipping a ship.

INTRODUCTION

REVIEW

N/A.

OBJECTIVES

By the end of this lesson the cadet shall be expected to identify the procedure for berthing a ship.

IMPORTANCE

It is important for cadets to identify the procedure for berthing a ship because it will be used when training aboard Sea Cadet Training Vessels (SCTVs). A ship can slip easier from a berth when this procedure is followed and berthing lines are secured properly.

A-CR-CCP-602/PF-001

Teaching Point 1

Identify Berthing Lines

Time: 10 min

Method: Interactive Lecture



A ship is said to berth when it comes alongside a pier or jetty.

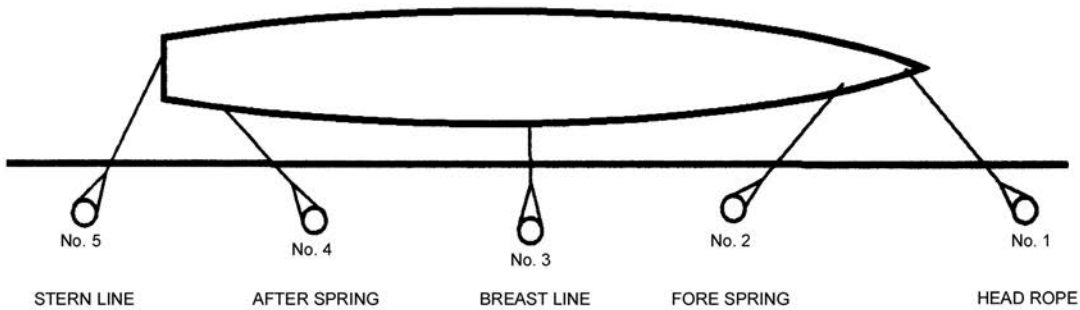

B-GN-181-105/FP-E00 (p. 6-11)

Figure 12-7-1 Berthing Lines

A ship's berthing arrangement depends on the size and characteristics of the ship. Each berthing line has a special name and purpose, which are as follows:

Breast Line. Line extending from midships that controls the lateral movement/distance that the ship lies from the jetty.

Head Rope. Line extending from the bow of the ship that is used to adjust the ship's position alongside a jetty.

Spring Line. Controls the fore and aft position of the ship. Any spring line that leads aft and prevents the ship from moving forward is called a head/fore spring. Any spring line that leads forward and prevents the ship from moving aft is called a back/after spring.

Stern Line. Line extending from the stern of the ship that is used to adjust the ship's position alongside a jetty.



Berthing lines are numbered consecutively, with number one being the head rope (as illustrated in [Figure 12-7-1](#)).

CONFIRMATION OF TEACHING POINT 1

QUESTIONS

- Q1. What does berthing mean?
- Q2. What is the purpose of the head rope?
- Q3. Which line controls the distance that the ship lies from the jetty?

A-CR-CCP-602/PF-001

ANTICIPATED ANSWERS

- A1. When a ship comes alongside a pier or jetty.
- A2. It is used to adjust the ship's position alongside a jetty.
- A3. The breast line.

END OF LESSON CONFIRMATION

The cadets' participation in the activity in TP1 will serve as the confirmation of this lesson.

CONCLUSION

HOMEWORK/READING/PRACTICE

N/A.

METHOD OF EVALUATION

N/A.

CLOSING STATEMENT

Berthing and slipping procedures used on a ship require teamwork among the crew. These procedures will be used when training aboard Sea Cadet Training Vessels (SCTVs).

INSTRUCTOR NOTES/REMARKS

N/A.

REFERENCES

- A1-004 B-GN-181-105/FP-E00 Chief of the Maritime Staff. (1997). *CFCD 105 Fleet Seamanship Rigging and Procedures Manual*. Ottawa, ON: Department of National Defence.
- C1-047 (ISBN 0 11 772695 8/B-ON-050-002/PT-004) Command of the Defence Council. (1995). *BR 76 Admiralty Manual of Seamanship*. London, England: HMSO Publications Centre.

THIS PAGE INTENTIONALLY LEFT BLANK

MODIFIED LESSON SPECIFICATIONS AND INSTRUCTIONAL GUIDES – TPS 1 AND 2 OF EO M224.02

A-CR-CCP-602/PG-001

EO M224.02 – PREPARE FOR SAIL TRAINING

1. **Performance.** Prepare for Sail Training.
2. **Conditions**
 - a. Given:
 - (1) fully equipped sailboat;
 - (2) helmets;
 - (3) PFD;
 - (4) supervision; and
 - (5) assistance as required.
 - b. Denied: N/A.
 - c. Environmental: Sail centre.
3. **Standard.** In accordance with the *CYA White Sail I Practical Skills Checklist*, the cadet shall:
 - a. select appropriate personal clothing based on the weather forecast for the sail training day (i.e. rainy, hot, or cold day);
 - b. select personal safety equipment, to include:
 - (1) a PFD;
 - (2) a helmet; and
 - (3) footwear.

4. **Teaching Points**

TP	Description	Method	Time	Ref
TP1	Explain how to protect oneself from sunburns and hypothermia, to include: <ol style="list-style-type: none"> a. wearing sunscreen; b. wearing a hat; c. identifying the signs of hypothermia; and d. treatment of hypothermia. 	Interactive Lecture	5 min	C1-007 (pp. 24 and 25) C0-027
TP2	Explain the general clothing to be worn during sailing activities, to include: <ol style="list-style-type: none"> a. a PFD (selecting and wearing); b. footwear; and c. a helmet. 	Interactive Lecture	5 min	C1-007 (pp. 24 and 25) A1-010 (chapter 1 Para 17) C0-027

5. **Time**

- | | | |
|----|--------------------------|--------|
| a. | Introduction/Conclusion: | 5 min |
| b. | Interactive Lecture: | 10 min |
| c. | Total: | 15 min |

6. **Substantiation.** An interactive lecture was chosen for TP1 and TP2 to present basic material and to orient the cadets to aspects of sail training required prior to participating in practical training.

7. **References**

- a. A1-010 A-CR-CCP-030/PT-001 D Cdts 4. (2005). *Water Safety Orders*. Ottawa, ON: Department of National Defence.
- b. C0-027 Canadian Red Cross. (1999-2006). *PFD Checklist*. Retrieved 2 October 2006, from <http://www.redcross.ca/article.asp?id=001039&tid=024>.
- c. C0-027 Canadian Red Cross. (1999-2006). *Lifejacket Comparison Chart*. Retrieved 8 November 2006, from <http://croixrouge.ca/article.asp?id=002542&tid=014>.
- d. C1-007 (ISBN 0-920232-17-5)/A-CR-CCP-009/PT-001 Donaldson, S. (1994). *Basic Sailing Skills*. Gloucester, ON: Canadian Yachting Association.
- e. C1-008 Canadian Yachting Association. (2006). *Canadian Yachting Association White Sail Level I Practical Skills Checklist*. Retrieved 3 April 2006, from www.sailing.ca/cbet/content/WIChecklist.doc.
- f. C1-009 Canadian Dermatology Association. (ND). *Facts About Sun Exposure: Prevention*. Retrieved 4 April 2006, from http://www.dermatology.ca/sun/facts_e.html.
- g. C1-098 Office of Boating Safety. (2006). *Safe Boating Guide*. Ottawa, ON: Her Majesty the Queen in Right of Canada, as represented by Transport Canada.

8. **Training Aids**

- a. Presentation aids (e.g. whiteboard/flipchart/OHP) appropriate for classroom/training area;
- b. PFD;
- c. Helmet; and
- d. *CYA White Sail I Practical Skills Checklist*.

9. **Learning Aids**

- a. PFD;
- b. Helmet;
- c. Paper; and
- d. Pens/pencils.

10. **Test Details.** Cadets will be assessed in accordance with the *CYA White Sail I Practical Skills Checklist* during the mandatory sail weekend.

11. **Remarks.** Instructors shall ensure cadets are properly dressed, according to the weather, prior to participating in this EO.



ROYAL CANADIAN SEA CADETS

PHASE TWO

INSTRUCTIONAL GUIDE



SECTION 2

EO M224.02 – PREPARE FOR SAIL TRAINING

Total Time: 15 min

PREPARATION

PRE-LESSON INSTRUCTIONS

Resources needed for the delivery of this lesson are listed in the lesson specification located in A-CR-CCP-602/PG-001, Chapter 4. Specific uses for said resources are identified throughout the Instructional Guide within the TP for which they are required.

Review the lesson content and become familiar with the material prior to delivering the lesson.

PRE-LESSON ASSIGNMENT

N/A.

APPROACH

An interactive lecture was chosen for TP1 and TP2 to present basic material and to orient the cadets to aspects of sail training required prior to participating in practical training.

INTRODUCTION

REVIEW

N/A.

OBJECTIVES

By the end of this lesson the cadet shall be expected to choose the appropriate personal clothing.

IMPORTANCE

It is important for cadets to wear the appropriate clothing, in order to be prepared for sailing activities.



The timings allocated in this EO are for instruction only.

Cadets will be provided additional training time during M224.04 (Sail a Sailboat) to complete the practical skills as required. For example, self-recovery is an evaluated skill in accordance with the *CYA White Sail I Practical Skills Checklist*, but the cadets will not be evaluated on this skill until M224.04 (Sail a Sailboat).

A-CR-CCP-602/PF-001

Teaching Point 1

Explain How to Protect Oneself from Sunburns and Hypothermia

Time: 5 min

Method: Interactive Lecture

IMPORTANCE OF PROTECTION FROM THE SUN

Sailing is an outdoor sport and therefore protection from the weather, especially the sun, is integral. Heat stroke, heat exhaustion, and sunburns are very common heat-related injuries that can occur when sailing in various types of weather.

According to the Canadian Dermatology Association, the following precautions should be observed to protect against sun exposure:

- Reduce sun exposure between 10:00 a.m. and 4:00 p.m..
- Seek shade or create shade.
- Wear clothing to cover arms and legs.
- Wear a wide brimmed hat.
- Always wear sunscreen with a minimum of sun protection factor (SPF) # 15 or higher with ultraviolet A (UVA) and ultraviolet B (UVB) protection.



Sailing will normally take place during the recommended time to limit sun exposure so the following precautions are a must. Due to harmful UV rays, sunscreen should be worn regardless of weather conditions.

HYPOTHERMIA

Hypothermia is the condition of having an abnormally low body temperature. This is caused by exposure to cold air temperature or cold water, both of which can occur when sailing.

Signs of Hypothermia

Some of the signs that can determine if someone is suffering from hypothermia are as follows:

- shivering;
- slowing down of motor skills;
- slowing down and falling behind;
- numb hands and feet;
- dazed, confused, careless or forgetful behaviour;
- slowed or slurred speech;
- dilated pupils; and
- decreased attention span.

A-CR-CCP-602/PF-001



Even on warm summer days, it is likely to be cool out on the water. You should always dress warmly, especially when the air temperature is below 21 degrees Celsius or the water is below 18 degrees Celsius. Generally, it is better to overdress as you can always remove layers if you get too warm.

Treatment of Hypothermia

If it is suspected that someone is suffering from hypothermia, the following treatments are recommended:

- get out of the water;
- get out of the wind;
- remove wet clothing; and
- begin controlled re-warming, by having the individual:
 - take a warm bath (not too hot);
 - drink a warm (not hot), non-alcoholic, drink;
 - warm-up by layering blankets; and
 - cuddle with another person, using body heat to slowly warm the core temperature.

CONFIRMATION OF TEACHING POINT 1

QUESTIONS

- Q1. What are some precautions that should be followed to protect oneself from sun exposure?
- Q2. What is hypothermia?
- Q3. What are some of the signs of hypothermia?

ANTICIPATED ANSWERS

- A1. The following precautions should be observed when protecting against sun exposure:
- Reduce sun exposure between 10:00 a.m. and 4:00 p.m..
 - Seek shade or create shade.
 - Wear clothing to cover arms and legs.
 - Wear a wide brimmed hat.
 - Always wear sunscreen with a minimum of sun protection factor (SPF) # 15 or higher with ultraviolet A (UVA) and ultraviolet B (UVB) protection.
- A2. Hypothermia is the condition of having an abnormally low body temperature.
- A3. Someone suffering from hypothermia may display the following signs:
- shivering;
 - slowing down of motor skills;
 - slowing down and falling behind;

A-CR-CCP-602/PF-001

- numb hands and feet;
- dazed, confused, careless or forgetful behaviour;
- slowed or slurred speech;
- dilated pupils; and
- decreased attention span.

Teaching Point 2

Explain the General Clothing to be Worn During Sailing Activities

Time: 5 min

Method: Interactive Lecture

SELECTING AND WEARING A PERSONAL FLOTATION DEVICE (PFD)

A flotation device is mandatory for all on-water activities. There are two types, lifejackets and PFDs.

Lifejackets are designed to keep a person's face out of the water by rolling them onto their back should they become unconscious. Lifejackets are larger, bulkier, more uncomfortable and can only be found in two sizes (90 lbs and above and 90 lbs and below).

PFDs are designed for sporting activities and therefore are smaller, more comfortable and allow for easier movement. PFDs can be found in a range of sizes (based on chest sizes for adults and body weight for children) and colours. They are recommended for all small vessel recreational activities.



All cadets will be provided with a DND-issued cadet PFD. No other PFD is to be worn.
PFDs must be worn over the outer layer of clothing.



For the policies on wearing of and caring for PFDs, refer to A-CR-CCP-030/PT-001, *Water Safety Orders*, Chapter 1, paragraphs 16–19 and paragraphs 22–24.

PFDs must meet the following requirements:

- **Suitable for the Weight and Size of the Person.** The recommended weight range for a PFD is stipulated on the inside tag.
- **Suitable for Activity.** The PFD should be comfortable for the activity taking place.
- **In Good Condition With no Tears or Rips.** PFDs are designed to work when they are in the best condition. Tears, rips, stains, etc. render the PFD useless. Ensure all zippers, straps, clips, etc. are intact and functioning properly.
- **Snug Fit.** The PFD should fit so as not to slip off in the water.
- **Fisheries and Oceans Canada – Canadian Coast Guard (CCG) or Transport Canada approved.** Approval will be identified on the inside tag of the PFD.

The Canadian Red Cross has produced a PFD checklist of questions to ask when selecting a PFD:

A-CR-CCP-602/PF-001

- Is it Canadian-approved?
- Will it support the cadet wearing it?
- Are all the snaps, belts, ties, tapes and/or zippers in good condition?
- Is it easy to put on and take off?
- Does it allow the cadet's arms to move freely when wearing it?
- Does it allow the cadet to bend at the waist?
- Can the cadet see the ground at their feet and walk over obstacles easily?
- Does it keep the cadet's head above water?
- Does it allow the cadet to swim and manoeuvre easily in the water?

FOOTWEAR

Shoes for sail training must be soft-soled to enable better traction on the surface of a sailboat and closed-toed to help prevent injuries to the cadets' feet (running shoes fit these criteria).



For the policy on footwear refer to A-CR-CCP-030/PT-001, Chapter 4, paragraph 20.

WEARING A HELMET

All cadets participating in on the water sail activities, who are qualified to the CYA White Sail II level and below, must wear a regionally approved helmet. A kayak type helmet is recommended. A helmet will also provide protection against the sun.



For the policy on wearing a helmet, refer to A-CR-CCP-030/PT-001, Chapter 4, paragraph 19.

CONFIRMATION OF TEACHING POINT 2

QUESTIONS

- Q1. What requirements must a PFD meet?
- Q2. What type of shoes shall be worn when sailing?
- Q3. What must you wear if you have a White Sail Level II or below qualification?

ANTICIPATED ANSWERS

- A1. PFDs must meet the following requirements:
- suitable for the weight and size of the person,
 - suitable for the activity,

A-CR-CCP-602/PF-001

- in good condition with no tears or rips,
- snug fit, and
- Fisheries and Oceans Canada–Canadian Coast Guard (CCG) or Transport Canada approved.

A2. Soft-soled shoes.

A3. A helmet.

END OF LESSON CONFIRMATION

QUESTIONS

Q1. What are some of the recommended treatments for hypothermia?

Q2. What are the main differences between a lifejacket and a PFD?

ANTICIPATED ANSWERS

A1. If it suspected that someone is suffering from hypothermia, the following treatments are recommended:

- get out of the water;
- get out of the wind;
- remove wet clothing; and
- begin controlled re-warming, by having the individual:
 - take a warm bath (not too hot);
 - drink a warm (not hot), non-alcoholic, drink;
 - warmed by layering blankets; and
 - cuddled by another person, using body heat to slowly warm the core temperature.

A2. Lifejackets are designed to keep a person's face out of the water by rolling them onto their back should they become unconscious. Lifejackets are larger, bulkier, more uncomfortable and can only be found in two sizes (90 lbs and above and 90 lbs and below).

PFDs are designed for sporting activities and therefore are smaller, more comfortable and they allow for easier movement. PFDs can be found in a range of sizes (based on chest sizes for adults and body weight for children) and colours.

CONCLUSION

HOMEWORK/READING/PRACTICE

N/A.

METHOD OF EVALUATION

N/A.

A-CR-CCP-602/PF-001

CLOSING STATEMENT

Safety is a number one concern while participating in aspects of cadet training. Being familiar with safety procedures and equipment will allow for more enjoyable sail training.

INSTRUCTOR NOTES/REMARKS

N/A.

REFERENCES

- A1-010 A-CR-CCP-030/PT-001 D Cdts 4. (2005). *Water Safety Orders*. Ottawa, ON: Department of National Defence.
- C0-027 Canadian Red Cross. (1999–2006). *PFD Checklist*. Retrieved 2 October 2006, from <http://www.redcross.ca/article.asp?id=001039&tid=024>.
- C0-027 Canadian Red Cross. (1999–2006). *Lifejacket Comparison Chart*. Retrieved 8 November 2006, from <http://croixrouge.ca/article.asp?id=002542&tid=014>.
- C1-007 (ISBN 0-920232-17-5)/A-CR-CCP-009/PT-001 Donaldson, S. (1994). *Basic Sailing Skills*. Gloucester, ON: Canadian Yachting Association.
- C1-008 Canadian Yachting Association. (2006). *Canadian Yachting Association White Sail Level I Practical Skills Checklist*. Retrieved 3 April 2006, from www.sailing.ca/cbet/content/WIChecklist.doc.
- C1-009 Canadian Dermatology Association. (ND). *Facts About Sun Exposure: Prevention*. Retrieved 4 April 2006, from http://www.dermatology.ca/sun/facts_e.html.
- C1-098 Office of Boating Safety. (2006). *Safe Boating Guide*. Ottawa, ON: Her Majesty the Queen in Right of Canada, as represented by Transport Canada.

THIS PAGE INTENTIONALLY LEFT BLANK

MODIFIED LESSON SPECIFICATIONS AND INSTRUCTIONAL GUIDES – TP 1 OF EO C207.01

A-CR-CCP-602/PG-001

EO C207.01 – IDENTIFY THE RANK STRUCTURE OF THE ROYAL CANADIAN ARMY AND AIR CADETS

1. **Performance.** Identify the Rank Structure of the Royal Canadian Army and Air Cadets.
2. **Conditions**
 - a. Given:
 - (1) supervision; and
 - (2) assistance as required.
 - b. Denied: N/A.
 - c. Environmental: Suitable classroom facilities or training area large enough to accommodate the entire group.
3. **Standard.** In accordance with specified references, the cadet shall identify the rank structure of:
 - a. the Royal Canadian Army Cadets; and
 - b. the Royal Canadian Air Cadets.
4. **Teaching Points**

TP	Description	Method	Time	Ref
TP1	Identify the Army and Air Cadet rank structure, to include: <ol style="list-style-type: none"> a. Private (Pte); b. Corporal (Cpl); c. Master Corporal (MCpl); d. Sergeant (Sgt); e. Warrant Officer (WO); f. Master Warrant Officer (MWO); g. Chief Warrant Officer (CWO); h. Air Cadet (AC); i. Leading Air Cadet (LAC); j. Corporal (Cpl); k. Flight Corporal (FCpl); l. Sergeant (Sgt); m. Flight Sergeant (FSgt); n. Warrant Officer Second Class (WO2); and o. Warrant Officer First Class (WO1). 	Interactive Lecture	10 min	A3-004 (pp. 1 to 9) A2-030 (pp. 1/5 to 5/5, A-1/1, and B-1/2)

A-CR-CCP-602/PG-001

5. **Time**

- | | | |
|----|--------------------------|--------|
| a. | Introduction/Conclusion: | 5 min |
| b. | Interactive Lecture: | 10 min |
| c. | Total: | 15 min |

6. **Substantiation.** An interactive lecture was chosen for this lesson to orient the cadets to the Army and Air Cadet rank structure, to generate interest, and to present basic material.

7. **References**

- a. A2-030 CATO 40-03 D Cdts 4. (2005). *Army Cadet Ranks and Cadet Corps*. Ottawa, ON: Department of National Defence.
- b. A3-004 CATO 51-02 D Cdts 4. (2007). *Air Promotions*. Ottawa, ON: Department of National Defence.

8. **Training Aids.** Presentation aids (e.g. whiteboard/flipchart/OHP) appropriate for the classroom/training area.

9. **Learning Aids.** N/A.

10. **Test Details.** N/A.

11. **Remarks.** N/A.



ROYAL CANADIAN SEA CADETS

PHASE TWO

INSTRUCTIONAL GUIDE



SECTION 5

**EO C207.01 – IDENTIFY THE RANK STRUCTURE OF
THE ROYAL CANADIAN ARMY AND AIR CADETS**

Total Time: 15 min

PREPARATION

PRE-LESSON INSTRUCTIONS

Resources needed for the delivery of this lesson are listed in the lesson specification located in A-CR-CCP-602/PG-001, Chapter 4. Specific uses for said resources are identified throughout the Instructional Guide within the TP for which they are required.

Review the lesson content and become familiar with the material prior to delivering the lesson.

Photocopy the handout of ranks located at [Annex G](#) for each cadet.

PRE-LESSON ASSIGNMENT

N/A.

APPROACH

An interactive lecture was chosen for TP1 to orient the cadets to the Army and Air Cadet rank structure, to generate interest, and to present basic material.

INTRODUCTION

REVIEW

N/A.

OBJECTIVES

By the end of this lesson the cadet shall be expected to identify the rank structure of the Royal Canadian Army and Air cadets.

IMPORTANCE

It is important for cadets to identify the rank structure of the Army and Air Cadets to better understand the structure of other elements. Knowing the rank structure and insignia will help cadets address other cadets and gain an appreciation for the differences and similarities between sea, Army and Air Cadets.

A-CR-CCP-602/PF-001

Teaching Point 1

Identify the Army and Air Cadet Rank Structure

Time: 10 min

Method: Interactive Lecture



Both Army and Air Cadet ranks have chevrons and crowns, just like Sea Cadets. Although, Sea Cadets have an anchor and Air Cadets have a propeller on some of their insignia.

Distribute handouts of the cadet rank insignia located at [Annex G](#) and briefly introduce the cadets to Army and Air Cadet ranks.

CADET RANK INSIGNIA

SEA CADET RANKS	ARMY CADET RANKS	AIR CADET RANKS
ORDINARY SEAMAN (OS) (NO BADGE)	CADET (NO BADGE)	AIR CADET (AC) (NO BADGE)
ABLE SEAMAN (AB) 	PRIVATE (Pte) 	LEADING AIR CADET (LAC) 
LEADING SEAMAN (LS) 	CORPORAL (Cpl) 	CORPORAL (Cpl) 
MASTER SEAMAN (MS) 	MASTER CORPORAL (MCpl) 	FLIGHT CORPORAL (FCpl) 
PETTY OFFICER SECOND CLASS (PO2) 	SERGEANT (Sgt) 	SERGEANT (Sgt) 
PETTY OFFICER FIRST CLASS (PO1) 	WARRANT OFFICER (WO) 	FLIGHT SERGEANT (FSgt) 
CHIEF PETTY OFFICER SECOND CLASS (CPO2) 	MASTER WARRANT OFFICER (MWO) 	WARRANT OFFICER SECOND CLASS (WO2) 
CHIEF PETTY OFFICER FIRST CLASS (CPO1) 	CHIEF WARRANT OFFICER (CWO) 	WARRANT OFFICER FIRST CLASS (WO1) 

D CdtS 3, 2007, Ottawa ON: Department of National Defence

Figure 7-5-1 Cadet Ranks

A-CR-CCP-602/PF-001

CONFIRMATION OF TEACHING POINT 1

QUESTIONS

- Q1. What does the rank insignia for a corporal look like?
- Q2. What rank has two chevrons and a maple leaf?
- Q3. What does the rank insignia for a warrant officer look like?
- Q4. What does the rank insignia for leading Air Cadet look like?
- Q5. What is the highest rank an Air Cadet can obtain?

ANTICIPATED ANSWERS

- A1. Two chevrons.
- A2. Master Corporal (MCpl).
- A3. A crown.
- A4. A propeller.
- A5. Warrant Officer First Class (WO1).

END OF LESSON CONFIRMATION

The cadets' participation in the activity in TP1 will serve as the confirmation of this lesson.

CONCLUSION

HOMEWORK/READING/PRACTICE

N/A.

METHOD OF EVALUATION

N/A.

CLOSING STATEMENT

Being able to identify the ranks of the Army and Air Cadets will make it easier to understand the ranks worn on their uniforms. Cadets may gain an appreciation for the differences and similarities between sea, Army and Air Cadets.

INSTRUCTOR NOTES/REMARKS

N/A.

REFERENCES

- A2-030 CATO 40-03 D Cdts 4. (2005). *Army Cadet Ranks and Cadet Corps*. Ottawa, ON: Department of National Defence.
- A3-004 CATO 51-02 D Cdts 4. (2007). *Air Promotions*. Ottawa, ON: Department of National Defence.

CADET RANK INSIGNIA

SEA CADET RANKS	ARMY CADET RANKS	AIR CADET RANKS
ORDINARY SEAMAN (OS) (NO BADGE)	CADET (NO BADGE)	AIR CADET (AC) (NO BADGE)
ABLE SEAMAN (AB) 	PRIVATE (Pte) 	LEADING AIR CADET (LAC) 
LEADING SEAMAN (LS) 	CORPORAL (Cpl) 	CORPORAL (Cpl) 
MASTER SEAMAN (MS) 	MASTER CORPORAL (MCpl) 	FLIGHT CORPORAL (FCpl) 
PETTY OFFICER SECOND CLASS (PO2) 	SERGEANT (Sgt) 	SERGEANT (Sgt) 
PETTY OFFICER FIRST CLASS (PO1) 	WARRANT OFFICER (WO) 	FLIGHT SERGEANT (FSgt) 
CHIEF PETTY OFFICER SECOND CLASS (CPO2) 	MASTER WARRANT OFFICER (MWO) 	WARRANT OFFICER SECOND CLASS (WO2) 
CHIEF PETTY OFFICER FIRST CLASS (CPO1) 	CHIEF WARRANT OFFICER (CWO) 	WARRANT OFFICER FIRST CLASS (WO1) 

THIS PAGE INTENTIONALLY LEFT BLANK

INSTRUCTIONAL TECHNIQUES ASSESSMENT FORM

Cadet's Name: _____

Division: _____

Lesson Topic: _____

Criteria	Comments	Incomplete	Completed With Difficulty	Completed Without Difficulty
PREPARATION				
Selected a lesson location.				
Set up the lesson location.				
Used a lesson plan.				
Selected an appropriate method(s) of instruction.				
Reviewed previous lesson material.				
INTRODUCTION				
Stated what the cadets will learn.				
Stated why it is important.				
Described where the knowledge/skill will be applied.				
BODY				
Applied the principles of instruction. (interest, comprehension, emphasis, participation, accomplishment and confirmation)				
Selected an appropriate instructional aid(s).				

Criteria	Comments	Incomplete	Completed With Difficulty	Completed Without Difficulty
END OF LESSON CONFIRMATION				
Used questions/activity to confirm knowledge or skills.				
CONCLUSION				
Summarized the lesson.				
Re-motivated the cadets.				
Described the next lesson.				
EFFECTIVE-SPEAKING TECHNIQUES				
Applied the elements of voice control. (pitch, tone, volume, speed, pause and articulation)				
Used appropriate body language.				
Maintaining appropriate dress and deportment.				
QUESTIONING TECHNIQUES				
Choose appropriate types of questions.				
Applied the questioning sequence. (pose, pause, pounce, ponder and praise)				
FEEDBACK				

 Assessor's Signature

 Date

 Cadet's Signature

LIST OF TOPICS

1. Your personal involvement within the cadet corps.
2. One fun event in which you took part at a Cadet Summer Training Centre.
3. One subject or topic area you would like to see added to/expanded on in the current training program.
4. One goal you have set or attained while in cadets.
5. Where you see yourself within the corps in the future.
6. One fun event in which you took part with the corps.
7. Your first night as a cadet.
8. Your first trip with the corps.
9. Your first visit to the sail centre.
10. Why you joined cadets.

THIS PAGE INTENTIONALLY LEFT BLANK

VERBAL PRESENTATION FEEDBACK FORM

Name: _____

Date: _____

Length: **1 min**

Start: _____

End: _____

Total: _____

Criteria	Comments	Yes	No
Introduction			
Body			
Conclusion			
Voice			
Body Language			
Dress & Deportment			
Presentation Aid(s)			
Comments:			
Strengths		Areas for Improvement	

 Instructor's Signature

 Cadet's Signature

THIS PAGE INTENTIONALLY LEFT BLANK

THE LESSON PLAN

The lesson plan is a way for the instructor to organize the lesson and summarize information included in the lesson specification, the IG and their personal ideas. Lesson plans provide a set of detailed directions for delivering one or more periods of instruction.

The lesson plan is arranged in this specific order:

Part	Purpose
1. Introduction	Builds the cadets' interest and motivation.
2. Body	Presents and explains each TP.
3. End of Lesson Confirmation	Confirms cadets' comprehension of the lesson.
4. Conclusion	Summarizes key points and identifies future lessons.

INTRODUCTION

The introduction is the instructor's first verbal interaction with the cadets. It should capture the cadets' interest. The following should be included in the introduction of a lesson plan:

- **What.** A description of what the cadets will be expected to accomplish at the end of the lesson.
- **Why.** A description of how and where the lesson fits into the Cadet Program.
- **Where.** A description of why it is important for the cadets to achieve the objectives.



Read the "Objective" and "Importance" paragraphs in the IG for help in writing the introduction of the lesson plan.

BODY

The body of the lesson plan is where the content is presented, explained and supported. Each TP directs the instructor and the cadets.

Each TP in the lesson includes:

- **Introduction.** Briefly introduce the content to be taught during the TP.
- **Teaching Method.** Identifies which teaching method has been chosen for the given TP.
- **Lesson Content.** Presents the lesson content in a clear and logical order, from easy to difficult or known to unknown.
- **Confirmation.** Confirmation of the TP may be oral questions, games, role-play or an in-class or practical activity. Instructional guides offer suggestions on how to confirm TPs. Instructors may choose to use those confirmation suggestions or develop their own.

END OF LESSON CONFIRMATION

The lesson plan should outline procedures to be used to confirm the learning of the TP. End of lesson confirmations are carried out to ensure that the cadets have understood the whole lesson and that any weaknesses in performance are identified so they may be corrected.

Confirmation activities are based on the lesson objectives. The end of lesson confirmation may be oral questions, games, role-play or an in-class or practical activity. IGs offer suggestions for how to conduct end of lesson confirmations. Instructors may choose to use those confirmation suggestions or develop their own.

CONCLUSION

The conclusion of a lesson allows the instructor to give a summary of key points and link them to the coming lessons and their practical use.

- **A Summary of Important Points and Any Weak Areas.** The summary reviews the main TPs. The depth of the summary will be determined by the lesson objectives and the results of the cadets' end of lesson confirmation/test. If the cadets achieved the objectives successfully, the summary may be brief. If they experienced some difficulties, the instructor should summarize them here and indicate how the issue will be addressed.
- **Re-Motivation Statement.** The re-motivation statement restates the importance of the lesson (the "why") and re-motivates the cadets. The instructor should also take this time to give an overview of the next lesson and any precautions the cadets should be aware of when using the knowledge they have gained in a practical setting.



Read the "Closing Statement" paragraph in the IG for help in writing the conclusion of the lesson plan.

PLAN A DRILL LESSON CHECKLIST

PREPARATION	NOTES
Have you: <input type="checkbox"/> Selected an appropriate squad location? <input type="checkbox"/> Written a lesson plan?	
INTRODUCTION	
Does your introduction: <input type="checkbox"/> Review previous lesson material? <input type="checkbox"/> State what the cadets will learn? <input type="checkbox"/> Describe why the movement is important to learn? <input type="checkbox"/> Describe where and when the movement can be used? <input type="checkbox"/> Describe how the cadets will be assessed?	
BODY	
Does the body of your lesson: <input type="checkbox"/> Demonstrate the complete movement with the instructor calling the time? <input type="checkbox"/> Explain the movement? <input type="checkbox"/> Demonstrate and explain the first part of the movement? <input type="checkbox"/> Provide time for the squad to ask questions? <input type="checkbox"/> Permit practice of the first part of the movement (collectively, individually, collectively)? <input type="checkbox"/> Teach the second and each subsequent movement following the sequence described above? <input type="checkbox"/> Permit practice of the complete movement with: <ul style="list-style-type: none"> <input type="checkbox"/> the instructor calling the time; <input type="checkbox"/> the cadets calling the time; and <input type="checkbox"/> the cadets judging the time? <input type="checkbox"/> Confirm each TP? <input type="checkbox"/> Include two complete demonstrations?	

END OF LESSON CONFIRMATION	NOTES
<input type="checkbox"/> Did you conduct an end of lesson confirmation?	
CONCLUSION	
Does your conclusion: <input type="checkbox"/> Restate the movement taught and where or when it will be used? <input type="checkbox"/> Re-motivate the cadets by: <input type="checkbox"/> comment on the cadets' progress; and <input type="checkbox"/> re-state why the drill movement just learned is important? <input type="checkbox"/> Describe the next lesson?	

LIST OF APPROVED 15-MINUTE DRILL TOPICS

Teach the movement of attention from stand at ease, and stand at ease from attention (M108.01 [Adopt the Positions of Attention, Stand at Ease and Stand Easy], A-CR-CCP-601/PG-001, Chapter 4, Section 8 and A-CR-CCP-601/PF-001, Chapter 8, Section 1).

Teach the movement of stand easy from stand at ease, and stand at ease from stand easy (M108.01 [Adopt the Positions of Attention, Stand at Ease and Stand Easy], A-CR-CCP-601/PG-001, Chapter 4, Section 8 and A-CR-CCP-601/PF-001, Chapter 8, Section 1).

Teach a salute to the front (M108.02 [Execute a Salute at the Halt Without Arms], A-CR-CCP-601/PG-001, Chapter 4, Section 8 and A-CR-CCP-601/PF-001, Chapter 8, Section 2).

Teach a salute to the right (left) (M108.02 [Execute a Salute at the Halt Without Arms], A-CR-CCP-601/PG-001, Chapter 4, Section 8 and A-CR-CCP-601/PF-001, Chapter 8, Section 2).

Teach the right turn at the halt (M108.03 [Execute Turns at the Halt], A-CR-CCP-601/PG-001, Chapter 4, Section 8 and A-CR-CCP-601/PF-001, Chapter 8, Section 3).

Teach the left turn at the halt (M108.03 [Execute Turns at the Halt], A-CR-CCP-601/PG-001, Chapter 4, Section 8 and A-CR-CCP-601/PF-001, Chapter 8, Section 3).

Teach the about turn at the halt (M108.03 [Execute Turns at the Halt], A-CR-CCP-601/PG-001, Chapter 4, Section 8 and A-CR-CCP-601/PF-001, Chapter 8, Section 3).

THIS PAGE INTENTIONALLY LEFT BLANK

**MODIFIED LESSON SPECIFICATIONS AND INSTRUCTIONAL GUIDES – EO M108.01
(MOVEMENT OF ATTENTION FROM STAND AT EASE, AND STAND AT EASE FROM ATTENTION)**

A-CR-CCP-601/PG-001

EO M108.01 – ADOPT THE POSITIONS OF ATTENTION, STAND AT EASE, AND STAND EASY

1. **Performance.** Adopt the Positions of Attention, Stand at Ease, and Stand Easy.
2. **Conditions**
 - a. Given:
 - (1) words of command;
 - (2) supervision; and
 - (3) assistance as required.
 - b. Denied: N/A.
 - c. Environmental: A drill, or outdoor parade square in favourable weather.
3. **Standard.** In accordance with A-PD-201-000/PT-000, the cadet shall perform the following individual drill movements:
 - a. attention from stand at ease; and
 - b. stand at ease from attention.

4. **Teaching Points**

TP	Description	Method	Time	Ref
TP1	Explain and demonstrate the movement of attention from stand at ease and allow cadets to practice.	Demonstration and Performance	5 min	A0-002 (pp. 2-2 to 2-8)
TP2	Explain and demonstrate the movement of stand at ease from attention and allow cadets to practice.	Demonstration and Performance	5 min	A0-002 (pp. 2-2 to 2-8)

5. **Time**
 - a. Introduction/Conclusion: 5 min
 - b. Demonstration and Performance: 10 min
 - c. Total: 15 min
6. **Substantiation.** The demonstration-performance method was chosen to allow cadets to participate in supervised exploration of practical instructional material. This method provides the instructor the opportunity to introduce the subject matter, demonstrate and explain procedures, and supervise the cadets while they imitate the skill. This method appeals to all learning styles.
7. **References.** A0-002 A-PD-201-000/PT-000 DHH 3-2. (2001). *The Canadian Forces Manual of Drill and Ceremonial*. Ottawa, ON: The Department of National Defence.
8. **Training Aids.** Assistant instructors as required.
9. **Learning Aids.** N/A.

A-CR-CCP-601/PG-001

10. **Test Details.** There is no formal assessment of this EO. Instructors will confirm the cadets' ability to perform the drill movement during the end of lesson check, and ongoing feedback will be provided during future drill practices, weekly parade nights, and ceremonial parades.
11. **Remarks.** N/A.

A-CR-CCP-601/PF-001



COMMON TRAINING
PHASE ONE
INSTRUCTIONAL GUIDE



SECTION 1

EO M108.01 – ADOPT THE POSITIONS OF ATTENTION, STAND AT EASE AND STAND EASY

Total Time: 15 min

PREPARATION

PRE-LESSON INSTRUCTIONS

A complete list of resources needed for the instruction of this EO is located at Chapter 4 of the QSP. Specific uses for said stores are identified throughout the Instructional Guide, within the teaching point for which they are required.

Prior to instructing this lesson the instructor shall:

- review the lesson content, and become familiar with the material; and
- select the most effective squad formation for the lesson being taught. A squad may be in a single rank, hollow square or semi-circle for elementary drill instruction. (Note: All cadets **must** be able to fully observe all demonstrations and explanations.)

PRE-LESSON ASSIGNMENT

N/A.

APPROACH

This lesson will be presented using the demonstration and performance method. The demonstration-performance method was chosen to allow cadets to participate in supervised exploration of practical instructional material. This method provides the instructor the opportunity to introduce the subject matter, demonstrate and explain procedures, and supervise the cadets while they imitate the skill. This method appeals to all learning styles.



The instructor shall develop and use a vocabulary of short, concise words to impress on the squad that the movements must be performed smartly. For example, the words “crack”, “drive”, “seize” and “grasp” suggest the degree of smartness required. Profanity or personal sarcasm shall never be used.

INTRODUCTION

REVIEW

N/A.

A-CR-CCP-601/PF-001

OBJECTIVES

By the end of this lesson the cadet shall be expected to adopt the positions of attention and stand at ease.

IMPORTANCE

As members of the Canadian Cadet Movement (CCM) cadets will be required to perform drill movements at a competent level, developing sharpness, esprit de corps, physical coordination, and alertness. These movements will be executed with ease and without hesitation. Ensuring that the cadets efficiently move together as one will promote discipline, alertness, precision, pride, steadiness, and cohesion. This develops the basis of teamwork that the CCM depends on.

Teaching Point 1

Adopting the Position of Attention From Stand at Ease

Time: 5 min

Method: Demonstration and Performance

DEMONSTRATE THE COMPLETE MOVEMENT WITH TIMING



Instructors are reminded that they are to present the example with regards to drill, from the moment they step onto the parade square. Proper drill movements, combined with a professional demeanour, are of paramount importance, and must be exemplified throughout the period of instruction.

The instructor shall provide a complete demonstration of the drill movement, with timing. A practiced assistant instructor may carry out this demonstration.

The demonstration shall be provided from various vantage points, as required.

DEMONSTRATE FIRST PART OF MOVEMENT (FIRST NUMBER)



For ease of instruction, drill commands have been broken down into individual movements, or numbers. The instructor(s) shall demonstrate and explain each number.

In order to adopt the position of attention from stand at ease, the cadet shall:

On the command ATTENTION BY NUMBERS, SQUAD – ONE, bend the left knee and shift the balance to the right foot.

PRACTICE THE SQUAD ON THE FIRST MOVEMENT

Practice the squad on the first movement collectively, individually and collectively.

DEMONSTRATE AND EXPLAIN THE SECOND PART OF THE MOVEMENT

On the command SQUAD – TWO:

1. straighten the left leg in double time, place the foot smartly on the ground, toe touching first, followed by the heel, and with heels aligned; and
2. simultaneously, with a quick motion, bring the arms and hands to the position of attention.

A-CR-CCP-601/PF-001

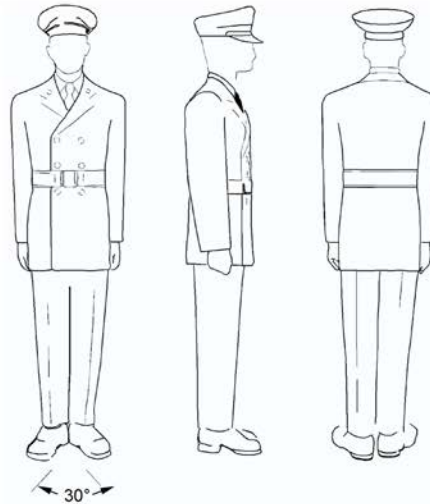

A-PD-201-000/PT-000, *The Canadian Forces Manual of Drill and Ceremonial, 2001*

Figure 8-1-1 The Position of Attention



A-PD-201-000/PT-000, *The Canadian Forces Manual of Drill and Ceremonial, 2001*

Figure 8-1-2 Fists at Position of Attention



Constant checking and correcting of all faults is essential. Faults shall be corrected immediately after they occur.

GIVE TWO COMPLETE AND FINAL DEMONSTRATIONS

On the command ATTEN – TION, combine the two movements. The timing is called as “one”.

The instructor(s) shall provide a full demonstration and allow time for practice.

CONFIRMATION OF TEACHING POINT 1

Cadets will adopt the position of attention as a squad.

A-CR-CCP-601/PF-001

Teaching Point 2

Adopting the Position of Stand at Ease From Attention

Time: 5 min

Method: Demonstration and Performance

DEMONSTRATE THE COMPLETE MOVEMENT WITH TIMING

The position of standing at ease is an intermediate position between attention and standing easy. It allows no relaxation, but can be maintained without strain for a longer time than the position of attention.

DEMONSTRATE FIRST PART OF MOVEMENT (FIRST NUMBER)



For ease of instruction, drill commands have been broken down into individual movements, or numbers. The instructor(s) shall demonstrate and explain each number.

On the command STAND AT EASE BY NUMBERS, SQUAD – ONE, the cadet shall bend the left knee.



A-PD-201-000/PT-000, The Canadian Forces Manual of Drill and Ceremonial, 2001

Figure 8-1-3 Squad One – Stand at Ease

PRACTICE THE SQUAD ON THE FIRST MOVEMENT

Practice the squad on the first movement collectively, individually and collectively.

DEMONSTRATE AND EXPLAIN THE SECOND PART OF THE MOVEMENT (SECOND NUMBER)

On the command SQUAD – TWO, the cadet shall:

1. carry the left foot to the left, straightening it in double time, and place it smartly flat on the ground with the inside of the heels 25 cm apart;
2. simultaneously, with a quick motion, bring the arms behind the back, stretched to their full extent, and place the back of the right hand in the palm of the left, with thumbs crossed right over left, the fingers together and extended; and
3. balance the body with the weight evenly distributed on both feet.

A-CR-CCP-601/PF-001

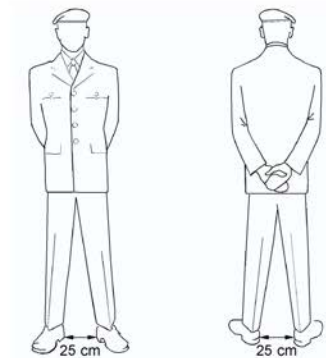

A-PD-201-000/PT-000, The Canadian Forces Manual of Drill and Ceremonial, 2001

Figure 8-1-4 The Position of Stand at Ease

PRACTICE THE SQUAD ON THE SECOND MOVEMENT

Practice the squad on the second movement collectively, individually and collectively.

GIVE TWO COMPLETE AND FINAL DEMONSTRATIONS

On the command STAND AT – EASE, combine the two movements. The timing is "one."

The instructor(s) shall provide a full demonstration and allow time for practice.



Constant checking and correcting of all faults is essential. Faults shall be corrected immediately after they occur.

CONFIRMATION OF TEACHING POINT 2

Cadets will adopt the position of stand at ease as a squad.

END OF LESSON CONFIRMATION

The confirmation for this lesson should consist of the cadets, as a squad, practicing the positions of attention, stand at ease and stand easy, and should emphasize movements that cadets showed difficulty with during the class.

Practice the complete movement, with the:

- **instructor** calling the time;
- **squad** calling the time; and
- **squad judging** the time.

A-CR-CCP-601/PF-001

CONCLUSION

HOMEWORK/READING/PRACTICE

Drill movements are skills that must be practiced individually, in order to make the cadet more proficient as a member of a unit. Cadets are encouraged to practice the movements, as opportunities are made available. Ongoing feedback will be provided, and should be heeded during any drill practice.

METHOD OF EVALUATION

In accordance with A-PD-201-000/PT-000, *The Canadian Forces Manual of Drill and Ceremonial*, the cadet shall participate in an Annual Ceremonial Review (ACR) parade. This movement will be used in preparation for, and in the execution of, the ACR parade.

CLOSING STATEMENT

The hallmarks of cadet drill are efficiency, precision, and dignity. These qualities are developed through self-discipline and practice. They lead to unit pride and cohesion. Good drill that is well rehearsed, closely supervised and precise, is an exercise in obedience and alertness. It sets the standard for the execution of any duty, both for the individual and the unit, and builds a sense of confidence between commander and subordinate that is essential to high morale. The personal qualities developed on the parade ground must be maintained in all aspects of life.

INSTRUCTOR NOTES/REMARKS

N/A.

REFERENCES

A0-002 A-PD-201-000/PT-000 DHH 3-2. (2001). *The Canadian Forces Manual of Drill and Ceremonial*. Ottawa, ON: The Department of National Defence.

MODIFIED LESSON SPECIFICATIONS AND INSTRUCTIONAL GUIDES – EO M108.01 (MOVEMENT OF STAND EASY FROM STAND AT EASE, AND STAND AT EASE FROM STAND EASY)

A-CR-CCP-601/PG-001

EO M108.01 – ADOPT THE POSITIONS OF ATTENTION, STAND AT EASE, AND STAND EASY

1. **Performance.** Adopt the Positions of Attention, Stand at Ease, and Stand Easy.
2. **Conditions**
 - a. Given:
 - (1) words of command;
 - (2) supervision; and
 - (3) assistance as required.
 - b. Denied: N/A.
 - c. Environmental: A drill, or outdoor parade square in favourable weather.
3. **Standard.** In accordance with A-PD-201-000/PT-000, the cadet shall perform the following individual drill movements:
 - a. stand easy from stand at ease; and
 - b. stand at ease from stand easy.

4. **Teaching Points**

TP	Description	Method	Time	Ref
TP1	Explain and demonstrate the movement of stand easy from stand at ease and allow cadets to practice.	Demonstration and Performance	5 min	A0-002 (pp. 2-2 to 2-8)
TP2	Explain and demonstrate the movement of stand at ease from stand easy and allow cadets to practice.	Demonstration and Performance	5 min	A0-002 (pp. 2-2 to 2-8)

5. **Time**
 - a. Introduction/Conclusion: 5 min
 - b. Demonstration and Performance: 10 min
 - c. Total: 15 min
6. **Substantiation.** The demonstration-performance method was chosen to allow cadets to participate in supervised exploration of practical instructional material. This method provides the instructor the opportunity to introduce the subject matter, demonstrate and explain procedures, and supervise the cadets while they imitate the skill. This method appeals to all learning styles.
7. **References.** A0-002 A-PD-201-000/PT-000 DHH 3-2. (2001). *The Canadian Forces Manual of Drill and Ceremonial*. Ottawa, ON: The Department of National Defence.
8. **Training Aids.** Assistant instructors as required.
9. **Learning Aids.** N/A.

A-CR-CCP-601/PG-001

10. **Test Details.** There is no formal assessment of this EO. Instructors will confirm the cadets' ability to perform the drill movement during the end of lesson check, and ongoing feedback will be provided during future drill practices, weekly parade nights, and ceremonial parades.
11. **Remarks.** N/A.

A-CR-CCP-601/PF-001



COMMON TRAINING
PHASE ONE
INSTRUCTIONAL GUIDE



SECTION 1

EO M108.01 – ADOPT THE POSITIONS OF ATTENTION, STAND AT EASE AND STAND EASY

Total Time: 15 min

PREPARATION

PRE-LESSON INSTRUCTIONS

A complete list of resources needed for the instruction of this EO is located at Chapter 4 of the QSP. Specific uses for said stores are identified throughout the Instructional Guide, within the teaching point for which they are required.

Prior to instructing this lesson the instructor shall:

- review the lesson content, and become familiar with the material; and
- select the most effective squad formation for the lesson being taught. A squad may be in a single rank, hollow square or semi-circle for elementary drill instruction. (Note: All cadets **must** be able to fully observe all demonstrations and explanations.)

PRE-LESSON ASSIGNMENT

N/A.

APPROACH

This lesson will be presented using the demonstration and performance method. The demonstration-performance method was chosen to allow cadets to participate in supervised exploration of practical instructional material. This method provides the instructor the opportunity to introduce the subject matter, demonstrate and explain procedures, and supervise the cadets while they imitate the skill. This method appeals to all learning styles.



The instructor shall develop and use a vocabulary of short, concise words to impress on the squad that the movements must be performed smartly. For example, the words “crack”, “drive”, “seize” and “grasp” suggest the degree of smartness required. Profanity or personal sarcasm shall never be used.

INTRODUCTION

REVIEW

N/A.

A-CR-CCP-601/PF-001

OBJECTIVES

By the end of this lesson the cadet shall be expected to adopting the positions of stand easy and stand at ease.

IMPORTANCE

As members of the Canadian Cadet Movement (CCM) cadets will be required to perform drill movements at a competent level, developing sharpness, esprit de corps, physical coordination, and alertness. These movements will be executed with ease and without hesitation. Ensuring that the cadets efficiently move together as one will promote discipline, alertness, precision, pride, steadiness, and cohesion. This develops the basis of teamwork that the CCM depends on.

Teaching Point 4

Adopting the Position of Stand Easy

Time: 5 min

Method: Demonstration and Performance

DEMONSTRATE THE COMPLETE MOVEMENT WITH TIMING



Instructors are reminded that they are to present the example with regards to drill, from the moment they step onto the parade square. Proper drill movements, combined with a professional demeanour, are of paramount importance, and must be exemplified throughout the period of instruction.

The instructor shall provide a complete demonstration of the drill movement, with timing. A practiced assistant instructor may carry out this demonstration.

The demonstration shall be provided from various vantage points, as required.

The position of stand easy is ordered when it is desirable to permit cadets to relax. This command is only given when the squad is in the position of stand at ease.

On the comand STAND – EASY, the cadet shall:

1. close the hands and bring the arms to the position of attention; and
2. relax.

A-CR-CCP-601/PF-001

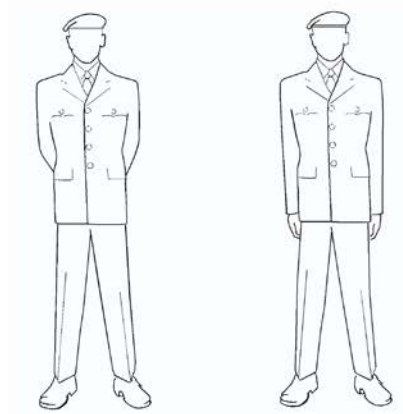

A-PD-201-000/PT-000, *The Canadian Forces Manual of Drill and Ceremonial, 2001*

Figure 8-1-5 Stand Easy From Stand at Ease



When standing easy, the cadet may, with permission, move all but the feet and adjust clothing and equipment, but shall not talk.

PRACTICE THE COMPLETE MOVEMENT WITH TIMING

Practice the squad on the first movement collectively, individually and collectively.

GIVE TWO COMPLETE AND FINAL DEMONSTRATIONS

Combine the preceding movements with timing. The instructor(s) shall provide a full demonstration and allow time for practice.



Constant checking and correcting of all faults is essential. Faults shall be corrected immediately after they occur.

CONFIRMATION OF TEACHING POINT 4

Cadets will adopt the position of stand easy as a squad.

Teaching Point 5

Adopting the Position of Stand at Ease From Standing Easy

Time: 5 min

Method: Demonstration and Performance

DEMONSTRATE THE COMPLETE MOVEMENT WITH TIMING

The instructor shall provide a complete demonstration of the drill movement, with timing. A practiced assistant instructor may carry out this demonstration.

A-CR-CCP-601/PF-001

The demonstration shall be provided from various vantage points, as required.

In order to adopt the position of stand at ease from easy the cadet shall, on the cautionary command SQUAD (or formation title), assume the position of stand at ease.

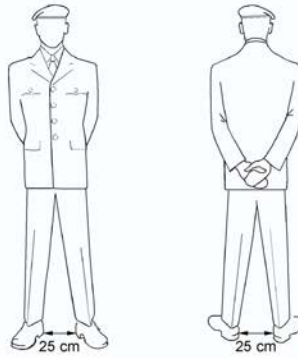

A-PD-201-000/PT-000, *The Canadian Forces Manual of Drill and Ceremonial, 2001*

Figure 8-1-4 The Position of Stand at Ease



This teaching point is best taught as a group practice to ensure adherence to timings and togetherness of the squad.



Constant checking and correcting of all faults is essential. Faults shall be corrected immediately after they occur.

CONFIRMATION OF TEACHING POINT 5

Cadets will adopt the position of stand at ease as a squad.

END OF LESSON CONFIRMATION

The confirmation for this lesson should consist of the cadets, as a squad, practicing the positions of attention, stand at ease and stand easy, and should emphasize movements that cadets showed difficulty with during the class.

Practice the complete movement, with the:

- **instructor** calling the time;
- **squad** calling the time; and
- **squad judging** the time.

A-CR-CCP-601/PF-001

CONCLUSION

HOMEWORK/READING/PRACTICE

Drill movements are skills that must be practiced individually, in order to make the cadet more proficient as a member of a unit. Cadets are encouraged to practice the movements, as opportunities are made available. Ongoing feedback will be provided, and should be heeded during any drill practice.

METHOD OF EVALUATION

In accordance with A-PD-201-000/PT-000, *The Canadian Forces Manual of Drill and Ceremonial*, the cadet shall participate in an Annual Ceremonial Review (ACR) parade. This movement will be used in preparation for, and in the execution of, the ACR parade.

CLOSING STATEMENT

The hallmarks of cadet drill are efficiency, precision, and dignity. These qualities are developed through self-discipline and practice. They lead to unit pride and cohesion. Good drill that is well rehearsed, closely supervised and precise, is an exercise in obedience and alertness. It sets the standard for the execution of any duty, both for the individual and the unit, and builds a sense of confidence between commander and subordinate that is essential to high morale. The personal qualities developed on the parade ground must be maintained in all aspects of life.

INSTRUCTOR NOTES/REMARKS

N/A.

REFERENCES

A0-002 A-PD-201-000/PT-000 DHH 3-2. (2001). *The Canadian Forces Manual of Drill and Ceremonial*. Ottawa, ON: The Department of National Defence.

THIS PAGE INTENTIONALLY LEFT BLANK

**MODIFIED LESSON SPECIFICATIONS AND INSTRUCTIONAL
GUIDES – EO M108.02 (SALUTE TO THE FRONT)**

A-CR-CCP-601/PG-001

EO M108.02 – EXECUTE A SALUTE AT THE HALT WITHOUT ARMS

1. **Performance.** Execute a Salute at the Halt Without Arms.
2. **Conditions**
 - a. Given:
 - (1) words of command;
 - (2) supervision; and
 - (3) assistance as required.
 - b. Denied: N/A.
 - c. Environmental: A drill, or outdoor parade square in favourable weather.
3. **Standard.** In accordance with A-PD-201-000/PT-000, the cadet shall execute salutes at the halt without arms, to the front.
4. **Teaching Points**

TP	Description	Method	Time	Ref
TP1	Explain and demonstrate saluting to the front at the halt and allow cadets to practice.	Demonstration and Performance	10 min	A0-002 (pp. 2-10 to 2-12)

5. **Time**
 - a. Introduction/Conclusion: 5 min
 - b. Demonstration and Performance: 10 min
 - c. Total: 15 min
6. **Substantiation.** The demonstration-performance method was chosen to allow cadets to participate in supervised exploration of practical instructional material. This method provides the instructor the opportunity to introduce the subject matter, demonstrate and explain procedures, and supervise the cadets while they imitate the skill. This method appeals to all learning styles.
7. **References.** A0-002 A-PD-201-000/PT-000 DHH 3-2. (2001). *The Canadian Forces Manual of Drill and Ceremonial*. Ottawa, ON: The Department of National Defence.
8. **Training Aids.** Assistant instructors as required.
9. **Learning Aids.** N/A.
10. **Test Details.** There is no formal assessment of this EO. Instructors will confirm the cadets' ability to perform the movements during the end of lesson check, and ongoing feedback will be provided during future drill practices, weekly parade nights, and ceremonial parades.
11. **Remarks.** N/A.



COMMON TRAINING
PHASE ONE
INSTRUCTIONAL GUIDE



SECTION 2

EO M108.02 – EXECUTE A SALUTE AT THE HALT WITHOUT ARMS

Total Time: 15 min

PREPARATION

PRE-LESSON INSTRUCTIONS

A complete list of resources needed for the instruction of this EO is located at Chapter 4 of the QSP. Specific uses for said stores are identified throughout the Instructional Guide, within the teaching point for which they are required.

Prior to instructing this lesson the instructor shall:

- review the lesson content, and become familiar with the material; and
- select the most effective squad formation for the lesson being taught. A squad may be in a single rank, hollow square or semi-circle for elementary drill instruction. (Note: All cadets **must** be able to fully observe all demonstrations and explanations.)

PRE-LESSON ASSIGNMENT

N/A.

APPROACH

This lesson will be presented using the demonstration and performance method. The demonstration-performance method was chosen to allow cadets to participate in supervised exploration of practical instructional material. This method provides the instructor the opportunity to introduce the subject matter, demonstrate and explain procedures, and supervise the cadets while they imitate the skill. This method appeals to all learning styles.



The instructor shall develop and use a vocabulary of short, concise words to impress on the squad that the movements must be performed smartly. For example, the words “crack”, “drive”, “seize” and “grasp” suggest the degree of smartness required. Profanity or personal sarcasm shall never be used.

INTRODUCTION

REVIEW

N/A.

A-CR-CCP-601/PF-001

OBJECTIVES

By the end of this lesson the cadet shall be expected to execute a salute at the halt without arms.

IMPORTANCE

As members of the Canadian Cadet Organization (CCO) cadets will be required to perform drill movements at a competent level, developing sharpness, esprit de corps, physical coordination, and alertness. These movements will be executed with ease and without hesitation. Ensuring that the cadets efficiently move together as one will promote discipline, alertness, precision, pride, steadiness, and cohesion. This develops the basis of teamwork that the CCO depends on.

Teaching Point 1

Execute a Salute to the Front

Time: 10 min

Method: Demonstration and Performance

DEMONSTRATE THE COMPLETE MOVEMENT WITH TIMING



Instructors are reminded that they are to present the example with regards to drill, from the moment they step onto the parade square. Proper drill movements, combined with a professional demeanour, are of paramount importance, and must be exemplified throughout the period of instruction.

The instructor shall provide a complete demonstration of the drill movement, with timing. A practiced assistant instructor may carry out this demonstration.

The demonstration shall be provided from various vantage points, as required.

The salute is given with the right hand. When physical incapacity or carrying of articles makes a salute with the right hand impracticable, compliments will be paid by turning the head and eyes to the left or right or standing to attention, as appropriate (see also A-PD-201-000/PT-000, Chapter 1, Section 2).

DEMONSTRATE FIRST PART OF MOVEMENT (FIRST NUMBER)



For ease of instruction, drill commands have been broken down into individual movements, or numbers. The instructor(s) shall demonstrate and explain each number.

On the command TO THE FRONT SALUTE BY NUMBERS, SQUAD – ONE, the cadet shall:

1. bend the right elbow and open the palm of the right hand as it passes the shoulder; and
2. force the right hand by its shortest route to the front of the headdress so that the:
 - a. palm of the hand is facing down;
 - b. thumb and fingers are fully extended and close together;
 - c. tip of the second finger is in line with the outside of the right eyebrow and touching the outside edge of the headdress or arm of glasses, if worn;
 - d. hand, wrist and forearm are in a straight line and at a 45-degree angle to the upper arm;
 - e. elbow is in line with the shoulders; and

- f. upper arm is parallel to the ground.

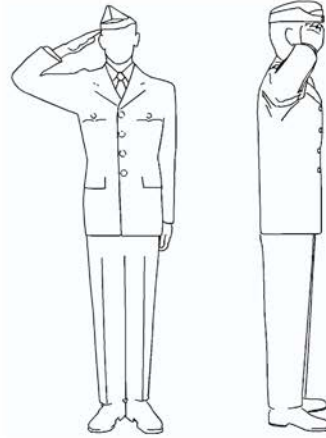

A-PD-201-000/PT-000, The Canadian Forces Manual of Drill and Ceremonial, 2001

Figure 8-2-1 Saluting to the Front Without Arms

PRACTICE THE SQUAD ON THE FIRST MOVEMENT

Practice the squad on the first movement collectively, individually and collectively.



Constant checking and correcting of all faults is essential. Faults shall be corrected immediately after they occur.

DEMONSTRATE AND EXPLAIN THE SECOND PART OF THE MOVEMENT

On the command SQUAD – TWO, the hand is:

1. brought sharply to the position of attention by the shortest route, without slapping the thigh; and
2. closed after the forearm is lowered below shoulder level.

PRACTICE THE SQUAD ON THE SECOND MOVEMENT

Practice the squad on the second movement collectively, individually and collectively.

GIVE TWO COMPLETE AND FINAL DEMONSTRATIONS

On the command TO THE FRONT – SALUTE, the two movements are combined. The standard pause shall be observed between movements.

The instructor(s) shall provide a full demonstration and allow time for practice.

Note: When wearing headdress, other than a cap with a peak, the second finger is 2 cm above and in line with the outer tip of the right eyebrow.

A-CR-CCP-601/PF-001



Standard Pause: The standard pause between each movement is two beats in quick time. For example, on the command MOVE TO THE RIGHT IN FILE, RIGHT – TURN, the squad:

1. executes the first movement of the turn on the executive order and simultaneously calls out "ONE";
2. after completing the first movement, calls "TWO", "THREE" while observing the standard pause; and
3. when executing the final movement, calls out "ONE".

CONFIRMATION OF TEACHING POINT 1

Cadets will execute salutes to the front as a squad.

END OF LESSON CONFIRMATION

The cadet's participation in TP1 will serve as the confirmation of this lesson.

CONCLUSION

HOMEWORK/READING/PRACTICE

N/A.

METHOD OF EVALUATION

In accordance with A-PD-201-000/PT-000, *The Canadian Forces Manual of Drill and Ceremonial*, the cadet shall participate in an Annual Ceremonial Review (ACR) parade. This movement will be used in preparation for, and execution of, the ACR parade.

CLOSING STATEMENT

The hallmarks of cadet drill are efficiency, precision, and dignity. These qualities are developed through self-discipline and practice. They lead to unit pride and cohesion. Good drill, that is well rehearsed, closely supervised and precise, is an exercise in obedience and alertness. It sets the standard for the execution of any duty, both for the individual and the unit, and builds a sense of confidence between commander and subordinate that is essential to high morale. The personal qualities developed on the parade ground must be maintained in all aspects of life.

INSTRUCTOR NOTES/REMARKS

N/A.

REFERENCES

A0-002 A-PD-201-000/PT-000 DHH 3-2. (2001). *The Canadian Forces Manual of Drill and Ceremonial*. Ottawa, ON: The Department of National Defence.

THIS PAGE INTENTIONALLY LEFT BLANK

MODIFIED LESSON SPECIFICATIONS AND INSTRUCTIONAL GUIDES – EO M108.02 (SALUTE TO THE RIGHT [LEFT])

A-CR-CCP-601/PG-001

EO M108.02 – EXECUTE A SALUTE AT THE HALT WITHOUT ARMS

1. **Performance.** Execute a Salute at the Halt Without Arms.
2. **Conditions**
 - a. Given:
 - (1) words of command;
 - (2) supervision; and
 - (3) assistance as required.
 - b. Denied: N/A.
 - c. Environmental: A drill, or outdoor parade square in favourable weather.
3. **Standard.** In accordance with A-PD-201-000/PT-000, the cadet shall execute salutes at the halt without arms, to the left and right.

4. **Teaching Points**

TP	Description	Method	Time	Ref
TP2	Explain and demonstrate saluting to the left and right at the halt and allow cadets to practice.	Demonstration and Performance	10 min	A0-002 (pp. 2-10 to 2-12)

5. **Time**
 - a. Introduction/Conclusion: 5 min
 - b. Demonstration and Performance: 10 min
 - c. Total: 15 min
6. **Substantiation.** The demonstration-performance method was chosen to allow cadets to participate in supervised exploration of practical instructional material. This method provides the instructor the opportunity to introduce the subject matter, demonstrate and explain procedures, and supervise the cadets while they imitate the skill. This method appeals to all learning styles.
7. **References.** A0-002 A-PD-201-000/PT-000 DHH 3-2. (2001). *The Canadian Forces Manual of Drill and Ceremonial*. Ottawa, ON: The Department of National Defence.
8. **Training Aids.** Assistant instructors as required.
9. **Learning Aids.** N/A.
10. **Test Details.** There is no formal assessment of this EO. Instructors will confirm the cadets' ability to perform the movements during the end of lesson check, and ongoing feedback will be provided during future drill practices, weekly parade nights, and ceremonial parades.
11. **Remarks.** N/A.



COMMON TRAINING
PHASE ONE
INSTRUCTIONAL GUIDE



SECTION 2

EO M108.02 – EXECUTE A SALUTE AT THE HALT WITHOUT ARMS

Total Time: 15 min

PREPARATION

PRE-LESSON INSTRUCTIONS

A complete list of resources needed for the instruction of this EO is located at Chapter 4 of the QSP. Specific uses for said stores are identified throughout the Instructional Guide, within the teaching point for which they are required.

Prior to instructing this lesson the instructor shall:

- review the lesson content, and become familiar with the material; and
- select the most effective squad formation for the lesson being taught. A squad may be in a single rank, hollow square or semi-circle for elementary drill instruction. (Note: All cadets **must** be able to fully observe all demonstrations and explanations.)

PRE-LESSON ASSIGNMENT

N/A.

APPROACH

This lesson will be presented using the demonstration and performance method. The demonstration-performance method was chosen to allow cadets to participate in supervised exploration of practical instructional material. This method provides the instructor the opportunity to introduce the subject matter, demonstrate and explain procedures, and supervise the cadets while they imitate the skill. This method appeals to all learning styles.

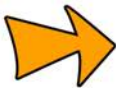

The instructor shall develop and use a vocabulary of short, concise words to impress on the squad that the movements must be performed smartly. For example, the words “crack”, “drive”, “seize” and “grasp” suggest the degree of smartness required. Profanity or personal sarcasm shall never be used.

INTRODUCTION

REVIEW

N/A.

A-CR-CCP-601/PF-001

OBJECTIVES

By the end of this lesson the cadet shall be expected to execute a salute at the halt without arms.

IMPORTANCE

As members of the Canadian Cadet Organization (CCO) cadets will be required to perform drill movements at a competent level, developing sharpness, esprit de corps, physical coordination, and alertness. These movements will be executed with ease and without hesitation. Ensuring that the cadets efficiently move together as one will promote discipline, alertness, precision, pride, steadiness, and cohesion. This develops the basis of teamwork that the CCO depends on.

Teaching Point 2

Execute a Salute to the Right (Left)

Time: 10 min

Method: Demonstration and Performance

DEMONSTRATE THE COMPLETE MOVEMENT WITH TIMING



Instructors are reminded that they are to present the example with regards to drill, from the moment they step onto the parade square. Proper drill movements, combined with a professional demeanour, are of paramount importance, and must be exemplified throughout the period of instruction.

The instructor shall provide a complete demonstration of the drill movement, with timing. A practiced assistant instructor may carry out this demonstration.

The demonstration shall be provided from various vantage points, as required.

The salute is given with the right hand. When physical incapacity or carrying of articles makes a salute with the right hand impracticable, compliments will be paid by turning the head and eyes to the left or right or standing to attention, as appropriate (see also A-PD-201-000/PT-000, Chapter 1, Section 2)

DEMONSTRATE FIRST PART OF MOVEMENT (FIRST NUMBER)



For ease of instruction, drill commands have been broken down into individual movements, or numbers. The instructor(s) shall demonstrate and explain each number.

On the command TO THE RIGHT (LEFT) SALUTE BY NUMBERS, SQUAD – ONE, saluting shall:

1. bend the right elbow and open the palm of the right hand as it passes the shoulder; and
2. force the right hand by its shortest route to the front of the headdress so that the:
 - a. palm of the hand is facing down;
 - b. thumb and fingers are fully extended and close together;
 - c. tip of the second finger is in line with the outside of the right eyebrow and touching the outside edge of the headdress or arm of glasses, if worn;
 - d. hand, wrist and forearm are in a straight line and at a 45-degree angle to the upper arm; and
 - e. upper arm is parallel to the ground.

3. the head and eyes shall be turned smartly to the right (left) as far as possible without straining, remembering the following:
 - a. when saluting to the left, the right hand, wrist and arm are brought further over to the left to the correct position in line with the outside edge of the right eyebrow; and
 - b. when saluting to the right, the arm is moved to the rear, with the tip of the second finger remaining in line with the outside edge of the right eyebrow.

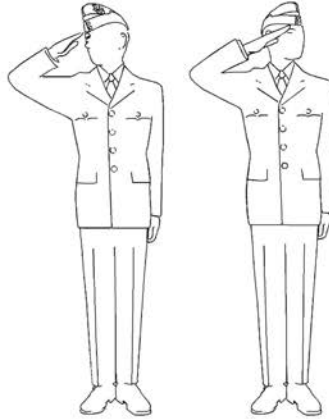

A-PD-201-000/PT-000, The Canadian Forces Manual of Drill and Ceremonial, 2001

Figure 8-2-2 Saluting to the Right and Left

PRACTICE THE SQUAD ON THE FIRST MOVEMENT

Practice the squad on the first movement collectively, individually and collectively.



Constant checking and correcting of all faults is essential. Faults shall be corrected immediately after they occur.

DEMONSTRATE AND EXPLAIN THE SECOND PART OF THE MOVEMENT

On the command SQUAD – TWO, the hand is brought sharply to the position of attention, and simultaneously the head and eyes are turned smartly to the front.

PRACTICE THE SQUAD ON THE SECOND MOVEMENT

Practice the squad on the second movement collectively, individually and collectively.

GIVE TWO COMPLETE AND FINAL DEMONSTRATIONS

On the command TO THE RIGHT (LEFT) – SALUTE, the two movements are combined. The standard pause shall be observed between movements.

The instructor(s) shall provide a full demonstration and allow time for practice.

A-CR-CCP-601/PF-001



Standard Pause: The standard pause between each movement is two beats in quick time. For example, on the command MOVE TO THE RIGHT IN FILE, RIGHT – TURN, the squad:

1. executes the first movement of the turn on the executive order and simultaneously calls out "ONE";
2. after completing the first movement, calls "TWO", "THREE" while observing the standard pause; and
3. when executing the final movement, calls out "ONE".

CONFIRMATION OF TEACHING POINT 2

Cadets will execute salutes to the left and left as a squad.

END OF LESSON CONFIRMATION

The cadet's participation in TP2 will serve as the confirmation of this lesson.

CONCLUSION

HOMEWORK/READING/PRACTICE

N/A.

METHOD OF EVALUATION

In accordance with A-PD-201-000/PT-000, *The Canadian Forces Manual of Drill and Ceremonial*, the cadet shall participate in an Annual Ceremonial Review (ACR) parade. This movement will be used in preparation for, and execution of, the ACR parade.

CLOSING STATEMENT

The hallmarks of cadet drill are efficiency, precision, and dignity. These qualities are developed through self-discipline and practice. They lead to unit pride and cohesion. Good drill, that is well rehearsed, closely supervised and precise, is an exercise in obedience and alertness. It sets the standard for the execution of any duty, both for the individual and the unit, and builds a sense of confidence between commander and subordinate that is essential to high morale. The personal qualities developed on the parade ground must be maintained in all aspects of life.

INSTRUCTOR NOTES/REMARKS

N/A.

REFERENCES

A0-002 A-PD-201-000/PT-000 DHH 3-2. (2001). *The Canadian Forces Manual of Drill and Ceremonial*. Ottawa, ON: The Department of National Defence.

THIS PAGE INTENTIONALLY LEFT BLANK

**MODIFIED LESSON SPECIFICATIONS AND INSTRUCTIONAL
GUIDES – EO M108.03 (RIGHT TURN AT THE HALT)**

A-CR-CCP-601/PG-001

EO M108.03 – EXECUTE TURNS AT THE HALT

1. **Performance.** Execute Turns at the Halt.
2. **Conditions**
 - a. Given:
 - (1) words of command;
 - (2) supervision; and
 - (3) assistance as required.
 - b. Denied: N/A.
 - c. Environmental: A drill hall, or outdoor parade square in favourable weather.
3. **Standard.** In accordance with A-PD-201-000/PT-000, the cadet shall perform the movement of right turn at the halt.
4. **Teaching Points**

TP	Description	Method	Time	Ref
TP1	Explain and demonstrate the movement of right turn at the halt and allow cadets to practice.	Demonstration and Performance	10 min	A0-002 (pp. 2-12 to 2-13)

5. **Time**
 - a. Introduction/Conclusion: 5 min
 - b. Demonstration and Performance: 10 min
 - c. Total: 15 min
6. **Substantiation.** The demonstration-performance method was chosen to allow cadets to participate in supervised exploration of practical instructional material. This method provides the instructor the opportunity to introduce the subject matter, demonstrate and explain procedures, and supervise the cadets while they imitate the skill. This method appeals to all learning styles.
7. **References.** A0-002 A-PD-201-000/PT-000 DHH 3-2. (2001). *The Canadian Forces Manual of Drill and Ceremonial*. Ottawa, ON: The Department of National Defence.
8. **Training Aids.** Assistant instructors as required.
9. **Learning Aids.** N/A.
10. **Test Details.** There is no formal assessment of this EO. Instructors will confirm the cadets' ability to perform the movement during the end of lesson check, and ongoing feedback will be provided during future drill practices, weekly parade nights, and ceremonial parades.
11. **Remarks.** N/A.



COMMON TRAINING
PHASE ONE
INSTRUCTIONAL GUIDE



SECTION 3

EO M108.03 – EXECUTE TURNS AT THE HALT

Total Time: 15 min

PREPARATION

PRE-LESSON INSTRUCTIONS

A complete list of resources needed for the instruction of this EO is located at Chapter 4 of the QSP. Specific uses for said stores are identified throughout the Instructional Guide, within the teaching point for which they are required.

Prior to instructing this lesson the instructor shall:

- review the lesson content, and become familiar with the material; and
- select the most effective squad formation for the lesson being taught. A squad may be in a single rank, hollow square or semi-circle for elementary drill instruction. (Note: All cadets **must** be able to fully observe all demonstrations and explanations.)

PRE-LESSON ASSIGNMENT

N/A.

APPROACH

This lesson will be presented using the demonstration and performance method. The demonstration-performance method was chosen to allow cadets to participate in supervised exploration of practical instructional material. This method provides the instructor the opportunity to introduce the subject matter, demonstrate and explain procedures, and supervise the cadets while they imitate the skill. This method appeals to all learning styles.



The instructor shall develop and use a vocabulary of short, concise words to impress on the squad that the movements must be performed smartly. For example, the words “crack”, “drive”, “seize” and “grasp” suggest the degree of smartness required. Profanity or personal sarcasm shall never be used.

INTRODUCTION

REVIEW

N/A.

A-CR-CCP-601/PF-001

OBJECTIVES

By the end of this lesson the cadet shall be expected to execute right turns at the halt.

IMPORTANCE

As members of the Canadian Cadet Movement (CCM) cadets will be required to perform drill movements at a competent level, developing sharpness, esprit de corps, physical coordination, and alertness. These movements will be executed with ease and without hesitation. Ensuring that the cadets efficiently move together as one will promote discipline, alertness, precision, pride, steadiness, and cohesion. This develops the basis of teamwork that the CCM depends on.

Teaching Point 1

Execute Right Turn

Time: 10 min

Method: Demonstration and Performance

DEMONSTRATE THE COMPLETE MOVEMENT WITH TIMING



Instructors are reminded that they are to present the example with regards to drill, from the moment they step onto the parade square. Proper drill movements, combined with a professional demeanour, are of paramount importance, and must be exemplified throughout the period of instruction.

The instructor shall provide a complete demonstration of the drill movement, with timing. A practiced assistant instructor may carry out this demonstration.

The demonstration shall be provided from various vantage points, as required.

Turns and inclines are made to change direction: right or left turns change direction by 90°, about turns by 180°, and right and left inclines (not instructed in this lesson) by 45°.

DEMONSTRATE FIRST PART OF MOVEMENT (FIRST NUMBER)



For ease of instruction, drill commands have been broken down into individual movements, or numbers. The instructor(s) shall demonstrate and explain each number.

The cadet shall execute a right turn, by:

On the command RIGHT TURN BY NUMBERS, SQUAD – ONE, turning 90° to the right by pivoting on the right heel and left toe and raising the left heel and right toe simultaneously. Both knees will be kept braced during the turn, arms at the sides and body erect. On the completion of the movement, the weight of the body is placed on the right foot and the left leg is braced with the heel off the ground.

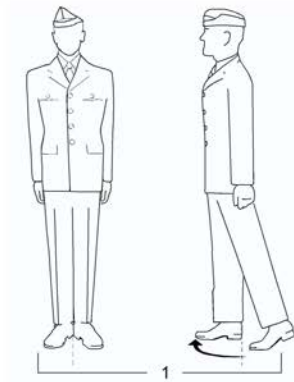

A-PD-201-000/PT-000, The Canadian Forces Manual of Drill and Ceremonial, 2001

Figure 8-3-1 Squad One – Right Turn at the Halt

PRACTICE THE SQUAD ON THE FIRST MOVEMENT

Practice the squad on the first movement collectively, individually and collectively.



Constant checking and correcting of all faults is essential. Faults shall be corrected immediately after they occur.

DEMONSTRATE AND EXPLAIN THE SECOND PART OF THE MOVEMENT

On the command SQUAD – TWO, the cadets shall bend the left knee, straightening it in double time and smartly placing the left foot beside the right to assume the position of attention.

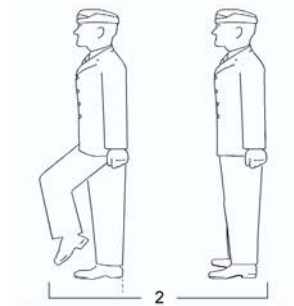

A-PD-201-000/PT-000, The Canadian Forces Manual of Drill and Ceremonial, 2001

Figure 8-3-2 Squad Two – Right Turn at the Halt

PRACTICE THE SQUAD ON THE SECOND MOVEMENT

Practice the squad on the second movement collectively, individually and collectively.

A-CR-CCP-601/PF-001

GIVE TWO COMPLETE AND FINAL DEMONSTRATIONS

On the command RIGHT – TURN, combine the two movements. The standard pause shall be observed between the movements.

The instructor(s) shall provide a full demonstration and allow time for practice.



Standard Pause: The standard pause between each movement is two beats in quick time. For example, on the command MOVE TO THE RIGHT IN FILE, RIGHT – TURN, the squad:

1. executes the first movement of the turn on the executive order and simultaneously calls out "ONE";
2. after completing the first movement, calls "TWO", "THREE" while observing the standard pause; and
3. when executing the final movement, calls out "ONE".

CONFIRMATION OF TEACHING POINT 1

Cadets will execute right turns as a squad.

END OF LESSON CONFIRMATION

The cadet's participation in TP1 will serve as the confirmation of this lesson.

CONCLUSION

HOMEWORK/READING/PRACTICE

N/A.

METHOD OF EVALUATION

In accordance with A-PD-201-000/PT-000, *The Canadian Forces Manual of Drill and Ceremonial*, the cadet shall participate in an Annual Ceremonial Review (ACR) parade. This movement will be used in preparation for, and in the execution of, the ACR parade.

CLOSING STATEMENT

The hallmarks of cadet drill are efficiency, precision, and dignity. These qualities are developed through self-discipline and practice. They lead to unit pride and cohesion. Good drill that is well rehearsed, closely supervised and precise, is an exercise in obedience and alertness. It sets the standard for the execution of any duty, both for the individual and the unit, and builds a sense of confidence between commander and subordinate that is essential to high morale. The personal qualities developed on the parade ground must be maintained in all aspects of life.

INSTRUCTOR NOTES/REMARKS

N/A.

REFERENCES

- A0-002 A-PD-201-000/PT-000 DHH 3-2. (2001). *The Canadian Forces Manual of Drill and Ceremonial*.
Ottawa, ON: The Department of National Defence.

**MODIFIED LESSON SPECIFICATIONS AND INSTRUCTIONAL
GUIDES – EO M108.03 (LEFT TURN AT THE HALT)**

A-CR-CCP-601/PG-001

EO M108.03 – EXECUTE TURNS AT THE HALT

1. **Performance.** Execute Turns at the Halt.
2. **Conditions**
 - a. Given:
 - (1) words of command;
 - (2) supervision; and
 - (3) assistance as required.
 - b. Denied: N/A.
 - c. Environmental: A drill hall, or outdoor parade square in favourable weather.
3. **Standard.** In accordance with A-PD-201-000/PT-000, the cadet shall perform the movement of left turn at the halt.
4. **Teaching Points**

TP	Description	Method	Time	Ref
TP2	Explain and demonstrate the movement of left turn at the halt and allow cadets to practice.	Demonstration and Performance	10 min	A0-002 (pp. 2-12 to 2-13)

5. **Time**
 - a. Introduction/Conclusion: 5 min
 - b. Demonstration and Performance: 10 min
 - c. Total: 15 min
6. **Substantiation.** The demonstration-performance method was chosen to allow cadets to participate in supervised exploration of practical instructional material. This method provides the instructor the opportunity to introduce the subject matter, demonstrate and explain procedures, and supervise the cadets while they imitate the skill. This method appeals to all learning styles.
7. **References.** A0-002 A-PD-201-000/PT-000 DHH 3-2. (2001). *The Canadian Forces Manual of Drill and Ceremonial*. Ottawa, ON: The Department of National Defence.
8. **Training Aids.** Assistant instructors as required.
9. **Learning Aids.** N/A.
10. **Test Details.** There is no formal assessment of this EO. Instructors will confirm the cadets' ability to perform the movements during the end of lesson check, and ongoing feedback will be provided during future drill practices, weekly parade nights, and ceremonial parades.
11. **Remarks.** N/A.



COMMON TRAINING
PHASE ONE
INSTRUCTIONAL GUIDE



SECTION 3

EO M108.03 – EXECUTE TURNS AT THE HALT

Total Time: 15 min

PREPARATION

PRE-LESSON INSTRUCTIONS

A complete list of resources needed for the instruction of this EO is located at Chapter 4 of the QSP. Specific uses for said stores are identified throughout the Instructional Guide, within the teaching point for which they are required.

Prior to instructing this lesson the instructor shall:

- review the lesson content, and become familiar with the material; and
- select the most effective squad formation for the lesson being taught. A squad may be in a single rank, hollow square or semi-circle for elementary drill instruction. (Note: All cadets **must** be able to fully observe all demonstrations and explanations.)

PRE-LESSON ASSIGNMENT

N/A.

APPROACH

This lesson will be presented using the demonstration and performance method. The demonstration-performance method was chosen to allow cadets to participate in supervised exploration of practical instructional material. This method provides the instructor the opportunity to introduce the subject matter, demonstrate and explain procedures, and supervise the cadets while they imitate the skill. This method appeals to all learning styles.



The instructor shall develop and use a vocabulary of short, concise words to impress on the squad that the movements must be performed smartly. For example, the words “crack”, “drive”, “seize” and “grasp” suggest the degree of smartness required. Profanity or personal sarcasm shall never be used.

INTRODUCTION

REVIEW

N/A.

A-CR-CCP-601/PF-001

OBJECTIVES

By the end of this lesson the cadet shall be expected to execute left turns at the halt.

IMPORTANCE

As members of the Canadian Cadet Movement (CCM) cadets will be required to perform drill movements at a competent level, developing sharpness, esprit de corps, physical coordination, and alertness. These movements will be executed with ease and without hesitation. Ensuring that the cadets efficiently move together as one will promote discipline, alertness, precision, pride, steadiness, and cohesion. This develops the basis of teamwork that the CCM depends on.

Teaching Point 2

Execute Left Turn

Time: 10 min

Method: Demonstration and Performance

DEMONSTRATE THE COMPLETE MOVEMENT WITH TIMING



Instructors are reminded that they are to present the example with regards to drill, from the moment they step onto the parade square. Proper drill movements, combined with a professional demeanour, are of paramount importance, and must be exemplified throughout the period of instruction.

The instructor shall provide a complete demonstration of the drill movement, with timing. A practiced assistant instructor may carry out this demonstration.

The demonstration shall be provided from various vantage points, as required.

Turns and inclines are made to change direction: right or left turns change direction by 90°, about turns by 180°, and right and left inclines (not instructed in this lesson) by 45°.

DEMONSTRATE FIRST PART OF MOVEMENT (FIRST NUMBER)



For ease of instruction, drill commands have been broken down into individual movements, or numbers. The instructor(s) shall demonstrate and explain each number.

The cadet shall execute a left turn, by:

On the command LEFT TURN BY NUMBERS, SQUAD – ONE, turning 90° to the left by pivoting on the left heel and right toe and raising the right heel and left toe simultaneously. Both knees will be kept braced during the turn, arms at the sides and body erect. On the completion of the movement, the weight of the body is placed on the left foot and the right leg is braced with the heel off the ground.

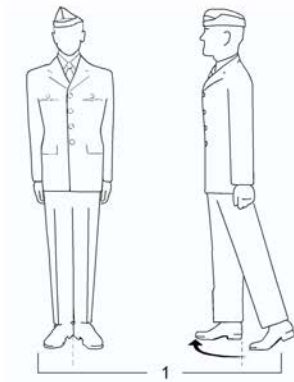

A-PD-201-000/PT-000, *The Canadian Forces Manual of Drill and Ceremonial, 2001*

Figure 8-3-1 Squad One – Turn at the Halt

PRACTICE THE SQUAD ON THE FIRST MOVEMENT

Practice the squad on the first movement collectively, individually and collectively.



Constant checking and correcting of all faults is essential. Faults shall be corrected immediately after they occur.

DEMONSTRATE AND EXPLAIN THE SECOND PART OF THE MOVEMENT (SECOND NUMBER)

On the command SQUAD – TWO, bend the right knee, straightening it in double time and smartly placing the right foot beside the left to assume the position of attention.

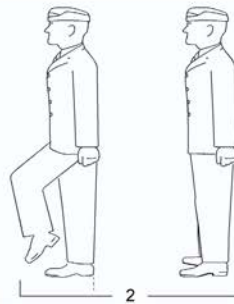

A-PD-201-000/PT-000, *The Canadian Forces Manual of Drill and Ceremonial, 2001*

Figure 8-3-2 Squad Two – Turn at the Halt

PRACTICE THE SQUAD ON THE SECOND MOVEMENT

Practice the squad on the second movement collectively, individually and collectively.

A-CR-CCP-601/PF-001

GIVE TWO COMPLETE AND FINAL DEMONSTRATIONS

On the command LEFT – TURN, combine the two movements. The standard pause shall be observed between the movements.

The instructor(s) shall provide a full demonstration and allow time for practice.

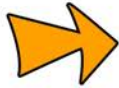

Standard Pause: The standard pause between each movements is two beats in quick time. For example, on the command MOVE TO THE LEFT IN FILE, LEFT – TURN, the squad:

1. executes the first movement of the turn on the executive order and simultaneously calls out “ONE”.
2. after completing the first movement, calls “TWO”, “THREE” while observing the standard pause.
3. when executing the final movement, calls out “ONE”.

CONFIRMATION OF TEACHING POINT 2

Cadets will execute LEFT turns as a squad.

END OF LESSON CONFIRMATION

The cadets' participation in TP2 will serve as the confirmation of this lesson.

CONCLUSION

HOMEWORK/READING/PRACTICE

N/A.

METHOD OF EVALUATION

In accordance with A-PD-201-000/PT-000, *The Canadian Forces Manual of Drill and Ceremonial*, the cadet shall participate in an Annual Ceremonial Review (ACR) parade. This movement will be used in preparation for, and in the execution of, the ACR parade.

CLOSING STATEMENT

The hallmarks of cadet drill are efficiency, precision, and dignity. These qualities are developed through self-discipline and practice. They lead to unit pride and cohesion. Good drill that is well rehearsed, closely supervised and precise, is an exercise in obedience and alertness. It sets the standard for the execution of any duty, both for the individual and the unit, and builds a sense of confidence between commander and subordinate that is essential to high morale. The personal qualities developed on the parade ground must be maintained in all aspects of life.

INSTRUCTOR NOTES/REMARKS

N/A.

REFERENCES

- A0-002 A-PD-201-000/PT-000 DHH 3-2. (2001). *The Canadian Forces Manual of Drill and Ceremonial*.
Ottawa, ON: The Department of National Defence.

**MODIFIED LESSON SPECIFICATIONS AND INSTRUCTIONAL
GUIDES – EO M108.03 (ABOUT TURN AT THE HALT)**

A-CR-CCP-601/PG-001

EO M108.03 – EXECUTE TURNS AT THE HALT

1. **Performance.** Execute Turns at the Halt.
2. **Conditions**
 - a. Given:
 - (1) words of command;
 - (2) supervision; and
 - (3) assistance as required.
 - b. Denied: N/A.
 - c. Environmental: A drill hall, or outdoor parade square in favourable weather.
3. **Standard.** In accordance with A-PD-201-000/PT-000, the cadet shall perform the movement of about turns at the halt.
4. **Teaching Points**

TP	Description	Method	Time	Ref
TP3	Explain and demonstrate the movement of about turn at the halt and allow cadets to practice.	Demonstration and Performance	10 min	A0-002 (pp. 2-12 to 2-13)

5. **Time**
 - a. Introduction/Conclusion: 5 min
 - b. Demonstration and Performance: 10 min
 - c. Total: 15 min
6. **Substantiation.** The demonstration-performance method was chosen to allow cadets to participate in supervised exploration of practical instructional material. This method provides the instructor the opportunity to introduce the subject matter, demonstrate and explain procedures, and supervise the cadets while they imitate the skill. This method appeals to all learning styles.
7. **References.** A0-002 A-PD-201-000/PT-000 DHH 3-2. (2001). *The Canadian Forces Manual of Drill and Ceremonial*. Ottawa, ON: The Department of National Defence.
8. **Training Aids.** Assistant instructors as required.
9. **Learning Aids.** N/A.
10. **Test Details.** There is no formal assessment of this EO. Instructors will confirm the cadets' ability to perform the movements during the end of lesson check, and ongoing feedback will be provided during future drill practices, weekly parade nights, and ceremonial parades.
11. **Remarks.** N/A.



COMMON TRAINING
PHASE ONE
INSTRUCTIONAL GUIDE



SECTION 3

EO M108.03 – EXECUTE TURNS AT THE HALT

Total Time: 15 min

PREPARATION

PRE-LESSON INSTRUCTIONS

A complete list of resources needed for the instruction of this EO is located at Chapter 4 of the QSP. Specific uses for said stores are identified throughout the Instructional Guide, within the teaching point for which they are required.

Prior to instructing this lesson the instructor shall:

- review the lesson content, and become familiar with the material; and
- select the most effective squad formation for the lesson being taught. A squad may be in a single rank, hollow square or semi-circle for elementary drill instruction. (Note: All cadets **must** be able to fully observe all demonstrations and explanations.)

PRE-LESSON ASSIGNMENT

N/A.

APPROACH

This lesson will be presented using the demonstration and performance method. The demonstration-performance method was chosen to allow cadets to participate in supervised exploration of practical instructional material. This method provides the instructor the opportunity to introduce the subject matter, demonstrate and explain procedures, and supervise the cadets while they imitate the skill. This method appeals to all learning styles.



The instructor shall develop and use a vocabulary of short, concise words to impress on the squad that the movements must be performed smartly. For example, the words “crack”, “drive”, “seize” and “grasp” suggest the degree of smartness required. Profanity or personal sarcasm shall never be used.

INTRODUCTION

REVIEW

N/A.

A-CR-CCP-601/PF-001

OBJECTIVES

By the end of this lesson the cadet shall be expected to execute about turns at the halt.

IMPORTANCE

As members of the Canadian Cadet Movement (CCM) cadets will be required to perform drill movements at a competent level, developing sharpness, esprit de corps, physical coordination, and alertness. These movements will be executed with ease and without hesitation. Ensuring that the cadets efficiently move together as one will promote discipline, alertness, precision, pride, steadiness, and cohesion. This develops the basis of teamwork that the CCM depends on.

Teaching Point 3

Execute About Turn

Time: 10 min

Method: Demonstration and Performance

DEMONSTRATE THE COMPLETE MOVEMENT WITH TIMING



Instructors are reminded that they are to present the example with regards to drill, from the moment they step onto the parade square. Proper drill movements, combined with a professional demeanour, are of paramount importance, and must be exemplified throughout the period of instruction.

The instructor shall provide a complete demonstration of the drill movement, with timing. A practiced assistant instructor may carry out this demonstration.

The demonstration shall be provided from various vantage points, as required.

DEMONSTRATE FIRST PART OF MOVEMENT (FIRST NUMBER)

On the command ABOUT TURN BY NUMBERS, SQUAD – ONE, turning 180° to the right by pivoting on the right heel and left toe and raising the left heel and right toe simultaneously. Both knees will be kept braced during the turn, arms at the sides and body erect. On the completion of the movement, the weight of the body is placed on the right foot and the left leg is braced with the heel off the ground.

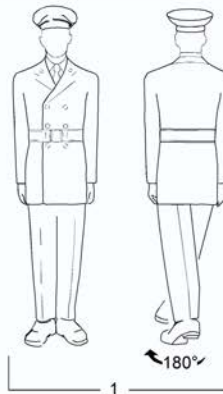

A-PD-201-000/PT-000, *The Canadian Forces Manual of Drill and Ceremonial*, 2001

Figure 8-3-3 Squad One – About Turn at the Halt

PRACTICE THE SQUAD ON THE FIRST MOVEMENT

Practice the squad on the first movement collectively, individually and collectively.



Constant checking and correcting of all faults is essential. Faults shall be corrected immediately after they occur.

DEMONSTRATE AND EXPLAIN THE SECOND PART OF THE MOVEMENT (SECOND NUMBER)

On the command SQUAD – TWO, bending the left knee, straightening it in double time and smartly placing the left foot beside the right to assume the position of attention.

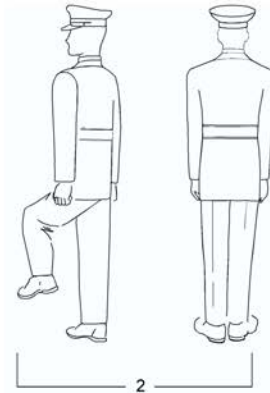

A-PD-201-000/PT-000, The Canadian Forces Manual of Drill and Ceremonial, 2001

Figure 8-3-4 Squad Two – About Turn at the Halt

PRACTICE THE SQUAD ON THE SECOND MOVEMENT

Practice the squad on the second movement collectively, individually and collectively.

GIVE TWO COMPLETE AND FINAL DEMONSTRATIONS

On the command ABOUT – TURN, combine the two movements. The standard pause shall be observed between the movements.

The instructor(s) shall provide a full demonstration and allow time for practice.

A-CR-CCP-601/PF-001



Standard Pause: The standard pause between each movement is two beats in quick time. For example, on the command ABOUT – TURN, combine the two movements. The standard pause shall be observed between the movements:

1. executes the first movement of the turn on the executive order and simultaneously calls out "ONE".
2. after completing the first movement, calls "TWO", "THREE" while observing the standard pause.
3. when executing the final movement, calls out "ONE".

CONFIRMATION OF TEACHING POINT 3

Cadets will execute about turns as a squad.

END OF LESSON CONFIRMATION

The cadet's participation in TP3 will serve as the confirmation of this lesson.

CONCLUSION

HOMEWORK/READING/PRACTICE

N/A.

METHOD OF EVALUATION

In accordance with A-PD-201-000/PT-000, *The Canadian Forces Manual of Drill and Ceremonial*, the cadet shall participate in an Annual Ceremonial Review (ACR) parade. This movement will be used in preparation for, and in the execution of, the ACR parade.

CLOSING STATEMENT

The hallmarks of cadet drill are efficiency, precision, and dignity. These qualities are developed through self-discipline and practice. They lead to unit pride and cohesion. Good drill that is well rehearsed, closely supervised and precise, is an exercise in obedience and alertness. It sets the standard for the execution of any duty, both for the individual and the unit, and builds a sense of confidence between commander and subordinate that is essential to high morale. The personal qualities developed on the parade ground must be maintained in all aspects of life.

INSTRUCTOR NOTES/REMARKS

N/A.

REFERENCES

A0-002 A-PD-201-000/PT-000 DHH 3-2. (2001). *The Canadian Forces Manual of Drill and Ceremonial*. Ottawa, ON: The Department of National Defence.

THIS PAGE INTENTIONALLY LEFT BLANK

DRILL INSTRUCTIONAL TECHNIQUES ASSESSMENT FORM

Cadet's Name: _____

Division: _____

Lesson Topic: _____

Criteria	Comments	Incomplete	Completed With Difficulty	Completed Without Difficulty
PREPARATION				
Maintained dress and deportment.				
Selected an appropriate squad formation.				
Used a lesson plan.				
Reviewed previous lesson.				
INTRODUCTION				
Stated what the cadets will learn.				
Stated why it is important.				
Stated where/when this skill will be applied.				
BODY				
Demonstrated complete movement, calling the time.				
Demonstrated and explained the first part of the movement (Squad 1).				
Had the squad practice the first part of the movement collectively, individually and collectively again.				
Taught the second part of the movement and each subsequent part in the same manner.				
Gave two complete demonstrations.				
Practiced the complete movement with: <ul style="list-style-type: none"> • the instructor calling the time, • the cadets calling the time, and • the cadets judging the time. 				

Criteria	Comments	Incomplete	Completed With Difficulty	Completed Without Difficulty
Used clear words of command and correct pauses.				
Gave appropriate and immediate feedback.				
Allowed questions after each movement.				
END OF LESSON CONFIRMATION				
Demonstrated the movement taught.				
Confirmation was conducted as a squad.				
Emphasized aspects of the movement with which the cadets experienced difficulty.				
CONCLUSION				
Summarized the lesson.				
Re-motivated the cadets.				
FEEDBACK				

 Assessor's Signature

 Date

 Cadet's Signature

CHAPTER 10

PO 311 – PARTICIPATE IN A RECREATIONAL SUMMER BIATHLON ACTIVITY



COMMON TRAINING
PHASE THREE
INSTRUCTIONAL GUIDE



SECTION 1

**EO C311.01 – PRACTICE AIMING AND FIRING THE
 CADET AIR RIFLE FOLLOWING PHYSICAL ACTIVITY**

Total Time:

90 min

PREPARATION

PRE-LESSON INSTRUCTIONS

Resources needed for the delivery of this lesson are listed in the lesson specification located in A-CR-CCP-603/PG-001, Chapter 4. Specific uses for said resources are identified throughout the instructional guide within the TP for which they are required.

Review the lesson content and become familiar with the material prior to delivering the lesson.

PRE-LESSON ASSIGNMENT

N/A.

APPROACH

An interactive lecture was chosen for TPs 1 and 2 to review aiming and firing techniques.

A practical activity was chosen for TPs 3–6 as it is an interactive way to allow the cadets to experience aiming and firing the cadet air rifle following physical activity.

INTRODUCTION

REVIEW

N/A.

OBJECTIVES

By the end of this lesson the cadet shall have practiced aiming and firing the cadet air rifle following physical activity.

IMPORTANCE

It is important for cadets to practice aiming and firing the cadet air rifle following physical activity because these skills are essential to summer biathlon training.

Teaching Point 1**IAW EO C206.02 (Practice Aiming Techniques, A-CR-CCP-602/PF-001, Chapter 6, Section 2), Review Breathing Techniques**

Time: 5 min

Method: Interactive Lecture

Breathing supplies the blood stream with oxygen and eliminates waste elements (such as carbon dioxide) from the blood. While breathing, the oxygen inhaled is used to supply muscles with energy, ensuring optimal potential of the muscles. Just like in sports, controlled breathing can affect marksmanship outcomes.

CONTROLLED BREATHING

Once a stable prone position is established, integrate the principles of controlled breathing. For maximum stability when firing, hold the breath for five to seven seconds. It is very important not to hold the breath for more than seven seconds, as tension will increase in the chest, muscles will lack oxygen and stability will be reduced. When the body lacks oxygen, muscles will quiver and eyesight will be negatively affected.

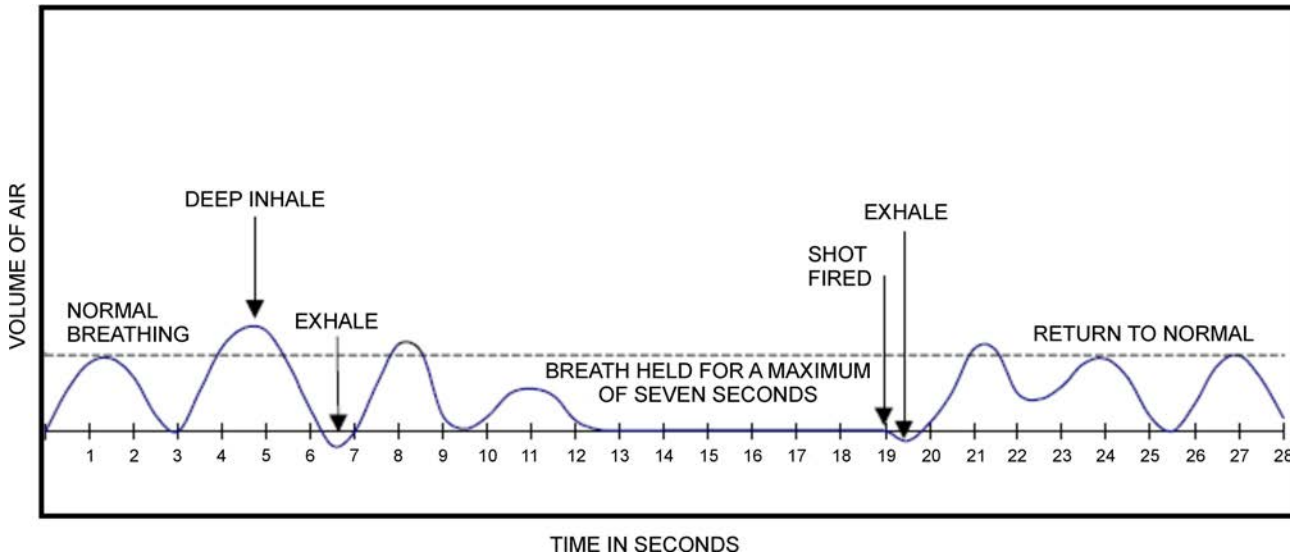

A-CR-CCP-177/PT-001, (p. 1-5-9)

Figure 10-1-1 Marksmanship Breathing Cycle

ACHIEVING A CONTROLLED BREATHING SEQUENCE

The following is the recommended method for achieving a controlled breathing sequence:

1. Adopt the prone position.
2. Relax and breathe normally.
3. Obtain a sight picture.
4. Inhale and exhale deeply.
5. Inhale deeply and exhale normally.
6. Relax the chest muscles, hold a breath for five to seven seconds and squeeze the trigger.
7. Exhale completely and resume normal breathing.

CONFIRMATION OF TEACHING POINT 1

QUESTIONS

- Q1. Breathing supplies the blood stream with what?
- Q2. Oxygen supplies what with energy?
- Q3. For how long should the breath be held while firing?

ANTICIPATED ANSWERS

- A1. Oxygen.
- A2. The muscles.
- A3. Five to seven seconds.

Teaching Point 2

IAW EO C206.03 (Practice Firing Techniques, A-CR-CCP-602/PF-001, Chapter 6, Section 3), Review Natural Sight Alignment

Time: 5 min

Method: Interactive Lecture

Natural alignment describes the direction that the cadet air rifle is aimed when the marksman is in the prone position with the cadet air rifle at the ready. When in a comfortable position, the cadet air rifle should not be forced to point at the target. Even with a perfect prone position and sight alignment, forcing the air rifle can cause muscle tension and will affect the accuracy of each shot.

Natural alignment is obtained by:

- 1. adopting a comfortable prone position;
- 2. acquiring a sight picture;
- 3. closing both eyes;
- 4. taking several normal breaths to relax the muscles;
- 5. looking through sights when comfortable;
- 6. adjusting body position until a proper sight picture is achieved; and
- 7. proceeding to fire.

CONFIRMATION OF TEACHING POINT 2

QUESTIONS

- Q1. What is natural alignment?
- Q2. What can happen if the air rifle is forced to point at the target?
- Q3. What is the first step to obtaining natural alignment?

ANTICIPATED ANSWERS

- A1. The direction that the cadet air rifle is aimed when the marksman is in the prone position with the cadet air rifle at the ready.
- A2. Forcing the air rifle can cause muscle tension and will affect the accuracy of each shot.
- A3. Adopting a comfortable prone position.

Teaching Point 3

Conduct a Warm-Up Session, Composed of Light Cardiovascular Exercises

Time: 5 min

Method: Practical Activity



The following information will be explained to the cadets during the warm-up session.

PURPOSE OF A WARM-UP

A warm-up session is composed of stretches and light cardiovascular exercises designed to:

- stretch the muscles;
- gradually increase respiratory action and heart rate;
- expand the muscles' capillaries to accommodate the increase in blood circulation which occurs during physical activity; and
- raise the muscle temperature to facilitate reactions in muscle tissue.

GUIDELINES FOR STRETCHING

The following guidelines should be followed while stretching to prepare for physical activity and to help prevent injury:

- Stretch all major muscle groups, including the back, chest, legs, and shoulders.
- Never bounce while stretching.
- Hold each stretch for 10–30 seconds to let the muscles release fully.
- Repeat each stretch two to three times.
- When holding a stretch, support the limb at the joint.
- Static stretching, which is stretching a muscle and holding it in position without discomfort for 10–30 seconds, is considered the safest method.
- Stretching helps to relax the muscles and improve flexibility, which is the range of motion in the joints.
- As a guide, allow 10 minutes to warm up for every hour of physical activity.



The stretches chosen should focus on the areas of the body that will be used the most during the physical activity.

ACTIVITY

OBJECTIVE

The objective of this warm-up activity is to stretch the muscles and perform light cardiovascular exercises to prepare the body for physical activity and to help prevent injuries.

RESOURCES

N/A.

ACTIVITY LAYOUT

N/A.

ACTIVITY INSTRUCTIONS

1. Arrange the cadets in either a warm-up circle or in rows (as illustrated in Figures 10-1-2 and 10-1-3).

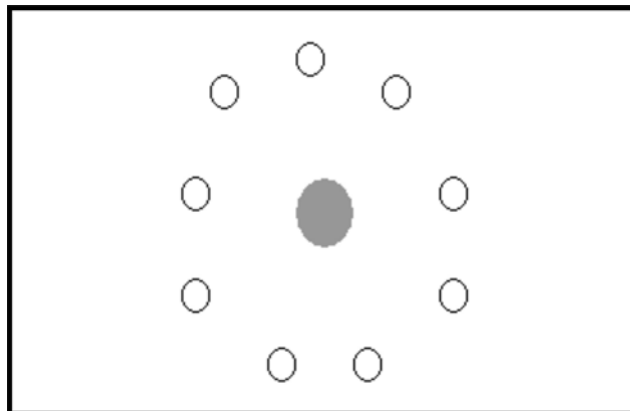

Director Cadets 3, 2006, Ottawa, ON: Department of National Defence

Figure 10-1-2 Instructor in the Centre of a Warm-Up Circle

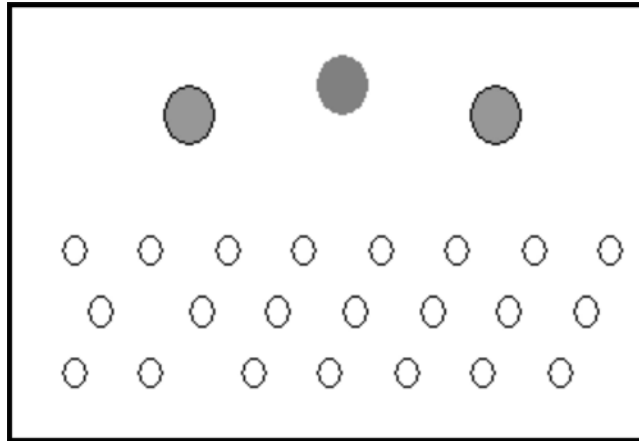

Director Cadets 3, 2006, Ottawa, ON: Department of National Defence

Figure 10-1-3 Instructor at the Front With Two Assistant Instructors

2. Demonstrate before having the cadets attempt each stretch/light cardiovascular exercise.
3. Assistant instructors may help demonstrate the exercises and ensure the cadets are performing them correctly.
4. Have cadets perform each stretch/light cardiovascular exercise.



Light cardiovascular exercises should be done to warm up the muscles prior to stretching to avoid injury to or tearing of the muscles. For example, running on the spot for 30 seconds or performing jumping jacks should be performed prior to conducting the stretches located at Annex A.

SAFETY

- Ensure there are at least two arm lengths between the cadets so they can move freely.
- Ensure the cadets perform the stretches and light cardiovascular exercises in a safe manner, following the guidelines for stretching listed in this TP.

CONFIRMATION OF TEACHING POINT 3

The cadets' participation in the warm-up session will serve as the confirmation of this TP.

Teaching Point 4

Conduct an Activity Where the Cadets Will Aim and Fire the Cadet Air Rifle Following Physical Activity

Time: 60 min

Method: Practical Activity

ACTIVITY

OBJECTIVE

The objective of this activity is to have the cadets aim and fire the cadet air rifle following physical activity, practicing breathing techniques and natural alignment.

RESOURCES

- Cadet air rifles (one per firing lane),
- Safety glasses/goggles (two per firing lane),
- Shooting mats (two per firing lane),
- Biathlon Air Rifle Targets (BARTs) (one per firing lane), and
- Coins (one per firing lane).



If resources are available, the number of firing lanes may be increased.

ACTIVITY LAYOUT

A range IAW A-CR-CCP-177/PT-001, Part 1, Section 8.

ACTIVITY INSTRUCTIONS

1. Divide the cadets into pairs.
2. Have one cadet from each pair run or participate in some sort of activity to elevate their heart rate for five to ten minutes.
3. Have the same cadet from each pair approach the firing point and prepare to fire.
4. Have the cadet adopt the prone position and their partner balance a coin on the barrel of the cadet air rifle, just behind the front sight.
5. While practicing a controlled breathing sequence and natural alignment, the cadet shall dry fire the cadet air rifle while keeping the coin balanced.
6. Circulate throughout the training area and coach the cadets on their breathing techniques and natural alignment.
7. Have the cadets switch positions and repeat steps 2. to 5. until the activity time is complete.

SAFETY

Range activities will be conducted IAW A-CR-CCP-177/PT-001.

CONFIRMATION OF TEACHING POINT 4

The cadets' participation in the activity will serve as the confirmation of this TP.

Teaching Point 5**Conduct a Cool-Down Session, Composed of Light Cardiovascular Exercises**

Time: 5 min

Method: Practical Activity



The following information will be explained to the cadets during the cool-down session.

PURPOSE OF A COOL-DOWN

A cool-down is composed of stretches and light cardiovascular exercises designed to:

- allow the body time to slowly recover from physical activity and to help prevent injury;
- prepare the respiratory system to return to its normal state; and
- stretch the muscles to help relax and restore them to their resting length.



The stretches chosen should focus on the areas of the body that were used the most during the sports activity.

ACTIVITY**OBJECTIVE**

The objective of the cool-down is to stretch the muscles and perform light cardiovascular exercises that allow the body time to recover from physical activity, and to prevent injury.

RESOURCES

N/A.

ACTIVITY LAYOUT

N/A.

ACTIVITY INSTRUCTIONS

1. Arrange the cadets in either a warm-up circle or in rows (as illustrated in Figures 10-1-2 and 10-1-3).
2. Demonstrate before having the cadets attempt each stretch/light cardiovascular exercise.
3. Assistant instructors may help demonstrate the movements and ensure the cadets are performing them correctly.
4. Have cadets perform each stretch/light cardiovascular exercise.

SAFETY

- Ensure there are at least two arm lengths between the cadets so they can move freely.

- Ensure the cadets perform the stretches and light cardiovascular exercises in a safe manner, following the guidelines for stretching listed in TP 3.

CONFIRMATION OF TEACHING POINT 5

The cadets' participation in the cool-down session will serve as the confirmation of this TP.

END OF LESSON CONFIRMATION

The cadets' participation in the activity in TP 4 will serve as the confirmation of this lesson.

CONCLUSION

HOMework/READING/PRACTICE

N/A.

METHOD OF EVALUATION

N/A.

CLOSING STATEMENT

Being able to use breathing techniques and natural alignment while firing following physical activity may help to improve marksmanship skills for summer biathlon.

INSTRUCTOR NOTES/REMARKS

This lesson shall be taught prior to conducting EO C311.02 (Participate in a Recreational Summer Biathlon Activity, Section 2).

REFERENCES

- | | |
|--------|--|
| A0-027 | A-CR-CCP-177/PT-001 Director Cadets 3. (2001). <i>Canadian Cadet Movement: Cadet Marksmanship Program Reference Manual</i> . Ottawa, ON: Department of National Defence. |
| C0-002 | (ISBN 0-88962-630-8) LeBlanc, J., & Dickson, L. (1997). <i>Straight Talk About Children and Sport: Advice for Parents, Coaches, and Teachers</i> . Oakville, ON: Mosaic Press. |
| C0-089 | (ISBN 0-936070-22-6) Anderson, B. (2000). <i>Stretching: 20th Anniversary</i> (Rev. ed.). Bolinas, CA: Shelter Publications, Inc. |
| C0-149 | Biathlon Canada. (2005). <i>Biathlon Bears: Community Coaching</i> . Ottawa, ON: Biathlon Canada. |

THIS PAGE INTENTIONALLY LEFT BLANK



COMMON TRAINING
PHASE THREE
INSTRUCTIONAL GUIDE



SECTION 2

EO C311.02 – PARTICIPATE IN A RECREATIONAL SUMMER BIATHLON ACTIVITY

Total Time:

180 min

PREPARATION

PRE-LESSON INSTRUCTIONS

Resources needed for the delivery of this lesson are listed in the lesson specification located in A-CR-CCP-603/PG-001, Chapter 4. Specific uses for said resources are identified throughout the instructional guide within the TP for which they are required.

Review the lesson content and become familiar with the material prior to delivering the lesson.

Ensure that all members involved in conducting this activity are familiar with the competition guidelines located at Annex B.

Set up a first aid station.

Set up a running route of 1000 m.

Set up a range IAW A-CR-CCP-177/PT-001, Part 1, Section 8.

Photocopy Annexes C, D and E.

PRE-LESSON ASSIGNMENT

N/A.

APPROACH

A practical activity was chosen for this lesson as it is an interactive way for the cadets to participate in recreational summer biathlon. This activity contributes to the development of biathlon skills and knowledge, and promotes physical fitness in a fun and challenging setting.

INTRODUCTION

REVIEW

N/A.

OBJECTIVES

By the end of this lesson the cadet shall have participated in a recreational summer biathlon activity.

IMPORTANCE

It is important for the cadets to participate in a recreational summer biathlon activity because it requires personal discipline, develops marksmanship skills and promotes physical fitness.

Teaching Point 1

Explain the Components of a Recreational Summer Biathlon Activity

Time: 10 min

Method: Practical Activity



Describe the components of the recreational summer biathlon activity. Ensure that the cadets understand the course layout, rules and regulations, scoring, penalties and out of bound areas before the activity is conducted. The cadets should be made aware of the start area, the course, the firing range and the finish area.

COMPOSITION

Cadets will be divided into teams for the summer biathlon activity. For a group of 25 cadets, the cadets should be divided into groups of five.

COURSE LAYOUT

Each cadet will:

- run a route of approximately 1000 m;
- fire five to eight rounds in an effort to knock down all five targets on the biathlon air rifle target (BART);
- run a second route of approximately 1000 m;
- fire five to eight rounds in an effort to knock down all five targets on the BART;
- run a third route of approximately 1000 m; and
- finish the race.



The 1000 m route should be clearly marked prior to the start of this lesson.

RULES AND REGULATIONS

Rules and regulations for the recreational summer biathlon activity include the following:

- The cadets must remain in their own teams throughout the activity.
- The cadets must use the same firing lane for the duration of the activity.
- The run must be completed in the proper sequence and on the marked route.
- Cadet air rifles must be placed at the firing point by the range staff and will remain there for the duration of the activity.
- All firing will be done in the prone position.
- The cadet air rifle must be made safe upon completion of firing.

- An inoperable cadet air rifle will be replaced by the range staff, the target will be reset, and the cadet will fire five to eight rounds with the new cadet air rifle.
- Safety infractions will result in time penalties.
- Missed targets will result in time penalties.

SCORING

The team's final score is determined by adding the total time for all run routes plus any penalties issued. The team with the lowest final score is considered the winning team.

Scoring will be calculated as follows:

- **Time.** The team's final time is the time from the start to finish, and any penalties.
- **Targets.** For each relay of firing, the number of hit and missed targets will be recorded on the range recording sheet by the lane scorekeeper (located at Annex C). There is no positive point value for each hit target; competitors will be deducted points for each missed target.

PENALTIES

The following penalties will be added to the team's time:

- Each violation of the principles of fair play or good sportsmanship will result in a one-minute penalty, to include:
 - not giving way in an area of congestion;
 - pushing or shoving;
 - using profanity; and
 - interfering with other competitors.
- Each missed target will result in a 10-second penalty.
- Each safety infraction on the firing point will result in a two-minute penalty, to include:
 - not keeping control of the cadet air rifle;
 - moving forward of the firing point; and
 - intentionally firing rounds at objects other than the BART.
- Each team member that does not cross the finish line will receive a two-minute penalty.

OUT OF BOUNDS AREAS

Make cadets aware of all out of bounds areas and safety considerations depending on the training area.

CONFIRMATION OF TEACHING POINT 1

QUESTIONS

- Q1. What are two rules/regulations for this recreational summer biathlon activity?
- Q2. How will the recreational summer biathlon activity be scored?
- Q3. What is one violation of the principles of fair play/good sportsmanship?

ANTICIPATED ANSWERS

A1. Rules and regulations for the recreational summer biathlon activity include the following:

- The cadets must remain in their own teams throughout the activity.
- The cadets must use the same firing lane for the duration of the activity.
- The run must be completed in the proper sequence and on the marked route.
- Cadet air rifles must be placed at the firing point by the range staff and will remain there for the duration of the activity.
- All firing will be done in the prone position.
- The cadet air rifle must be made safe upon completion of firing.
- An inoperable cadet air rifle will be replaced by the range staff, the target will be reset, and the cadet will fire five to eight rounds with the new rifle.
- Safety infractions will result in time penalties.
- Missed targets will result in time penalties.

A2. The activity will be scored based on time and penalties.

A3. Violations of the principles of fair play/good sportsmanship include:

- not giving way in an area of congestion;
- pushing or shoving;
- using profanity; and
- interfering with other competitors.

Teaching Point 2

Conduct a Warm-Up Session Composed of Light Cardiovascular Exercises

Time: 10 min

Method: Practical Activity



The following information will be explained to the cadets during the warm-up session.

PURPOSE OF A WARM-UP

A warm-up session is composed of stretches and light cardiovascular exercises designed to:

- stretch the muscles;
- gradually increase respiratory action and heart rate;
- expand the muscles' capillaries to accommodate the increase in blood circulation which occurs during physical activity; and
- raise the muscle temperature to facilitate reactions in muscle tissue.

GUIDELINES FOR STRETCHING

The following guidelines should be followed while stretching to prepare for physical activity and to help prevent injury:

- Stretch all major muscle groups, including the back, chest, legs, and shoulders.
- Never bounce while stretching.
- Hold each stretch for 10–30 seconds to let the muscles release fully.
- Repeat each stretch two to three times.
- When holding a stretch, support the limb at the joint.
- Static stretching, which is stretching a muscle and holding it in position without discomfort for 10–30 seconds, is considered the safest method.
- Stretching helps to relax the muscles and improve flexibility, which is the range of motion in the joints.
- As a guide, allow 10 minutes to warm up for every hour of physical activity.



The stretches chosen should focus on the areas of the body that will be used the most during the physical activity.

ACTIVITY

OBJECTIVE

The objective of this warm-up activity is to stretch the muscles and perform light cardiovascular exercises to prepare the body for physical activity and to help prevent injuries.

RESOURCES

N/A.

ACTIVITY LAYOUT

N/A.

ACTIVITY INSTRUCTIONS

1. Arrange the cadets in either a warm-up circle or in rows (as illustrated in Figures 10-2-1 and 10-2-2).

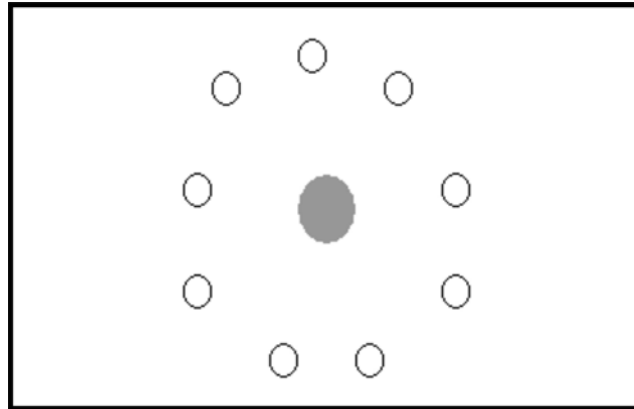

Director Cadets 3, 2006, Ottawa, ON: Department of National Defence

Figure 10-2-1 Instructor in the Centre of a Warm-Up Circle

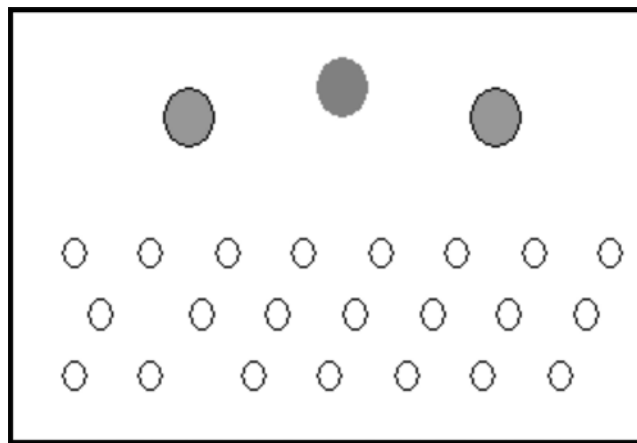

Director Cadets 3, 2006, Ottawa, ON: Department of National Defence

Figure 10-2-2 Instructor at the Front with Two Assistant Instructors

2. Demonstrate before having the cadets attempt each stretch/light cardiovascular exercise.
3. Assistant instructors may help demonstrate the exercises and ensure the cadets are performing them correctly.
4. Have cadets perform each stretch/light cardiovascular exercise.



Light cardiovascular exercises should be done to warm up the muscles prior to stretching to avoid injury to or tearing of the muscles. For example, running on the spot for 30 seconds or performing jumping jacks should be performed prior to conducting the stretches located at Annex A.

SAFETY

- Ensure there are at least two arm lengths between the cadets so they can move freely.
- Ensure the cadets perform the stretches and light cardiovascular exercises in a safe manner, following the guidelines for stretching listed in this TP.

CONFIRMATION OF TEACHING POINT 2

The cadets' participation in the warm-up session will serve as the confirmation of this TP.

Teaching Point 3

Conduct a Recreational Summer Biathlon Activity

Time: 140 min

Method: Practical Activity

ACTIVITY

OBJECTIVE

The objective of this activity is to have the cadets participate in a recreational summer biathlon activity.

RESOURCES

Based on 25 cadets per group, the equipment required to conduct the recreational summer biathlon activity shall include, but is not limited to, the following:

- Cadet air rifles (6),
- Shooting mats (10),
- Air rifle pellets (a minimum of 875 pellets),
- Container to hold pellets (5),
- Stopwatches (6),
- BART (5),
- Safety glasses/goggles (10),
- Notice board,
- Biathlon scoresheets located at Annex C,
- Course control sheets located at Annex D, and
- Range recording sheets located at Annex E.

ACTIVITY LAYOUT

- Set up a first aid station.
- Set up a running route of approximately 1000 m.
- Set up an air rifle range IAW A-CR-CCP-177/PT-001, Part 1, Section 8, with a minimum of five lanes for 25 cadets.
- Set up BARTs.
- Place two shooting mats per firing lane (a minimum of five firing lanes for 25 cadets).
- Place a cadet air rifle at each firing point.
- Place a pair of safety glasses/goggles at each firing point.

ACTIVITY INSTRUCTIONS

Activity instructions are located at Annex B.

SAFETY

- Ensure all range safety procedures are followed.
- Ensure cadets drink fluids and apply sunscreen.
- Ensure the running route is clearly marked and crossing points are monitored anywhere a road may be crossed.
- Ensure a first-aider is identified at the start of the activity and is available at all times.
- Ensure water is available for the cadets during and after the activity.

CONFIRMATION OF TEACHING POINT 3

The cadets' participation in the activity will serve as the confirmation of this TP.

Teaching Point 4

Conduct a Cool-Down Session Composed of Light Cardiovascular Exercises

Time: 10 min

Method: Practical Activity



The following information will be explained to the cadets during the cool-down session.

PURPOSE OF A COOL-DOWN

A cool-down is composed of stretches and light cardiovascular exercises designed to:

- allow the body time to slowly recover from physical activity and to help prevent injury;
- prepare the respiratory system to return to its normal state; and
- stretch the muscles to help relax and restore them to their resting length.



The stretches chosen should focus on the areas of the body that were used the most during the sports activity.

ACTIVITY

OBJECTIVE

The objective of the cool-down is to stretch the muscles and perform light cardiovascular exercises that allow the body time to recover from physical activity, and to prevent injury.

RESOURCES

N/A.

ACTIVITY LAYOUT

N/A.

ACTIVITY INSTRUCTIONS

1. Arrange the cadets in either a warm-up circle or in rows (as illustrated in Figures 10-2-1 and 10-2-2).
2. Demonstrate before having the cadets attempt each stretch/light cardiovascular exercise.
3. Assistant instructors may help demonstrate the movements and ensure the cadets are performing them correctly.
4. Have cadets perform each stretch/light cardiovascular exercise.

SAFETY

- Ensure there are at least two arm lengths between the cadets so they can move freely.
- Ensure the cadets perform the stretches and light cardiovascular exercises in a safe manner, following the guidelines for stretching listed in TP 1.

CONFIRMATION OF TEACHING POINT 4

The cadets' participation in the cool-down session will serve as the confirmation of this TP.

END OF LESSON CONFIRMATION

The cadets' participation in a recreational summer biathlon activity will serve as the confirmation of this lesson.

CONCLUSION

HOMEWORK/READING/PRACTICE

N/A.

METHOD OF EVALUATION

N/A.

CLOSING STATEMENT

Recreational summer biathlon is an activity that requires personal discipline, develops marksmanship skills and promotes physical fitness. Participation in a recreational summer biathlon activity may improve personal fitness level.

INSTRUCTOR NOTES/REMARKS

EO C311.01 (Practice Aiming and Firing the Cadet Air Rifle Following Physical Activity, Section 1) shall be taught prior to conducting this activity.

REFERENCES

A0-027 A-CR-CCP-177/PT-001 Directorate of Cadets 3. (2001). *Cadet Marksmanship Program: Reference Manual*. Ottawa, ON: Department of National Defence.



- A0-036 Cadets Canada. (n.d.). *Canadian Cadet Movement: Biathlon Championship Series*. Ottawa, ON: Department of National Defence.
- A0-098 Directorate Cadets 4. (2007). CATO 14-42, *Biathlon Common Program*. Ottawa, ON: Department of National Defence.
- C0-002 (ISBN 0-88962-630-8) LeBlanc, J., & Dickson, L. (1997). *Straight Talk About Children and Sport: Advice for Parents, Coaches, and Teachers*. Oakville, ON: Mosaic Press.
- C0-089 (ISBN 0-936070-22-6) Anderson, B. (2000). *Stretching: 20th Anniversary* (Rev. ed.). Bolinas, CA: Shelter Publications, Inc.

SAMPLE STRETCHES

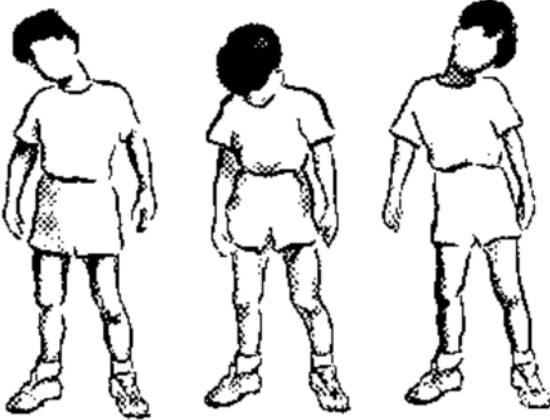
a. Neck:

 <p><i>B. Hanson, Moving on the Spot: A Collection of 5 Minute Stretch and Movement Sessions, Toronto Public Health. Retrieved October 26, 2006, from http://www.lin.ca/resource/html/dn3.htm#1</i></p> <p>Figure 10A-1 Neck Stretch</p>	<p>Slowly roll your head across your chest from shoulder to shoulder. Do not roll your head backwards.</p>
---	--

b. Shoulders:

 <p><i>B. Hanson, Moving on the Spot: A Collection of 5 Minute Stretch and Movement Sessions, Toronto Public Health. Retrieved October 26, 2006, from http://www.lin.ca/resource/html/dn3.htm#1</i></p> <p>Figure 10A-2 Shoulder Push</p>	<p>Stand and extend your arms behind you, interlocking your fingers. Push up and back with your shoulders.</p> <p>Hold this position for a minimum of 10 seconds.</p>
 <p><i>B. Hanson, Moving on the Spot: A Collection of 5 Minute Stretch and Movement Sessions, Toronto Public Health. Retrieved October 26, 2006, from http://www.lin.ca/resource/html/dn3.htm#1</i></p> <p>Figure 10A-3 Shoulder Shrug</p>	<p>Stand and raise your shoulders as high as possible and then lower your shoulders, stretching your neck up.</p> <p>Pull your shoulders back as far as possible and then round your shoulders forward by pushing your shoulders forward as far as possible.</p> <p>Hold each position for a minimum of 10 seconds.</p>



Warm Ups, by Martha Jefferson Hospital, Copyright 2001 by Martha Jefferson Hospital. Retrieved October 26, 2006, from <http://www.marthajefferson.org/warmup.php>

Figure 10A-4 Arm Circles

Hold your arms straight out, palms up. Make small circles with your arms, gradually increasing the size.

Reverse the direction of your circles.



Smart Start: A Flexible Way to Get Fit. Retrieved October 26, 2006, from <http://www.in-motion.ca/walkingworkout/plan/flexibility/>

Figure 10A-5 Shoulder Stretch

Either standing or sitting, take your right arm in your left hand and bring it across your chest, supporting the joint by holding it behind the elbow. Pull lightly on the elbow towards your chest. You should feel the stretch in your right shoulder.

Hold this position for a minimum of 10 seconds and repeat on the opposite side.

c. Arms:



Exercises. Copyright 1998 by Impacto Protective Products Inc. Retrieved October 26, 2006, from <http://www.2protect.com/home.htm>

Figure 10A-6 Wrist Rotations

Rotate your hands in circular motions at the wrist.

Change direction and repeat on both sides.



Smart Start: A Flexible Way to Get Fit. Retrieved October 26, 2006, from <http://www.in-motion.ca/walkingworkout/plan/flexibility/>

Figure 10A-7 Triceps Stretch

Stand and bring your right arm over your head, bent at the elbow. Use your left hand to gently pull your arm down.

Hold this position for a minimum of 10 seconds and repeat on the opposite side.



Exercise Programme for Squash, Tennis, Softball, Handball. Retrieved October 26, 2006, from <http://www.physionline.co.za/conditions/article.asp?id=49>

Figure 10A-8 Forearm Stretch

In a kneeling position, place your hands on the floor in front of you turned so that your fingers are pointing toward your knees, and your thumbs are pointing out. Keeping your hands flat on the floor, lean back.
Hold this position for a minimum of 10 seconds.

d. Chest and Abdominals:



Smart Start: A Flexible Way to Get Fit. Retrieved October 26, 2006, from <http://www.in-motion.ca/walkingworkout/plan/flexibility/>

Figure 10A-9 Chest Stretch

Stand facing a wall. With your right arm bent and your elbow at shoulder height, place your palm against the wall. Turn your body away from your right arm. You should feel the stretch on the front side of your armpit and across the front of your chest.

Hold this position for a minimum of 10 seconds and repeat on the opposite side.



B. Hanson, Moving on the Spot: A Collection of 5 Minute Stretch and Movement Sessions, Toronto Public Health. Retrieved October 26, 2006, from <http://www.lin.ca/resource/html/dn3.htm#1>

Figure 10A-10 Side Stretch

Stand with your left arm up over your head. Bend at your waist towards the right side of your body.

Hold this position for a minimum of 10 seconds and repeat on the opposite side.

e. Back:



Smart Start: A Flexible Way to Get Fit. Retrieved October 26, 2006, from <http://www.in-motion.ca/walkingworkout/plan/flexibility/>

Figure 10A-11 Lower Back Stretch

Lie on your back and bring your knees toward your chest. Grasp the back of your knees.
Hold this position for a minimum of 10 seconds.

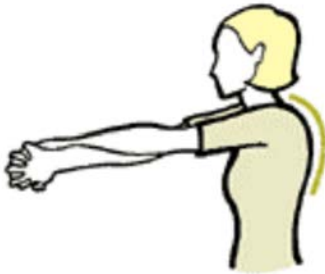

Smart Start: A Flexible Way to Get Fit. Retrieved October 26, 2006, from <http://www.in-motion.ca/walkingworkout/plan/flexibility/>

Figure 10A-12 Upper Back Stretch

Extend your arms straight in front of you at shoulder height crossing one arm over the other. With the palms facing each other, intertwine your fingers and press out through your arms. Let your chin fall to your chest as you exhale. You should feel the stretch in the upper back.

Hold this position for a minimum of 10 seconds and repeat on the opposite side.

f. Legs:



Smart Start: A Flexible Way to Get Fit. Retrieved October 26, 2006, from <http://www.in-motion.ca/walkingworkout/plan/flexibility/>

Figure 10A-13 Hamstring Stretch

Lie flat on the floor with your knees bent and your back flat on the floor. Slowly raise and straighten one leg, grasping it behind your thigh with both hands.
Hold this position for a minimum of 10 seconds.



Smart Start: A Flexible Way to Get Fit. Retrieved October 26, 2006, from <http://www.in-motion.ca/walkingworkout/plan/flexibility/>

Figure 10A-14 Inner Thigh Stretch

Sit on the floor with your knees bent and the soles of your feet together. Grab your toes and pull yourself forward while keeping your back and neck straight.

Hold this position for a minimum of 10 seconds.

Grab your ankles and push your knees down toward the floor with your elbows.

Hold this position for a minimum of 10 seconds.



Smart Start: A Flexible Way to Get Fit. Retrieved October 26, 2006, from <http://www.in-motion.ca/walkingworkout/plan/flexibility/>

Figure 10A-15 Hip Flexor

Kneel on your right knee. Position your left foot in front of you, bending your knee and placing your left hand on that leg for stability. Keep your back straight and abdominal muscles tight. Lean forward, shifting more body weight onto your front leg. You should feel the stretch in the front of your hip and the thigh of the leg you are kneeling on. Cushion your kneecap with a folded towel if necessary.

Hold this position for a minimum of 10 seconds and repeat on the opposite side.



Running Exercises. Retrieved October 26, 2006, <http://www.physionline.co.za/conditions/article.asp?id=46>

Figure 10A-16 Ankle Rotations

From a sitting position, rotate your foot in a clockwise, and then a counter-clockwise, direction.

Switch and repeat on the opposite side.



Smart Start: A Flexible Way to Get Fit. Retrieved October 26, 2006, from <http://www.in-motion.ca/walkingworkout/plan/flexibility/>

Figure 10A-17 Calf Stretch

Stand three steps away from and facing a wall. Step in towards the wall with your right leg, bending your right knee and keeping your left leg straight. Extending your arms with your palms forward, reach out to the wall and let your body fall toward the wall. Keep your toes forward and your heels down. Lean your body into the wall with your left leg straight behind your body. You should feel the stretch in your left calf.

Hold this position for a minimum of 10 seconds and repeat on the opposite side.



Smart Start: A Flexible Way to Get Fit. Retrieved October 26, 2006, from <http://www.in-motion.ca/walkingworkout/plan/flexibility/>

Figure 10A-18 Quadriceps Stretch

Stand with your hand against a wall for balance. Lift your left foot off the ground, bending your knee as if you are trying to kick your bottom with your heel. Do not lean forward at the hips. Grab and hold your ankle with your left hand. You should feel the stretch in your left thigh.

Hold this position for a minimum of 10 seconds and repeat on the opposite side.

GUIDELINES TO CONDUCT A RECREATIONAL SUMMER BIATHLON ACTIVITY

OBJECTIVES

The objectives of the recreational summer biathlon activity are:

- to practice and improve marksmanship skills;
- to improve personal fitness level; and
- to introduce the cadets to the sport of summer biathlon.

COMPOSITION

Cadets will be divided into teams for the summer biathlon activity. For a group of 25 cadets, the cadets should be divided into groups of five.

FACILITIES

The facilities required to conduct a recreational summer biathlon activity are:

- a route, approximately 1000 m with the start and finish lines located close to the range. The route should be wide enough to accommodate a maximum of 10 cadets running at one time. When roads are to be crossed, they must be clearly marked and a central crossing point established with traffic control provided, and

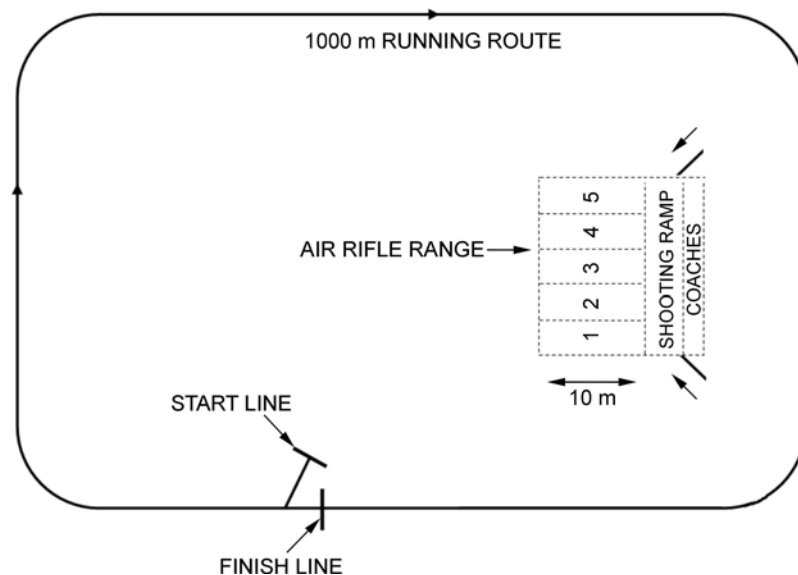

Director Cadets 3, 2008, Ottawa, ON: Department of National Defence

Figure 10B-1 Recreational Summer Biathlon Activity Course Layout

- an air rifle range constructed IAW A-CR-CCP-177/PT-001, Part 1, Section 8, with a minimum of one firing lane per cadet per group.

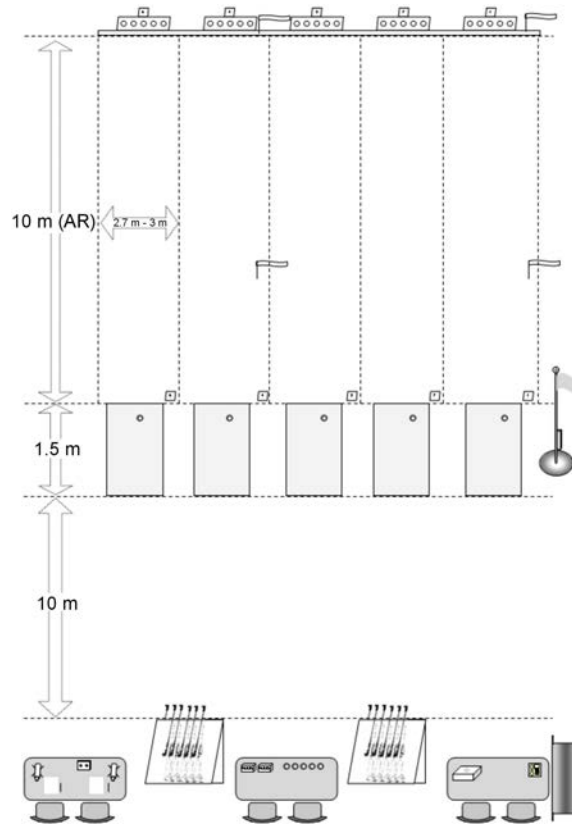

Director Cadets 3, 2008, Ottawa, ON: Department of National Defence

Figure 10B-2 Recreational Summer Biathlon Air Rifle Range Layout

STAFFING

Numerous staff are required to conduct a recreational summer biathlon activity. These appointments shall include:

- **Technical Delegate.** Responsible for the overall conduct of the competition, including issuing penalties, and interpreting the rules.
- **Range Safety Officer (RSO).** Responsible for the overall conduct of the activities on the range.
- **Assistant RSO.** Responsible for targets, issuing ammunition, and assisting the RSO, as required.
- **Lane Scorekeeper.** Responsible for scoring targets and recording results on the range recording sheet (located at Annex E).
- **Chief of Statistics.** Responsible for compiling all the event data (e.g., range results, start/finish time, and any penalties assessed).
- **Runner.** Responsible for collecting the scoring sheets and delivering them to the chief of statistics.
- **Start and Finish Line Chief.** Responsible for starting the run and recording the finish times on the scoresheet (located at Annex C).
- **Course Controller.** Responsible for recording each time the cadet runs a route on the course control sheet (located at Annex D).
- **First-Aider.** Responsible for dealing with any injuries that may occur during the competition.

FORMAT

Briefing

All cadets will attend an initial briefing. This will include the essential information required by the cadets to participate in the recreational summer biathlon activity. The cadets are given:

- start times,
- range lane assignments,
- weather updates, and
- an introduction to the competition staff.

The Running Route

Each cadet will run three separate routes of approximately 1000 m. Each running route will consist of:

- each team assembling for a mass start (teams will have a two-minute interval between start times);
- each team finishing as a complete team; and
- crossing the finish line as a team.

The Range

Each cadet will fire five to eight pellets in an effort to knock down all five targets on the BART. After each bout of firing, the appropriate lane scorer will record the team's results and reset the BART.

When all members of the team have completed firing, they will re-assemble for a mass start for the next running route.

SEQUENCE

This recreational summer biathlon activity will be conducted in the following sequence:

- running a route of approximately 1000 m;
- firing five to eight pellets at the BART;
- running a route of approximately 1000 m;
- firing five to eight pellets at the BART;
- running a third route of approximately 1000 m; and
- crossing the finish line.

EQUIPMENT

Based on 25 cadets, the equipment required to conduct the recreational summer biathlon activity shall include, but is not limited to, the following:

- Cadet air rifles (6),
- Shooting mats (10),
- Air rifle pellets (a minimum of 875 pellets),
- Container to hold pellets (5),
- Stopwatches (6),

- BART (5),
- Safety glasses/goggles (10),
- Notice board,
- Biathlon scoresheets located at Annex C,
- Course control sheets located at Annex D, and
- Range recording sheets located at Annex E.

DRESS

Appropriate clothing according to the weather forecast.

RULES AND REGULATIONS

- The cadets must remain in their own teams throughout the activity
- The cadets must use the same firing lane for the duration of the activity.
- The run must be completed in the proper sequence and on the marked route.
- Cadet air rifles must be placed on the firing point by the range staff and will remain there for the duration of the activity.
- All firing will be done in the prone position.
- The cadet air rifle must be made safe upon completion of firing.
- An inoperable cadet air rifle will be replaced by the range staff, the target will be reset, and the cadet will fire five to eight rounds with the new rifle.
- Safety infractions will result in time penalties.
- Missed targets will result in time penalties.

SCORING

The team's final score is determined by adding the total time for all run routes plus any penalties issued. The team with the lowest final score is considered the winning team.

Scoring will be calculated as follows:

- **Time.** The team's final time is the time from the start to finish, and any penalties.
- **Targets.** For each relay of firing, the number of hit and missed targets will be recorded on the range recording sheet by the lane scorekeeper (located at Annex C). There is no positive point value for each hit target; competitors will be deducted points for each missed target.

PENALTIES

The following penalties will be added to the team's time:

- Each violation of the principles of fair play or good sportsmanship will result in a one-minute penalty, to include:
 - not giving way in an area of congestion;
 - pushing or shoving;
 - using profanity; and
 - interfering with other competitors.

- Each missed target will result in a 10-second penalty.
- Each safety infraction on the firing point will result in a two-minute penalty, to include:
 - not keeping control of the cadet air rifle;
 - moving forward of the firing point; and
 - intentionally firing rounds at objects other than the BART.
- Each team member not crossing the finish line will result in a two-minute penalty.

OUT OF BOUNDS AREA

Out of bounds areas will be clearly identified prior to the start of the recreational summer biathlon activity.

NOTES

- Course control staff will record each time a team completes a route. See course control sheet located at Annex D.
- The start and finish line chief will keep records for each team. When the sheet is full or nearly full the runner will take the sheet to the chief of statistics. See scoresheet located at Annex C.
- Bibs may be used to identify cadets, if available.

THIS PAGE INTENTIONALLY LEFT BLANK

THIS PAGE INTENTIONALLY LEFT BLANK

THIS PAGE INTENTIONALLY LEFT BLANK

THIS PAGE INTENTIONALLY LEFT BLANK