

Ezekiel 4.

The master key to unlock the Bible's chronology

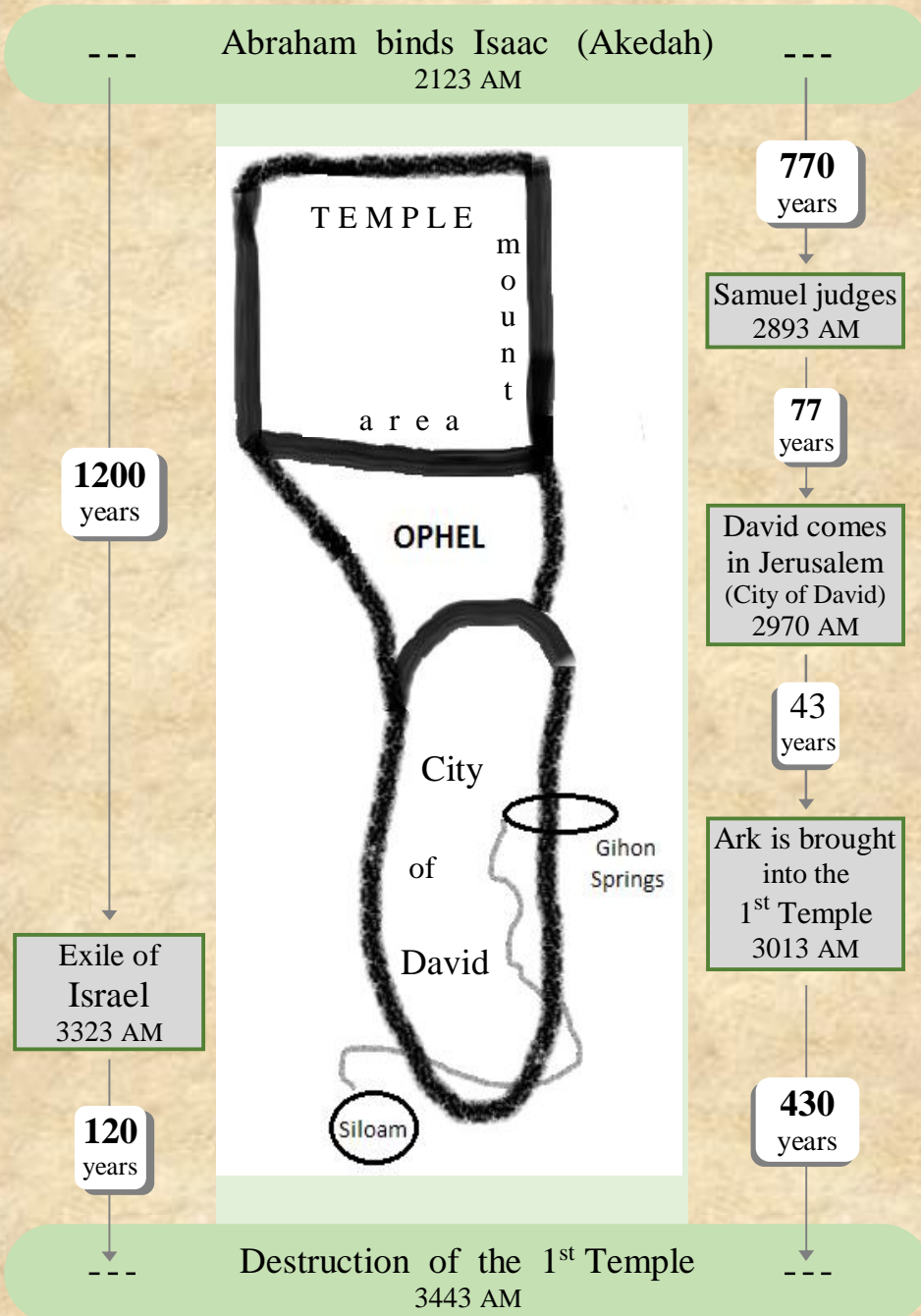

If the only achievement of this book was the uncovering of this pattern, I would be satisfied. But there is so much more..

Yves Peloquin



"Make the mind of this people dull, and stop their ears, and shut their eyes, so that they may not look with their eyes, and listen with their ears, and comprehend with their minds, and turn and be healed."

Isaiah 6:10

It is the glory of God to conceal a matter;
to search out a matter is the glory of kings.

Prov 25:2 NIV

Dédié à Marie-Paule mon épouse, sans
qui je n'aurais jamais pu m'investir avec
autant d'énergie dans cette recherche, et
à mes trois enfants :

Jeanne, Émile, Évelyne
qui ont si souvent été privés de ma
présence.

Also dedicated to my father Leo
(1921-1994 AD) from whom I learned the
names of Jacob's children. I believe he
was one of the great...great grandsons of
Leah, first wife of the patriarch Jacob.



The First Part

INTRODUCTION	page 4
The house of Judah sin that lasted 40 days (years)	page 12
The house of Israel sin that lasted 390 days (years)	page 16
A siege that last 430 days (390 days + 40 days)	page 26
Why an iron wall	page 34
Left side/Right side	page 38
The feeding of Ezekiel during his siege	page 43
The need to have Ezekiel tied up	page 45
Prophesying against the siege of Jerusalem	page 50
Ezekiel's bare arm	page 61
Ezekiel eating defiled food	page 70
430 years and 400 years to Exodus	page 79
Ezekiel shaves his hair	page 91
Ezekiel is weighing and dividing the hair	page 99
Ezekiel's hair growing again	page 107
Daniel 70-week & post exile chronology	page 116
Ezekiel's fasting	page 133
Ezekiel's famine of words	page 136
Conclusion of first part	page 142

Second Part

Setting a true chronology of the Bible	page 143
The timeline of Joseph	page 144
Sabbath and Jubilee	page 149
Yeshua's ministry	page 152
The time of Joshua	page 162
Oppressions and Judges	page 165
Pilgrimage of fathers and sons	page 179
When did Abraham marry	page 181
Did the Israelites wait 19 y. in Kadesh Barnea?	page 177
Understanding Judah & Israel EXILE	page 182
From Babel to Daniel's 70 th week	page 194
Numbers 37-73 and the timing of Samson	page 195
Was Solomon 17 years old when he became king?	page 196
Unseal chronological patterns in 28 charts	page 197
Conclusion of second part	page 226
Appendix A From Adam to Abraham (the basic timeline)	page 229
Appendix B Abraham's family tree	page 232
Appendix C Akedah Exodus Crucifixion	page 235
Appendix D Synchronizing the calendar	page 256
Appendix E The Bible's timeline	page 257
Appendix F Hidden link between 3443 and 3993	page 266
Appendix G Daniel 8:14 '2300 evenings & mornings' ..	page 267
Appendix H Daniel 12:11-12 1,290 days & 1,335 days	page 270
Appendix I Daniel 70 th week	page 271
Appendix J King of Israel	page 279
Appendix K 77 People of authority (11 + 22 + 44)	page 280
Appendix L The 12 symbolical acts of Ezekiel 4-5	page 281

The master key to unlock the Bible's chronology

By Yves Peloquin
Montréal, Canada

<http://www.EzekielMasterKey.com>

Created Dec 2004

Last update Aug 29, 2016
(Year **5978 AM**)

Several solutions have been proposed to explain the 390 and the 40 years symbolized by Ezekiel's 390 and 40 days. None has been very convincing, so far.

The following observation is therefore indisputable: in spite of the fact that Ezekiel spent a very long period of 430 days on his sides to perform his sign, no one has ever come up with any hidden interpretation that could match (and justify) the prophet's amazing task? This paper shall propose a fresh new way to understand Ezekiel 4.

The Siege of Jerusalem prophesied

Ezek 4:1-13

4:1 "Now, son of man, take a clay tablet, put it in front of you and draw the city of Jerusalem on it. 2 Then lay siege to it: Erect siege works against it, build a ramp up to it, set up camps against it and put battering rams around it. 3 Then take an iron pan, place it as an iron wall between you and the city and turn your face toward it. It will be under siege, and you shall besiege it. This will be a sign to the house of Israel. 4 "Then lie on your left side and put the sin of the house of Israel upon yourself. You are to bear their sin for the number of days you lie on your side. 5 I have assigned you the same number of days as the years of their sin. So for 390 days you will bear the sin of the house of Israel. 6 "After you have finished this, lie down again, this time on your right side, and bear the sin of the house of Judah. I have assigned you 40 days, a day for each year. 7 Turn your face toward the siege of Jerusalem and with bare arm prophesy against her. 8 I will tie you up with ropes so that you cannot turn from one side to the other until you have finished the days of your siege. 9 "Take wheat and barley, beans and lentils, millet and spelt; put them in a storage jar and use them to make bread for yourself. You are to eat it during the 390 days you lie on your side. 10 Weigh out twenty shekels of food to eat each day and eat it at set times. 11 Also measure out a sixth of a hin of water and drink it at set times. 12 Eat the food as you would a barley cake; bake it in the sight of the people, using human excrement for fuel." 13 The LORD said, "In this way the people of Israel will eat defiled food among the nations where I will drive them."

It is indisputable that some important chronological information can be obtained by correctly interpreting the sign performed by Ezekiel. After all, we already know that when he was lying for 390 and 40 days, he was then symbolically portraying one period of sin that lasted 390 years and another that lasted 40 years. No doubts that these two values will lead us to the discovery of some solid markers in the Bible chronology once we have them correctly understood.

But there is more information to be obtained from Ezek 4-5 than what has been suggested until now. We will see in the following pages that while he was lying on his sides Ezekiel was performing more than a dozen different symbolical acts each one portraying an independent set of events that had or would take place over distinct periods of either 390, 40, or 430 years.

From a few basic sequences of events whose timeline are well known, we are going to, while identifying each Ezekiel 4-5 symbolical act, find out the timing of every **meaningful biblical event**.

Figuratively speaking, this book has been designed like a ladder. Where each rung allow a workman to go higher and higher, here most chapters will introduce a new Ezekiel 4-5 symbolical act and consolidate it by using the chronological information validated in the previous chapters. As we move on, several paths of reliable events will keep expanding until it becomes possible to merge them into a tightly interconnected network.

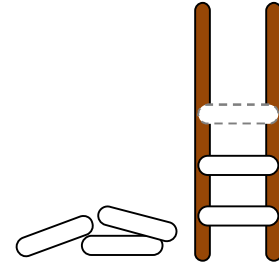

A unique feature pertaining to the development of this work will be obvious in the first part of the book. No biblical event will be associated to a specific date! Instead, each event will be featured by its relationship with the other relative **dating**. Similar to what is done in the bible's narration the emphasis will be exclusively over the length of time separating the events between themselves (**relative dating**). This approach will be very destabilizing for many readers who would have preferred the obvious comfort obtained by manipulating dates.

Unfortunately, once the chronology of the patriarchs has been figured out it is impossible to move on in a straight manner to reach the time of Moses, Aaron, Joshua and Caleb. It quickly become apparent that the bible chronology should then be handled like a jigsaw puzzle where it is sometime more advantageous to solve different area according their color or form before trying to fit them in the main picture.



In the second part of the book, dates will be anchored to each biblical event (**absolute dating**). This is a prerequisite to adequately discuss about the occurrence of the sabbatical years, highlight some palindromic dates (like 3443 AM for the destruction of the first Temple), to project the likely timing of the re-emergence of the Lost-Tribes of Israel in the future, and of course to produce the detailed biblical timeline expected in this kind of work.

In the end more than 180 biblical events will have been firmly dated and hopefully presented in many spectaculars patterns. Truly, never before was a biblical chronology elaborated around so many markers and with such an abundance of **self-validating mechanisms**.

I just mentioned that this chronology will display some spectacular patterns. In fact patterns are a major outcome of this chronology. They come in so many forms and they involve so many events that one could ask ourselves: Why were all those events inscribed in such a vast network of patterns? The obvious answer is that the patterns, by their sole presence, are a proof of the accuracy of the dates leading to them. Given that a random set of dates would rarely lead to an harmonious and spectacular pattern, finding a large number of them, interacting between each other, compels us to accept the involvement of a Master Designer.

Let's start with four examples of spectacular patterns to show evidence of design.

First example: The age of the last four patriarchs / followed by my own 2000 years pattern

Abraham	175	Gen 25:7
Isaac	180	Gen 35:28
Jacob	147	Gen 47:28
Joseph	110	Gen 50:26

Part of the following was observed by Stanley Gevirtz in an article called 'The Life Spans of Joseph and Enoch and the Parallelism'

Here the age of these four closely related and most central patriarchs of the Bible are used to produce the following mathematical relationship.

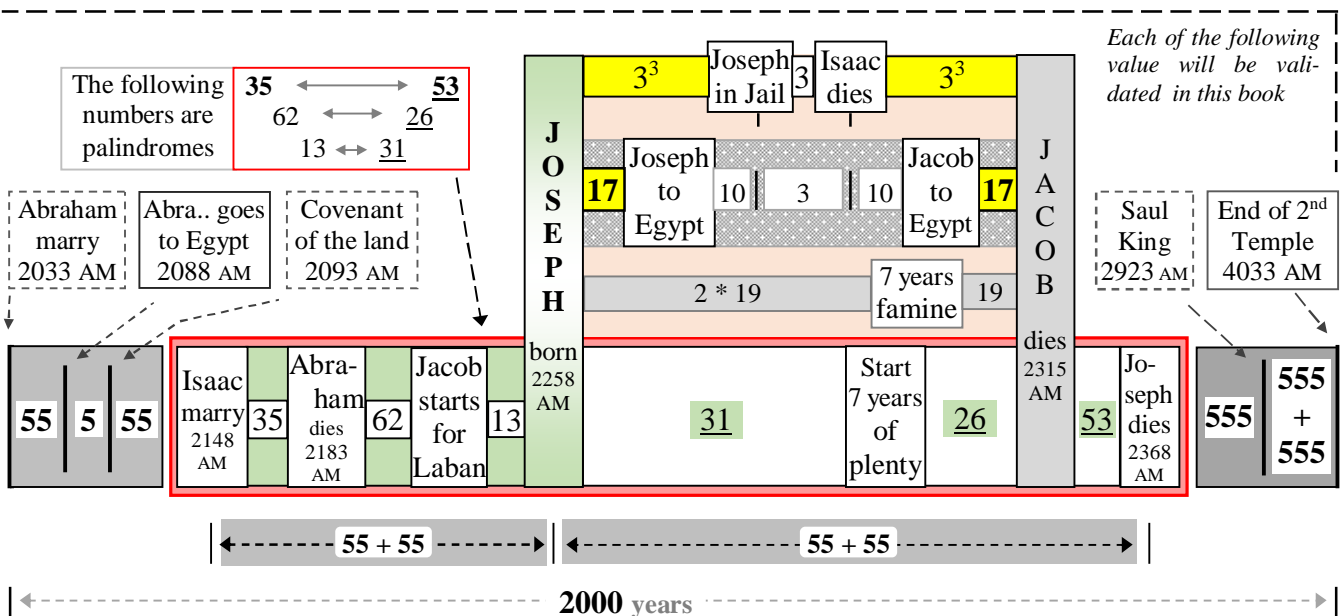
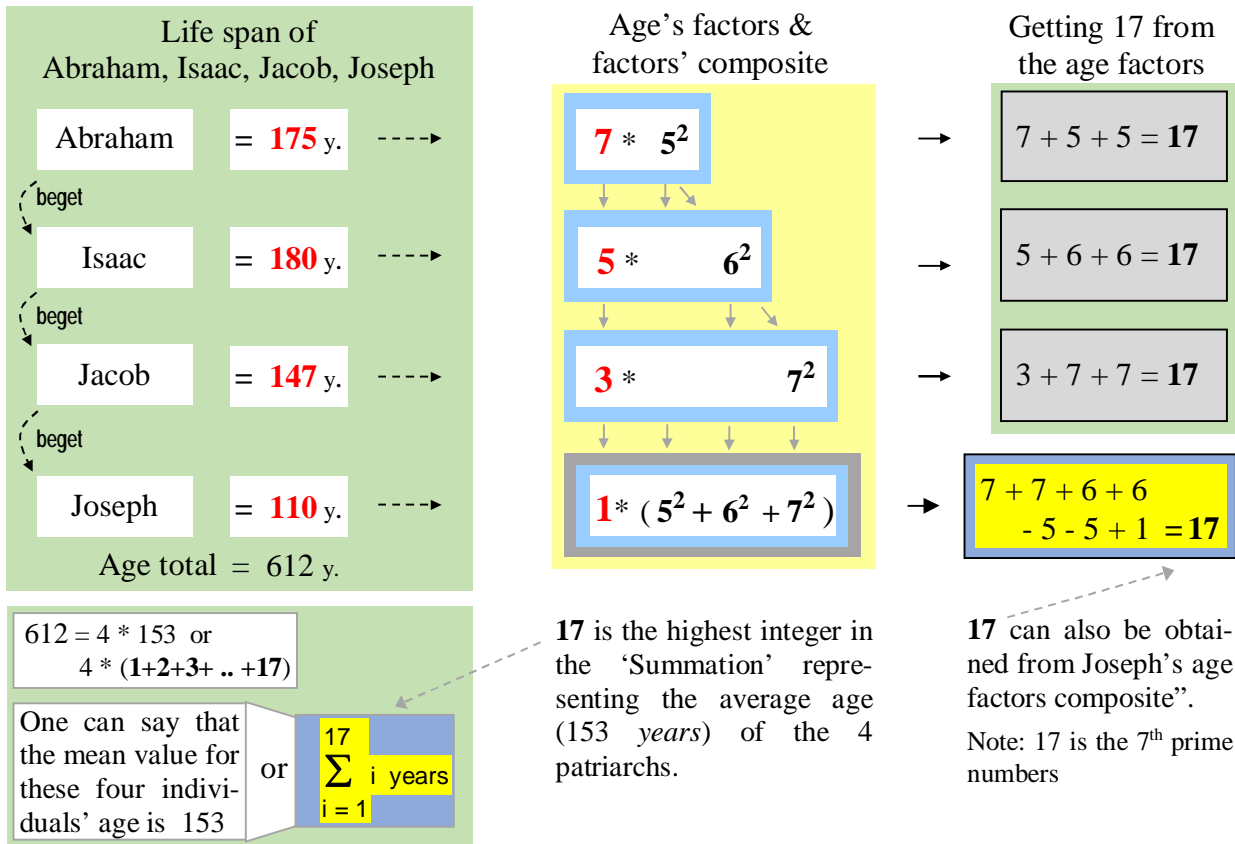

Second example : Genesis 1:1

The very first verse of the Bible tells us that God created the universe

Gen 1:1 In the beginning God created the heavens and the earth.

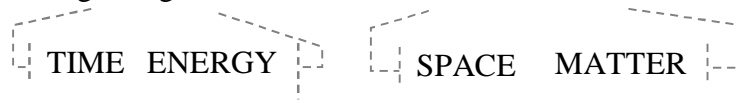

Here is Gen 1:1 in Hebrew with the Gematria¹ value expressed for each letter of the 7 words.

GENESIS 1:1						
7	6	5	4	3	2	1
90 200 1 5	400 1 6	40 300 40 10 5	400 1 40	40 30 5 1	200 1 2	400 300 1 10 200 2
הָאָרֶץ	וְאֵת	הַשָּׁמַיִם	אֵת	אֱלֹהִים	בְּרָא	בְּרֵאשִׁית
earth the	and	heaven the	—	God	created	beginning the In
296	407	395	401	86	203	913

← 7 letters → ← 7 letters →

← 14 letters → ← 14 letters →

← The 7 words use 28 letters (i.e. 1 + 2 + 3 + 4 + 5 + 6 + 7 letters) →

The gematria value of the 7 Hebrew words of Gen 1:1. leads to some fascinating information².

Total gematria = 913 + 203 + 86 + 401 + 395 + 407 + 296 = **2701**

2701 = 37 * 73 (37 & 73 are Mirror Numbers i.e.MN)

37 is the 12th prime number } **12 & 21** (MN)
 73 is the 21th prime number. }
 $12^2 = 144$ } **144 & 441** (MN)
 $21^2 = 441$ }

2701 + 1072 = 3773 (i.e. MN 2701 & 1072) = 7 * 7 * 77

1 st word + 3 rd word	= 913 + 86	= 999	Keep in mind for next page, if you rotate 999 you will obtain 666
2 nd word + 4 th word + 5 th word	= 203 + 401 + 395	= 999	
6 th word + twice the 7 th word	= 407 + 296 + 296	= 999	

If we add words #3, #5 and #6 (God, heaven, and, i.e. 86 + 395 + 407) we obtain 888

If we add words #3, #5 and #7 (God, heaven, earth, i.e. 86 + 395 + 296) we obtain **777**

¹ In the Hebrew alphabet each character has a value. A gematria of a word is the sum of these characters values.

² This information should be credited to Vernon Jenkins Ref 'The other bible code' on Internet

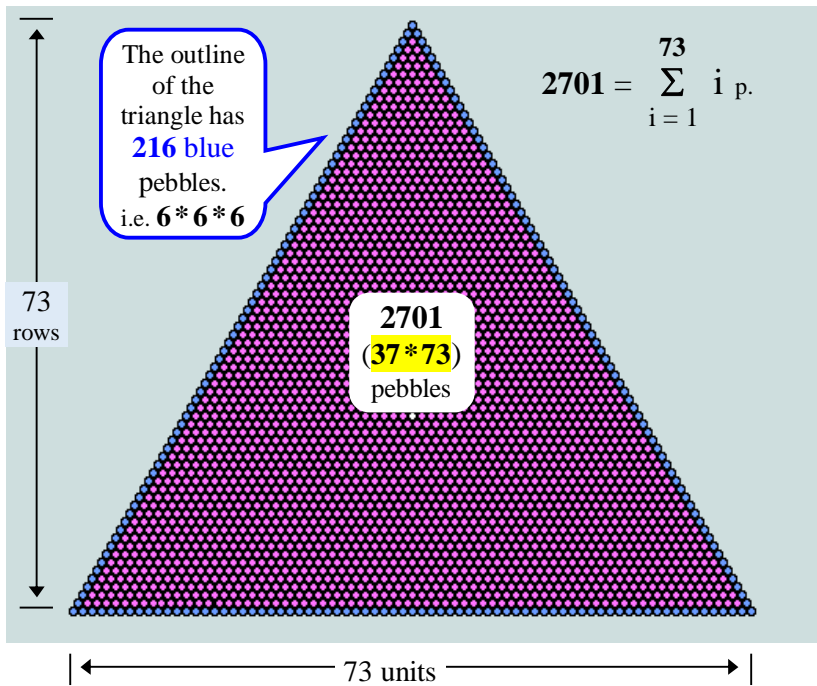

2701 is a triangular number and can be expressed like this:
 $1+2+3+\dots+71+72+73$

To visualize the value **2701**, we will build a triangle by aligning small pebbles (p) the following way:

there will be
1 pebble on the first row,
2 on the second,
3 on the third
...
73 pebbles on the 73th

There are 2701 pebbles in all.

Without adding or losing any pebble, we can transform the previous geometric structure in four perfectly fitting new ones.

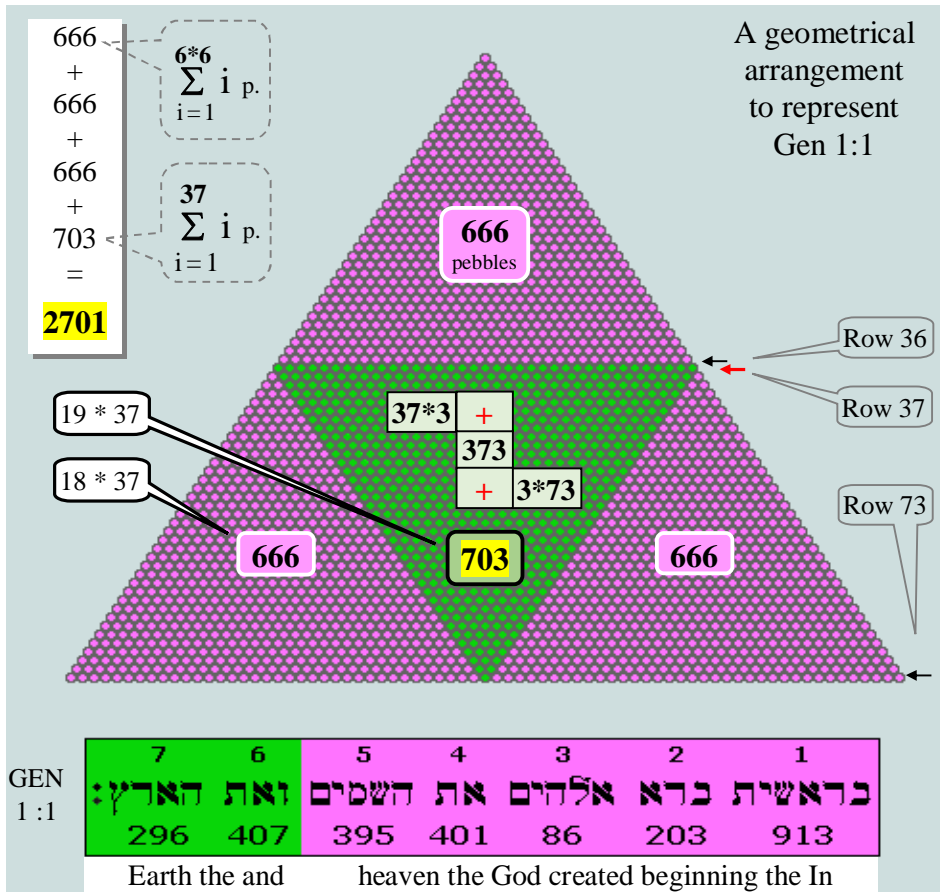

Notice
The first 5 words (gematria value of Gen 1:1)
i.e. (913, 203, 86, 401, 395)
add up to **3 * 666**

The last two words
'and the earth'
(gem. value of Gen 1:1)
i.e. (407, 296)
add up to **703**

Interesting:
 $666 = (6 + 6 + 6) * 37$
 $666 = 1^6 - 2^6 + 3^6$
 $666 = 2^2 + 3^2 + 5^2 + 7^2 + 11^2 + 13^2 + 17^2$
(i.e. Sum of the square of the first 7 prime numbers)

$666 = 1 + 2 + 3 + 4 + 567 + 89$
 $= 123 + 456 + 78 + 9$
 $= 9 + 87 + 6 + 543 + 21$

Third example : The High Priest's Breastplate³

In Exodus 28 we are told that the High Priest was going to wear a piece of garment called the Breastplate. Over this garment was disposed, on 4 rows, 12 precious stones on which was engraved the **names of each tribe of Israel**, one name on each stone. Here are some hidden facts attached to the breastplate, they were discovered by Ian Mallett and Vernon Jenkins and they show the absolute cleverness of God.



To demonstrate this we need to see the breastplate as a mathematical matrix in which the name of each tribe of Israel is replaced by its gematria value⁴. The following table gives us the gematria's values corresponding to each tribe's name. (The tribe's order can be found in Gen 29:32-Gen 20:20, Gen 41:51-52)

	Tribe	Hebrew	gematria
1	Reuben	רֵאוּבֵן	259
2	Simeon	שִׁמְעוֹן	466
3	Judah	יְהוּדָה	30
4	Dan	דָּן	54
5	Naphtali	נַפְתָּלִי	570
6	Gad	גָּד	7

7	Asher	אֲשֵׁר	501
8	Issachar	יִשָּׁשכָר	830
9	Zebulun	זְבֻלֹן	95
10	Benjamin	בְּנִימִין	162
11	Manasseh	מְנַשֶּׁה	395
12	Ephraim	אֶפְרַיִם	331

3	30 Judah	2	466 Simeon	1	259 Reuben
6	7 Gad	5	570 Naphtali	4	54 Dan
9	95 Zebulun	8	830 Issachar	7	501 Asher
12	331 Ephraim	11	395 Manasseh	10	162 Benjamin

Here we have each matrix's row filled from right to left with the name of each tribe according the order of their birth.

Notice two important rules:

The name of '**LEVI**' is not used in the matrix. The Breastplate was weared by a Levite therefore there was no need to represent that tribe on it.

The name of **Joseph** is not used either. Instead we replace it with the names of his two sons (**Manasseh & Ephraim**) who were adopted by Jacob (Gen 48:5).

The first interesting fact in this matrix is that the sum of all the gematria value = **3700**.

$$= 259 + 466 + 30 + 54 + 570 + 7 + 501 + 830 + 95 + 162 + 395 + 331$$

$$\mathbf{3700 = 10 * 10 * 37}$$

³ The following description should be entirely credited to two individuals, one is called Ian Mallett and the other is Vernon Jenkins whose work can be seen at <http://www.whatabeginning.com/> under 'AN ORACLE RESTORED'

⁴ In the Hebrew alphabet each character has a value and the gematria of a word is the sum of these values.

3 30 Judah	2 466 Simeon	1 259 Reuben
6 7 Gad	5 570 Naphtali	4 54 Dan
9 95 Zebulun	8 830 Issachar	7 501 Asher
12 331 Ephraim	11 395 Manasseh	10 162 Benjamin

The combined value of the greens squares
(259+30+570+501+95+395)

= 1850
or
50 * 37

The combined value of the oranges squares
(466+54+7+830+162+331)

= 1850
or
50 * 37

3 30 Judah	2 466 Simeon	1 259 Reuben
6 7 Gad	5 570 Naphtali	4 54 Dan
9 95 Zebulun	8 830 Issachar	7 501 Asher
12 331 Ephraim	11 395 Manasseh	10 162 Benjamin

The combined value of the yellows squares
(259+466+54+570+501)

= 1850
or
50 * 37

The combined value of the blues squares
(30+7+830+95+162+395+331)

= 1850
or
50 * 37

Interesting:

The gematria of Gen 1:1 (i.e. 2701) is found in the Breastplate's matrix

30 Judah	466 Simeon	259 Reuben
7 Gad	570 Naphtali	54 Dan
95 Zebulun	830 Issachar	501 Asher
331 Ephraim	395 Manasseh	162 Benjamin

30 + 466 + 259
+ 570 + 54 + 95
+ 501 + 331 + 395
= **2701**

7 +
830 +
162
= **999**

Fourth example: The seven resurrections.

There are plenty of example showing that the number ‘7’ has a special meaning in the Bible

At the creation of the world, the **seventh day** was set apart from the previous six days. This is the only day which does not mention any new creative elements. Day 7 is also the only day that does not have the repeated formula, “And there was evening and there was morning. It is obvious that the seventh day is special.

Special too was the **7th patriarch** ‘Enoch’ (Adam, Seth, Enosh, Kenan, Mahalalel, Jared, Enoch). Gen 5:24 Enoch walked with God; then he was no more, because God took him away.

Joshua and Israel marched around Jericho **seven** times while **seven** priests blew **seven** trumpets before the walls came crashing down (Joshua 6:3-4).

On a recommendation of the prophet Elisha, Naaman, commander of the army of the king of Aram, was cure of leprosy by going to wash himself **7 times** in the Jordan (ref 2 King 5:1-14)

God instituted **7 feast days**. There are 4 in the spring : Passover, Unleavened bread, First fruits, Feast of Weeks. And there are 3 in the fall: Trumpets (Rosh Hashanah), Atonement (Yom Kippur), Tabernacles (Sukkot).

Yeshua was the **7th individual** brought back to life in the Bible. His resurrection is especially special giving that the 6 previous one are part of an unexpected pattern⁵ organized around the post mortem stage of those who died.

A double sequence of three post mortem stages

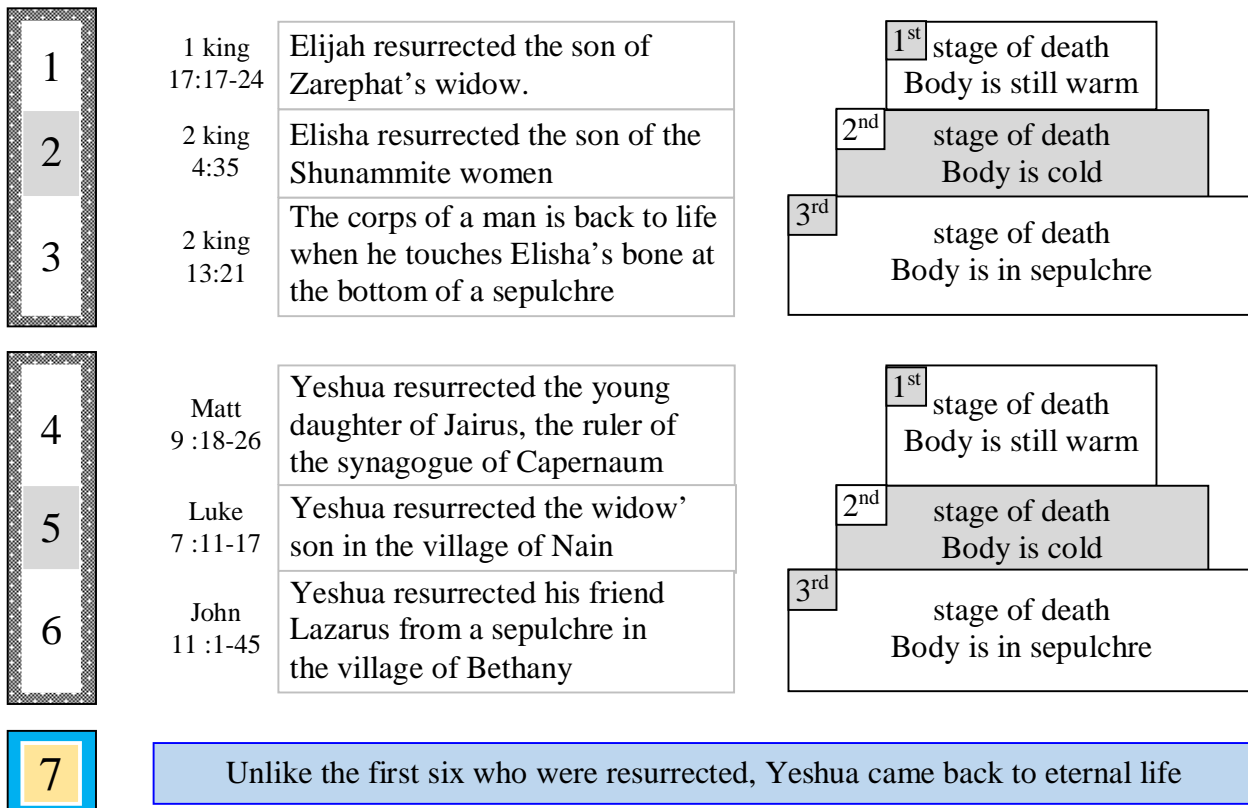

⁵ I learned about this pattern in ‘The Resurrection Pattern’ by Darek Barefoot

Apart of the second half of the first example, I have nothing to do with the previous four examples. I have included them at the beginning of this book with one goal in mind, show the readers that patterns are an integral part of the biblical message and therefore they should be sought as if they were precious gems. I know by experience that when they are found they are often awe-inspiring. It is the way of the Bible: The right understanding leads to great discoveries.

Let's try to understand what we are told in Ezekiel 4-5

The 40 years imputed to Judah

The logical start for the '40 years of sin' of Judah should be 40 years before the destruction of Jerusalem by Nebuchadnezzar's army, but this solution presents a major flaw and is therefore totally unacceptable.

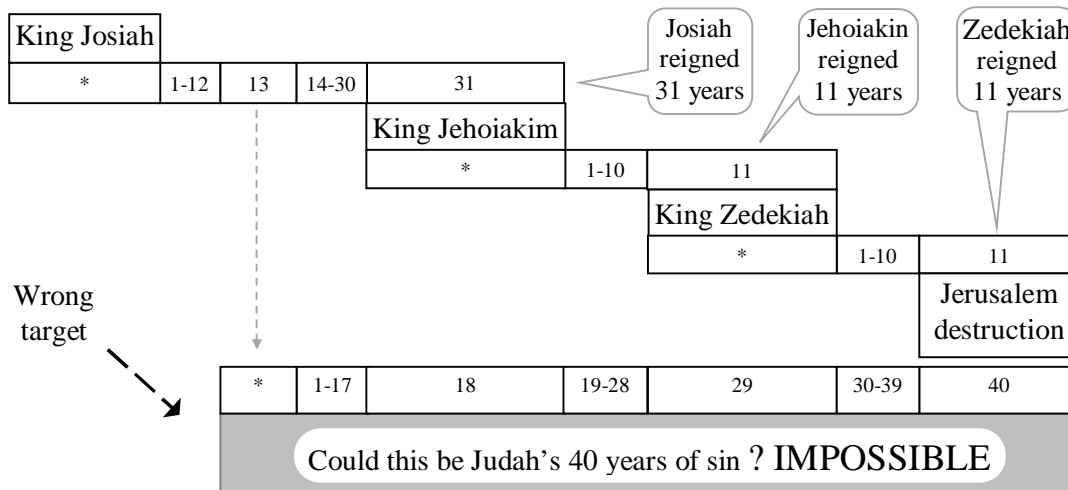

As we can see, going backwards 40 years from Jerusalem's destruction in the 11th year of Zedekiah brings us into the 13th year⁶ of Josiah. Why would the "40 years of sin" start in the kingship of one of the few kings who really sought God's approval? King Josiah was responsible for major reform that brought his people closer to God:

- Jer 22:15-16 Did not your father [Josiah] have food and drink? He did what was right and just, so all went well with him. He defended the cause of the poor and needy...
- 2 Kings 23:25 Neither before nor after Josiah was there a king like him who turned to the LORD as he did--with all his heart and with all his soul and with all his strength...

Have you considered this? Before Josiah's reign, many of the previous kings had led the people astray for the whole duration of their reign. Weren't these 'years' also years of sin? Why should they be ignored? Why did God restrict the period of sin to 40 years when we could easily count hundreds of years of sinful reign?

⁶ Jeremiah started prophesying the same year : Jer. 25:3 For twenty-three years--from the thirteenth year of Josiah son of Amon king of Judah until this very day--the word of the LORD has come to me and I have spoken to you again and again, but you have not listened.

A premise } Given that the 40 years of sin refer to a fixed period (40 years) it has to be preceded and followed by a period without sin (absence of sin). If this were not the case it wouldn't be possible to mark the beginning and the end of these 40 years.

Here is a new way to look at it:

When Ezekiel was told to bear the sin of the house of Judah, he was not told to bear all the sins of Judah; the request was much more specific than that. **He was going to bear ONLY one sin, one sin that lasted 40 years.** All other sins committed by Judah could have lasted hundreds of years, could have been preceded and followed by years without sin; they were irrelevant to Ezekiel's 40 years of Sin.

HOUSE OF JUDAH HISTORY

Solomon dies	X years	40 years	Y years	Jerusalem's destruction
Kingdom splits (Ref 1 King 12:16)	Absence of the special sin	Special Sin	Absence of the special sin	

What was Judah's special Sin?

- Ezek 5:11-12 Therefore as surely as I live, declares the Sovereign LORD, because you have **defiled my sanctuary** with all your vile images and detestable practices, I myself will withdraw my favor; I will not look on you with pity or spare you. A third of your people will die of the plague or perish by famine inside you; a third will fall by the sword outside your walls; and a third I will scatter to the winds and pursue with drawn sword.

See also 2 Kings 21:7, Jer 7:30, 2 Chron 33:4-6, 2 Chron 33:7

➔ ➔ ➔ Defilement of God's Temple ← ← ←

Defiling the Temple (His dwelling place) was certainly an abomination in the eyes of God, something worse than anything else the people could have done.

We have now to answer three questions:

1. Who did it?
2. How and when was it stopped?
3. When did it start?

Who did it?

- 2 Kings 21:7-9 He took the carved Asherah pole he had made and put it in the temple **Manasseh** led them astray, so that they did more evil than the nations the LORD had destroyed before the Israelites.

See also Jer 15:3-4, 2 Kings 23:26-27, 2 Kings 24:2-4

So who did it? ➔ King Manasseh defiled the Temple.

How and when was it stopped?

- 2 Kings 23:4 The king ordered Hilkiah the high priest, the priests next in rank and the doorkeepers to remove from the temple of the LORD all the articles made for Baal and Asherah and all the starry hosts. He burned them outside Jerusalem in the fields of the Kidron Valley and took the ashes to Bethel.
- 2 Kings 23:21-23 The king gave this order to all the people: "Celebrate the Passover to the LORD your God, as it is written in this Book of the Covenant." Not since the days of the judges who led Israel, nor throughout the days of the kings of Israel and the kings of Judah, had any such Passover been observed. But **in the eighteenth year of King Josiah**, this Passover was celebrated to the LORD in Jerusalem

See also 2 Kings 23:1-3, 2 Kings 23:7, 2 Kings 23:11-12

When was it stopped? → The Temple was purified in Josiah’s 18th year.

When did the ‘40 years of sin’ start?

We know from 2 Kings 23:23 that Josiah cleansed the Temple in the 18th year of his kingship:

We also know from Ezek 4:6 that the Sin lasted 40 years (= 40 days)

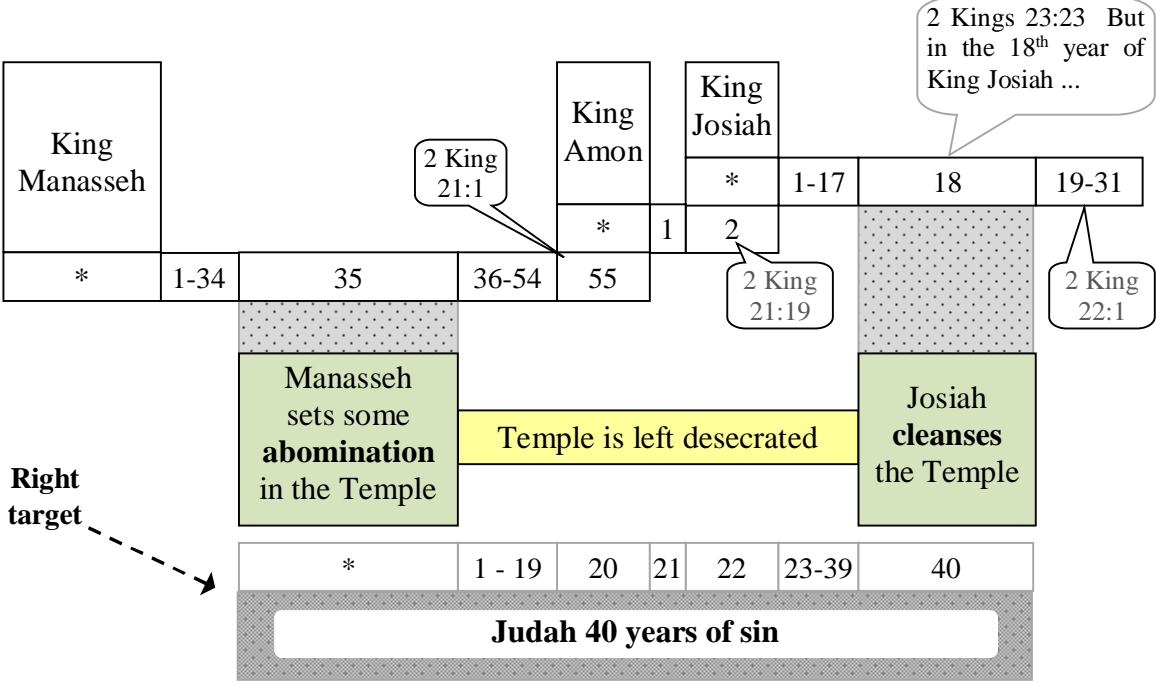

It’s a simple matter to go back 40 years from the 18th year of Josiah and find that the starting point of this desecration (abomination) happened in Manasseh 35th year of reign.

JUDAH's 40 years of Sin

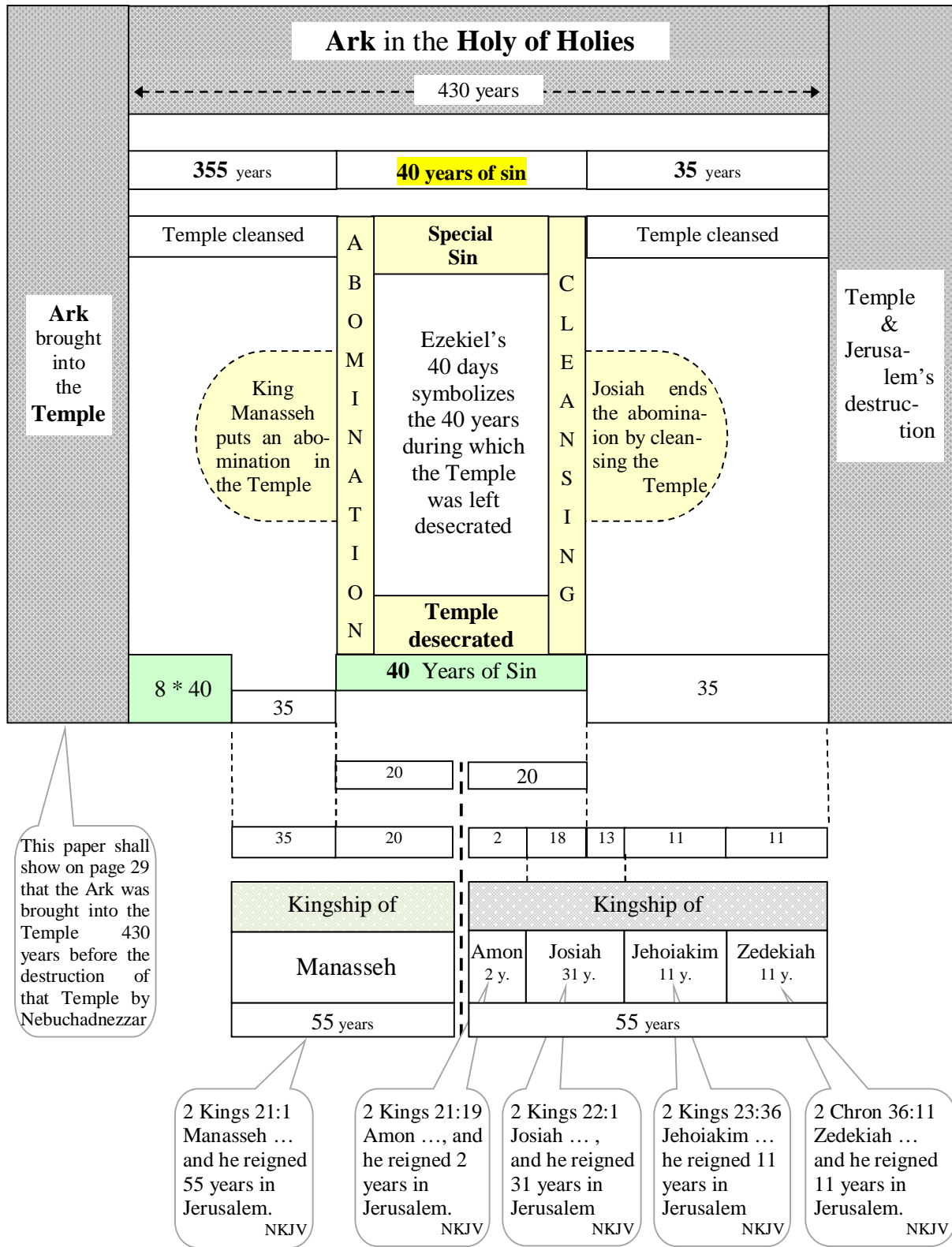

Figure 1. Judah's 40 years of Sin

The 390 years imputed to Israel

The house of Israel's sin that we are looking for needs to satisfy the following 5 requirements:

- #1. Unique and never done before
- #2. Started at a specific time
- #3. Ended at a specific time
- #4. Lasted 390 years (and involve the same people from the start to the end)
- #5. Inflamed God

Here, contrary to the house of Judah's very unique sin that we have identified earlier, no such sin can be found in relation to the house of Israel. We have to consider the only other alternative: **the '390 years of sin' refers to a time in which numerous sins were committed.** Given that it is very unlikely that all those sins started on the same day, the beginning that we are looking for must be linked to an event involving the 12 tribes and must have been so disgraceful to God that it became the start of the 390 years of sin. Unsurprisingly, there is such an event.

- Hos 9:9 They have sunk deep into corruption, as **in the days of Gibeah**. God will remember their wickedness and punish them for their sins.
- Hos 10:9 "**Since the days of Gibeah**, you have sinned, O Israel, and there you have remained.

Judges 19 describes what happened in Gibeah. It can be summarized the following way:

A Levite and his concubine found shelter for the night in an old man's house in Gibeah. During the night the concubine was abused by some of the wicked men of the city while this Levite showed no concern for her. The woman was found lying on the threshold of the house in the morning. Later, the Levite dismembered his concubine (while she might have been still alive) and sent one part to every tribe of Israel:

- Judg 19:29 When he reached home, he took a knife and cut up his concubine, limb by limb, into twelve parts and sent them into all the areas of Israel.

The disastrous outcome of this event was that the 12 tribes were involved in a fratricidal war for the first time.

- Among the 11 tribes who fought against Benjamin there was more than 40,000 victims.
- Benjamin's tribe was nearly exterminated⁷. Among all the men, woman and children of that tribe only 600 soldiers survived by hiding for 4 months⁸.

⁷ Judg 20:48 The men of Israel went back to Benjamin and put all the towns to the sword, including the animals and everything else they found. All the towns they came across they set on fire.

⁸ Judg 20:46-47 On that day twenty-five thousand Benjamite swordsmen fell, all of them valiant fighters. But six hundred men turned and fled into the desert to the rock of Rimmon, where they stayed four months. NIV

The incident at Gibeah is the perfect candidate for the start⁹ of the 390-year period.

- ❖ Hosea called the ‘days of Gibeah’ ‘the start of a period of sin’. This is exactly what we are looking for.
- ❖ What happened was unique.¹⁰

Notice that the original intent of the men of Gibeah (Benjamites) was to commit **an abomination** prescribed by the law of God. Compare¹¹ Judge 19:22 and Lev 18:22. Therefore, both periods of sin (390 years and 40 years¹²) are associated with abominations.

When did the Gibeah incident happen?

Phinehas, the grandson of Aaron, was officiating when it happened. It situates the incident in the period following the arrival in the Promised Land:

- Judg 20:27-28 And the Israelites inquired of the LORD. (In those days the ark of the covenant of God was there, with Phinehas son of Eleazar, the son of Aaron, ministering before it.)

Israel served the Lord until all the elders who had witnessed the Exodus died. That makes it unlikely that the Gibeah incident happened before the death of Joshua:

- Josh 24:31 Israel served the LORD throughout the lifetime of Joshua and of the elders who outlived him and who had experienced everything the LORD had done for Israel.

If we speculate that the elders who outlived Joshua were at least 15 years old at the time of the Exodus (old enough to have understood what was going on) but younger than 20 years old (otherwise they would have died before reaching the promised land, a direct outcome of the spy event as stipulated in Num 14:29) we have a group of people aged at least 60 years old at the division of the land. All those elders could have died in a range of 30 years after the division of the land.

Note that Josh. 24:31 implies that Israel stopped serving the Lord not long after the death of all those witnesses.

⁹ There is no doubt that Israel was already sinning long before the event of Gibeah but the ABOMINATION that was committed at that time was worse than everything else.

¹⁰ Judg. 19:30 Everyone who saw it said, "Such a thing has never been seen or done, not since the day the Israelites came up out of Egypt

¹¹ Judg 19:22 "Bring out the man who came to your house so we can have sex with him."
Lev 18:22 Thou shalt not lie with mankind, as with womankind: it is abomination.

¹² 2 Kings 21:11 "Because Manasseh king of Judah has done these abominations (he has acted more wickedly than all the Amorites who were before him, and has also made Judah sin with his idols),

The following figure gives the chronology of some important events that occurred in the Exodus period.

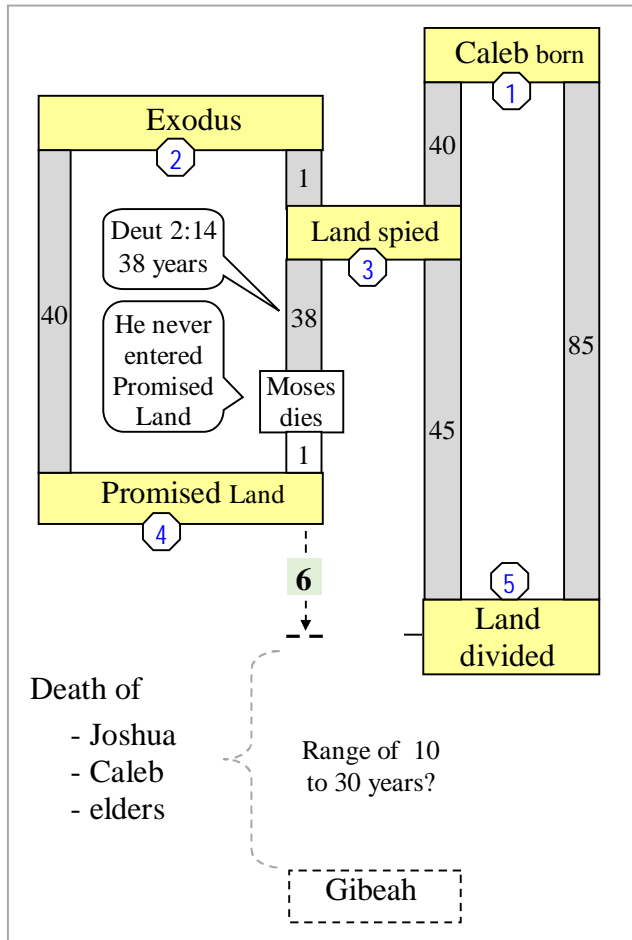

Figure 2. Land divided

We are told in Ezekiel 4. that the '390 years of sin' are associated with the 'House of Israel', however the event of Gibeah involved the 12 tribes of Israel. Could Ezekiel have used the term 'House of Israel' with the 12 tribes¹³ in mind? Yes, the two Hebrew words (beeyt-Yisraa'eel) transliterated as 'the House of Israel' in Ezekiel 4:4 were also used to point to the twelve tribes in other instances¹⁴ and this, a long time before the split of the two Kingdoms.

- Ex 16:31 And the house of Israel called its name Manna. NKJV

Nobody will contest the fact that Moses was here referring to the 12 tribes of Israel:

- Ruth 4:11 The LORD make the woman that is come into thine house like Rachel and like Leah, which two did build the house of Israel: NKJV

¹³ 'House of Israel' is the term often used to point to the group of 10 tribes who chose Jeroboam as King after Solomon's death. Ref 1 King 12:20.

¹⁴ Strong #1004 = beeyt- and Strong # 3478 = Yisraa'eel are also found together in Ex 40:38, Lev 10:6, Lev 17:3, :8, :10, Lev 22 :18, Num 20 :29, Josh 21 :45, Ruth 4 :11, 1 Sam 7:2 , :3, 2 Sam 1:12

From 3 to 5 & From 1 to 5

Josh. 14:10 "Now then, just as the LORD promised, he has kept me alive for forty-five years since the time he said this to Moses, while Israel moved about in the desert. So here I am today, **eighty-five** years old!

From 1 to 3

Josh. 14:7 I was **forty years** old when Moses the servant of the LORD sent me from Kadesh Barnea to explore the land.

From 2 to 3

Num 10:11-12 On the twentieth day of the second month of the second year, Then the Israelites set out from the Desert of Sinai ...
The land was spied in the **second year**.

From 2 to 4

Num 14:33-34 For **forty years**--you will suffer for your sins

From 4 to 5

Land was divided **6 years** after coming in the Promised Land. $85 - (40 - 1 + 40)$

Following the Gibeah incident the Israelites kept sinning for several hundred years. During that time:

- They were often oppressed in response to their worshipping of others gods.
- The Ark was captured.
- They rejected God their true King.
- God rejected Saul their first king.

It would have been an amazing change if the people had suddenly succeeded in reforming themselves after all these years, yet, according to Ezekiel the period of sin lasted no more than 390 years. What could have happened to justify that the count of years of sin came to a stop after 390 years?

The answer seems to be directly related to God's dwelling place:

- Deut 12:4-5 You must not worship the LORD your God in their way. **But you are to seek the place the LORD your God will choose from among all your tribes to put his Name there for his dwelling.**

At the time of the Gibeah incident God's "permanent" dwelling place was at Shiloh (**under the jurisdiction of Ephraim**¹⁵), however He abandoned it and chose Zion instead.

- Ps 78:59 he rejected Israel completely.
- Ps 78:68 but he chose the tribe of Judah, Mount Zion, which he loved.

If it can be shown that God came to Zion, his last dwelling place, exactly 390 years after the Gibeah incident, we will have a very strong argument to explain why Israel's years of Sin did not go over the 390 mark, the logic being that there wouldn't have been any justification in cumulating any more years of sin once the people had been given a new beginning (see page 23) and God had come to a new dwelling place.

God rejected the House of Israel (He left Shiloh)

- 1 Sam 4:22 The glory has departed from Israel, for the ark of God has been captured."

We have something truly unique here: as a sign that He had rejected the House of Israel and His dwelling place in Shiloh, God sent the Ark into captivity:

- 1 Sam 3:11 And the LORD said to Samuel: "See, I am about to do something in Israel that will make the ears of everyone who hears of it tingle.

God chose the House of Judah (He came to Zion)

Years later the Ark would again be used, but this time to show that God was coming to His new dwelling place in Zion.

¹⁵ Jer 31:9 because I am Israel's father, and Ephraim is my firstborn son. NIV

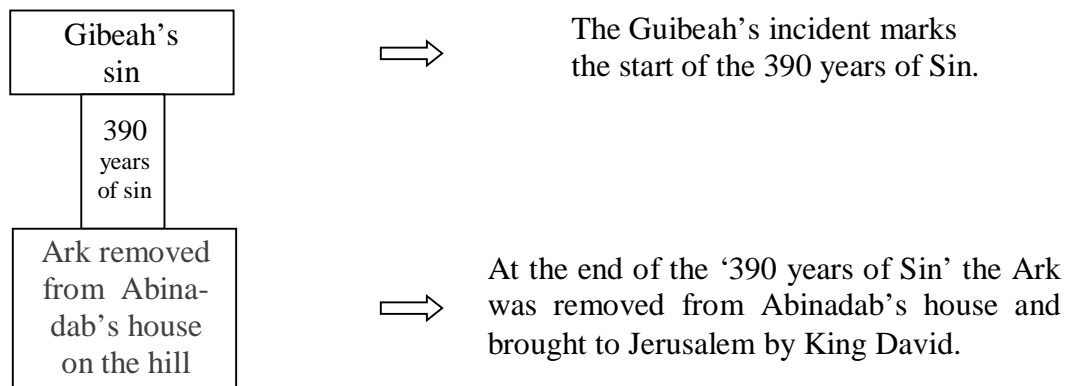

When the time came to bring the Ark into Jerusalem David had to fetch it from the house of Abinadab. In 2 Sam 6:3 we are told that Abinadab's house was on a **hill**. Why are we told this seemingly useless detail? It doesn't appear to bring anything to the story and from the reader's perspective that 'hill' could have been any hill.

The Hebrew word translated as '**hill**' in 2 Sam 6:3 is the very same word used in Judges 19 to designate the Benjamite town of '**Gibeah**'. Interesting, isn't it? The implication here is that we were not merely informed that the house of Abinadab was on an 'unknown' hill, impossible to identify, but we were rather told that this house was at Gibeah, the same 'Gibeah' that was involved with the start of the 390 years of Sin. Notice that while most English translations of the Bible have the house of Abinadab on a hill, the KJV has located it at 'Gibeah':

- 2 Sam 6:3 And they set the ark of God upon a new cart, and brought it out of the house of Abinadab that was in Gibeah: KJV

Obviously 'Gibeah' and 'hill' are from the same Hebrew word. Which one the author of 2 Sam 6:3 had in mind when he wrote the verse is hard to determine but we can speculate in favor of 'Gibeah'.

The town of Gibeah was where King Saul (the first king of Israel) lived during his whole kingship. Therefore, it would be reasonable to think that, at one time during his kingship, he had the Ark brought to Gibeah so that it could be close to him. Was not David going to do exactly the same when he moved to Jerusalem?

As we can see, the start and the end of the 390 years of sin are both related to Gibeah somehow.

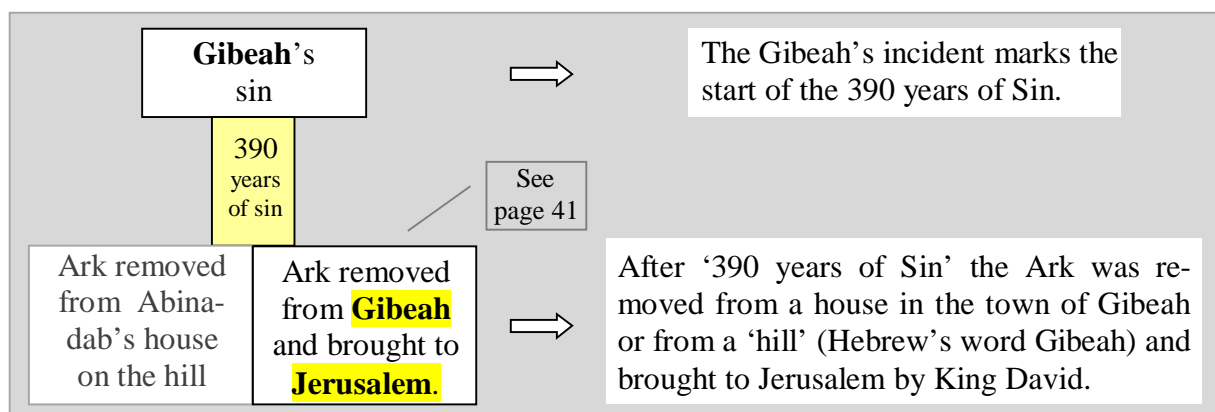

The following 7 points will highlight some interesting parallels between the Start (S1-S7) and the End (E1-E7) of that 390-year period. They confirm that the two events are related somehow.

S1	<p>There was no King in Israel at that time:</p> <ul style="list-style-type: none"> • Judg 19:1 In those days Israel had no king. 	
	<p>David was the first king to reign over all Israel.</p>	E1

S2	<p>The Levite wouldn't go to Jerusalem for sanctuary:</p> <ul style="list-style-type: none"> • Judg 19:12 No We won't go into an alien city, whose people are not Israelites. 	
	<p>The Ark could not be brought to its new sanctuary without the participation of the Levites:</p> <ul style="list-style-type: none"> • 1 Chron 15:12-13 "You are the heads of the Levitical families; you and your fellow Levites are to consecrate yourselves and bring up the ark of the LORD, the God of Israel, to the place I have prepared for it. It was because you, the Levites, did not bring it up the first time that the LORD our God broke out in anger against us. 	E2

S3	<p>The Levite wouldn't go to Jerusalem because it was occupied by the Jebusites:</p> <ul style="list-style-type: none"> • Judg 19:11-12 "Come, let's stop at this city of the Jebusites and spend the night." His master replied, "No. 	
	<p>When David came to Jerusalem, a few years before he brought the Ark, the first thing he and his army did was to remove the Jebusites from the city:</p> <ul style="list-style-type: none"> • 2 Sam 5:6 The king and his men marched to Jerusalem to attack the Jebusites, who lived there. 	E3

S4	<p>The Levite concubine was dismembered in 12 parts:</p> <ul style="list-style-type: none"> • Judg 19:29 When he reached home, he took a knife and cut up his concubine, limb by limb, into twelve parts and sent them into all the areas of Israel. 	
	<p>The last Benjamite king over Israel was Ish-Bosheth and he was killed by two of his own compatriots. The surprising thing about this is that all three men (Benjamites) were dismembered and the total number of limbs obtained was also 12, the same number that was associated with the Levite concubine who was killed by the Benjamites of Gibeah.</p> <p style="margin-left: 40px;">Ish-Boseth's head was cut off: = 2 parts.</p> <ul style="list-style-type: none"> • 2 Sam 4:7 After they stabbed and killed him, they cut off his head. <p style="margin-left: 40px;">Recab and Baanah, Ish-Boseth's murderer: 5 parts each = 10 parts</p> <ul style="list-style-type: none"> • 2 Sam 4:12 They cut off their hands and feet and hung the bodies by the pool in Hebron. 	E4

S5 The people of Israel who came to fight at Gibeah didn't want to go to war against the whole tribe of Benjamin. They sent men among the Benjamites to negotiate the surrender of the wicked men of Gibeah:

- Judg 20:13 Now surrender those wicked men of Gibeah so that we may put them to death and purge the evil from Israel."

Unexpectedly the **Benjamites refused to listen to their brother** and chose to protect those who were guilty.

All the Benjamite woman and children were killed during the following war. (Jud 20:48)

Of all the people gathered in Jerusalem for the bringing in of the Ark, the only one (we are told) who didn't show a joyful heart during the event was Michal, the King's wife. She despised David because he was dancing before the Ark:

- 2 Sam 6:16 As the ark of the LORD was entering the City of David, Michal daughter of Saul watched from a window. And when she saw King David leaping and dancing before the LORD, she despised him in her heart.

Unexpectedly Michal, a **Benjamite** (daughter of Saul) **refused to humble herself**.

This Benjamite woman didn't have any children until the day of her death. (2 Sam 6:23)

E5

S6 After having fought and won against the Benjamites, the people of Israel went to Bethel ('**house of God**') to repent of the gravity of their action.

→ The people fasted:

- Judg 21:2 The people went to Bethel, where they sat before God until evening, raising their voices and weeping bitterly.

→ Presented burnt offerings and fellowship offerings:

- Judg 21:4 and presented burnt offerings and fellowship offerings.

After the Ark was brought to Zion (its new **dwelling place**)

→ David presented burnt offerings and fellowship offering:

- 1 Chron 16:2 After David had finished sacrificing the burnt offerings and fellowship offerings

→ And they were fed:

- 1 Chron 16:3 Then he gave a loaf of bread, a cake of dates and a cake of raisins to each Israelite man and woman.

E6

S7 One outcome of the Gibeah incident was the near extinction of the Benjamites. Of the 600 men who survived 200 needed to find a wife among the other tribes. It was agreed that they could pick one from **among the girls that were dancing at Shiloh**. (see Jud 21:20-22)

When the Ark came to Zion **David was seen leaping and dancing** before the Lord:

- 2 Sam 6:16 and when she saw King David leaping and dancing before the LORD

E7

NOTE: In each case the dancing was very special and the person doing it would never have to do it again.

-- The girls of Shiloh were dancing to find a husband (otherwise the author of Jud 21:22 would have used a much stronger word than 'complaint' to describe the people's protestation. Notice also that only the girls' fathers and brothers were involved, if the matter had been dramatic the whole town would have joined in.).

-- The King was dancing in the street (a very unusual sight) because the Ark was coming to Zion. He would never have to do it again.

It was previously said (on page 19) that the count of years was stopped in the 390th year because that year (when the Ark was brought to Jerusalem) the Israelites were offered a new beginning. Were they really offered a new beginning?

Bringing the Ark to Jerusalem was a major event in the history of the 12 tribes and it was done with the approbation of God and every leader of Israel¹⁶.



When the right time came everybody¹⁷ in Israel was mobilized to bring the Ark and each one had the proper attitude for transforming that day into a grand celebration.

Holiness

- 1 Chron 15:12-13 "You are the heads of the fathers' houses of the Levites; sanctify yourselves, you and your brethren, that you may bring up the ark of the LORD God of Israel to the place I have prepared for it.

Respect

- 2 Sam 6:13 And so it was, when those bearing the ark of the LORD had gone six paces, that he sacrificed oxen and fatted sheep.

Humility

- 2 Sam 6:14 Then David danced before the LORD with all his might; and David was wearing a linen ephod.

Joy

- 2 Sam 6:15 So David and all the house of Israel brought up the ark of the LORD with shouting and with the sound of the trumpet.

When the Ark reached its new Tabernacle in Zion (the original tent was not brought with the Ark) David offered a peace offering¹⁸ to God in the name of all the people¹⁹.

And then David blessed²⁰ all the people **in the name of God**.

¹⁶ 1 Chron 13:1-3 Then David consulted with the captains of thousands and hundreds, and with every leader. And David said to all the assembly of Israel, "If it seems good to you, and if it is of the LORD our God, let us send out to our brethren everywhere who are left in all the land of Israel, and with them to the priests and Levites who are in their cities and their common-lands, that they may gather together to us; and let us bring the ark of our God back to us NKJV

¹⁷ 1 Chron 15:3 David assembled all Israel in Jerusalem to bring up the ark of the LORD to the place he had prepared for it.

¹⁸ Peace Offering. This sacrifice celebrated covering of sin, forgiveness by God, and the restoration of a right and meaningful relationship with God and with life itself.
(from Nelson's Illustrated Bible Dictionary, Copyright (c)1986, Thomas Nelson Publishers)

¹⁹ 2 Sam 5:1-2 All the tribes of Israel came to David at Hebron and said, "We are your own flesh and blood. ... And the LORD said to you, 'You will shepherd my people Israel, and you will become their ruler.'"

²⁰ 2 Sam 6:18 he blessed the people in the name of the LORD Almighty. NIV

David's blessing is the key element in my belief that the count of 'year of sin' was then stopped. In those days the people were not collectively blessed on a regular basis and the last time they had been was on Mount Gerizim (Josh 8:33-34) when Joshua did it (400 years earlier). Therefore, David's blessing was so exceptional that its implication cannot be neglected.

There would have been no point in God allowing David to pass special favours to the 12 tribes if at the same time He intended to keep cumulating the years of their sin.

When was the Ark brought to Jerusalem?

David was already installed in Jerusalem when he brought the Ark:

- 2 Sam. 5:5 In Hebron he reigned over Judah for seven years and six months, and in Jerusalem he reigned over all Israel and Judah for thirty-three years.

So the Ark did not come to Jerusalem before David's 8th year of reign. In fact, we will see a little further in this paper (on page 68) that the Ark was probably brought to Jerusalem 3 years after David came to the city.

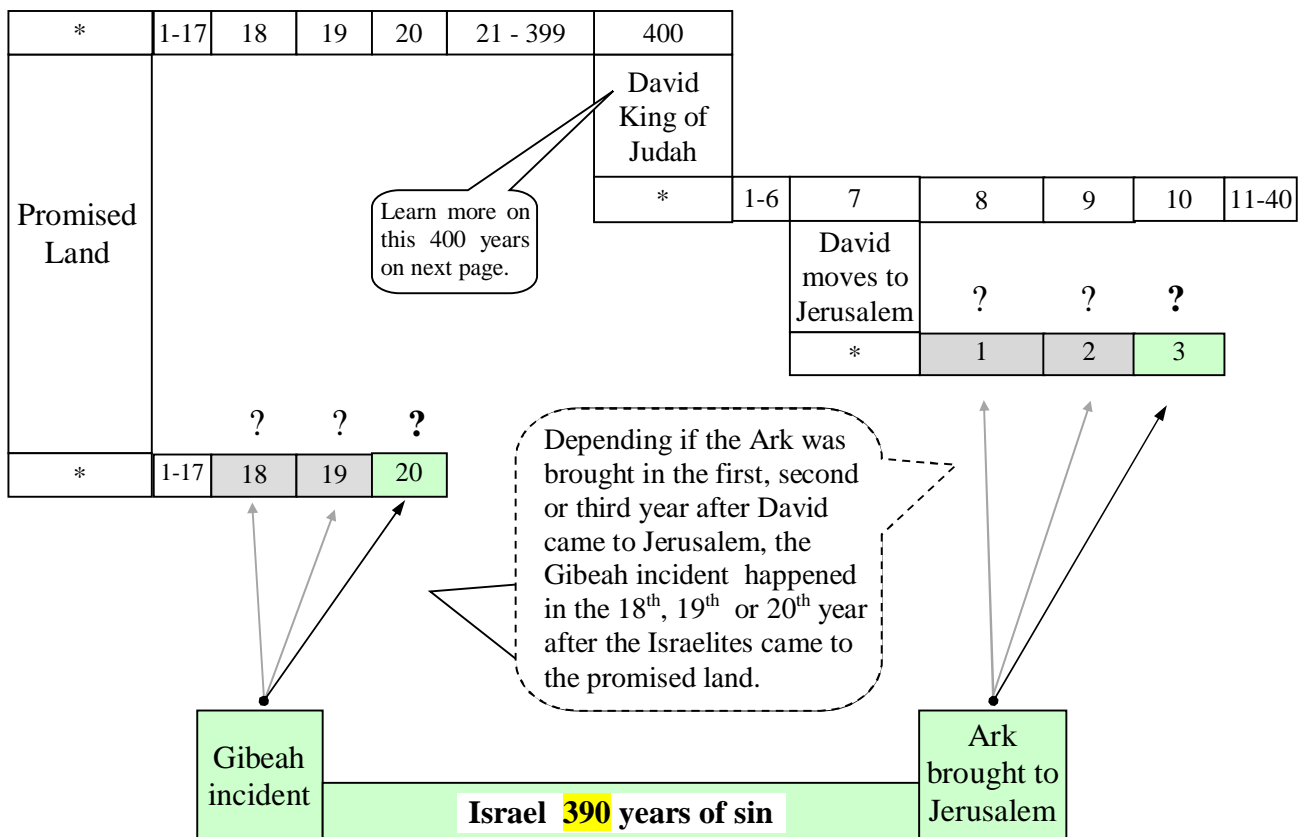

The 390 years of sin associated with the House of Israel is the time period between the Gibeah incident and the coming of the Ark to Jerusalem.

David's reign

The following chart shows that David reigned 400 years after the Israelites came to the Promised Land. For more explanation, read my paper

“The 44 Hebrew monarchs (A Chronology of two kingdoms)”

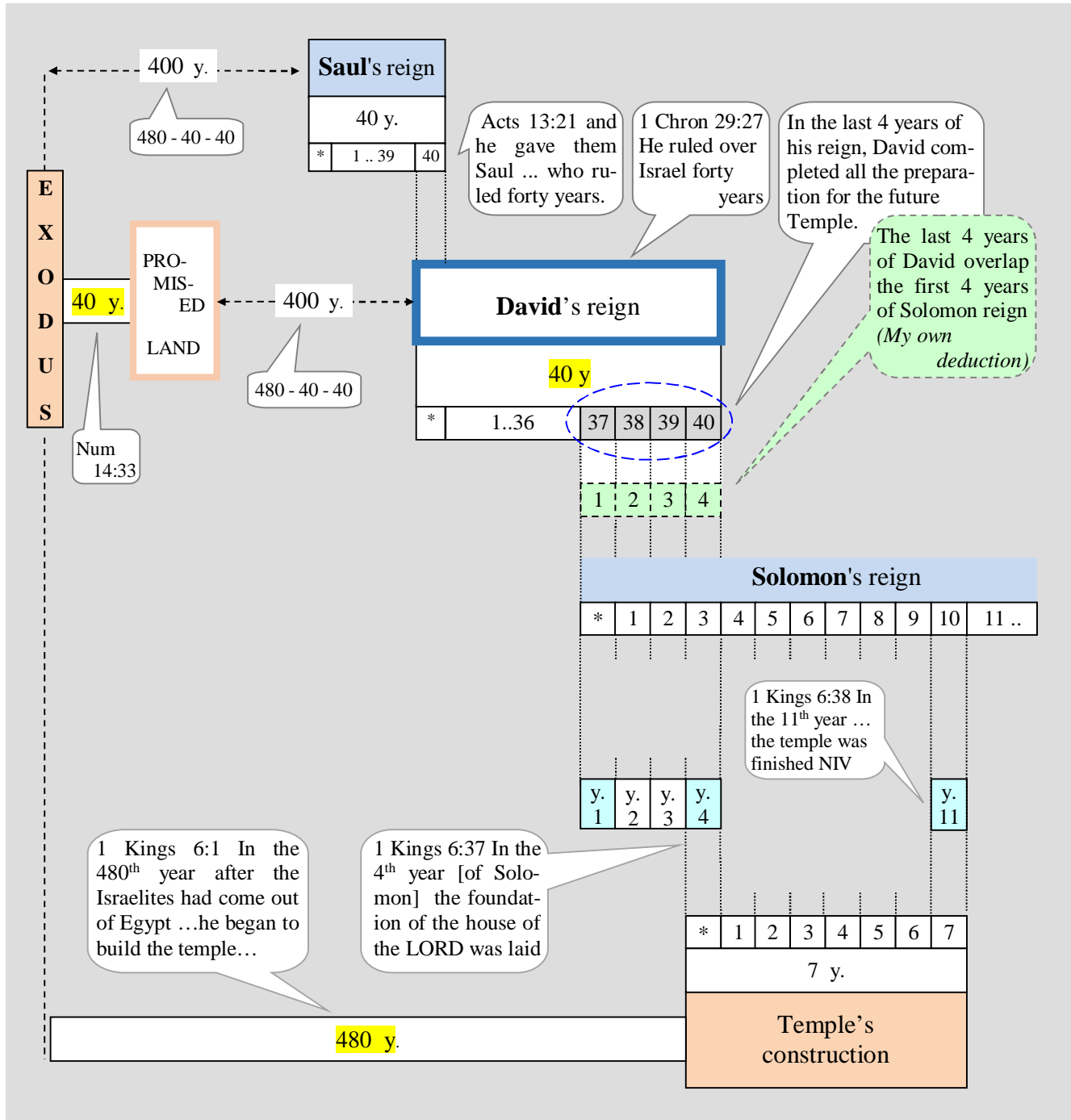

Ezekiel's 430-year SIEGE of Jerusalem

Ezekiel was asked to symbolize a siege that would end with the destruction of Jerusalem. To do it, he had to lie on his side in front of an image of the city for 430 days, a number obtained by combining the 390 days assigned to the House of Israel with the 40 days assigned to the House of Judah:

- Ezek 4:5-7 I have assigned you the same number of days as the years of their sin. So for 390 days you will bear the sin of the house of Israel. "After you have finished this, lie down again, this time on your right side, and bear the sin of the house of Judah. I have assigned you 40 days, a day for each year.

A major point has to be understood about the duration of Ezekiel's siege. No matter that the 430 days are a composite of the 390 days and 40 days, it would be erroneous to deduce that Ezekiel performed two different sieges (one 390-day siege against Israel and one 40-day siege against Judah.). Ezekiel's siege had nothing to do with the side on which he was lying on. During the **whole 430 days** of his act, he had been continually facing the image of Jerusalem; therefore he was portraying a single, uninterrupted, siege of the city.

Using the rule that a day stands for a year²¹ **Ezekiel portrayed a siege that lasted 430 years.**

As we know, it was Nebuchadnezzar, King of Babylon, who achieved the destruction of Jerusalem. He came to Jerusalem in the 9th year of the reign of Zedekiah (King of Judah), he laid a siege in front of the city and, in the 11th year of the reign of the King of Judah, succeeded in piercing the wall. Jerusalem was then burned down and the Temple destroyed. **Nebuchadnezzar's siege lasted less than 2 years:**

- 2 Kings 25:1-4 So in the ninth year of Zedekiah's reign, on the tenth day of the tenth month, Nebuchadnezzar king of Babylon marched against Jerusalem with his whole army. He encamped outside the city and built siege works all around it. The city was kept under siege until the eleventh year of King Zedekiah.Then the city wall was broken through

Why did the symbolic siege of Ezekiel last 430 years (day = year) when it is so obvious that Nebuchadnezzar's siege only lasted 2 years? There could be only one possible explanation. Even though those two sieges ended with the destruction of Jerusalem,

Ezekiel's siege was not depicting Nebuchadnezzar's siege at all.

Was Jerusalem under siege for 430 years?

If the 390 days-years and the 40 days-years are accurate values that could be explained (and they will be later), there is no reason to doubt that the 430 days-years had also a literal application? So the answer is YES, there was a siege of 430 years against Jerusalem.

²¹ As explained in Ezek. 4:5 I have assigned the same number of days as the years of their sin.

Who was holding the siege and when?

By lying on his side during 430 days, in front of an image of Jerusalem, Ezekiel was symbolizing 'somebody else's siege'.

Now, if we understand correctly the role of a prophet (Ezekiel in this particular case) we can say that he is a substitute for the word of God and we could venture to say that he is also a substitute for God himself:

- Ezek 7:1-2 The word of the LORD came to me:
- Amos 3:8 the Sovereign LORD has spoken- who can but prophesy?
- Jer 20:9 his word is in my heart like a fire, a fire shut up in my bones. I am weary of holding it in; indeed, I cannot.

Ezekiel's symbolic action is a sign that mirrors a real action:

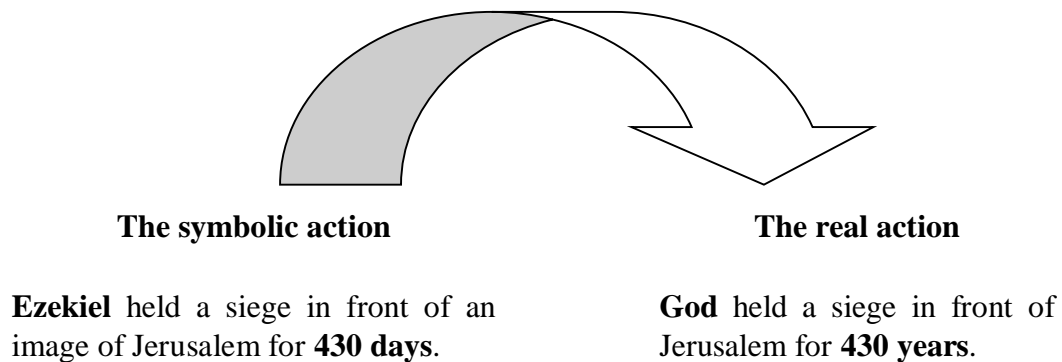

Did God keep Jerusalem under siege²² for 430 years?

A siege is established when a foreign army comes to a fortified city, builds a camp and, no matter how long it takes, pressures this city until its people capitulate. This is the military concept of a siege.

But let's suppose that Ezekiel was not portraying the human military siege that everybody has assumed, but instead a divine siege. Do we have the three basic elements: army, camp, city?

What is the mighty army? **The ark**, of course:

- Josh 3:4 But keep a distance of about a thousand yards between you and the ark; do not go near it."

²² If this siege lasted 430 years and ended with Jerusalem's destruction, it must have started during Solomon's reign.

- 1 Sam 4:6-7 when they learned that the ark of the LORD had come into the camp, the Philistines were afraid.
- 1 Sam 5:3 When the people of Ashdod rose early the next day, there was Dagon, fallen on his face on the ground before the ark of the LORD!
- 1 Sam 5:10 the people of Ekron cried out, "They have brought the ark of the god of Israel around to us to kill us and our people."
- 1 Sam 6:19 But God struck down some of the men of Beth Shemesh, putting seventy of them to death because they had looked into the ark of the LORD

Did it come to a new location? **It was brought to the Temple:**

- 1 Kings 8:3-4 When all the elders of Israel had arrived, the priests took up the ark, and they brought up the ark [*in the temple*]

Do we have a fortified camp? Yes, the **Holy of Holies inside the Temple:**

- Ezek 24:21 I am about to desecrate my sanctuary-**the stronghold** in which you take pride,
- 1 Kings 6:19-20 He prepared the inner sanctuary within the temple to set the ark of the covenant of the LORD there.
- 2 Sam 6:2-3 the ark of God, which is called by the Name, the name of the LORD Almighty, who is enthroned between the cherubim that are on the ark.
- Ezek 43:6-7 I heard someone speaking to me from inside the temple. He said: "Son of man, this is the place of my throne and the place for the soles of my feet.
- Ezek 9:3 Now the glory of the God of Israel went up from above the cherubim, where it had been, and moved to the threshold of the temple.
- 1 Kings 8:11 for the glory of the LORD filled his temple.
- 1 Kings 8:12-13 "The LORD has said that he would dwell in a dark cloud; I have indeed built a magnificent temple for you, a place for you to dwell forever."

The ark of the covenant, sitting in the inner sanctuary of the Temple was, for the people of Jerusalem, a constant reminder (430 years) of the alliance they had agreed with God.

- Ex 34:10 Then the LORD said: "I am making a covenant with you.

- Jer 25:6 Do not follow other gods to serve and worship them; do not provoke me to anger with what your hands have made
- Jer 44:4-6 Again and again I sent my servants the prophets, who said, 'Do not do this detestable thing that I hate!' But they did not listen or pay attention; they did not turn from their wickedness or stop burning incense to other gods. Therefore, my fierce anger was poured out; it raged against the towns of Judah and the streets of Jerusalem and made them the desolate ruins they are today.
- Jer 44:10 To this day they have not humbled themselves or shown reverence, nor have they followed my law and the decrees I set before you and your fathers.

The whole Temple was filled with the power of God:

- 1 Kings 8:10-11 When the priests withdrew from the Holy Place, the cloud filled the temple of the LORD. And the priests could not perform their service because of the cloud, for the glory of the LORD filled his temple.
- Ezek 24:21 I am about to desecrate my sanctuary-**the stronghold** in which you take pride,

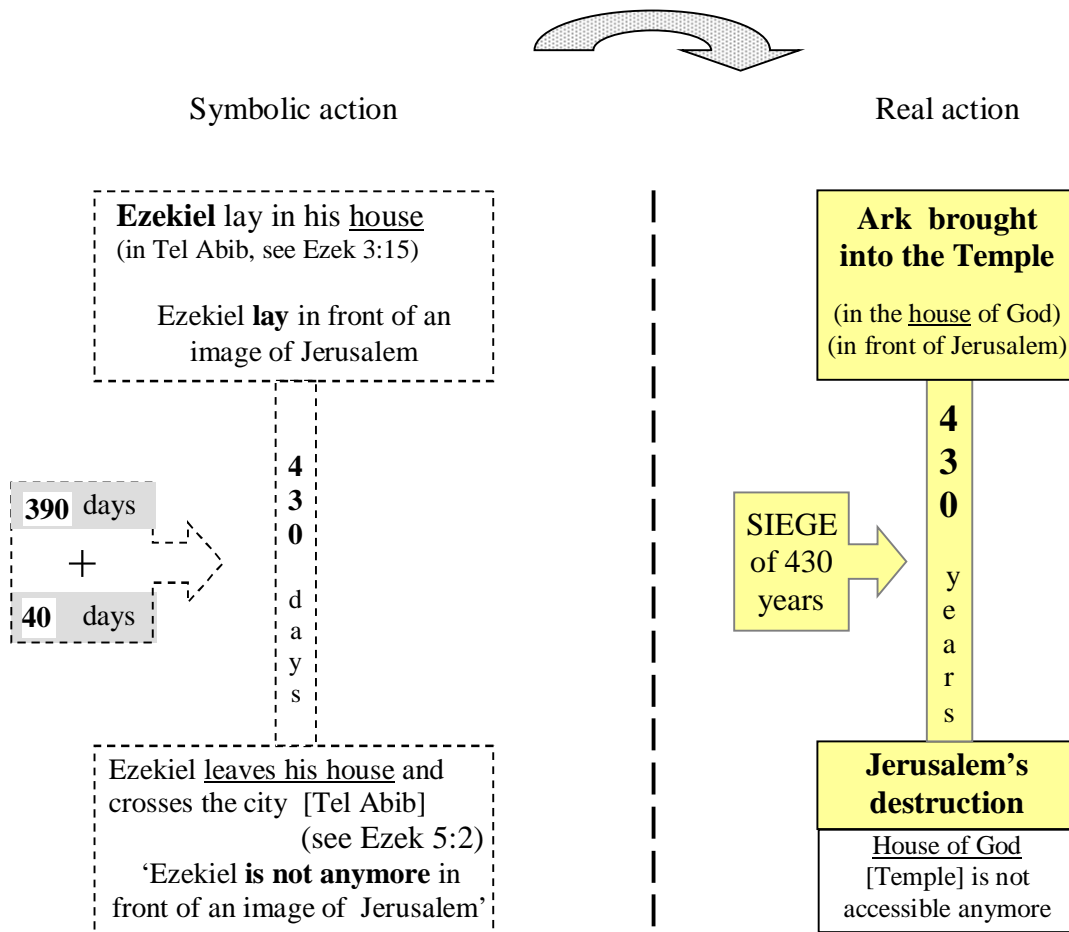

Figure 3. God's 430 years SIEGE

The Temple

The Temple built by Solomon was the third stage of a design conceived by God. Five of those stages are known, the first one was used in the book of Genesis and the last one belongs in the book of Revelation.

- | | | |
|---|--|---|
| #1. The Garden of Eden's layout (Genesis) | | It is outside the scope of this paper to discuss how each structure mirrors a unique pattern but under a different form. Suffice it to say that from the first structure to the last, elements had been evolving from their physical representation toward a spiritual counterpart in heaven. |
| #2. The Tabernacle of Moses (Exodus) | | |
| #3. Solomon's Temple (King) | | |
| #4. Ezekiel's Temple (Ezekiel) | | |
| #5. The heavenly Throne of God (Revelation) | | |

It is important for the comprehension of 'Ezekiel 4-5' to realize that because each structure shares the same design, we can borrow information supplied in one stage and apply it to the next stage (and vice versa).

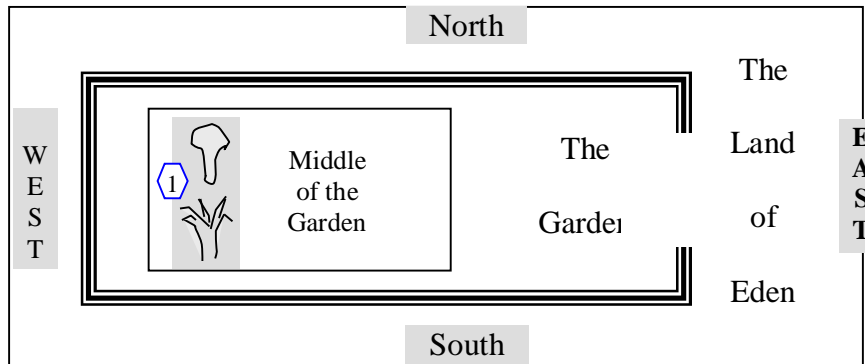

The Garden of Eden was in the Land of Eden. In the middle of the garden was a very special place where two unique trees were found. One was called the Tree of Life and the other the Tree of Good and Evil

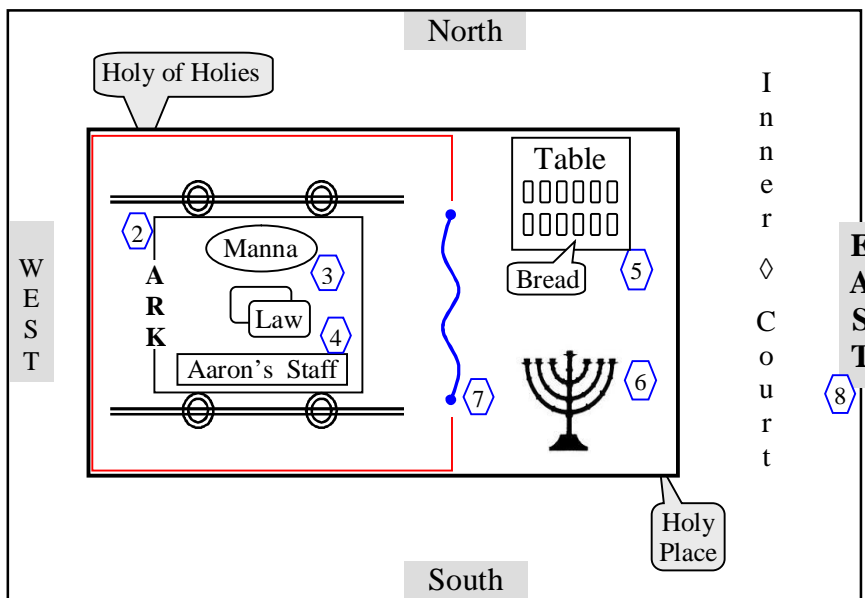

In the tabernacle of Moses, in the inner room called the Holy of Holies, was the Ark, that contained the Pot of Manna and Aaron's staff.

In the 2nd structure the pot of manna and Aaron's staff typify the tree of life and the tree of good and evil of the first structure. We know that Aaron's staff is related to almonds (Num 17:8-9) so it is probably the case for one of the two trees found in the middle of the garden.

① Gen. 2:9 In the middle of the garden were the tree of life and the tree of the knowledge of good and evil.

② In the Temple the Ark contained only the Law:

- 1 Kings 8:9 9 There was nothing in the ark except the two stone tablets that Moses had placed in it at Horeb, where the LORD made a covenant with the Israelites after they came out of Egypt.

But at Sinai there was also some manna and Aaron's staff:

- Heb. 9:4 This ark contained the gold jar of manna, Aaron's staff that had budded, and the stone tablets of the covenant.

A representation of the manna and Aaron's staff will be kept in the following schemas for their symbolic value.

③ Ex 16:34 Aaron put the manna in front of the Testimony,

Ex 16:33 So Moses said to Aaron, "Take a jar and put an omer of manna in it. Then place it before the LORD to be kept for the generations to come."

NOTE 1 : That was in Moses' Tabernacle

NOTE 2 : The Manna is situated on the north side since this is the side where the bread will be. See item 4.

④ Num. 17:8 Aaron's staff, which represented the house of Levi, had not only sprouted but had budded, blossomed and produced almonds.

NOTE 1 : That was in Moses' Tabernacle.

NOTE 2 : Aaron's staff is situated on the south side since this is the side where the lamp will be. See item 5.

⑤ Ex. 26:35 Place the table outside the curtain on the north side

Ex. 40:23 and set out the bread on it before the LORD

Lev. 24:6 Set them in two rows, six in each row,

⑥ Ex. 26:35 put the lampstand opposite it on the south side.

Ex. 25:32-33 Six branches are to extend from the sides of the lampstand—three on one side and three on the other. Three cups shaped like almond flowers with buds and blossoms are to be on one branch, three on the next branch, and the same for all six branches extending from the lampstand.

⑦ 2 Chron. 3:14 He made the curtain of blue, purple and crimson yarn and fine linen, with cherubim worked into it.

⑧ Two of the structures were facing 'EAST' and it must be the case for the others.

Garden of Eden: Gen. 2:8 Now the LORD God had planted a garden in the east, in Eden;

Ezekiel Temple : Ezek. 8:16 With their backs toward the temple of the LORD and their faces toward the east, they were bowing down to the sun in the east

Now, instead of visualizing Ezekiel in his home, we will depict him in the Temple²³ of Solomon..

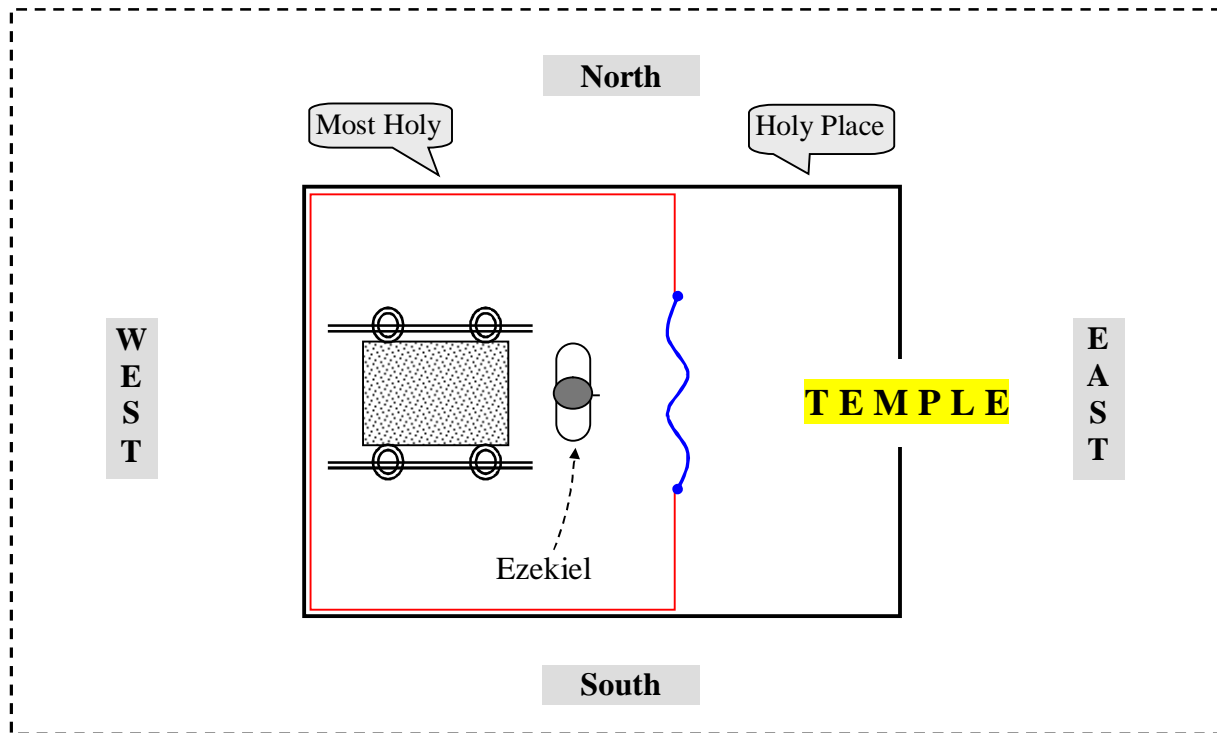

Figure 4. Temple of Solomon²⁴

Ezekiel was physically in his home when he lay on his side for 430 days, but he then was portraying the siege that was going on in the Temple of Solomon. With that in mind it is natural to symbolically represent Ezekiel in the Temple²⁵, the intended location of his action.

To help us analyze this siege we need a small artifice. We are going to borrow some of the features of Moses' Tabernacle and transpose them into Solomon's Temple; they will occupy the same position. Can we do that? Yes. Remember that Ezekiel's action is highly symbolic; it is a sign²⁶. Surely we are allowed some digression as long as it helps us understand the message we are being told.

The Tabernacle of Moses and the Temple of Solomon are two different structures sharing an identical design that was conceived by God.²⁷ Every piece of furniture found in them have a counterpart in the Heavenly Throne of God and occupy a very specific location in the design. To transpose them from one structure to the other²⁸ is not going to alter their symbolic value.

²³ Ezekiel was a priest. Ezek. 1:3 the word of the LORD came to Ezekiel the priest

²⁴ Of all the furniture found in Solomon's Temple only the Ark is shown here.

²⁵ Some years later Ezekiel was shown the future Temple. Ref : Ezek. 43:5 Then the Spirit lifted me up and brought me into the inner court, and the glory of the LORD filled the temple.

²⁶ Ezek. 4:3 This will be a sign to the house of Israel.

²⁷ Ezek. 43:11 make known to them the design of the temple-its arrangement, its exits and entrances-its whole design and all its regulations ... so that they may be faithful to its design

Before we continue with Ezekiel we need to alter our representation of the Temple of Solomon a little more and get closer to what it really looked like. The following representation is the subject of an entire paper, 'Secrets of the Holy Ark' by Tony Badillo²⁹.

The plan of the whole floor of the Temple depicted a human body whose face could be seen in the Holy of Holies.

From Tony Badillo's paper we learn that:

- The two cherubim standing behind the Ark, represented the eyes of the face
- The Ark with its poles on each side was the nose and its two nostrils
- There were two protuberances³⁰ indented in the veil by the two poles
- There was a stair separating the Holy of Holies from the Holy Place
- This stair portrays the mouth of the Temple face
- The Golden Altar was at the bottom of the stair

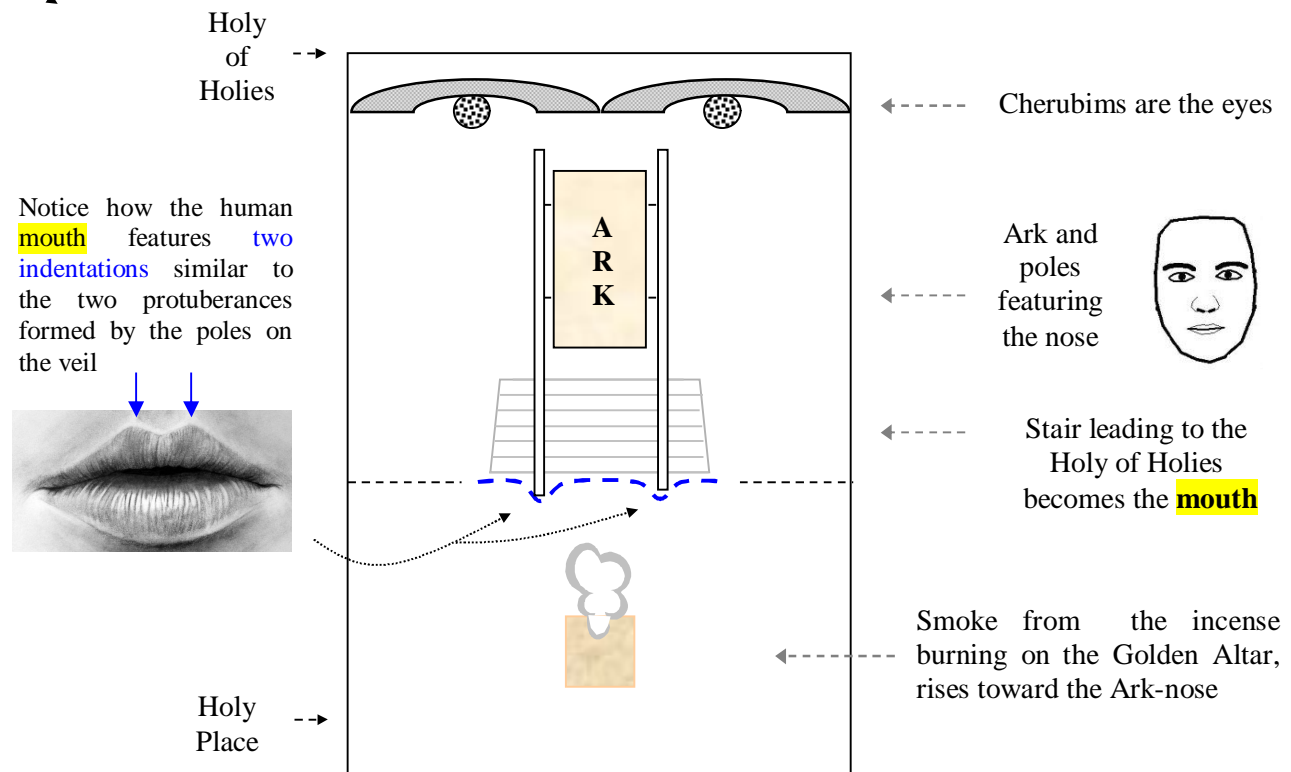

Figure 5 Temple Face

²⁸ The two structures are also directly linked to the 12 tribes of Israel. The Tabernacle of Moses was created at the start of the Exodus; it was eventually replaced by Solomon's Temple which lasted until all the 12 tribes had finally been sent into captivity.

²⁹ Use a search engine like Google.com to do a search with the following keywords:

Ark of the Covenant Secrets badillo

³⁰ 1 Kings 8:8 These poles were so long that their ends could be seen from the Holy Place in front of the inner sanctuary, but not from outside the Holy Place;

WALL OF IRON

There is an aspect of Ezekiel's re-enactment (Ezek. 4:) that has been quite puzzling and came as a complete surprise when I finally understood it. We first read that Ezekiel was told to draw 'carve' on a clay tile the city of Jerusalem (and its wall) and have all the military equipment needed for a siege leaned up against it:

- Ezek 4:1-3 "Now, son of man, take a clay tablet, put it in front of you and draw the city of Jerusalem on it. Then lay siege to it: Erect siege works against it, build a ramp up to it, set up camps against it and put battering rams around it.

And then we read this very unexpected statement:

- Ezek 4:3 Then **take an iron pan**, place it as an iron wall between you and the city and turn your face toward it.

If the tile with the carving of Jerusalem, the wall and the military apparatus, form a whole,

why was there a need to further add another wall (the iron pan) between Ezekiel and that tile?

Ezekiel

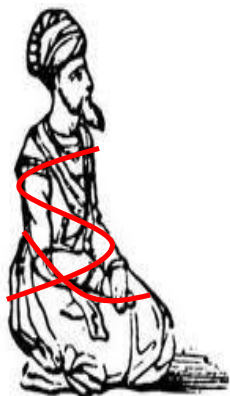

Iron pan



Tile



Ezekiel sketched the city of Jerusalem, the wall and the military arsenal on a fresh and newly made clay brick

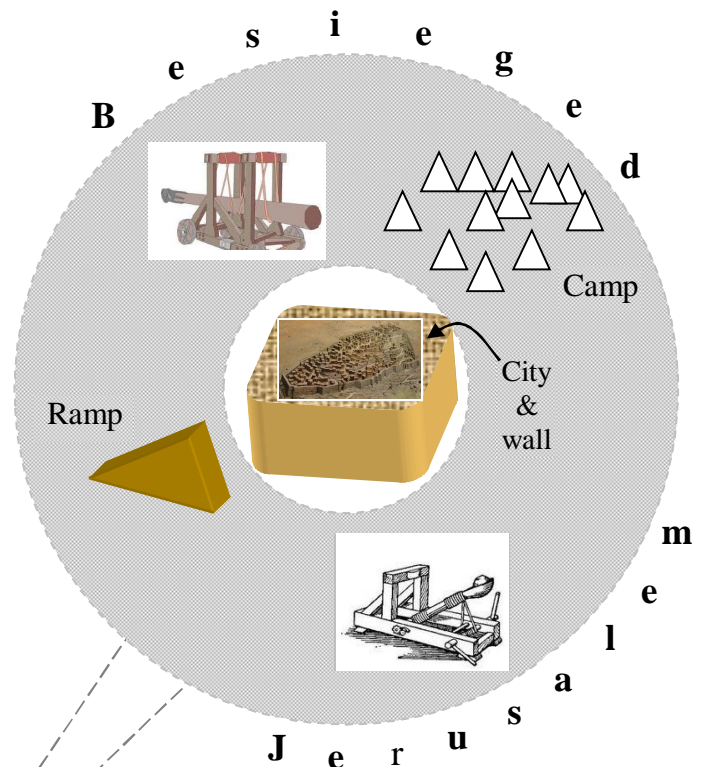

No matter how you look at it, **if** the iron wall (iron pan) was meant to be part of the military siege, it is wrongly located. But suppose the real purpose of the iron wall ('qiy'r') was to bring to mind a separation between two rooms (the Hebrew word 'qiy'r' refers to the internal or external wall of a house and has nothing to do with the wall of a city (chowmat)

Let's remember that although Ezekiel was physically lying in his home it was meant to represent him symbolically **lying in the Jerusalem Temple**. Doesn't this fact directly point to the real purpose of the 'iron pan'?

It is not an overstatement to say that the Temple's Holy of Holies was the most inaccessible location of Israel. The high priest was the only one to enter it and for a single day each year. However, the only thing that separated the most holy from the holy room was a **veil**. *Parochet*

- Ex 26:33 Hang the curtain from the clasps and place the ark of the Testimony behind the curtain. **The curtain will separate the Holy Place from the Most Holy Place**
- 2 Chron 3:14 He made the curtain of blue, purple and crimson yarn and fine linen, with cherubim worked into it.

That veil was as efficient as an IRON WALL.

Isn't it ironic that Ezekiel was told to use an 'IRON PAN' to represent this curtain? Iron was among the hardest material to be found at the time of Ezekiel while the veil offered hardly any resistance.

And there is more. Notice that Ezekiel was asked to turn³¹ his **face toward the iron pan** in front of him. By doing this he was portraying the **Temple's face**, in front of the **veil**, as depicted³² by the furniture in the Holy of Holies.

Notice also that during his siege Ezekiel was **tied up** in front of the **iron pan** (representing the veil). Isn't it quite appropriate that the **veil** separating the Holy of Holies from the Holy Place was crisscrossed with **gold chains**?

- 1 Kings 6:21 Solomon covered the inside of the temple with pure gold, and he extended gold chains across the front of the inner sanctuary, which was overlaid with gold.

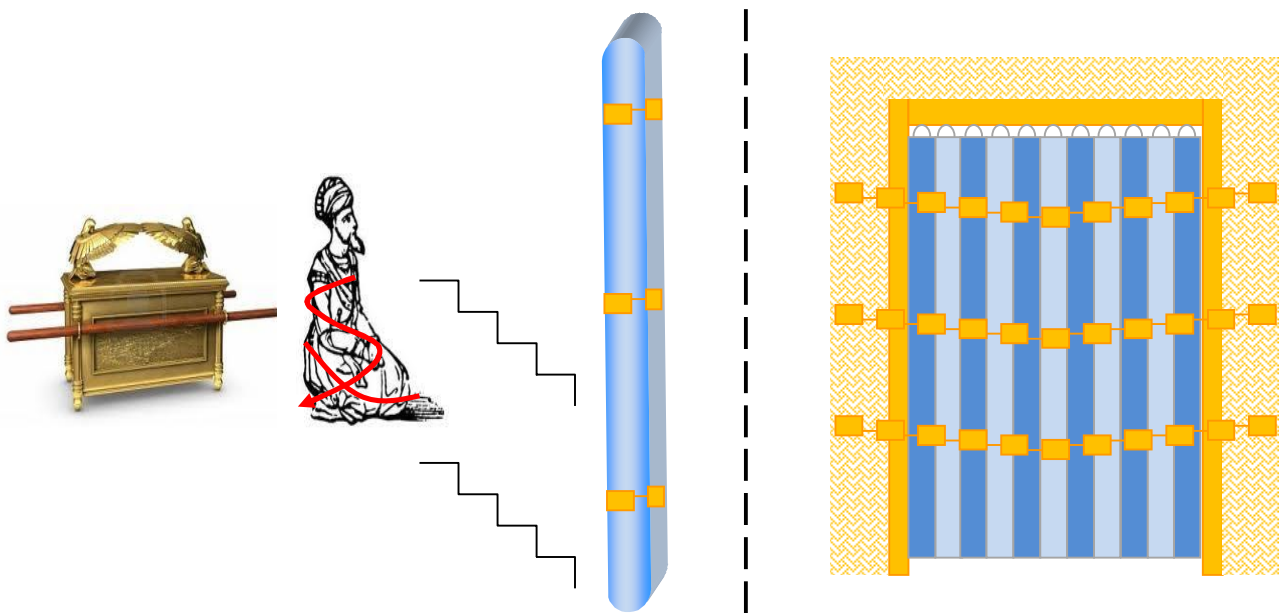

³¹ Ezek 4:3 Then take an iron pan, place it as an iron wall between you and the city and turn your face toward it.

³² See page 33 about the Temple's floor plan and Tony Badillo.

Ezekiel went through a cleansing ritual

Even though there is no direct reference to support it, we do have here a strong indication that Ezekiel's action **was really intended to show what was going on in the Temple.**

No commentator seems to have noticed it but Ezekiel, just before lying on his side for 430 days, went through the cleansing ritual that he described in Ezek. 44:26-27. This ritual was prescribed to the priests **before they entered the Temple.**

Ezek. 44:26-27 After he is cleansed, ¹
they shall count seven days ²
for him. And on the day that he goes to the sanctuary ³
to minister in the sanctuary,
he must offer his sin offering ⁴
in the inner court," says the Lord GOD ⁵

God's house

Now see how Ezekiel fulfilled each point:

1 Ezek. 2:1-3 Then **the Spirit entered me** when He spoke to me, and set me on my feet; and I heard Him who spoke to me. And He said to me: "Son of man, I am sending you to the children of Israel,

Ezek. 3:3 "Son of man, eat this scroll I am giving you and fill your stomach with it." So I ate it, and **it tasted as sweet as honey** in my mouth.

2 Ezek. 3:15 Then I came to the captives at Tel Abib, who dwelt by the River Chebar; and I sat where they sat, and remained there **astonished among them seven days.**

Ezek. 3:24 Then the Spirit came into me and raised me to my feet. He spoke to me and said: "**Go, shut yourself inside your house.**

3 Note: Just before that, Ezekiel had been in the presence of the Glory
Ezek 3:23 And the glory of the LORD was standing there... and **I fell face down**

4 Ezek. 4:10 Weigh out twenty shekels of food to eat each day and eat it at set times.

Ezek. 4:3 Then take an iron pan, place it as an iron wall between you and the city.

5 *The iron pan represents the veil and given that the pan was between Ezekiel and the city, Ezekiel's action put him symbolically in the Holy of Hollies.*

Ezekiel in his symbolic location with all the Temple's features in place

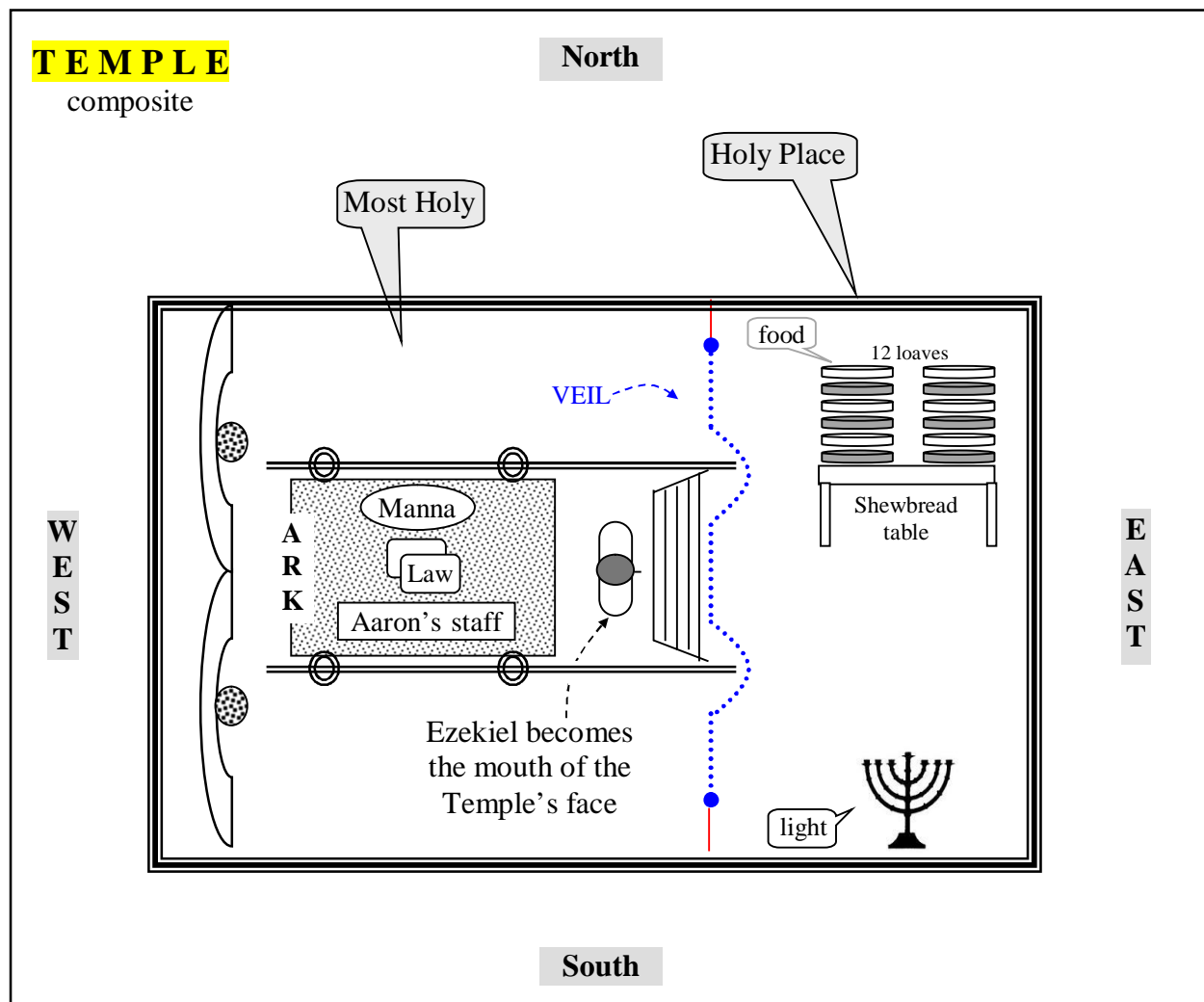

Notice that Ezekiel stands in front of the curtain, at the top of the stair, exactly where the **‘Temple’s mouth’** (see Temple Face on page 33) happens to be. This detail is of some importance given the number of times Ezekiel had previously been warned about speaking when it would be time:

Ezek 2:4 I am sending you to them, and you shall say to them ... NKJV

Ezek 2:7 You shall speak My words to them, NKJV

Ezek 3:1 "Son of man, eat what you find; eat this scroll, and go, speak to the house of Israel."

Ezek 3:4 "Son of man, go to the house of Israel and speak with My words to them.

Ezek 3:11 and speak to them and tell them, 'Thus says the Lord GOD,'

Ezek 3:26 I will make your tongue cling to the roof of your mouth ...

It is very meaningful to have Ezekiel (the **“Prophet”** of YHWH) the future Watchman of Israel (Ezek 33:7) becoming the **mouth** of the Temple’s face.

LEFT SIDE /RIGHT SIDE

Ezek 37:16 Then take another stick of wood, and write on it, '**Ephraim's** stick, belonging to Joseph and all the house of Israel associated with him.' NIV

Ezek 37:16 "Son of man, take a stick of wood and write on it, 'Belonging to **Judah** and the Israelites associated with him.' NIV

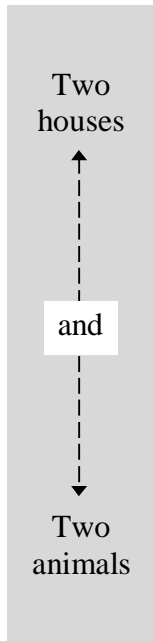

The house of Israel represented the 12 tribes and, since the 390 years of sin is attributed to the house of Israel (not the kingdom of Israel), the 390 years of sin involved the 12 tribes. The house of Israel was somewhat under the leadership of Joseph's son Ephraim, who was blessed profusely by Jacob:

- Jer 31:9 For I am a Father to Israel, And Ephraim is My firstborn. NKJV
And Ephraim is associated with a calf (a bull, an ox):
- Jer 31:18 "I have surely heard **Ephraim's** moaning: 'You disciplined me like an unruly **calf**,

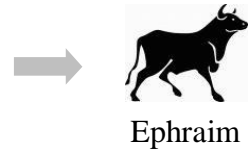

The house of Judah represented the tribes of Benjamin and Judah, since the 40 years of sin is attributed to the house of Judah, the 40 years of sin involve only those two tribes. The tribe of Judah assumed leadership of the house.

- Judah is associated with a lion:
- Gen 49:9 You are a **lion's** cub, O **Judah**;

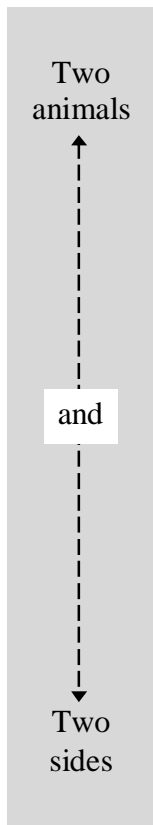
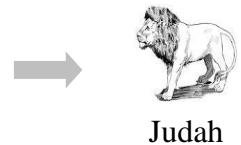

At the beginning of Ezekiel a creature with four faces was seen. This creature gives us the key to understand why the left side was attributed to the house of Israel and the right side to the house of Judah:

- Ezek 1:10 Their faces looked like this: Each of the four had the face of a man, and on the right side each had the **face of a lion**, and on the left the face of an ox;

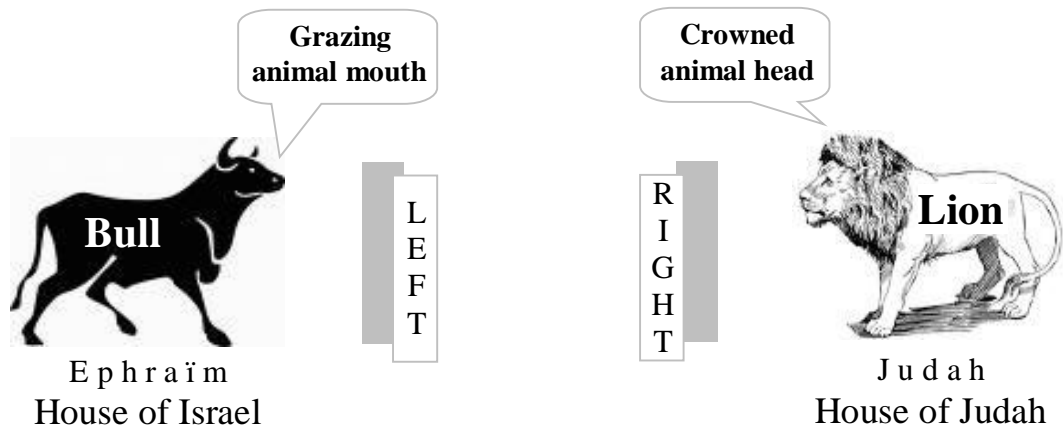

Notice that the left side is associated with a grazing animal (bull, cow, calf) whose distinctive feature is the activity of its mouth. However, for obvious reasons, the distinctive feature of the lion, associated with the right side, is its head (crowned with a mane, a symbol of majesty).

Ezekiel is lying on his left side for 390 days

For the first 390 days of his siege's re-enactment Ezekiel was lying on his left side:

- Ezek 4:5 For I have laid on you the years of their iniquity, according to the number of the days, three hundred and ninety days; so you shall bear the iniquity of the house of Israel. NKJV

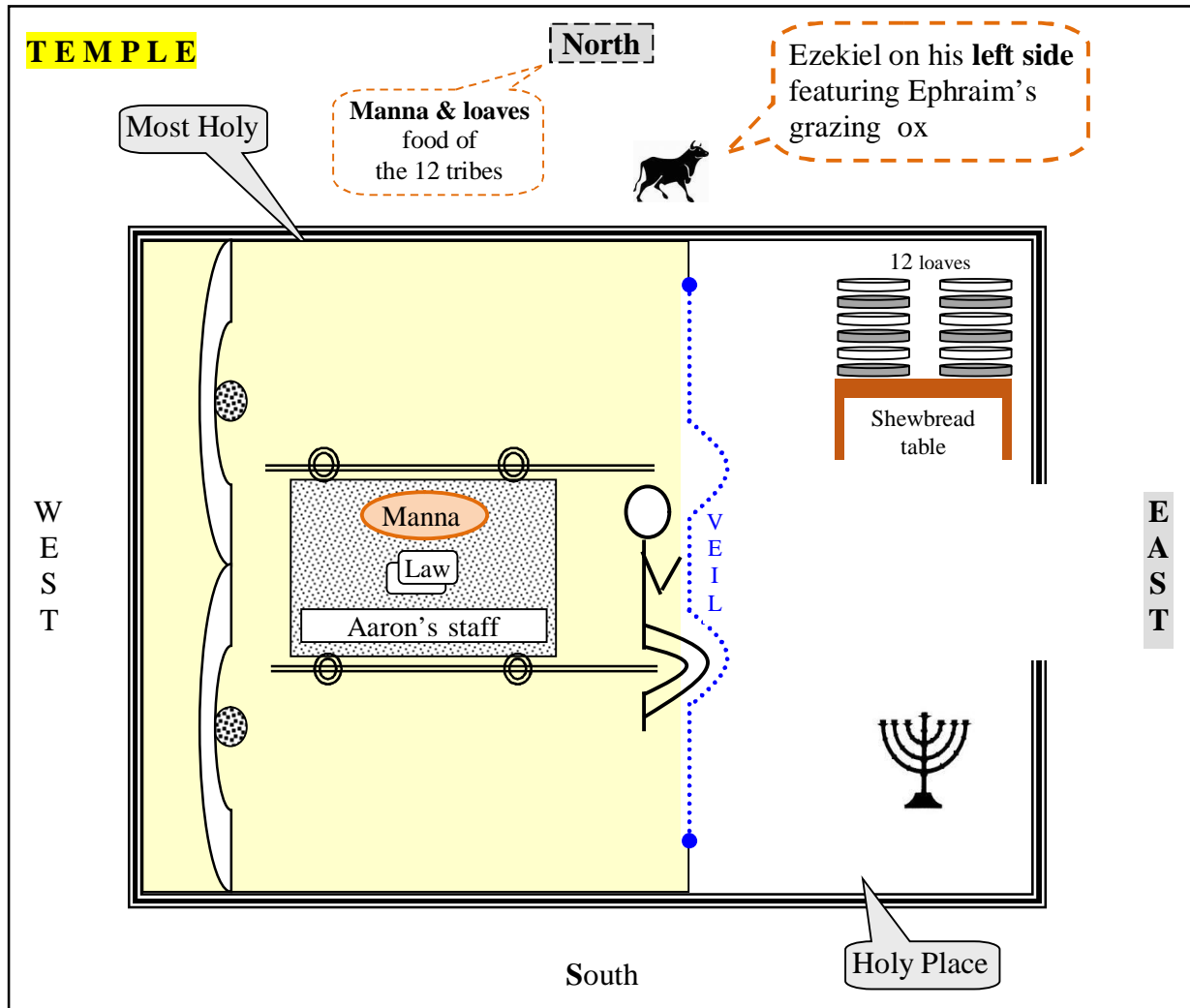

Figure 6. Ezekiel on his left side for 390 days (mouth toward north)

Notice: Ezekiel's mouth³³ on the north side with 'the food' of the temple

The first 390 days of Ezekiel's siege are characterized by his access to food:³⁴

- Ezek 4:9-10 Take wheat and barley, beans and lentils, millet and spelt; put them in a storage jar and use them to make bread for yourself. You are to eat it during the 390 days you lie on your side.

The two items³⁵ on the north side (borrowed from the Tabernacle) are related to **food** and characterize the **12 tribes** as abundantly blessed by God..

³³ The 'mouth' is the distinctive feature of the grazing ox representing Ephraim.

³⁴ There is no mention of food in the second part of Ezekiel's siege (40 days). This will be discussed later.

³⁵ Manna food of the 12 tribes at Exodus. And the 12 loaves representing the 12 tribes.

Ezekiel is lying on his right side for 40 days

For the second part of his siege, the last 40 days, Ezekiel was lying on his right side:

- Ezek 4:6 "After you have finished this, lie down again, this time on your right side, and bear the sin of the house of Judah.

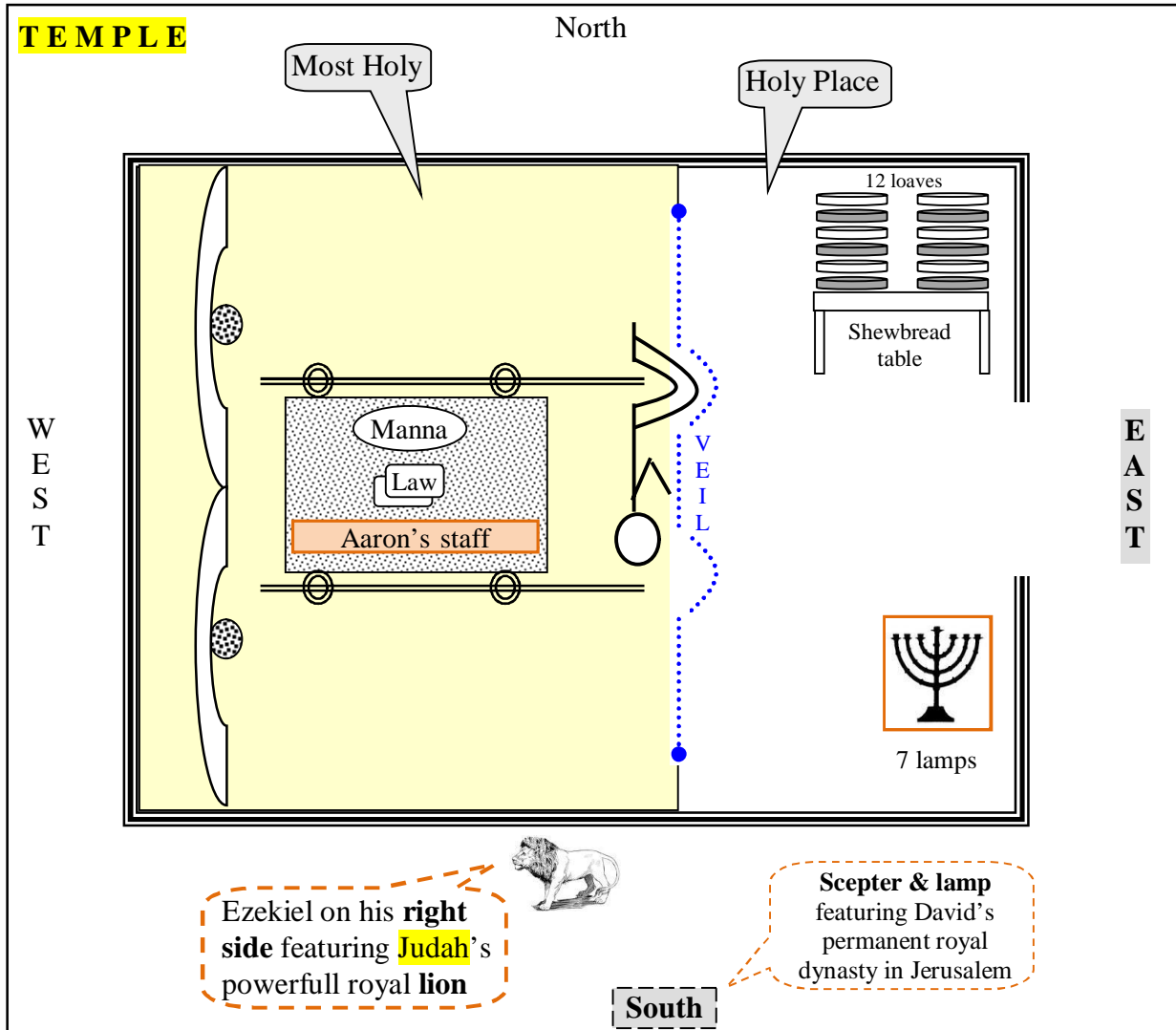

Figure 7. Ezekiel on his right side for 40 days (head toward south)

Notice: Ezekiel was not fed during the 40 days and as we should expect there is no trace of food on the south side.

Ezekiel's head³⁶ on the south side with the Temple's objects symbolizing 'authority'.

³⁶ The 'head', is the distinctive feature of the crowned lion representing Judah.

The two items on the south side (borrowed from the Tabernacle) characterize Judah³⁷ as a guide.

The STAFF

- Ezek 19:11 Its branches were strong, fit for a ruler's scepter.
- Gen 49:10 The scepter will not depart from Judah

Sceptre emblem and sign of power

Lamp = Monarch
2 Sam 1:17



The LAMP

- 1 Kings 11:36-37 I will give one tribe to his son so that David my servant may always have a lamp before me in Jerusalem, the city where I chose to put my Name.
- 2 Kings 8:19 Nevertheless, for the sake of his servant David, the LORD was not willing to destroy Judah. He had promised to maintain a lamp for David and his descendants forever.

Judah had to keep the scepter and by association, the law.

The start of the 40 years of sin is directly connected with the abandoning of the law:

- 2 Kings 21:8-9 if only they will be careful to do everything I commanded them and will keep the whole Law that my servant Moses gave them." But the people did not listen. Manasseh led them astray,

The end of the 40 years of sin came with the rediscovery of the book of the law:

- 2 Kings 22:3,11 In the eighteenth year of his reign, King Josiah ... When the king heard the words of the Book of the Law, he tore his robes.

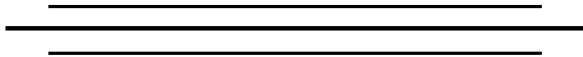

During the 390-year period of sin the Ark was under the care of the 12 tribes whose leadership was assumed (symbolically) by Ephraim. The **symbol of Ephraim is an ox**.

At the end of the 390 years of sin the Ark was removed from the house of Abinadab³⁸ and David attempted to bring it to Jerusalem by putting it on a cart that was drawn by **oxen**. It was a failure and the Ark was left at the house of Obed-Edom.

Three months later the Ark was successfully brought to Zion. This time the Ark was carried on the Levites' shoulders while they were following King David, a man crowned like a **lion**³⁹ (**Judah's symbol**).

The Ark coming to Jerusalem marks the end of Israel 390-year of sin

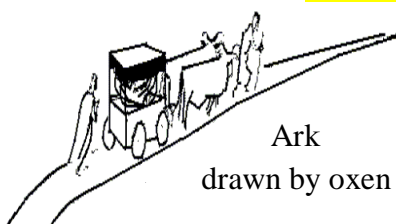

3 months later →



³⁷ According to Jacob's blessings (Gen 49:10) Judah is forever a ruler.

³⁸ See 2 Sam 6:3

³⁹ The Ark went from the Ox to the Lion, another way to show that it was leaving Ephraim to come to dwell in Judah.

We have already seen many small details to back up our deduction that Ezekiel's performance was meant to be set in the Temple (although it was physically held in his home). Here is a final piece of evidence to strengthen this conclusion.

Prior to going to his house for 430 days, Ezekiel was engulfed in a celestial vision of the Lord's throne (or celestial Temple). At one point in this vision, while he was (A) in the Lord's dwelling place, Ezekiel heard from (B) behind him the noise of flapping (D) wings belonging to (C) four living creatures:

- Ezek 1:5 Also from within it came the likeness of **four** living creatures. NKJV
- Ezek 3:12-13 Then the Spirit lifted me up, and I heard **behind** me a great thunderous voice: "Blessed is the glory of the LORD from **His place!**" **I also heard the noise of the wings** of the **living creatures** that **touch one another**, NKJV

Now, with the description of Ezekiel's vision in mind, let's see how each element of that vision can also be found in the Temple's composite that became Ezekiel's symbolic surroundings while he was lying in his own house.

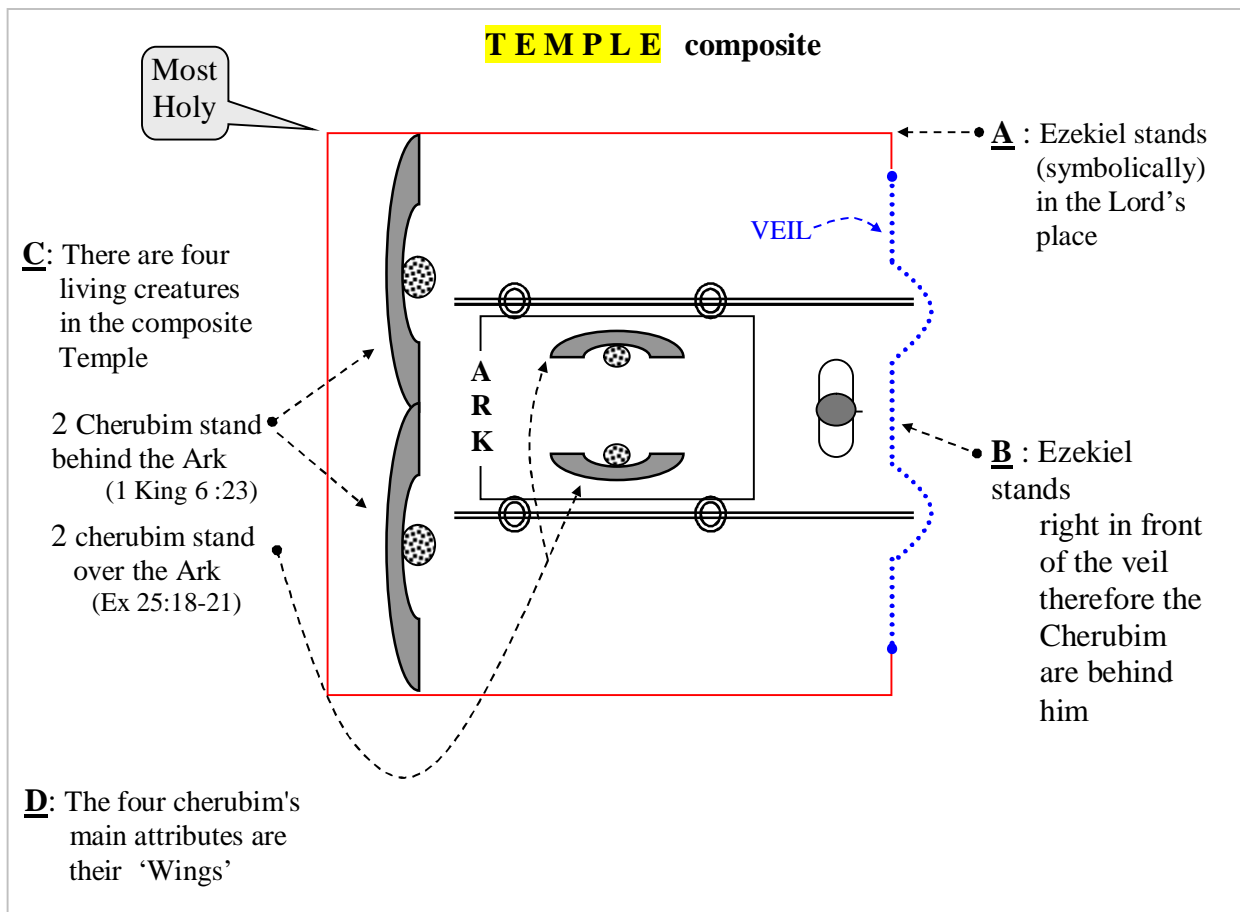

Can there be any doubts left when so many pieces point in the same direction?

Food and no food

A major difference between the two periods enacted by Ezekiel, while laying on his sides, has to do with food. For the first 390 days he was told to eat some food, which was not the case for the following 40 days. It is strange, isn't it? Why was Ezekiel not offered any food during the 40 days he was lying on his right side? No doubt Ezekiel had access to a supply of food; he had filled the jar himself at the beginning of the first period:

- Ezek. 4:9 "Take wheat and barley, beans and lentils, millet and spelt; put them in a storage jar and use them to make bread for yourself.

His access to all the water he wanted is even more obvious. Ezekiel was asked to measure it just before he drank it, but nowhere was he told that he had to stock it:

- Ezek 4:11 Also measure out a sixth of a hin of water and drink it at set times.

It is clear that God instructed Ezekiel to eat in the 390 days⁴⁰ of the first period and not in the following 40 days⁴¹, even though, as I believe, there was food and water available. There is only one word that can give light to the whole situation: FASTING.

40 days of fasting for the sin of Judah

This is a very interesting thought and it becomes quite convincing when we realize that the food on the first 390 days had a **dual purpose**. It was used to feed Ezekiel - he wouldn't have survived without food - but its main purpose was to be used as a SIN OFFERING.

A sin offering offered 390 times for the sin of Israel

According Lev 5:11-13 a sin offering couldn't have any oil and it was given to a priest. Ezekiel, a priest, didn't put any oil in his food. Notice also that Ezekiel had to eat at 'set time', as if he was following a ritual.

- Ezek 4:9 "Take wheat and barley, beans and lentils, millet and spelt; put them in a storage jar and **use them to make bread** for yourself.
- Ezek 4:10-11 And your food which you eat shall be by weight, twenty shekels a day; **from time to time** you shall eat it.

Ezekiel's food (sin offering) was corrupted when it was cooked over dung (Ezek 4:12-13). Unsurprisingly the 390 years period associated with it was also characterized by corruption:

- Hos 9:9 They have sunk deep into corruption, as in the days of Gibeah.

If a sin offering was appropriate for the 390-year of Israel, it would have apparently misrepresented the 40-year period of sin associated with the southern tribes (Judah & Benjamin). Let's not forget that Judah's fault was directly related to God's dwelling place, the inner room of the Temple.

⁴⁰ Have you notice that while on his left side, the side associated with the grazing animal, Ezekiel cooked his food (Eze 4:15) over a fire fueled with cow manure?

⁴¹ Another interesting fact: the left side is associated with grazing animals who feed and drink most of the time. Ezekiel on his left side had access to food and water every day. It was not the case when he turned on his right side and had to fast for 40 days. And what was the animal associated with the right side? A lion, an hunting animal that could go days without food and water.

Notice here God's reaction to what King Manasseh did in the Temple:

- 2 Kings 22:16-17 I am going to bring disaster on this place and its people, according to everything written in the book the king of Judah has read. Because they have forsaken me and burned incense to other gods and provoked me to anger by all the idols their hands have made, my anger will burn against this place and will not be quenched.
- Jer 6:2 I will destroy the Daughter of Zion, so beautiful and delicate.
- Jer 15:6 So I will lay hands on you and destroy you; I can no longer show compassion.

The abomination done in the Temple was not something that could have been associated with a sin offering. God was ready at the time to destroy the whole kingdom of Judah, but instead He allowed the fault to be atoned years later, by an act of the highest humility. Ezekiel would fast for 40 days. We shouldn't doubt that Ezekiel performed the proper action here; Moses had done the same at Sinai. Remember how the Israelites had made for themselves an idol cast in the shape of a calf while Moses was receiving the tablet of the law.

In response God was going to totally destroy Israel:

- Ex 32:9-10 "I have seen these people," the LORD said to Moses, "and they are a stiff-necked people. Now leave me alone so that my anger may burn against them and that I may destroy them. Then I will make you into a great nation."

Moses' 40 days fast and prayers saved the Israelites:

- Deut 9:18-19 Then once again I fell prostrate before the LORD for **forty days** and forty nights; **I ate no bread and drank no water**, because of all the sin you had committed, doing what was evil in the LORD's sight and so provoking him to anger. I feared the anger and wrath of the LORD, for **he was angry enough with you to destroy you**. But again the LORD listened to me.

Notice that Moses' fasting took place on God's mountain [Sinai] while Ezekiel's fasting was done in his house while he was symbolically re-enacting a siege that was going on in the [Temple] behind the veil. Both locations (Sinai and Temple) were the most sacred places in Israel's history.

There is much more to say about the 390 days of food and the 40 days without any. We will see later that these two periods were also among Ezekiel major symbolical acts.

Ref: Ezekiel ate defiled food for 390 days on page 70

Ezekiel fasts during 40 days on page 133

Why was there a need to tie Ezekiel during the 430 days of his siege?

- Ezek 4:8 I will tie you up with ropes so that you cannot turn from one side to the other until you have finished the days of your siege.

It is obvious in Eze 4:8 that Ezekiel was physically tied⁴² for the whole 430 days (390 + 40) of his siege. But to be tied for 430 days (even though he was allowed some free movements occasionally) is an awfully long time and we should seek an hidden meaning behind this very harsh treatment. Why did it have to be done that way? Was God afraid that Ezekiel wouldn't hold his position on each side and therefore needed to be tied? Absolutely not, Ezekiel was a priest whose entire life had been devoted to God.

- Ezek 4:14 Then I said, "Not so, Sovereign LORD! I have never defiled myself. From my youth until now I have never eaten anything found dead or torn by wild animals. No unclean meat has ever entered my mouth."

He didn't weep or lament when he lost his wife because he was told not to do so:

- Ezek 24:18 So I spoke to the people in the morning, and in the evening my wife died. The next morning I did as I had been commanded.

If the ropes were not used to force Ezekiel to obey then we have to conclude that they were used for a symbolical purpose.

It is said in Ezek 4:8 that the prophet could not turn on the other side before the right time. Thus Ezekiel was first portraying somebody tied for 390 days and then for 40 days. A two parts symbolical act that brought freedom at the end. Without surprise the Bible has nothing to say about anybody that could have been tied for 430 years (390 + 40). There is no mention neither of somebody tied for 430 days (390 + 40). But then, did we correctly understand what was meant by the rope symbol?

What if the ropes that were put on Ezekiel were not meant to symbolize somebody tied? What if those ropes were no more than an artifact used to symbolize somebody held prisoner? By binding Ezekiel, wasn't it the proper way to represent somebody confined in a specific location?

- Ezek 3:25 And you, son of man, they will tie with ropes; you will be bound so that you cannot go out among the people.

⁴² The reader is already aware that Ezekiel was **tied** in front of an iron wall which symbolised the veil of the Holy of Holies. That veil was also criss-crossed by **chains**. See discussion on Iron Wall on page 35.

If we are right about this we should be able to find an important individual who had been in prison for 430 days⁴³ and did recover his freedom at the end of a siege. Don't we have the perfect candidate in the person of Jeremiah the prophet?

- Jer 38:6 So they took Jeremiah and put him into the cistern NIV
- Jer 38:28 Now Jeremiah remained in the court of the prison until the day that Jerusalem was taken.

Ezekiel lying on his left and right sides while being tied up	
430 days	
390 days	40 days
food	no food

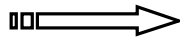

Jeremiah kept prisoner	
430 days ?	
390 days ?	40 days ?
Bread	No food



Jer 38:6 They lowered Jeremiah by ropes into the cistern



In a cistern
Jer 38:6

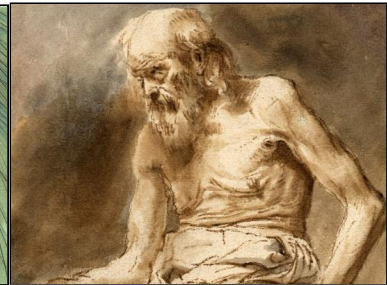

In the yard
Jer 38:28

Jeremiah's story doesn't specify that he was held prisoner exactly 430 days but a careful reading of the book of Jeremiah and an understanding of the sequence of events surrounding Nebuchadnezzar's siege against Jerusalem, do strengthen this belief. **Furthermore** Jeremiah was held captive in **two different locations**. First in a **cistern** in which he was **feed** (Jer 37:21) every day, then in the **court of the prison** at a time where there was **no more food** in the city (Jer 38:9)

The timeline of Jeremiah's actions

- #1. Nebuchadnezzar attacked Jerusalem in Zedekiah's 9th year, 10th month, 10th day. (This is **about 560 days** before Jerusalem was captured in the 11th year, 4th month, 9th day of Zedekiah): See Jer 52:4 and 2 Kings 25:1
- #2. While Jerusalem and a few other cities were still resisting, Jeremiah told King Zedekiah that he and the city would be captured but the King would die peacefully: (Jer 34:2-7). Zedekiah made a covenant to free all the slaves (Jer 34:8-9). Then **Nebuchadnezzar ended the siege of Jerusalem** (Jer 37:5). The King didn't maintain the covenant and everybody took back their slaves: (Jer 34:11, Jer 34:16). Jeremiah announced that Nebuchadnezzar would be back (Jer34:21-22, 37:7-8)

⁴³ in this context we discard a 430-year period as it wouldn't make any sense

IN PRISON - - - - -

- #3. Jeremiah wanted to leave Jerusalem but was arrested and accused of trying to join the then leaving Babylonian army (Jer 37:4, 37:11-12, 37:15-16).
- #4. As prophesied earlier (see #2) the Babylonian army came back.
- #5. King Zedekiah who was worried about what was going to happen to him, had Jeremiah brought to the palace for questioning: See Jer 37:17. Jeremiah was fearing for his life in the dungeon (Jer 37:20-21). While a prisoner Jeremiah bought a field (Jer 32:1-3, 32:6-7)

#6. **Turning point No more bread** - - - - -

Zedekiah inquires from Jeremiah (Jer 21:1-2) and was told about the imminent destruction of Jerusalem (Jer 21:7, 38:2). Pashur and his men had previously lowered Jeremiah in a dungeon (cistern) to kill him (Jer 38:6). The Cushite Ebed-Melech rescued Jeremiah after telling the King that Jeremiah would die if he was kept in the dungeon since **there was no more bread in the city:**

- Jer 38:9 ... For there is no more bread in the city." NKJV

#7. With the bread gone, the famine started.

- Ezek 4:16-17 Son of man, surely I will cut off the supply of bread in Jerusalem; they shall eat bread by weight and with anxiety, and shall drink water by measure and with dread, that they may lack bread and water, and be dismayed with one another,
- Lam 4:9 Those killed by the sword are better off than those who die of famine; racked with hunger, they waste away for lack of food from the field.
- Lam 2:20 Should women eat their offspring, the children they have cared for?

#8. People dying everywhere. The food was completely gone, the wall was broken and the city was captured:

- Jer 52:6 By the **ninth day of the fourth month** the famine in the city had become so severe that there was no food for the people to eat
- Jer 38:28 Now Jeremiah remained in the court of the prison until the day that Jerusalem was taken. And he was there when Jerusalem was taken.
- Jer 39:2 In the eleventh year of Zedekiah, in the fourth month, on the ninth day of the month, the city was penetrated.

Given that the length of Ezekiel's siege is divided into two periods of time (390 and 40 days), was Jeremiah's stay in prison also divided in a similar way?

E Z E K I E L	3 9 0	<p>During the first 390 days Ezekiel had access to food</p> <ul style="list-style-type: none"> Ezek 4:9 "Take wheat and barley, beans and lentils, millet and spelt; put them in a storage jar and use them to make bread for yourself. You are to eat it during the 390 days you lie on your side 	o n h i s
	Turning point (Ezekiel starts fasting)		s i d e s
	4 0	<p>During the following 40 days Ezekiel was fasting (already discussed in this work)</p>	

In each case the turning point is related to **food**.

J e r e m i a h	? 3 9 0 ?	<p>In the first part (points #3, #4, #5 of the previous chronology of Jeremiah) there was food in Jerusalem and we are told that Jeremiah received his daily bread:</p> <ul style="list-style-type: none"> Jer 37:21 King Zedekiah then gave orders for Jeremiah to be placed in the courtyard of the guard and given bread from the street of the bakers each day until all the bread in the city was gone. 	i n P r i s o n
	Turning point (No more bread)		
	? 4 0 ?	<p>In the second part (points #6, #7, #8) the famine progressed in the city.</p> <p>This period started when Jeremiah was put in a dungeon and the King was told that there was no more bread in the city:</p> <ul style="list-style-type: none"> Jer 38:9 and he is likely to die from hunger in the place where he is. For there is no more bread in the city." NKJV <p>At the end of the period (which corresponds to the end of Jeremiah's imprisonment) there is no more food in the city:</p> <ul style="list-style-type: none"> Jer 52:6 By the ninth day of the fourth month the famine in the city had become so severe that there was no food for the people to eat. <p>We know that this period had to be short (40 days?); point #7 describes the terrible conditions that prevailed in the city once the food started to become scarce.</p>	

As mentioned a few pages back we won't find in Jeremiah's writing any confirmation that his imprisonment lasted exactly 430 days and that it was divided into an initial period of 390 days followed by a period of 40 days. **We got those numbers by recognizing in Ezekiel's binding a symbolic reference to Jeremiah's imprisonment.** Nevertheless, not having a direct statement from Jeremiah about those numbers doesn't mean he left us clueless.

We are told that Jeremiah was arrested during the period of Nebuchadnezzar's interrupted siege (see #3 earlier). We are also told that the people abandoned the covenant they had made when they realized that Nebuchadnezzar was not threatening them anymore. This betrayal of the covenant led to the return of Nebuchadnezzar, which in turn led King Zedekiah, in the 10th year of his kingship, to consult Jeremiah.

All those events happened in a short time and given that we are told that King Zedekiah met Jeremiah sometime in the 10th year of his Kingship⁴⁴, we know they all happened between the 480th and the 98th day before the capture of Jerusalem⁴⁵.

Fixing Jeremiah's whole imprisonment to 430 days
is in agreement with 'between 480 and 98 days'.

The famine that prevailed at the end of Nebuchadnezzar's siege started when the bread became unavailable and ended when the food was also gone completely. This progression couldn't have evolved in just a few days; it had to last several weeks. Indeed, Ezekiel implied that the famine would be progressive:

- Ezek 5:16 I will bring more and more famine upon you and cut off your supply of food.

Another important fact about this famine is that one third of the population died from starvation and sickness:

- Ezek 5:12 A third of your people will die of the plague or perish by famine inside you

Before they started dying from starvation the people had been desperately eating any possible scrap of food they found. In the end they even ate their own flesh (see #7). We shouldn't doubt that it must have taken weeks of privation and starvation before they persuaded themselves to do such a terrible thing:

- Ezek 4:17 They will be **appalled at the sight of each other** and will waste away because of their sin.
- Lam 4:9 Those killed by the sword are better off than those who die of famine; racked with hunger, **they waste away for lack of food** from the field.

Fixing Jeremiah's second part of imprisonment to 40 days
is in agreement with the progression of the famine just described.

⁴⁴ Jer 32:1 This is the word that came to Jeremiah from the LORD in the tenth year of Zedekiah king of Judah, which was the eighteenth year of Nebuchadnezzar.

⁴⁵ Not knowing in what part of the 10th year of Zedekiah those events took place we use the earliest (First day of the 10th year) and the latest (last day of the 10th year). Zedekiah was captured in the fourth month of his 11th year.

Prophecy against the siege of Jerusalem

- Ezek 4:7 Therefore thou shalt set thy face toward the siege of Jerusalem, and thine arm shall be uncovered, and thou shalt prophesy against it. KJV

By using the words '**against it**' the translators of Ezek 4:7 may have misled us into believing that Ezekiel was going to prophesy about (against) Nebuchadnezzar's future siege of Jerusalem. This is doubtful that it was the purpose. What would he have accomplished by prophesying for 430 days about the coming destruction of Jerusalem? Who would have benefited from it? Ezekiel was confined in the privacy of his home where he might have been, as far as we know, alone most of the time.

As an alternative to the words 'against it' I suggest using '**upon it**'. At once it introduces the possibility that Ezekiel was simply asked to perform an act of prophesying while he was looking toward the sketch he had drawn on a tile (which represented the siege of Jerusalem).

We don't know what Ezekiel was prophesying about, but it doesn't matter given that

he was not doing it to inform anybody.

What nobody understood until now is the fact that Ezekiel's prophesying was done as **an independent symbolic act**. In this particular case it was the act of 'prophesying' in itself that was used to reveal something hidden rather than the information that was prophesied.

T H E P R O P H E T

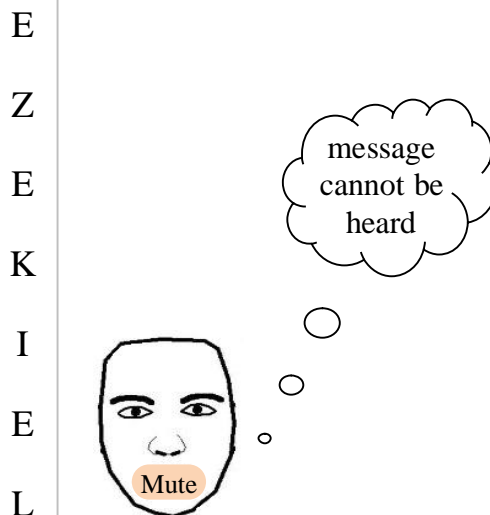

Similar to the other symbolic acts⁴⁶ that he had performed during the same period of 430 days, this new one was also done according to the established pattern: during the first 390 days the prophet prophesied while lying on his left side (House of Israel), and during the following 40 days he prophesied while lying on his right side (House of Judah).

As we will see in the following pages, we can point to two different periods (**390 years and 40 years**) of Israel's history during which prophetic communication was a major characteristic

⁴⁶ Like lying on his sides, eating food, being tied.

390 years of prophecy for the House of Israel (North side)

In all likelihood the first period portrayed by Ezekiel's prophesying starts with "Moses' escapes from Egypt" and ends with the 'capture of the Ark'.

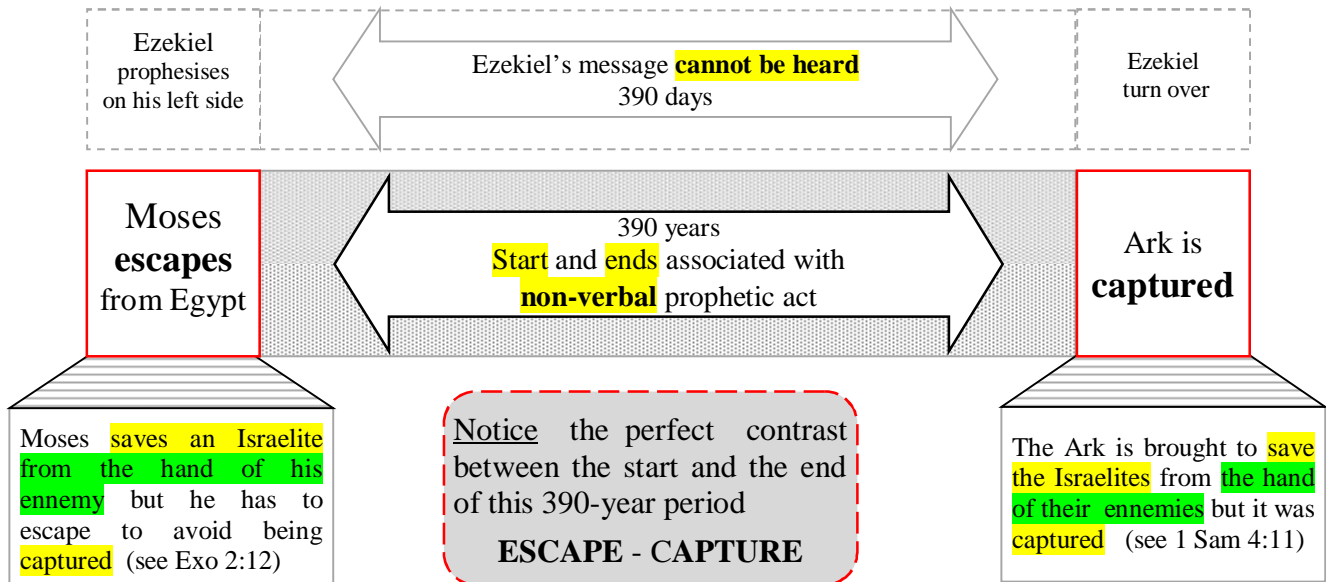

Escape from Egypt

Was Moses' escape a prophetic event and does it qualify for the start of any period? The answer to both questions is yes. In fact, we will see that "Moses' escape from Egypt" not only started '390 years of prophetic events' it also marks the beginning of a series of events that went on for 40 years and whose echo can be found during the 40 years of the Exodus. A more appropriate way to view these first 40 years of our '390 years of prophetic events' would be to recognize that they make up Moses' phantom Exodus.

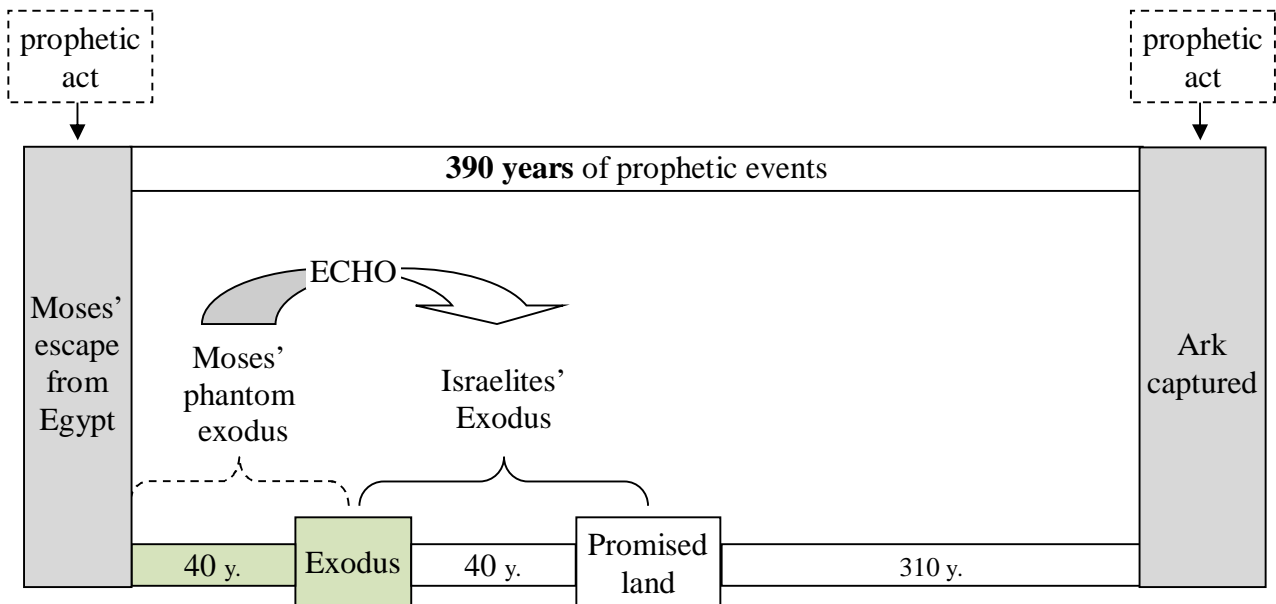

Here we have 10 events that took place during Moses' phantom exodus and are echoed during the Israelites' Exodus.

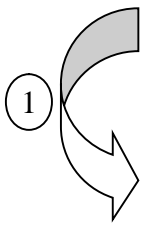

Moses sees his people's hardship:

- Ex 2:11 and it came to pass in those days, when Moses was grown, that he went out unto his brethren, and looked on their burdens KJV

God see his people's hardship:

- Ex 3:7 And the LORD said, I have surely seen the affliction of my people which are in Egypt, and have heard their cry by reason of their taskmasters; for I know their sorrows; KJV.
-

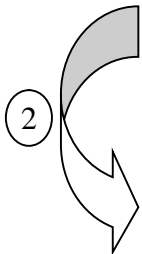

Moses rescues one Israelite:

- Ex 2:11 and he spied an Egyptian smiting an Hebrew, one of his brethren. KJV

Moses rescues every Israelite:

- Ex 3:10 and I will send thee unto Pharaoh, that thou mayest bring forth my people the children of Israel out of Egypt. KJV
-

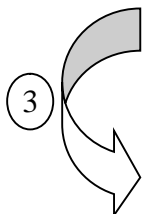

Moses kills an Egyptian soldier and **buries him in the sand:**

- Ex 2:12 he slew the Egyptian, and hid him in the sand. KJV

Moses would **bury** the whole Egyptian army **in the water:**

- Ex 14:28 And the waters returned, and covered the chariots, and the horsemen, and all the host of Pharaoh that came into the sea after them; there remained not so much as one of them. KJV
-

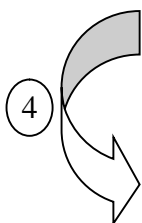

Moses is told by an Israelite that he isn't his Judge:

- Ex 2:14 Who made thee a prince and a judge over us? KJV

Moses becomes ruler and Judge over every Israelite:

- Ex 18:13 And it came to pass on the morrow, that Moses sat to judge the people: and the people stood by Moses from the morning unto the evening. KJV

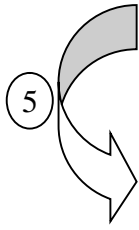

Pharaoh plans to kill Moses but he will never see him again:

- Ex 2:15 Now when Pharaoh heard this thing, he sought to slay Moses.

Pharaoh [a different one] threatens Moses that he will kill him next time he sees him but they will never meet again:

- Ex 10:28 And Pharaoh said unto him, Get thee from me, take heed to thyself, see my face no more; for in that day thou seest my face thou shalt die. KJV
-

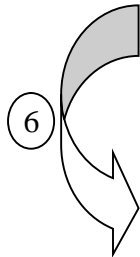

Moses flees from Egypt to avoid being captured:

- Ex 2:15 Now when Pharaoh heard this thing, he sought to slay Moses. But Moses fled from the face of Pharaoh, and dwelt in the land of Midian KJV

Moses helps all of Israel to flee from Egypt and regain their freedom:

- Ex 12:31-33 ... Rise up, and get you forth from among my people, both ye and the children of Israel; and go, serve the LORD, as ye have said. .. And the Egyptians were urgent upon the people, that they might send them out of the land in haste; KJV

Note: Pharaoh authorized Israelites to take a three-day journey to worship their God. Pharaoh never authorized them to leave permanently. We can therefore say that Moses and all the Israelites escaped from Egypt.

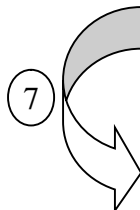

Moses leaves Egypt and crosses a desert.

(It is here assumed that the Medianites' land borders a desert.)

The Israelites leave Egypt and cross the sea:

- Ex 14:22 And the children of Israel went into the midst of the sea upon the dry ground: and the waters were a wall unto them on their right hand, and on their left. KJV
-

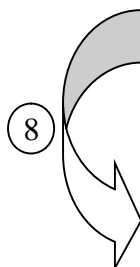

Moses goes to the Sinai and talks to God:

- Ex 3:4 God called unto him out of the midst of the bush, and said, Moses, Moses. And he said, Here am I. KJV

The Israelites go to the Sinai and hear God talking to Moses:

- Ex 19:9 And the LORD said unto Moses, Lo, I come unto thee in a thick cloud, that the people may hear when I speak with thee, and believe thee for ever. KJV
- Ex 19:18-19 and the whole mount quaked greatly. And when the voice of the trumpet sounded long, and waxed louder and louder, Moses spake, and God answered him by a voice. KJV



9

At the end of 'Moses' phantom exodus' one of his sons (it could be both), born in the wilderness, is circumcised:

- Ex 4:25 Then Zipporah took a sharp stone, and cut off the foreskin of her son, KJV

At the end of the Israelites' Exodus, all those born in the wilderness are circumcised:

- Josh 5:3 And Joshua made him sharp knives, and circumcised the children of Israel at the hill of the foreskins. KJV
 - Josh 5:5 but all the people that were born in the wilderness by the way as they came forth out of Egypt, them they had not circumcised. KJV
-



10

Moses' phantom Exodus could have lasted 40 years:

- Acts 7:23 And when he was full forty years old, it came into his heart to visit his brethren the children of Israel. KJV
- Ex 7:7 And Moses was [80] years old, and Aaron [83] years old, when they spake unto Pharaoh. KJV

NOTE: To those who might be reticent to accept any reference from the book of Act, I suggest that they **postulate** from here on that Moses was 40 years old when he fled from Egypt and that the Exodus occurred 40 years later. At the end of this 'paper' they will be in a much better position to evaluate the soundness of this postulate.

Israel's Exodus lasted 40 years:

- Num 14:33 And your children shall wander in the wilderness forty years, KJV
-

Ark captured (End of the 390 years)

We have seen that the start of the 390 (prophetic) years was initiated by the 'escape of Moses from Egypt', an event symbolizing the exodus that was about to occur for the twelve tribes.

At the opposite end of the period, 390 years later, a calamity that must have been felt by every member of the twelve tribes took place. At the time, some of the tribes were engaged in a battle against their oppressors, the Philistines. Expecting that it would bring them some divine help, the Israelites brought the Ark of the Covenant onto the battlefield. They were defeated and the Philistines took the Ark with them.

Before saying more about the 'capture of the Ark', here is a cursory layout that shows how these 390 years (of prophecy) relate to others events.

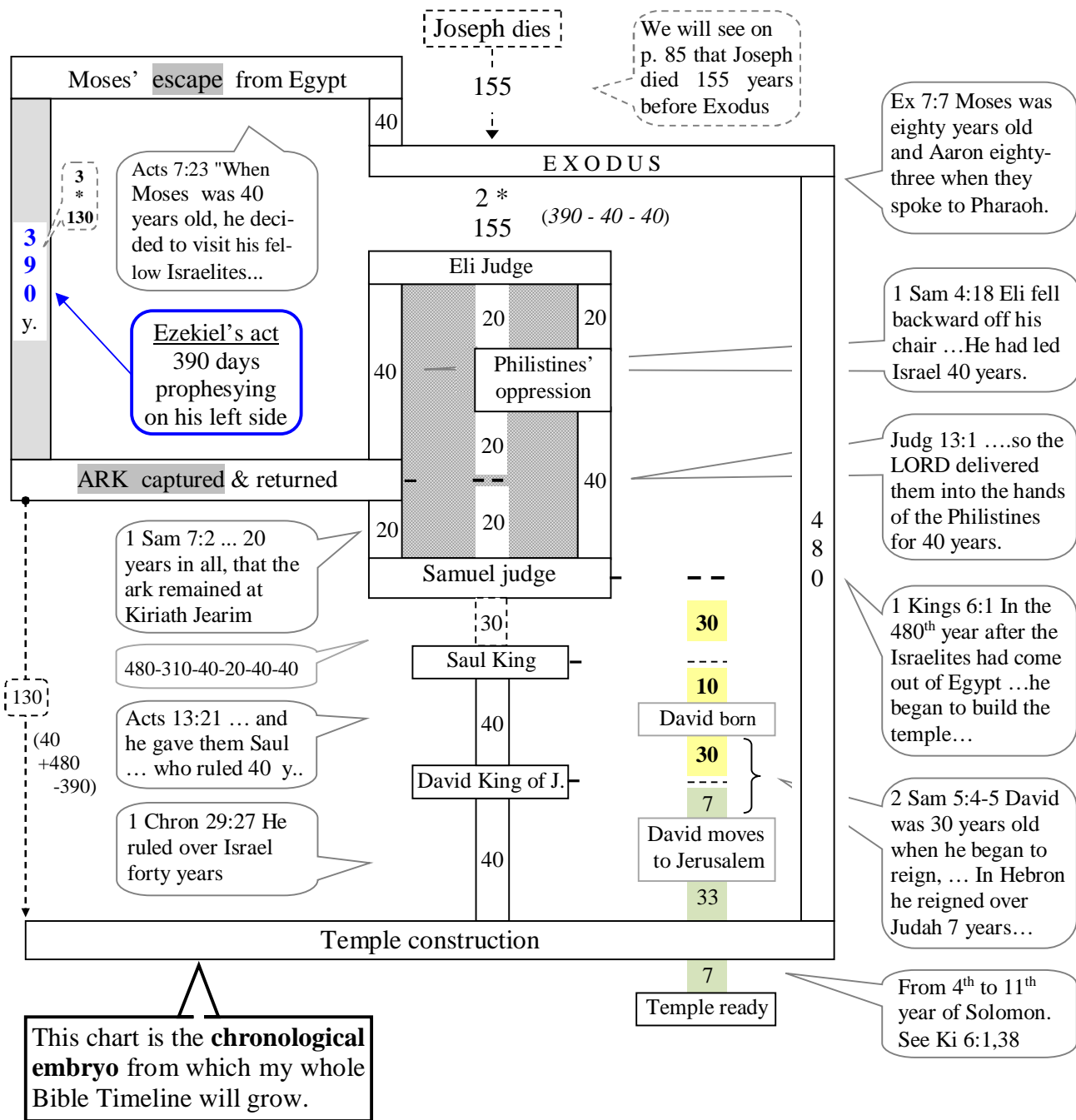

Besides having conveniently happened 390 years⁴⁷ after “Moses’ escape from Egypt”, did the ‘capture of the Ark’ mark the end of this ongoing ‘prophetic’ period? We need to keep in mind that there was a break after Ezekiel’s first 390 days of prophesying. When he turned over, his action was fully accomplished in regard to the House of Israel. The finality expressed in Ezekiel’s action (turning over) had to be found also at the end of the 390 year period that we are looking at.

But to our question we can answer a strong ‘yes’. The Capture of the Ark was nothing less than God’s proclamation that He was leaving his dwelling place in Shiloh:

- 1 Sam 4:22 She said, "The glory has departed from Israel, for the ark of God has been captured."

⁴⁷ This is part of the hidden information found in Ezekiel 4.

The Ark never came back to Shiloh after its capture. The departure was permanent. The capture of the Ark was a prophetic event that had been hinted to Samuel some years earlier:

- 1 Sam 3:11 And the LORD said to Samuel: "See, I am about to do something in Israel that will make the ears of everyone who hears of it tingle.

Samuel was informed of the future capture of the Ark while lying in the Temple. We can hardly fail to see the connection with Ezekiel 'symbolically' lying in the Temple while indirectly portraying Samuel in the same situation:

- 1 Sam 3:9,15 So Eli told Samuel, "Go and lie down, and if he calls you, say, 'Speak, LORD, for your servant is listening.'" So Samuel went and lay down in his place... Samuel lay down until morning and then opened the doors of the house of the LORD.
- Ezek 4:4 "Then lie on your left side and put the sin of the house of Israel upon yourself.

Parallels between Moses and Samuel

- The start of the 390 years began with a prophetic sign performed by Moses (his **escape from** Egypt) and ended with a prophetic sign revealed to Samuel some time before it occurred (Ark's **capture**).
- Both prophets (Moses and Samuel) were highly regarded in the eyes of God:
 - Jer 15:1 Then the LORD said to me, "Even if Moses and Samuel stood before Me, My mind would not be favorable toward this people.
- Moses was the first judge of Israel. (He is the one who anointed the first High Priest [Aaron].)
Samuel was the last Judge. (He is the one who anointed the first king [Saul].)
- Both of them owe their life to the unusually strong will of their mother (not their father):
 - Ex 2:3 Then she placed the child [**Moses**] in it and put it among the reeds along the bank of the Nile.
 - 1 Sam 1:11 "O LORD Almighty, if you will only look upon your servant's misery and remember me, and not forget your servant but give her a son[**Samuel**],
- Neither of them was raised by their mother.
Moses was raised by Pharaoh's daughter after having been weaned by his mother.
Samuel was raised by Eli in the Temple at Shiloh after having been weaned by his mother.
- Each one stood on Holy ground.
Moses went up the Sinai and Samuel used to lie down in the Temple.

Echoes between the 390 year period of prophecy and Ezekiel surrounding

⇒ **At the start of the period Moses is linked with special food.**

During forty years of his life Moses ate the Manna that was given by God:

- Ex 16:35 The Israelites ate manna forty years, until they came to a land that was settled; they ate manna until they reached the border of Canaan.

Moses' mandate was to bring the House of Israel (12 tribes) to a land flowing with milk and honey:

- Ex 3:8-10 and to bring them up out of that land into a good and spacious land, a land flowing with milk and honey ... I am sending you to Pharaoh to bring my people the Israelites out of Egypt."

Moses was the first one to be told to eat bread without yeast for 7 days:

- Ex 12:14-15 "This is a day you are to commemorate; for the generations to come you shall celebrate it as a festival to the LORD--a lasting ordinance. For seven days you are to eat bread made without yeast.

«« Should we be surprised that the two items found on the north side of the Temple were also food? »»

Manna

- Ex 16:34 As the LORD commanded Moses, Aaron put the manna in front of the Testimony, that it might be kept.

Bread

- Ex 40:22-23 Moses placed the table in the Tent of Meeting **on the north side** of the tabernacle outside the curtain and set out the bread on it before the LORD, as the LORD commanded him.
- Lev 24:5-6 "Take fine flour and bake twelve loaves of bread, using two-tenths of an ephah for each loaf. Set them in two rows, six in each row, on the table of pure gold before the LORD.

NOTE: The twelve loaves of bread symbolize the 12 tribes of Israel. (House of Israel)

⇒ **Near the end of the 390 years, Samuel is told about the capture of the Ark while sleeping in the Temple.**

«« Ezekiel is portraying this period while symbolically lying in the Temple. »»

40 years of prophecy for the House of Judah (South side)

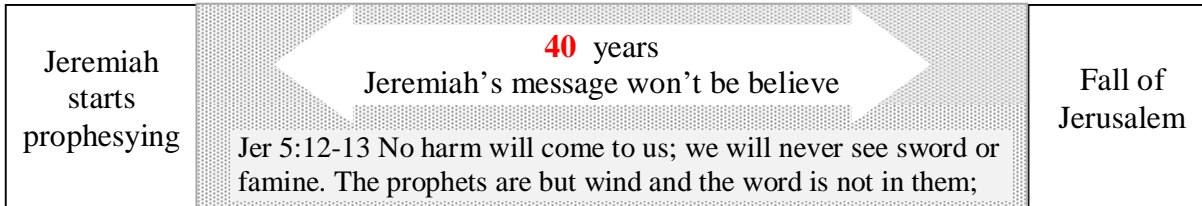
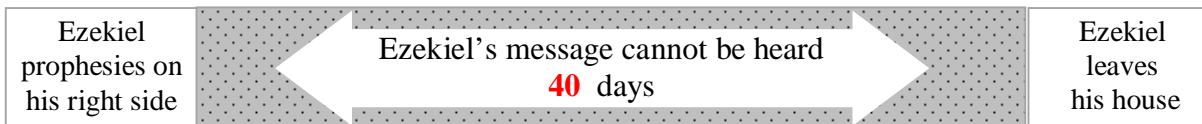

Exactly 40 years before the destruction of Jerusalem, the prophet Jeremiah was mandated to prophesy against Jerusalem:

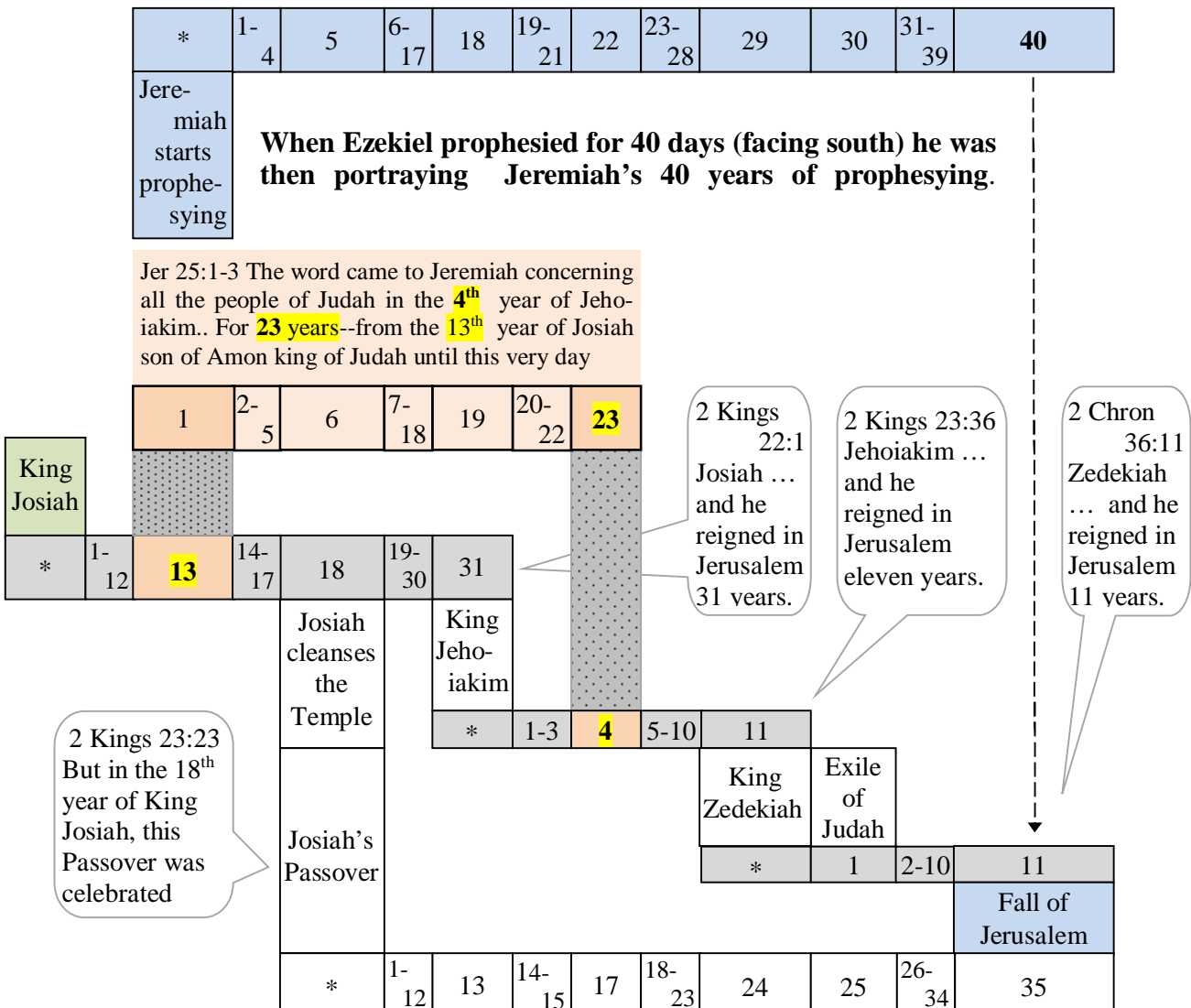

Echoes between the 40 year period of prophesying and Ezekiel surrounding

⇒ **At the beginning of Jeremiah's mandate God asked him what he saw and the answer was a branch of an almond tree:**

- Jer 1:11 The word of the LORD came to me: "What do you see, Jeremiah?"
"I see the branch of an almond tree," I replied.

The two items on the south side are also associated with almonds.

Aaron's staff, the one which blossoms:

- Num 17:8 Aaron's staff, which represented the house of Levi, had not only sprouted but had budded, blossomed **and produced almonds**.

The lamp decorated with almond shapes:

- Ex 25:33 Three cups shaped like almond flowers with buds and blossoms

⇒ **At the end (of the 40 years) Jeremiah witnessed the destruction of the Temple.**

The following are interesting parallels between Moses and Jeremiah; one was associated with Israel's 390 year (of prophecy) and the other with Judah's 40 year (of prophecy).

They both saw themselves as inadequate communicators.

Moses:

- Ex 4:10 Moses said to the LORD, "O Lord, I have never been eloquent, neither in the past nor since you have spoken to your servant. I am slow of speech and tongue."

Jeremiah:

- Jer 1:6 "Ah, Sovereign LORD," I said, "I do not know how to speak; I am only a child."

They both became very powerful.

Moses:

- Deut 34:12 For no one has ever shown the mighty power or performed the awesome deeds that Moses did in the sight of all Israel.

Jeremiah:

- Jer 1:10 See, today I appoint you over nations and kingdoms to uproot and tear down, to destroy and overthrow, to build and to plant."

They both became major prophets.

Moses:

- Deut 34:10 Since then, no prophet has risen in Israel like Moses, whom the LORD knew face to face

Jeremiah:

- Jer 1:5 "Before I formed you in the womb I knew you, before you were born I set you apart; I appointed you as a prophet to the nations."

Freedom came with one while captivity came with the other.

Moses:

- Ex 3:10 So now, go. I am sending you to Pharaoh to bring my people the Israelites out of Egypt."

Jeremiah:

- Jer 40:1 He had found Jeremiah bound in chains among all the captives from Jerusalem and Judah who were being carried into exile to Babylon.

Finally, each period (390 years and 40 years) of prophecy terminated with a calamity of the same magnitude.

The Ark was captured:

- 1 Sam 3:11 "See, I am about to do something in Israel that will make the ears of everyone who hears of it tingle.
- 1 Sam 4:11 The ark of God was captured

The Temple was destroyed:

- 2 Kings 21:12 Behold, I am bringing such evil upon Jerusalem and Judah, that whosoever heareth of it, both his ears shall tingle
- 2 Chron 36:19 They set fire to God's temple and broke down the wall of Jerusalem; they burned all the palaces and destroyed everything of value there.

It is highly **revealing** that the **Ark** and **the Temple** were specifically targeted by the disasters that occurred at the end of each period of prophecy. Those two elements were the same ones symbolized by Ezekiel when he held a 430-day siege in his house (thus portraying the time spent by the **Ark** in the **Temple**).

With bare arm . . . (390 + 40 days)

Besides prophesying while lying on his side Ezekiel was instructed to do it **with his arm uncovered**:

- Ezek 4:7 Turn your face toward the siege of Jerusalem and with bare arm prophesy against her.

The request seems so unimportant that the casual reader doesn't give it a second thought and if he does he probably fails to understand the purpose of it.

Some commentators rightly associated 'the bare arm' of Ezekiel as a sign of power or fighting. In biblical times, it was customary for a soldier about to engage in a fight to uncover his right arm. This was done to prevent his garment being in the way while manipulating the sword. Aware of this information, we should refrain from assuming that Ezekiel's bare arm was a sign of the imminent siege⁴⁸ coming against Jerusalem. If it had been intended that way, it would have been lessened by Ezekiel's appearance, as he was lying and tied during the whole time. And besides that, the siege had already been portrayed on a tile; there was no need to call our attention to it again.



The only other reference where the two words, 'Chaasap' and 'et- z^arowa' (translated 'bare' and 'arm') appear together is in Isa 52:10:

- Isa 52:10 The LORD hath made bare his holy arm in the eyes of all the nations; and all the ends of the earth shall see the salvation of our God.

It is obvious here that the subject of Isa 52:10 is God's powerful accomplishment for his people.

Now, since Ezekiel was specifically chosen by God to act in the present performance and since he was doing it in his capacity of a prophet, we may conclude that Ezekiel's 'bare arm' was a substitute for God's 'bare arm'. Ezekiel, by having his arm bare, was performing yet another symbolic act, which was also dependent on the time that he lay on his sides. However, in the present case there is no need to differentiate between what was going on during the first 390 days and what was going on during the last 40 days. In the end Ezekiel had been laying bare arm for **430 days**, even⁴⁹ if he had to turn over at one time.

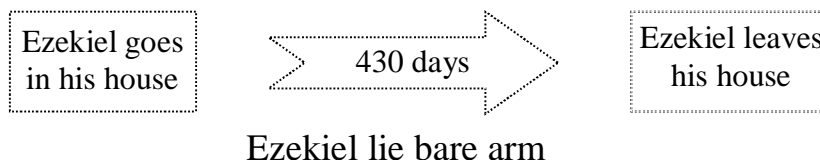

⁴⁸ Nebuchadnezzar' siege

⁴⁹ When Ezekiel turned to the other side at the end of the first 390 days, it did create a break for many symbolic acts that were currently going on but it was not the case with the 'bare arm' one. Laying South-north facing East rather than laying North-south facing East had no impact on Ezekiel's bare arm. The symbolic act kept going on until the 430th day.

430 years under God's protection

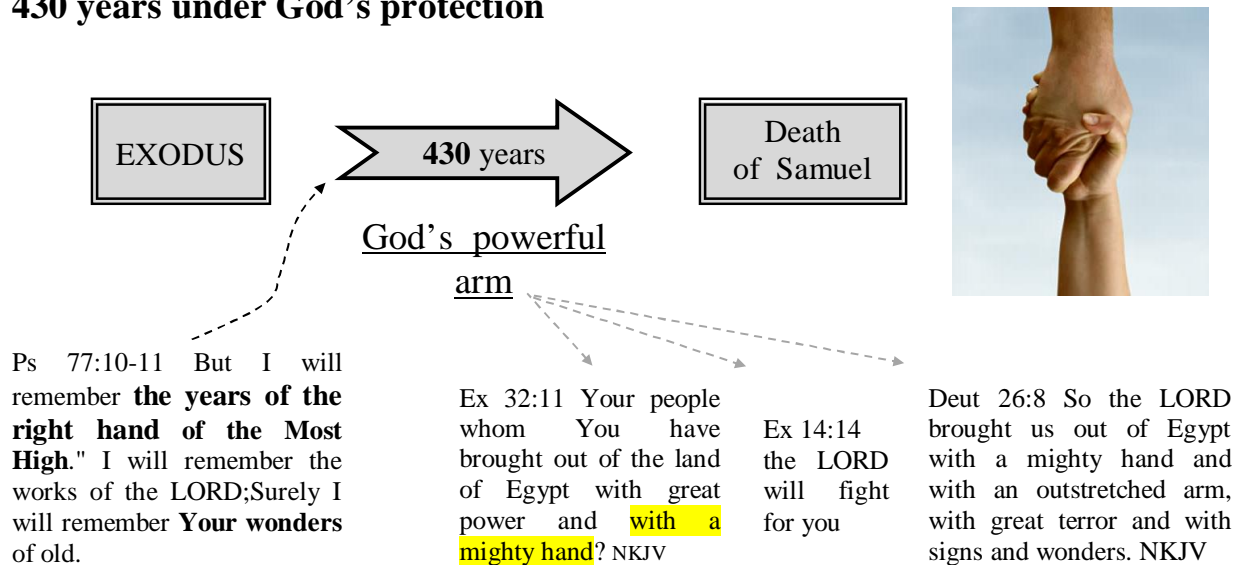

Ezekiel's portraying of God's powerful arm for 430 days was intended to remind us of the 430-year period that started at the Exodus.

Before the Exodus, God's manifestations of power had been extremely rare and were never witnessed by more than a few individuals if at all. At the Exodus, God's mighty power was manifested in such a spectacular way that nobody could have pretended not to have heard about it. In the space of a single day every family⁵⁰ in Egypt lost a son, a father or a brother while several millions of Israelites, untouched by the tragedy, left the country:

- Ex 12:12 "On that same night I will pass through Egypt **and strike down** every firstborn
- Ex 13:3 "Commemorate this day, the day you came out of Egypt, out of the land of slavery, because the LORD brought you out of it **with a mighty hand**
- Ex 7:4 Then **I will lay my hand on Egypt** and with mighty acts of judgment I will bring out my divisions, my people the Israelites.

By his mighty power God opened the sea and allowed the 12 tribes to cross it on dry land:

- Ex 14:13-14 Moses answered the people, "Do not be afraid. Stand firm and you will see the deliverance the LORD will bring you today. The Egyptians you see today you will never see again. **The LORD will fight for you;** you need only to be still."
- Isa 43:16-17 he who made a way through the sea, a path through the mighty waters, who drew out the chariots and horses, the army and reinforcements together,

In the 40 years following the Exodus the 12 tribes witnessed almost every day the manifestation⁵¹ of God's power:

- Ex 13:22 He took not away the pillar of the cloud by day, nor the pillar of fire by night, from before the people.
- Deut 8:16 He gave you manna to eat in the desert, something your fathers had never known,

⁵⁰ There was a dead in every house (Ex 12:30) and the first born of every animal was also put to death. (see Ex 12:29)

⁵¹ See also Deut 2:7, Num 11:31, Num 9:15-16

- Ex 17:6 Strike the rock, and water will come out of it for the people to drink."
- Deut 8:4 Your clothes did not wear out and your feet did not swell during these forty years.

After the Israelites had entered the Promised Land they became accountable for their behavior. For several hundred years their life had alternated between oppressors and rescuers:

- Josh 23:10 One of you routs a thousand, because the LORD your God fights for you, just as he promised.
- Judg 2:14-15 In his anger against Israel the LORD handed them over to raiders who plundered them. He sold them to their enemies all around, whom they were no longer able to resist. Whenever Israel went out to fight, **the hand of the LORD was against them** to defeat them,
- Judg 2:18 Whenever the LORD raised up a judge for them, he was with the judge and **saved them out of the hands of their enemies** as long as the judge lived;

The 430 years under God's special protection ended with Samuel's death, the last and one of the greatest of the judges. During Samuel's lifetime the Ark was captured⁵², the Philistines were permanently subdued⁵³, and two kings were anointed⁵⁴.

There was a good reason to end the 430 years of God's protection (mighty arm) at the time of Samuel's death. The Israelites in their blindness, voluntarily rejected that special protection by asking for a king:

- 1 Sam 8:6 But when they said, "Give us a king to lead us," this displeased Samuel;
- 1 Sam 8:7 And the LORD told him: "Listen to all that the people are saying to you; it is not you they have rejected, **but they have rejected me as their king.**

There was no equivocation, they didn't need God's arm to fight for them anymore, their new king would protect them:

- 1 Sam 8:19-20 But the people refused to listen to Samuel. "No!" they said. "**We want a king over us.** Then we will be like all the other nations, **with a king to lead us and to go out before us and fight our battles.**"

At the end of Samuel's life (the last Judge of Israel), all ties with the past were done away with. God's manifestation of power again became extremely rare.

⁵² 1 Sam 3:11 And the LORD said to Samuel: "See, I am about to do something in Israel that will make the ears of everyone who hears of it tingle.

⁵³ 1 Sam 7:12-13 "Thus far has the LORD helped us." So the Philistines were subdued and did not invade Israelite territory again.

⁵⁴ Saul (see 1 Sam 15:17) & David (see 1 Sam 16:13)

The 3 blocks view

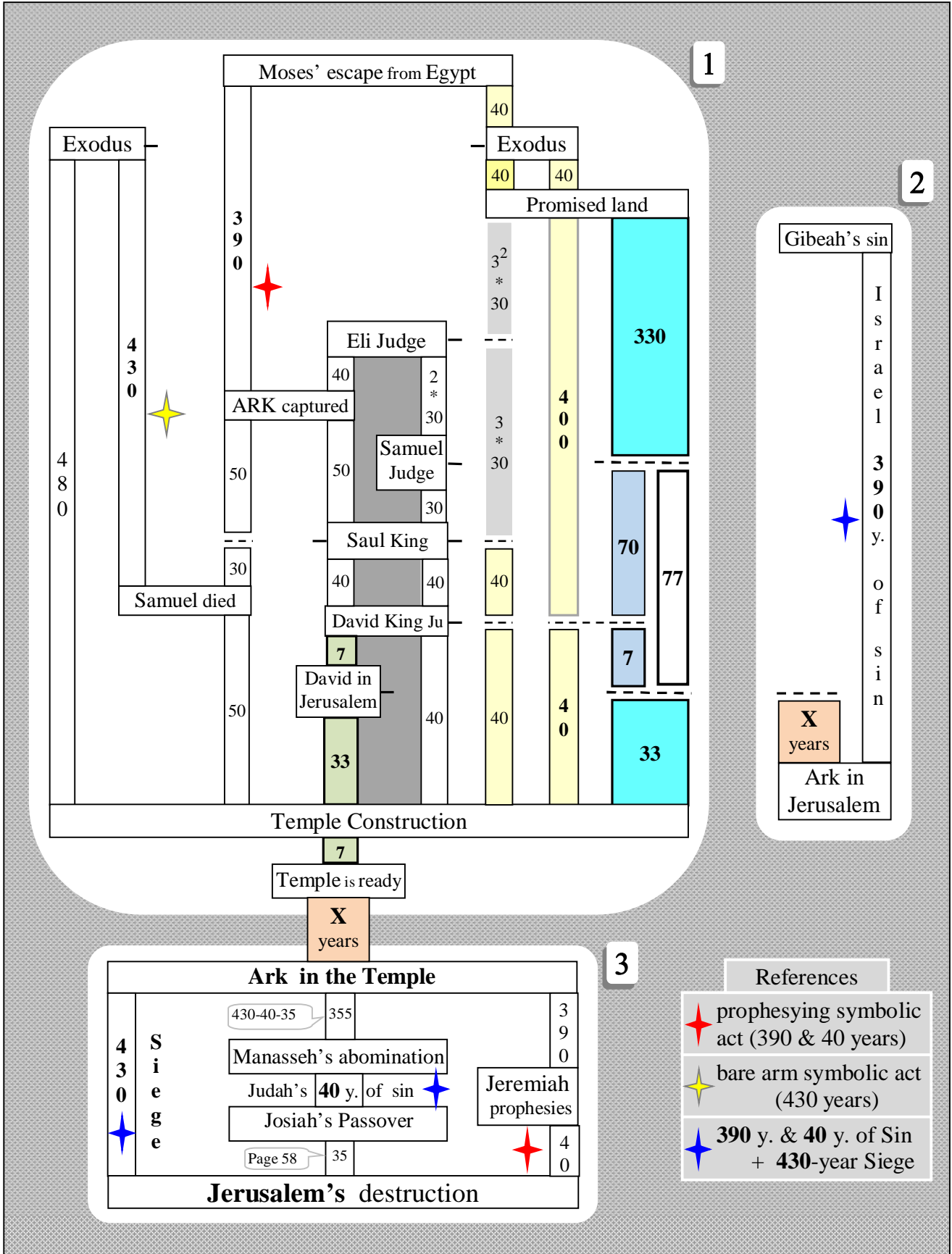

The previous figure combines all the information obtained from Ezekiel 4. so far. As we can see, the chronology of the period from “Moses’ escape” to “Jerusalem’s destruction” can be divided into three blocks of information. Now, we will try to link those three blocks together.

Between block 1 and block 3

By postulating that the Ark was brought into the Temple three years after the end of its construction, we discover (see Figure 8. Blocks 1 and 3 reunited on page 66’) that many events can now be linked together by either meaningful values or by original patterns.

Most of us took for granted that the Ark was brought into the Temple right at the end of the 7 years of its construction, which cannot be the case.

According 1 King 6:38 the Temple was ready in the **month of Bull** (the 8th month), 7 years after the start of its construction:

- 1 Kings 6:38 In the eleventh year in the month of Bul, the eighth month, the temple was finished in all its details according to its specifications. He had spent seven years building it.

But the Ark was brought in the **month of Ethanim** (the 7th month):

- 1 Kings 8:2-4 All the men of Israel came together to King Solomon at the time of the festival in the month of Ethanim, the seventh month. When all the elders of Israel had arrived, the priests took up the ark, 4 and they brought up the ark of the LORD

The Ark could not have been brought to the Temple one month before this one was ready. Therefore the only way to reconcile the information we are given is to recognize that the Ark was brought the following year at the earliest. This paper shows, by the use of patterns, that a three-year delay brought the best possible solution.

A three-year wait is quite acceptable given that the Temple, once its structure was completed (after 7 years), needed to be properly dressed before becoming operational. Thousands of people had worked on the structure, but only a few and exceptionally skilled workers were involved with the temple furnishing:

- 1 Kings 7:13-14 King Solomon sent to Tyre and brought Hiram ... Hiram was highly skilled and experienced in all kinds of bronze work. He came to King Solomon and did all the work assigned to him.
- 1 Kings 7:48-50 Solomon also made all the furnishings that were in the Lord’s temple: the golden altar; the golden table on which was the bread of the Presence; the lampstands of pure gold (five on the right and five on the left, in front of the inner sanctuary); the gold floral work and lamps and tongs; the pure gold basins, wick trimmers, sprinkling bowls, dishes and censers; and the gold sockets for the doors of the innermost room, the Most Holy Place, and also for the doors of the main hall of the temple.

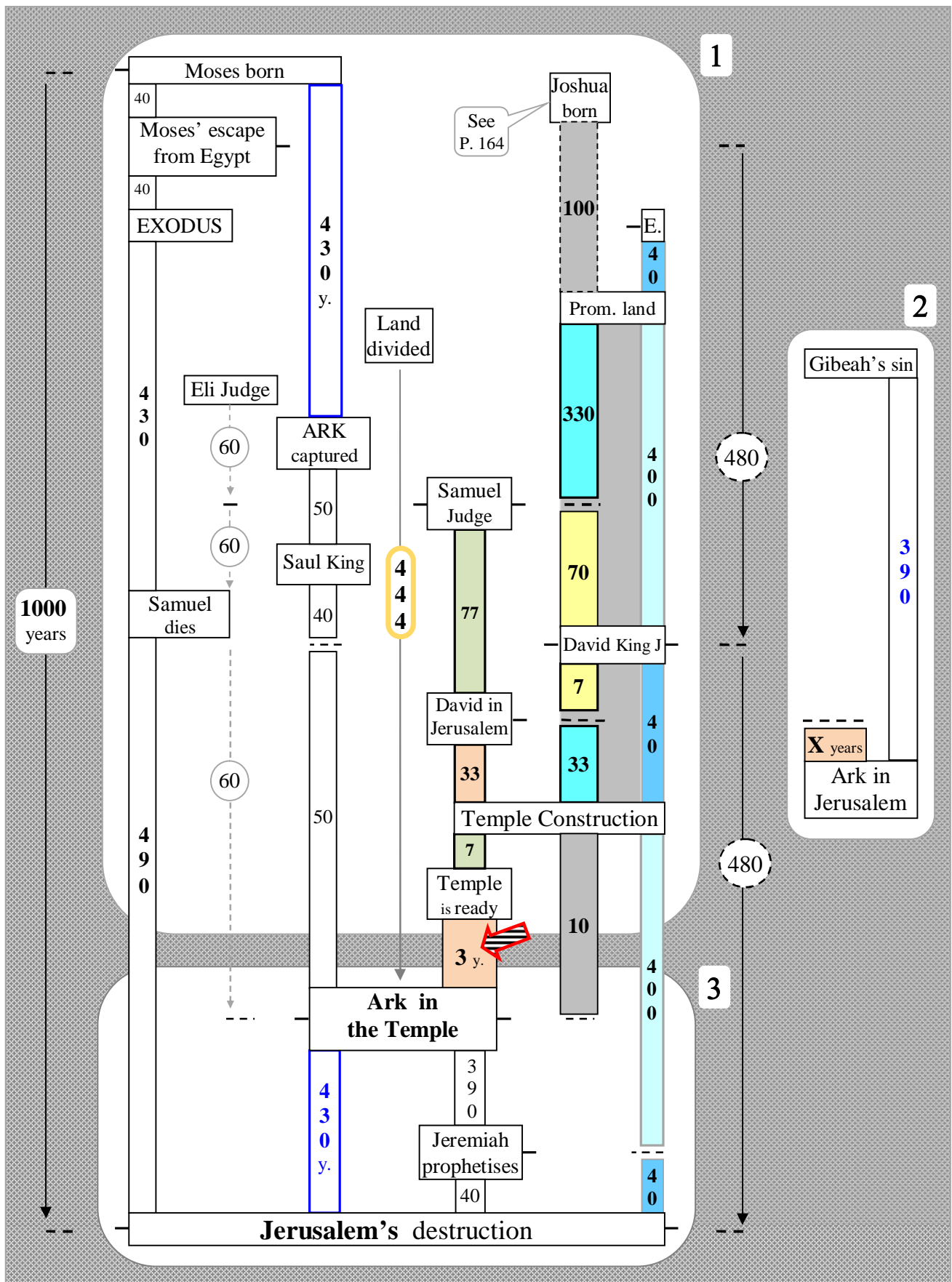

Figure 8. Blocks 1 and 3 reunited

On a chronological point of view, an extremely important piece of information is obtained from the previous figure. There were 490 years between “Samuel’s death” and Jerusalem’s end”:

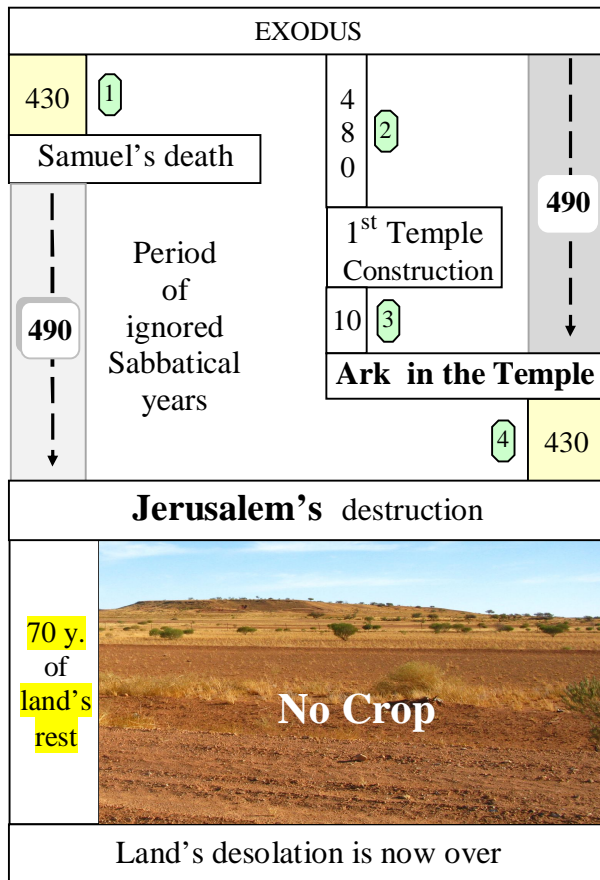

Figure 9. Samuel's death

The number of sabbatical years that were missing was 70. At a rate of one sabbatical year, every 7 years, the people had been disobeying the sabbatical law for 490 years. With the help of the previous figure, it is easy to see that going back 490 years from the ‘Destruction of Jerusalem’ we reach the time of Samuel’s death. Should we be surprised? The people stopped keeping the sabbatical year as soon as Samuel, their last judge, died.

Going back to the earlier discussion of Ezekiel’s ‘bare arm’, we concluded that it portrayed the mighty hand of God that operated from ‘EXODUS’ to ‘Samuel’s death’, a period of 430 years. We can now also say that the mighty hand of God operated from ‘Exodus’ to the time the Israelites started ignoring the sabbatical years.

By choosing to ignore⁵⁵ God’s important warning the Israelites brought to an end the unmatched superiority they had over other people around:

- Deut 5:15 Remember that you were slaves in Egypt and that the LORD your God brought you out of there with a mighty hand and an outstretched arm. **Therefore the LORD your God has commanded you to observe the Sabbath day.**

⁵⁵ The sabbatical law didn’t limit itself to the weekly cycle; there was also a counterpart that has to do with the 7 years cycle.

- ① The 430 years obtained from the 430 days of Ezekiel’s bare arm.
- ② 1 Kings 6:1 In the 480th year after the Israelites had come out of Egypt, ... he began to build the temple of the LORD
- ③ This is deduced by earlier speculation when it was shown that the Ark was brought into the Temple 3 years after the structure was completed.
- ④ The 430 years portrayed by the total 430 days that Ezekiel had been lying on both sides. (Siege of the Ark)

Following the destruction of Jerusalem (and the Temple) we are told that the land was going to enjoy all the sabbatical rest it hadn’t received in the past:

- 2 Chron 36:21 The land enjoyed its Sabbath rests; all the time of its desolation it rested, until the **seventy years** were completed in fulfillment of the word of the LORD

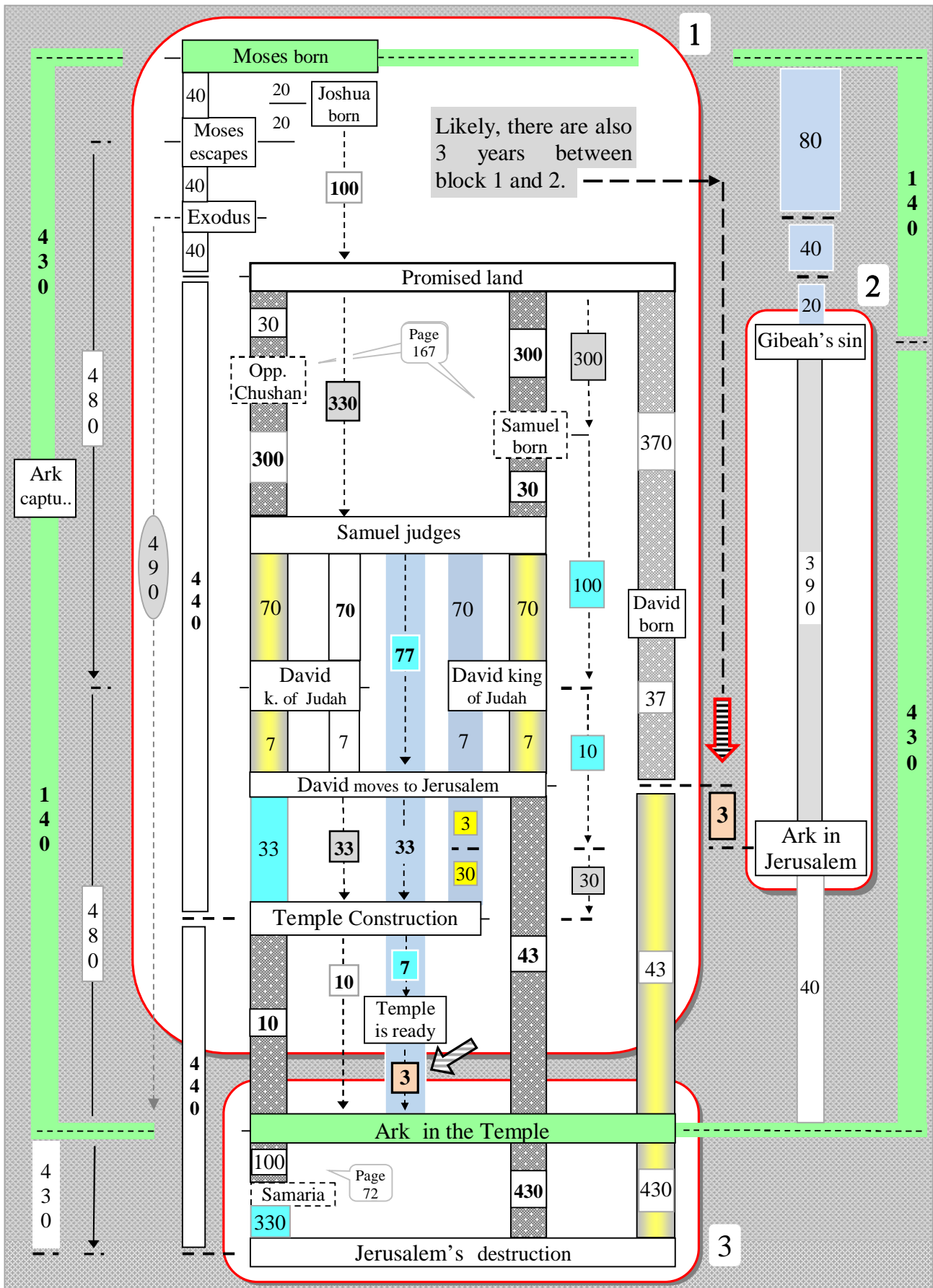

The ark was brought in Jerusalem 3 years after David settled in the city

Did David wait three years to bring the Ark in Jerusalem? It is quite conceivable if he was planning to bring it into the new palace that he was building during that time.

1 Chron 15:1 David built houses for himself in the City of David; and he prepared a place for the ark of God, and pitched a tent for it.

1 Chron 15:3 David assembled all Israel in Jerusalem to bring up the ark of the LORD to the place he had prepared for it.

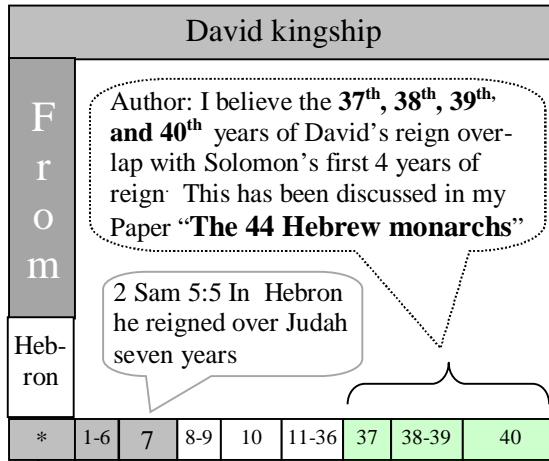

1 Kings 6:37 The foundation of the temple of the LORD was laid in the 4th year,

1 Kings 6:38 In the 11th year in the month of Bul,

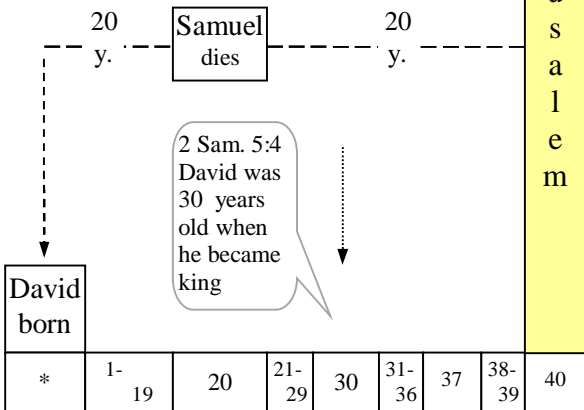
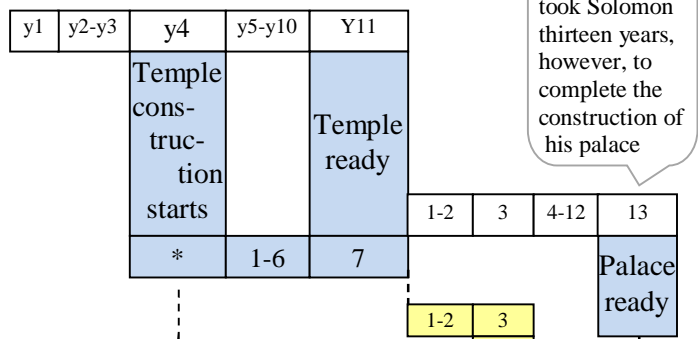
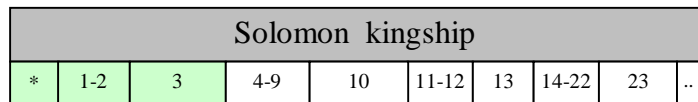
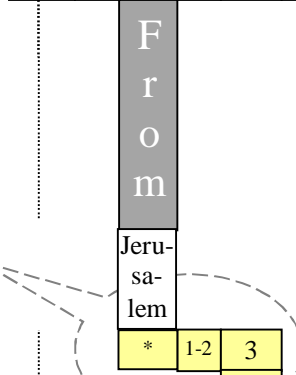

Many patterns substantiate it, the Ark was put in the Temple 40 years after it was brought in Jerusalem.

Ark in Jerusalem

Ark in Temple

Ezekiel ate defiled food for 390 days

Among the numerous symbolic acts described in Ezekiel 4 there is the profanation of his food:

Ezek 4:12-15 ... and bake it using fuel of human waste in their sight." Then the LORD said, "So shall the children of Israel eat their defiled bread among the Gentiles, where I will drive them." Then he said unto me, Lo, I have given thee cow's dung for man's dung, KJV

Notice A direct correlation between the north side's animal (Bull) of the House of Israel's 390 days, and the "cow's dung".



Cow's dung used as fuel

There are **three very important elements** that we have to keep in mind when analyzing this symbolic act:

1. It lasted 390 years:
Ezekiel was allowed to feed himself only during the first 390 days of his siege. Therefore, according to the rule that 'a day equals a year'⁵⁶, whatever was portrayed by the defiled food had to last **exactly 390 years**.
2. It applied to the 12 tribes:
Any symbolical act associated with the 390 days of Ezekiel has to do with the 12 Tribes. This point has already been shown several times in this paper.
3. It will involve other nations:
Part or the totality of the period will be spent in the midst of non-Israelite nations. Therefore, any exile period should be considered.

In short, we are looking for a period of 390 years during which the people of Israel (12 tribes) supposedly ate defiled food among other nations. If we accept this most simplistic⁵⁷ interpretation, we will find only three possible starts for the period.

- #1. First exile: When Jacob goes to Egypt
A quick analysis of the chronology would show that Jacob's descendants came back from Egypt about 265 years later. That period is too short to represent what we are looking for.
- #2. Second exile: When the northern tribes went into captivity
At the end of King Hoshea's reign 10 tribes were deported to Assyria, but unexpectedly they never came back to their land; they are still in exile to this day. *(there will be much more to say about that exile later in this book)*
- #3. Third exile: When Judah went into Exile
This exile lasted only 70 years and is therefore too short to be a valid start.

Obviously the 390-year period could not have started with any of the previous three exiles, on the other hand Ezek 4:13 does say that the Israelites shall eat their defiled food among the nations. It can hardly be more unambiguous: the Israelites had to be in exile to fulfill this description.

⁵⁶ Ezek 4:5 For I have laid on you the years of their iniquity, according to the number of the days NKJV
Note: People have been ill-advised to replace 'days' by 'years' every time they found it convenient in their research on chronology but to do it with Ezekiel 4 is quite appropriate.

⁵⁷ Remember that Ezekiel's symbolic acts are never what they appear to be.

Now wouldn't it bring a whole new perspective to our interpretation if, instead of assuming that the 'start of an exile' had initiated the period of defiled food, we used the 'return from an exile' to close it? It doesn't work with the first and second Exile. Going backward 390 years from the coming to the Promised Land (first exile) would bring us to a time when the 12 patriarchs were not even born. Neither can we use the end of the second exile given that this exile is not over yet (*author absolute belief*).

That leaves us with the third Exile 'exile of Judah' with the inference that the Israelites (southern kingdom) ate their defiled food among other nations only in the last 70 years⁵⁸. It should be noted that Ezek 4:13 doesn't specifically say that they would be among⁵⁹ other nations for the whole 390 years. Besides that, we are about to discover that going backwards 390 years from the 'return of Judah's exiles' brings us to the start of the most corrupted (defiled) period of Israel's history, a period also characterized by the introduction of the worship of Baal (a foreign nation's deity) by the Israelites. The foundation of Samaria.

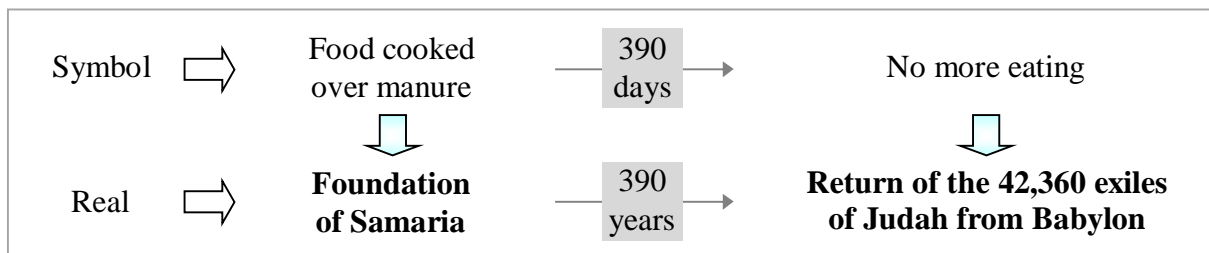

Was Samaria founded 390 years before the return of the 42,360 exiles from Babylon? Yes, but it is not the purpose of this paper to present the readers with all the necessary details. However, to corroborate this proposition, it can be quickly shown that King Omri, the one who founded Samaria, was the one reigning 390 years before the return of the exiles from Babylon. First, we need to establish when the return of the exiles from Babylon took place.

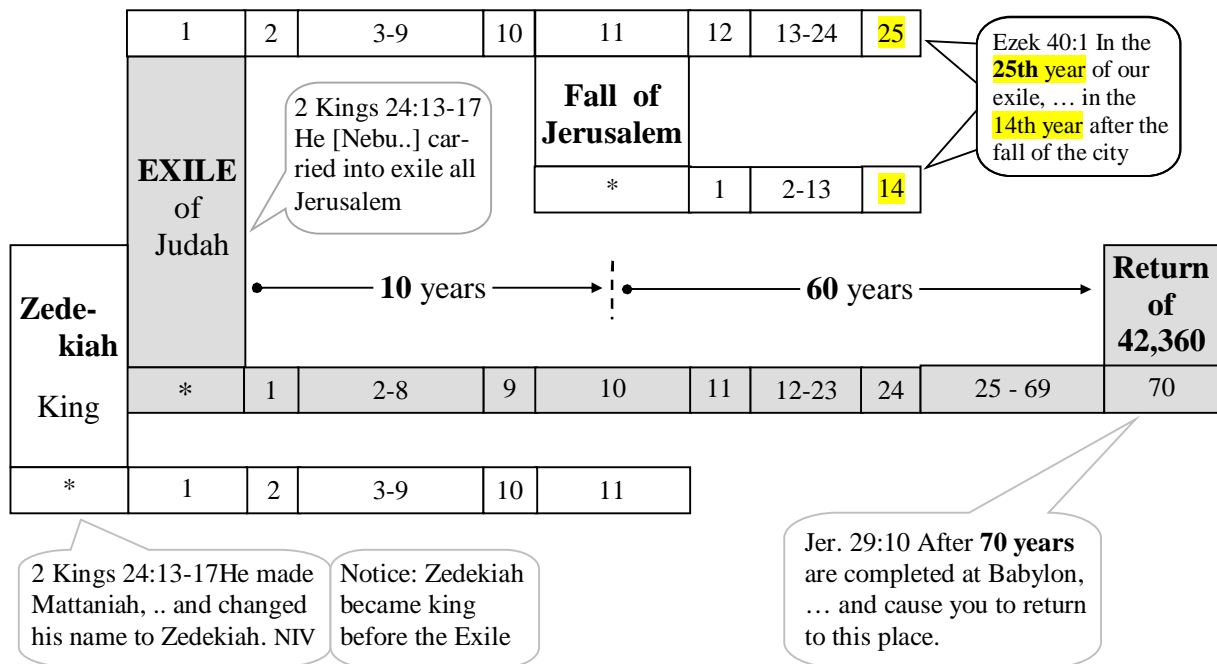

⁵⁸ 70 years is the duration of the Exile

⁵⁹ There is more to say about that aspect. See 'among other nations' on page 77.

We then continue by establishing the time of Omri's kingship, which was about the time Samaria was founded.

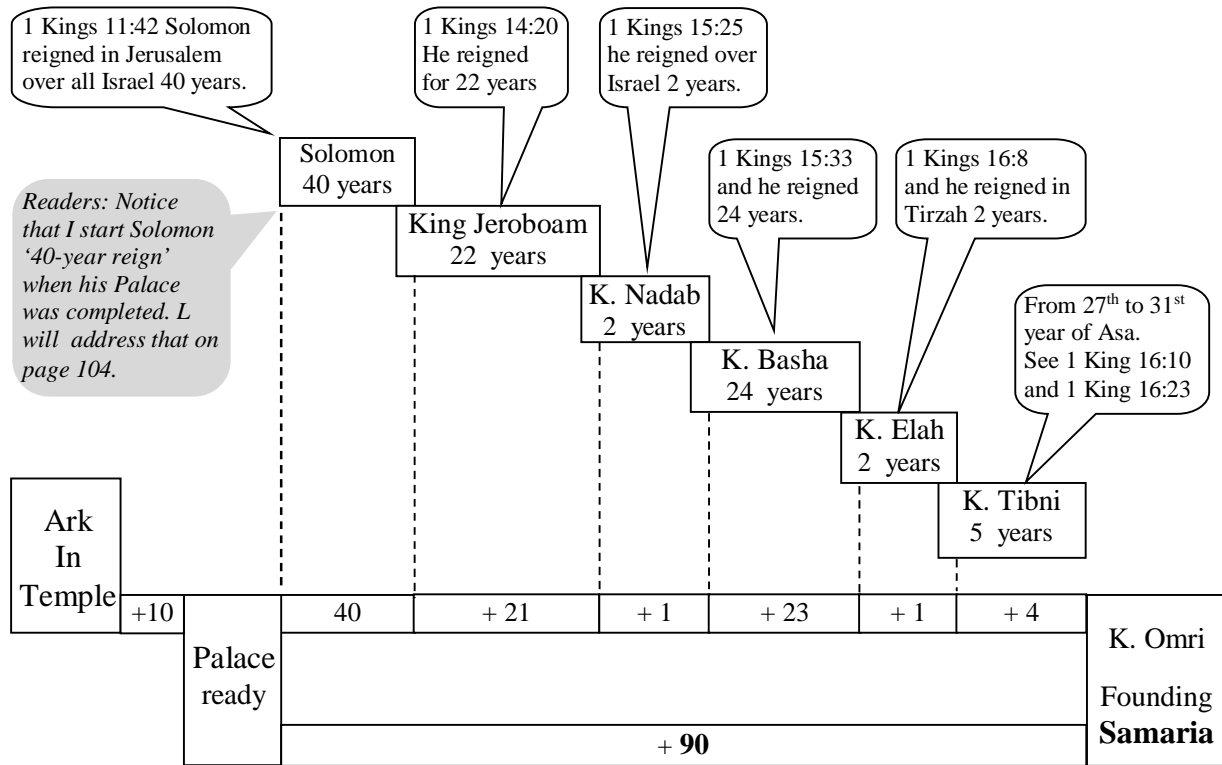

Using the information found up to now, we can see that there are 390 years between 'the founding of Samaria' and 'the return of the exiles'. (430 + 60 - 100)

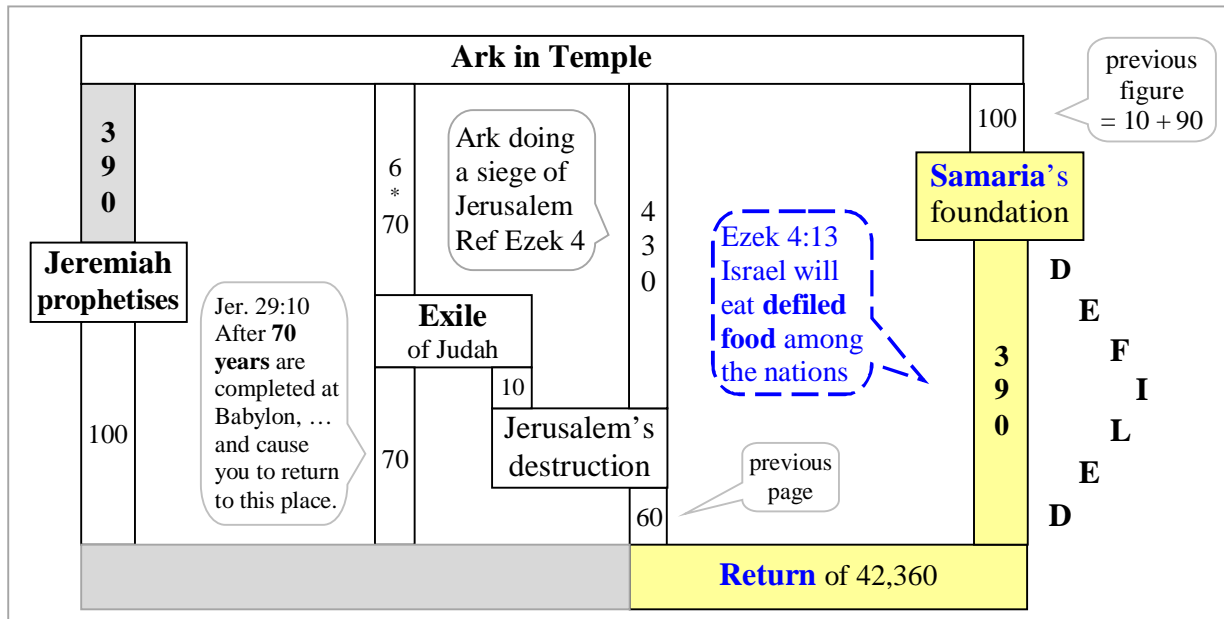

Figure 11. Defiled food

Defiled food = False word

The Israelites were told that along with their bread they also needed to feed themselves with the 'word of God':

- Deut 8:3 He humbled you, causing you to hunger and then feeding you with manna, which neither you nor your fathers had known, to teach you that man does not live on bread alone but **on every word that comes from the mouth of the LORD.** NIV

Jeremiah and Ezekiel were fed the words of God before being sent to the people:

- Jer 15:16 When your words came, I ate them; they were my joy and my heart's delight, NIV
- Ezek 3:3 Then he said to me, "Son of man, eat this scroll I am giving you and fill your stomach with it." So I ate it, and it tasted as sweet as honey in my mouth. NIV

The role of the prophets was to feed the people with food for the mind⁶⁰. Therefore, when the prophets were lying and gave words that did not come from God, **they were feeding the people with defiled food.** Ezekiel's unclean food symbolized the false words given to the people by most of the prophets after the foundation of Samaria.

Initiating the period of 390 years with the foundation of Samaria is quite judicious. Samaria hadn't only become the capital⁶¹ of the northern kingdom it also became the seat of all the corruption that prevailed in Israel:

- Jer 23:13 "Among the prophets of Samaria I saw this repulsive thing: They prophesied by Baal and led my people Israel astray.

With the start of Samaria a new dynasty of kings (Omri, Ahab, Ahaziah, Jehoram [Joram]) began to reign over the people. They introduced changes that would have a profound effect on the people:

- 1 Kings 16:25 But Omri did evil in the eyes of the LORD and sinned more than all those before him.
- 1 Kings 16:30-32 Ahab son of Omri did more evil in the eyes of the LORD than any of those before him. He not only considered it trivial to commit the sins of Jeroboam son of Nebat, but he also married Jezebel daughter of Ethbaal king of the Sidonians, and began to serve Baal and worship him.
- 1 Kings 22:53 He [Ahaziah] served and worshiped Baal and provoked the LORD, the God of Israel, to anger, just as his father had done.
- 2 Kings 3:2 He [Joram son of Ahab] did evil in the eyes of the LORD,

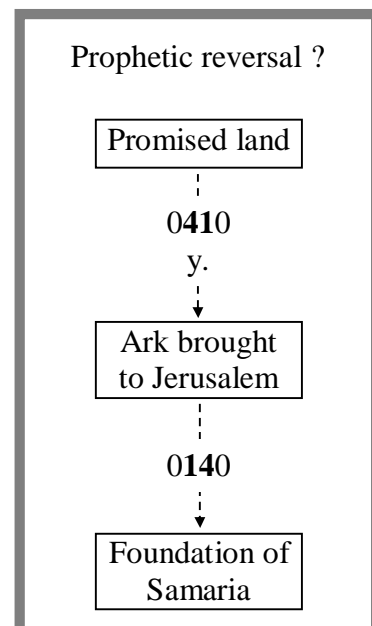

⁶⁰ Notice in the following verse from Amos that the 'absence of word' (from God) can be equated to a famine. [Amos 8:11 "Behold, the days are coming," says the Lord GOD, "That I will send a famine on the land, Not a famine of bread, Nor a thirst for water, But of hearing the words of the LORD. NKJV]

⁶¹ from then on Samaria would be the residence of all the kings of the northern kingdom until the Exile

Legacy of Omri's dynasty

New deity:

- Mic 6:16 For the statutes of Omri are kept; All the works of Ahab's house are done; And you walk in their counsels, NKJV
- Kings 18:18 "I have not made trouble for Israel," Elijah replied. "But you [Ahab] and your father's family [Omri] have. You have abandoned the LORD's commands and have followed the Baals.
- Jer 3:6-7 "Have you seen what faithless Israel has done? She has gone up on every high hill and under every spreading tree and has committed adultery there. I thought that after she had done all this she would return to me but she did not, NIV

New prophets:

- 1 Kings 18:19 And bring the four hundred and fifty prophets of Baal and the four hundred prophets of Asherah, who eat at Jezebel's table." [Jezebel was king Ahab's wife]

Corrupted shrines:

- 2 Kings 17:29 Nevertheless, each national group made its own gods in the several towns where they settled, and set them up in the shrines the people of Samaria had made at the high places.

A Temple of Baal in Samaria:

- 1 Kings 16:32 He set up an altar for Baal in the temple of Baal that he [Ahab] built in Samaria.

The corruption in Israel became so critical that it was almost impossible to hear the words of God anywhere in the whole territory. There came a time when there was only one prophet of God left:

- 1 Kings 18:22 Then Elijah said to them, "I am the only one of the Lord's prophets left,

Meanwhile Judah didn't do any better. Its land was also filled with corruption:

- 2 Kings 16:3 He [king Ahaz of Judah] walked in the ways of the kings of Israel and even sacrificed his son in the fire, NIV
- 2 Kings 17:19 and even Judah did not keep the commands of the LORD their God. They followed the practices Israel had introduced. NIV
- 2 Kings 21:3 He[king Manasseh] rebuilt the high places his father Hezekiah had destroyed; he also erected altars to Baal and made an Asherah pole, as Ahab king of Israel had done. NIV
- Jer 5:1 "Go up and down the streets of Jerusalem, look around and consider, search through her squares. If you can find but one person who deals honestly and seeks the truth, I will forgive this city. NIV

- Ezek 16:51 Samaria did not commit half the sins you [Judah] did. You have done more detestable things than they, NIV
- Jer 11:13 You have as many gods as you have towns, O Judah; and the altars you have set up to burn incense to that shameful god Baal are as many as the streets of Jerusalem.' NIV
- Jer 13:27 Woe to you, O Jerusalem! How long will you be unclean?" NIV
- Jer 32:34 They set up their abominable idols in the house that bears my Name and defiled it. NIV

Judah was also deceived by its prophets:

- Jer 4:10 "Ah, Sovereign LORD, how completely you have deceived this people and Jerusalem by saying, 'You will have peace,' when the sword is at our throats." NIV
- Jer 7:28 Therefore say to them, 'This is the nation that has not obeyed the LORD its God or responded to correction. Truth has perished; it has vanished from their lips.'
- Jer 8:10 prophets and priests alike, all practice deceit. NIV
- Jer 23:11 "Both prophet and priest are godless; even in my temple I find their wickedness," declares the LORD. NIV
- Jer 23:21 I did not speak to them, yet they have prophesied. NIV
- Ezek 22:26 Her priests have violated My law and profaned My holy things; they have not distinguished between the holy and unholy, nor have they made known the difference between the unclean and the clean; and they have hidden their eyes from My Sabbaths, so that I am profaned among them. NKJV

The return of the exiles (of Judah) that had been away from their land for 70 years, brought an end to the 390 years of the 'defiled word'. The people were then offered a new start, their sins were forgiven and they received a new spirit:

- Jer 29:13-14 You will seek me and find me **when you seek me with all your heart**. I will be found by you," ... , "and will bring you back from captivity. NIV
- Ps 85:1-2 Lord, You have been favorable to Your land; You have brought back the captivity of Jacob. **You have forgiven the iniquity of Your people; You have covered all their sin.** NKJV
- Isa 45:8 "You heavens above, rain down righteousness; let the clouds shower it down. Let the earth open wide, let salvation spring up, **let righteousness grow with it;** NIV
- Ps 126:1-2 When the LORD brought back the captives to Zion, we were like men who dreamed. Our mouths were filled with laughter, **our tongues with songs of joy.** NIV

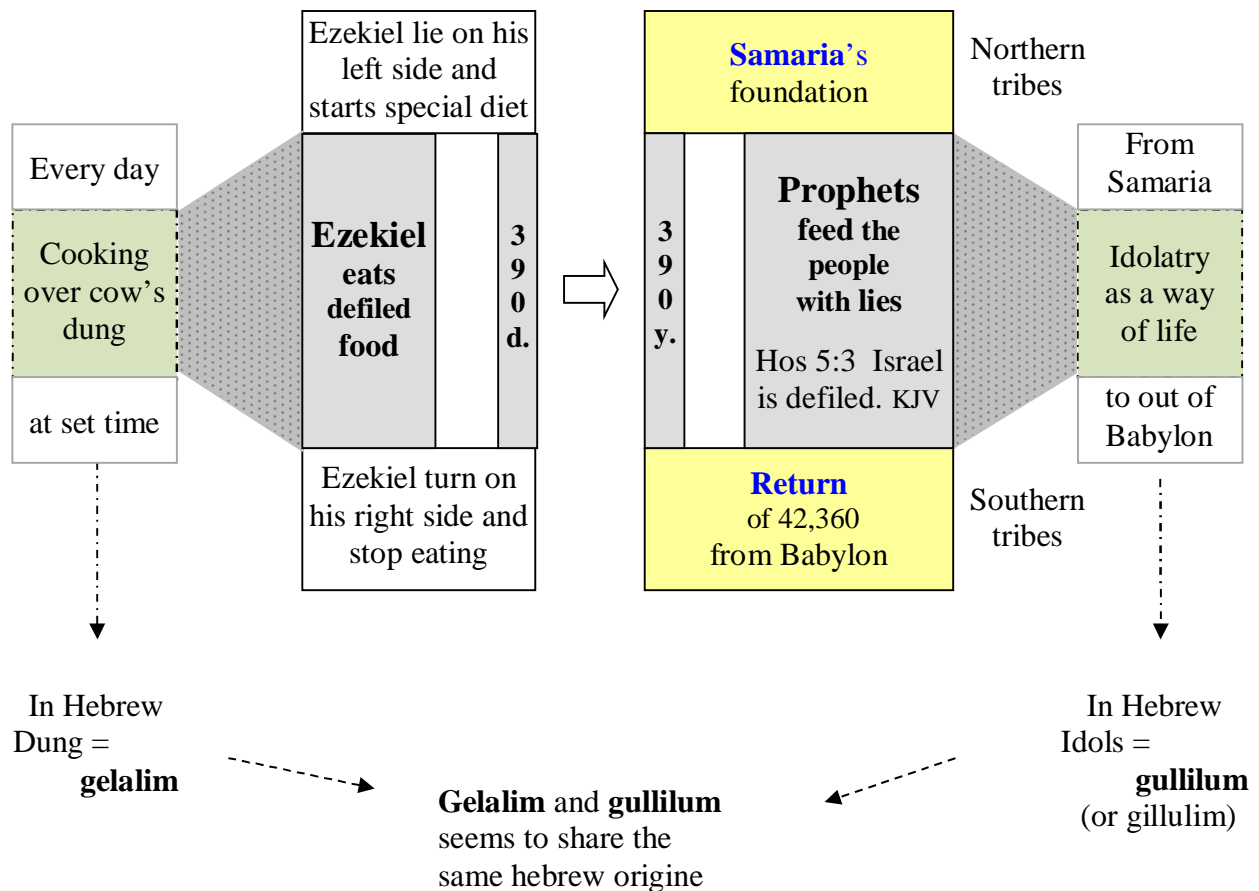

The lower limit of the 390-year period of Ezekiel's defiled food is defined by the **founding of Samaria** (an event associated with the **northern tribes**) while the upper limit is defined by the **'return of the 42,360 exiles'** (an event exclusively associated with the **southern tribes**).

Some readers will object that we have failed to point to the right 390-year period given that the tribes involved at the start of this period are not the same tribes implicated at its end. Yet this argument doesn't invalidate our interpretation of Ezekiel 4:13. Symbolically, there has been people of the House of Israel (12 tribes) eating defiled food (hearing false word) during the whole period of 390 years.

A study of the 390 years, starting with the founding of **Samaria**, shows how some prophets introduced an evil system that spread from a single city and gradually reached all the land of two kingdoms (north and south). For hundreds of years, people of every tribes, showing an obvious lack of judgment, had been listening and believing false teaching, thus succeeding in alienating their one true God. Then they were sent into exile, one kingdom at the time. **The period of 390 years came to an end when the first exiles of one kingdom were allowed to return to their land and Jerusalem.**

The Israelites didn't need to go among other nations for the whole 390 years.

Some readers will also argue that Ezekiel 4:13 imply that the Israelites would have to eat their food (hearing lies) **among other nations for the whole 390-year period** and not, as I suggested, during only the 70-year portion of their Exile.

- Ezek 4:13 The LORD said, "In this way the people of Israel will eat defiled food among the nations where I will drive them." NIV

Although the objection is legitimate it cannot be retained for the following reason. When told about the way he should cook his food, Ezekiel protested vehemently and as a result, received 'partial' abatement for his assignment

- Ezek 4:15 "Very well," he said, "I will let you bake your bread over cow manure instead of human excrement." NIV

It is only logical that the events portrayed by this symbolical act should also reflect a convincing form of abatement. Thus, as we will see, the Israelites didn't need to go immediately abroad to eat the defiled food of other nations. For 320 years prior the 70-year exile, the other nations themselves came to Israel.

After the founding of Samaria the Israelites were inclined to mix with other nations:

See 1 Kings 20:34

- Hos 7:8-9 "Ephraim has mixed himself among the peoples; Ephraim is a cake unturned. Aliens have devoured his strength, But he does not know it; NKJV

Ahab's wife Jezebel, who was not an Israelite, brought with her the deity of her own nation and introduced the worship of Baal on a large scale in the northern kingdom. (It is quite conceivable that she brought also her own prophets with her when she came to Samaria.)

See 1 Kings 16:31

- 1 Kings 18:19 And bring the four hundred and fifty prophets of Baal and the four hundred prophets of Asherah, who eat at Jezebel's table." NIV

See 2 Kings 10:32-33

- 2 Kings 15:29 In the time of Pekah king of Israel, Tiglath-Pileser king of Assyria came and ... NIV

Foreign armies also invaded Judah's territory and the people were subdued by those nations for years before being sent into captivity, thus sharing the same fate as their brothers from the northern kingdom. In the end, every Israelite, no matter which tribe, he belonged, was eating defiled bread on foreign soil:

- 2 Kings 16:7 Ahaz sent messengers to say to Tiglath-Pileser king of Assyria, "I am your servant and vassal. NIV

See 2 Kings 23:33-34 & 2 King 24:1

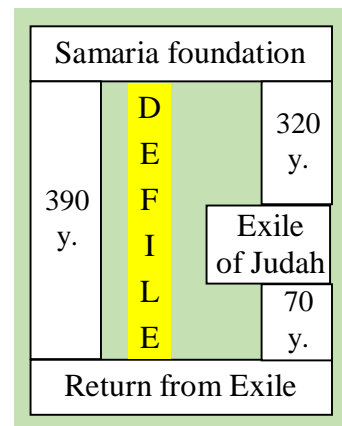

Ezekiel's symbolical act

390 years of defiled food

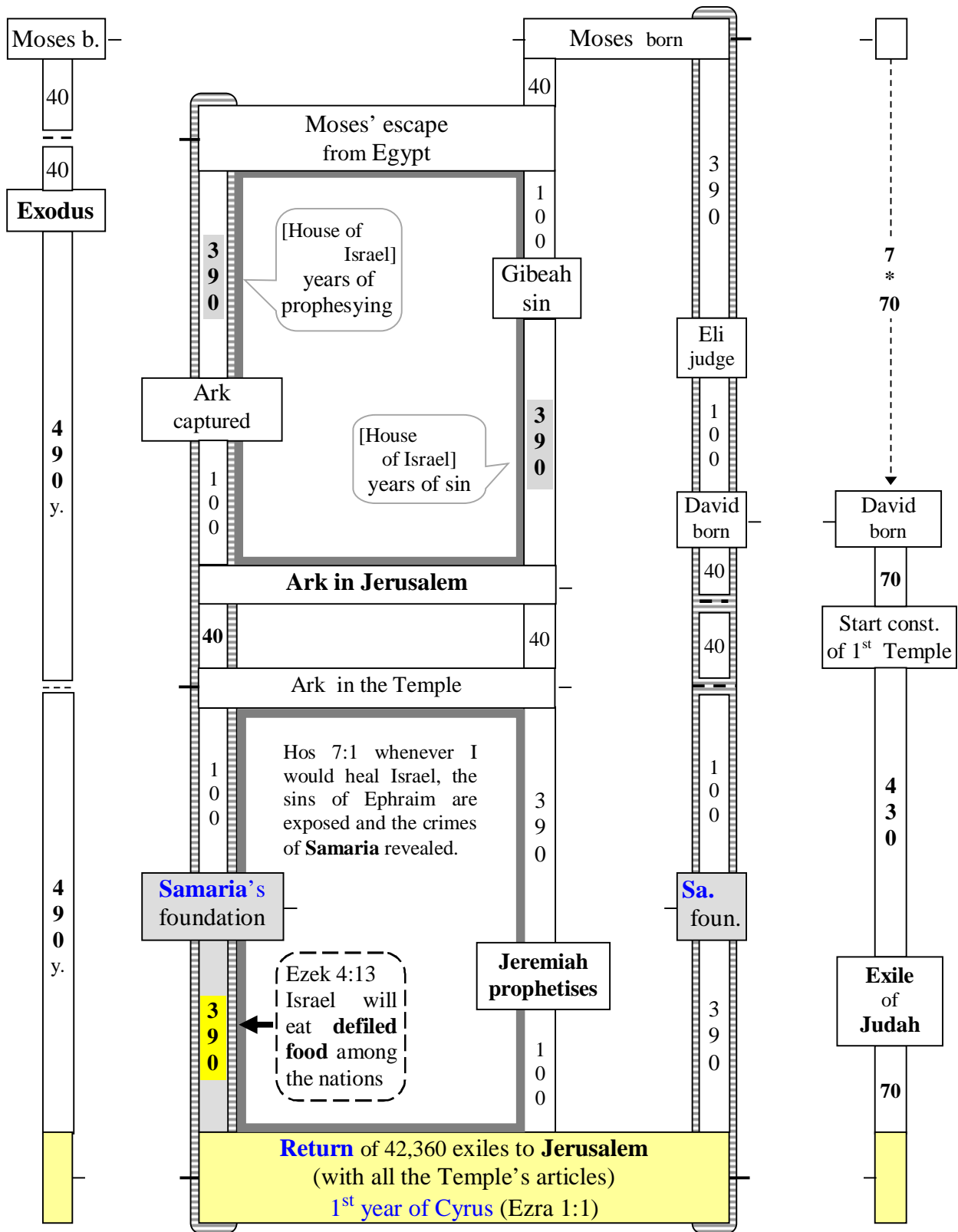

Figure 12. Ezekiel defiled food

430 years and 400 years countdown to Exodus

Anybody who has studied the Bible's chronology for some time will agree. There is only one way to obtain the date of the Exodus and it is by properly identifying the origin of the 430 years mentioned in Exodus 12:40 and in Galatians 3:17. These two verses are fundamental to the building of an elaborate and consistent chronology of the Bible.

- Ex 12:40-41 Now the sojourn of the children of Israel who lived in Egypt was four hundred and thirty years. ... all the armies of the LORD went out from the land of Egypt. NKJV
- Gal 3:17 What I mean is this: The law, introduced 430 years later, does not set aside the covenant previously established by God and thus do away with the promise NIV

In the following pages we will identify the covenant alluded to in Galatians 3:17, determine the right date for the Exodus, and finally find out what happened 400 years before the Exodus.

- Gen 15:13 and they will be enslaved and mistreated four hundred years. NIV

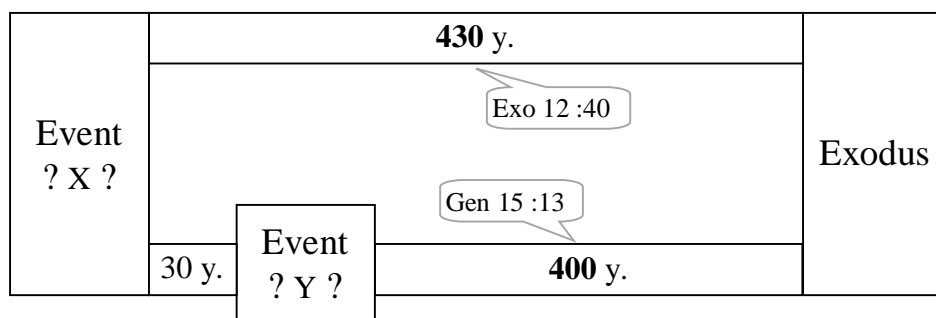

The Exodus started when the Israelites left Egypt and according to Exo 12:40 it was at the end of a period of 430 years⁶². The verse doesn't say anything about the beginning of the period. Fortunately, we are not left without a clue as Galatians 3:17 supplies us with an important clarification: the 430-year period originated at the time of a covenant. In Galatians 3:16, one verse before, we learn that the covenant was known to Abraham, the first patriarch of Israel.

- Gal 3:16 Now to Abraham and his Seed were the promises made. NKJV

Our initial approach will be to build a timeline of the important events in Abraham's life. One of those events is more likely to have triggered the 430-year countdown to the Exodus. We have to keep in mind that we don't know yet if we are looking for a covenant that was enunciated, confirmed or activated.

⁶² Here many people have been lured into thinking that the Israelites spent the whole 430 years in Egypt. Even though the verse seems to say so it wasn't the case and we will see later that there is an alternate way to understand Ex 12:40.

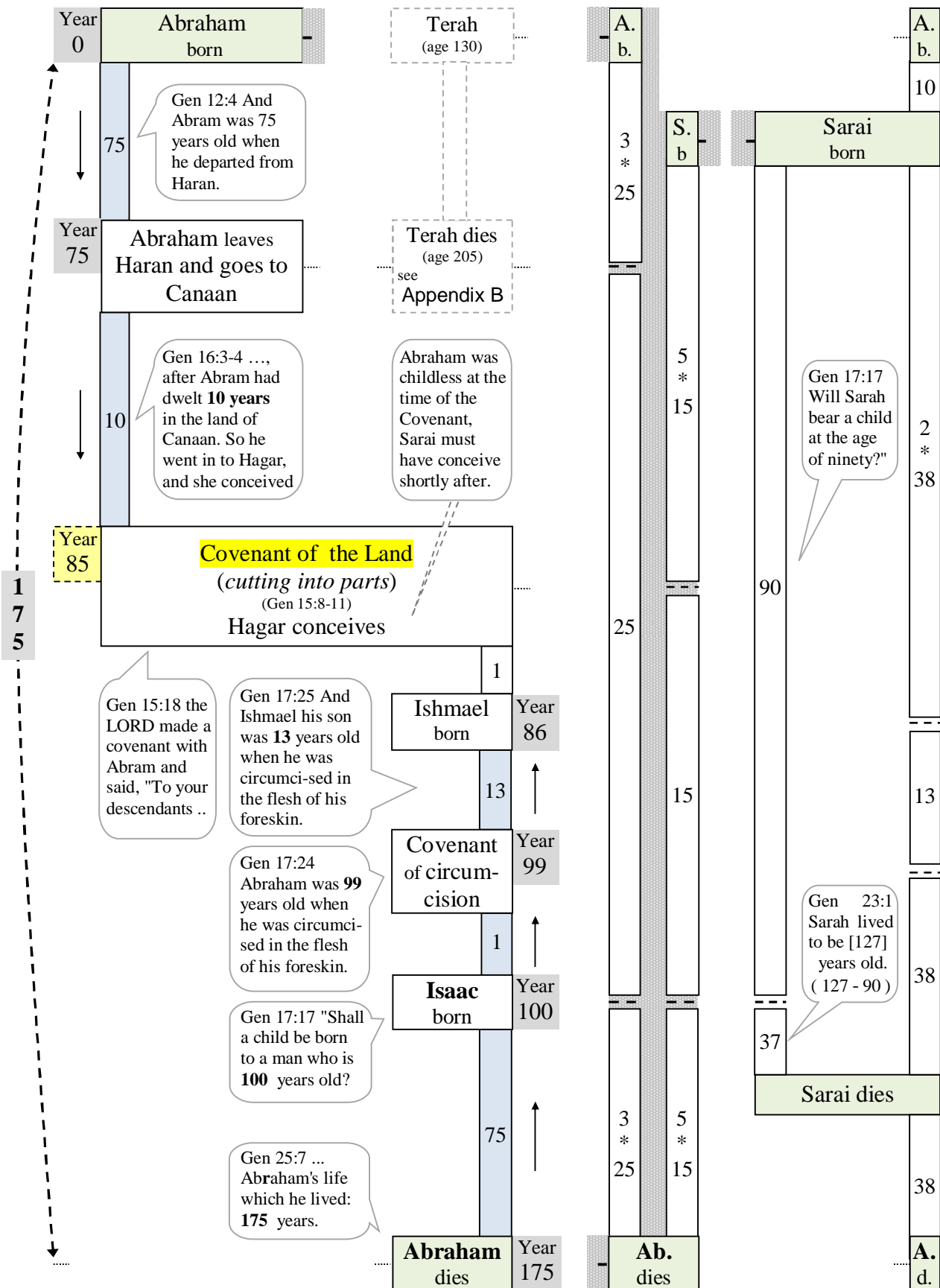
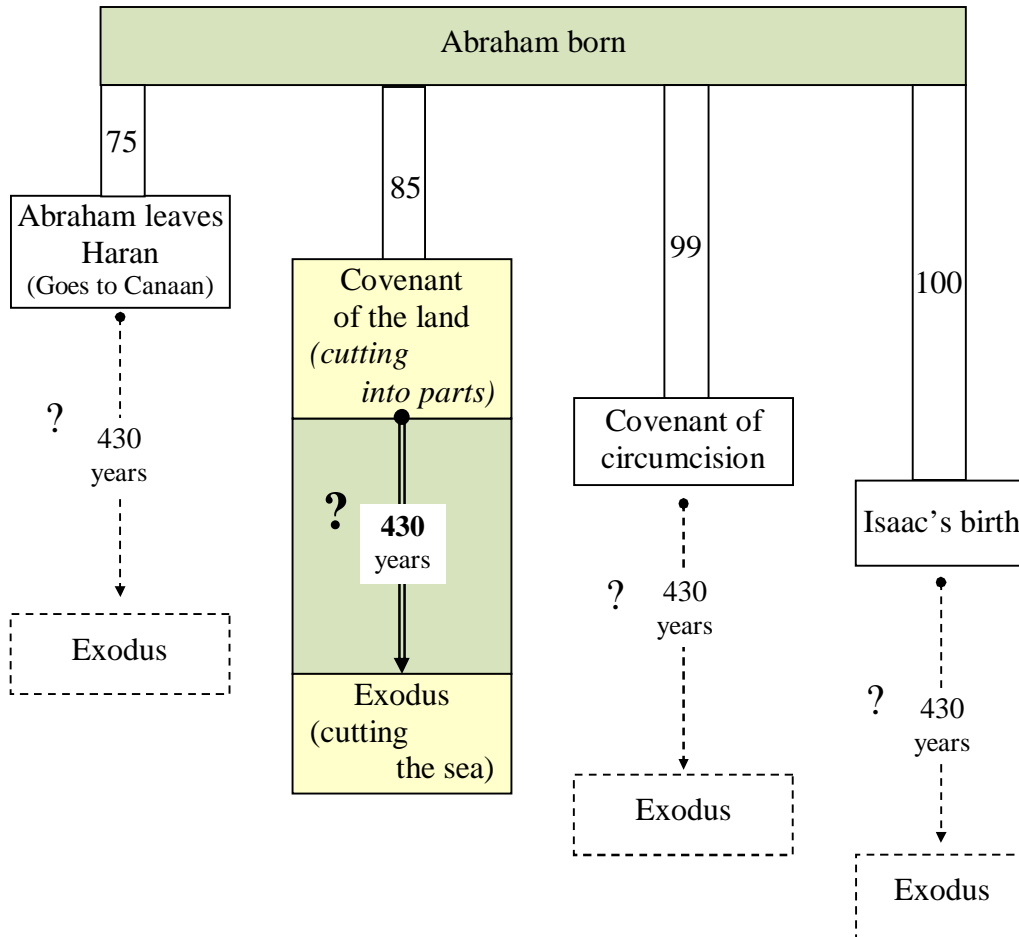

Figure 13 Abraham timeline

Should we start the 430 years ... (see the previous figure for references)

- ⇒ **When** Abraham left Haran at age 75? He was certainly obeying God in doing that.
- ⇒ **When** Abraham received the covenant of the land at age 85? This is the first time a sign is introduced to confirm that the land will be given (the cutting into part, Gen 15:8-11).
- ⇒ **When** Abraham was circumcised at age 99? By marking his own flesh and the flesh of his people Abraham was ratifying a very special agreement with God.
- ⇒ **When** 100-year-old Abraham became the father of Isaac? This was the fulfillment of a promise received the previous year and the beginning of an important dynasty.



This chart shows how the Exodus' date is a tributary of the origin of the 430-year period.

Intuitively, it seems right to start the 430 years leading to the Exodus at the ‘Covenant of the land’. One could say that the period started with God’s promise to give the land and the covenant that goes with it, and would end 430 years later with the return to that land by million of people after escaping slavery in Egypt.

--- Unfortunately, that argument wouldn’t be strong enough to convince everyone that those events are absolutely complementary. But there is more...

Have you noticed that the strange ritual performed by Abraham when he learned of the covenant of the land (cutting into parts), was echoed in several points at Exodus? Look at the following two events and compares **A & A’ B & B’ C & C’ D & D’**

Cutting into parts	Gen 15:10-11 Then he brought all these to Him and cut them in two (A) , down the middle, and placed each piece opposite the other (B) ; but he did not cut the birds in two. And when the vultures came down on the carcasses, Abram drove them away(C) .
430 years later	Gen 15:17 And it came to pass, when the sun went down and it was dark, that behold, there appeared a smoking oven and a burning torch that passed between those pieces (D) .
EXODUS	Ex 14:16 But lift up your rod, and stretch out your hand over the sea and divide it (A’) . Ex 14:19-20 ... and the pillar of cloud ... So it came between the camp (B’) of the Egyptians and the camp of Israel. Thus it was a cloud and darkness to the one, and it gave light [like a burning torch] by night to the other ... Ex 14:22 and the Israelites went through the sea on dry ground, with a wall of water on their right and on their left (D’) . NIV Ex 14:24 the LORD looked down from the pillar of fire and cloud at the Egyptian army and threw it into confusion (C’) . NIV

Cutting into parts		Exodus
Abraham cut the animals in two	A - A’	Moses splits the sea in two
Abraham placed the pieces opposite to each other	B - B’	the camp of Israel faced the camp of the Egyptians
Abraham drove away the vulture	C - C’	God threw the Egyptian army in confusion.
A burning torch passed between the pieces	D - D’	pillar of fire following the Israelite while they crossed the split sea.

A journey that lasted 430 years (in 6 steps)
(Covenant of the land to Exodus)

(1) For the first time Abraham received a covenant

- Gen 15:18 On the same day the LORD made a covenant with Abram, saying: "To your descendants I have given this land, from the river of Egypt to the great river

(2) that was accompanied by a **sign**

- Gen 15:9-10 So He said to him, "Bring Me a three-year-old heifer, a three-year-old female goat, a three-year-old ram, a turtledove, and a young pigeon." Then he brought all these to Him and cut them in two, down the middle, and placed each piece opposite the other; but he did not cut the birds in two. NKJV

(3) And in order to inaugurate (and seal) this covenant, **God went through the cutting into parts.**

(4) **And 430 years went by**

- Ex 12:40-41 Now the sojourn of the children of Israel who lived in Egypt was four hundred and thirty years. ... all the armies of the LORD went out from the land of Egypt.

NOTE: Ex 12:40 seems to say that the children of Israel lived in Egypt for 430 years but with the proper punctuation the expression 'who lived in Egypt' become a distinctive mark that should be associated with the 'children of Israel' rather than the 'sojourn'.

➔ Now the sojourn of the children of Israel, who lived in Egypt, was 430 years...

Here the word used by the translators to describe what the children of Israel were doing for 430 years is 'sojourn' (or 'dwelling'). Wouldn't the text be better served with a word like 'journey'?

➔ Now the 'journey' of the children of Israel, who lived in Egypt, was 430 years...

(5) God remembered the covenant and was ready to give the Israelites their land:

- Ex 6:4-5 I have also established My covenant with them, to give them the land of Canaan, the land of their pilgrimage, in which they were strangers. And I have also heard the groaning of the children of Israel whom the Egyptians keep in bondage, and I have remembered My covenant. NKJV
- Ex 6:8 and I will give it to you as a heritage NKJV

(6) Prior receiving the object of the covenant⁶³ that was sealed when God went through the parts, the Israelites **went through the sea, which had been physically split.** (We have here a clear reminder of the true origin of this covenant.)

- Ex 14:16 But lift up your rod, and stretch out your hand over the sea and divide it. And the children of Israel shall go on dry ground through the midst of the sea. NKJV

⁶³ that is : the land

The Exodus also echoed another event that occurred during the very same year of the ‘cutting into parts’⁶⁴. It is Hagar’s pregnancy.

The second event: Hagar’s pregnancy

H A G A R	<p>An (A) <u>Egyptian slave</u> was (B) <u>mistreated</u> by her (C) <u>Hebrew mistress</u>. She (D) <u>fled</u> into the (E) <u>desert</u> where she was met by an (F) <u>angel</u> while she rested near a (G) <u>spring</u> on the road to (H) <u>Shur</u> .</p> <ul style="list-style-type: none"> • Gen 16:6-7 " Then Sarai mistreated Hagar; so she fled from her. The angel of the LORD found Hagar near a spring in the desert; it was the spring that is beside the road to Shur NIV
-----------------------	--

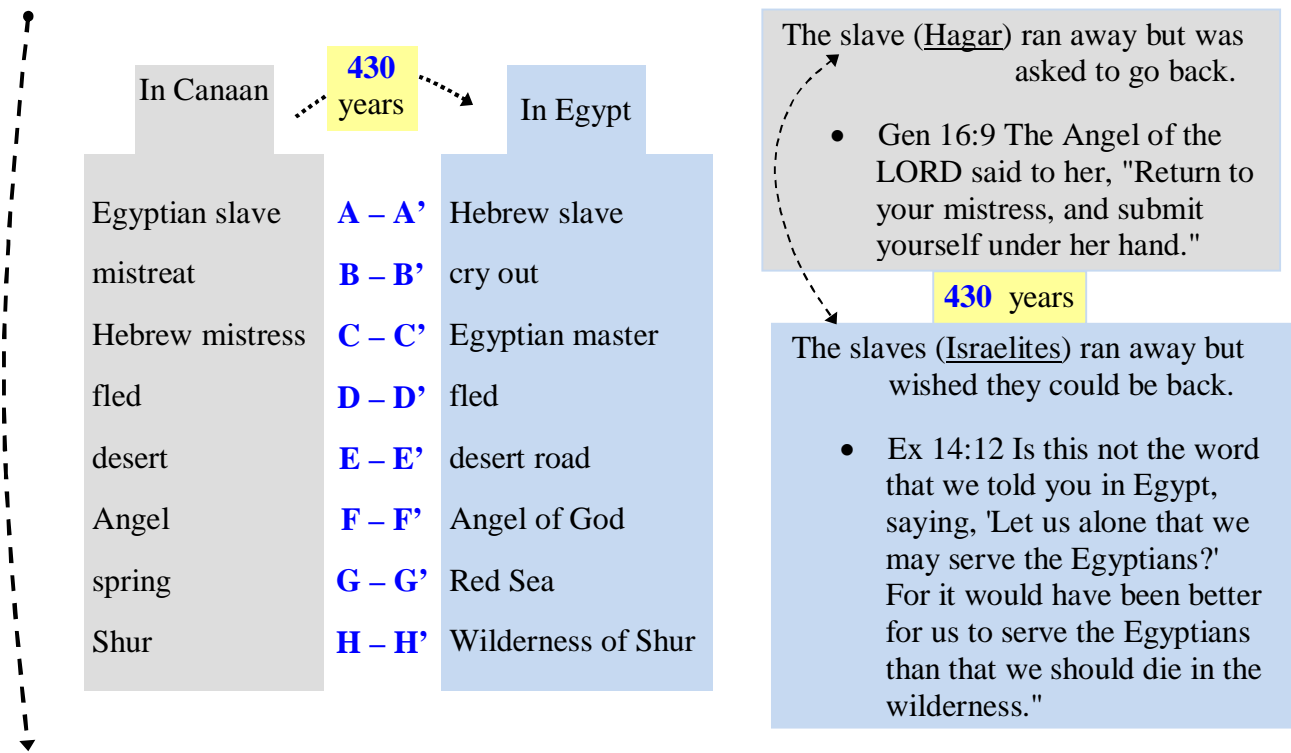

E X O D U S	<ul style="list-style-type: none"> • Ex 3:7 "I have indeed seen the misery of my people [A' <u>Hebrew slave</u>] in Egypt. I have heard them B' <u>crying out</u> because of their slave drivers [C' <u>Egyptian master</u>], and I am concerned about their suffering. • Ex 13:18 So God led the people around by the E' <u>desert</u> road toward the <u>Red Sea</u>. • Ex 14:5 When the king of Egypt was told that the people D' <u>had fled</u>, • Ex 14:19 Then the F' <u>angel of God</u>, who had been traveling in front of Israel's army, withdrew and went behind them. • Ex 15:22 So Moses brought Israel from the G' <u>Red Sea</u>; then they went out into the H' <u>Wilderness of Shur</u>.
----------------------------	--

⁶⁴ ‘Cutting in two parts’ or ‘Covenant of the land’ are used interchangeably in the present book.

A subordinate journey that lasted 400 years

(From Akedah to Exodus)

With the link between 'Covenant of the land' and 'Exodus' now established we are well positioned to determine with absolute certainty the origin of the 400 years of Gen 15:13.

- Gen 15:13 Then He said to Abram: "Know certainly that your descendants will be strangers in a land that is not theirs, and will serve them, and they will afflict them **four hundred years**. NKJV

Knowing that this period ended at the Exodus, it is a simple matter to go backwards 400 years and see where it brings us. From the previous material we deduce that Isaac was 15 at that time, which in itself is a non event and wouldn't qualify as a meaningful start for the 400 years. But suppose Isaac was 15 years old when he was sacrificed by Abraham! (The Jews refer to this event as 'the binding of Isaac' and call it by the Hebrew word 'AKEDAH')

The Bible doesn't give any direct chronological link to Isaac's binding. Isn't it surprising when we think about it? Isn't it quite inconceivable that the biggest act of obedience and faith ever described in the Bible, the most important symbolic act, an act that would be mirrored at Yeshua's death, wouldn't be accurately dated when more than 300 chronological references are available to chart all kinds of other events? Isn't it possible that the 400-year period had its origin in the year of Isaac's binding? Is there any other event that could be more meaningful to mark the beginning of this important period?

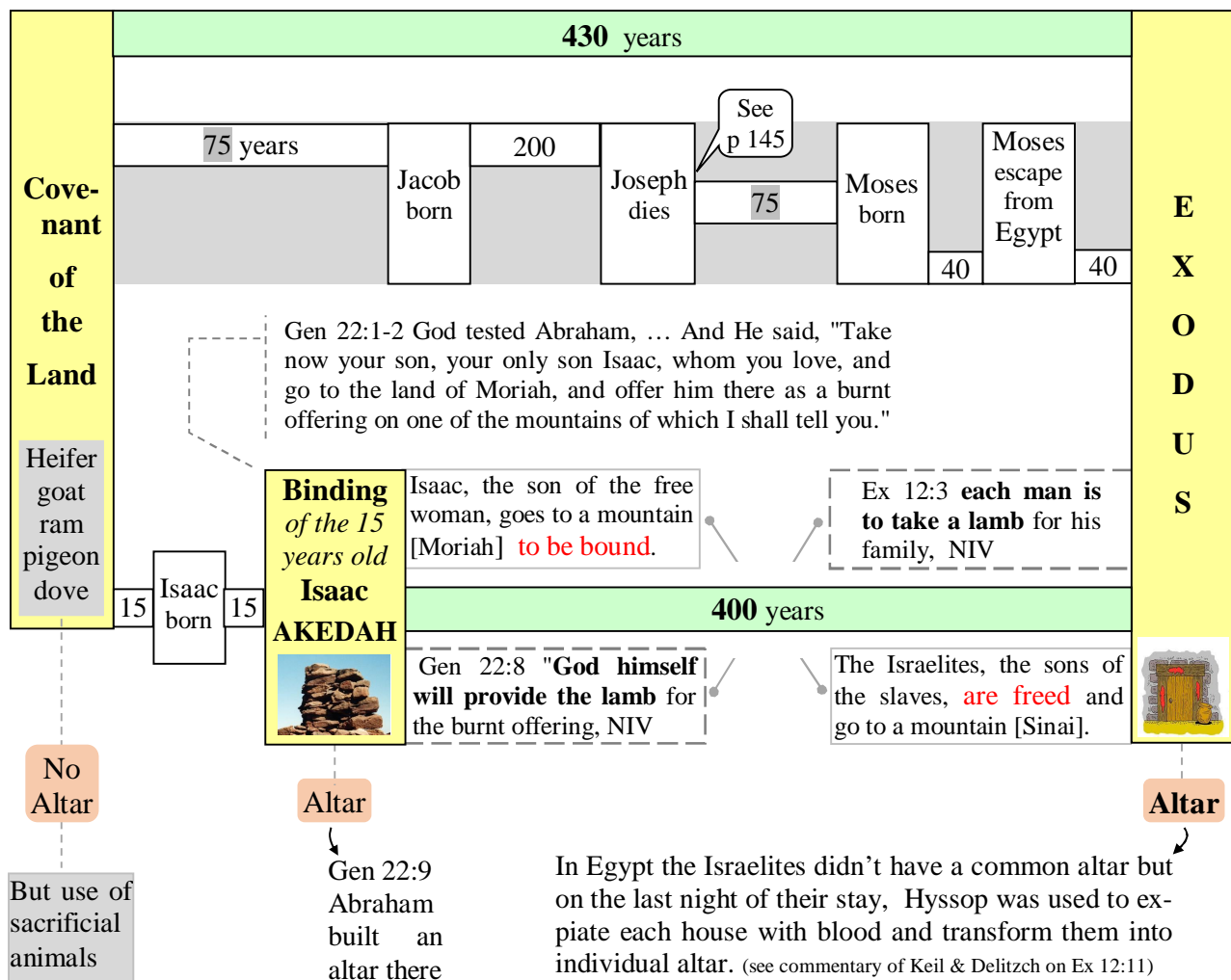

In Gen 15:13 we are told that the 400-year period has to do with the whereabouts of Abraham's descendant. It goes without saying that we should have argued that Isaac's birth, the first Abraham's legitimate son, was the rightful event to start the 400-year period. Unfortunately the preceding chart shows that it is not possible, Isaac was already 15 years old when the 400-year period started. This is why the 'binding' of Isaac is the next best choice if not in fact a better one? Here is why.

First a few facts to show that Isaac was neither an infant nor an adult at the time of the binding. One can say that at 15 years old, he was in the right age range.

Old enough to worship

- Gen 22:5 We will worship and then we will come back to you." NIV

Strong enough to hold all the wood

- Gen 22:6 Abraham took the wood for the burnt offering and placed it on his son Isaac, NIV

Still young enough to be called "boy"

- Gen 22:5 He said to his servants, "Stay here with the donkey while I and the boy go over there. NIV

NOTE: w^ahana`ar the Hebrew word translated here as "the boy" could describe Isaac any period from the age of infancy to adolescence.

We are told that God would establish a covenant with Isaac.

- Gen 17:19 I will establish My covenant with him [Isaac] for an everlasting covenant, and with his descendants after him. NKJV
- Gen 17:21 1 But My covenant I will establish with Isaac, NKJV

We are also told that Abraham and Isaac would be involved (together?) in a covenant and a promise.

- 1 Chron 16:16 The covenant which He made with Abraham, And His oath to Isaac, NKJV
- Ps 105:9 the covenant he made with Abraham, the oath he swore to Isaac. NIV

We know that a covenant was confirmed to Abraham at Akedah.

- Gen 22:15-17 The angel of the LORD called to Abraham from heaven a second time and said, "I swear by myself, declares the LORD, that because you have done this and have not withheld your son, your only son, I will surely bless you.. NIV

Could it be that Isaac was also chosen during Akedah?

Isaac's relationship with his father Abraham culminated at Akedah. The only bonding activity between them that was ever documented in the Bible was the three days' journey to Mt. Moriah. During this trip Abraham's sadness must have been almost unbearable. How could it have been different? He had just been asked to do the most difficult thing ever: to show his

unfaltering obedience to God by voluntarily killing the unexpected son of his old age, the only son he shared with Sarai, a son that he loved⁶⁵ very much. At age 15, Isaac was old enough to understand what was going on and if he had ever witnessed his father making a sacrifice to God in the past, he must have sensed that this time something was quite different.

- Gen 22:7 "The fire and wood are here," Isaac said, "but where is the lamb for the burnt offering?"

Whether he had known for some time or had only learned at the last minute that he would be the victim, it didn't make any difference. Isaac never offered any resistance and he followed his father unrestrained, to the top of the mountain where an altar would be built.

- Gen 22:5 Stay here with the donkey while I and the boy go over there.

Thirty years after the Covenant of the land Abraham was 115 years old (see Figure 13 Abraham timeline on page 80) and would never have been able to bind his 15 year old son if he had refused to cooperate. Isaac was a consenting victim who could have found many opportunities to run away, but he didn't. On the contrary, he even walked the last stretch to the altar by himself.

- Gen 22:9 He bound his son Isaac and laid him on the altar, on top of the wood.

The sacrifice of Isaac was a request so well chosen that it allowed Abraham and Isaac to independently prove their worth to God at the same time.

- ❖ Abraham proved himself by offering his son in sacrifice.
- ❖ Isaac proved himself by accepting to be the sacrifice.

At Akedah Isaac didn't object to his father's plan and he totally accepted that he would die. In fact, he came so close to death that one can say that symbolically he did die. But then, if there was a symbolic death, it had to be followed by a symbolic resurrection and the opportunity of a new beginning. That day Isaac inherited his father's covenant.

- Gen 15:13 Then He said to Abram: "Know certainly that your **descendants** will be **strangers** in a land that is not theirs, and will serve them, and they will afflict them **four hundred years**. NKJV

The only remaining question before one can fully accept that Akedah is at the origin of the 400-year period is the following. Did Isaac, the new born descendant, begin this new journey by being a **stranger** in a land that was not his? The answer is: Absolutely! Have you noticed that Isaac never returned home with his father?

- Gen 22:19 Then Abraham returned to his servants, and they set off together for Beersheba. And Abraham stayed in Beersheba. NIV

In fact it will take 25 years before we hear about Isaac again. Gen 24:62 tells us that he has been living in the Negev and he is about to meet his future wife.

⁶⁵ Gen 22:2 "Take your son, your only son, Isaac, whom you love,

Abraham leaves Haran and goes to Canaan

Abraham went for a 3 days journey to offer a sacrifice . Gen 21:4

The 400 years of Gen 15:13

40

Binding of Isaac

Instead of dying during the sacrifice, Isaac was saved at the last second. This symbolic **rebirth** is the most appropriate start for the **400 years** found in:

Heb 11:19 Abraham reasoned that God could raise the dead, and figuratively speaking, he did receive Isaac back from death.

Gen 15:13 "Know certainly that your **descendants** will be strangers in a land that is not theirs, and will serve them, and they will afflict them **400 years**."

Gen 28 :3 May God Almighty bless you and make you fruitful and increase your numbers **until** you **become** a **community of peoples**

To God, the **whole community of Israel** is viewed as a **firstborn** son: Ex 4:22-23 Israel is my firstborn son, and I told you, "Let my son go

400 y.

The **'rebirth'** of Isaac leads to the **birth** of Israel

The **'women giving birth'** symbol. On the night before they left Egypt, the Israelite's houses became like the womb of pregnant women ready to give birth after 40 weeks. (40 w. / 400 y.)

While the first born of the Egyptian were dying, those of the **Israelites** were miraculously protected. Figuratively speaking and similar to Isaac, one can say that they were also received **back from the dead**.

1. Pharaoh had increased the people's labor. Ex 5:9
2. In Ex 3:10 Moses is told to bring them (i.e. Abraham's descendants, see Gen 15:13) out of Egypt || When water breaks, a woman knows the birth of her child is near.
3. Men waited with the loins girded (legs free) Ex 12:11
4. Everybody eat in haste Ex 12:11, (impending event). Unleavened bread used, picturing the urgency of the situation by the lack of time to introduce leaven in it).
5. Through Egypt **'wailing'** was heard Ex 11:6 || Period of active labor for a woman
6. Nobody would leave his house before the appointed time Ex 12:22 || delivery's time cannot be shorten
7. Early in the morning, people went out through a **bloody entrance**. Ex 12:7 || Birth of the child
8. That day God delivered the nation Ex 14:13 || The midwife helps the baby during the birth
9. Any meat left over had to be completely burned before the morning (Ex 12:10) . || Women's afterbirth need to be disposed of (buried or burned).
10. That morning the Egyptians gave the Israelites women pieces of clothing for their children. Ex 3:22
11. The day, similar to a child birthday, would be commemorated in the future Ex 13:3
12. For many years afterward, God took care of his children and feed them in the desert. Ex 8:16

Metaphor of a child delivery

- 1 Labor increase
- 2 Water breaks
- 3 free the legs
- 4 Impending event
- 5 Wailing
- 6 Appointed time
- 7 Bloody exit
- 8 Delivery
- 9 Disposal of afterbirth
- 10 Gift received
- 11 Day to remember
- 12 Nursing the baby

Exodus

40

Nation of Israel comes to the Promised Land

Moses requested an authorization to make a 3 days journeys to offer a sacrifice. Ex 3:18

The child delivery metaphor took place on the vey night every Egyptian first born died.

The 430 years and 400 years countdown from Exodus

Covenant of the land
 Gen 15:18 To your descendants **I give this land**
 (Cutting Into 2 parts Gen 15:10)

A covenant involves 2 parties	God binding part of the covenant	A covenant involves pouring blood
	Abraham binding part of the cov..	

Blazing torch Gen 15:17



Gen 22:10

Fire on the altar Gen 22:9

Binding of Isaac 'Akedah'

430

Ex 12:40 Now the sojourn of the children of Israel who lived in Egypt was **430** years.

Gen 15:13 and they will be enslaved and **mistreated 400** years.

Isn't Isaac's **binding** the most obvious way to start this 400 years of 'mistreatment'?

Exo.14:16

Pillar of fire Exo 14:24

EXODUS
 (Cutting the sea in 2 parts)

on P. 181

60

60

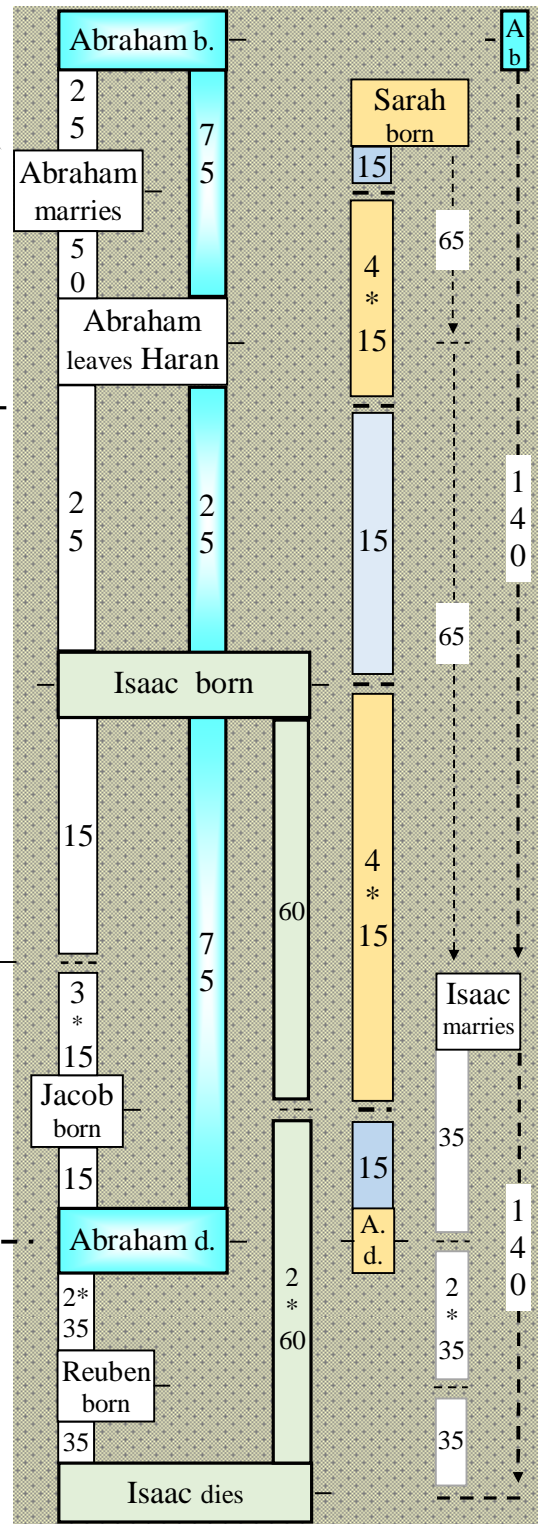

Awesome complementarity
between 4 periods
portrayed by Ezekiel

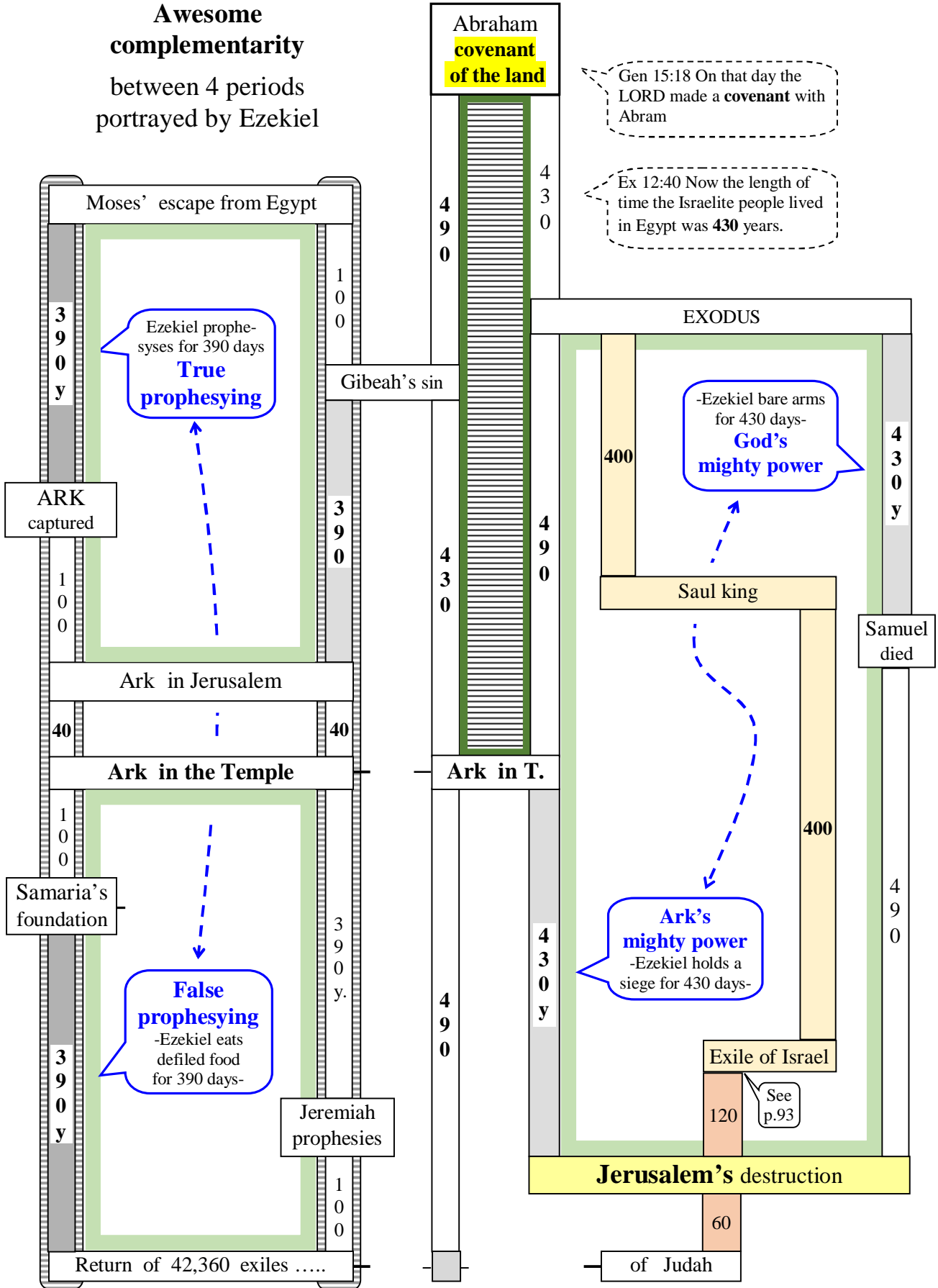

Figure 14. Covenant of the land

Ezekiel shaves his hair

Ezek 5:1-3 "And you, son of man, take a sharp sword, take it as a barber's razor, and pass it over your head and your beard; then take balances to weigh and divide the hair. You shall burn with fire one-third in the midst of the city, when the days of the siege are finished; then you shall take one-third and strike around it with the sword, and one-third you shall scatter in the wind: I will draw out a sword after them. NKJV



We learn in Ezekiel 5:12 that everything that was done with the hair (i.e. Burn, Strike, Scatter) would also be done to the population of Jerusalem:

- Ezek 5:12 One-third of you shall die of the pestilence, and be consumed with famine in your midst; and one-third shall fall by the sword all around you; and I will scatter another third to all the winds, and I will draw out a sword after them. NKJV

The purpose of having Ezekiel shave his hair was to use the hair to show how the people of Jerusalem would be punished. The whole action could have been done without interruption right after Ezekiel's 430-day siege.

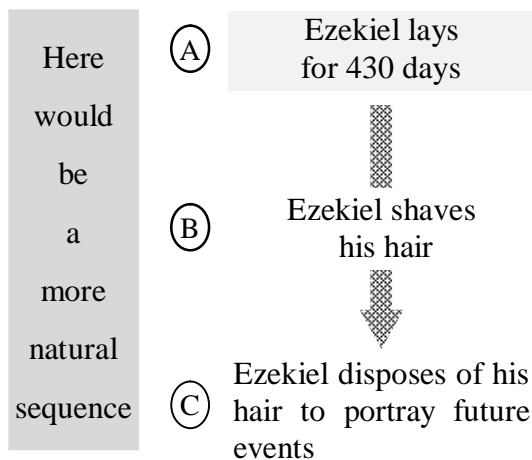

Unexpectedly it was done in a different way.

Ezekiel was told to shave all his hair and (see Ezek 5:2) wait until the end of his siege before using the hair to portray future events. Why can we be confident that it was done in that order? Because there wouldn't have been any point in telling him to wait until the end of his siege to burn the hair if that siege had already been mimicked.

Ezek 5:2 You shall burn with fire one-third in the midst of the city, **when the days of the siege are finished**; NKJV

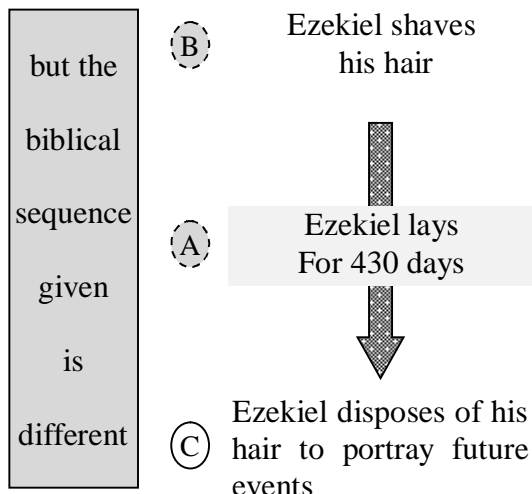

Why was a ‘delay of 430 days’ introduced between the shaving and the disposing of the hair? What could possibly justify the two actions being separated the way they were? In this paper, we have previously seen that many symbolic acts took place at the beginning of Ezekiel’s siege. Was there also a symbolic act associated with the ‘shaving’ itself? Yes.

In order to find where the ‘shaving action’ is meant to lead us, we first need to understand how deeply humiliating the shaving of his head and beard must have been to Ezekiel:

- Lev 21:5-6 They shall not make any bald place on their heads, nor shall they shave the edges of their beards nor make any cuttings in their flesh. They shall be holy to their God NKJV
- 2 Sam 10:4-5 Therefore Hanun took David's servants, shaved off half of their beards, cut off their garments in the middle, at their buttocks, and sent them away. When they told David, he sent to meet them, because the men were greatly **ashamed**. And the king said, "Wait at Jericho until your beards have grown, and then return." NKJV

To have his beard and hair shaved was a **humiliating** experience for a priest and even though he was only performing a symbolic act there is no reason to believe that Ezekiel would have felt differently at the start of his 430-day siege. The keyword to understand this new symbolic act is ‘humiliation’. We have to find a period of 430 years, initiated by an event that turned out to be greatly humiliating for the whole House of Israel. This event can be found without too much difficulty for it had a tremendous effect on the Israelites:

It is the **capture of the Ark** by the Philistine (1 Sam 4:10-11):

- 1 Sam 4:13 And when the man came into the city and told it, all the city cried out.



What should have been a day of victory for the people of Israel turned out to be a day of great stupefaction, confusion and humiliation. This was prophesied earlier by Samuel:

- 1 Sam 3:11 Then the LORD said to Samuel: "Behold, I will do something in Israel at which both ears of everyone who hears it will tingle⁶⁶. NKJV

The daughter of Eli, who gave birth that day, named her child in relation to this event:

- 1 Sam 4:21 Then she named the child Ichabod, saying, "The glory has departed from Israel!" because the ark of God had been captured

Notice here the perfect relationship between

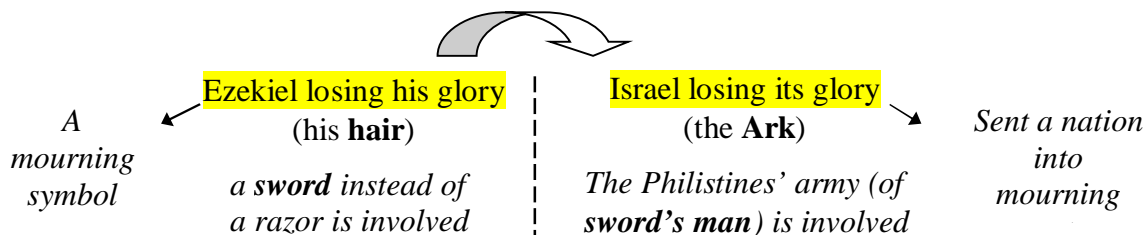

⁶⁶ According to Strong’s definition (6750) tingle carries the idea of ‘vibration’ of the ears in reddening with shame.

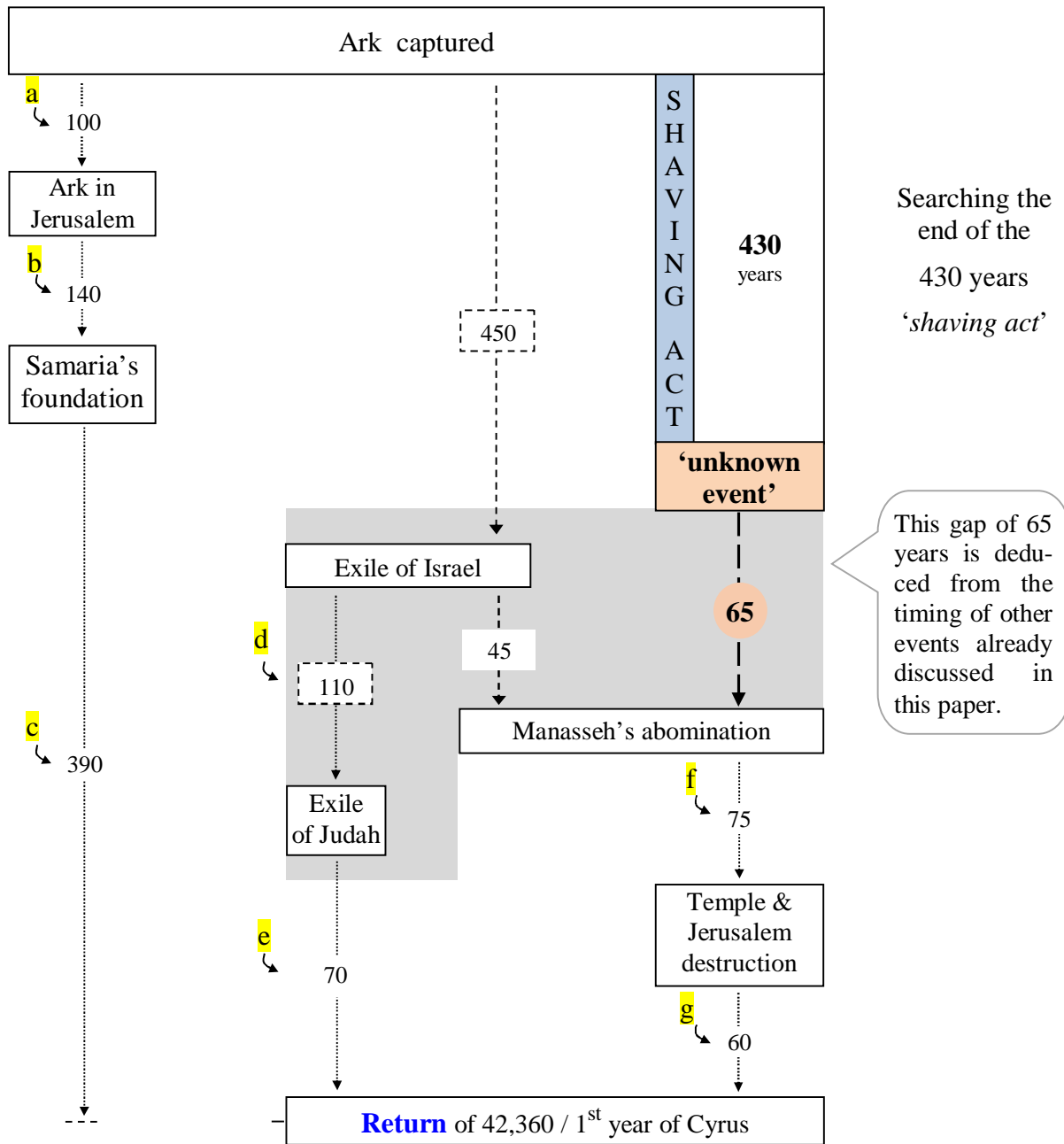
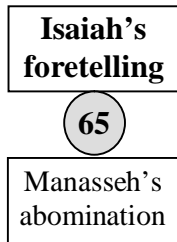

Figure 15. Shaving act

References:

- a Ark captured to Ark in Jeru.. = 100 : Figure 12. Ezekiel defiled food on page 78
- b Ark in Jeru. to Samaria foun. = 140 : Figure 12. Ezekiel defiled food on page 78
- c Samaria found... to Return = 390 : Figure 12. Ezekiel defiled food on page 78
- d see my book 'The 44 Hebrew monarchs' on page 52
- e Exile of Judah to Return = 70 : Figure 11. Defiled food on page 72
- f Manasseh's abomination
to Temple destruction = 75 : Figure 1. Judah's 40 years of Sin p.16
- g Temple destruction to Return = 60 : Figure 11. Defiled food on page 72

In the preceding figure we have established that the end of the ‘430-year period’ symbolized by Ezekiel’s shaving, happened 65 years before Manasseh’s desecration of the Temple. This 65-year connection would have been meaningless in itself, but there is a strong possibility that it is the same period that is referred to in an important prophecy of Isaiah.



- Isa 7:8-9 Within **sixty-five years** Ephraim will be too shattered to be a people. The head of Ephraim is Samaria, and the head of Samaria is only Remaliah’s son. NIV

The following figure shows that Isaiah’s prophecy was told at the beginning of Ahaz’s kingship. It could not have been told after Ahaz’s third year given that it was delivered in response to King Pekah’s menace.

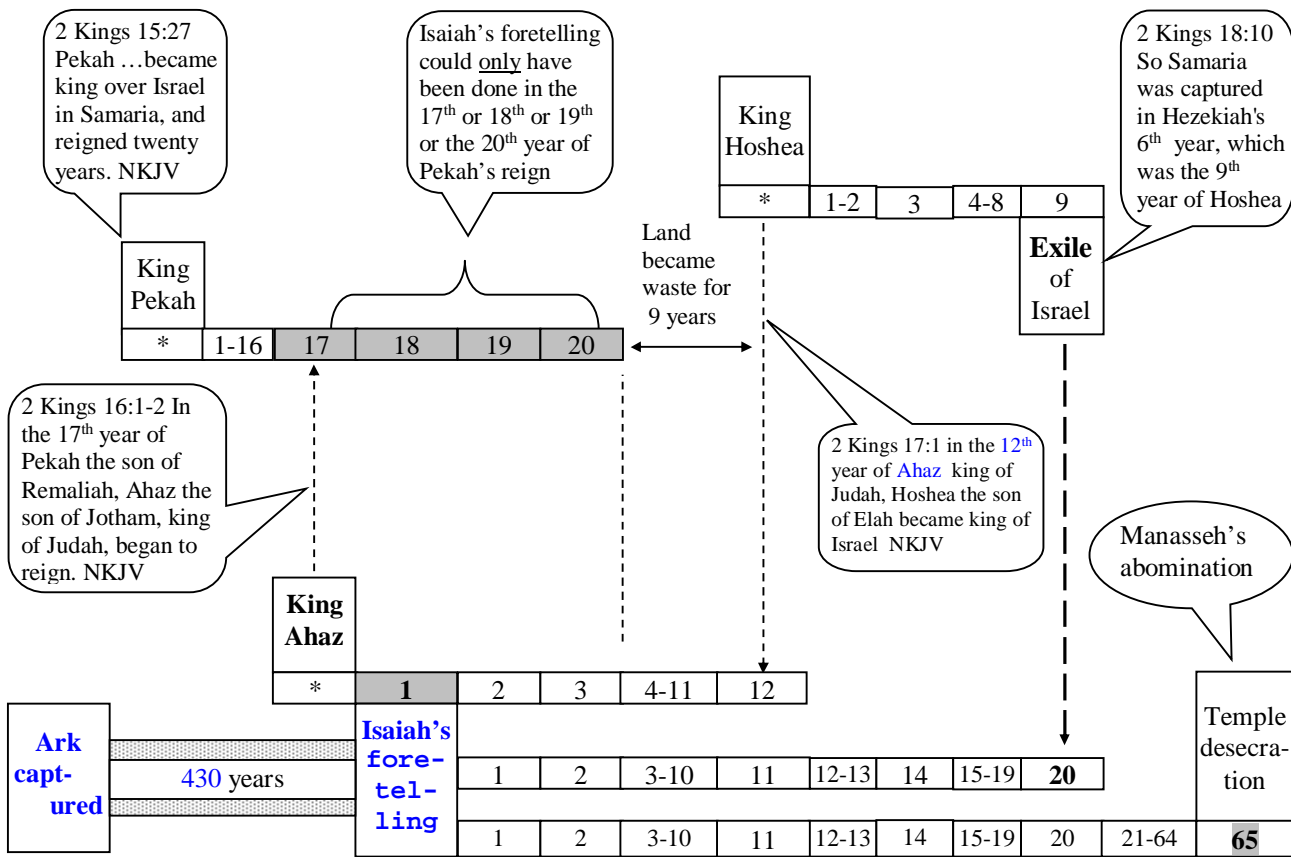

In the preceding figure, in spite of the fact that it could also have been told in the second or third year of Ahaz, it is ‘postulated’ that Isaiah’s prophecy was delivered in the **first** year of King Ahaz. Note that Isa 7:16 implies that between the time the prophecy was delivered and the end of King Pekah’s kingship, a boy would have matured enough to know right and wrong.

If the 'capture of the Ark' is an event that could match the humiliation suffered by Ezekiel when he had to shave, we haven't yet justified that 'Isaiah's foretelling' is the appropriate event to close the 430-year period. This is what we are going to do shortly.

When Isaiah told King Ahaz that within 65 years Israel (Kingdom of Israel) wouldn't be a 'people' anymore, he was certainly not referring to the Exile of Israel. If the reader looks at the preceding figure he will notice that Israel went into exile only 20 years after Isaiah's foretelling. The question that should be asked is: Why then did Isaiah allude to a time that was 45 years (65 – 20) after the Exile of Israel? The answer is that even though Israel was sent into Exile in the 9th year of Hosea it is assumed that many people (from the northern tribes) had been left in their land and it would take another 45 years to remove their identity.

In 2 Chron 30:5-6 King Hezekiah of Judah, in preparation for a very special Passover (5 years after Israel went in captivity) is sending couriers all over Israel's territories to invite people to the feast in Jerusalem:

- 2 Chron 30:5-6 They decided to send a proclamation throughout Israel, from Beersheba to Dan, calling the people to come to Jerusalem and celebrate the Passover to the LORD, the God of Israel. It had not been celebrated in large numbers according to what was written. At the king's command, couriers went throughout Israel and Judah NIV

Two important facts have to be kept in mind:

1. Hezekiah wouldn't have dared send couriers into the northern territories if King Hoshea had still been ruling over the land. Therefore, we can only conclude (without the need of any timeline) that the Exile had already taken place.
2. Hezekiah wouldn't have sent couriers if nobody had been living in these territories at that time. Therefore we can deduce that not all the northern Israelites were gone.

The Exile of Israel (northern ten tribes) that took place in the 9th year of Hoshea was not enough to completely eradicate the name of Ephraim's kingdom; many people (Israelites) were still living in the territory after that Exile. Isaiah was in fact predicting that it would take another 45 years after the Exile to fully erase the Northern Kingdom's identity once and for all. How did it happen? It is believed that at the time of Manasseh's captivity (following the desecration of the Temple):

- 2 Chron 33:10-11 The LORD spoke to Manasseh and his people, but they paid no attention. So the LORD brought against them the army commanders of the king of Assyria, who took Manasseh prisoner, put a hook in his nose, bound him with bronze shackles and took him to Babylon. NIV

the King of Assyria took that opportunity to resettle (exchange) people all over the territory:

- Ezra 4:2-3 they came [people living in the land at that time] to Zerubbabel ...and said, "Let us help you build because, like you, we seek your God and have been sacrificing to him **since the time of Esarhaddon king of Assyria, who brought us here.**" But Zerubbabel, Jeshua and the rest of the heads of the families of Israel answered, "**You have no part with us** in building a temple to our God. NIV

Now that the connection between Isaiah's foretelling and Manasseh's captivity is better understood, we can investigate why this 'foretelling' is the appropriate event to close the 430-year period (symbolized by the shaving of Ezekiel) initiated with the capture of the Ark.

The scattering of Ezekiel's hairs is matched by Isaiah's foretelling

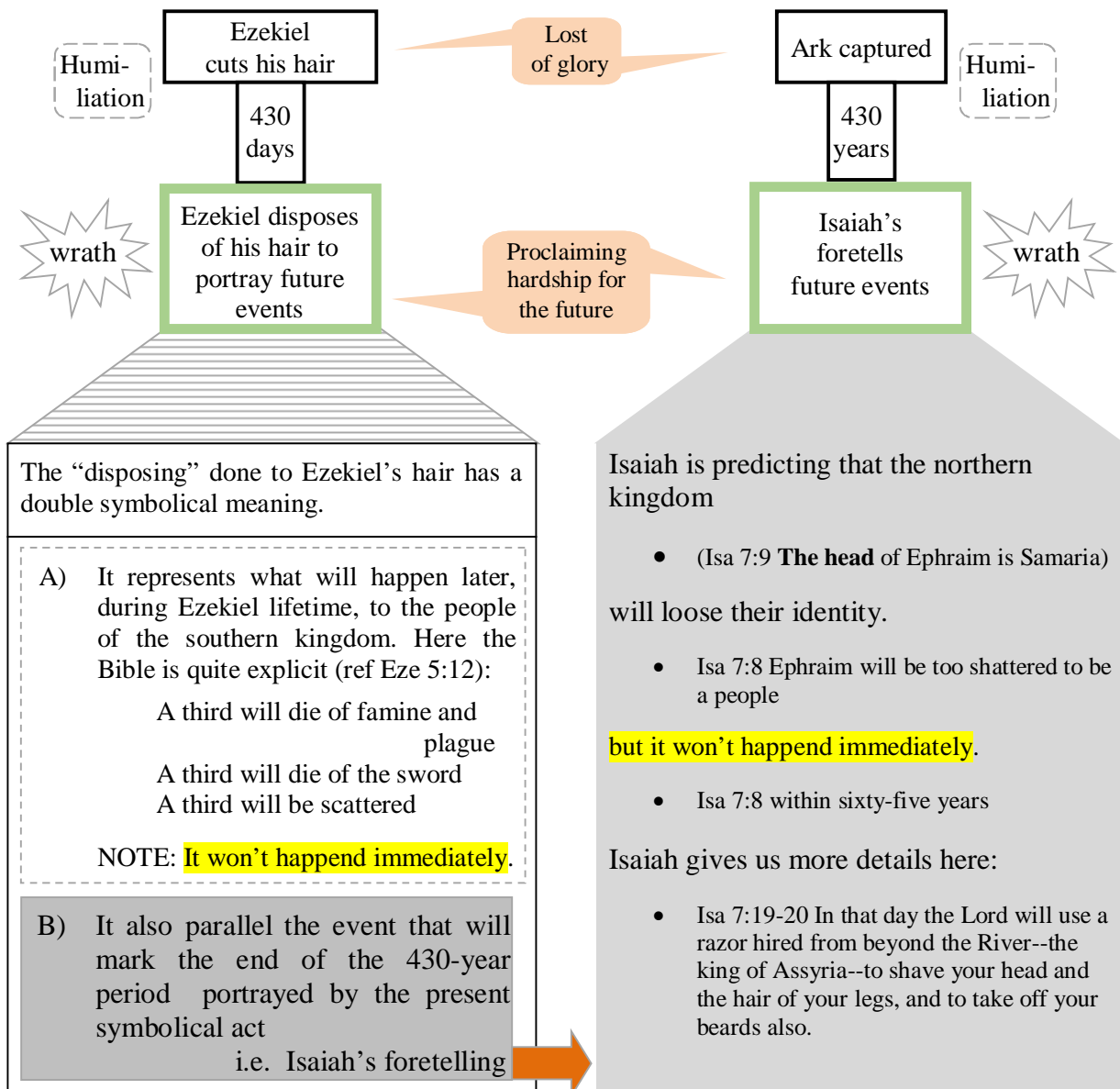

This is a clear parallel to the symbolic language used in Ezekiel. (Shave, razor, hair, beard).

If Jeremiah can equate ‘**scattering**’ (casting the hair) with ‘**rejecting Judah**’

- Jer 7:29 Cut off your hair and **throw it away** ... for the LORD **has rejected** and abandoned this generation.

then, when Isaiah tell us that God will **reject Israel**

- Israel won’t be a people
- The King of Assyria will be a razor

we can picture him (Isaiah) **scattering** some hair too.

Contrary to the other symbolic acts of Ezekiel that we have seen in this paper, the **shaving** act (i.e. cutting & disposing of) was not continuously carried on over the whole period of time that Ezekiel lay on his side. Even though it is true that the two actions (cutting & disposing of) were separated by the 430 days of his siege⁶⁷, each action was fully completed on the day it was initiated. For instance, once he had cut off his hair (first part of the shaving) it started growing again.

This is an important point to keep in mind while we are looking at the 430-year period following the capture of the Ark. The humiliation of Ezekiel (losing his hair) was never intended to become a permanent attribute⁶⁸ of the period he lay on his side. Therefore, there is no need to look for traces of ‘humiliation’ during the whole 430-year period that followed the capture of the Ark.

The second part of the shaving (disposing of the hair to portray future events) and its counterpart, ‘Isaiah’s foretelling’, mirror each other adequately. When God asked Ezekiel to dispose of his hair He was sealing the fate of the people of Judah (southern kingdom). When Isaiah said that Israel would lose its identity within the next 65 years, God was also sealing the fate of the northern 10 tribes (Ephraim). Notice that in both cases there would be many years before the things announced came to pass.

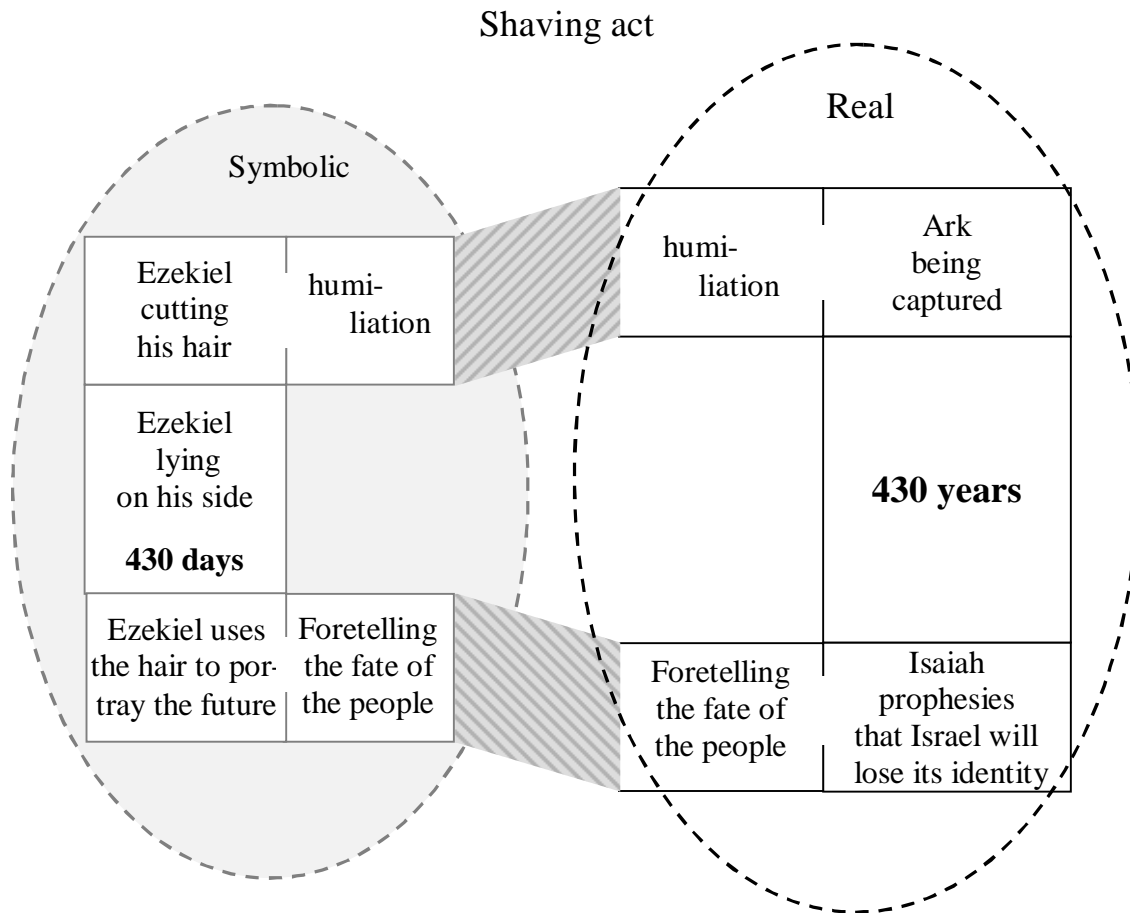

⁶⁷ Thus establishing the duration of this [‘430 days of shaving’] symbolic act.

⁶⁸ If it had been meant that way Ezekiel would have had to shave every few days during the next 430 days.

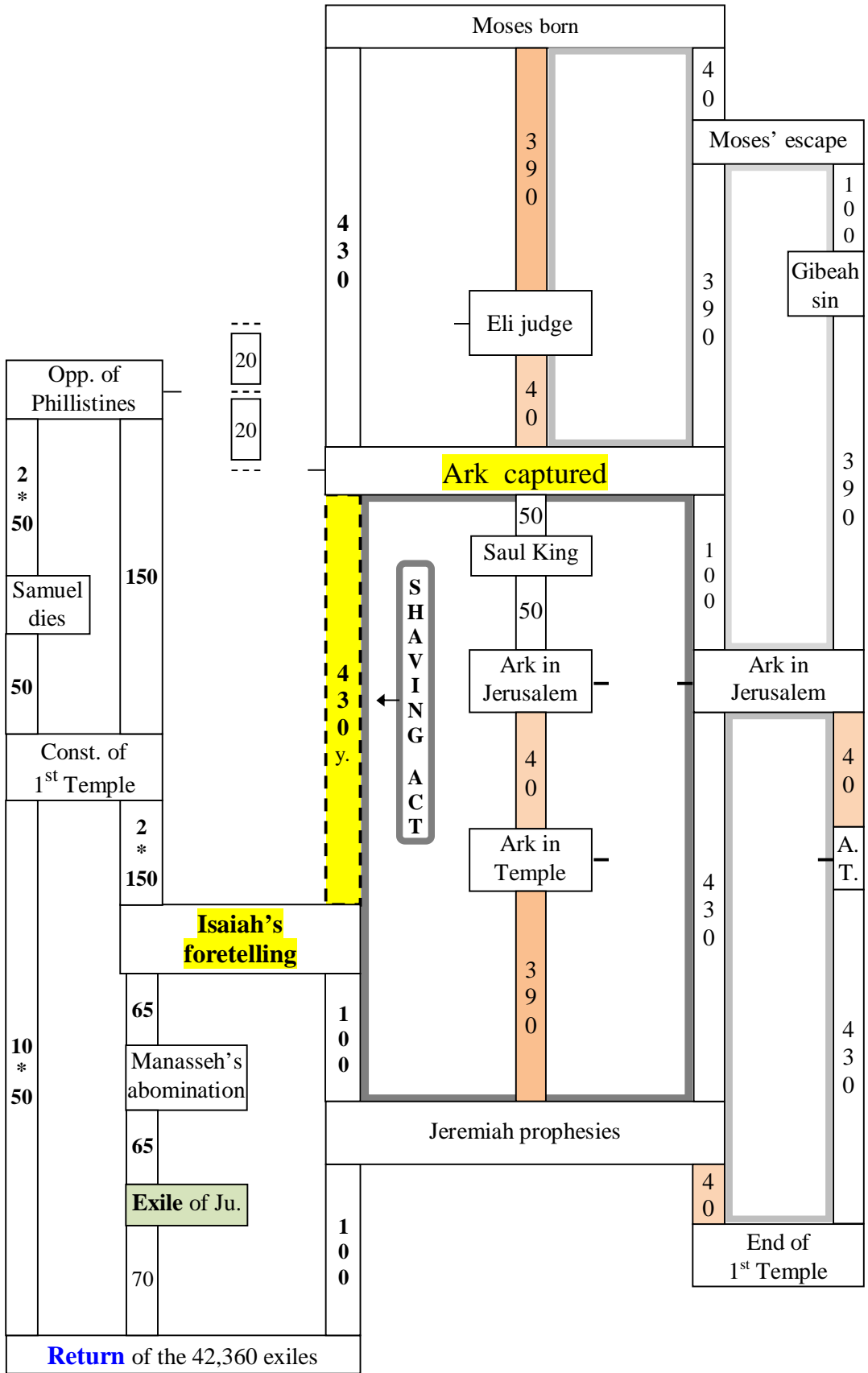

Ezekiel weighs and divides the hair

It is only when the shaving of his hair is understood as a symbolic act that we can grasp why Ezekiel had to do the ‘cutting of his hair’ at the beginning of the 430-day siege and then wait until the end of that siege before the hair is used to portray future events.

Unfortunately, this knowledge doesn’t explain why Ezekiel had to ‘weigh, and divide’ the hair immediately after the ‘cutting’ when it would seem much more natural if those two actions had been performed at the time of ‘disposal’.

Ezek 5:1 "And you, son of man, take a sharp sword, take it as a barber's razor, and pass it over your head and your beard; **then take balances to weigh and divide the hair.** NKJV

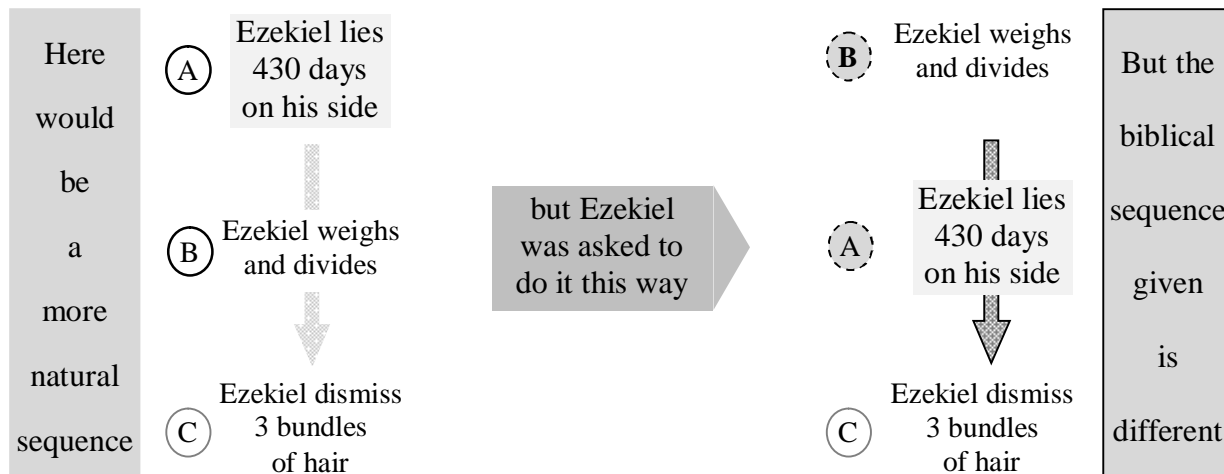

The shaving act was concluded by three different actions applied on three bundles of hair. Did it really matter if these three bundles of hair had been properly weighed or that each one had the right number of hairs?

Was there anybody around Ezekiel that would have benefited from that information? We don’t know, of course, but we can speculate that this kind of accuracy had no direct impact on the way the real object of Ezekiel’s symbolic act needed to be portrayed.

Why then was Ezekiel asked to use a scale to weigh and divide the hair at the beginning of the shaving act if accuracy was not an immediate concern?

And suppose accuracy after all was needed. Was it really obtained by using a scale? The question is pertinent. A scale can be very accurate when dividing by two, but does it maintain the same level of accuracy when dividing by three (three bundles)? And to add to the difficulty of obtaining the right measure, the material to weigh was human hair.



As we can see, it is difficult to harmonize the ‘weigh and divide’ request asked of Ezekiel at one point with the three bundles of hair he was manipulating at another point. Therefore the

solution is to stop assuming that the two sets of actions are directly related. Ezekiel was asked to weigh and divide his hair in some way at the start of the siege, but at the end of that siege, he gathered all the hair together and divided it into three bundles without the need of a scale.

Here is a proposal that reconciles all the elements:

- Ezekiel cuts his hair
- Using a scale he weighs and divides all the hair in two parts
- Ezekiel lies for 430 days on his side
- All the hair is gathered back to be separated into three bundles (no need of a scale)
- Ezekiel disposes of the three bundles

What we have here is very interesting. After dividing his hair into two quantities Ezekiel kept them that way for 430 days. Doesn't it look like we have found another symbolic act that had nothing to do with the symbolic shaving act?

The extraordinary thing with this arrangement is that we can now distinguish the sequence of a new symbolic act (WEIGH & DIVIDE) embedded in the shaving one.

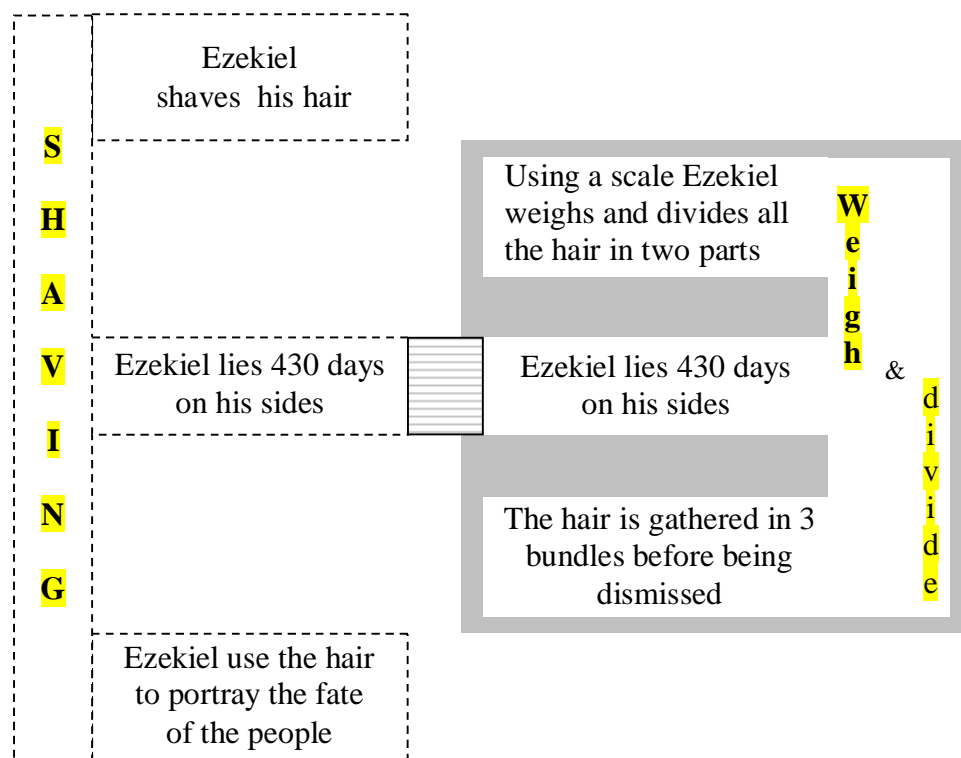

In the symbolism used by Ezekiel 'hair' represents 'people':

- Ezek 5:12 One-third of you shall ... ; and one-third shall ... ; and I will scatter another third NKJV

And 'weighing' could stand for 'evaluating':

- Prov 16:2 All the ways of a man are pure in his own eyes, But the LORD **weighs** the spirits. NKJV

Here are the elements we know about the ‘weigh & divide act’

- It must portray a period during which the people had been evaluated and divided (in two parts) accordingly.
- The dividing of the hair lasted the whole 430 days of Ezekiel’s siege;⁶⁹ therefore the event portrayed will have a long-lasting effect (430 years).
- It must depict a major set of events; otherwise Ezekiel would not have been required to portray it.

We have enough here to discern the one single event that became a turning point for Israel, i.e. the division of the kingdom⁷⁰ at the death of King Solomon.

The division of the kingdom

Solomon had been judged (evaluated, weighed) and found guilty; he was then told that his kingdom wouldn’t survive him:

- 1 Kings 11:10-11 Therefore the LORD said to Solomon, "**Because you have done this**, and have not kept My covenant and My statutes, which I have commanded you, **I will surely tear the kingdom** away from you and give it to your servant. NKJV
- 1 Kings 11:13 However I will not tear away the whole kingdom; I will give one tribe to your son for the sake of my servant David, NKJV
- 1 Kings 11:30-31 Then Ahijah took hold of the new garment that was on him, and tore it into twelve pieces. And he said to Jeroboam, "Take for yourself ten pieces, for thus says the LORD, the God of Israel: 'Behold, I will tear the kingdom out of the hand of Solomon and will give ten tribes to you NKJV

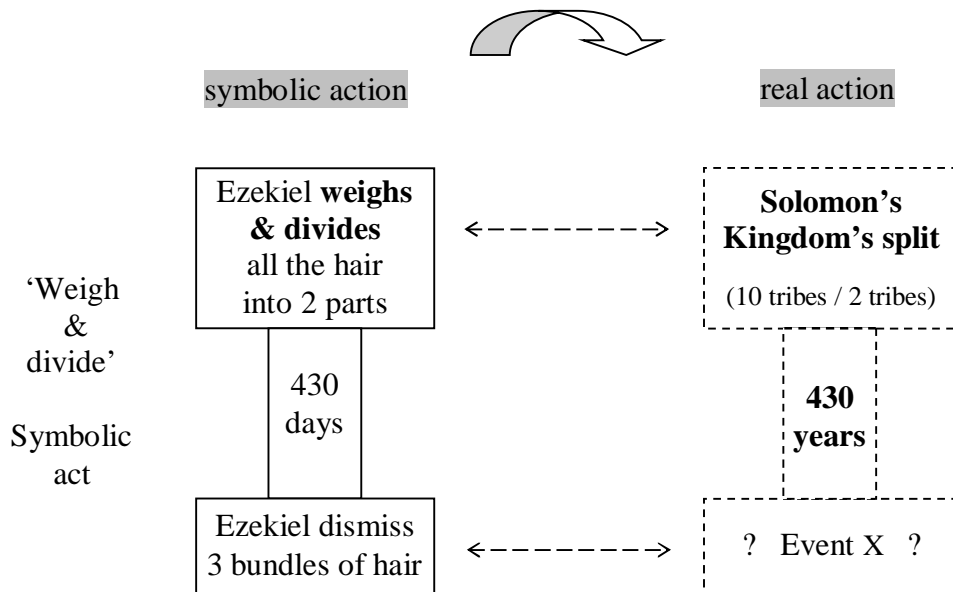

⁶⁹ In the preceding section we have seen that Ezekiel initiated one of the symbolic acts by shaving his hair but that sign of ‘humiliation’ was not a characteristic of the whole 430-day period that followed. Everybody should agree that as soon his hair had been cut it started growing again. With the ‘dividing act’ we have a different situation. Once divided the hair was kept divided until the end of the 430-day period.

⁷⁰ also called the ‘Kingdom’s split’ in this paper

The 'event x' which concludes the 430 years of 'Weigh & divide' is quite unexpected but once known it cannot be ignored. It is the division of the Babylonian Empire after 70 years of imperialism over its neighbours.

End of the 70 years of Babylonian imperialism (Fall of Babylon)

The 70 years of Babylon imperialism was the time allowed for the domination by Babylon over the surrounding nations:

- Jer. 25:9-11 I will summon all the peoples of the north and my servant Nebuchadnezzar king of Babylon," declares the LORD, "and I will bring them against this land and its inhabitants and against all the surrounding nations. and these nations will serve the king of Babylon **70 years**.

The first ruler associated with the 70 years of Babylon is Nebuchadnezzar and it was prophesied that 3 generations of his own family would rule the nations:

- Jer 27:5-7 Now I will hand all your countries over to my servant Nebuchadnezzar king of Babylon; I will make even the wild animals subject to him. All nations will serve **him and his son and his grandson** until the time for his land comes; then many nations and great kings will subjugate him.

First generation: Nebuchadnezzar (Represented by the 1st bundle of hair?)

- Dan 1:1 In the third year of the reign of Jehoiakim king of Judah, Nebuchadnezzar king of Babylon came to Jerusalem and besieged it.

Second generation: Evil-Merodach (Represented by the 2nd bundle of hair?)

- 2 Kings 25:27 In the thirty-seventh year of the exile of Jehoiachin king of Judah, in the year Evil-Merodach became king of Babylon

Third generation: Belshazzar (Represented by the 3rd bundle of hair?)

- Dan 7:1 In the first year of Belshazzar king of Babylon,

At first glance, we should associate the start of the Babylonian 70 years of imperialism with the year Nebuchadnezzar became king of Babylon (the third year of King Jehoiakim of Judah):

- Jer 25:1 in the fourth year of Jehoiakim son of Josiah king of Judah, which was the first year of Nebuchadnezzar king of Babylon.

but it is quite possible that Nebuchadnezzar had been leading his army for a few years before he became king of Babylon. If this is true, we should associate the start of the Babylonian Empire with the start of the first battle which led to a victory against a major opponent (Egypt).

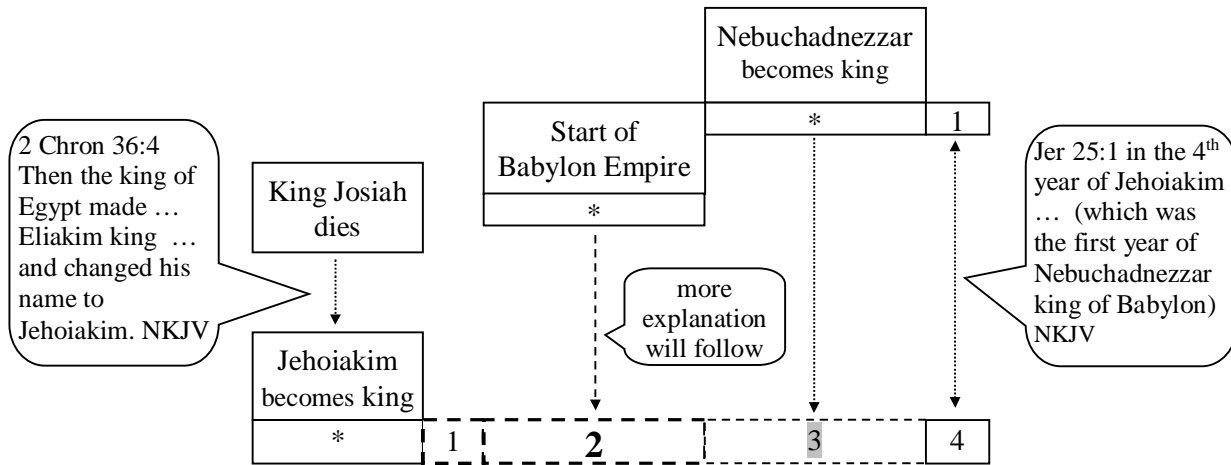

According to Jer 25:1 the 4th year of King Jehoiakim is also the first year of Nebuchadnezzar as king. We deduce that Nebuchadnezzar became king of Babylon in the third year of King Jehoiakim.

According to Jer 46:2 Egypt was defeated by Nebuchadnezzar in the 4th year of King Jehoiakim:

- Jer 46:2 concerning the army of Pharaoh Necho, king of Egypt, which was by the River Euphrates in Carchemish, and which Nebuchadnezzar king of Babylon defeated in the fourth year of Jehoiakim the son of Josiah, king of Judah: NKJV

According to 2 Chron 36:4 it was the Pharaoh of Egypt who crowned Jehoiakim king in Jerusalem, therefore we ‘assume’ that Egypt was not yet in conflict with Nebuchadnezzar at the beginning of Jehoiakim’s kingship:

From the previous references we deduce that some time in the first, second or third year of King Jehoiakim, Nebuchadnezzar was at the head of his army, engaged in battle (thus setting the true beginning of the Babylonian imperialism) against Egypt. We are going to postulate that the Babylonian Empire started **in the second year of King Jehoiakim**.

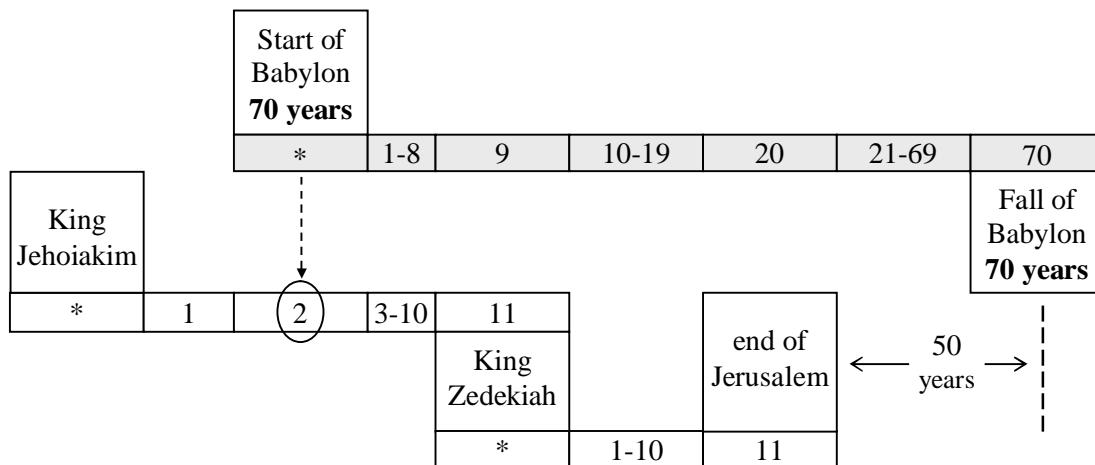

Using the fact that the ‘end of the 70-year Babylonian imperialism’ happened 50 years after the ‘destruction of Jerusalem’ (by Nebuchadnezzar’s army) we can now count backwards 430 years from this event and figure out that the ‘kingdom’s split’ occurred a mere 40 years after Solomon completed his new Palace.

From ‘Ark in Temple’ to

① Jerusalem’s destruction
= 430 years see page 29

From ‘Jerusalem’s destruction’

② to ‘Fall of Babylon’
= 50 years see previous page

From ‘Ark in Temple’ to

③ ‘Solomon’s palace ready’
= 10 years -see page 72

From ‘kingdom’s split’ to

④ ‘Fall of Babylon’
= 430 years
-our dividing symbolic act

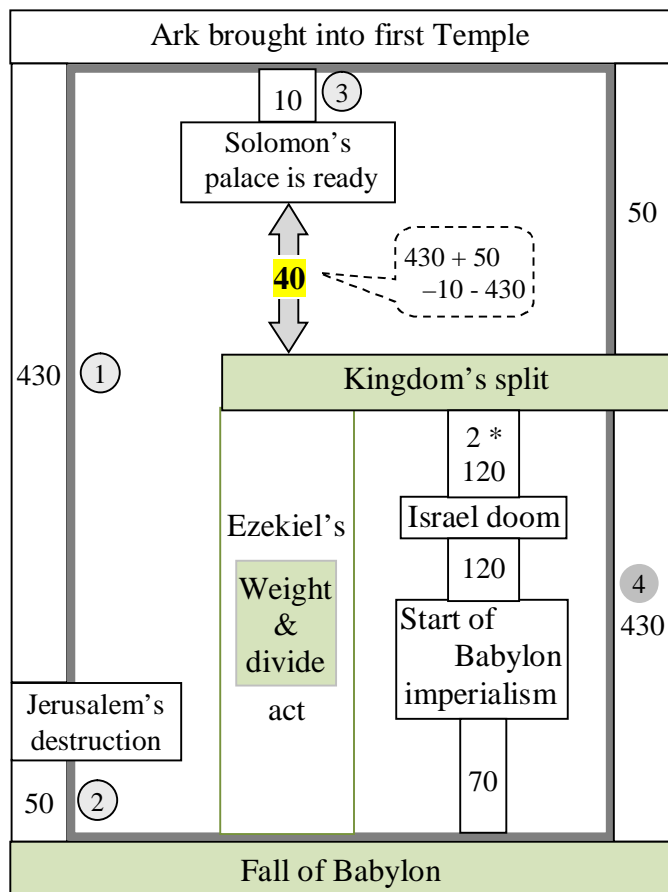

How long did Solomon reign?

Now that the ‘kingdom’s split’ has been accurately fixed we have enough to invalidate the widespread belief that Solomon’s kingship lasted only 40 years. We will see that in fact **Solomon had been king for 63 years.**

Solomon’s death occurred shortly before the ‘kingdom’s split’ and we have just learned in the previous figure that this ‘split’ occurred 40 years after Solomon’s palace became available. It ensures that Solomon’s reign had been longer than 40 years. Many readers would find it outrageous if they were asked to question the authenticity⁷¹ of 1 Kings 11:42 where it is mentioned that Solomon reigned over Israel for a total of 40 years. Fortunately, they won’t be asked such a thing. According to the previous figure, from the completion of his palace to his death (shortly before the kingdom’s split) there is a period of 40 years. This **has to be** the same ‘40 years’ as the one mentioned in 1 Ki 11:42. But before accepting this convenient interpretation, one point needs to be clarified. Why would 1 Ki 11:42 emphasize only the last 40 years of Solomon’s reign and choose to ignore the first 23 years during which Solomon built the Temple and his Palace?

The answer is found in

- 1 Kings 3:14 So if you walk in My ways, to keep My statutes and My commandments, as your father David walked, then I will lengthen your days." NKJV

⁷¹ 1 Kings 11:42 And the period that Solomon reigned in Jerusalem over all Israel was forty years. NKJV

Among all the things God told Solomon He would give him, there is only one that came with a condition attached. Solomon would first have to walk in God's way before he received a long life. In other words, there would be a period of evaluation **before** the promise would be delivered. God appeared to Solomon right after the completion of the Palace. This would be 23 years after the beginning of Solomon's reign (see on page 69).

- 2 Chron 7:11-12 ... and Solomon successfully accomplished all that came into his heart to make in the house of the LORD and in his own house. **Then the LORD appeared to Solomon by night, NKJV**

The Theophany of 2 Chron 7:12 is a proof that Solomon's reign had reached a **turning point**. Up to that time Solomon had been on 'probation' and needed to demonstrate that he was a worthy king. By appearing to him a second time God was acknowledging that Solomon had done well and he would be allowed a long life. Isn't it quite revealing that all this happened at the very time the new Palace became available? As if, symbolically, Solomon's reign was given an official start at the very time he was going to occupy his new palace.

Solomon's kingship lasted 63 years

(Solomon and David reigned 100 years altogether)

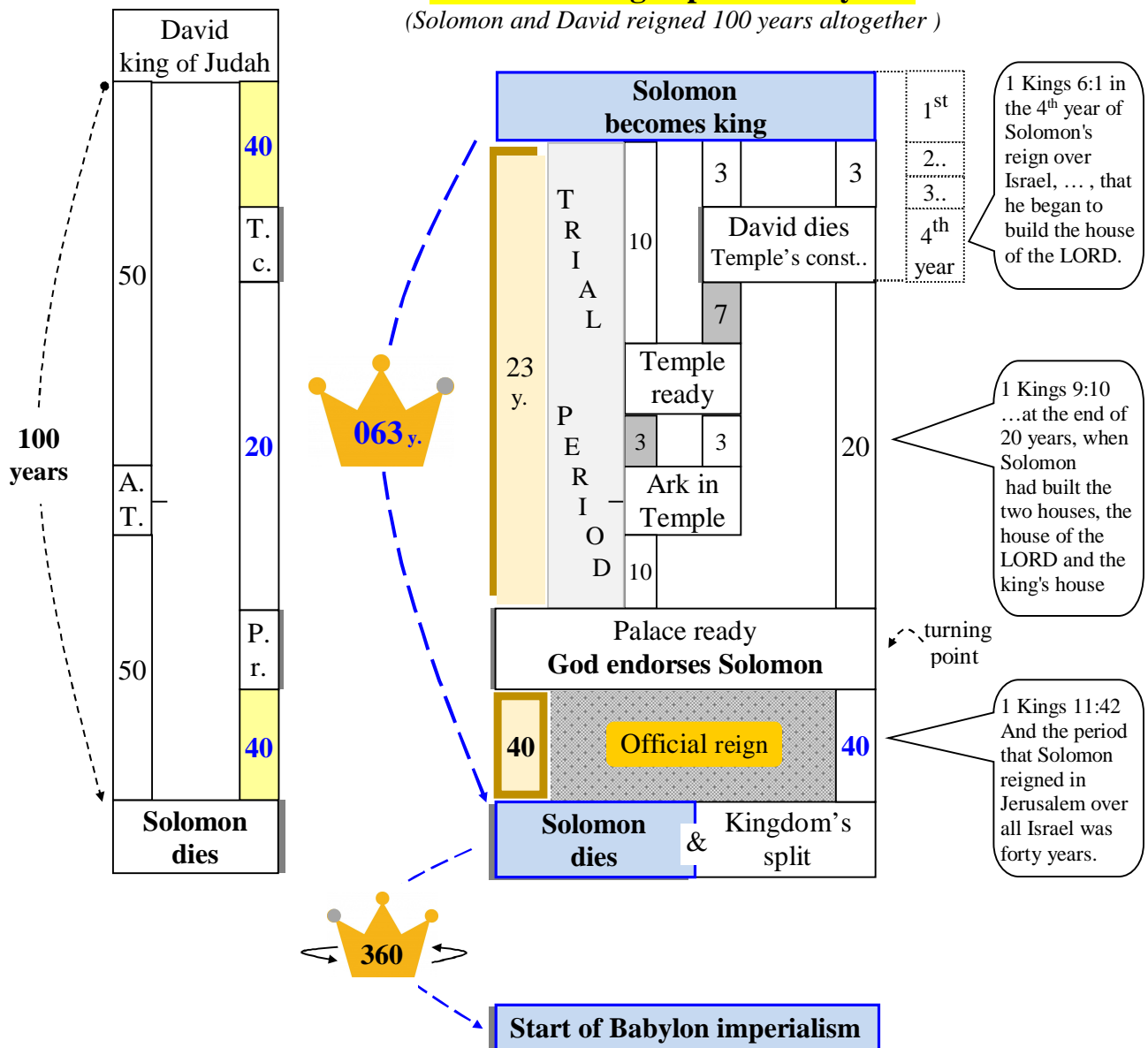

Here is why the ‘end of the 70-year of Babylonian imperialism’ also ends the 430 years of ‘weigh and divide’

Ezekiel ‘Weigh & divide’ action

Symbolic action

real action

Ezek 5:1 then take **balances** to **weigh** and **divide** the hair. (in 2)

The way the ‘Fall of the Babylonian Empire’ was proclaimed

Dan 5:26-28
 MENE: God has numbered your kingdom, And finished it;
 TEKEL: You have been **weighed** in the **balances**, and found wanting;
 PERES: Your kingdom has been **divided**,

echoes word for word the language used in Ezekiel’s ‘weigh & divide’ act.

Ezek 5:1 then take **balances** to **weigh** and **divide** the hair.

Solomon is being evaluated (weighted) and his Kingdom is splitted (divided) in two parts

430 days

430 years

Hair in 3 bundles before being dismissed

Babylonian Empire is dismissed after the 3rd generation

Notice how the ‘REAL Action’ started and ended with a king that was punished because he venerated others gods:

- ⇒ 1 Kings 11:10 and had commanded him concerning this thing, that he [Solomon] should not go after other gods; but he did not keep what the LORD had commanded.
- ⇒ Dan 5:4 They [Belshazzar and his lords] drank wine, and praised the gods of gold and silver, bronze and iron, wood and stone. NKJV

Ezekiel’s 3 bundles of hair meaning

- 1/3 will die from plague or famine
- 1/3 will fall from the sword
- 1/3 will be scattered

The 3 generations of Babylon:

1st Nebuchadnezzar Jer 25:9
 2nd Evil-Merodach 2 King 25:27
 3rd Belshazzar Dan 7:1

Ezekiel's hair growing again

Before directly addressing this new topic we first need to identify what happened at the end of Jerusalem's 70 years of desolation.

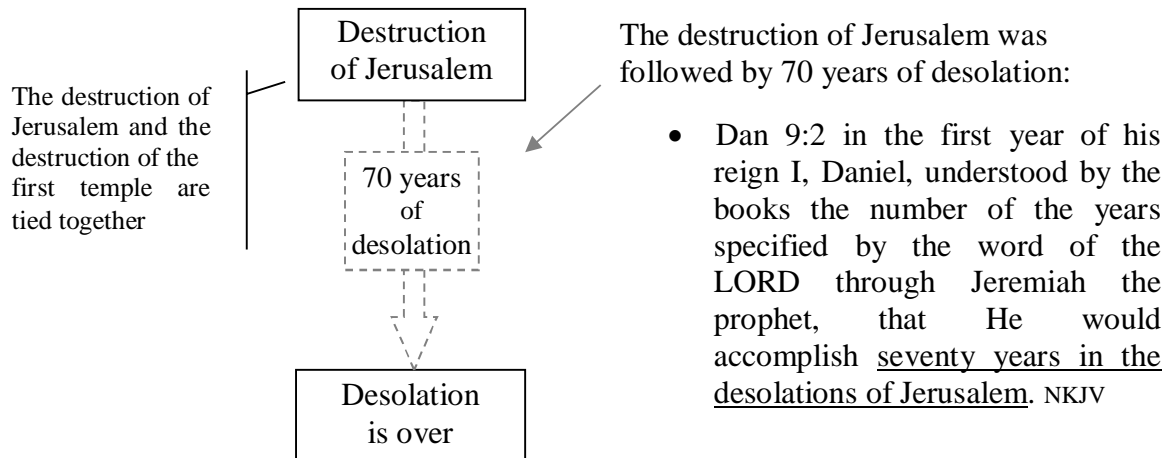

We learn from Chronicles that during the desolation (70 years) the land enjoyed its Sabbaths:

- 2 Chron 36:21 to fulfill the word of the LORD by the mouth of Jeremiah, until the land had enjoyed her Sabbaths. As long as she lay desolate she kept Sabbath, to fulfill seventy years. NKJV

And we also learn that the 70 years of desolation were equivalent to the 70 sabbatical years that had not been observed previously:

- Lev 26:35 As long as it lies desolate it shall rest--**for the time it did not rest on your Sabbaths when you dwelt in it.** NKJV

When the Israelites came into the Promised Land they had to follow a rule that allowed the land to rest for a full year every 7 years. That rule was known as the Sabbath law and it was enforced until the death of Samuel (see on page 67). After Samuel's death, during the next 490 years, the land was never allowed to rest and by the time Jerusalem was destroyed a total of 70 years (one year for every 7 years) had been disregarded and therefore needed to be accounted for. The law may have been ignored by the Israelites, but God did not forget it.

There is an important point to understand here. The 70 years of desolation that came after the destruction of Jerusalem were not years of 'punishment'⁷² against the Israelites, but rather years of 'restitution' to a land that had been denied some of its Sabbath rest.

⁷² In fact the punishment had been handled 10 years before when the Israelites (tribe of Judah) were sent into Exile.

IMPORTANT

The 70 years of exile and the 70 years of desolation are two different periods

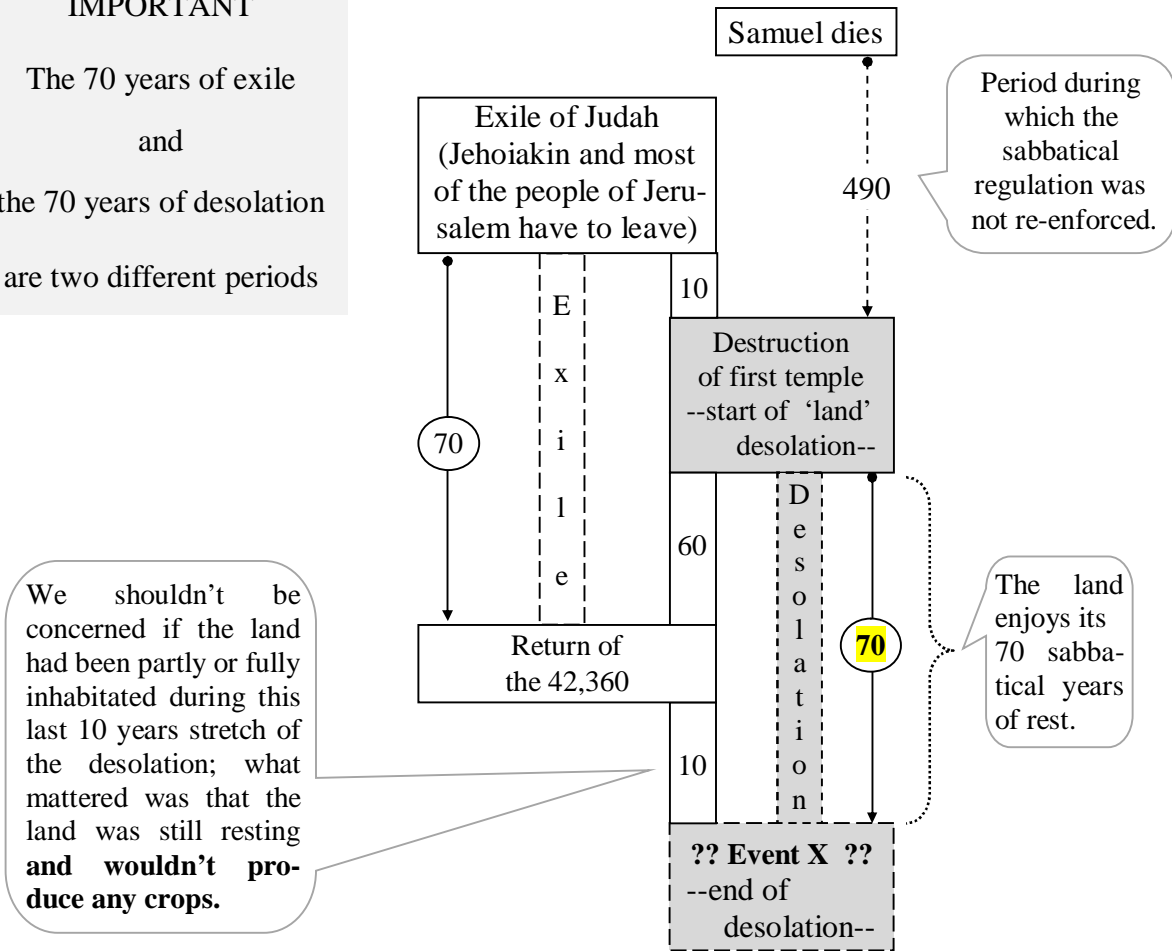

We have two important clues to identify the event 'X' that marked the end of Jerusalem's desolation.

- #1. The return of the exiles⁷³ (42,360) is not linked to the end of desolation.
- #2. Once the 70 years of rest were completed the land would give useful crop yields for the people again.

The event 'X' that we are looking for was clearly identified by Haggai:

The land was going to produce again:

- Hag 2:18-19 Give careful thought: Is there yet any seed left in the barn? Until now, the vine and the fig tree, the pomegranate and the olive tree have not borne fruit.
""From this day on I will bless you.""

⁷³ Ezra 2:1 Now these are the people of the province who came back from the captivity, of those who had been carried away, whom Nebuchadnezzar the king of Babylon had carried away to Babylon, and who returned to Jerusalem and Judah, everyone to his own city. NKJV

The event that would mark the end of the desolation of the land was the resuming of the construction of the second Temple:

- Hag 1:9-11 "Because of **my house, which remains a ruin**, while each of you is busy with his own house. Therefore, because of you **the heavens have withheld their dew and the earth its crops**. I called for a drought on the fields and the mountains, on the grain, the new wine, the oil and whatever the ground produces, on men and cattle, and on the labor of your hands."

Three important things to note from Hagai 1:9-11:

- #1. Haggai clearly identified a time when the Israelites were building their house⁷⁴ while the Temple lay in ruins.
- #2. The land was not producing any useful crops. (In fact the land had until then been enjoying its 70 sabbatical years of rest.)
- #3. Obtaining any crops of the land was directly related to the construction of the second Temple.

For Haggai to suggest the third point could only mean that the 70 years of desolation had just been reached. There was nothing preventing⁷⁵ the construction of the second Temple anymore.

- Hag 1:7-8 Go up into the mountains and bring down timber **and build the house**, so that I may take pleasure in it and be honored

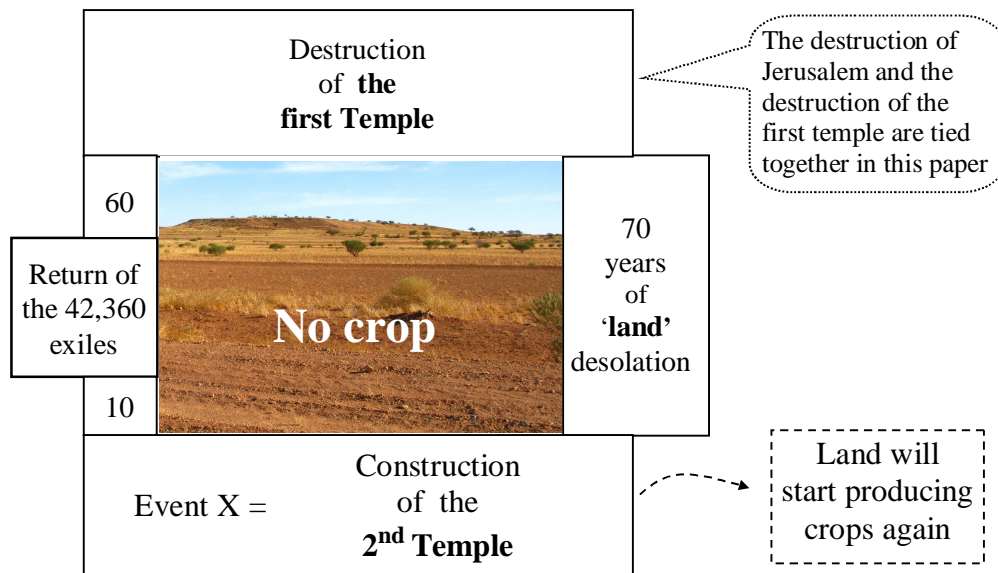

⁷⁴ This is not surprising given that according to our hypothesis the Israelites came back to the land 10 years before.

⁷⁵ A few years back the people (from the 42,360 who came back with Zerubbabel) had laid the foundation of the new Temple but they were not allowed to start any construction at that time.

Three distinct occurrences of a 70-year period
interact with 3 Ezekiel symbolical acts.

70 years
of Babylon
(Nations serve the
King of Babylon)

70 years
of exile
(People deported
from their land)

70 years
of desolation
(Land would enjoy
its sabbatical years)

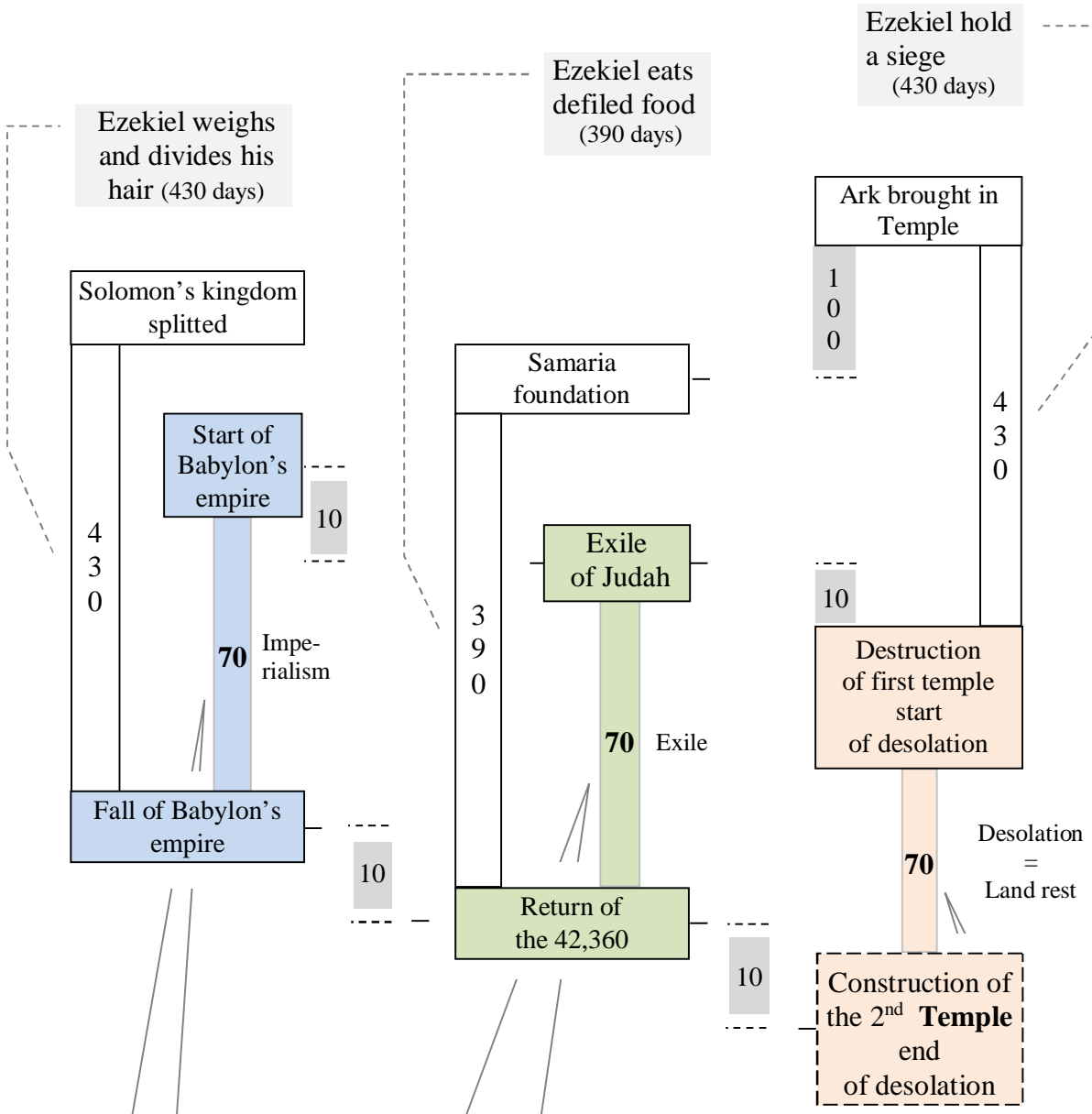

Jer 25:11 and these nations will serve the king of Babylon **seventy years**.

Jer 29:10 After **seventy years** are completed at Babylon, I will visit you and perform My good word toward you, and cause you to return to this place.

2 Chron 36:21 The land enjoyed its sab-bath rests; all the time of its desolation it rested, until the **seventy years** were completed

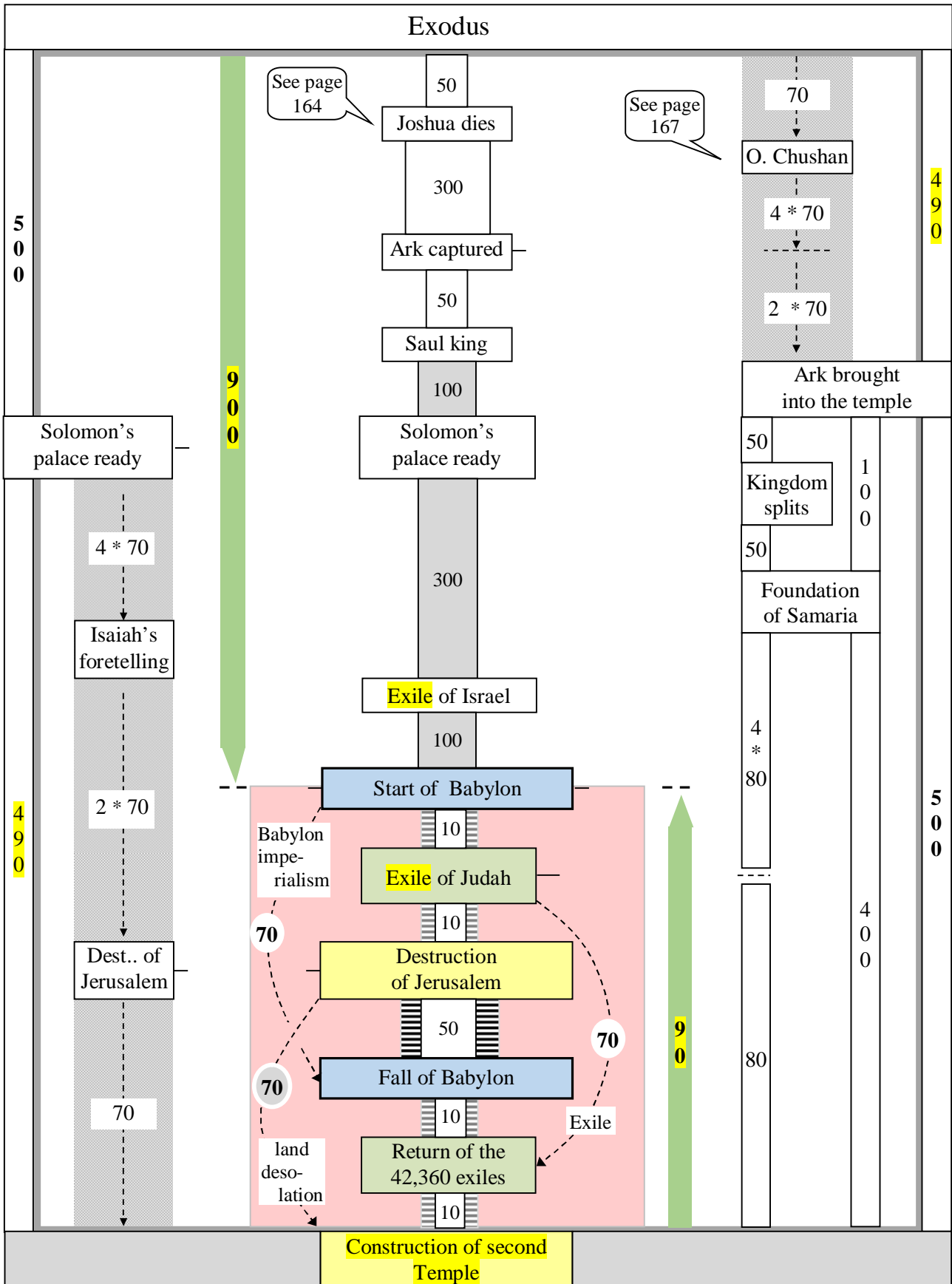

Figure 16. Construction of the second Temple

As mentioned earlier, Ezekiel had to shave his head and beard at the beginning of his siege. What is not emphasized, however, is the fact that his new baldness didn't last long.

In truth, his hair and beard started growing again immediately after the shaving. This may not have been apparent in the first few hours of Ezekiel's reenactment but let's not forget that he lay more than a year (430 days). We have here the first part of a new symbolic act.



This act is associated with no specific house⁷⁶ and it lasted the whole 430 days of Ezekiel's siege. Surprisingly the act was not concluded by Ezekiel shaving his head again⁷⁷. However, it is more than likely that the prophet rushed to make some proper hairdressing as soon as the siege was over and he was set free⁷⁸:

- Ezek 44:20 They [priest] shall neither shave their heads **nor let their hair grow long; but they shall keep their hair well trimmed.** NKJV

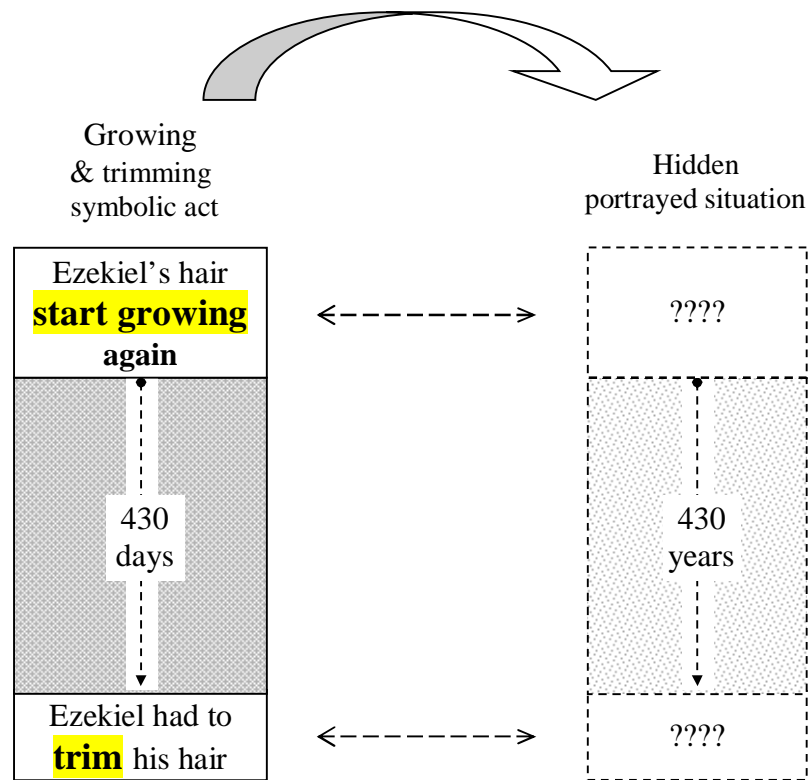

⁷⁶ The side on which Ezekiel was lying didn't alter the meaning of the act. Whatever side Ezekiel was lying on, his hair was growing independently of it.

⁷⁷ There is absolutely no indication that he would have done it any time during the siege. And it is quite unlikely that he would have gone through the humiliation (shaving his head) a second time after the siege.

⁷⁸ Ezekiel was tied during 430 days.

Ezekiel's "Growing and trimming" act

No matter how inadequate the following allegation will sound, I believe the event portrayed by Ezekiel's 'growing hair' is the '**construction of the second Temple**'. Notice that in each case ("hair starts growing" and "construction of the second Temple") a slow process is initiated and will eventually bring back something that had been 'dramatically' removed⁷⁹.

The construction of the second Temple took place at the end of a 70-year period during which the land was left completely desolated. We have already (on page 109) seen that 'the day' the Israelites returned to the construction of the (second) Temple the land started producing food again:

- Hag 1:7-8 Thus says the LORD of hosts: "Consider your ways! Go up to the mountains and bring wood **and build the temple, that I may take pleasure in it** and be glorified," says the LORD. NKJV
- Hag 2:19 Is the seed still in the barn? As yet the vine, the fig tree, the pomegranate, and the olive tree have not yielded fruit. **But from this day forward I will bless you.'**

Could it be more plain than that? The land started **growing food** the same day the construction of the second temple began. We have here a direct connection with Ezekiel's '**growing hair**'.

It was inferred earlier that after his siege was over, Ezekiel needed to trim his hair. Wouldn't it be also expected that after 430 years the second Temple was in dire need of some major repairs? John 2:20 confirms that some major repairs were done to the 2nd Temple⁸⁰

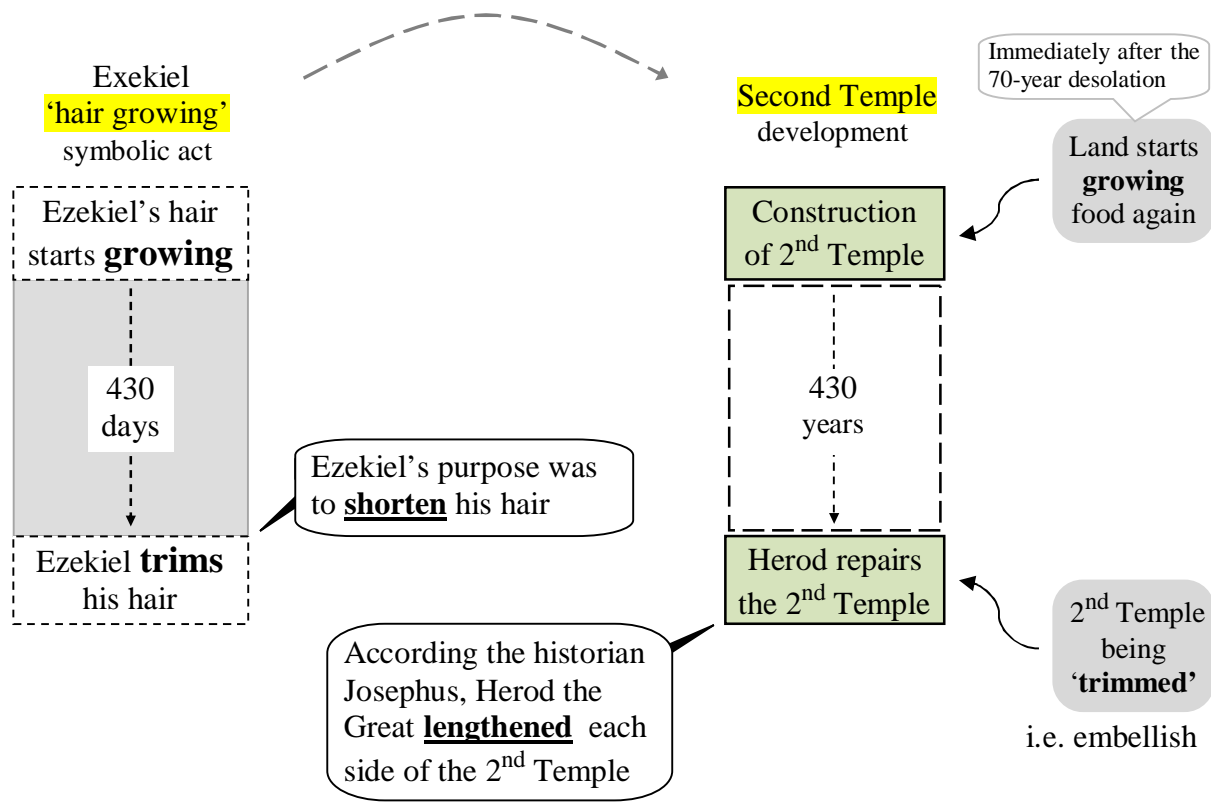

⁷⁹ Ezekiel felt humiliation at losing his hair; the Israelites felt despair at seeing their Temple destroyed.

⁸⁰ John 2:20 The Jews replied, "It has taken **forty-six** years to build this temple, NIV

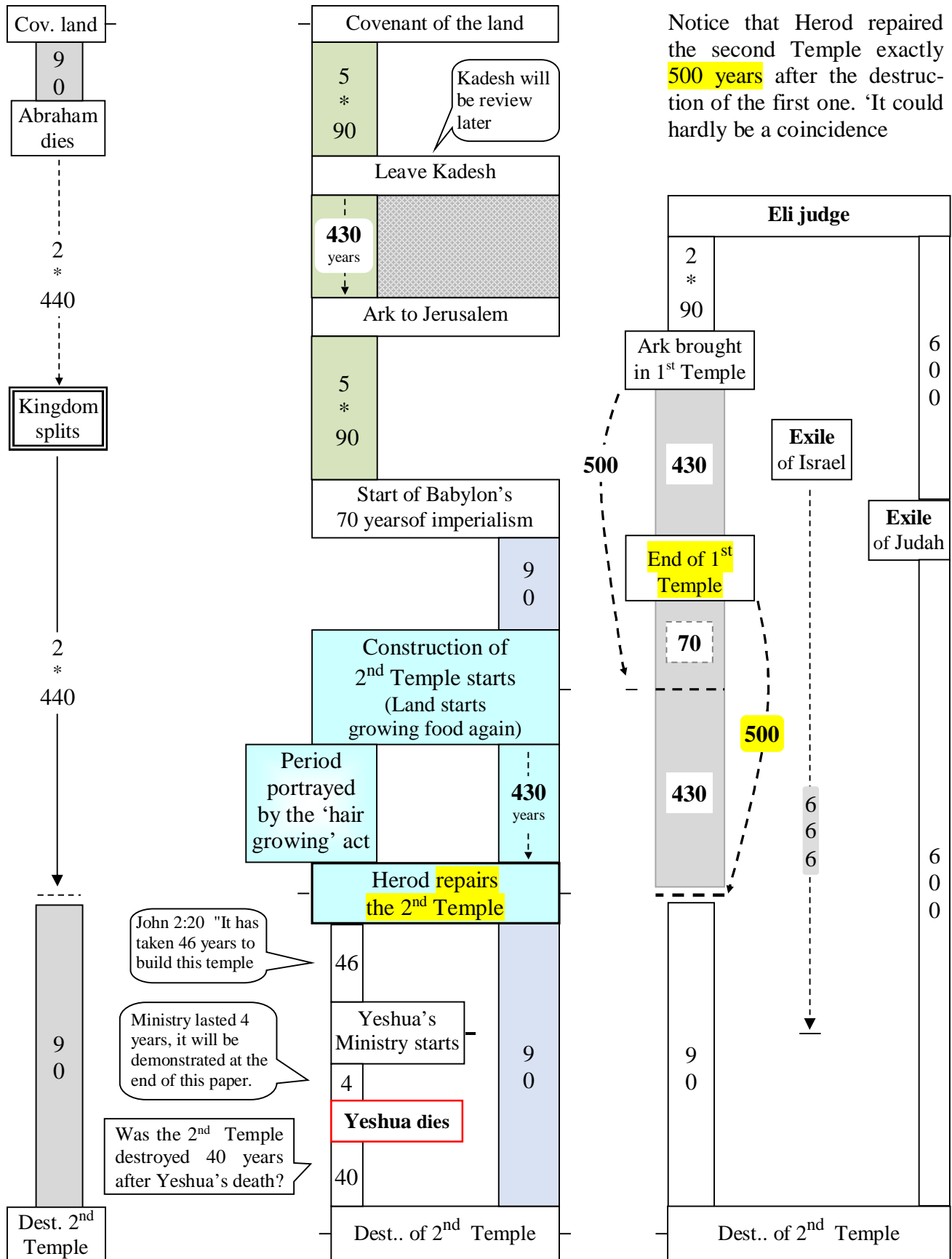
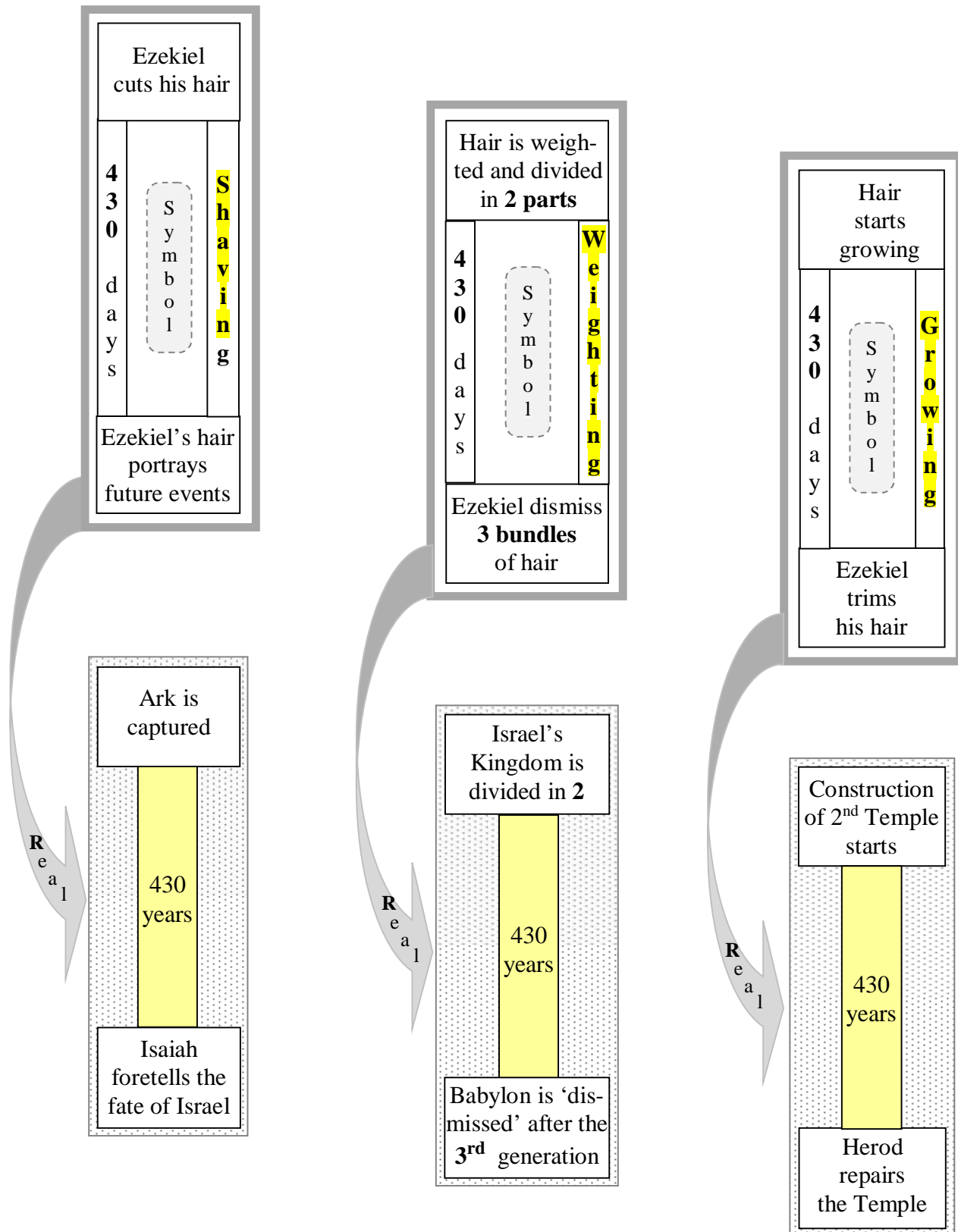

Figure 17. Hair growing act

The 3 symbolical acts associated with Ezekiel's hair



Daniel 70-week & post exile chronology

Dan 9:24-27 24 "Seventy weeks of years are decreed concerning your people and your holy city, to finish the transgression, to put an end to sin, and to atone for iniquity, to bring in everlasting righteousness, to seal both vision and prophet, and to anoint a most holy place. 25 Know therefore and understand that from the **going forth of the word** to restore and build Jerusalem to the coming of an **anointed one, a prince**, (A) there shall be **seven weeks**. Then for (B) **sixty-two weeks** it shall be built again with squares and moat, but in a troubled time. 26 And after the sixty-two weeks, **an anointed one** shall be cut off, and shall have nothing; and the people of **the prince** who is to come shall destroy the city and the sanctuary. Its end shall come with a flood, and to the end there shall be war; desolations are decreed. 27 And he shall make a strong covenant with many for (C) **one week**; and for half of the week he shall cause sacrifice and offering to cease; and upon the wing of abominations shall come one who makes desolate, until the decreed end is poured out on the desolator." RSV

This prophecy covered a period of 490 years (70 weeks of 7 years each) separated into 3 parts (A, B, C). The prophecy is solely concerned by the years of these three specific periods as they are the one that will contribute an active role to bring an end to the transgression in the holy city of Jerusalem. The 3 divisions form a 'time allotment' and don't need to be continuous. (*More on page 130*)

Daniel's 70 weeks (70 weeks are 'set aside')								
W O R D	7 weeks	Event X ?Anointed one A prince?	62 weeks	Anointed One Cut off	Irrelevant years Keep in mind The 70 weeks only involve Daniel's people and the holy city. Dan 9:24 Gap of ? years (to be reviewed)	A prince 'Who is to come'	1 week	C O N C L U S I O N
	Part A		Part B				Part C (3½ + 3½)	
	49 years	434 years	7 years					
	483			7				
483 + 7 = 490 years								

Any gap of years between part B and C should be viewed as irrelevant to the prophecy total count of years. It is therefore wrong to conclude that God has been stopping a so called clock in order to justify the gap. There is a gap because it covers a period of time that has nothing to do with any of the three **active** parts described in the prophecy. (We will see in **p. 131** why **part A & B** are continuous while **part C** stands apart.)

The first⁸¹ two periods (A & B), although described separately, are consecutive:

- Dan 9:25 there shall be seven weeks. Then for sixty-two weeks RSV

Daniel's prophecy starts with a 'word' to restore Jerusalem:

- Dan 9:25 Know therefore and understand that from the going forth **of the word** to restore and build Jerusalem RSV
- Isa 44:28 ... he will say of Jerusalem, "**Let it be rebuilt**," and of the temple, "Let its foundations be laid." '

⁸¹ The last period (C) will be review in Appendix I on page 271.

- Ezra 1:1-2 ... "This is what Cyrus king of Persia says: "The LORD, the God of heaven, has given me all the kingdoms of the earth and he has appointed me to build a temple for him at Jerusalem in Judah.

While most chronologers take the position that the 70-week period started at the time 'the word' was pronounced, I rather think that it started when 'this word' became **the very first concrete action on the ground**. Some translations of Dan. 9:25 says 'that from the **going forth** of the command'. Those translations convey the idea of something explicitly being 'accomplished'.

In this paper there is no doubt that the **Foundation⁸² of the 2nd Temple** is the first step to rebuild Jerusalem and therefore it coincides with the **start of Daniel's 70 weeks**.

- Isa 44:28 he will say of Jerusalem, "Let it be rebuilt," and of the temple, "Let its foundations be laid." ' NIV

rebuilding Jerusalem = laying the Temple's foundation

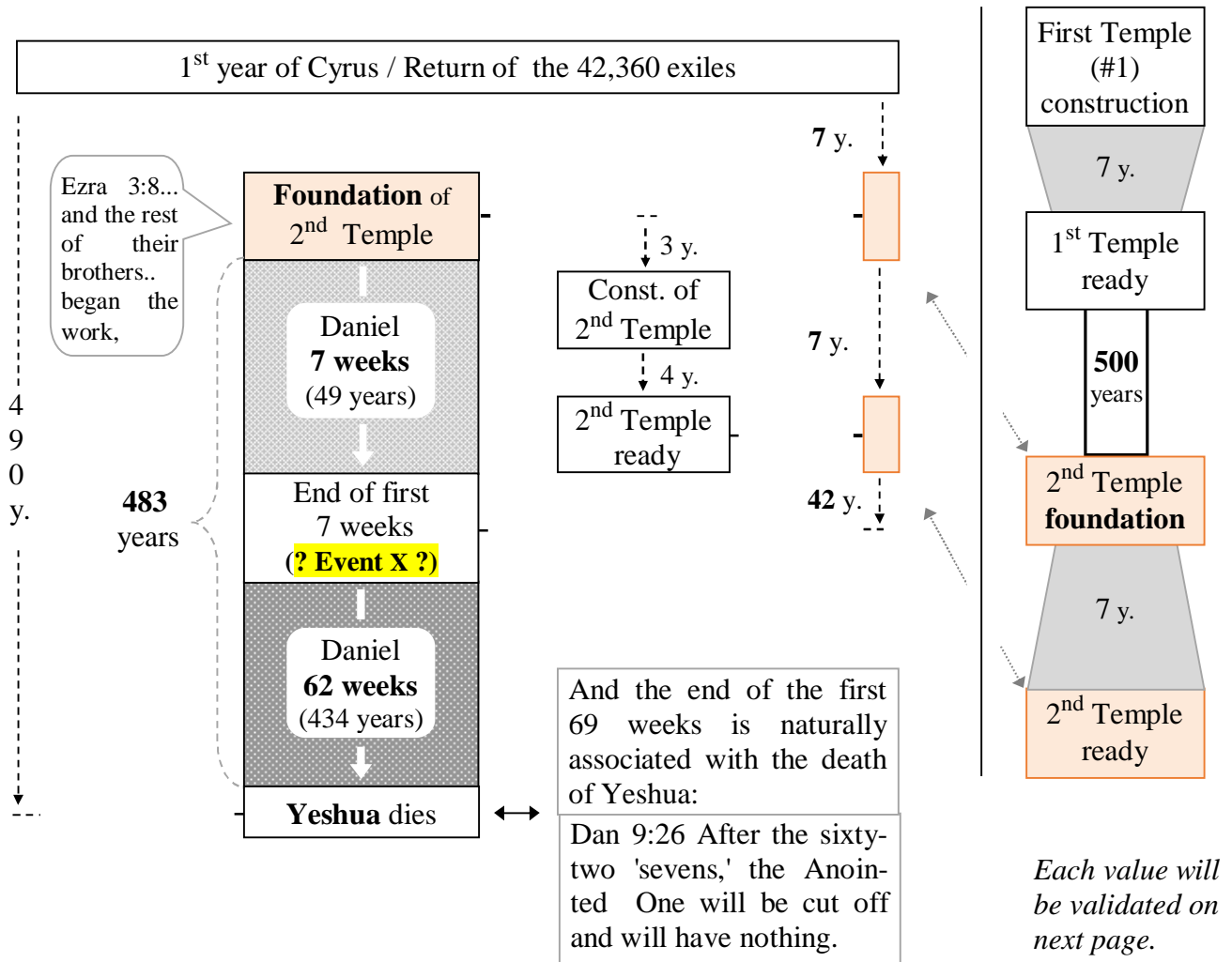
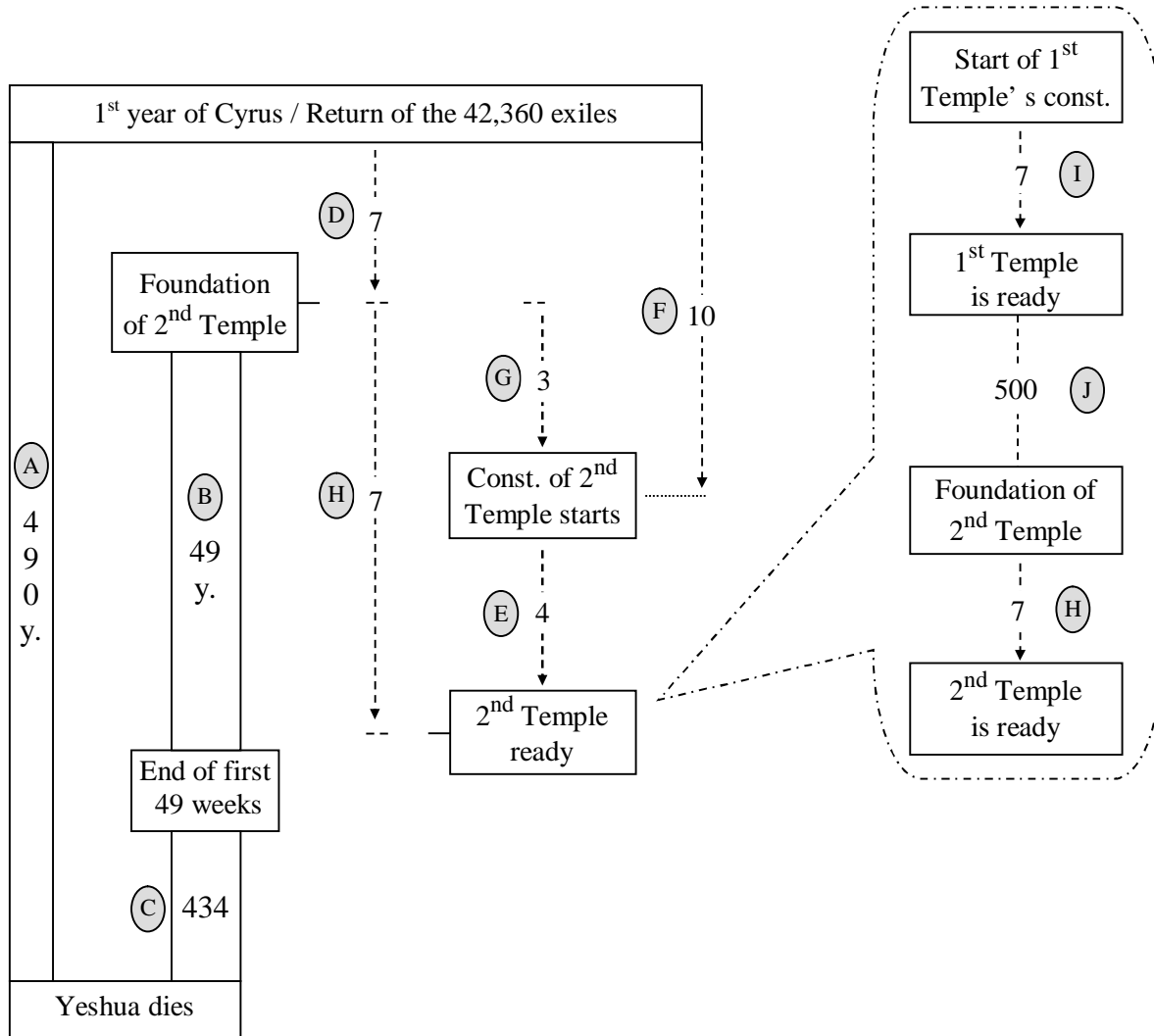

Figure 18. Second Temple period

⁸² This is the very first step toward the Temple's construction and thereby the first step to restoring and rebuilding Jerusalem. It doesn't matter that the Israelites had erected an altar in Jerusalem 6 or 7 months before given that it was made with earth or by piling a few stones one over the others. (see Ezra 3:1)

Some necessary clarifications about the timing of the events seen on the previous page:



- A: See Hair growing act on page 114
- B: First 7 weeks of Daniel's 70 weeks
- C: Next 62 weeks of Daniel's 70 weeks

- D: $A490 - C434 - B49 = 7$
- E: See Ezra 2:4 and Ezra 6:15
- F: See Figure 16. On page 111

- G: $F10 - D7 = 3$
- H: $G3 + E4 = 7$
- I : See page 55

- J: From Figure 8 on page 66
 'Temple ready' to 'Temple's destr..' = 433
 From Figure 11. On page 72
 'Temple's destruction .' to 'Return' = 60
 From $A490 - C434 - B49$
 'Return' to 'Foundation' = 7
 → $433 + 60 + 7 = 500$ years

From the previous page we know that the Foundation of the 2nd Temple occurred 3 years before the start of its construction

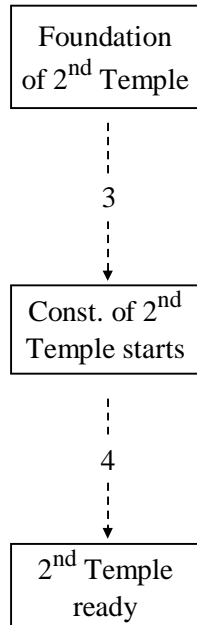

and Ezra tells us that Darius became king two years before the construction of the second Temple

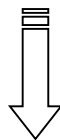
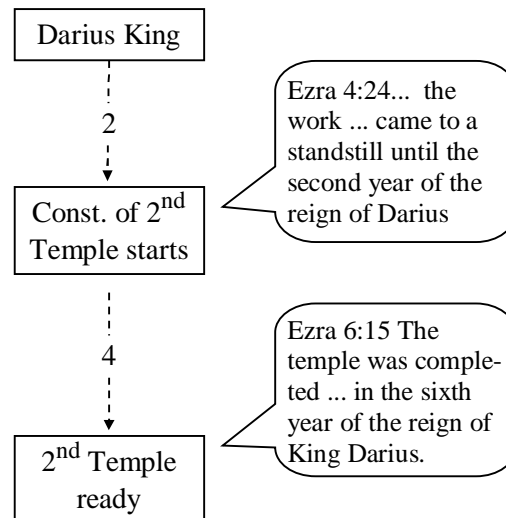

We put the information together

Darius Sequence	
Foundation of 2 nd Temple	----- 3 -----> ----- 4 ----->
*	1 2 3 4 5 6 7
Darius king	-- 2 --> Start Const. 2 nd Temple ----- 4 -----> 2 nd Temple is ready
*	1 2 3 4 5 6

Now we will have a closer look at the period of Nehemiah:

Part 1 Connecting from an event Y

Event Y		
*	1-19	20 th
	Nehemiah receives some news from Jerusalem	

Neh 1:1-2 The words of Nehemiah the son of Hachaliah. It came to pass in the month of Chislev, in 20th year, as I was in Shushan the citadel, that Hanani one of my brethren came with men from Judah; NKJV

Note: This happened in the month of **Chislev** and it was in the **20th year** of an event 'Y' that is not mentioned by name.

Note: The **unknown** event (Y) referred to by Nehemiah must have had great importance given that Nehemiah is still remembering it 20 years later.

Part 2 Connecting from king Artaxerxes

King Artaxerxes		Neh. meets K. Ar..		
*	1-19	20 th	21-31	32 th
		Wall started		Wall ended

Nehemiah asks the King to be sent to Jerusalem

12 years to repair?

The wall was large (people walk on it), long (many gates), high (otherwise it wouldn't have offered any protection). It was partly damaged or destroyed, should we be surprised that it took 12 years to repair?

Neh 2:1 And it came to pass in the month of **Nisan**, in the 20th year of King Artaxerxes, NKJV

Note: Here an event is connected with the **20th year of king Artaxerxes**, in the month of Nisan. Three months have gone since Neh 1:1 (Chislev – Tebeth – Adar – Nisan). Given that Nisan is the start of the new year (my working hypothesis in this book) we can rule out that this '20th year' (Neh 2:1) is the same '20th year' referred earlier in Neh 1:1.

Neh 5:14 from the time that I was appointed to be their governor in the land of Judah, from the 20th year until the 32th year of King Artaxerxes, twelve years, NKJV

Note 1: Nehemiah built Jerusalem's wall from the 20th to the 32th year of Artaxerxes.

Note 2: Neh 6:15 seems to suggest that the work on the

→ whole wall took only 52 days, it is not the case. In Neh 6:1 we are told that the wall is completed **but without the gates**. However, in Neh 6:3, the work is not stopped yet. (Why not? Because the people started to work on the gates). So, when Neh 6:3 claims that the work was completed in 52 days we need to understand that it took an additional 52 days to repair all the gates.

Merging Part 1 & 2

Event Y					
*	1	2-19	20 th		
			Nehemiah receives news 20 years after event Y		
				3 months later	
King Artaxerxes					
*	1-18	19	20 th	21-31	32 th
			Wall started		Wall ended

Neh.. meets Art.. in the king's 20th year, then goes to Jerusalem.

N
E
H
E
M
I
A
H

's sequence



Neh 7:4 the city was large..
It took 12 years to repair the whole wall and its towers

When Nehemiah came to Jerusalem to “repair” the wall, the return of the 42,360 exiles with Jerubabel had already taken place. We deduce this from the presence of many people (priest, nobles, officials) in the city when Nehemiah inspected the wall three days after his arrival:



- Neh 2:12-13 I set out during the night with a few men. ... There were no mounts with me except the one I was riding on. ... By night I went out ... examining the walls of Jerusalem, which had been broken down, NIV
- Neh 2:16 And the officials did not know where I had gone or what I had done; I had not yet told the Jews, the priests, the nobles, the officials, or the others who did the work. NKJV

Also, when Nehemiah came to Jerusalem the 2nd Temple had already been rebuilt:

- Neh 6:10 ... and he said, "Let us meet together in the house of God, within the temple, and let us close the doors of the temple, NKJV

Nehemiah couldn't have met anybody at the Temple if It hadn't been already rebuilt. Also notice⁸³ that in Neh 2:3, which is just before Nehemiah came to Jerusalem, his sadness is associated with the fact that the city lay in ruins and the gates had not yet been repaired. That Nehemiah didn't grieve for the Temple here, can only be explained by the fact that the 2nd Temple had already been reconstructed.

Now, knowing how concerned Nehemiah was when he learned, from his brother, about the awfully neglected condition⁸⁴ of the city, also knowing that Nehemiah took upon himself to repair the wall around Jerusalem and once it was done, he took some measures to repopulate the city⁸⁵, knowing all that, wouldn't it make a lot of sense if the mysterious 'Event Y' (Neh 1:1) still remembered by Nehemiah 20 years later, happened to be the **'Foundation of the 2nd Temple'**?

The first 7 weeks of Daniel's 70-week prophecy are mostly concerned with the restoration of the city and we have already made the 'foundation of the Temple' the very beginning of those 7 weeks. Should we be surprised if Nehemiah the 'builder', who loved Jerusalem to the point of crying for it, had always **kept track of the years** since the 'foundation of the 2nd Temple' (rebirth of the city) and used them as the origin⁸⁶ of his personal timeline?

As we will see, this conclusion allows us to untangle the sequence of events that occurred during the first 7 weeks of Daniel's 70 weeks of prophecy.

⁸³ Neh 2:3 "May the king live forever! Why should my face not be sad, when the city, the place of my fathers' tombs, lies waste, and its gates are burned with fire? NKJV

⁸⁴ Neh 1:2-4 and I asked them concerning the Jews who had escaped, who had survived the captivity, and concerning Jerusalem. ... The wall of Jerusalem is also broken down, and its gates are burned with fire." So it was, when I heard these words, that I sat down and wept, and mourned NKJV

⁸⁵ Neh 11:1 ... the rest of the people cast lots to bring one out of ten to dwell in Jerusalem, the holy city, NKJV

⁸⁶ See Neh 1 :1-2

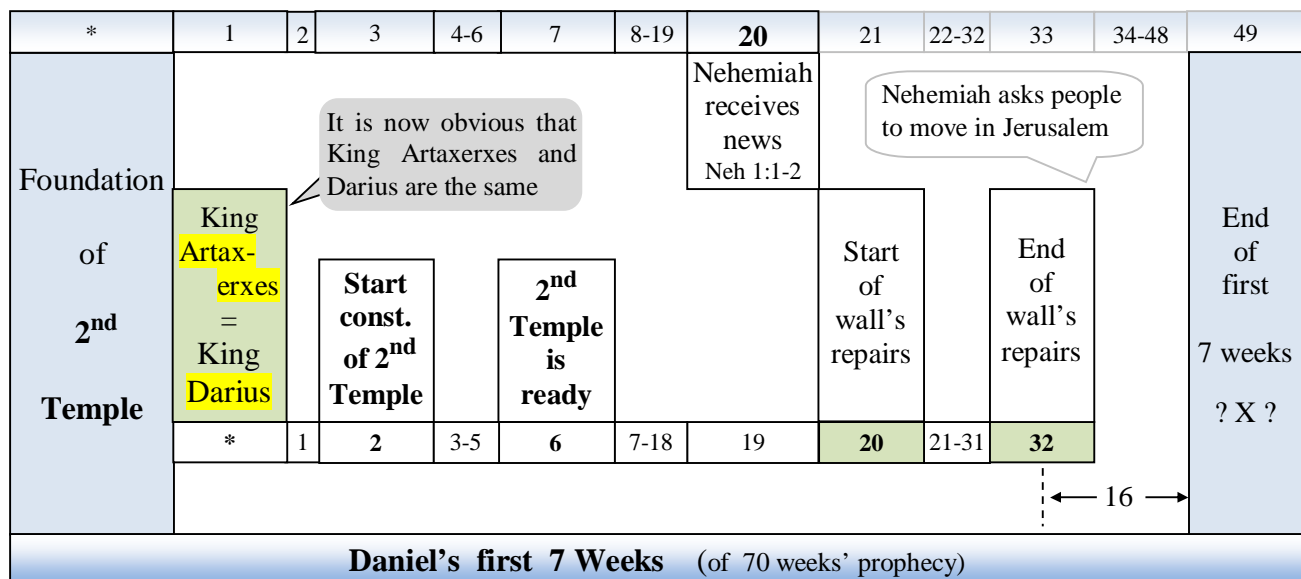
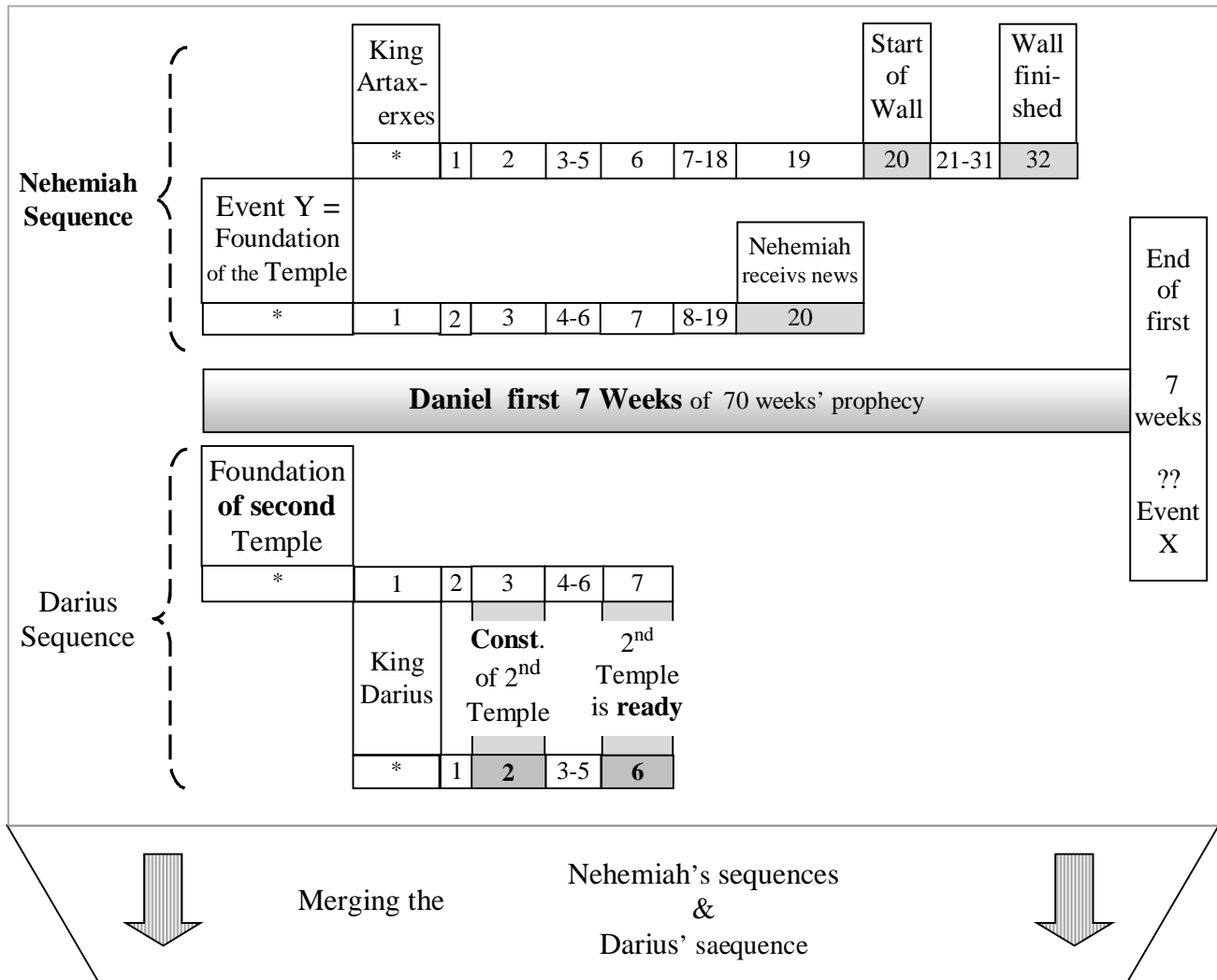
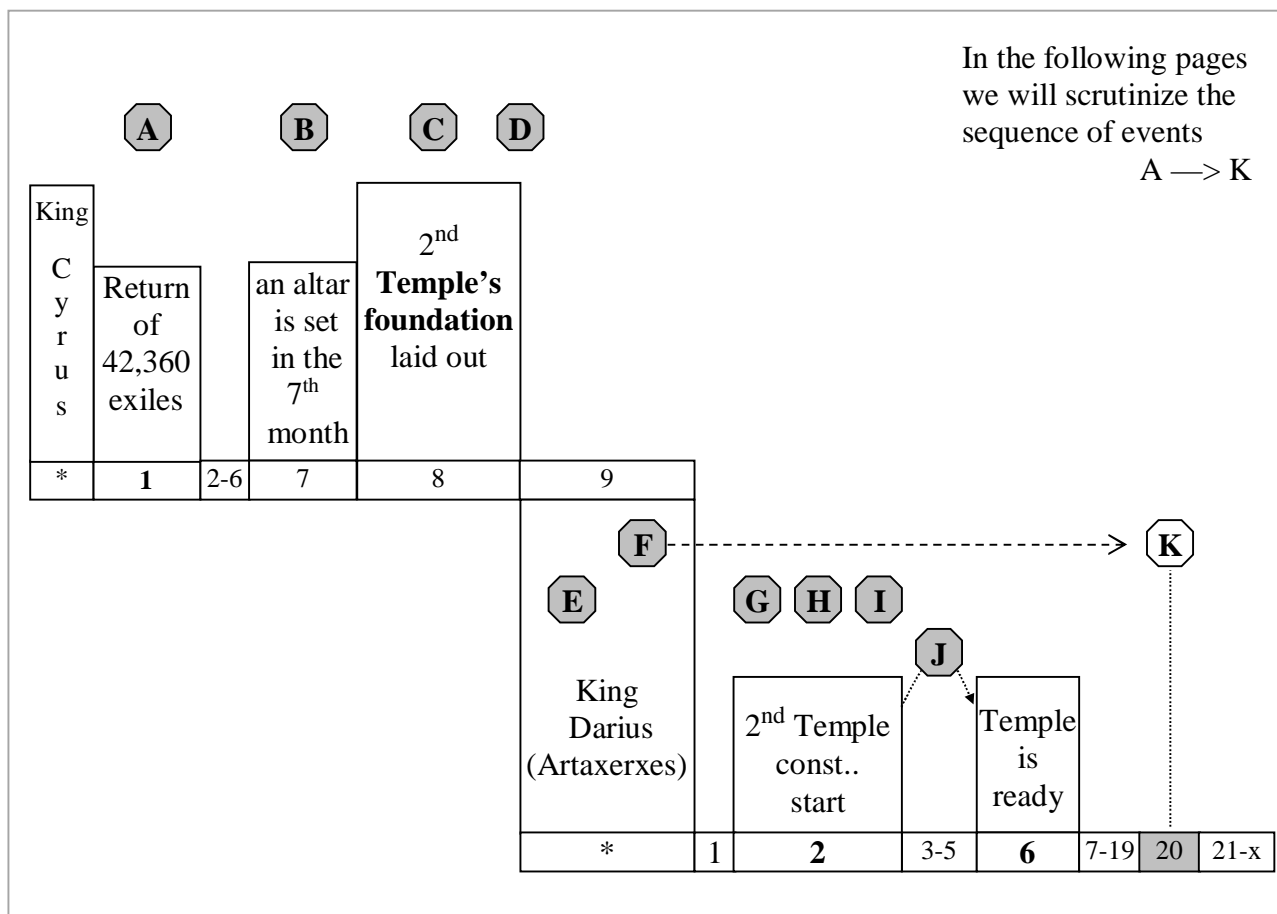

Figure 19 Post Foundation

What does Ezra have to say about the second Temple period?

Going through the book of Ezra for the first time could be a confusing experience. But, as we will see, once we have the proper sequence of events, Ezra becomes crystal clear.



A Cyrus, in the first year of his reign, allowed the exiles to return to Jerusalem and build their temple:

- Ezra 1:3 Who is among you of all His people? May his God be with him, and let him go up to Jerusalem which is in Judah, and build the house of the LORD God of Israel

B The people came to Jerusalem in the 7th month to erect an altar:

- Ezra 3:1 And when the seventh month had come, and the children of Israel were in the cities, the people gathered together as one man to Jerusalem. NKJV

We know that the Israelites came to the site of the 1st Temple (then in ruins) to set an Altar the year before they laid the foundation of the second Temple:

- Ezra 3:8 Now in the second month of the second year of their coming to the house of God at Jerusalem, NKJV

And we have previously established that the exiles laid the foundation of the 2nd Temple 7 years after their ‘return from exile’ (see Figure 18 on page 117).

Therefore, we can rightly deduce that the 7th month, alluded to in Ezra 3:1 happened 6 years after the ‘return of the exiles’ (that is to say in the 7th year of Cyrus). Notice that Ezra 3:1 does specify that the people came from their cities⁸⁷.

C According to Figure 18 on page 117 the foundation of the second Temple was laid 7 years after the ‘return of the exiles’.

D Zerubbabel’s plan was to construct the 2nd Temple right after the foundation had been laid, but then the enemies⁸⁸ of Judah came and discouraged the people, a situation that started during the time of Cyrus and prevailed until Darius (King of Persia):

- Ezra 4:4-5 Then the people of the land tried to discourage the people of Judah. They troubled them in building, and hired counselors against them to frustrate their purpose all the days of Cyrus king of Persia, even until the reign of Darius king of Persia. NKJV

Important: The enemies of Judah did their obstructing (and prevented the construction of the Temple) without involving King Cyrus. They (the enemies) knew very well that Cyrus was favorable⁸⁹ to the construction of the Temple and it would have been foolish to address him with any request to prohibit any work by the Israelites. This explains why Cyrus never received any letters of complaint from the enemies.

E It is only when Artaxerxes became king that the enemies wrote to the king. In their letter they complained to the new king that the people were rebuilding the city⁹⁰ (meaning that some houses were being repaired by a few Israelites while they were waiting to work on the Temple):

- Ezra 4:6-7 At the beginning of the reign of Xerxes, they lodged an accusation against the people of Judah and Jerusalem. And in the days of Artaxerxes king of Persia, Bishlam, Mithredath, Tabeel and the rest of his associates wrote a letter to Artaxerxes.

Note: The ‘Xerxes’ of Ezra 4:6 is another name for Artaxerxes and should not be confused with the ‘Xerxes’ of the book of Esther.

⁸⁷ Given that it was 6 years after the return from exile, the people had had enough time to settle down in their ancestral cities.

⁸⁸ The enemies could be those ‘few’ who were already occupying the land when the exiles came back home.

⁸⁹ Ezra 1:2 Thus says Cyrus king of Persia: All the kingdoms of the earth the LORD God of heaven has given me. And He has commanded me to build Him a house at Jerusalem which is in Judah. NKJV

⁹⁰ Because of the bad counselors, the re-construction of the 2nd Temple was still being delayed and some of the returned exiles had started working on their homes instead.

So at the beginning of his reign Artaxerxes received a letter⁹¹ informing him that the Jews were rebuilding the rebellious city of Jerusalem:

- Ezra 4:12 The king should know that the Jews who came up to us from you have gone to Jerusalem and are rebuilding that rebellious and wicked city. They are restoring the walls and repairing the foundations [of the city].

Upon receiving this letter King Artaxerxes had a search made in the royal archives and it was found that the city had indeed a long history of revolt:

- Ezra 4:19-20 and a search was made, and it was found that this city has a long history of revolt against kings and has been a place of rebellion and sedition.

F King Artaxerxes sent back a letter forbidding any rebuilding in Jerusalem (no houses, no wall):

- Ezra 4:21 Now issue an order to these men to stop work, so that this city will not be rebuilt until I so order.

Notice that Artaxerxes at this point was not aware that the previous king (Cyrus) had decreed the construction of the Temple. The only purpose for the search in the archives was to verify the allegation that the city had been rebellious in the past. Upon confirmation of it, Artaxerxes (Darius of Persia) ordered the returned exiles not to build anything in Jerusalem.

G In the second year of Darius (that is to say ‘Artaxerxes’) Haggai confronted the people of Judah and told them not to delay the construction of the Temple any more. As a result the people stopped building their houses⁹², came back to Jerusalem and at long last started building the 2nd Temple:

- Hag 1:14-15 So the LORD stirred up the spirit of Zerubbabel son of Shealtiel, governor of Judah, and the spirit of Joshua son of Jehozadak, the high priest, and the spirit of the whole remnant of the people. They came and began to work on the house of the LORD Almighty, their God, on the twenty-fourth day of the sixth month in the second year of King Darius.

⁹¹ Ezra 4:8 Rehum the commanding officer and Shimshai the secretary wrote a letter against Jerusalem to Artaxerxes the king

⁹² We have two strong indications that the people at that time were not building their houses inside the city of Jerusalem:

- 1) King Artaxerxes had forbidden any construction in the city. See **F**
- 2) More than 30 years later, after the completion of the wall we will see that there were still no houses in the city (Jerusalem) and Nehemiah had to take some measures to change this situation:
 - Neh 7:4 Now the city was large and spacious, but there were few people in it, and the houses had not yet been rebuilt.
 - Neh 11:1 Now the leaders of the people settled in Jerusalem, and the rest of the people cast lots to bring one out of every ten to live in Jerusalem, the holy city, while the remaining nine were to stay in their own towns.

H The enemies then sent a new letter to Darius (Artaxerxes) telling him the people had started the construction of their Temple:

- Ezra 5:7-8 The report they sent him read as follows: To King Darius: Cordial greetings. The king should know that we went to the district of Judah, to the temple of the great God. The people are building it

In this letter it was also mentioned that the people who were rebuilding the Temple, pretended that they had been authorized to do so by the late King Cyrus:

- Ezra 5:17 Now if it pleases the king, let a search be made in the royal archives of Babylon to see if King Cyrus did in fact issue a decree to rebuild this house of God in Jerusalem

I King Darius had a new search done in the archives, but this time it was to verify whether King Cyrus (the previous king) had ordered the construction of the Temple:

- Ezra 6:1-3 King Darius then issued an order, and they searched in the archives ...and this was written on it: In the first year of King Cyrus, the king issued a decree concerning the temple of God in Jerusalem:

Upon receiving the confirmation that Cyrus had previously authorized the work, Darius (Artaxerxes) issued a final edict that would quench all oppositions to the construction of the Temple once and for all.

- Ezra 6:7 Do not interfere with the work on this temple of God. Let the governor of the Jews and the Jewish elders rebuild this house of God on its site.

J The construction of the Temple lasted 4 years (from the second to the 6th year of Darius):

- Ezra 4:24 Thus the work of the house of God which is at Jerusalem ceased, and it was discontinued until the second year of the reign of Darius king of Persia. NKJV
- Ezra 6:15 Now the temple was finished on the third day of the month of Adar, which was in the sixth year of the reign of King Darius. NKJV

K Important: No matter that he allowed the Temple to be rebuilt, King Darius (aka Artaxerxes) didn't lift the interdiction (ref F) to construct any houses (or walls) in Jerusalem. However, it all changed in the king's 20th year when he changed his mind and granted Nehemiah the authorization to rebuild the wall. Subsequently Nehemiah asked the people to come and live in Jerusalem and build houses.

- Neh 7:4 Now the city was large and spacious, but the people in it were few, and the houses were not rebuilt.

Identifying the end of the first 7 weeks of Daniel's prophecy

The first 7 weeks (49 years) of Daniel were dedicated to the rebuilding of Jerusalem:

- Dan 9:25 It will be rebuilt with streets and a trench

Nevertheless, when Nehemiah finished the full restoration of the wall, 33 years after the beginning of the 7 weeks, not much had been done to reconstruct the city.

- Neh 7:4 Now the city was large and spacious, but there were few people in it, and the houses had not yet been rebuilt.

However, Nehemiah did something that would dramatically improve Jerusalem's situation by making sure that the city would become adequately populated:

- Neh 7:1 Then it was, when the wall was built and I had hung the doors,
- Neh 7:5 So my God put it into my heart to assemble the nobles, the officials and the common people for registration by families.
- Neh 11:1-2 Now the leaders of the people settled in Jerusalem, **and the rest of the people cast lots to bring one out of every ten to live in Jerusalem**, the holy city, while the remaining nine were to stay in their own towns. The people commended all the men who volunteered to live in Jerusalem.

In the previous figure (on page 122), the end of the first 7 weeks occurred 16 years after the completion of the wall. No doubt the new population of Jerusalem, introduced by Nehemiah when he finished the wall, had been quite busy during those 16 years. The rebuilding of the city could not have been completed without the repairing of the streets, construction of the houses and cleanup of the city⁹³.

How do we end the first 7 weeks?

Given that Daniel's first 69 weeks are separated into two periods (7 and 62 weeks) and the second period does end with the death of the anointed one, we are justified to seek a special event that would also mark the end of the first period of 7 weeks. Are we supposed to assume that sometime during the 49th year (year ending the first 7 weeks of years) Jerusalem's last house was built and therefore this important division of Daniel's prophecy was over? Isn't there a stronger event that would justify in a more obvious way, why those first 7 weeks (of years) needed to be separated from the next 62 weeks (of years)?

- Dan 9:25 there will be **seven 'sevens,'** and sixty-two 'sevens.'

There is an important aspect of the '7 weeks' that has been neglected so far:

- Dan 9:25 It will be rebuilt with streets and a trench, **but in times of trouble.**

⁹³ Let's keep in mind that when Nehemiah finished the wall, Jerusalem had been almost continually deserted for 100 years.

→ Nobody ever paid attention to this very important clues: DAN 9:25 plainly says that the period covering the reconstruction of Jerusalem would be a period of **fear, violence and intimidation** against the Jews. ←

Notice what was going on during the construction of the second Temple:

- Ezra 4:4 Then the peoples around them set out to discourage the people of Judah and make them afraid to go on building.
- Ezra 4:6 At the beginning of the reign of Xerxes, they lodged an accusation against the people of Judah and Jerusalem
- Ezra 4:23 they went immediately to the Jews in Jerusalem and compelled them by force to stop.

And notice how things hadn't changed by the time they rebuilt the wall:

- Neh 4:1 When Sanballat heard that we were rebuilding the wall, he became angry and was greatly incensed. He ridiculed the Jews,
- Neh 4:8 They all plotted together to come and fight against Jerusalem and stir up trouble against it.
- Neh 4:12 "Wherever you turn, they will attack us."
- Neh 4:16 From that day on, half of my men did the work, while the other half were equipped with spears, shields, bows and armor.
- Neh 6:2 But they were scheming to harm me;
- Neh 6:14 remember also the prophetess Noadiah and the rest of the prophets who have been trying to intimidate me.

Since the whole of the first 7 weeks was going to be marked by anguish, we can deduce that something of major importance must have happened to end these 7 weeks and make the violence stop. If this had not been the case, the word '**trouble**' wouldn't have been singled out as the **major** characteristic of those first 7 weeks.

There is an event in the chronology of the post-exile that fits like a glove. This event is described in the book of Esther.

In the 12th year of King Xerxes (King Ahasuerus) the Jews from all the provinces of the Persian Empire (that would have included Jerusalem and the region around) were going to be annihilated according a king's decree obtained by the evil Haman (see Est 4:13-14).

Est 3:8-9 it is not in the king's best interest to tolerate them. If it pleases the king, let a decree be issued **to destroy them**,

Est 9:24 For Haman son of Hammedatha, the Agagite, the enemy of all the Jews, had plotted against the Jews to destroy them and had cast the pur (that is, the lot) **for their ruin and destruction.** NIV

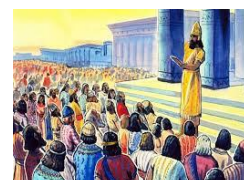

For many months afterwards it had been known that on the 13th day of the 12th month (month of Adar) people would be encouraged to kill all the Jews they could:

- Est 3:13 Dispatches were sent by couriers to all the king's provinces with the order to destroy, kill and annihilate all the Jews-young and old, women and little children-on a single day, the thirteenth day of the twelfth month, the month of Adar, and to plunder their goods.

Notice that Haman didn't contend with the immediate execution of the genocide, he rather made it known, months ahead, what was going to happen in order to better terrorize his future victims. This psychological warfare fits perfectly well with the spirit of Daniel first 7 weeks. Fortunately, due to a miraculous reversal of the original plan, the massacre didn't happen. King Xerxes authorized all the Jews of his kingdom to get organized and to destroy all their enemies. That day (which has been known ever since as the **Day of Purim** and has been celebrated by the Jews from all around the world), the 13th of Adar, and the next one, more than 75,000 enemies of the Jews were killed:

- Est 9:1 On the thirteenth day of the twelfth month, the month of Adar, the edict commanded by the king was to be carried out. On this day the enemies of the Jews had hoped to overpower them, but now the tables were turned and the Jews got the upper hand over those who hated them
- Est 9:16 Meanwhile, the remainder of the Jews who were in the king's provinces also assembled to protect themselves and get relief from their enemies. They killed seventy-five thousand of them but did not lay their hands on the plunder



Hanging of Haman's sons
Est 9:7-10

Could there be a better event to mark the end of the first 7 weeks of Daniel? – seven weeks (49 years) that had been characterized by troubles (against the Jews) right from the start?

Let's see how we can integrate this new information with our timeline and learn even more.

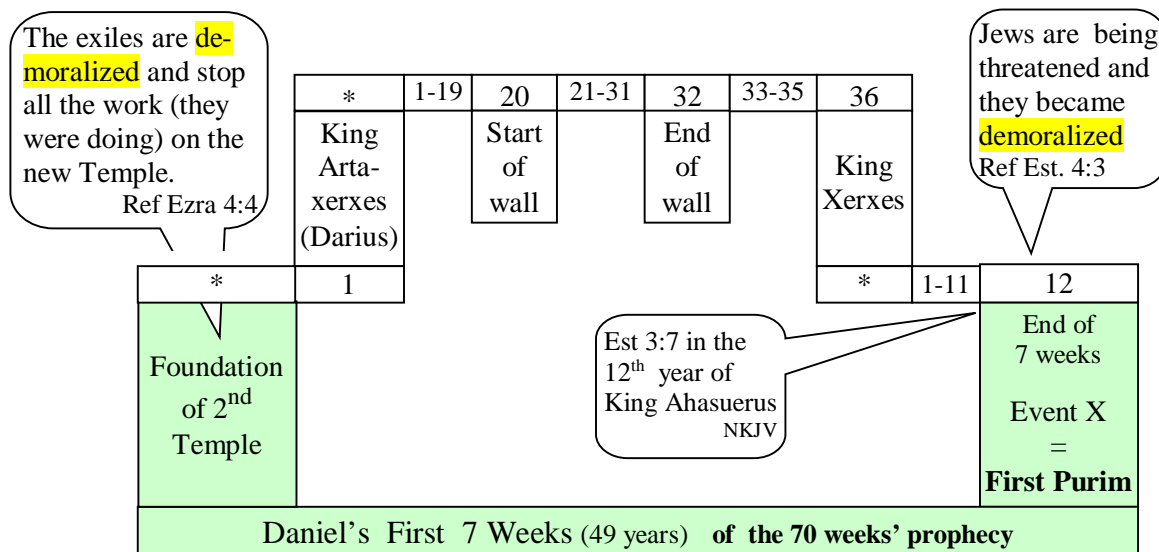

Let's revisit Daniel 9:25-27.

No linguist will contest this: to really understand the structure of Daniel 9 one have to be fluent in Hebrew. Unfortunately I don't have any rudiment of this language. However I do have an invaluable tool that compensate this shortcoming: a solid post exile chronology.

A few facts to keep in mind

Dan 9:25 Know therefore and understand that from the going forth of the word to **restore and build Jerusalem** to the coming of an anointed one, a prince, there shall be **seven weeks**. Then **for sixty-two weeks** it shall be built again with squares and moat, but in a troubled time. ²⁶And after the sixty-two weeks, an anointed one shall be cut off, and shall have nothing; (RSV translation)

1. This establishes that the 7 weeks and the 62 weeks follow each other without any intervening gap.
2. the coming of an anointed one, a prince is associated with the end of the first 7 weeks.
3. Contrary to what is said in the RSV translation we have seen earlier that 'the time of trouble' fits perfectly well with the first 7 weeks. Therefore we can doubt that it has anything to do with the 62 week² period.
4. There is an anointed one, a prince at the end of the first 7 weeks and there is an anointed one at the end of the 62 weeks. If you read further you will see that there is also a prince associated with the last 7 weeks.

In the previous page we have associated the end of the first 7 weeks of Daniel with the establishment of Purim. We can now point to the real identity of the 'Anointed one, the Prince' mentioned in Daniel 9:24. Without doubts it can be no one else than **Mordecai** (Queen Esther's uncle).

- Est 8:15 Mordecai left the king's presence **wearing royal garments of blue and white, a large crown of gold** and a purple robe of fine linen. NIV
- Est 9:4 Mordecai was prominent in the palace; his reputation spread throughout the provinces, and he became more and more powerful. NIV
- Est 10:3 **Mordecai the Jew was second in rank to King Xerxes**

In "Daniel's 70th week" Appendix I on page 271 we will see that the last week of Daniel 70-week is associated with the third Temple in Jerusalem. I bring this piece of information early on to highlight something that has never been understood until now:

The three parts of Daniel 70-week (7 w. 62 w. 70th w.) are directly and fundamentally related to the Temple.

The 70-week of Daniel: a timeline for the Temples

In this book you have learned that the first 7-week starts with the 'Foundation' of the second Temple and I just told you that the 70th week will fully overlap the exact duration of the third Temple. Now I will show you that the end of the 62-week (i.e. Yeshua's death) coincides with the SYMBOLICAL end of the second Temple? Here is how:

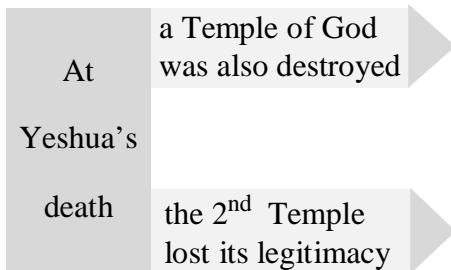

John 2:19 Jesus answered them, "**Destroy this temple**, and I will raise it again in three days." NIV
 John 2:21 But the temple he had spoken of was his body.

Matt 27:51-52 At that moment the curtain of the temple was torn in two from top to bottom

Several supernatural acts took place in the Temple for the next 40 years (see box on page 158). Each one indicating that the Temple was doomed. *Babylonian Talmud Yoma 39b*

The 70 weeks of Daniel start exactly **500** years after the 7-year's construction of the 1st Temple.

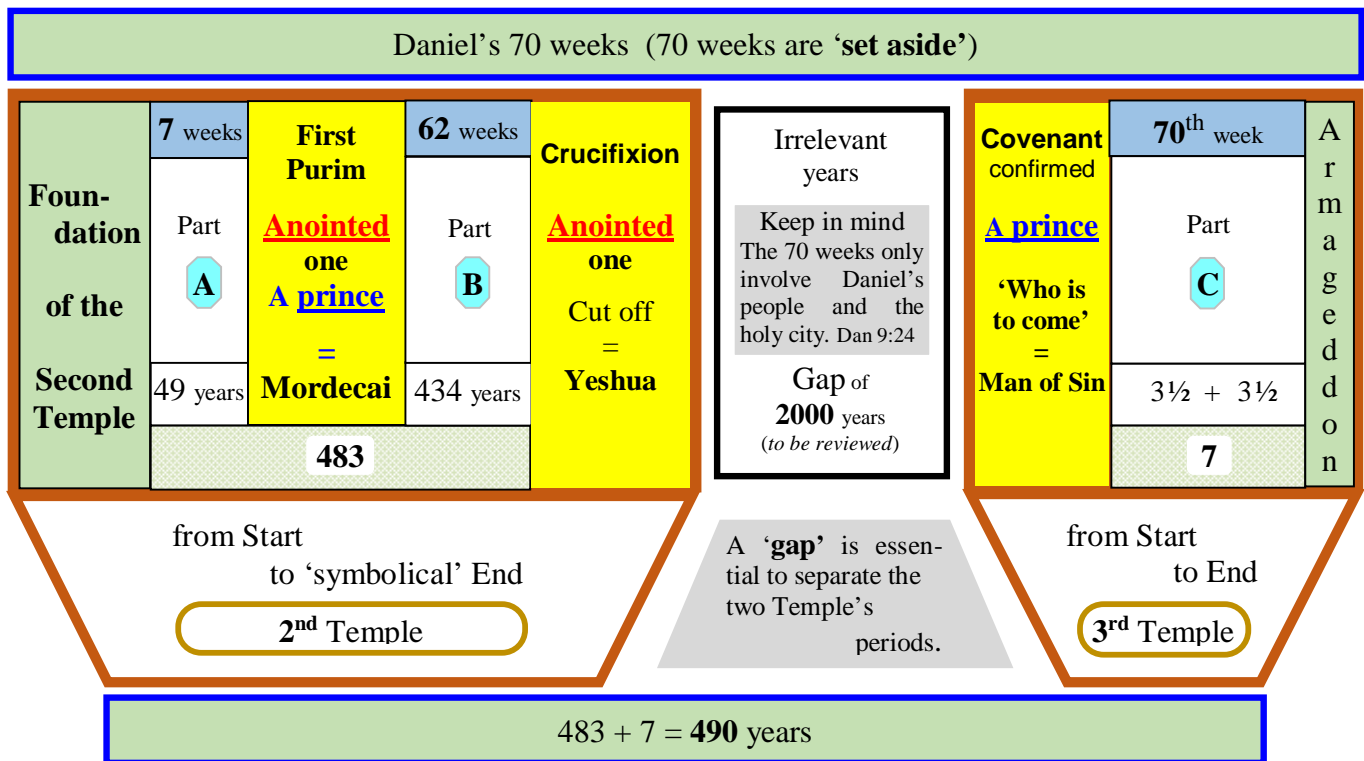

Remarkable the chart graphically demonstrates the necessity of a **gap** between Daniel's first 69-week and 70th week. Here is the proof that the gap between these two periods is totally legitimate (because of the Temple's correlation) and is meant to last thousands of years.

Post Exile chronology

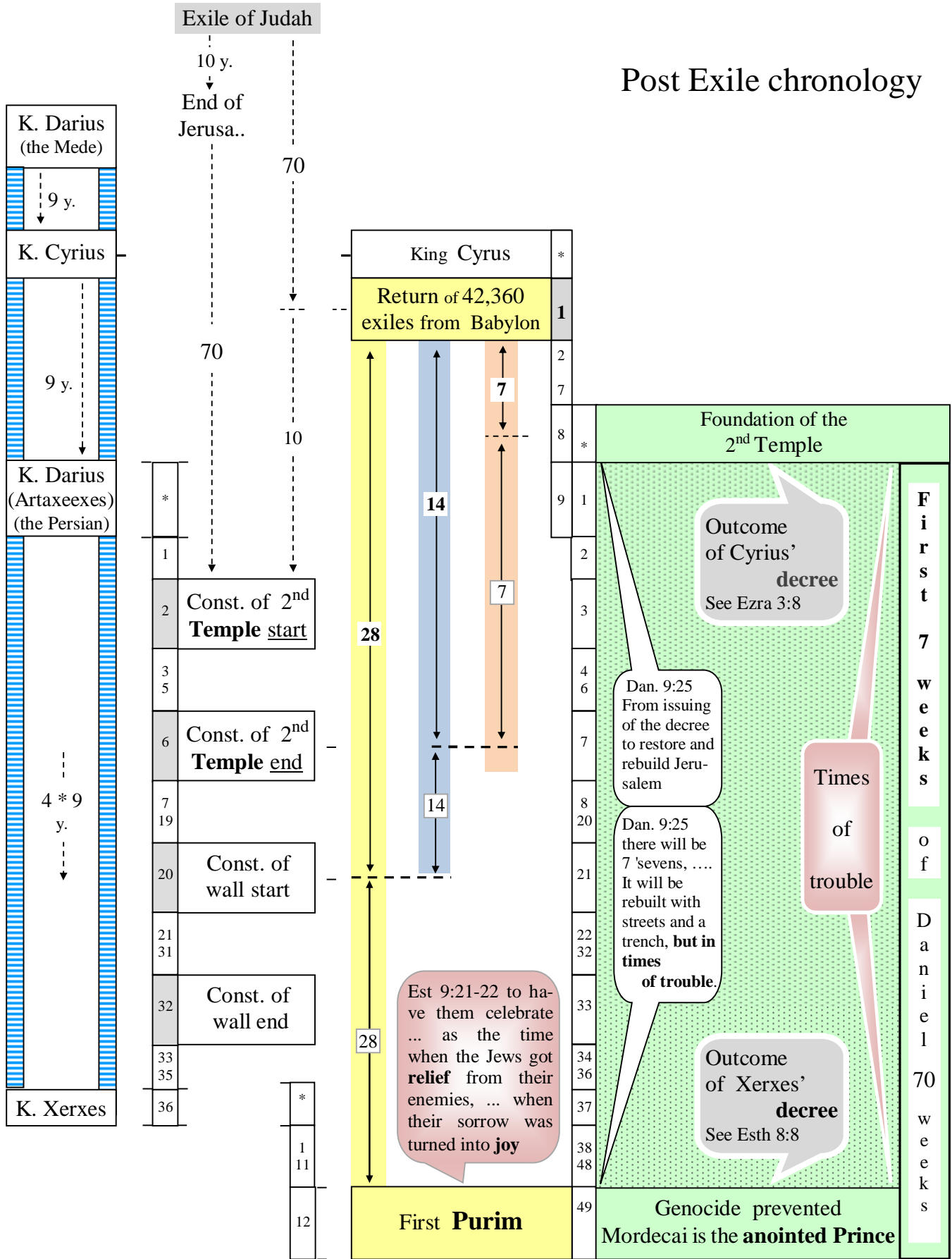

Figure 20 Post Exile chronology

Ezekiel fasts during 40 days

(this symbolical act is the counterpart to ‘Ezekiel ate defiled food for 390 days’ on page 70)

God originally intended to have Ezekiel cook his food over human excrement. However, this ordeal was lightened following Ezekiel’s objection that he had never defiled himself in the past.

- Ezek 4:14 So I said, "Ah, Lord GOD! Indeed I have never defiled myself from my youth till now; I have never eaten what died of itself or was torn by beasts, nor has abominable flesh ever come into my mouth."

Ezekiel’s food was cooked over cow manure, an acceptable compromise to the prophet.

- Ezek 4:15 Then He said to me, "See, I am giving you cow dung instead of human waste, and you shall prepare your bread over it."

Apparently Ezekiel’s food was still symbolically defiled, no matter how it was cooked.

- Ezek 4:13 "So shall the children of Israel eat their defiled bread among the Gentiles,

So, after 390 days of eating defiled food, Ezekiel turned over and fasted⁹⁴ for a period of 40 days. We saw earlier (see page 70) that the prophet eating defiled food was a symbolical act portraying a period during which Israel would only hear lies instead of the true words of God. In a way Israel was given poisonous food for the mind. What then should we think of the prophet fasting during 40 days? There is such a powerful contrast between Ezekiel two successive actions (eating defiled food – fasting) that we should also find a similar contrast between the two periods portrayed by them.

Symbolically, Ezekiel’s 40 days fast (while lying on his right side) was like cleansing ‘purging’ his body. This is the characteristic that we will use to identify the intended period associated with the house of Judah. Indeed, at one point the people of Judah must have gone through a radical change that literally initiated what would become a ‘40 years cleansing period’. And, to mark the end of that 40 year period, we should also find the occurrence of another event that will ‘metaphorically’ denote how Judah’s cleansing ended and how the people were reintroduced to a proper food for the mind.

The period portrayed by the symbolical act “**Ezekiel fasts during 40 days**” will have to meet the following criteria:

- Should start with an important change: (lies and idolatry ceased)
We are contrasting ‘Ezekiel feeding from defiled food during 390 days’
with ‘Ezekiel fasting during 40 days’.
- Absence of any ‘indoctrination’ during 40 years. (portrayed by Ezekiel’s fasting)
- Should end with an important change: (adequate learning was provided again)
Keep in mind that after his 40 days fast, Ezekiel started feeding himself again.

⁹⁴ This is implied by the absence of food during the time Ezekiel lied on his right side.

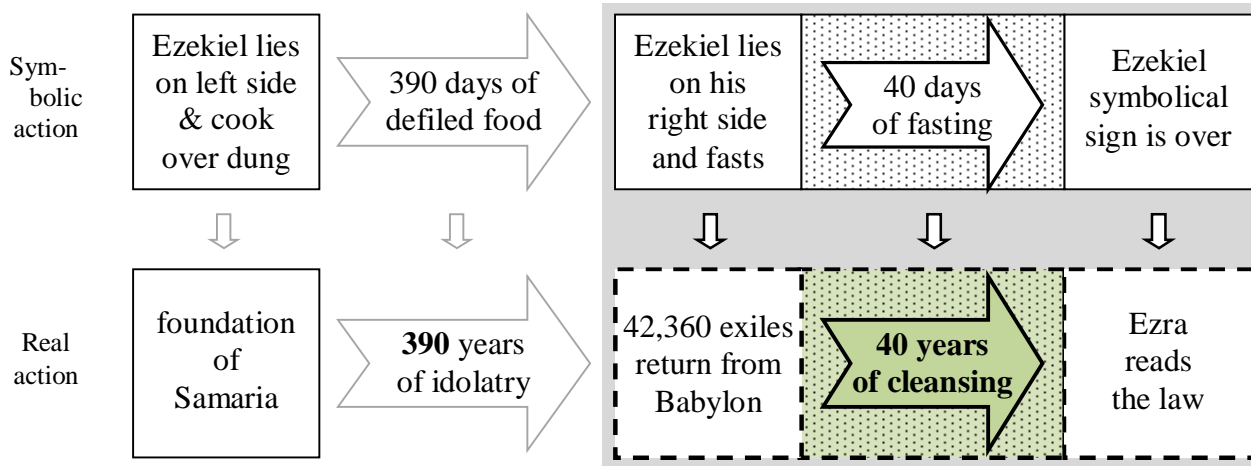

The 'return of the 42,360 exiles' points to the time when Judah (under the leadership of Zerubbabel) came back from the Babylonian captivity. This event is the perfect candidate to mark the start of the 40 years cleansing period we are looking for.

Indeed, as illustrated in the next figure, the return of the exiles marked the end of a 390 year period characterized by the proliferation of false prophets and the spreading of idolatry. The people of Judah spent the last 70 years of this 390 year period in Babylon, an environment associated with paganism.

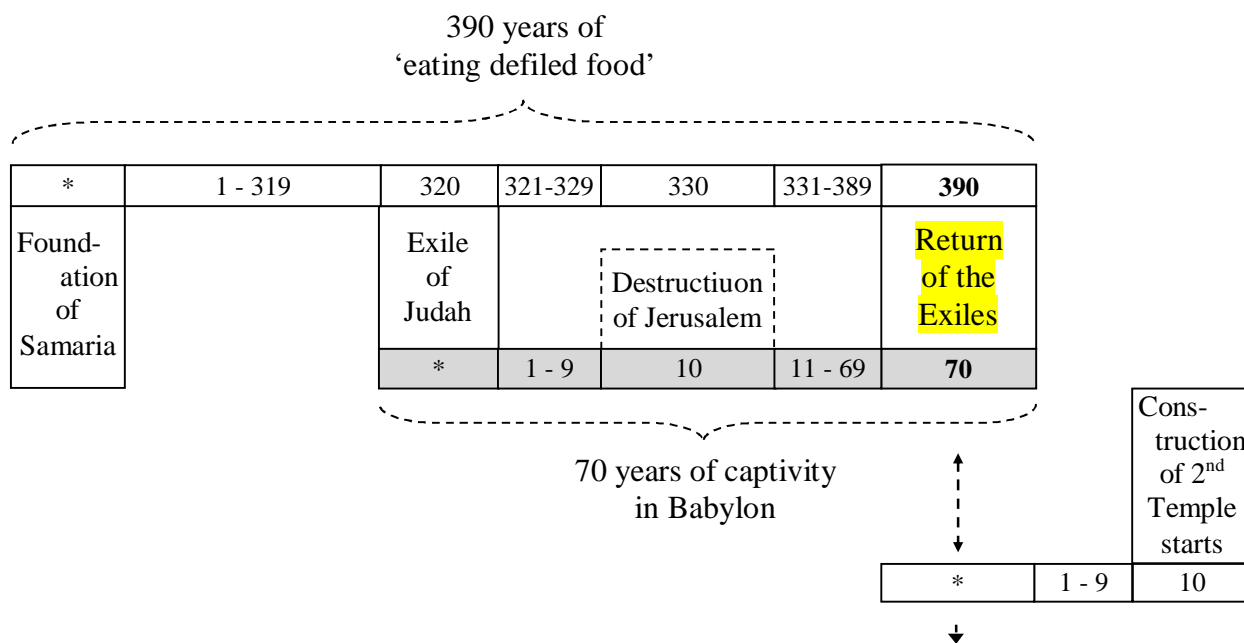

When they came back from captivity, the 42,360 exiles of Judah didn't receive any teaching of the law of God for a very long time (40 years). What preoccupied them at the time was rebuilding the country, the cities, the houses, the Temple, and repair the wall of Jerusalem that Nebuchadnezzar's army had left in ruin 60 years before. This 40 years without idolatry and without hearing any law of God can be viewed as **40 years of cleansing**.

The restoration of the wall surrounding Jerusalem was completed 40 years after the Return of the Exiles (see figure page 132)

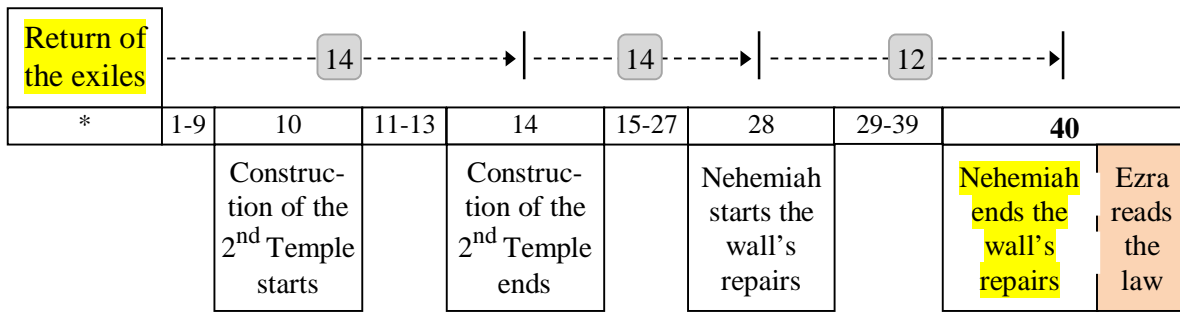

A very short time after the wall was fully repaired, the law of God was read by Ezra. It was the first time in centuries that the people of Judah heard it.

- Neh 6:15 So the wall was completed on the twenty-fifth of Elul, in fifty-two days. NIV (i.e. 12 years to repair the wall, 52 days to repair the gates)
- Neh 7:11 After the wall had been rebuilt and I had set the doors in place NIV
- Neh 7:73-8:1 When the seventh month came and the Israelites had settled in their towns, all the people assembled as one man in the square before the Water Gate. **They told Ezra the scribe to bring out the Book of the Law of Moses**, which the LORD had commanded for Israel. NIV

The reading of the law (about 6 days after Nehemiah completed the repairs on the wall) marks the end of the 40 years of cleansing that the people of Judah went through after the return from Exile. Notice how Ezekiel two consecutive symbolical acts (eating defiled food during 390 days, fasting during 40 days) portray two successive periods.

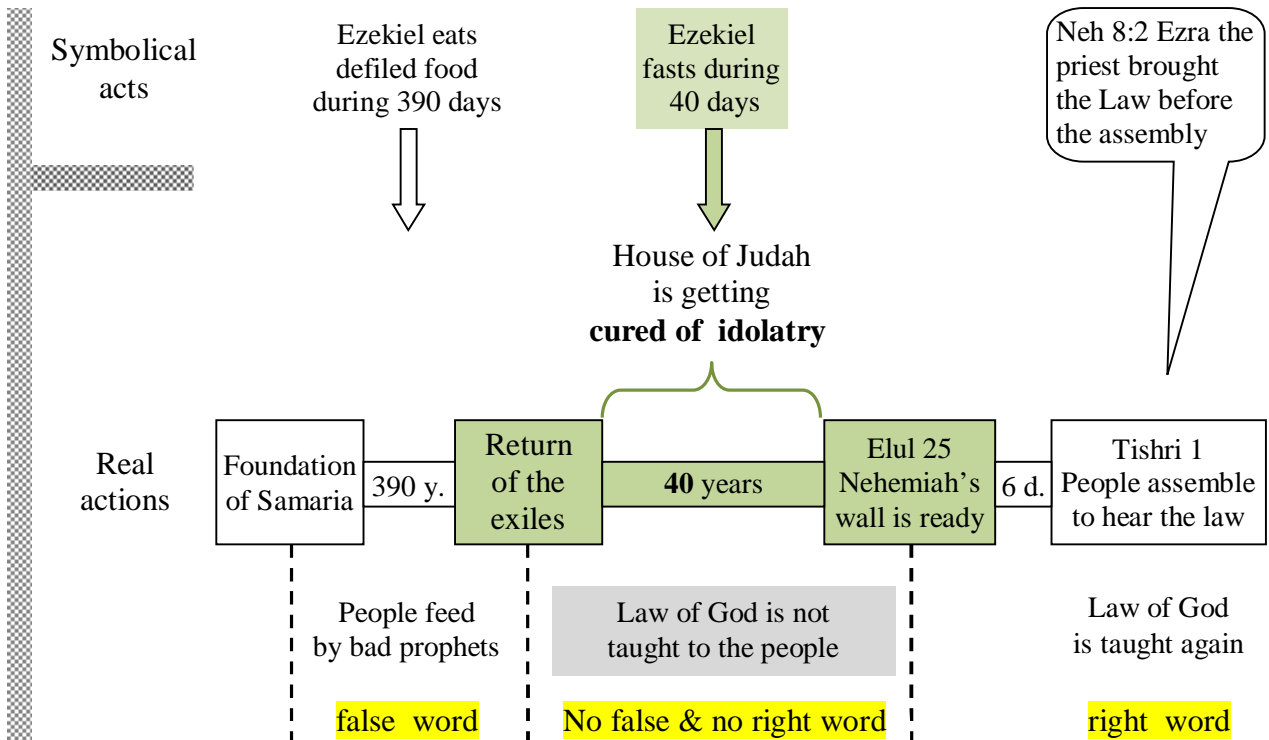

Ezekiel's famine of words

Right from the beginning of his call Ezekiel was given an absolutely clear mandate. He would be sent among his brother Israelites as a prophet and would have to tell them that their ways were doomed:

- Ezek 2:4 and you shall say to them, 'Thus says the Lord GOD.' NKJV
- Ezek 2:7 You shall speak My words to them NKJV
- Ezek 3:1 and go, speak to the house of Israel. NKJV
- Ezek 3:4 "Son of man, go to the house of Israel and speak with My words to them.
- Ezek 3:11 and go, get to the captives, to the children of your people, and speak to them and tell them, 'Thus says the Lord GOD NKJV
- Ezek 3:18 When I say to the wicked, 'You shall surely die,' and you give him no warning, nor speak to warn the wicked from his wicked way, NKJV

Ezekiel was not allowed to refuse God's call. No matter what, he would be accountable should he fail to relay the appropriate warning to the wicked:

- Ezek 3:20 because you did not give him warning, he shall die in his sin, and his righteousness which he has done shall not be remembered; but his blood I will require at your hand. NKJV

As we can see from the previous references, Ezekiel was reminded again and again that he would have to talk to his people. But then, just when Ezekiel should have started to fill his assignment, **the most unexpected thing happened.** Ezekiel was asked to go and shut himself in his house (Ezek 3:24). And the Spirit deliberately stuck Ezekiel's tongue to the roof of his mouth to incapacitate the prophet in such a way that **it became impossible for him to orally communicate with others:**

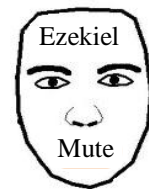

- Ezek 3:26 I will make your tongue cling to the roof of your mouth, so that you shall be mute and not be one to rebuke them

From then on Ezekiel would be allowed to talk only after being spoken to by the spirit:

- Ezek 3:27 But when I speak to you, I will open your mouth and you shall say to them,

Notice that Ezekiel was sent to his home as soon as he became mute. Given that the Spirit didn't speak to him again until (see Ezek 8:1) the 5th day of the 6th month of the 6th year, we can rightly deduce that Ezekiel didn't talk to anybody during the time he was lying on his sides:

- Ezek 8:1 And it came to pass in the sixth year, in the sixth month, on the fifth day of the month, as I sat in my house with the elders of Judah sitting before me, NKJV
- Ezek 8:5 Then He said to me, NKJV

So to stress what is now obvious: Ezekiel, the prophet, specially commissioned to talk to his brothers the Israelites, spent 430 days lying on his side, being unable to speak. During these 430 days, Ezekiel didn't receive and didn't deliver any word from God. Doesn't this strange situation make a lot more sense if we recognize that Ezekiel's period of silence was yet another symbolic act?

Ezekiel's 430 days of silence are screaming to draw our attention to **a famine of words** that was going to prevail for some 430 years:

- Amos 8:11-12 "Behold, the days are coming," says the Lord GOD, "That I will send a famine on the land, Not a famine of bread, Nor a thirst for water, **But of hearing the words of the LORD**. They shall wander from sea to sea, And from north to east; They shall run to and fro, seeking the word of the LORD, But shall not find it. NKJV

Now, starting at the time of the 'Covenant of the Land' and moving forward, using some of the indicators previously seen in this paper, can we pinpoint a 430-year period during which there was, in all likelihood, no communication from God? Yes, and it can be done without any difficulty. The following timeline shows six successive periods obtained by the use of 7 events already seen in this paper. The easiest way to isolate the period of silence we are looking for is to disqualify each period during which God maintained some form of communication with the Israelites. Inevitably⁹⁵ only the right period will remain.

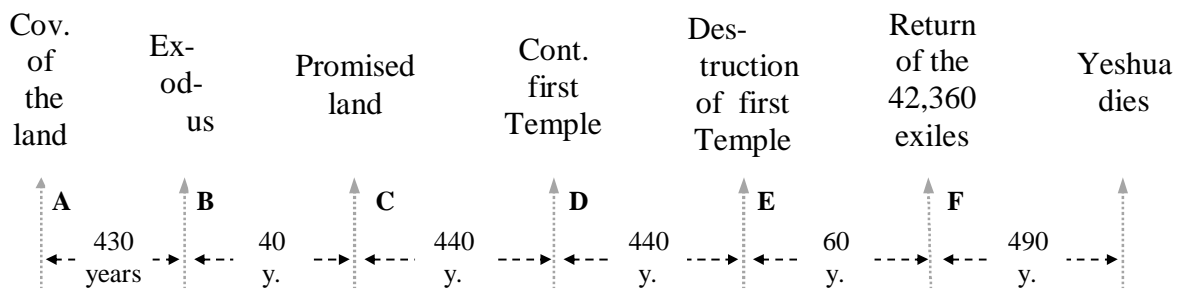

References to each period:

- A : Figure 14. Covenant of the land on page 90
- B : Figure 2. Land divided on page 18
- C : Figure 8. Blocks 1 and 3 reunited on page 66
- D : Figure 8. Blocks 1 and 3 reunited on page 66
- E : Figure 15. Shaving act on page 93
- F : Figure 17. Hair growing act on page 114

From what we know, there was either direct communication from God or from His prophets during period (A,B,C,D,E). This leave period 'F' as the only period left to investigate. Was there a 430-year 'Famine of the words' sometime during this 490-year period (F)? Yes

We saw earlier (on page 132) that 56 years after the return of the exiles one reaches Esther's first Purim⁹⁶. In the book of Esther an amazing sequence of coincidences conspire to save the Jews from annihilation. It is obvious to the readers of the story that God was behind the scene to help his people right from the start.

The day after they had killed all their enemies, the Jews of the Persian empire had an opportunity to collectively thanks God and to exalt His name. Unfortunately none of this happened. Instead, Esther and Mordecai, two of the story's characters, institutionalised a new feast to mark the time of their salvation from Haman national holocaust. They called that feast '**PURIM**', a name that commemorates "LOT" (or cast lot) **the exact opposite of acknowledging God's genuine involvement**. Since then, each year, the Jews remember the good fortune they had by exchanging gifts between themselves and they also remember what Mordecai and Esther had done for them.

⁹⁵ We rule out that there was more than one 'famine of words' that could have lasted 430 years.

⁹⁶ I seems an appropriate name for the very first occurrence of that feast

Disregarded by everybody, there is a shocking absence in the book of Esther: **the name of God is never mentioned**⁹⁷. Doesn't this situation remind us of when the Israelites rejected God and asked to have a king (Saul) chosen from among them? They did obtain their king at that time but at this terrible price, they lost the divine protection they had enjoyed during the previous **430 years** (see page 63). Clearly, God is again inflicted a major affront. This time they chose to honor their two new heroes, Mordecai and Esther, who had spoken for their welfare. Apparently, in spite of saving them from death, God didn't spoke loud enough.

Did God react to this contempt? How about ignoring them and keeping **silent**⁹⁸ for the next **430 years**? (Deut 32:20 "I will hide my face from them")

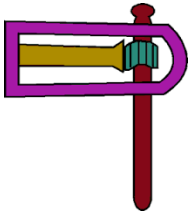

According to the Jewish belief, after the Megillat Esther there were no more prophets, no more miracles, no more direct communications from God.

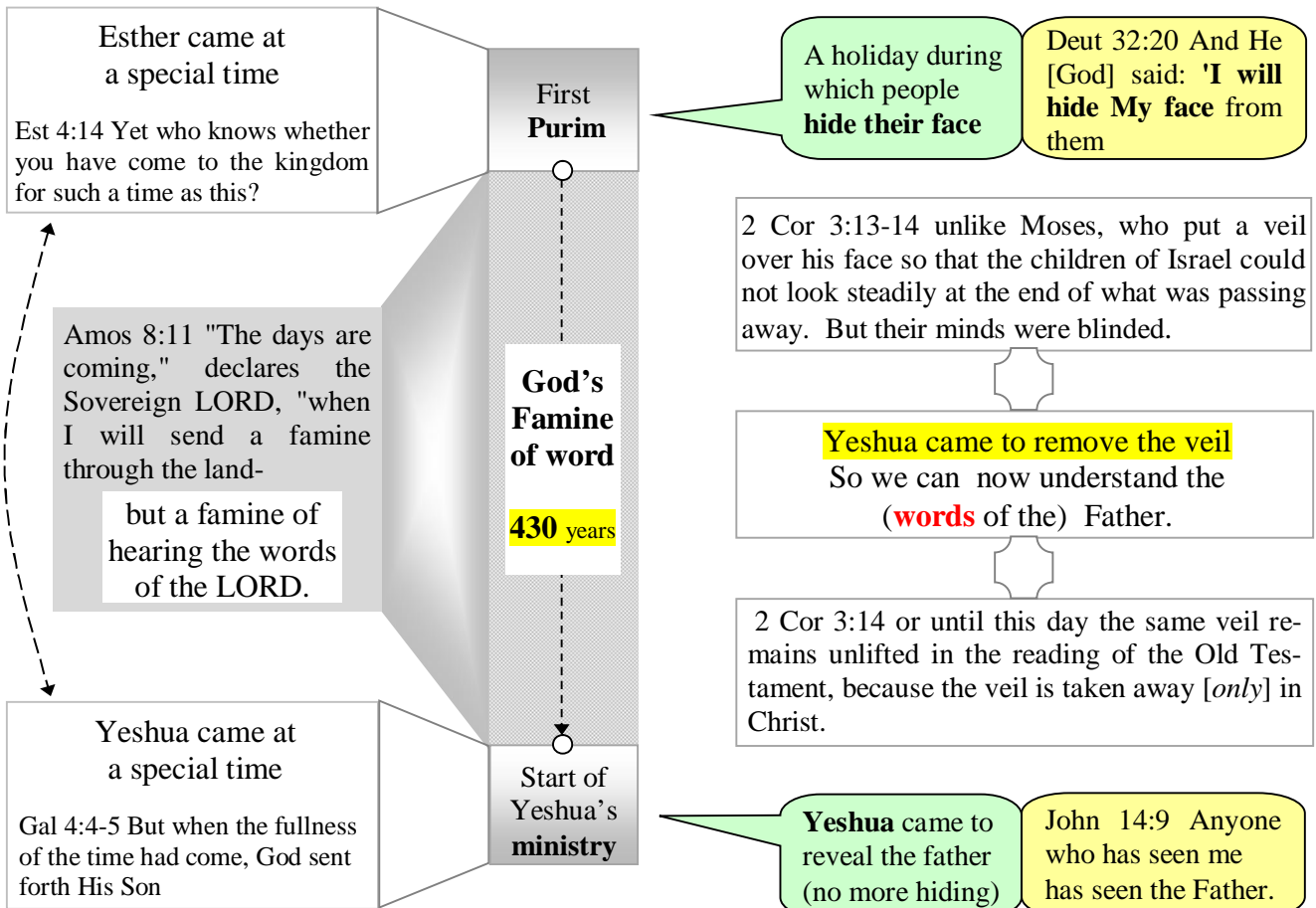

⁹⁷ The book of Esther is the only book of the Hebrew Bible that doesn't mention God. According to the Jewish sages there is a play of words using the name Esther in Hebrew that could mean 'hiding of the face'.

⁹⁸ One tradition when listening to Esther being read is to drown out the name of Haman whenever it is read with noise and "booming". Here, the people's behavior greatly contrasts with God's reaction. (**noise VS silence**)

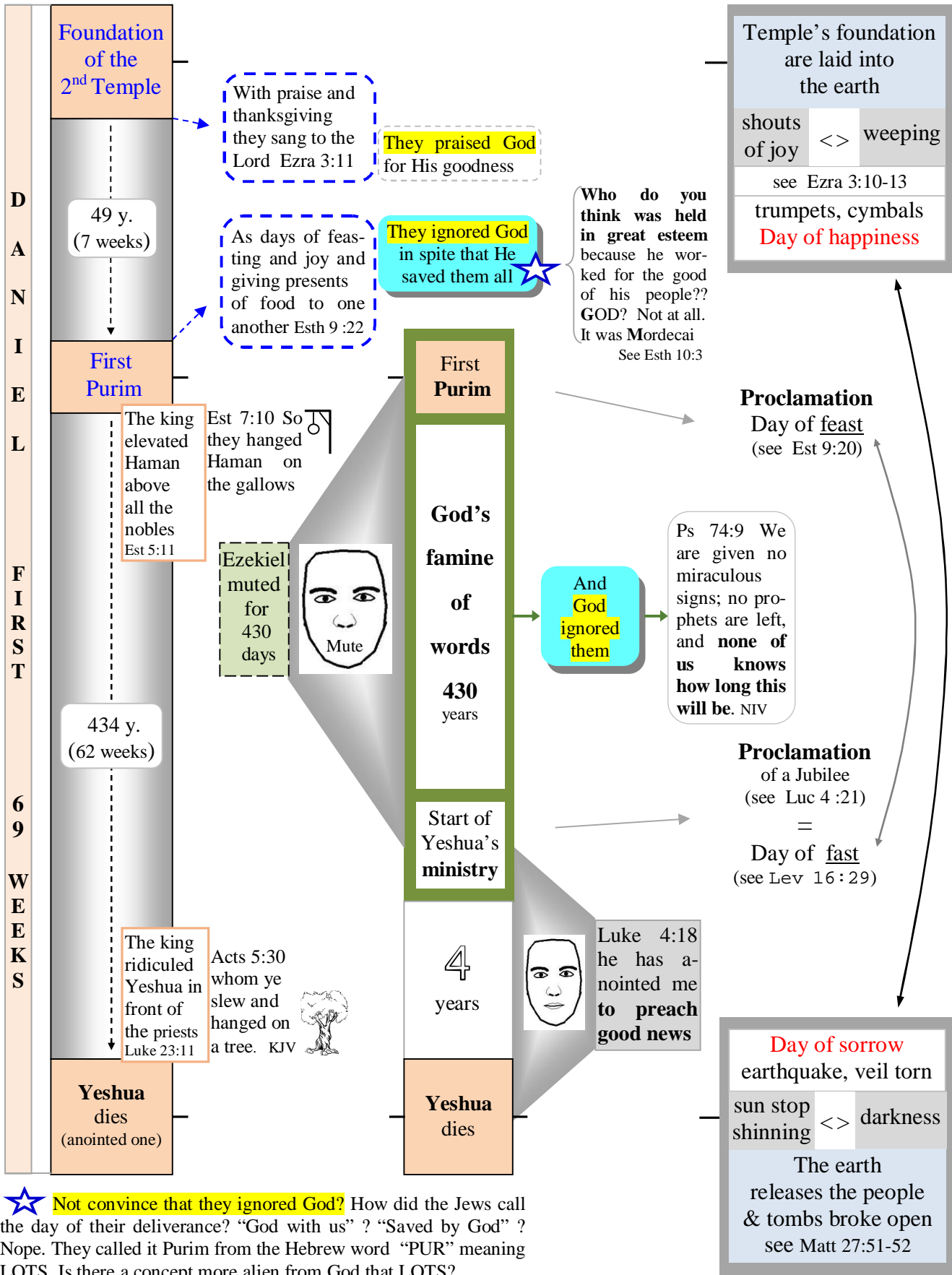

★ **Not convince that they ignored God?** How did the Jews call the day of their deliverance? "God with us" ? "Saved by God" ? Nope. They called it Purim from the Hebrew word "PUR" meaning LOTS. Is there a concept more alien from God that LOTS?

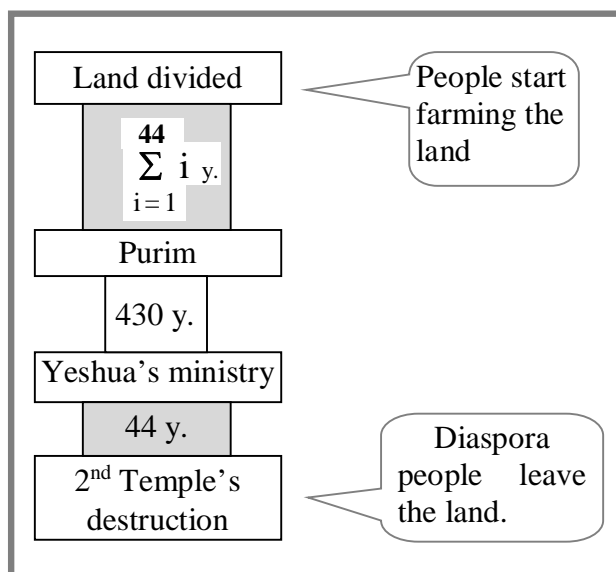

Purim	Est 8:11 By these letters the king permitted the Jews who were in every city to gather together and protect their lives--to destroy, kill, and annihilate all the forces of any people or province that would assault them, both little children and women, and to plunder their possessions, NKJV
	Est 8:14 The couriers who rode on royal horses went out, hastened and pressed on by the king's command. [to proclaim the good news] NKJV
430 years	
	<p>Luke 4:17-21 He found the place where it was written: "The Spirit of the LORD is upon Me, Because He has anointed Me To preach the gospel to the poor; He has sent Me to heal the brokenhearted, To proclaim liberty to the captives And recovery of sight to the blind, To set at liberty those who are oppressed; To proclaim the acceptable year of the LORD." Then He closed the book, and gave it back to the attendant and sat down. And the eyes of all who were in the synagogue were fixed on Him. And He began to say to them, "Today this Scripture is fulfilled in your hearing." NKJV</p>
	Yeshua's Ministry

Did the start of Yeshua's ministry⁹⁹ bring back the prophets, miracles, and some communication from God? Yes it did and here are a few references of the change that happened:

- Luke 4:24 Then He [Yeshua talking about himself] said, "Assuredly, I say to you, no **prophet** is accepted in his own country. NKJV
- Luke 4:39 So He stood over her and **rebuked [one of Yeshua's miracle] the fever,** and it left her. And immediately she arose and served them. NKJV
- Luke 3:22-23 And the Holy Spirit descended in bodily form like a dove upon Him, **and a voice came from heaven** which said, "You are My beloved Son; in You I am well pleased." Now Jesus Himself began His ministry at about thirty years of age..

⁹⁹ It will be demonstrated later on that the first year of Yeshua's ministry marked the beginning of a Jubilee.

At the start of his symbolic act, Ezekiel's **tongue** is stuck in his **mouth** and he cannot talk. At the end of the 430-year period of what we believe to be the 'famine of the word' Yeshua **preaches** to an audience that 'the scripture' is fulfilled in their ears (Luc 4:21) [Here, beside proclaiming a Jubilee year, Yeshua could be meaning that a specific period of time just came to an end].

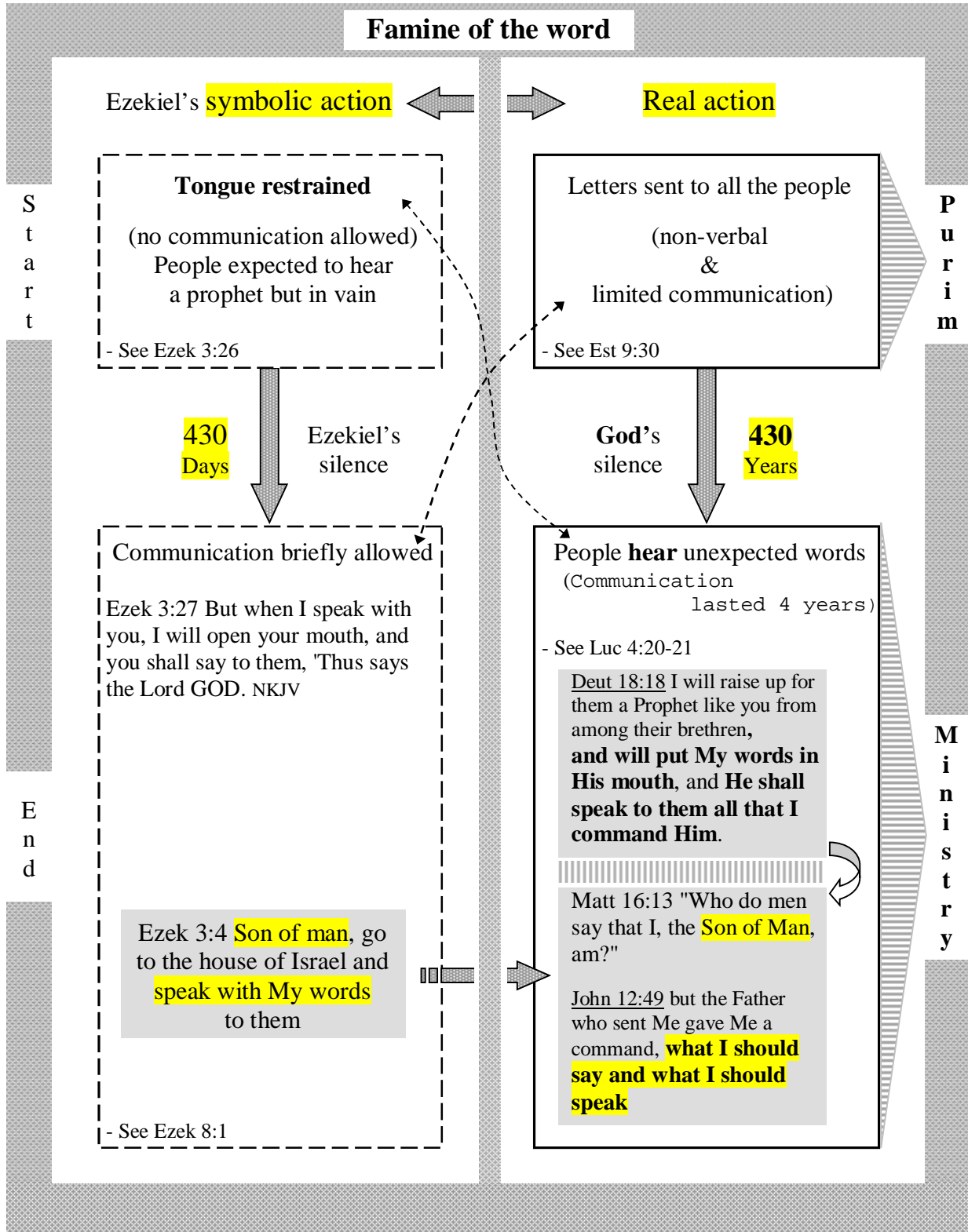

CONCLUSION (of first part)

The first part of this paper has convincingly (I certainly hope so) demonstrated that Ezek 4-5 was symbolically taking place in the Temple.

Should we be surprised that the very first verse of Ezekiel (Ezek 1:1) ties in the prophet's 'personal calling' to the exact year that the Temple was cleansed by King Josiah?

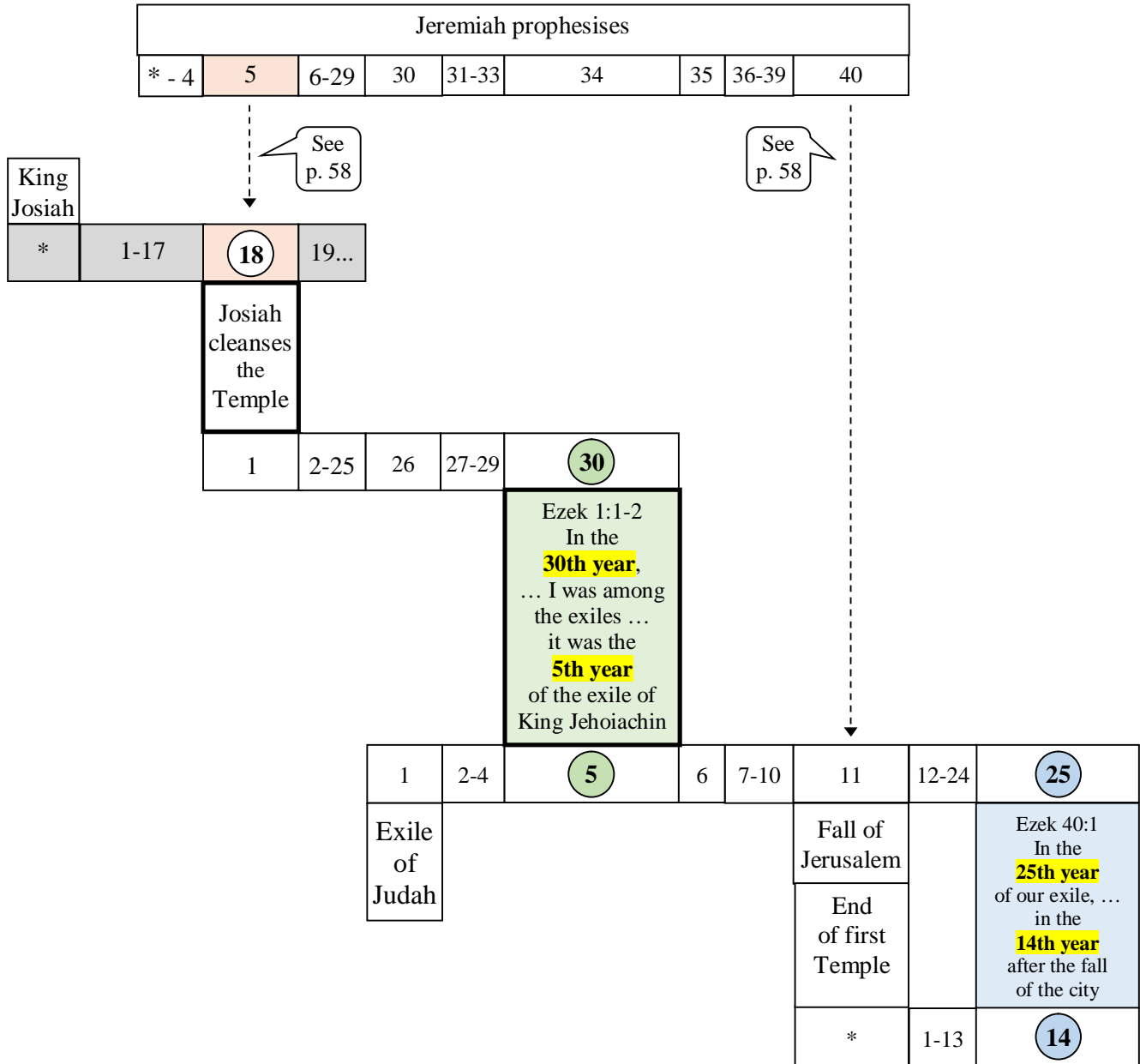

Second part

➔ Setting a true chronology of the Bible

I believe, like many other who study the Bible's chronology, that God has allowed humankind to evolve according to a 7,000-year Master Plan. In all likelihood this **Master Plan** is mirrored in the creation week. If this interpretation is right, we haven't reached year 6,000 AM yet, otherwise we would be living now during the millennial rest, which is not the case..

In the following pages I am going to associate a 'date' to each important event of the Bible, this will bring the discovery of some stunning patterns never exposed until now.

Creation week	Day 1	2,000 years	No Torah	Talmudic tradition The Jews abandoned this view and failed to recognize Yeshua as the Messiah they were expecting
	Day 2			
	Day 3	2,000 years	Torah	
	Day 4			
	Day 5	2,000 years	Messianic	
	Day 6			
	Day 7	1,000 years	Millennial rest	

Ps 90:4 For a thousand years in your sight are like a day that has just gone by

The AM mode of dating

This chronology uses the AM mode of dating instead of our more familiar Gregorian calendar. In the **AM** system (**Anno Mundi**) year '0' coincides with the creation of the world and the new year's day occurs around the time of each new spring equinox. (See Ex 12:1-3).

Using Abraham year of birth '2008 AM' (see Appendix A on page 229) as a starting point you can figure out the date of each event displayed on the left side of the next figure. This is done by going backward or forward a specific number of years (obtained from the Bible) from a known date (2008 AM). This process consolidates a new date at each step.

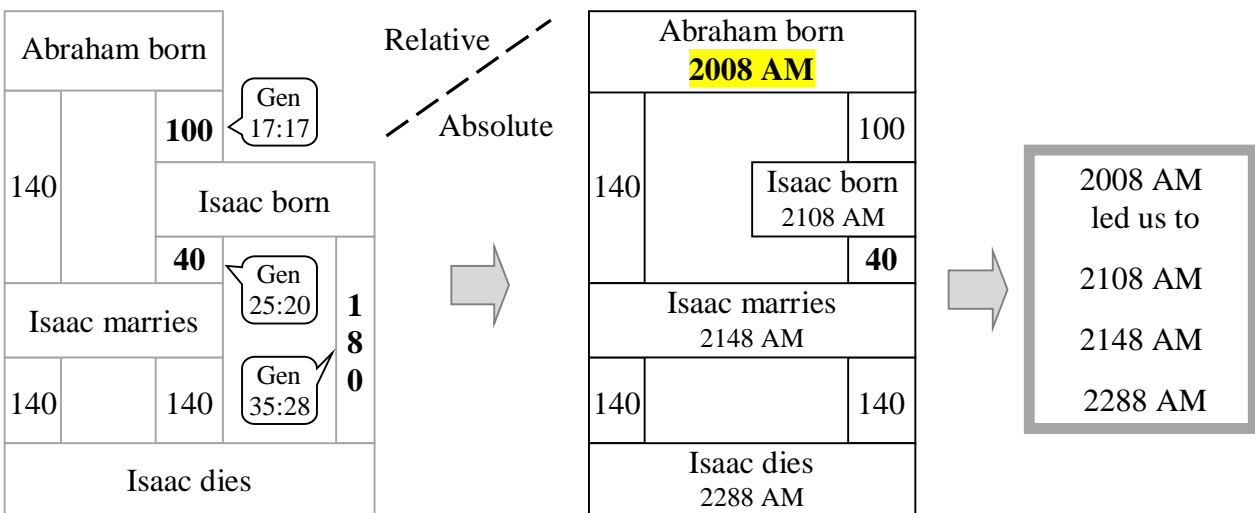

(This method was used to revisit every figure previously displayed in this work. As expected, each time a figure was reviewed, several new dates became available to help assess the timing of the reminding events. See the full result in Appendix E on page 257)

→ The timeline of Joseph

For an easier understanding follow the path in the numerical order. 1,2,3,..., 24 ★

The stepping stones path ★	Operation	Reference	Years	Event
1		Appendix A	2008 AM	Abram born
3	2108 - 90	Gen 17:17	2018 AM	Sarah born
4	2008 + 85	See page 80	2093 AM	Covenant of the land
2	2008 + 100	Gen 17:17	2108 AM	Isaac born
6	2018 + 127	Gen 23:1	2145 AM	Saraï dies
7	2108 + 40	Gen 25:20	2148 AM	Isaac marries
8	2108 + 60	Gen 25:26	2168 AM	Jacob born
9	2008 + 175	Gen 25 :7	2183 AM	Abraham dies
21	2265 - 20	Gen 31:41	2245 AM	Jacob hired by Laban
22	2245 + 7	Gen 29:20	2252 AM	Jacob marries
23	2252 + 1	Gen 29:31-32	2253 AM	Reuben born
16	2288 - 30	Gen 41:46	2258 AM	Joseph born
19	2258 + 1	Gen 30:25	2259 AM	Jacob completes 14 years of work for Laban
20	2259 + 6	Gen 31:41	2265 AM	Jacob leaves Laban
24		Next few pages	2268 AM	Benjamin born
17	2258 + 17	Gen 37:2	2275 AM	Joseph in Egypt
15	2288 - 2	Gen 41 :1	2286 AM	Joseph helps the baker
14	2108 + 180 2289 - 1	Gen 35:28 Gen 41:25	2288 AM	Isaac dies/ Joseph meets Pharaoh
13	2296 - 7	Gen 41:53	2289 AM	Start of 7 years of plenty
12	2298 - 2	Gen 45:6	2296 AM	Start of 7 years of famine
11	2168 + 130 2315 - 17	Gen 49:9 Gen 47:28	2298 AM	Jacob meets Pharaoh
10	2168 + 147	Gen 47:28	2315 AM	Jacob dies
18	2258 + 110	Gen 50:26	2368 AM	Joseph dies
5	2093 + 430	Ex 12 :40	2523 AM	Exodus

The dates of the events on the left side of this chart can be figured out without too much difficulty. (Refer to the table on page 148 for the steps)

However there is nothing in the Bible to pinpoint the exact date of the following four events:

Benjamin born
Joseph sent to prison
Manasseh birth
Ephraim birth

Benjamin was born some years after Jacob left Laban in 2265 AM and before Joseph was sold and sent to Egypt in 2275 AM. See Gen 34-35.

From Gen 39 we learn that Joseph, once in Egypt, became the intendant of Potiphar. No doubt it took many years before Potiphar would entrust everything he owned in the hands of Joseph. Therefore we can 'only' deduce that Joseph must have been sent to prison at least several years after his arrival in Egypt.

From Gen 41:50 we learn that Manasseh and Ephraim were born during the 7 years of plenty.

In the following pages we will see why, in all likelihood, these 4 events can be connected to the following dates

Benjamin born	2268 AM
Joseph sent to prison	2285 AM
Manasseh birth	2291 AM
Ephraim birth	2295 AM

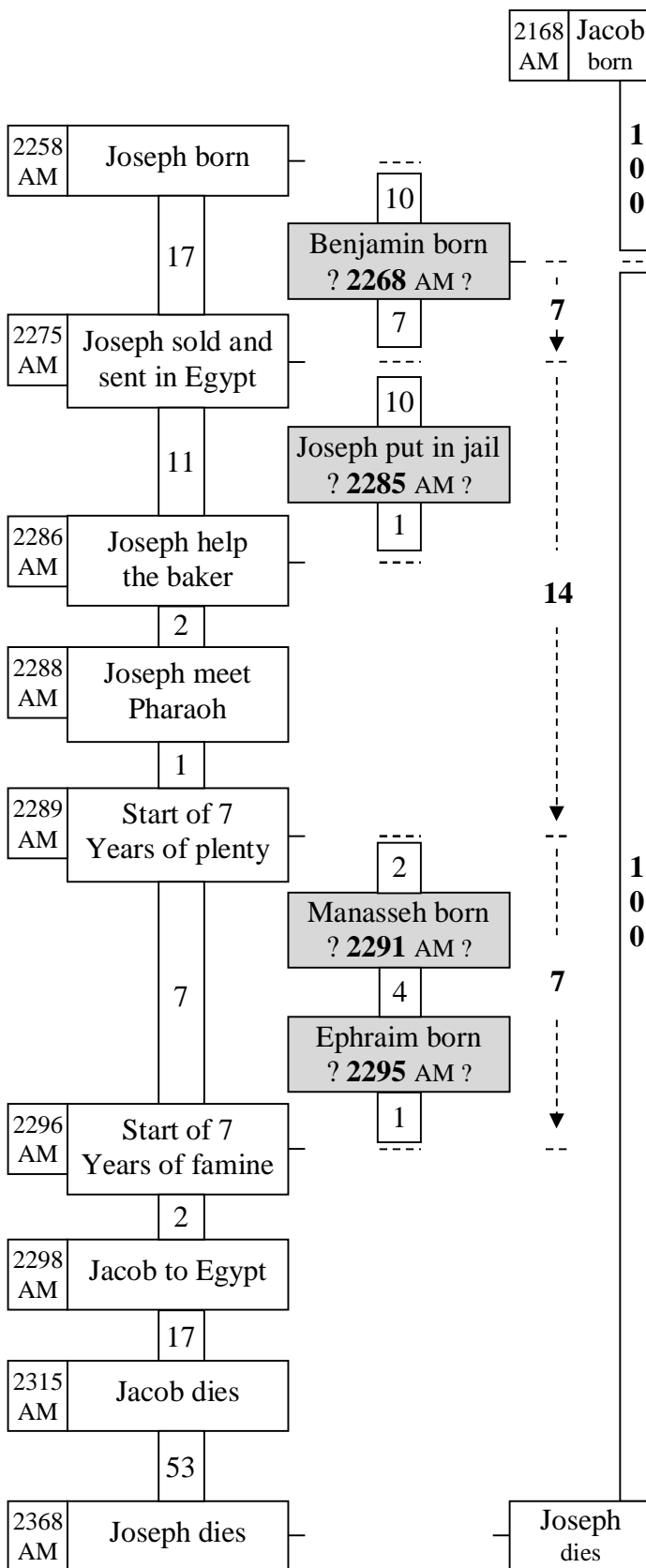

Rachel's sons

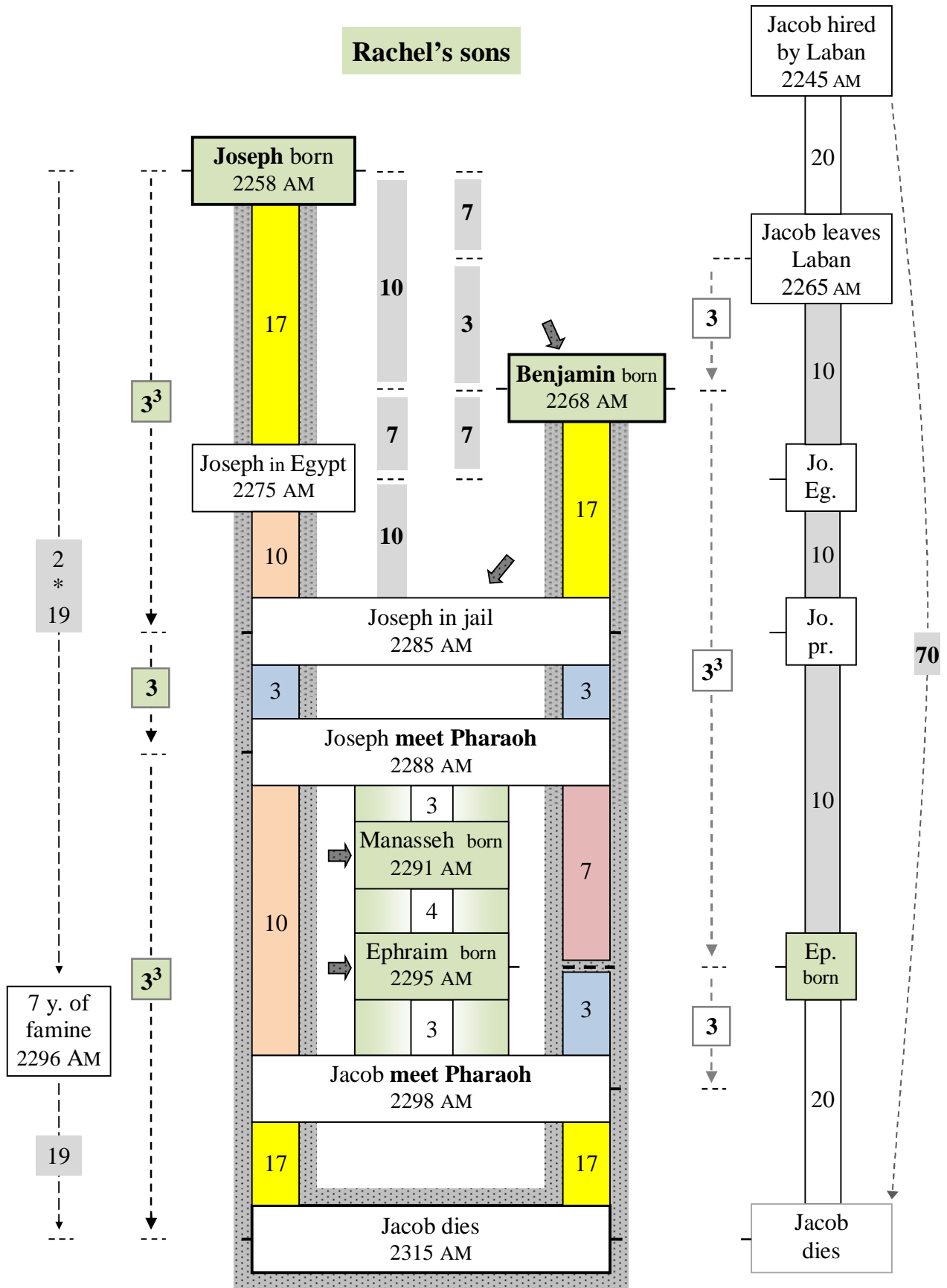

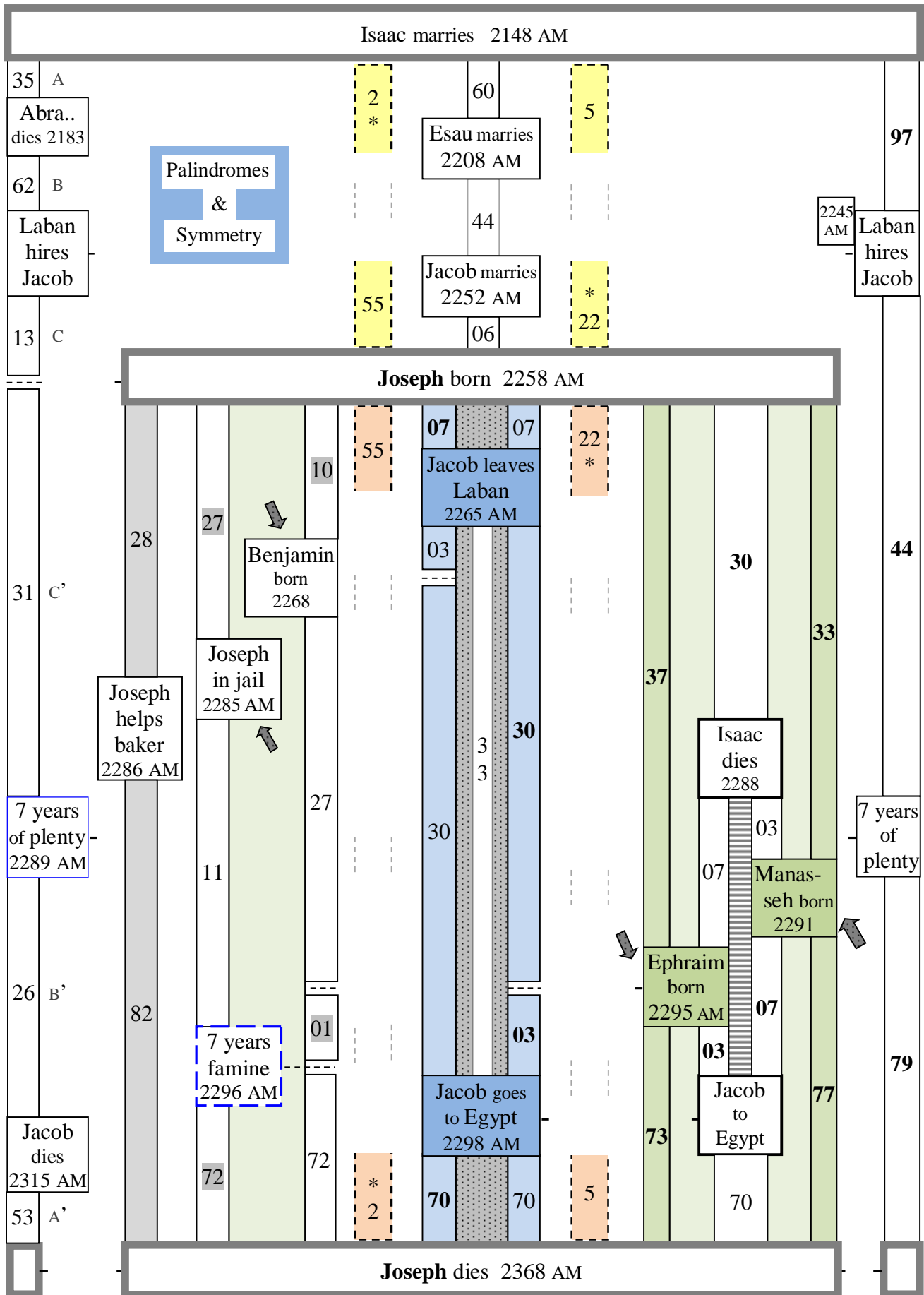

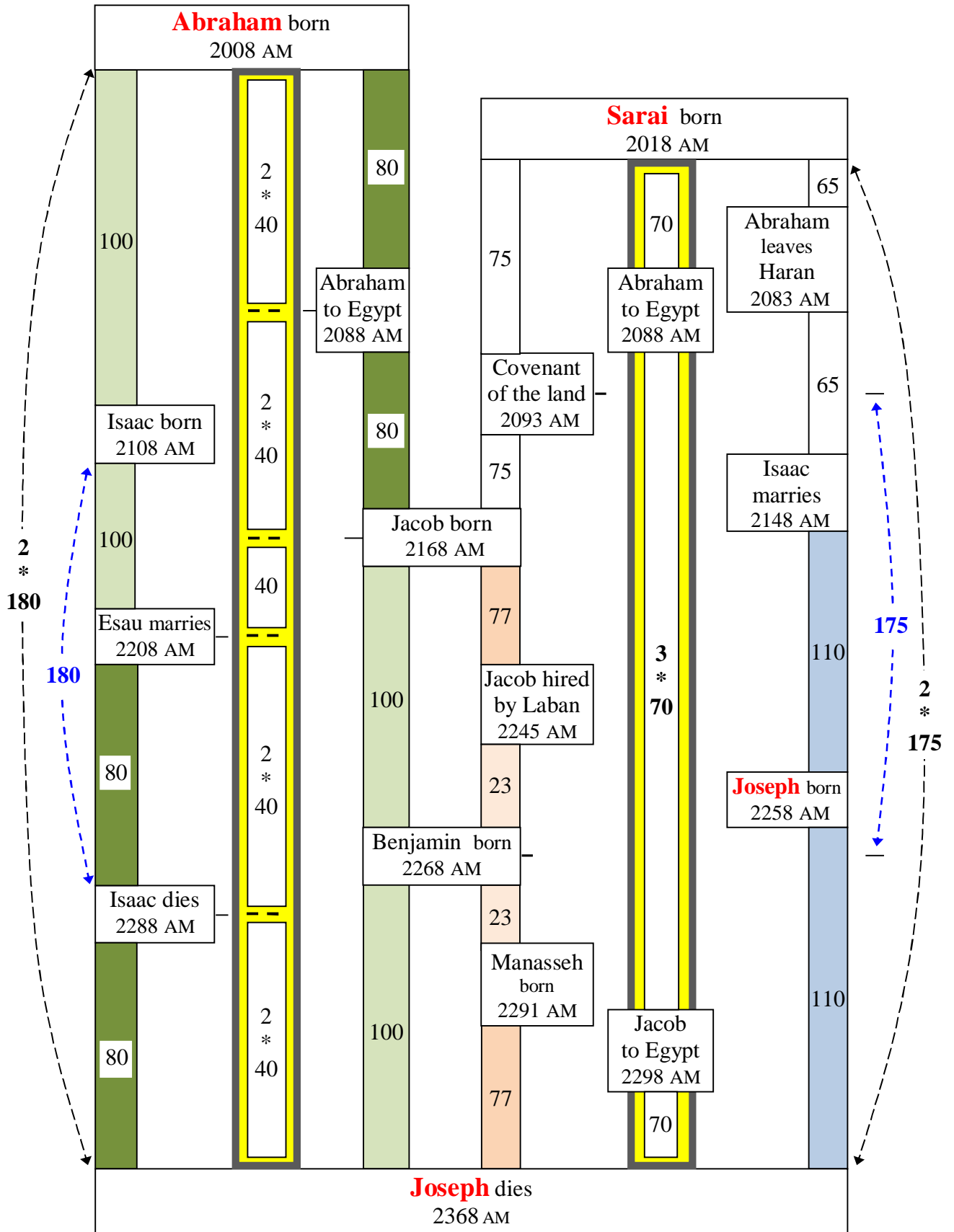

→ Was Yeshua's ministry first year (3989 AM) a jubilee year?

To answer this question we first need to examine how the sabbatical cycle is integrated in the chronology.

After the Israelites came to the Promised Land (2563 AM) they went to war against all the kings of the land to conquer their territories. It took six years (see Land divided on page 18) before Joshua could divide the land between the tribes. This was done in year 2569 AM (2563 + 6) and in that year the Israelites started farming their new land. As we should know, the primary benefit of the sabbatical cycle¹⁰⁰ was to allow the land to rest for one year in every 7 years, therefore it is only logical to have the first sabbatical cycle to coincide with the time that the land was exploited for the first time (2569 AM) by the Israelites.

Conquest of the land						First sabbatical cycle						
Pro-mised land						Land divided						First sabbatical year
	2563 AM	2564	2565	2566	2567		2568	2569 AM	2570 AM	2571 AM	2572 AM	
						1 st year	2 nd	3 rd	4 th	5 th	6 th	7 th

So the first sabbatical year was 2575 AM and up to the time of Daniel's death a new one was observed every 7 years. Having God's 7,000 years Master Plan in mind, it is interesting to note that if we count the number of sabbatical cycles that was originally intended, that is to say if they hadn't been interrupted at Daniel's death in 2953 AM, we obtain a total of exactly 490 (or $7 * 70$) sabbatical years before the start of the 7th millennium.

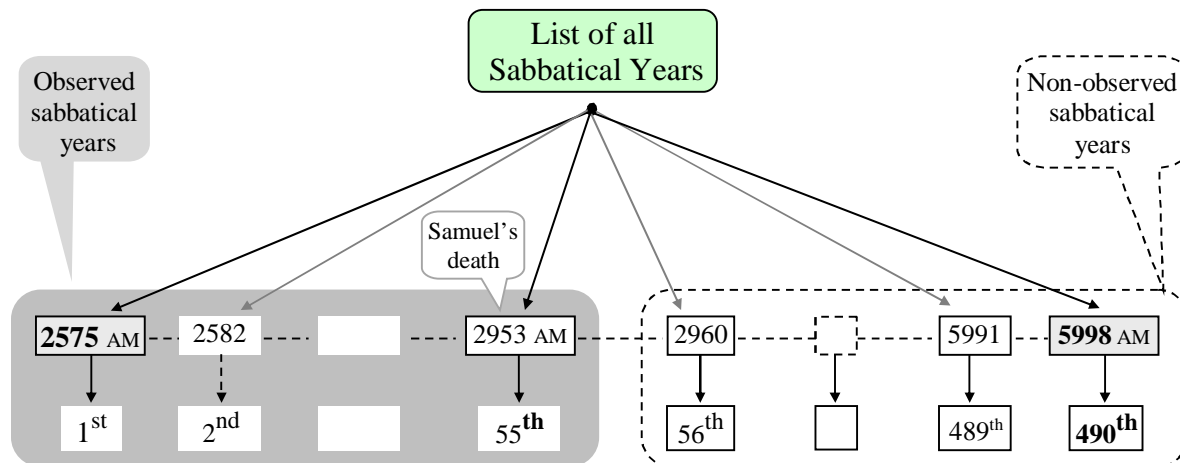

At the time they started the first sabbatical cycle the Israelites also began counting for the occurrence of a jubilee year¹⁰¹.

¹⁰⁰ Ex 23:10-11 "Six years you shall sow your land and gather in its produce, 11 but the seventh year you shall let it rest NKJV

¹⁰¹ This is the most logical time to start counting the Jubilee years. Both concepts are closely related.

The JUBILEE

Lev 25:8-10 And you shall count seven Sabbaths of years for yourself, seven times seven years; and the time of the seven Sabbaths of years shall be to you forty-nine years. Then you shall cause the trumpet of the Jubilee to sound on the tenth day of the seventh month; on the Day of Atonement you shall make the trumpet to sound throughout all your land. And you shall consecrate the fiftieth year,

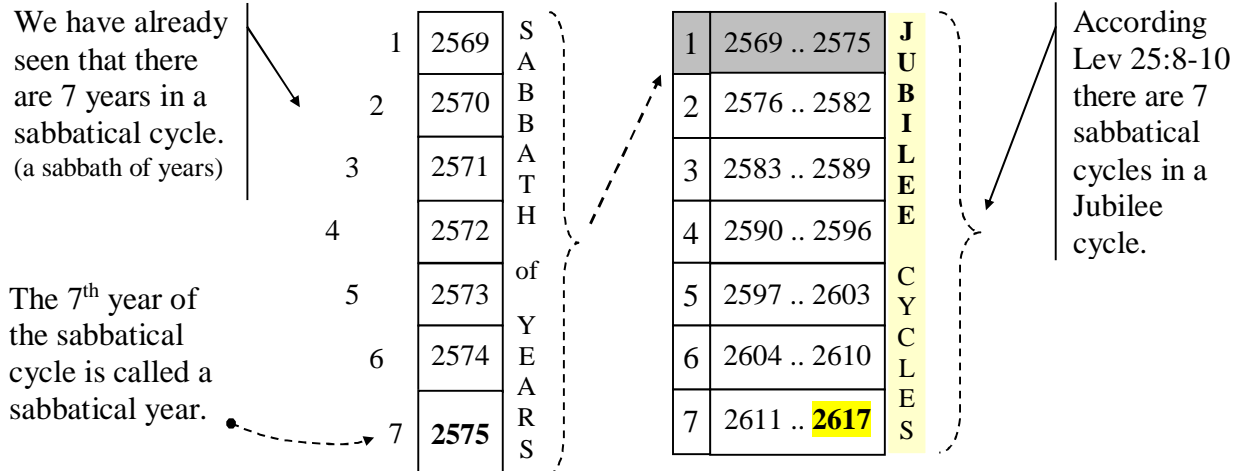

All in all there are 49 years in a jubilee cycle. Here is a layout of the very first jubilee cycle

Y1 2569 AM	Y8 2576	Y15 2583	Y22 2590	Y29 2597	Y36 2604	Y43 2611
Y2 2570	Y9 2577	Y16 2584	Y23 2591	Y30 2598	Y37 2605	Y44 2612
Y3 2571	Y10 2578	Y17 2585	Y24 2592	Y31 2599	Y38 2606	Y45 2613
Y4 2572	Y11 2579	Y18 2586	Y25 2593	Y32 2600	Y39 2607	Y46 2614
Y5 2573	Y12 2580	Y19 2587	Y26 2594	Y33 2601	Y40 2608	Y47 2615
Y6 2574	Y13 2581	Y20 2588	Y27 2595	Y34 2602	Y41 2609	Y48 2616
Y7 2575	Y14 2582	Y21 2589	Y28 2596	Y35 2603	Y42 2610	Y49 2617

When do we start the Jubilee year?

On the 10th day of the 7th month of the 49th year of the Jubilee cycle (Lev 25:8-10), the jubilee year would be consecrated. It means that the Jubilee year doesn't start at the very beginning of the 49th years of the Jubilee cycle. The 'jubilee year' starts only when the 7th month of the 49th year of the jubilee cycle is reached and ended on the 7th month of the next year (which is part of the next jubilee cycle).

First Jubilee							Second Jubilee					Third Jubilee		
2569	2570	2571	-	2615	2616	2617	2618	2619	-	2665	2666	2667	2668	-
1	2	3	-	47	48	49	1	2	-	48	49	1	2	-

The jubilee year starts on the 10th day of the 7th month of the 49th year

Ju
Y. 50

and ends in the 10th day of the 7th month of the 1st year

Ju
Y. 50

These overlapping 50th years are the consecrated years

--- 69 th Ju.			70 th Jubilee					7 th Millen- -nium	
-	5948	5949	5950	5951	-	5997	5998		5999
-	48	49	1	2	-	48	49		
			Ju Y. 50				Ju Y. 50		

The Jubilee year is also known as the **YOVEL** year. The name comes from the fact that on Yom Kippur of the fiftieth year, a yovel (ram's horn) is blown throughout the land to dedica-
this new jubilee year.



List of the 70 **Jubilee** years that will occur up to the Day of the Lord

Ju 1	2617- 2618	Ju 15	3303- 3304	Ju 29	3989- 3990	Ju 43	4675- 4676	Ju 57	5361- 5362
Ju 2	2666- 2667	Ju 16	3352- 3353	Ju 30	4038- 4039	Ju 44	4724- 4725	Ju 58	5410- 5411
Ju 3	2715- 2716	Ju 17	3401- 3402	Ju 31	4087- 4088	Ju 45	4773- 4774	Ju 59	5459- 5460
Ju 4	2764- 2765	Ju 18	3450- 3451	Ju 32	4136- 4137	Ju 46	4822- 4823	Ju 60	5508- 5509
Ju 5	2813- 2814	Ju 19	3499- 3500	Ju 33	4185- 4186	Ju 47	4871- 4872	Ju 61	5557- 5558
Ju 6	2862- 2863	Ju 20	3548- 3549	Ju 34	4234- 4235	Ju 48	4920- 4921	Ju 62	5606- 5607
Ju 7	2911- 2912	Ju 21	3597- 3598	Ju 35	4283- 4284	Ju 49	4969- 4970	Ju 63	5655- 5656
Ju 8	2960- 2961	Ju 22	3646- 3647	Ju 36	4332- 4333	Ju 50	5018- 5019	Ju 64	5704- 5705
Ju 9	3009- 3010	Ju 23	3695- 3696	Ju 37	4381- 4382	Ju 51	5067- 5068	Ju 65	5753- 5754
Ju 10	3058- 3059	Ju 24	3744- 3745	Ju 38	4430- 4431	Ju 52	5116- 5117	Ju 66	5802- 5803
Ju 11	3107- 3108	Ju 25	3793- 3794	Ju 39	4479- 4480	Ju 53	5165- 5166	Ju 67	5851- 5852
Ju 12	3156- 3157	Ju 26	3842- 3843	Ju 40	4528- 4529	Ju 54	5214- 5215	Ju 68	5900- 5901
Ju 13	3205- 3206	Ju 27	3891- 3892	Ju 41	4577- 4578	Ju 55	5263- 5264	Ju 69	5949- 5950
Ju 14	3254- 3255	Ju 28	3940- 3941	Ju 42	4626- 4627	Ju 56	5312- 5313	Ju 70	5998- 5999

NOTICE: Yeshua died in 3993 AM at age 33 (born in 3960 AM), therefore he was 29 years old when he announced the 29th jubilee in the 7th month of 3989 AM. See next few pages for a convincing proof that Yeshua's ministry lasted 4 years.

→ Did Yeshua's ministry last 4 years?

In the absence of any explicit Bible's references to confirm a 4-year ministry we could try to build a limited timeline that would include each action performed by Yeshua and his apostles and see how things add up. However, it is quite possible that this information has already been supplied but in a symbolic way. Here are **7 points** directly and indirectly related to Yeshua in which the number '4' is linked to a notion of 'duration'.

1st clue 4 days in the Temple

At age 12 Yeshua spent 4 days in the Temple:

- Luke 2:44 Thinking he was in their company, they traveled on for a day.
- Luke 2:46 After three days they found him in the temple courts

The 4 days in the Temple could mirror a future 4-year ministry.

2nd clue wait four years for the fruit

- Luke 13:6-9 "A man had a fig tree, planted in his vineyard, and he went to look for fruit on it, but did not find any. So he said to the man who took care of the vineyard, **'For three years** now I've been coming to look for fruit on this fig tree and haven't found any. Cut it down! Why should it use up the soil?' "'Sir,' the man replied, 'leave it alone **for one more year**, and I'll dig around it and fertilize it. If it bears fruit next year, fine! If not, then cut it down.'"

The man who took care of the vineyard was allowed a total of 4 years. Wasn't Yeshua taking care of Israel during his ministry? Could he have been given a fourth year too?

3rd clue Passover lamb chosen 4 days before

Yeshua's crucifixion can be equated to the killing of the Passover lamb.

Yeshua was described as a lamb:

- John 1:29 The next day John saw Jesus coming toward him, and said, "Behold! The Lamb of God who takes away the sin of the world! NKJV
- Isa 53:7 He was oppressed and He was afflicted, Yet He opened not His mouth; He was led as a lamb to the slaughter, And as a sheep before its shearers is silent, So He opened not His mouth. NKJV

The Passover lamb had to be without a fault:

- Ex 12:5 Your lamb shall be without blemish NKJV

Yeshua was also without a fault:

- Luke 23:4 So Pilate said to the chief priests and the crowd, "I find no fault in this Man." NKJV

- 1 Peter 1:19 but with the precious blood of Christ, as of a lamb without blemish and without spot. NKJV
- 2 Cor 5:21 For He made Him who knew no sin to be sin for us, NKJV
- John 8:46 Which of you convicts Me of sin? And if I tell the truth, why do you not believe Me? NKJV

The Passover lamb was **chosen** 4 days before being killed:

- Ex 12:3 'On the tenth day of this month every man shall take for himself a lamb,
- Ex 12:6 Now you shall keep it until the fourteenth day of the same month. Then the whole assembly of the congregation of Israel shall kill it at twilight. NKJV

Could a four-year ministry parallel the last four days of the Passover lamb?

If Yeshua's ministry lasted four years, it would perfectly match the four days during which the blemishless lamb had been known and expressly kept to become the Passover lamb.

4th clue

Timing of the of the jubilee year

At the beginning of his ministry, Yeshua

- was baptized
- spent 40 days in the desert
- spent some time teaching in the various synagogues around.

And then Yeshua announced the jubilee:

- Luke 4:18-21 "The Spirit of the Lord is on me, because he has anointed me to preach good news to the poor. He has sent me to proclaim freedom for the prisoners and recovery of sight for the blind, to release the oppressed, to proclaim the year of the Lord's favor." Then he rolled up the scroll, gave it back to the attendant and sat down. The eyes of everyone in the synagogue were fastened on him, and he began by saying to them, "**Today** this scripture is fulfilled in your hearing."

The text that Yeshua read in the synagogue was a description of **a jubilee year** and at the end of his reading, he told everybody **that what he had just read was happening on that very day**. We even know the date of that day:



- Lev 25:9-10 Then have the trumpet sounded everywhere on the tenth day of the seventh month; on the Day of Atonement sound the trumpet throughout your land. Consecrate the fiftieth year and proclaim liberty throughout the land to all its inhabitants.

At no other time would it have been more appropriate to announce a jubilee than at the start of a ministry that would bring the same kind of relief as was expected during a jubilee year. See the following report that was transmitted to John the Baptist later on:

- Matt 11:4-6 Jesus answered and said to them, "Go and tell John the things which you hear and see: The blind see and the lame walk; the lepers are cleansed and the deaf hear; the dead are raised up and the poor have the gospel preached to them. NKJV

According to the timeline given in Appendix E on page 257, Yeshua died in 3993 AM. If the ministry lasted four years, as we are trying to demonstrate, it had to start at 3989 AM. Was 3989 AM a jubilee year? Absolutely. See list of jubilee years on page 151.

There was a jubilee year starting in the 7th month of 3989 AM.

3989 AM			3990 AM		
M1	M7D10	M12 13	M1	M7D10	M12 13
					
49 th year of a 49-year cycle			First year of the next 49-year cycle		
<div style="border: 1px solid black; padding: 5px; width: fit-content; margin: auto;"> <p>Jubilee year #29 It is also called the fiftieth year in Lev 25:8-10</p> </div>					

It is quite possible that, contrary to the popular belief, the very start of Yeshua's ministry coincides with the proclamation of the Jubilee year.

M = month
D = day

We saw earlier that a jubilee starts in the 7th month of the 7th year of the 7th sabbatical cycle and terminates in the 7th month of the first year of the next cycle. (See page 151)

5th clue Four months before the harvest

- John 4:35 Do you not say, '**Four months more and then the harvest**'? I tell you, open your eyes and look at the fields! **They are ripe for harvest.**

A careful review of John indicates that the timing of John 4:35 could be a few weeks after the first Passover of Yeshua's ministry which was held in the first month (M1) of **3990 AM**:

- John 2:13 When it was almost time for the Jewish Passover, Jesus went up to Jerusalem.

There were four Passovers (**P1, P2, P3, P4**) during Yeshua's ministry (if it lasted 4 years as assumed by the author).

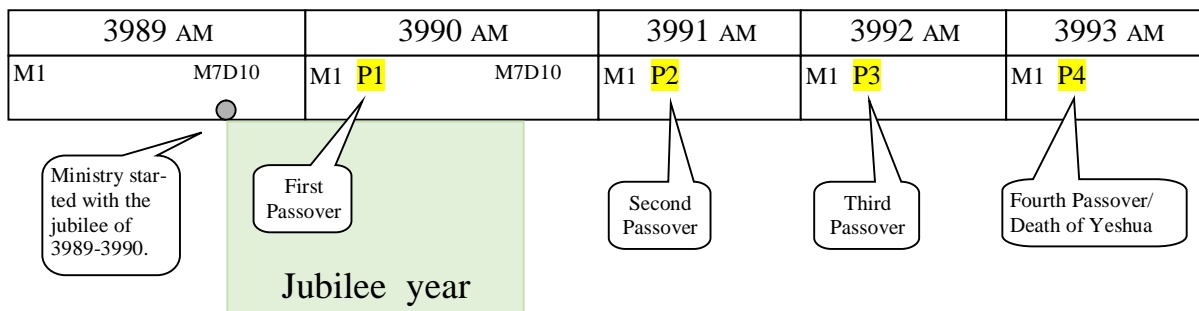

In John 4:35-38 Yeshua is telling his disciples that the fields are ready to be harvested (spring harvest) but people say “**four months more and then the harvest**”.

Why would the people wait 4 months if those fields were ready to be harvested? Why would it be a saying? Four months after the spring brings us into the fall, the fact that it was a saying could only mean that those circumstances had been encountered in the past and they would happen again in the future.

There is only one possible explanation here. At the time Yeshua was talking, during the spring of 3990 AM, there was still 4 months to wait for the end of the current jubilee year and this is why the people were not harvesting even though the crop was ready. (It would have been unlawful to do so.)

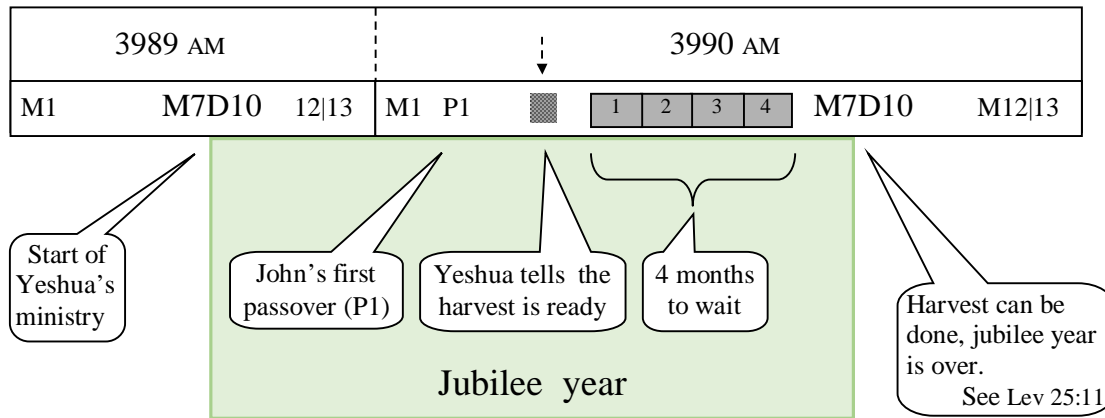

6th clue Queen Esther wait four days before going to the king uninvited

There are strong similarities between Yeshua’s ministry and what can be seen to some extent as Queen Esther’s 4-day ministry.

Here I specifically point to the 4-day period during which Queen Ester held a three days’ fast with all the Jews of Susa and then presented herself, uninvited, to the King and ended-up by pleading for her own safety. Note that by imploring the king to save the only life he cared for, the life of his queen, Esther brilliantly fought for the fate of all the Jews.

Queen Esther

4-day ministry

- Est 4:16 Go, gather all the Jews who are present in Shushan, and fast for me; neither eat nor drink for **three days**, night or day.
- Est 5:2 So it was, when the king saw Queen Esther standing in the court, that she found favor in his sight, and the king held out to Esther the golden scepter that was in his hand.
- Est 5:8 then let the king and Haman come to the banquet which I will prepare for them, and **tomorrow** I will do as the king has said."
- Est 7:2 And on the second day, at the banquet of wine, the king again said to Esther, "What is your petition, Queen Esther?"
- Est 7:3 O king, and if it pleases the king, let my life be given me at my petition, and my people at my request.

The parallel between Yeshua's ministry and Esther's ministry come in several levels.

Both individuals face violent death twice.

(In each case a king was involved)

Esther could have died when she presented herself to the King uninvited.

- Est 4:11 All the king's servants and the people of the king's provinces know that any man or woman who goes into the inner court to the king, who has not been called, he has but one law: put all to death,

As a Jewish she was also targeted by Haman's planned genocide.

- Est 3:8-9 Then Haman said to King Ahasuerus, "There is a certain people scattered and dispersed among the people in all the provinces of your kingdom; ... If it pleases the king, let a decree be written that they be destroyed,

Note: The date of the genocide was obtained **by casting lots.**

Yeshua was directly targeted when Herod had all the children under two killed.

- Matt 2:13 Now when they had departed, behold, an angel of the Lord appeared to Joseph in a dream, saying, "Arise, take the young Child and His mother, flee to Egypt, and stay there until I bring you word; for Herod will seek the young Child to destroy Him.

Yeshua was crucified.

- Mark 15:22-24 And they brought Him to the place Golgotha, And when they crucified Him,

Note: The distribution of Yeshua's garments was decided **by casting lots**
(Ref Mark 15:24)

Both started their ministry with an unusual fast.

Esther unexpectedly fasted during three days before meeting the King. Notice that by doing so, her appearance was likely to repel the King when he saw her.

- Est 4:16 Go, gather all the Jews who are present in Shushan, and fast for me; neither eat nor drink for three days, night or day. My maids and I will fast likewise.

Yeshua when 40 days in the desert

- Matt 4:1-2 Then Jesus was led up by the Spirit into the wilderness to be tempted by the devil. And when He had fasted forty days and forty nights, afterward He was hungry.

Both offer their lives to save a multitude

- Est 4:8-9 that he [the king's eunuchs] might command her [Esther] to go in to the king to make supplication to him and plead before him for her people.
- John 10:11 I am the good shepherd. The good shepherd gives His life for the sheep.

Each ministry happens to be the most critical period of the life of its author.

- ⇒ Esther's 4-day period is unquestionably the turning point of her story, up to that point she saw the rise of Haman and the introduction of a decree to annihilate most of the Jews, but after that she saw Haman lose everything, including his life, and the Jews were saved.
- ⇒ The purpose of Yeshua's ministry was to reveal the good news of the Kingdom of God. No other prophets had ever delivered a more important message.

7th clue

The last four years of Absalom

The last 4 years of Absalom are a TYPE of Yeshua's ministry

In the case of Absalom the four years started when he received the authorization from his father (King David) to leave his own house in Jerusalem and circulate in the city:

- 2 Sam 14:33 Then the king summoned Absalom, and he came in and bowed down with his face to the ground before the king. And the king kissed Absalom. NIV

And it ended when Absalom tried to usurp the crown and replace his father on the throne:

- 2 Sam 15:7 At the end of four years, Absalom said to the king, NIV

Here are 7 points showing that a parallel can be established between Absalom and Yeshua.

- ▶ P1 ◀ The last 4 years in each man's life started with freedom.
Absalom: At first Absalom was confined¹⁰² to his own house and was not allowed to see his father: See 2 Sam 14:24
Then he recovered his freedom and was allowed to see his father during the last 4 years of his life. See 2 Sam 15:7
Yeshua: At the start of his 4 year ministry Yeshua **declared a jubilee year** (freedom) : See Luke 4:16-18
- ▶ P2 ◀ Each man had an opposite way to resolve conflicts.
Absalom was seeking justice: See 2 Sam 15:4
Yeshua was promoting 'forgiveness' See Luke 6:37
- ▶ P3 ◀ The king's son and God's son were both impaled by the spear of a soldier while hanging on a tree.
Absalom was impaled by Joab. See 2 Sam 18:14
Note Joab was a soldier: 1 Chron 27:34
Yeshua was impaled by a soldier. See John 19:34
Note: There are many facts that tend to prove that Yeshua was crucified on a tree.
- ▶ P4 ◀ The king's son and God's son died with a crown on the head.
Absalom See 2 Sam 18:9
Yeshua See Matt 27:29

¹⁰² The fact that Absalom was confined to his own house is not in doubt. It was in response to a specific order [let him return to his own house] from the king. Also notice that Absalom sent his servant twice to ask Joab to come to see him. Why didn't Absalom go to see Joab himself given that they were close neighbors:

2 Sam 14:29 And when he sent again the second time, he would not come. NKJV

2 Sam 14:30 So he said to his servants, "See, Joab's field is near mine, NKJV

And how can we explain that Absalom would have been better if he had stayed in Geshur unless he was free to move around in Geshur:

2 Sam 14:32 "Why have I come from Geshur? It would be better for me to be there still." NKJV

► P5 ◀ Each man's death was followed by a loud sound.

Absalom See 2 Sam 18:16
Yeshua See Mark 15:38-39, Matt 27:51

► P6 ◀ The king's son and God's son were buried beneath a rock.

Absalom See 2 Sam 18:17
Yeshua See Matt 27:59-60

► P7 ◀ Following each death the people hurried home.

After Absalom's death See 2 Sam 18:17
After Yeshua's death See Luke 23:54,56

The previous 7 clues strongly suggest that Yeshua's ministry lasted 4 years.

Can we connect the death of Yeshua and the destruction of the second Temple?

Yeshua predicted that soon the Temple would not be needed to worship the Father

- John 4:21 Jesus declared, "Believe me, woman, a time is coming when you will worship the Father neither on this mountain nor in Jerusalem.

Yeshua associate his death with the end of something. Notice that the Temple's veil was torn in two at the time of his death.

- John 19:30 Jesus said, "It is finished." With that, he bowed his head and gave up his spirit.
- Matt 27:51 At that moment the curtain of the temple was torn in two from top to bottom. The earth shook and the rocks split.

The Jewish Talmud says that 40 years before the Temple was destroyed the gates of the temple opened by themselves, until Rabbi Yohanan B. Zakkai rebuked them (i.e., the gates) saying, "Hekel, Hekel, why do you alarm us? We know that you are destined to be destroyed" (Yoma 39b).

- Zech 11:1 Open your doors, O Lebanon, so that fire may devour your cedars!

Josephus - Moreover, the eastern gate of the inner, [court of the temple,] which was of brass, and vastly heavy, and had been with difficulty shut by twenty men, and rested upon a basis armed with iron, and had bolts fastened very deep into the firm floor, which was there made of one entire stone, was seen to be opened of its own accord about the sixth hour of the night. (Josephus, *The Wars of the Jews*, IV: iv, 3)

This
happened
every
day
for
40 years

Both the tearing of the veil and the opening of the gates symbolize the same fact: the Temple had become **redundant**. Therefore it is logical to deduce that both events happened the same year, i.e. the year of Yeshua's death. **The '40 years' supplied by the Talmud represents the period between the death of Yeshua and the destruction of the second Temple.** (the Temple was burned down by the Romans)

Can there be any doubts left?

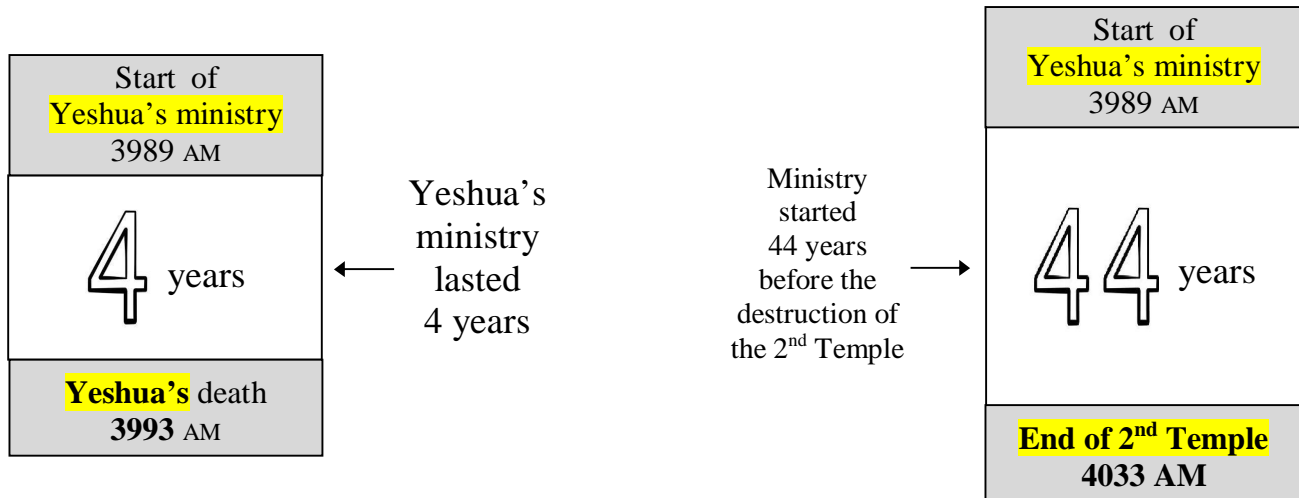

Year	Yeshua's ministry started in the 7 th month of 3389 AM and ended in the 1 st month of 3993 AM. The ministry lasted exactly 44 months.				# of months	Total # of months
3989 AM	M1-	M2-	M3-	M4-	6	44 Months
	M5-	M6-	M7-Thisri	M8-Mach..		
	M9-Kislev	M10-Tevet	M11-Shevat	M12-Adar I		
	M13-Adar2					
3990 AM	M1-Nissan	M2-Lyar	M3-Sivan	M4-Tammuz	12	
	M5-Mena	M6-Elul	M7-Thisri	M8-Mach..		
	M9-Kislev	M10-Tevet	M11-Shevat	M12-Adar I		
3991 AM	M1-Nissan	M2-Lyar	M3-Sivan	M4-Tammuz	13	
	M5-Mena	M6-Elul	M7-Thisri	M8-Mach..		
	M9-Kislev	M10-Tevet	M11-Shevat	M12-Adar I		
	M13-Adar2					
3992 AM	M1-Nissan	M2-Lyar	M3-Sivan	M4-Tammuz	12	
	M5-Mena	M6-Elul	M7-Thisri	M8-Mach..		
	M9-Kislev	M10-Tevet	M11-Shevat	M12-Adar I		
3993 AM	M1-Nissan				1	

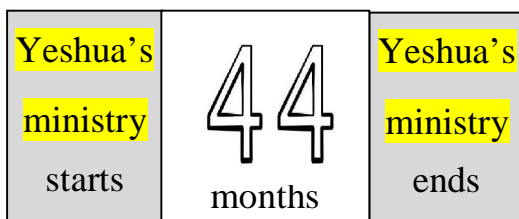

Ex 12:3 on the tenth day of this month each man is to take a lamb for his family

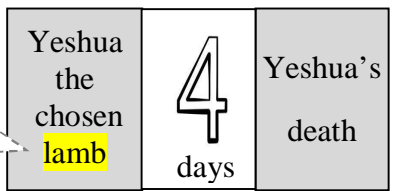

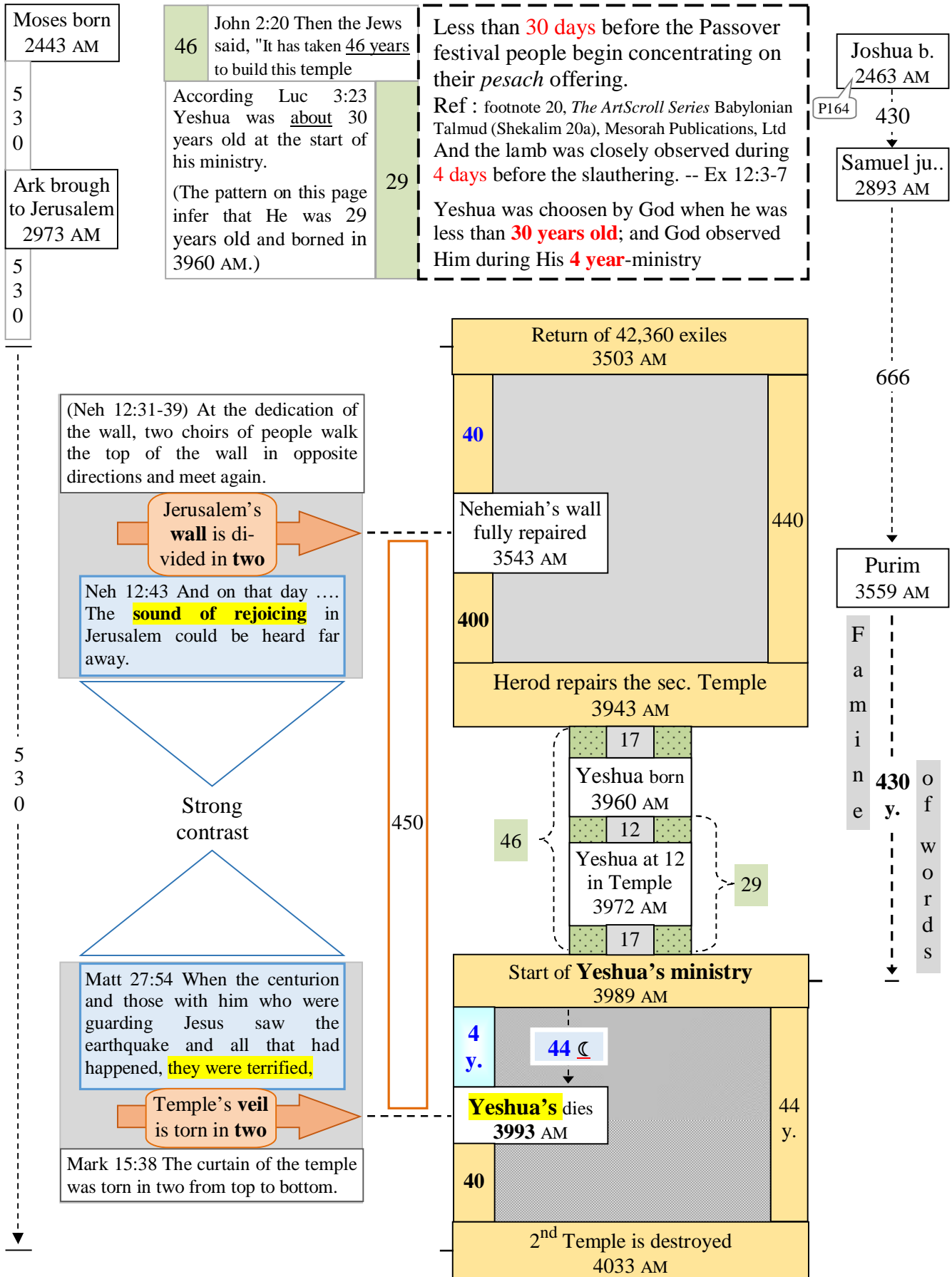



Exceptionnally in this page, two new units of time are used to represent the period between two events. They are the number of **New moon ☾** or the number of **days ☼**.

There are 29.530588 days between two ☾, there are 365.242188 ☼ in a year. For instance we know that Exodus occurred at Passover of 2523 AM and Yeshua died at Passover of 3993 AM. Using an Astronomical software we obtain 18,181 New moon between these two events. This can be demonstrated Grosso modo the following way :
 $3993 - 2523 = 1470$ years
 $1470 * 365.242188 = 536,906$ ☼
 $536,906 / 29.530588 = 18,181$ ☾

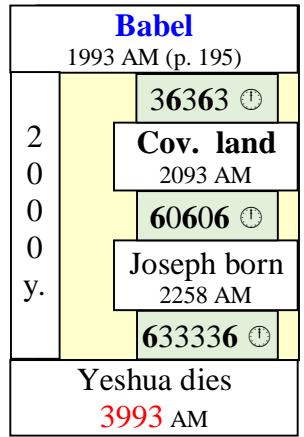

See p.190 for Babel in 1993 AM

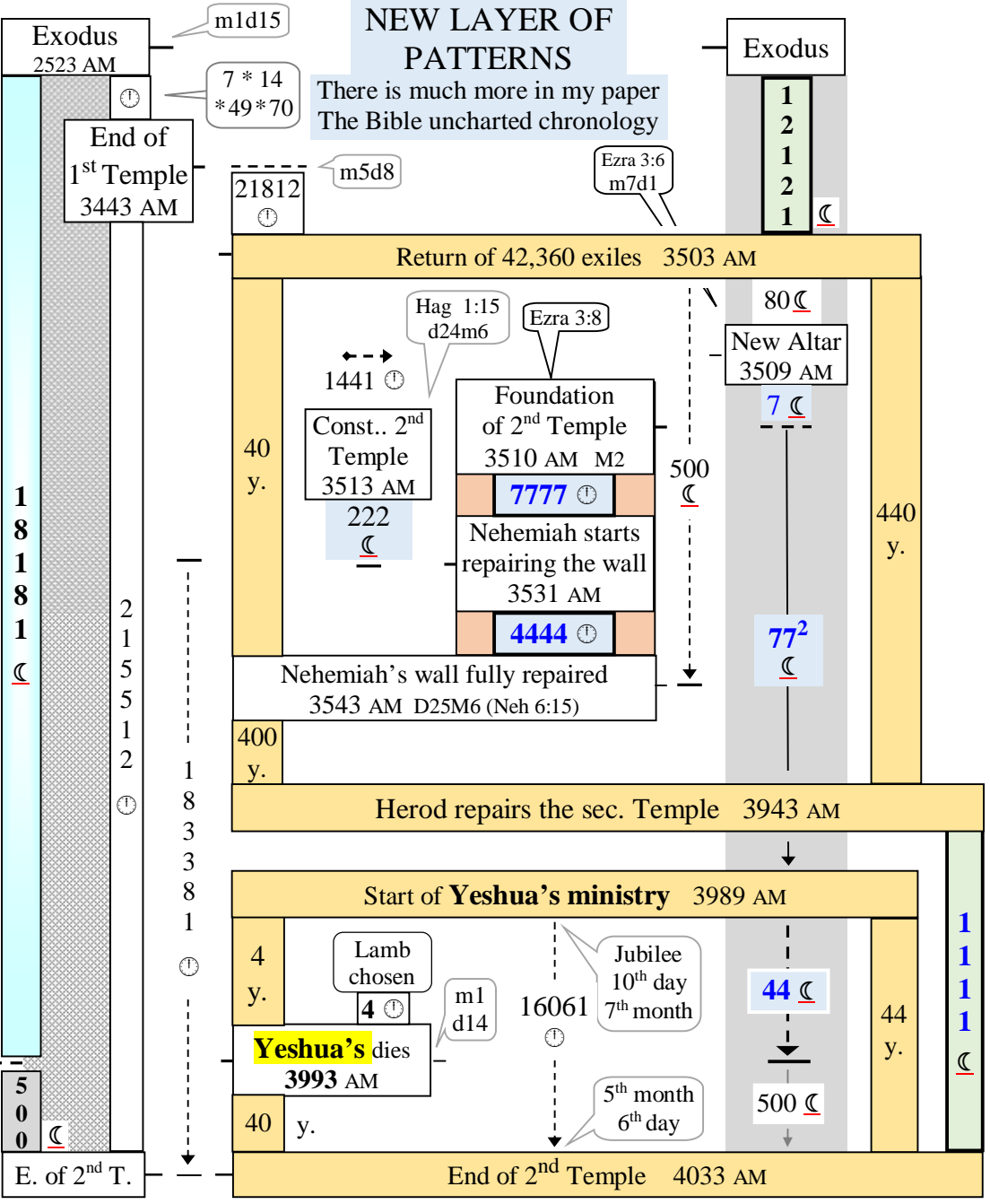

→ Where does Joshua fit into this chronology?

The following reference will lead us to the answer:

- Acts 13:17-20 The God of the people of Israel **chose our fathers**; he made the people prosper during their stay in Egypt, ... he overthrew seven nations in Canaan and gave their land to his people as their inheritance. All this took about 450 years.
"After this, God gave them judges until the time of Samuel the prophet. NIV

Here Paul singles out '[God] chose our fathers'¹⁰³ as the event that starts his 450-year time span. And even though he doesn't tell us what event brought the period to a close he informs us that it happened shortly before the beginning of the Judges' period. But what does it mean 'to choose the fathers'? Were those fathers chosen together and who were they? According to Act 13:16 the fathers were chosen before the Israelites went to Egypt. This brings us back to the time of the three patriarchs: Abraham, Isaac and Jacob.

Let's suppose that Paul implied that the fathers were chosen as the result¹⁰⁴ of an action they had performed. Already, from that premise, we can exclude Jacob from any group chosen. Elsewhere it is clearly written that Jacob's destiny was settled even before he was born:

- Gen 25:23 And the LORD said to her: "Two nations are in your womb, Two peoples shall be separated from your body; One people shall be stronger than the other, And the older shall serve the younger." NKJV

This leaves only Abraham and Isaac in the role of the chosen fathers.

Our fathers were chosen¹⁰⁵ at the sacrifice (Akedah) of Isaac!

Nothing more difficult to accept could have been asked to Abraham but he didn't hesitate:

- Gen 22:2 Take your son, your only son, Isaac, whom you love,
- Gen 22:3 Early the next morning Abraham got up and saddled his donkey.

Isaac offered no resistance and it should be credited as faith.

Isaac learned at the last minute he would be the sacrifice and he hardly had any time to meditate on the situation. Thus, his reaction had to come from an inner conviction that whatever his father requested from him was the right thing to do.

- Gen 22:7 "The fire and wood are here," Isaac said, "but where is the lamb for the burnt offering?"

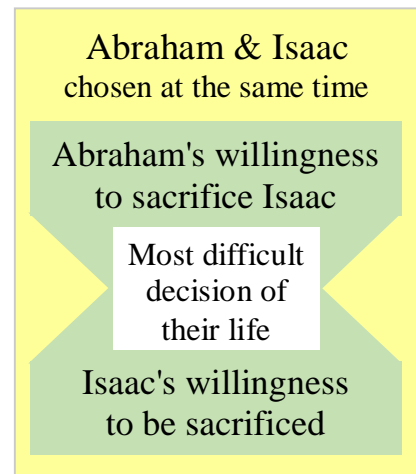

¹⁰³ Plural form, more than one father was chosen.

¹⁰⁴ If it were not the case why would they have been chosen in the first place?

¹⁰⁵ The expression 'The God of the people of Israel chose our fathers' does convey the idea that the 'choosing' was done following some actions of the 'fathers'. Also, given that Paul used this 'choosing' as the start of the 450 years we can deduce that the fathers' actions were done at the same time.

Isaac was not under restraint from anybody; he was alone with his father:

- Gen 22:5 Stay here with the donkey while I and the boy go over there.

The full consent of Isaac was mandatory. Abraham at 115 years old (2123 AM – 2008 AM) would never have been able to bind his 15 year-old son (2123 AM – 2108 AM) if this one had refused to fully cooperate. Isaac was a consenting victim here; he could have found an opportunity to run away but he didn't. On the contrary, he walked by himself to the altar:

- Gen 22:9 He bound his son Isaac and laid him on the altar, on top of the wood.

⇒ As a result God did **choose our fathers**:

- Gen 22:16-18 and said, "I swear by myself, declares the LORD, that because you have done this and have not withheld your son, your only son, I will surely bless you and make your descendants as numerous as the stars in the sky and as the sand on the seashore. Your descendants will take possession of the cities of their enemies, **and through your offspring all nations on earth will be blessed, because you have obeyed me.**"

Important: After this event neither Abraham nor Isaac were ever asked to prove their obedience again. No doubt the binding episode should be viewed as the most important event in both men's lives.

With the near certainty that the 450 year period of Act 13:20 started with the "binding of Isaac" in 2123 AM we can conclude that it ended at 2573 AM. This is 4 years after the land was divided by Joshua in 2569 AM and 10 years before the Gibeah event.

What happened in 2573 AM that could logically mark the end of the 450 year period?

According to Acts 13:16-20, at the end of the 450 years, the seven nations of Canaan had been conquered and the era of the Judges was soon to follow.

Joshua was chosen to lead the people to their inheritance:

- Josh 1:6-7 "Be strong and courageous, because you will lead these people to inherit the land I swore to their forefathers to give them.
- Josh 23:4-5 Remember how I have allotted as an inheritance for your tribes all the land of the nations that remain-the nations I conquered-between the Jordan and the Great Sea in the west.

The whole of the Exodus period is under the leadership of two individuals, Moses at **the beginning** and Joshua at **the end**. Therefore, it is quite reasonable to terminate the 450-year period with the death of Joshua (in 2573 AM).

Binding of Isaac 2123 AM Fathers chosen	450 years	Joshua ? dies ? inheritance received 2573 AM	450 years		Solomon was chosen 3023 AM	
	☆ Act 13:20 ▼		▼	Ark captured 2873 AM		▼
	3 * 150		2 * 150	Israel rejected		150

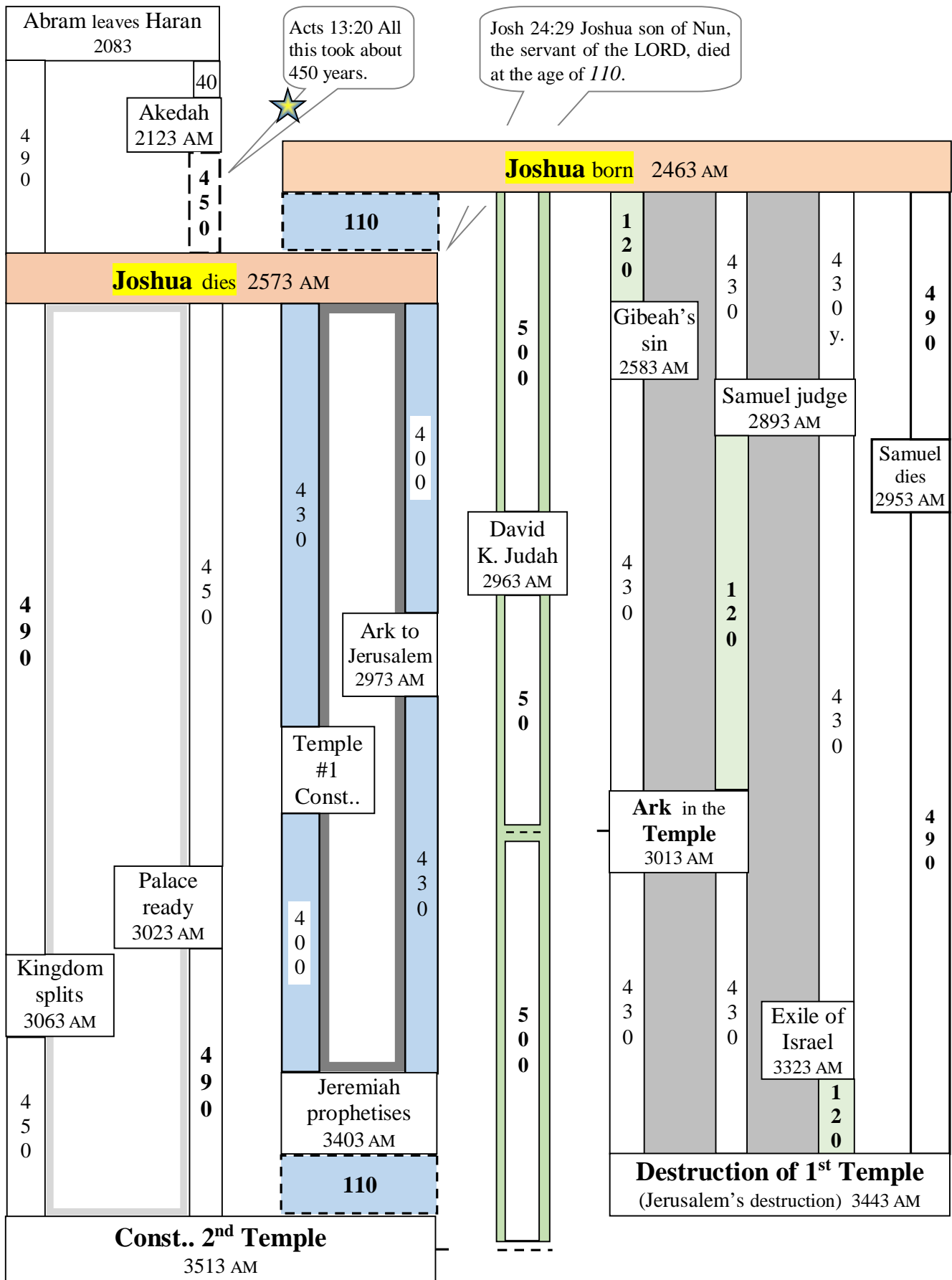

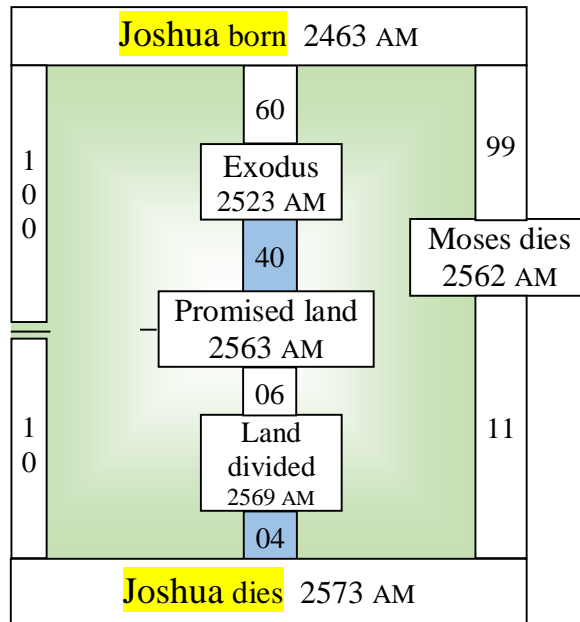

→ Figuring the chronology of the ‘oppressions and judges’ period

The first part of the ‘judges’ period’ includes all the oppressesions and all the judges from Cushan up to the end of the Philistine oppression¹⁰⁶. This period cannot have started before the death of Joshua in 2573 AM and neither can it have ended after the start of Samuel’s judgeship. The

maximum time span available to fit in all the judges (but Samuel) and oppressesions is therefore 320 years (2573 to 2893 AM).

Before figuring out the chronology of this period we have to find out if the sequence of judges and oppressesions could have overlapped somehow.

The following table shows, in sequence, each judge and each oppessor with the number of years they apparently lasted. The total obtained this way is 390 years.

Judge’s period (sequential layout)				
	Oppression		Judge	
Judge 3:8	Opp. Cushan	8		
Judge 3:11			Ju Othniel	40
Judge 3:14	Opp. Eglon	18		
Judge 3:30			Ju Ehud	80
Judge 4:3	Opp. Jabin	20		
Judge 5:31			Ju Deborah	40
Judge 6:1	Opp. Median	7		
Judge 8:28			Ju Gideon	40
Judge 9:22	Opp. Abimelech	3		
Judge 10:2			Ju Tola	23
Judge 10:3			Ju Jair	22
Judge 10:8	Opp. Ammon	18		
Judge 12:7			Ju Jephthah	6
Judge 12:9			Ju Ibzan	7
Judge 12:11			Ju Elon	10
Judge 12:14			Ju Abdon	8
Judge 13:1	Opp. Philistines	40		

114 + 276

We will see next page that this number is too high

Total years = 390

¹⁰⁶ Samuel’s judgeship started at the end of the Philistines’ 40 years of oppressesions.

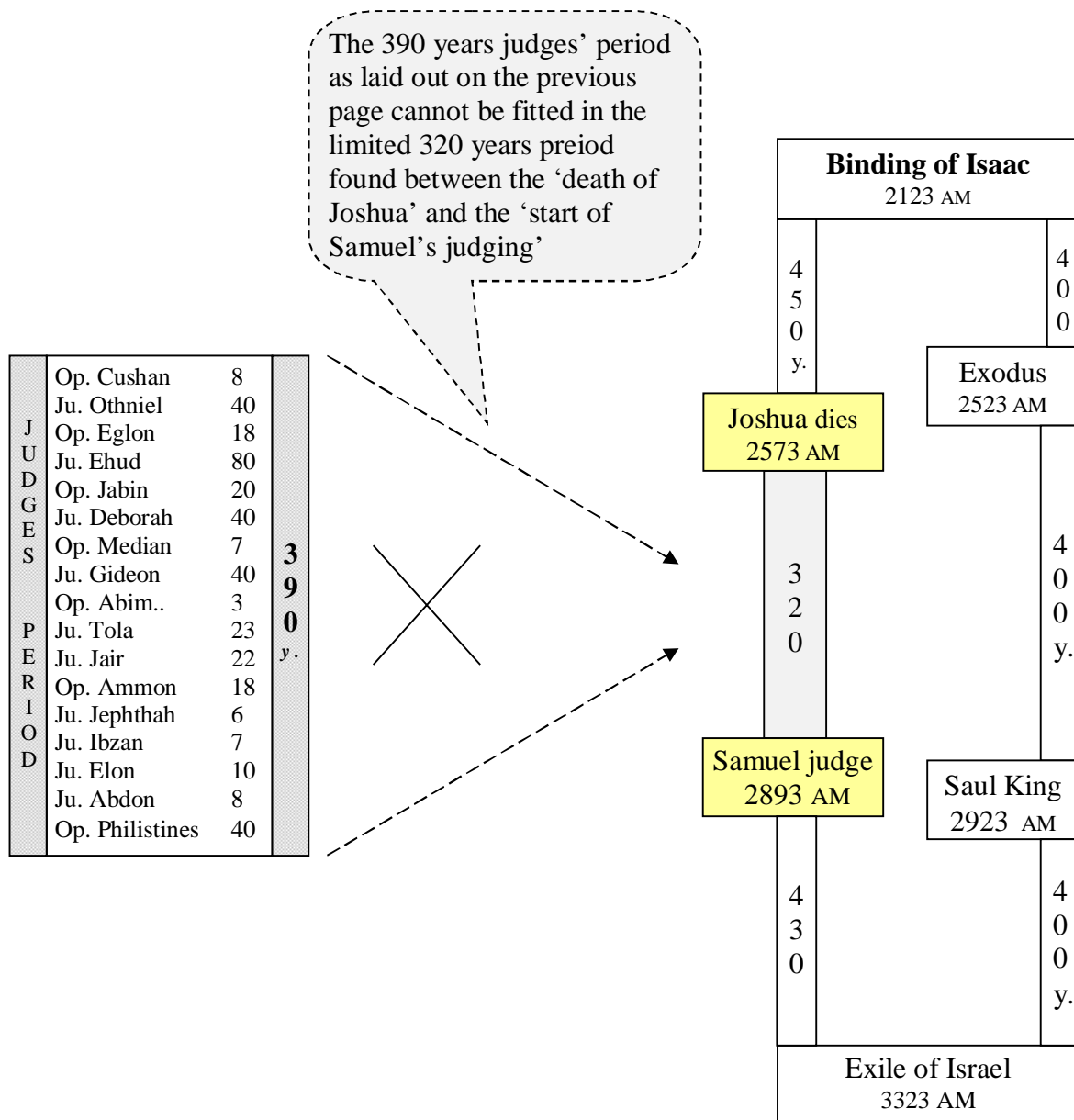

As it is clearly shown in the above figure, even if we start the oppression of Cushan the same year that Joshua died, there wouldn't be enough time to fit all the judges and all the oppressions before the start of Samuel's judgeship.

The 320 years between Joshua's death and the start of Samuel's judgeship cannot be increased. Therefore **the only way out** is to reduce the 390 year period previously obtained for the judges and oppressions. That can only be done by **overlapping** some and reducing the value of others. It may seem an impossible challenge given all the possibilities, but fortunately, as we will see, most of the judges and oppressions clearly didn't overlapped¹⁰⁷. Our first step to resolve this difficult puzzle is to find out when the Oppression of Cushan started. The following figure gives us a very strong indication that it was at 2593 AM.

¹⁰⁷ «it is decidedly contrary to the meaning of the book, to represent any two of the judges as ruling in different parts at the same time. At the commencement of each new section, it is always the nation collectively which is spoken of» Ref : John Kitto (1804-1854) *The Pictorial Bible*

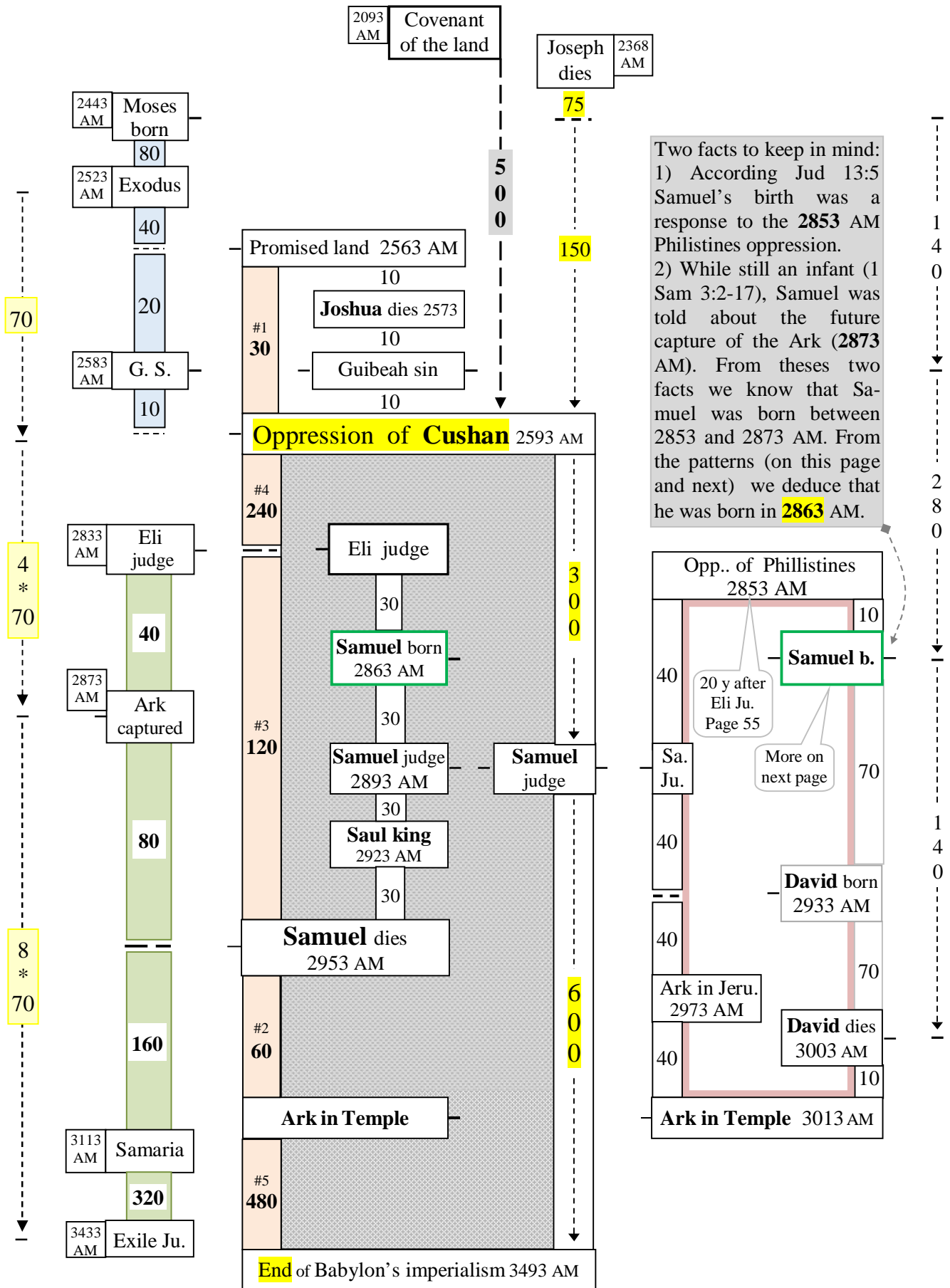

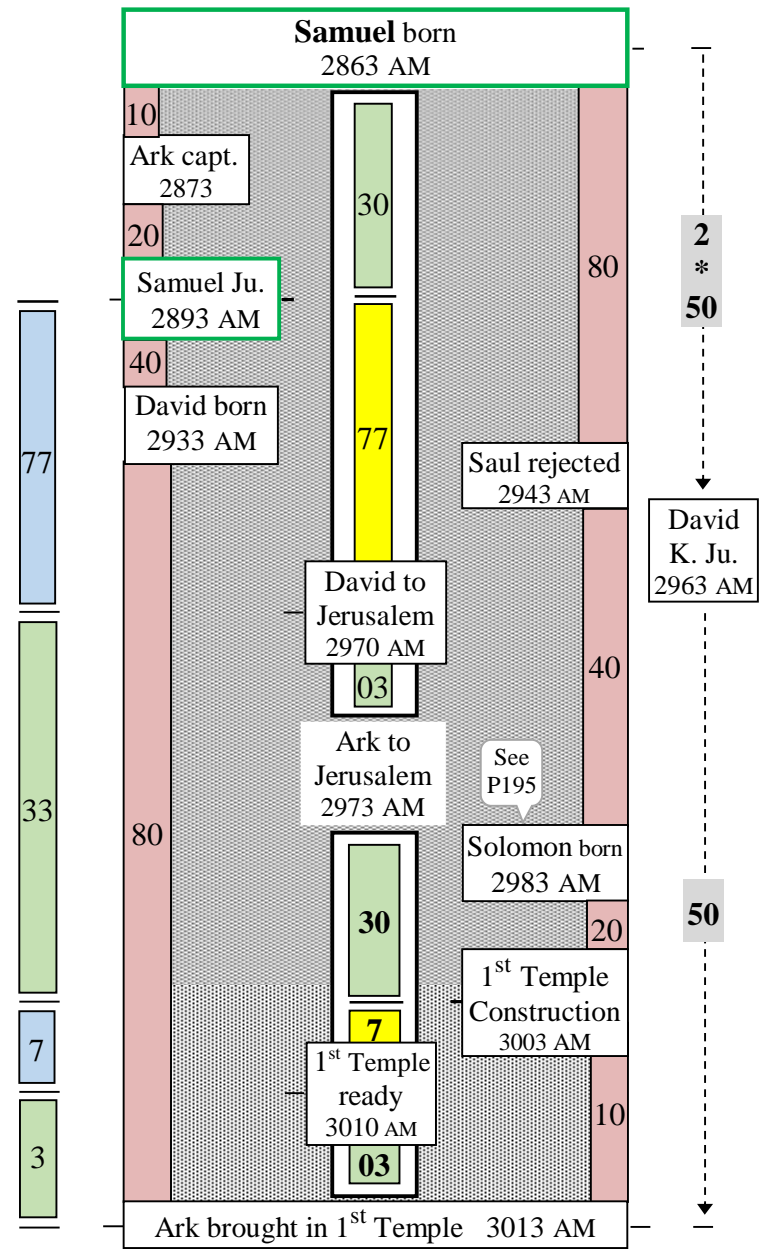
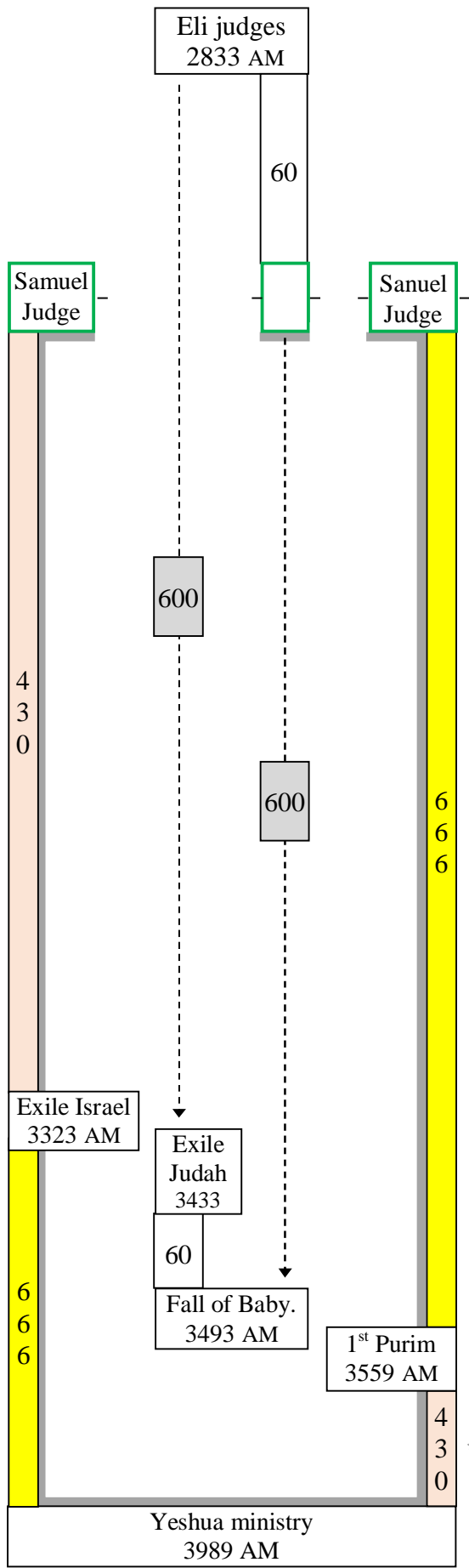

Ezekiel's 430-day famine of words symbolizes God's 430-year silence

The date of Jephthah's judgeship can be fixed.

After 18 years of oppression, Ammon claimed a part of Israel's territory pretending that it belonged to the Ammonites. Jephthah, a warrior, answered back that this territory had been under the control of Israel for the last 300 years:

- Judg 11:25-26 For **300 years** Israel occupied Heshbon, Aroer, the surrounding settlements and all the towns along the Arnon. Why didn't you retake them during that time?

If we can find out the origin of these 300 years we will be able to figure out the year that Jephthah became Judge.

The Bible tells us that the year Moses died (2562 AM), the territory around the Arnon was captured and given to the tribe of Reuben:

- Num 21:24 Israel, however, put him to the sword and took over his land from the Arnon to the Jabbok,
- Deut 2:36 From Aroer on the rim of the Arnon Gorge, and from the town in the gorge, even as far as Gilead, not one town was too strong for us. The LORD our God gave us all of them.
- Deut 3:16-17 But to the Reubenites and the Gadites I gave the territory extending from Gilead down to the Arnon Gorge (the middle of the gorge being the border) and out to the Jabbok River, which is the border of the Ammonites.

This territory of Reuben's is the same land that would be claimed by Ammon 300 years later, thus making Jephthah's judgeship start in 2862 AM (2562 + 300).

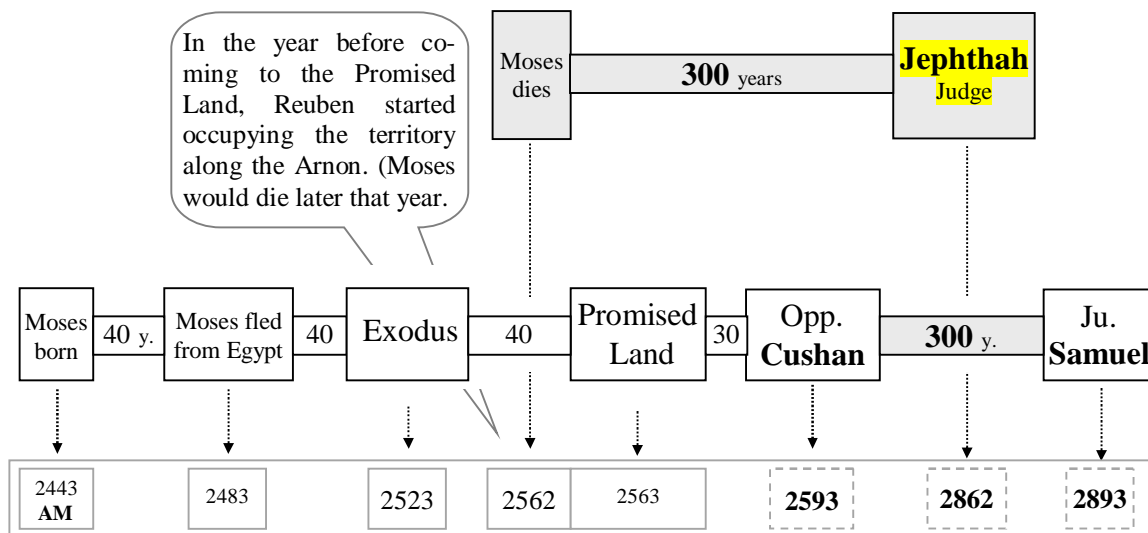

We now have three important dates to help us chart the chronology of the period of Oppressions and Judges. From those dates (2593, 2862, 2893) we are going to move forwards and backwards and lay down as many events as possible.

Judges conflicting chronology

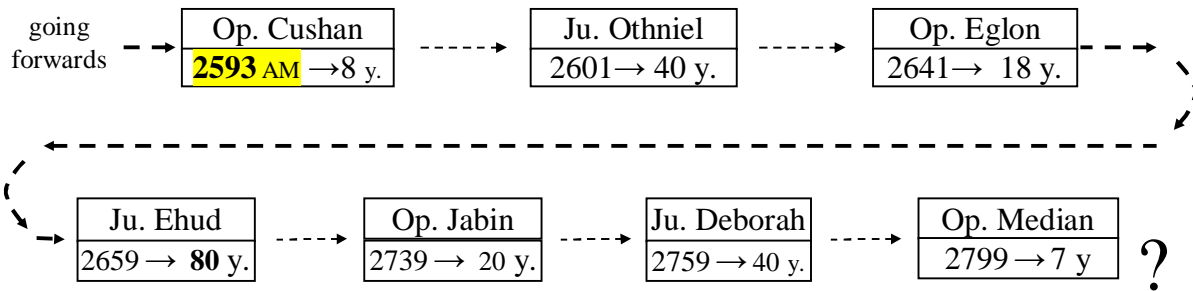

Problem :

The progression of the sequence of events at the top of this page, which goes forward from the Opp of Chushan, sets the

Opp of Median in 2799 AM

Median
in
2799 AM

???

Median
in
2749 AM

but then

it creates an obvious conflict with the sequence of events found at the bottom of this page which goes backwards from Samuel and sets the

Opp of Median in 2749 AM.

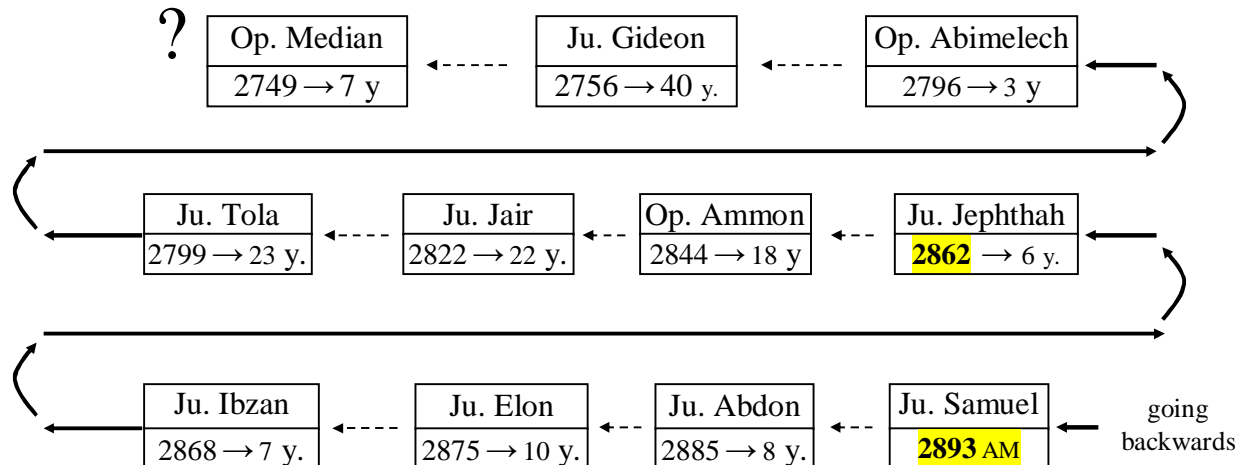

Judges **right** chronology

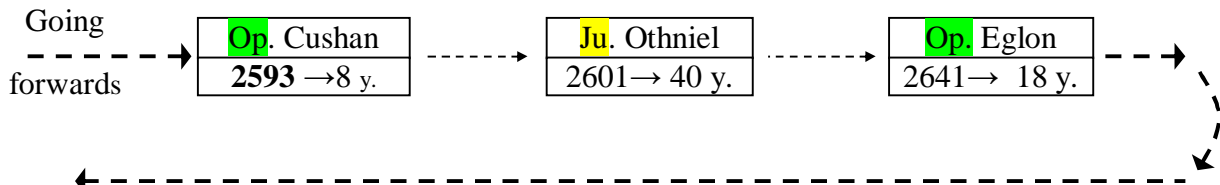

Solution

Part of the solution to harmonise the ‘forwards’ and the ‘backwards’ sequence is to recognize that the 80 years of Ehud is highly suspicious and could have been inflated as the result of a scribal error. (Notice that this number, 80, is twice the highest value, 40, reached by three other Judges). The suggested solution will reduce that value from 80 to 18 and will introduce a gap of 12 years at the end of Deborah’s 40-year judgeship.

It is worth noting that we could have tried to overlap the 80 years of Ehud with the judgeship of other Judges but this possibility has been rejected on the grounds that the Bible’s text doesn’t suggest any overlapping before the introduction of the double oppressions of Ammon and the Philistines.

- Judg 10:7 and He sold them into the hands of the Philistines and into the hands of the people of Ammon.

This solution may seem innocuous but, as you will discover in the following pages, it is going to transform the Judge’s period **inconsequential** sequence of numbers into a stunning series of pattern, imprinted by the Divine Finger.

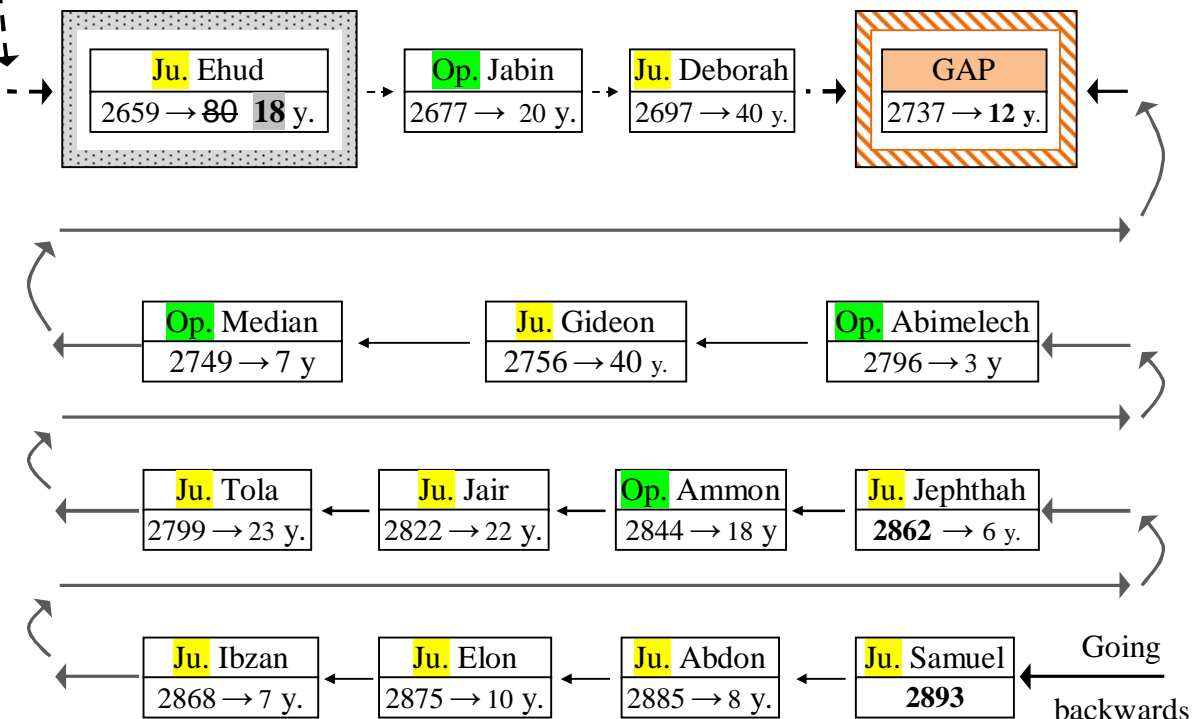

Judges' period

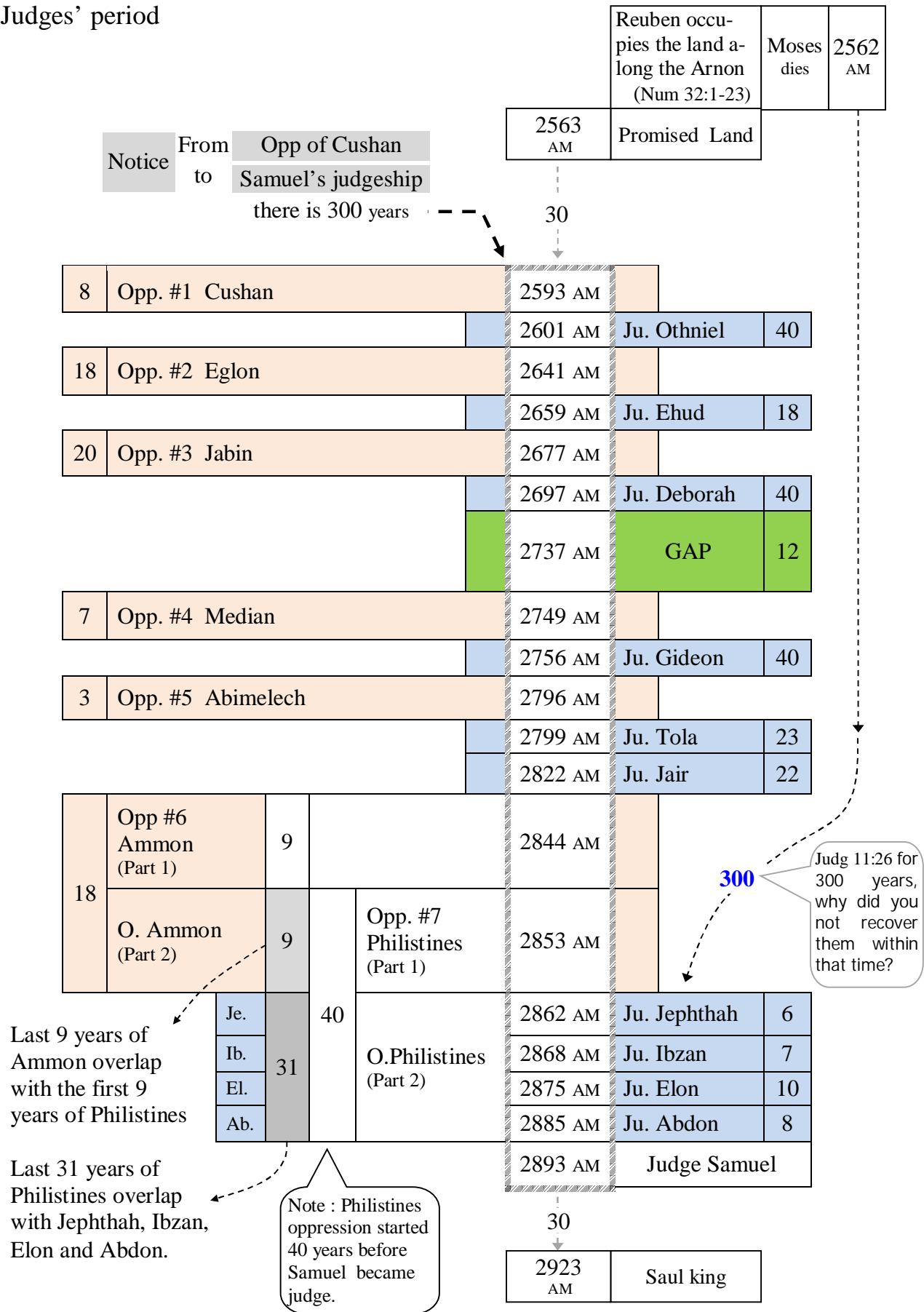

Judges's period (perfect setting & emergence of amazing patterns)

8	Opp. #1 Cushan		2593 AM			48	48				12 ²	
			2601 AM	Ju. Othniel	40							
18	Opp. #2 Eglon		2641 AM			47	2		1			
			2659 AM	Ju. Ehud	18	+	*	4				
20	Opp. #3 Jabin		2677 AM			49	48					
			2697 AM	Ju. Deborah	40							
			2737 AM	GAP		12					12	
7	Opp. #4 Median		2749 AM			47					300	
			2756 AM	Ju. Gideon	40							
3	Opp. #5 Abimelech		2796 AM			48						
			2799 AM	Ju. Tola	23							
			2822 AM	Ju. Jair	22							
18	9	Opp. #6 Ammon (P1)	2844 AM			49	3		1		12 ²	
	9	O. Ammon (P2)	2853 AM	Opp #7 Philistines (P1)	9		48		4			
			2862 AM	Opp. Philist.. (P2)	6	Ju. Jephthah	6					
			2868 AM		7	Ju. Ibzan	7					
			2875 AM		10	Ju. Elon	10					
			2885 AM		8	Ju. Abdon	8					
			2893 AM	Judge Samuel								

See how this 40 years of Philistines is perfectly mapped by the sequence **6,7,8,9,10**.

In the next pattern the timeline values are separated in 5 distinct groups (G1, G2, G3, G4, G5)

				G1	G2	G3	G4	G5	Total
1	Judges 3:8	8	Cushan	8					300 Years
2	Judges 3:11	40	Othniel	40					
3	Judges 3:14	18	Eglon	18					
4	Judges 3:30 ?	18	Ehud		18				
5	Judges 4:3	20	Jabin					20	
6	Judges 5:31	40	Deborah		40				
7	No ref.	12	Gap			12			
8	Judges 6:1	7	Median			7			
9	Judges 8:28	40	Gideon			40			
10	Judges 9:22	3	Abimelech				3		
11	Judges 10:2	23	Tola				23		
12	Judges 10:3	22	Jair				22		
13	Judges 10:8	9	Ammon P1				9		
14		9	Ammon P2				9		
15	Judges 12:7	6	Jephthah					6	
16	Judges 12:9	7	Ibzan			7			
17	Judges 12:11	10	Elon					10	
18	Judges 12:14	8	Abdon		8				

In each of the first four groups (G1, G2, G2, G4) the values add up to 66.

$$G1 = 8 + 40 + 18 = 66$$

$$G2 = 18 + 40 + 8 = 66$$

$$G3 = 12 + 7 + 40 + 7 = 66$$

$$G4 = 3 + 23 + 22 + 9 + 9 = 66$$

$$G5 = 20 + 6 + 10 = 36$$

Notice that each one of the 18 values has been used one time only.

Unexpectedly, the values in Group G5 add up to 36 (instead of 66). Does this invalidate the pattern? Not at all, we can preserve the integrity of this pattern by representing the value 36 by its factors: $6 * 6$.

$$G1 = 8 + 40 + 18 = 66$$

$$G2 = 18 + 40 + 8 = 66$$

$$G3 = 12 + 7 + 40 + 7 = 66$$

$$G4 = 3 + 23 + 22 + 9 + 9 = 66$$

$$G5 = 20 + 6 + 10 = 6 * 6$$

Could such a thing be possible without God's involvement?

NO

If any of the Judges or Oppressions had lasted a single year longer or ended a single year earlier, none of the previous amazing patterns would have been possible.

Here is another way to express the singularity of each individual period of time imputed to the Judges and their oppressors. We can group all the value found **before** and including the 12 years gap (i.e. 8,40,18,18,20,40 - **12**)

in 3 fully reflective arrangements of numbers and then do the same with all the values found **after** and including the 12 years gap (i.e. **12** - 7,40,3,23,22,9,9,6,7,10,8).

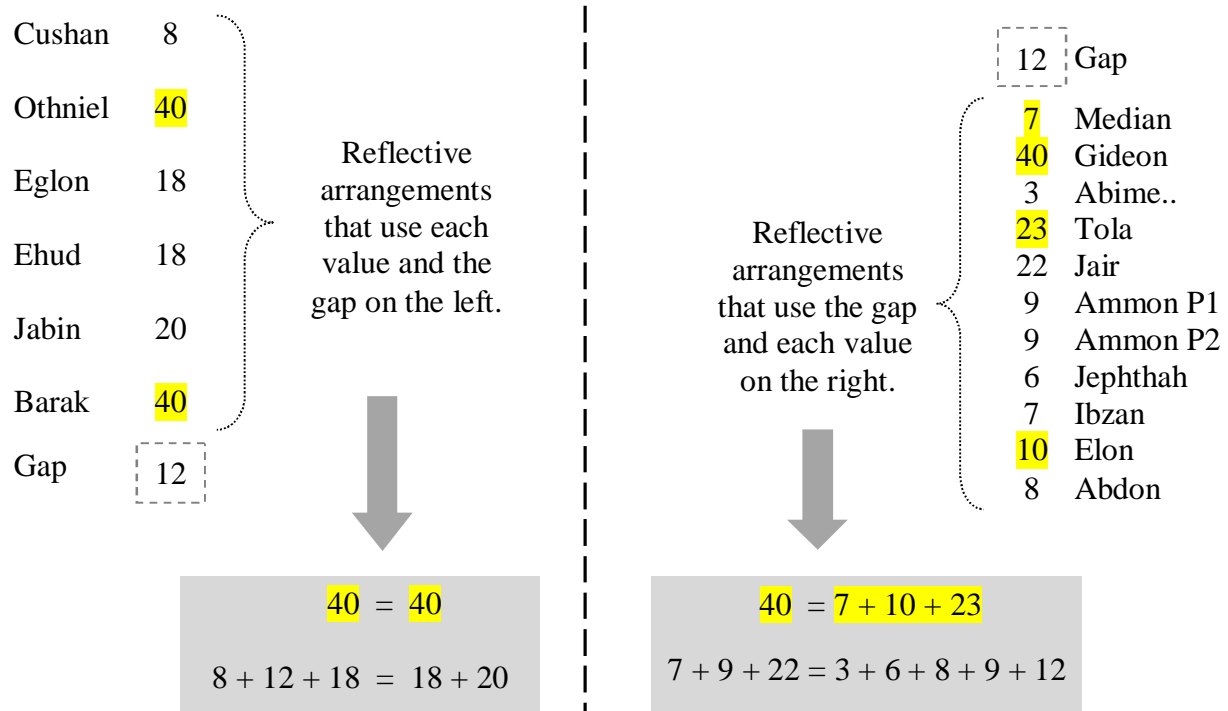

Note: Most of the patterns in the last few pages couldn't have been found without reducing Ehud's 80 years to 18. I am well aware that invoking a scribal error to invalidate a value found in the biblical text is a serious matter and shouldn't be done without serious consideration. Below is a Hebrew representation of both numbers 80 and 18. Reading from right to left, we can see that the first 4 letters in each box are almost identical, however the writing of 80 involves only one word (eight in its plural form) while the writing of 18 is done with two words ('eight' in its singular form followed by ten).



The partial similarity of the two numbers doesn't prove that a scribe, a long time ago, wrongly transcribed 80 instead of 18 on his manuscript while copying Judge 3:30. It does however show that it is not absolutely unthinkable. In the light of the previous few charts and the fact that Ehud could have hardly judged for 80 years, '18' is therefore a very appealing solution.

→ Did the Israelites wait 19 years in Kadesh Barnea? Yes

After leaving Egypt the Israelites went to Kadesh Barnea where God told them to take possession of the land. But because they were afraid of the inhabitants of the land they sent 12 spies to explore the region and report back what they saw. Unfortunately 10 of the 12 spies brought negative reports and discouraged the whole assembly. (See Deut 1:28-31) Because of this lack of faith in God's protection they had to wander in the desert for 38 years.

Deut 2:14 And the time we took to come from Kadesh Barnea until we crossed over the Valley of the Zered was '38' years,

Interestingly they didn't leave Kadesh immediately after the return of the spies and here is what the Bible has to say about it:

Deut 1:46 So you remained in Kadesh many days, according to the days that you spent there.

Isn't it a very cryptic way to say that they spent some more time in Kadesh before turning their back to the land?

The highly esteemed medieval French rabbi known as Rashi thought that the clause 'according to the days that you spent there' meant that they spent as much time in Kadesh Barnea as the amount of time spent in all the other locations visited.

Therefore out of their 38 years wandering in the desert, nineteen years would have been spent in Kadesh. Not all the Jewish sage believe the interpretation of Rashi but I found many strong patterns to vindicate his theory.

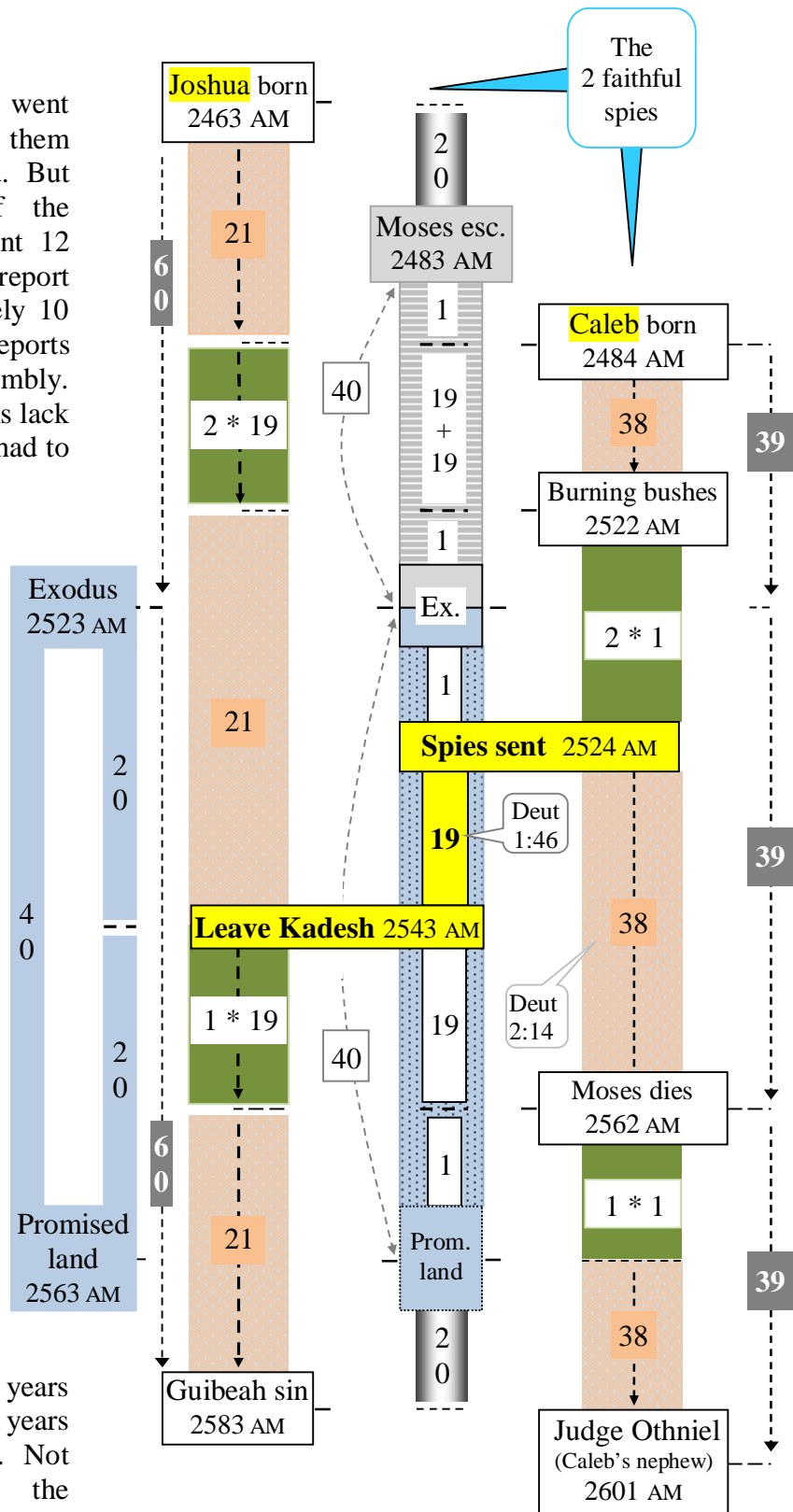

★ Caleb was 40 : Spies sent
Joshua was 80 : Leaves Kadesh

Sequence starts with a **spying event**



Spies sent 2524 AM

Sojourn in Kadesh Barnea

Joshua born 2463 AM

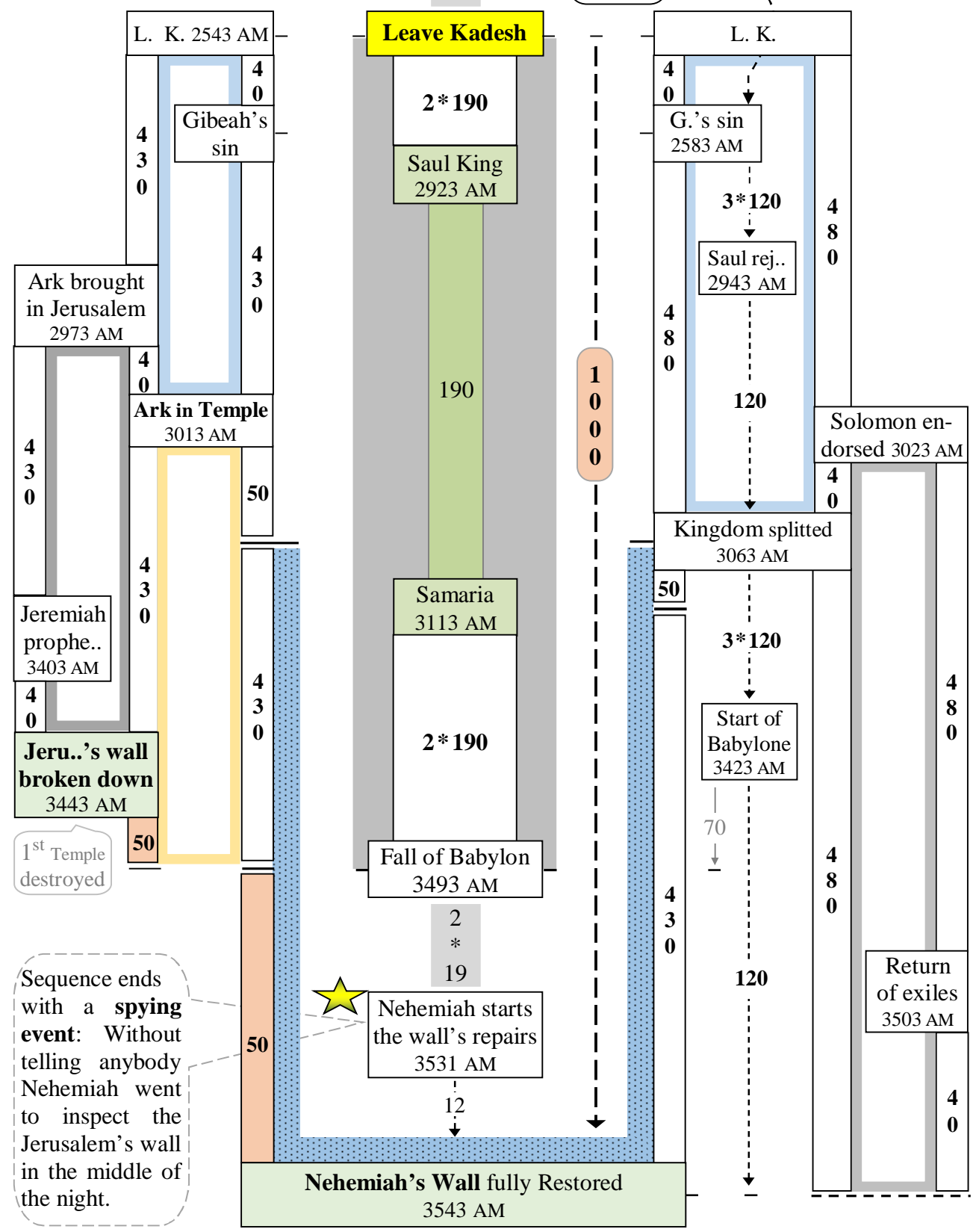

Sequence ends with a **spying event**: Without telling anybody Nehemiah went to inspect the Jerusalem's wall in the middle of the night.

→ Pilgrimage of fathers and sons

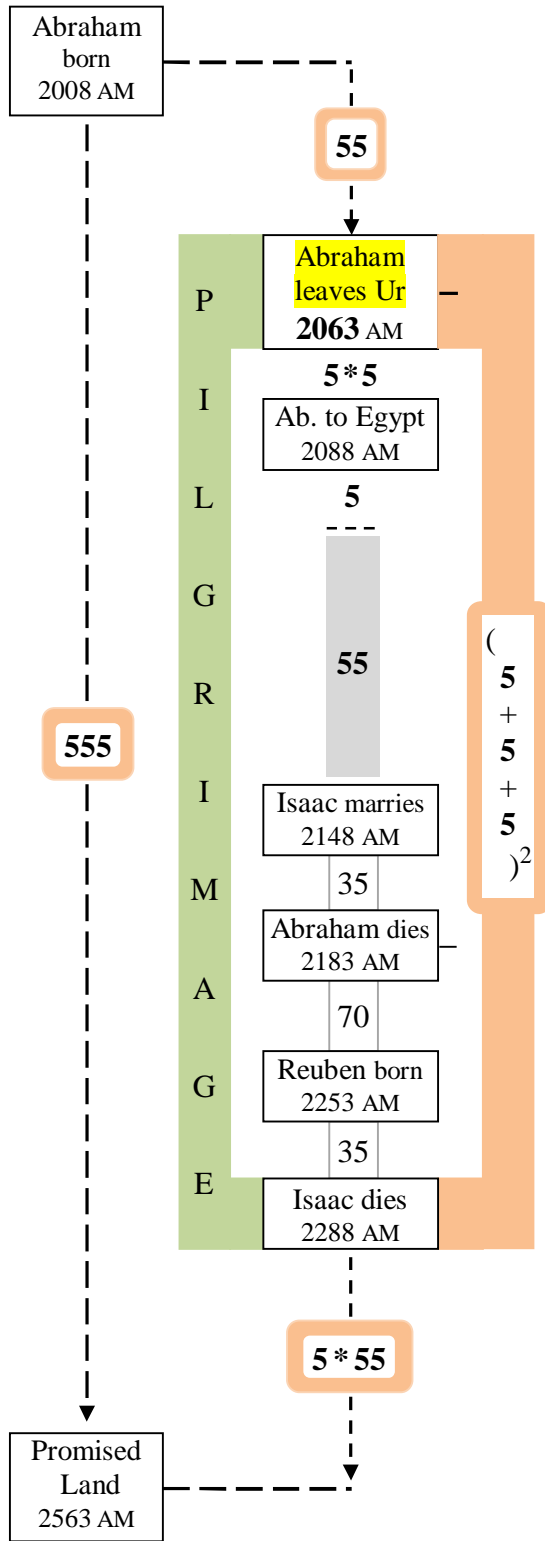

There is no specific statement in the Bible to help us figure out when Abraham left Ur and started his pilgrimage. However we can ...

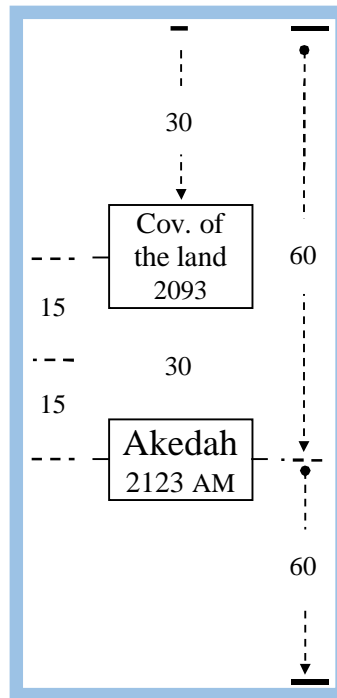

... speculate that it happened in 2063 AM as it is strongly suggested by this figure. This new date (2063 AM) will lead us to some surprising discovery.

For instance, we saw earlier that the northern tribes of Israel went into Exile in 3323 AM. This is exactly 20 * 63 years after Abraham own Exile from Ur in 2063 AM.

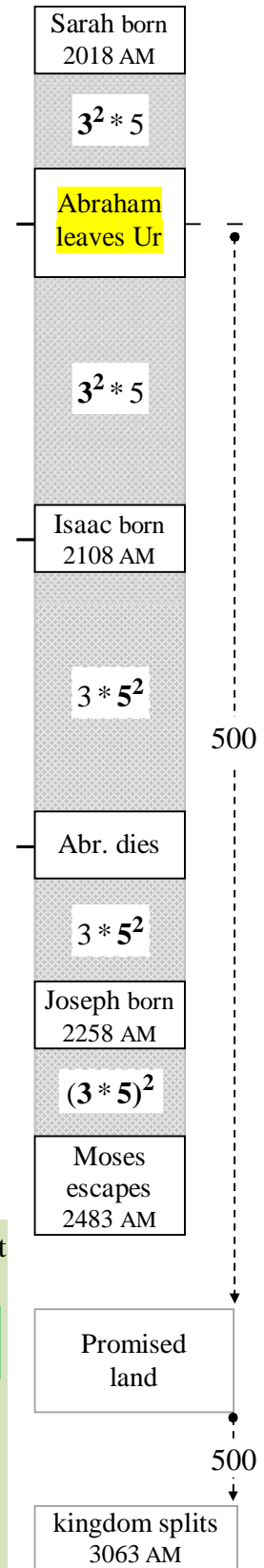
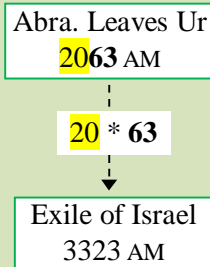

→When did Abraham marry?

Establishing which year Abraham got married to Sarah is a very speculative task, there is absolutely no direct information to clarify the point. However, we have seen in this chronology that each biblical event always fits in a strong network of patterns and by finding many of these around the year 2033 (wedding year?) should be a clue in itself. You decide.

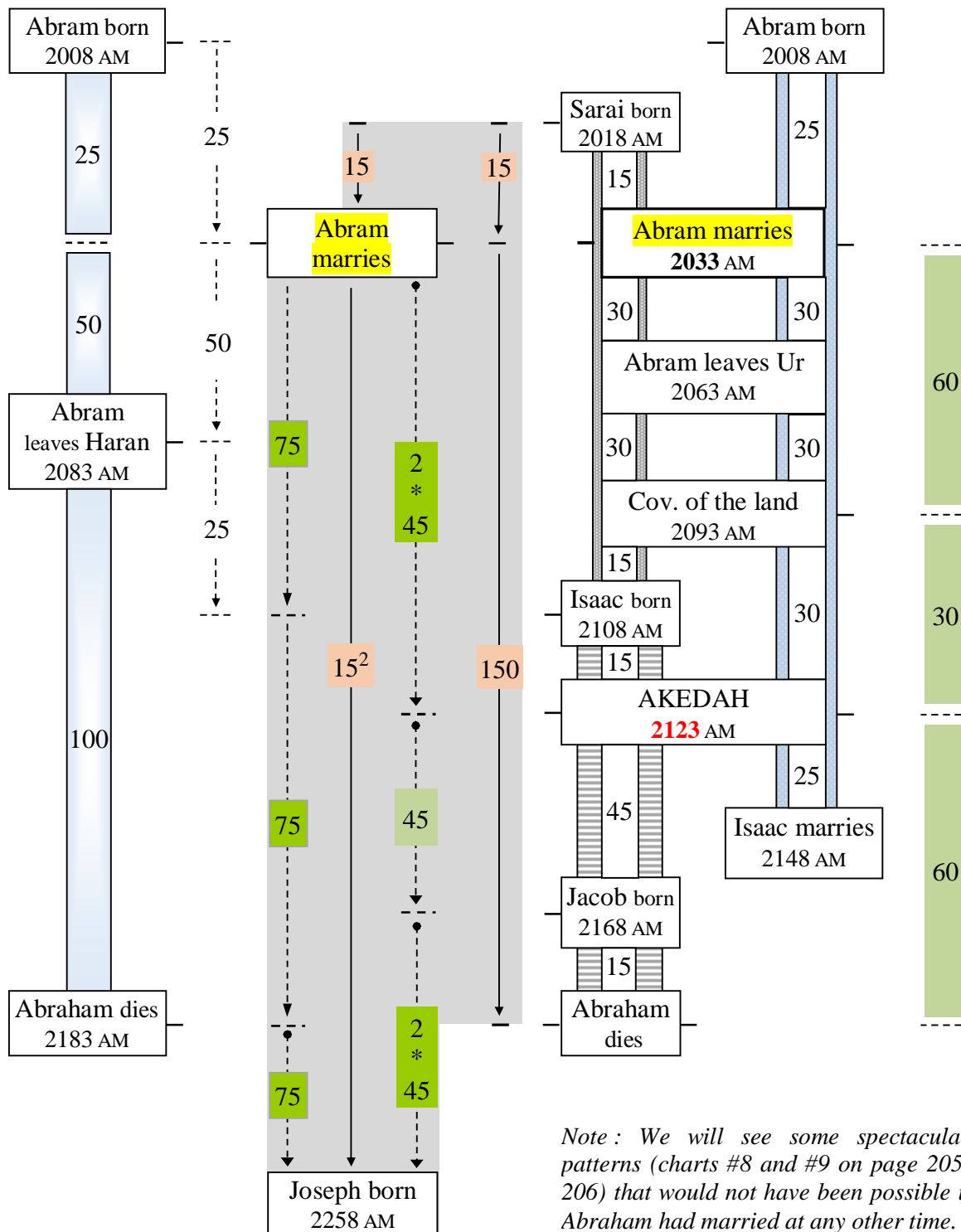

➔ Understanding Judah & Israel EXILE

❖ About Judah's Exile

Contrary to some commentator's belief, Ezekiel portraying of Judah 40 years of sin was not a way to erase their fault. God had clearly told Judah (collective name for the two tribes of Benjamin and Judah) that **she** wouldn't be spare for her sins.

Ezek 5:11 because you have defiled my sanctuary with all your vile images and detestable practices, I myself will withdraw my favor; I will not look on you with pity or spare you.

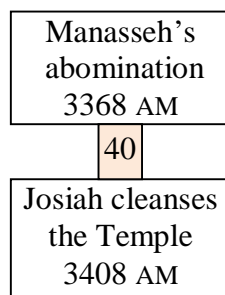

Judah's 40-year of sin corresponds to the time the Temple was left unclean.

And Judah went into captivity for 70 years (in Babylon)

Jer 29:10 "When seventy years are completed for Babylon, I will come to you and fulfill my gracious promise to bring you back to this place. NIV

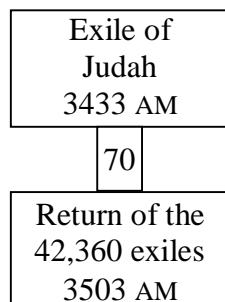

Judah went to exile because of its sins

According Isaiah 40:2 the forty years of sin should have generated a penalty of **80** years instead of 70 y. Are we missing something?

- Isa 40:2 proclaim to her that her hard service has been completed, that her sin has been paid for, that she has received from the LORD's hand **double** for all her sins. NIV

If you look carefully at the next chart you will see that Judah's suffering was not over at the end of the 70-year captivity (exile). When the people came back from exile in 3503 AM, they had to go through 10 years (3503-3513 AM) of privation because the land was then in the 60th year of her 70-year rest (desolation of the land) . (In others words even if the people were back to a land that had flowed with milk and honey in the past, they wouldn't see any crops for the next 10 years)

Understand the following two very important points:

1. The 70-year of Exile (3433-3503 AM) and the 70-year of land desolation (3443-3513 AM) are two different period that partially overlap.
2. During the 70-year desolation, the land was not producing any crop. This inactivity was a compensation for the previous 490 years of 'non stop' exploitation..

Therefore the people of Judah were punished during 80 years and it came in two parts: 70 years of exile (from 3433-3503 AM) followed by 10 years of privation when they came back from exile (3503-3513 AM).

<p>Judah received DOUBLE (i.e. 80 years) for her 40 years of sin</p>	<p>Jer 16:18 I will repay them <u>double</u> for their wickedness and their sin, because they have defiled my land with ... and have filled my inheritance with their detestable idols."</p>
--	--

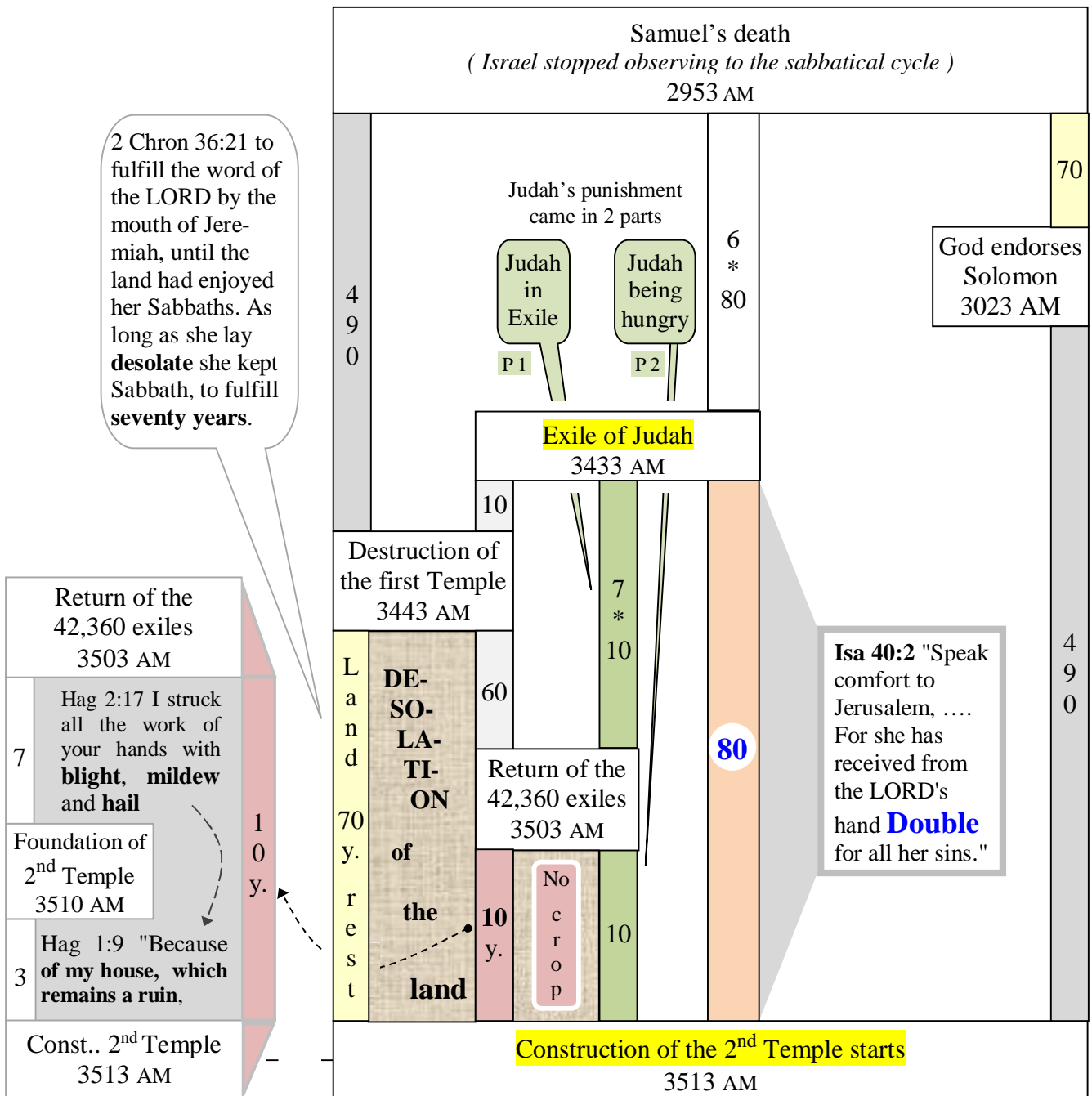

2 Chron 36:21 to fulfill the word of the LORD by the mouth of Jeremiah, until the land had enjoyed her Sabbaths. As long as she lay **desolate** she kept Sabbath, to fulfill **seventy years**.

Return of the 42,360 exiles
3503 AM

Hag 2:17 I struck all the work of your hands with **blight, mildew and hail**

7

Foundation of 2nd Temple
3510 AM

Hag 1:9 "Because of my house, which remains a ruin,

3

Const.. 2nd Temple
3513 AM

10 y.

❖ About Israel's Exile and its disappearance

Much has been said about the fact that Israel (northern 10 tribes) was punished 7 times over for its evil behaviour. It is doubtful anybody ever understood it correctly.

- Lev 26:18 If after all this you will not listen to me, I will punish you for your sins seven times over.

When Lev. 26:18 uses '7 times over' we should ask ourselves '7 times over' what? And the obvious answer that should come to mind is: '7 times over' the previous period of time during which ISRAEL HAD ALREADY been PUNISHED. We need to understand that the full punishment is given in two parts. There was to be a punishment during an initial period of time and, if it didn't work (they still didn't return to YHVH), then, the people would be punished again but this time **the period of punishment would be increased 7 times over**.

I am going to speculate that King Saul was rejected at the exact midpoint –2943 AM– of his 40-year reign. This event would have initiated a **380 year** period of punishment whose end was marked by the northern tribes going into exile. Did those Israelites from the northern tribes ever come back from their exile? If you are among those who believe, as I do, that they are still in exile, and that they should be distinguished from the exiles of Judah who came back with Zerubbabel in 3503 AM (page 182), then, ask yourself the following question: **Why haven't they come back yet to reclaim their¹⁰⁸ land?** I suggest that God had prevented them to do so because they never repented during the initial phase (380 years) of the punishment (see Amos 4:6-12). They are now serving the second phase of that punishment and they won't be back until the whole '7 times over' had elapsed.

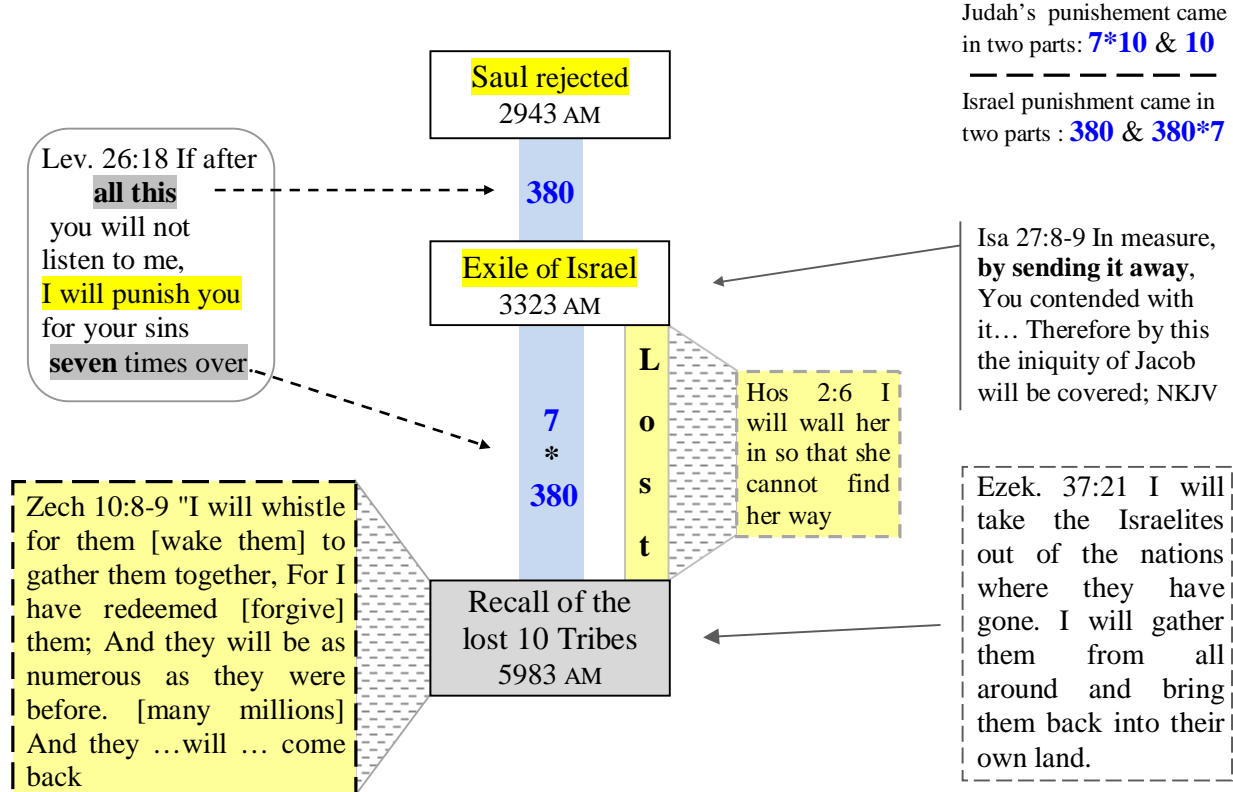

¹⁰⁸ Gen 17:8 Also I give to you [Abraham] and your descendants [southern and northern tribes] after you the land in which you are a stranger, all the land of Canaan, as an everlasting possession; and I will be their God."

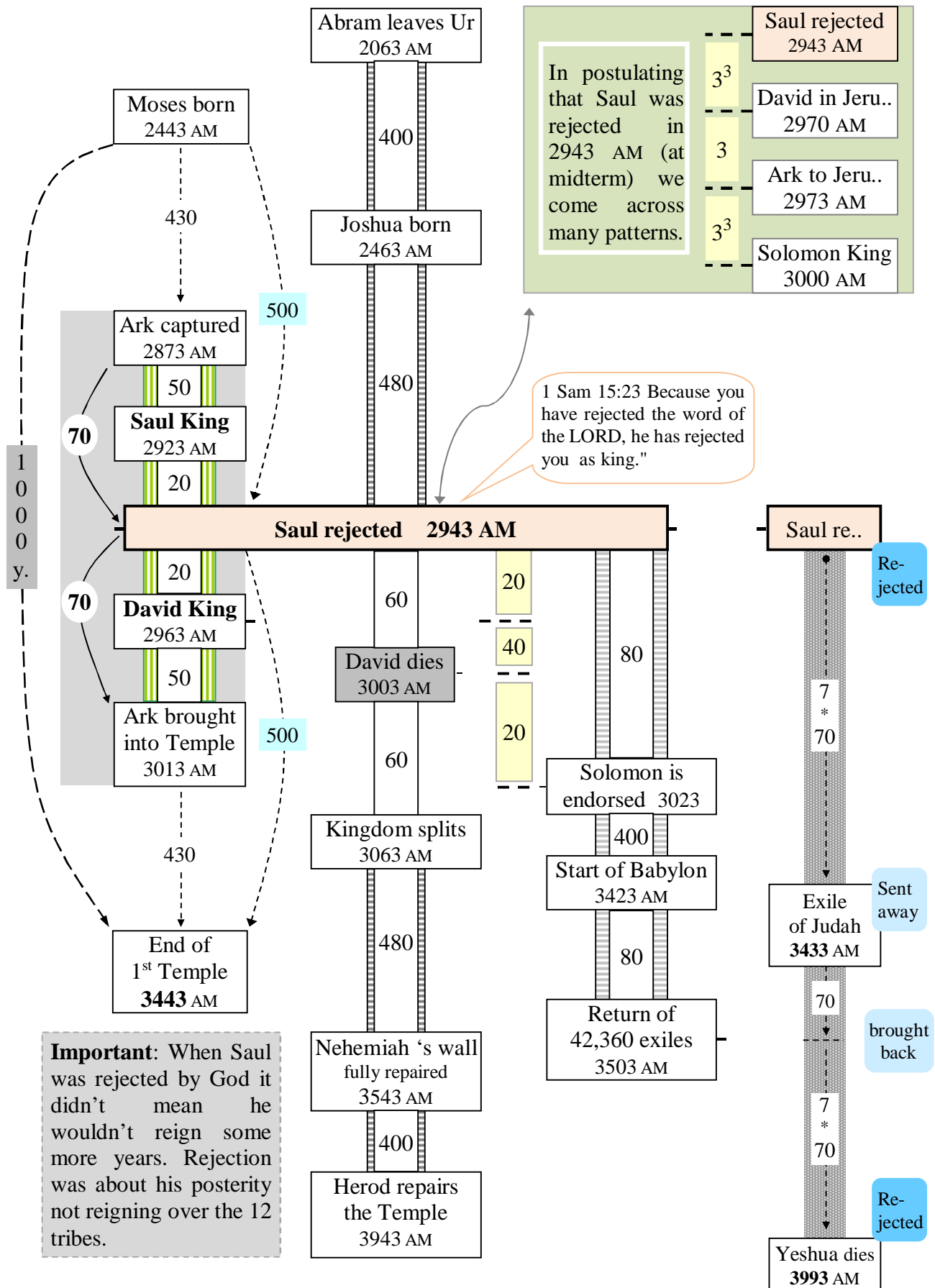

Abraham leaves Haran (and goes to Canaan) 2083 AM

5 * 390

The initial punishment lasted exactly 380 years because it was mirroring the previous period of 380 years (2563-2943 AM) during which the Israelites disobeyed God continually

This period of rebelliousness

beget

the initial punishment

100

Abraham dies 2183 AM

380

Promised land 2563 AM

380

Saul rejected 2943 AM

380

Exile of Israel 3323 AM

10 * 390 years after Abraham went to Canaan, the northern 10 tribes will return

Saul king 2923 AM

20

20

David King of Judah 2963 AM

1 Sam 15:23 Because you have rejected the word of the LORD,

End of 2nd Temple 4033

Can we reasonably believe that the northern exiles will ever be back?

The people of the northern kingdom of Israel were carried away by Assyrians. The people of the southern kingdom of Judah were carried away by Babylonians.

God promised that He would gather His people

Paid special attention to Jeremiah: 23:3 I myself will gather the remnant of my flock out of all the countries where I have driven them. 23:4 'none would be missing'.

We know that the tribes of Judah & Benjamin came back from Babylon after their 70-year exile (see p 184).

But the Northern 10 tribes never came back from the Assyrians' captivity. It is even believed that in due course they were scattered into many nations.

Nevertheless God said 'none would be missing'

N.B. This 'exile' will end only when the people will collectively 'and miraculously' learn who they really are.

Rom 11:25 that blindness in part is happened to Israel, until the fullness of the Gentiles be come in.

Where are the wandering children (Lost tribes) of the northern 10 tribes today?

While there is no definite consensus some researchers point to England, USA, Canada, France, Netherlands, Scandinavia, Ireland, Switzerland, Belgium, Australia, New Zealand.

The Hebrew word 'Brit-Am' means "Covenant of the people" (Isa 42:6). Is it why the British got the name Great-Britain? Notice that they also call themselves Anglo-Saxons. Are the 'Saxons' from 'Isaac's sons'?

Were names like Denmark, London, Danube, a testimony for the tribe of Dan as if he had been leaving his trail across Europe?

Gen 49:17 Dan will be a serpent by the roadside

For more on the subject:

- Judah's Sceptre and Joseph's birthright by J. H. Allen.
- Yair Davidy's research

5 * 390

7 * 380

10 * 390

Recall of the 10 Tribes 5983 AM

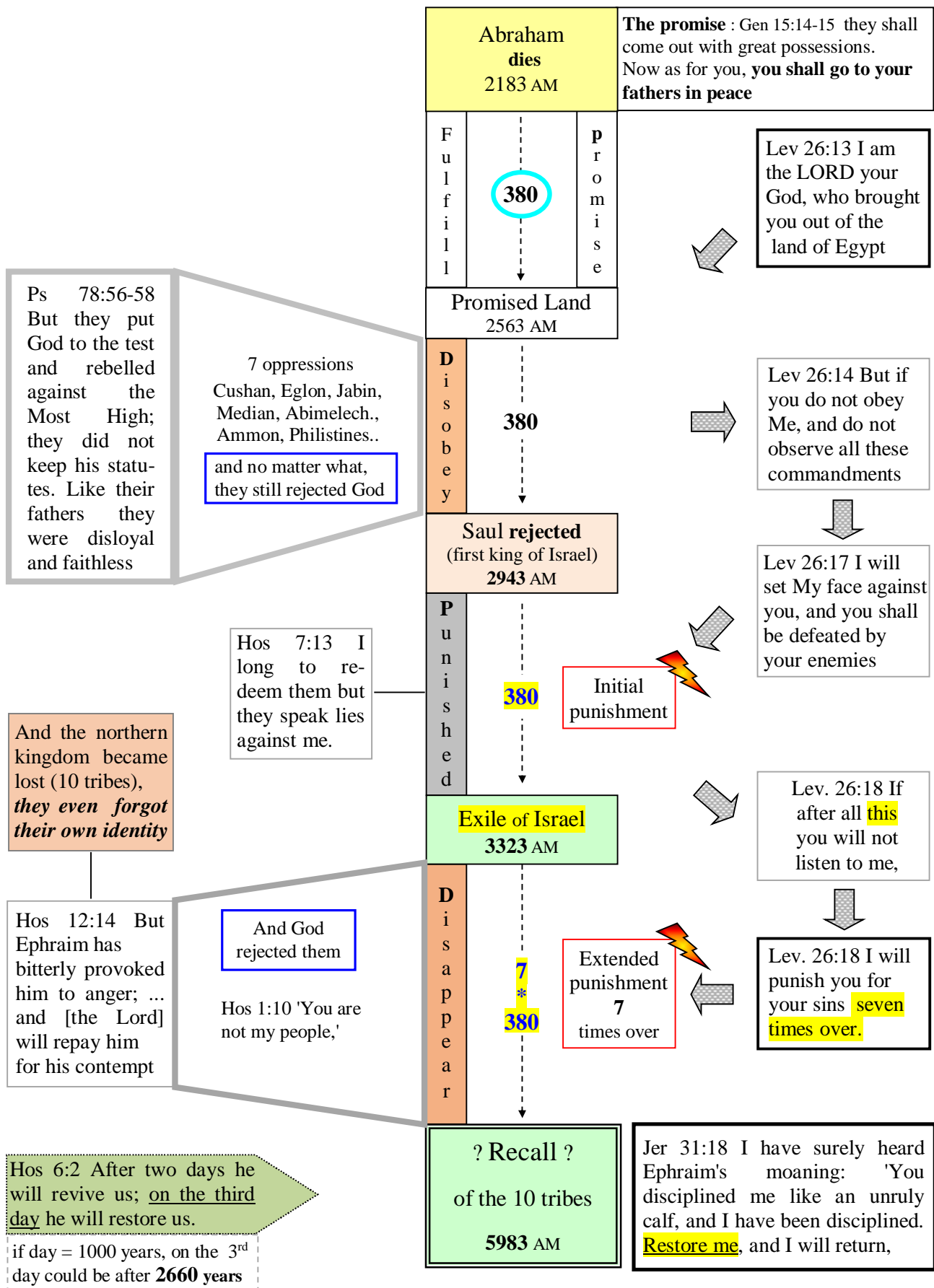

The repetitive usage of the number '38' between the 'Covenant of Circumcision' and the 'Recall of the Lost Tribes' is a powerful argument that add credibility to the following chronological structure.

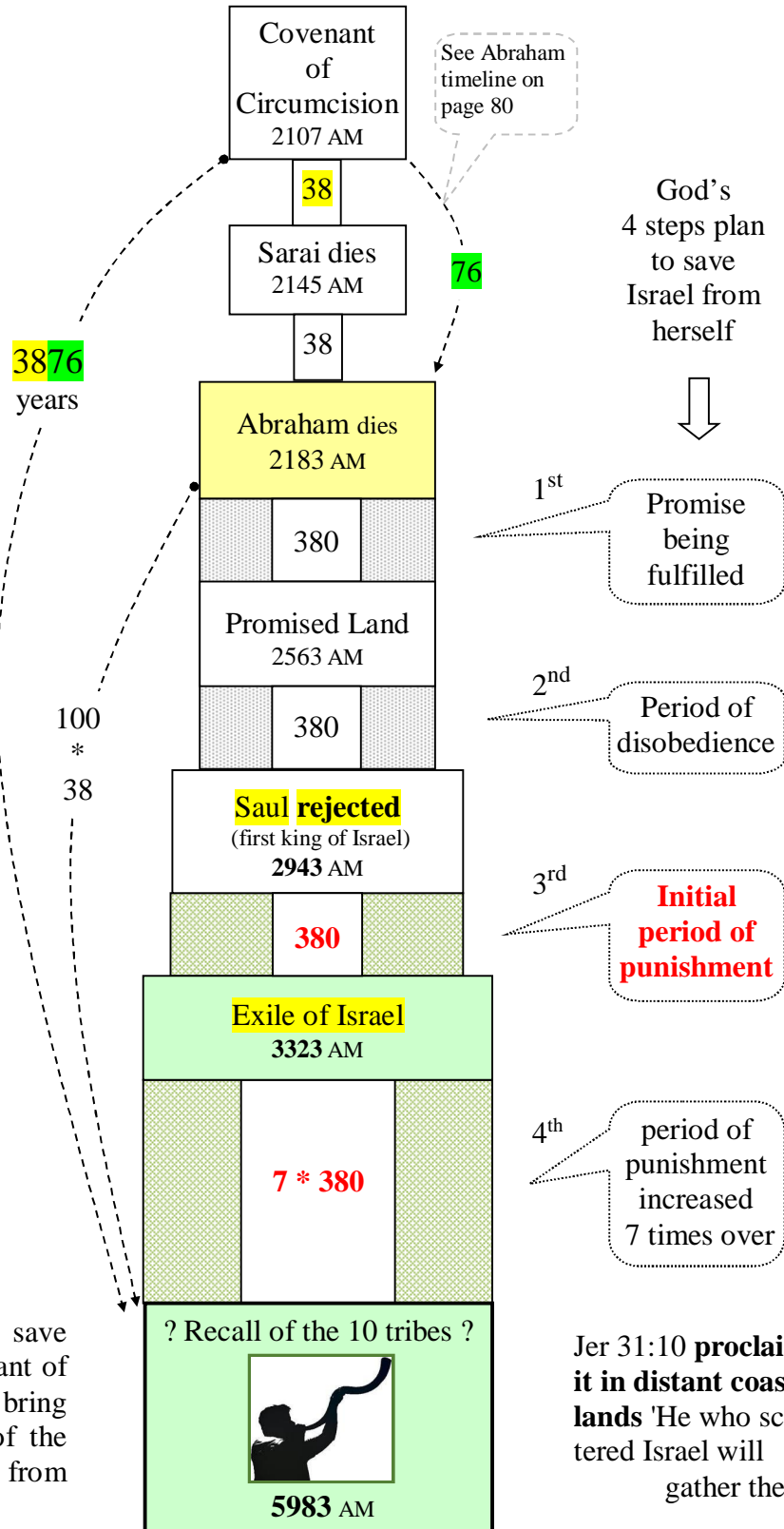

Jer 31:7-8 'O LORD, save your people, the remnant of Israel.' See, I will bring them from the land of the north and gather them from the ends of the earth.

Jer 31:10 **proclaim it in distant coast-lands** 'He who scattered Israel will gather them

A very attractive supposition
 Part 1: When did Abraham go to Egypt?

Abraham left Haran to go in Canaan in 2083 AM and he ratified the Covenant of the land in 2093 AM. Sometime between 2083 AM and 2093 AM Abraham went to Egypt for a while.

- Gen 12:10 Now there was a famine in the land, and Abram went down to Egypt to live there for a while

Suppose Abraham went to Egypt in **2088 AM**

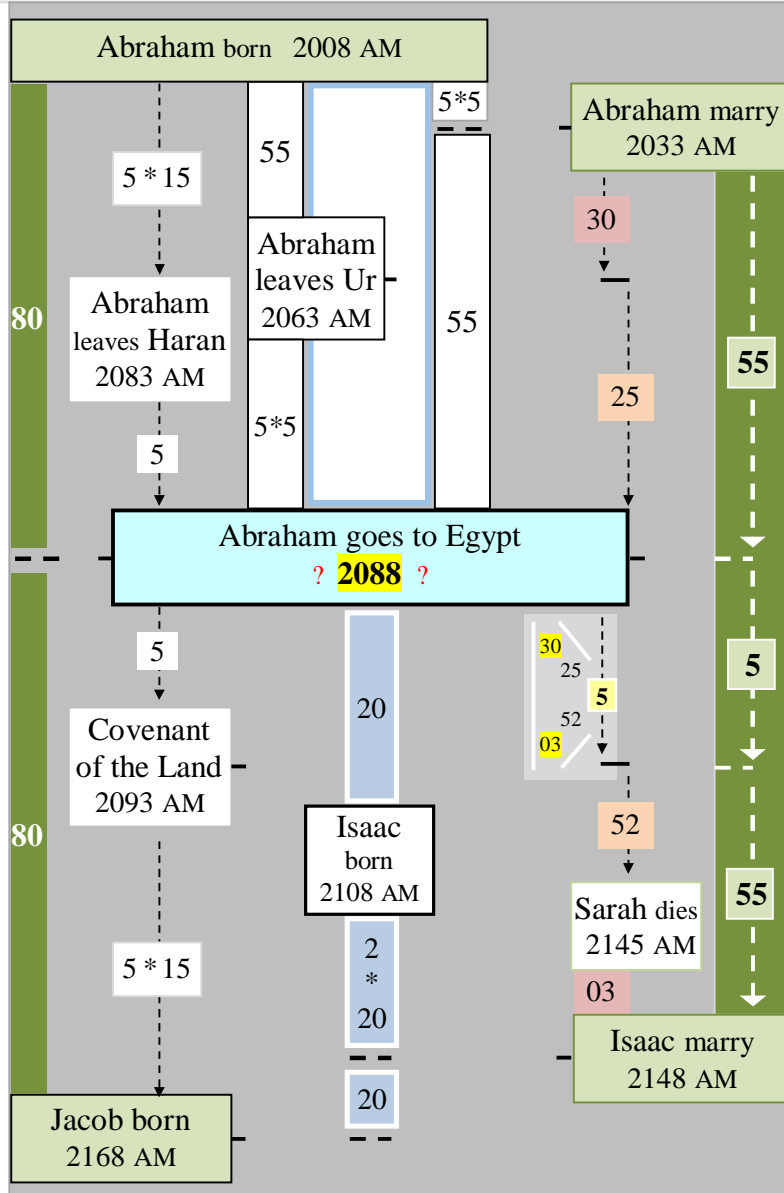

If Abraham went to Egypt in **2088 AM**, the Israelites will symbolically come out of it 3895 years later (2088-5983). Notice how you can reverse **3895** and obtain **5983**, the year of this recall.

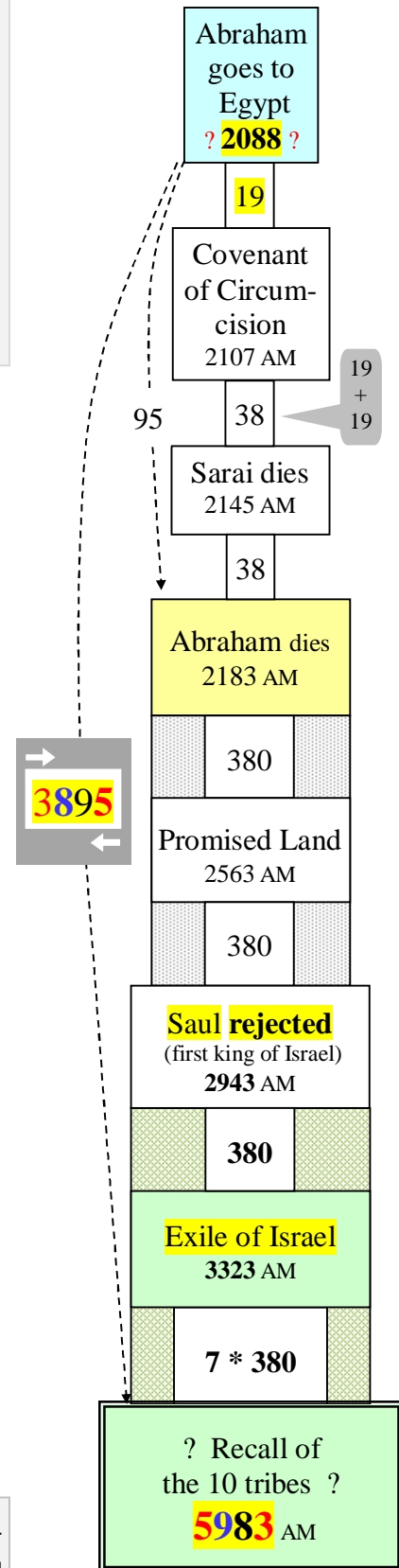

A very attractive supposition

Part 2: Figuring out Babel's timing

To the previous sequence of events associated with the Sin of Israel, let's graft a **second 95 years** segment by postulating that the scattering at Babel took place in 1993 AM.

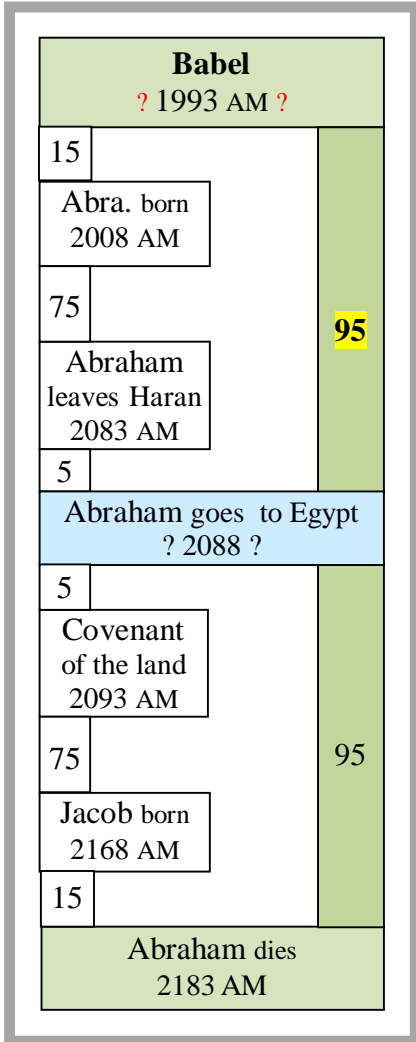

On the right side there are 7 events separated in time by either 380 years, one of its multiples (7*380) or one of its divisors (95). Notice that the sequence starts when God sent the people **all over the earth** (at Babel) and ends when He will recall the 10 tribes of Israel to bring them back from their **'all over the earth'** exile.

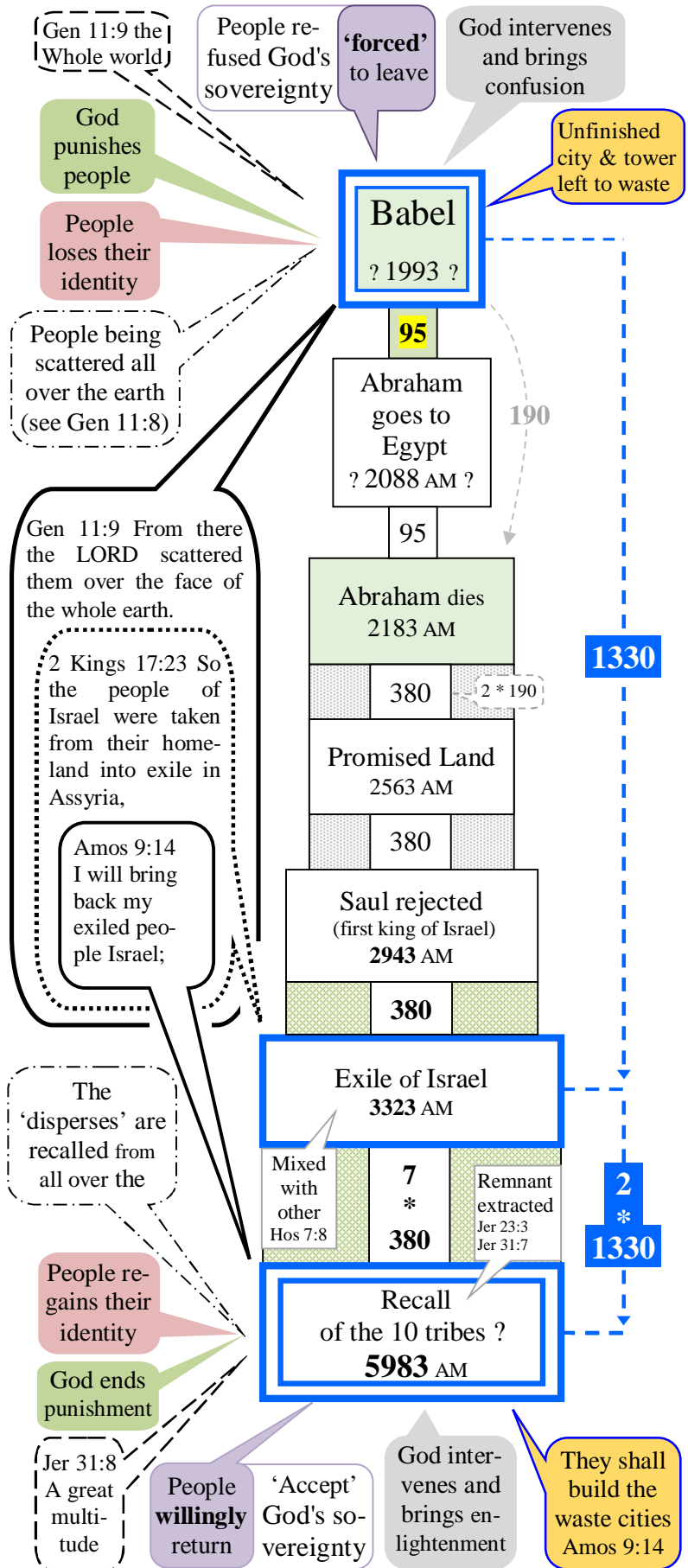

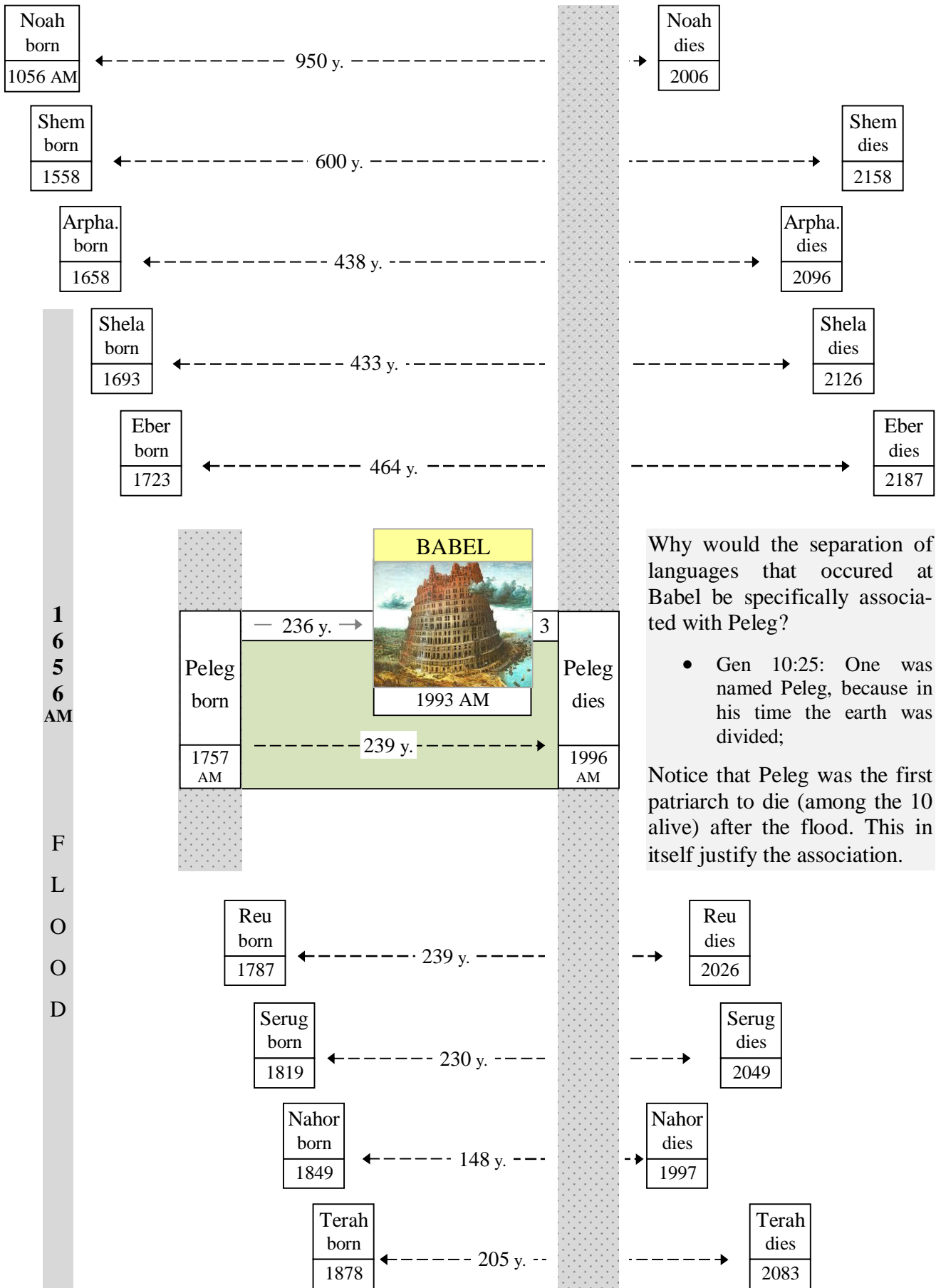

Why would the separation of languages that occurred at Babel be specifically associated with Peleg?

- Gen 10:25: One was named Peleg, because in his time the earth was divided;

Notice that Peleg was the first patriarch to die (among the 10 alive) after the flood. This in itself justifies the association.

Here is some information kindly supplied by my very knowledgeable friend Noel Rude on the connection between Babel, the exile of Israel, and Pentecost

The rabbis noticed a play on words (with the Hebrew בָּלַל *bālal*) connecting the confusion at Babel with the mingling of Ephraim (and his fellows) with the nations.

- ✓ Genesis 11:9 Therefore is the name of it called Babel; because the LORD did there confound [בָּלַל/συνέχεεν] the language of all the earth: and from thence did the LORD scatter them abroad upon the face of all the earth.
- ✓ Hosea 7:8 Ephraim, he hath mixed himself [תְּבִיֵּל] among the people; Ephraim is a cake not turned.

The miracle of Pentecost **exactly 2000 years** later is linked by verb (συνέχεεν) from the Septuagint:

- ✓ Acts 2:6 Now when this was noised abroad, the multitude came together, and were confounded [συνεχύθη], because that every man heard them speak in his own language.

Noel Rude also drew to my attention 1Kings 11:31 which connects ten men (ten tribes?) and “all the languages of the nations”:

- ✓ Zechariah 8:23 Thus saith the LORD of hosts; In those days *it shall come to pass*, that ten men shall take hold out of all languages of the nations, even shall take hold of the skirt of him that is a Jew, saying, We will go with you: for we have heard *that God is with you*.

This latter connection could well mean that the lost sheep of Israel, (ten tribes from ten men) after mingling among the nations for more than two thousand years, will come out of them with the knowledge of every language of the world. This would be a remarkable denouement, even if it was only meant to be taken at a symbolic level, of a drama that happened well before Israel was even born. At Babel, God gave the men the seed of every language and send them away from him to discover the world. At the ‘recall’, those of the ten tribes, no matter what language they will individually understand, will hear God and will come back to renew the close relationship that men could have had from the very beginning.

BABEL



RECALL of the Northern Ten Tribes

People wanted to make a **name** for themselves. God **confuse** their language. God **scattered** them all **over the world**.

Lost tribes have become many nations talking several languages. God will remove the **confusion** about their **identity**. God will **gather** them **from all around** (Ezek 37:21)

This ended up in an exile involving the whole world.

The whole world will witness the lost tribes being recall from exile.

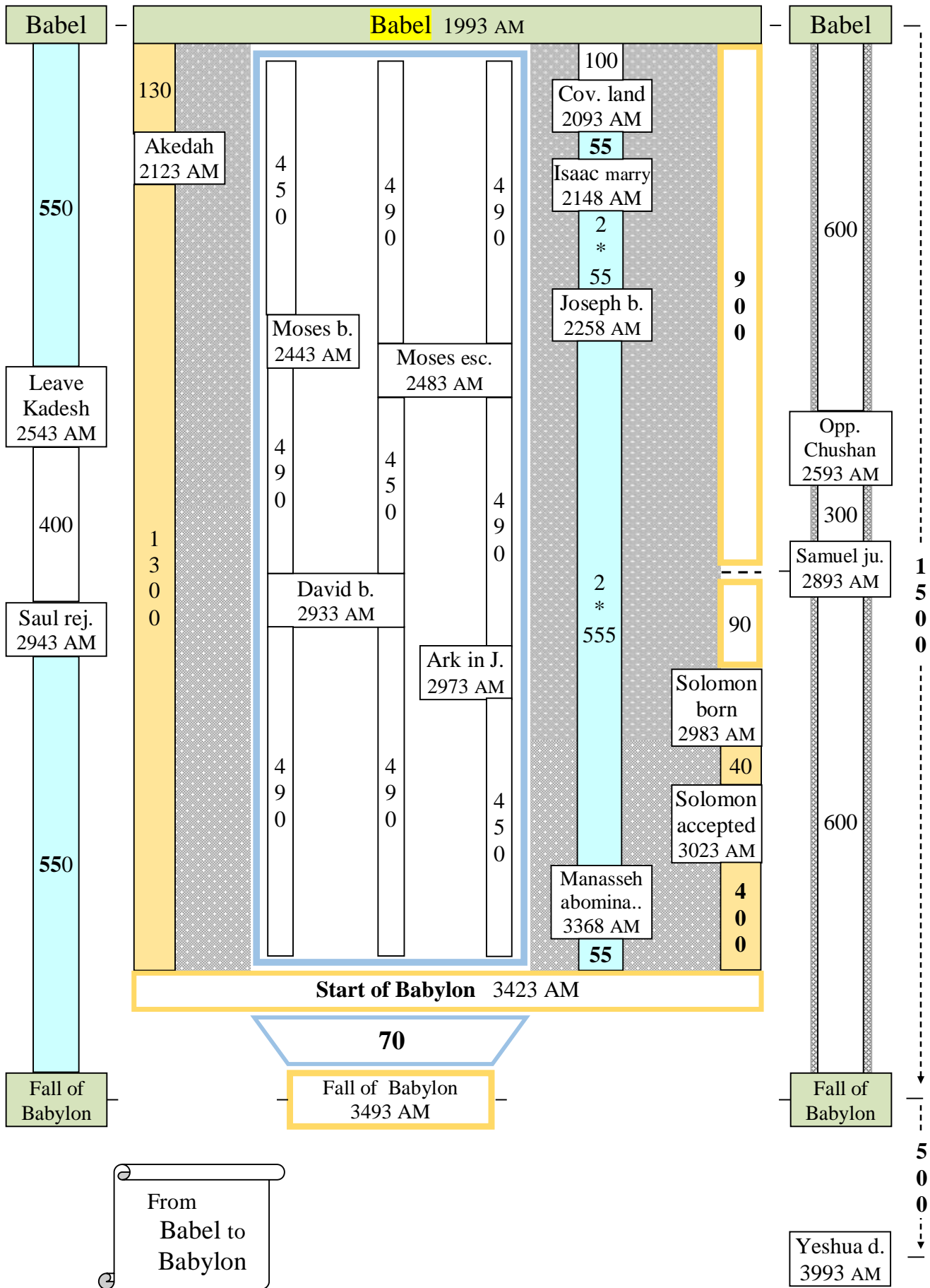

➔ From Babel to Daniel's 70th week

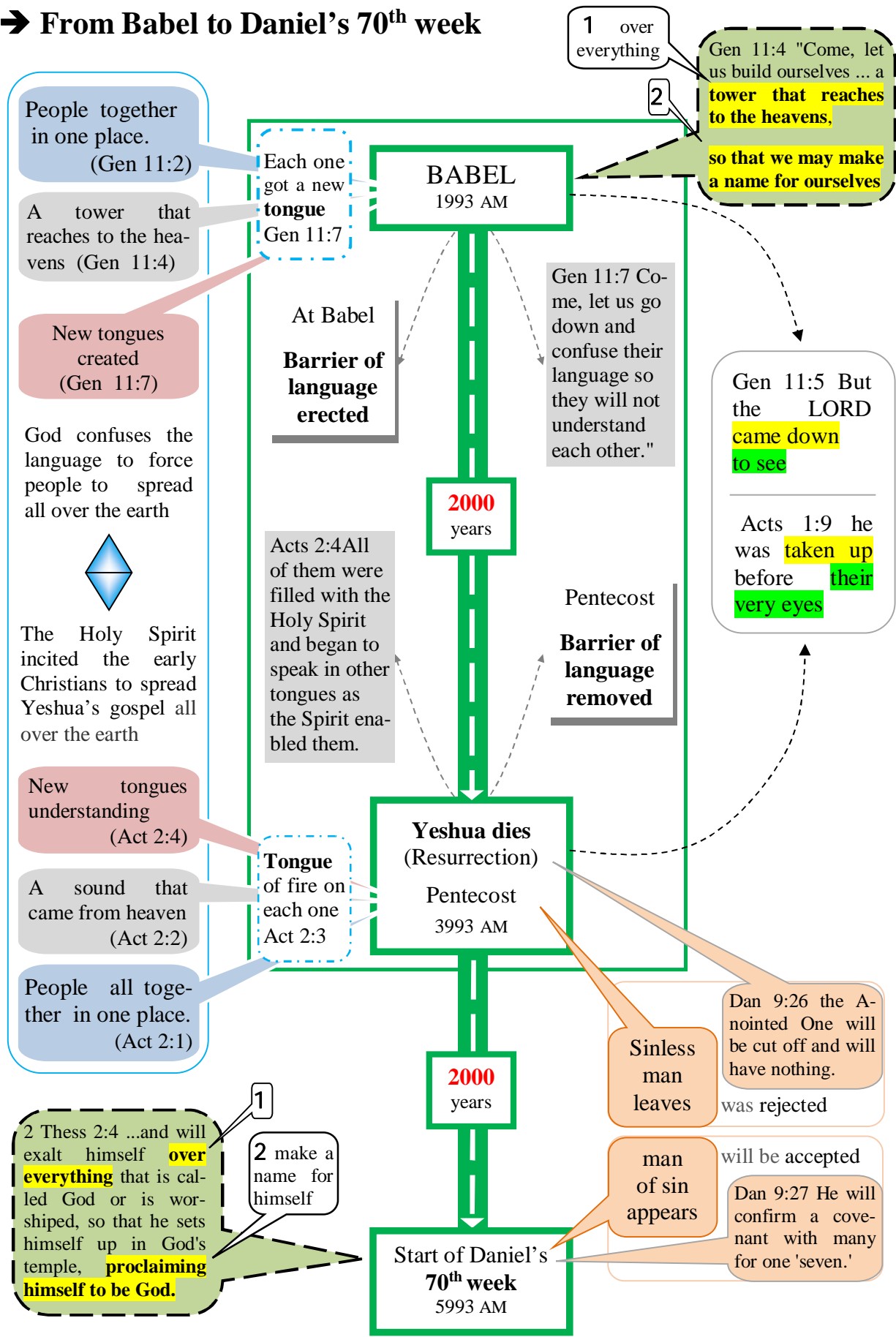

➔ What is the timing of Samson?

Samson was set apart to God from birth to help Israel against the Philistines. (see Judg 13:5) Therefore we know that Samson was birth after the start of the Philistines oppression.

Notice

Start of Phil. Opp to death of Samson = 37 y.

Birth of Samson to End of Phil Opp = 37 y.

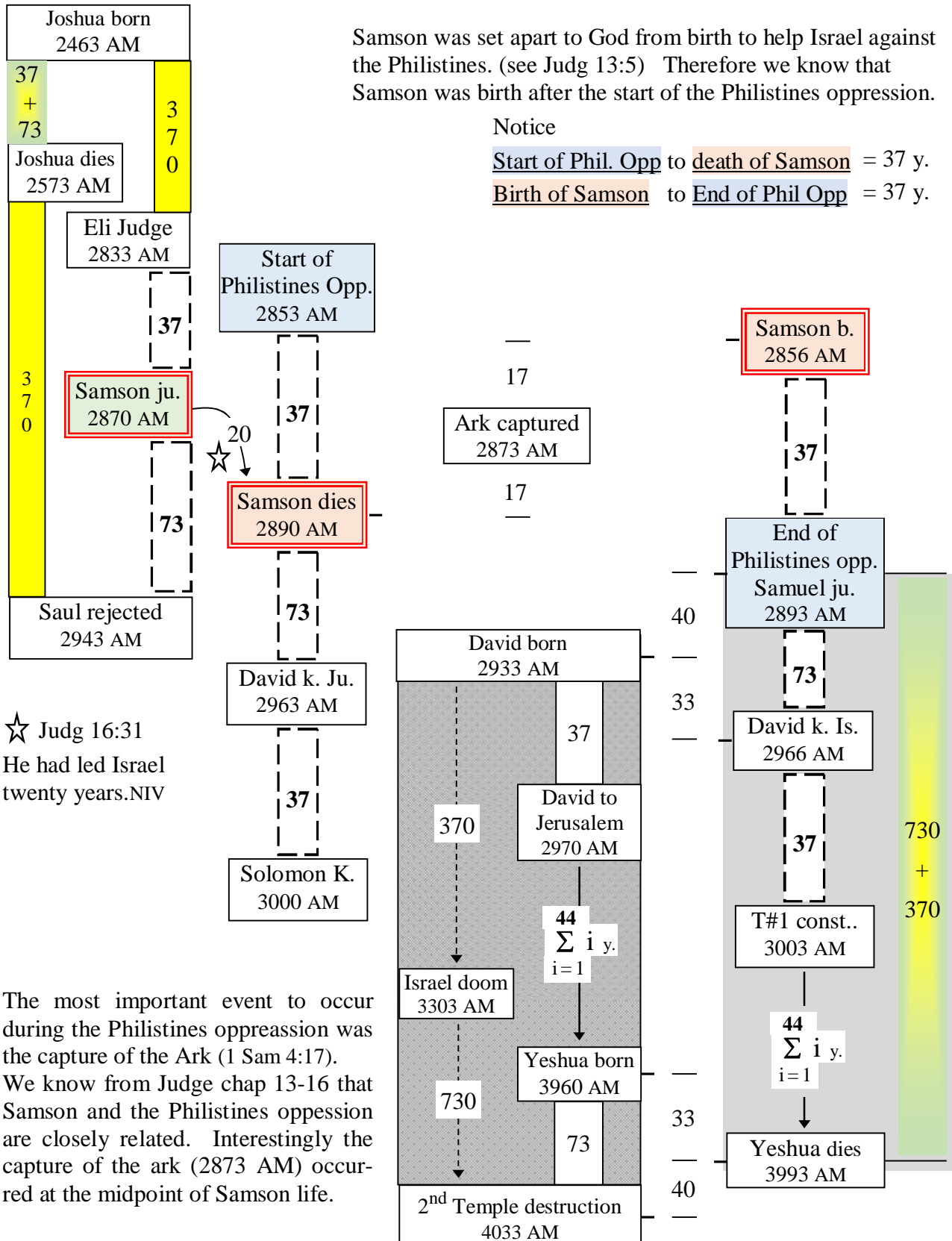

→ Was Solomon 17 years old when he became king? Yes.

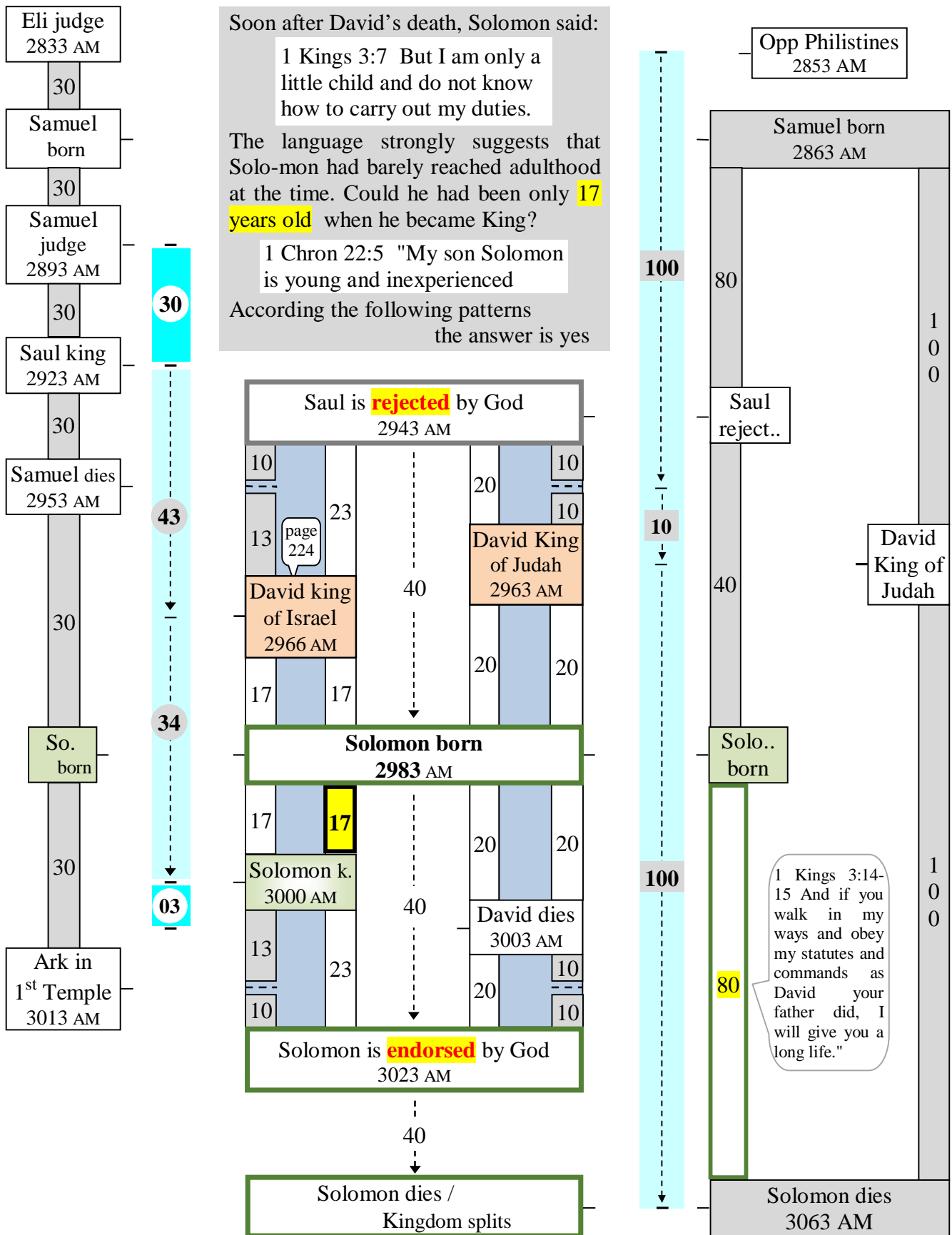

The Timeline unsealed in 28 charts

The following set of charts will highlight the extreme variety of patterns obtained when the chronology of the biblical events is rightly understood. It will become quite obvious after seeing the first few charts that most of the events are not restricted to the design of a single pattern but are often part of an elaborate network of them.



No human architect could have conceive a system with such complexity while integrating more than one hundreds events whose occurrence spanned a period of six thousand years.

Truly what you will see here is the miraculous manifestation of God perfect mind

1

Amazing
7 'links'
between
Adam
&
Yeshua

$$\sum_{i=1}^{77} i \text{ years}$$

=1+2+3+...+76+77

David dies
3003 AM

$$77^2 - 44^2$$

=1+2+3+...+43+44

$$\sum_{i=1}^{44} i \text{ years}$$

1 Cor 15:45
"The first man
Adam
became a
living being";
the **last**
Adam, a life-
giving spirit.

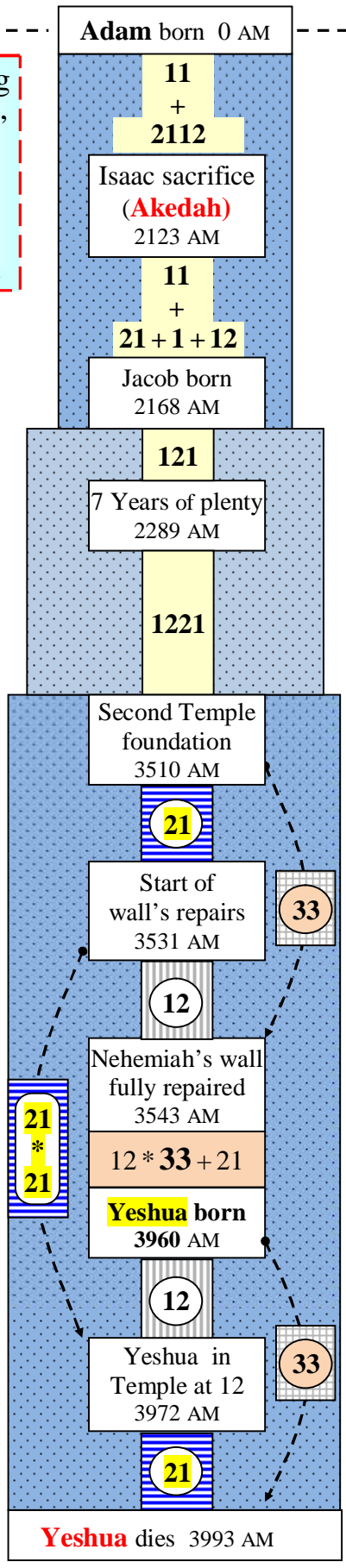

$$1221 + 121 + 1221$$

Promised land
2563 AM

$$121 - 21 + 1221 - 12 + 121$$

$$33 * 65$$

Sarai dies
2145 AM

$$3 * 30 * 33$$

David goes to Jerusalem
2970 AM

$$33$$

David dies
3003 AM

$$56 * 33$$

$$30 * 33$$

$$33 * 11^2$$

2

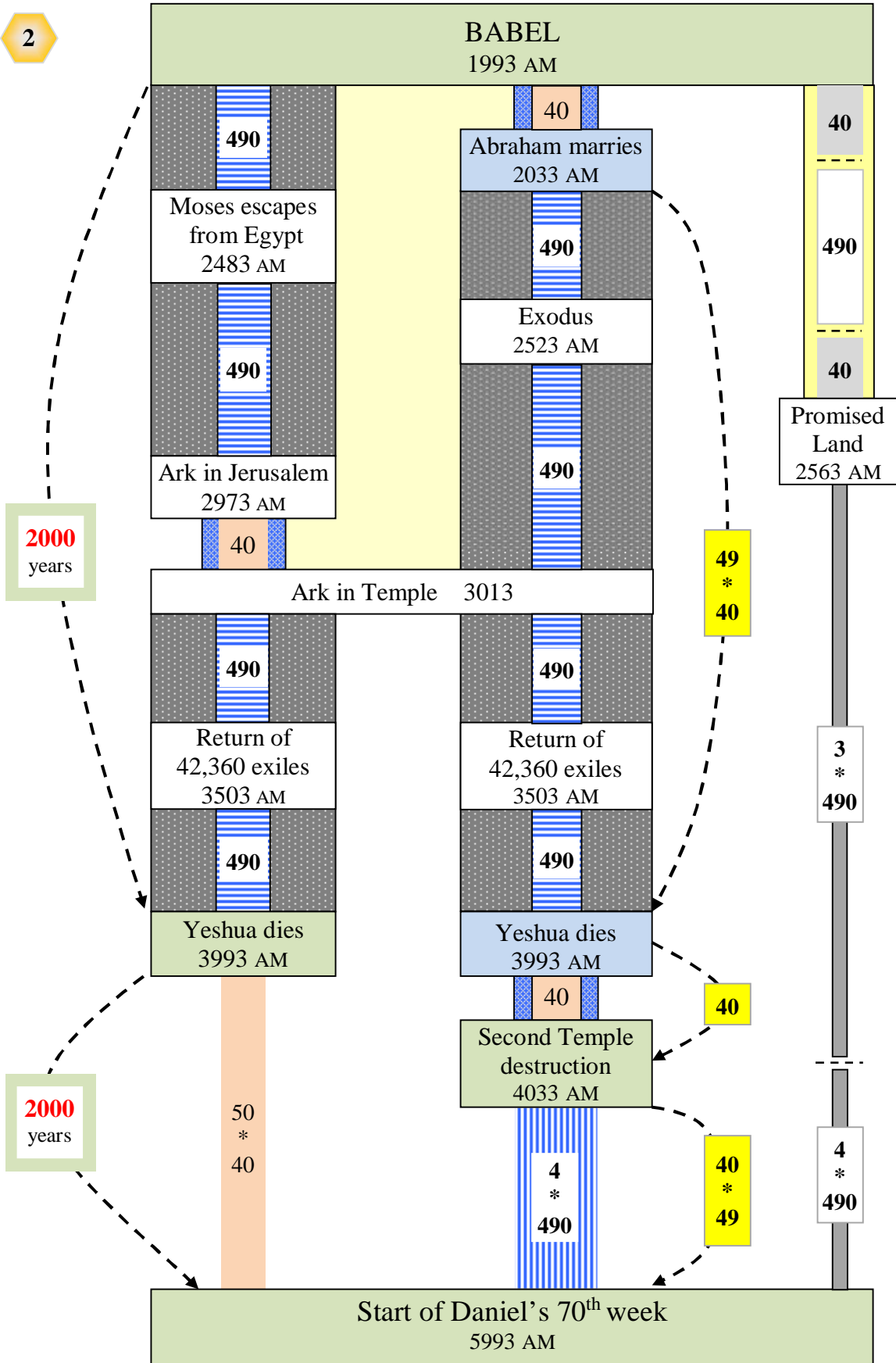

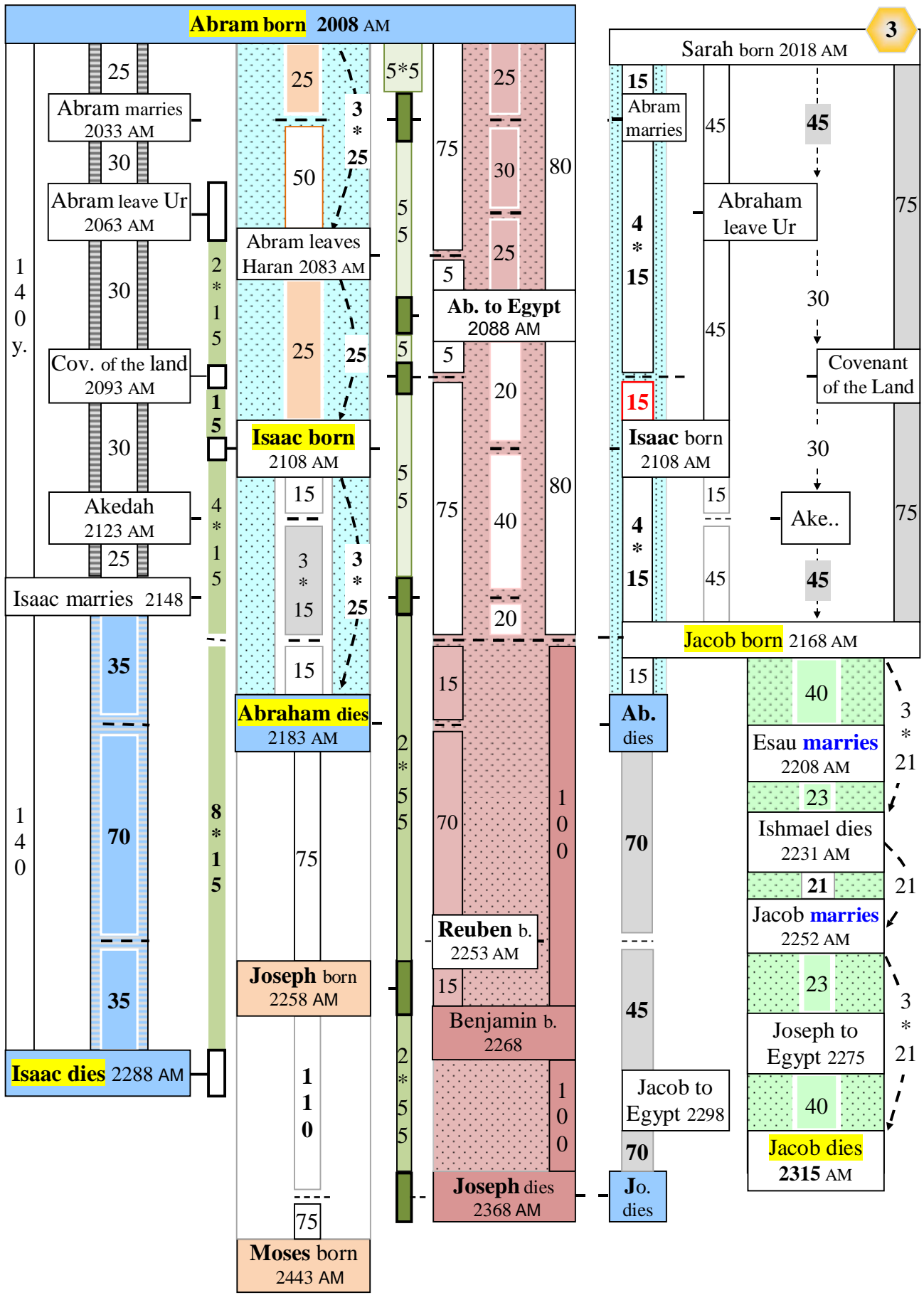

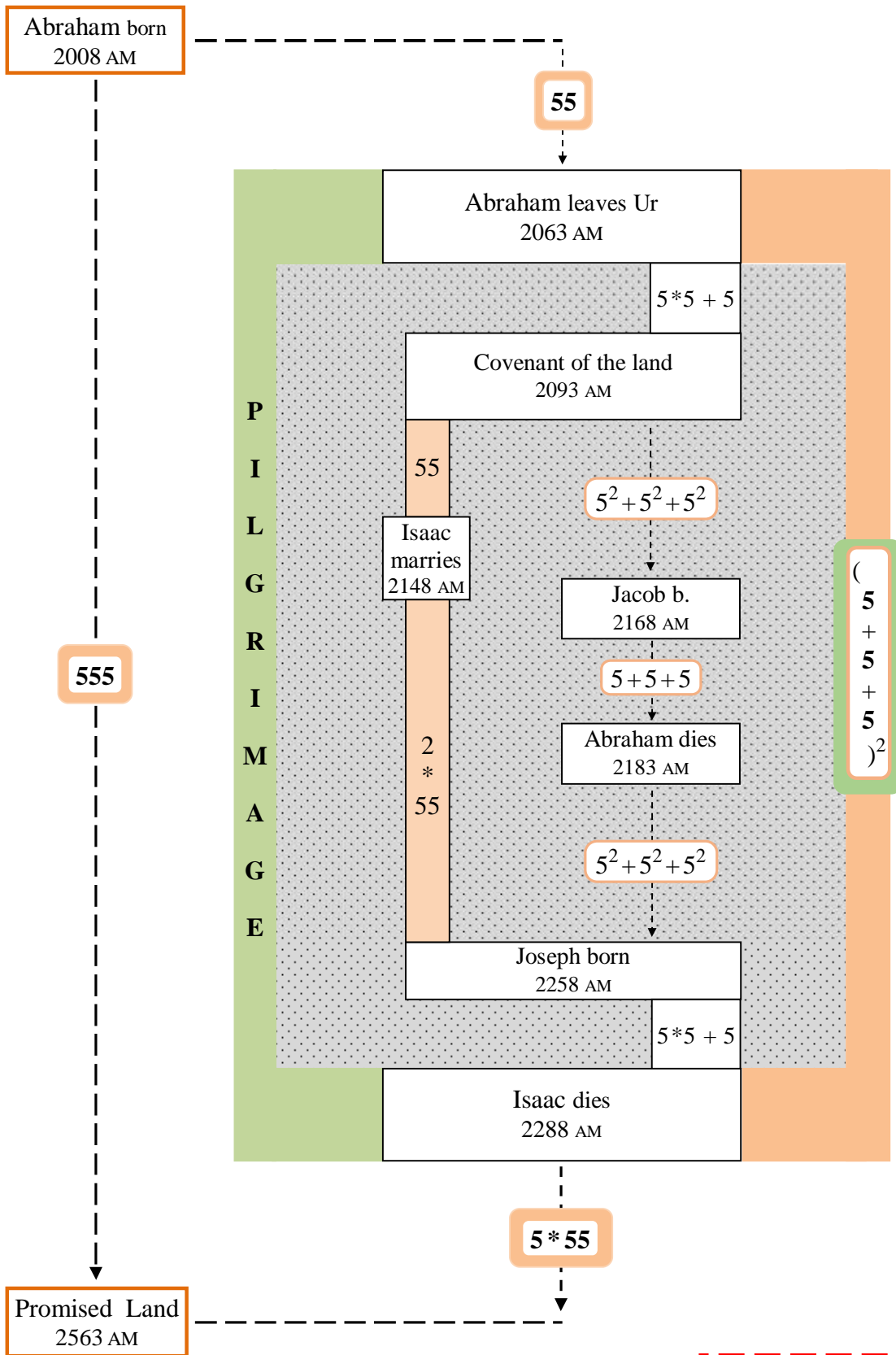

- Amazing -
Here is a very unique
and surprising pattern.

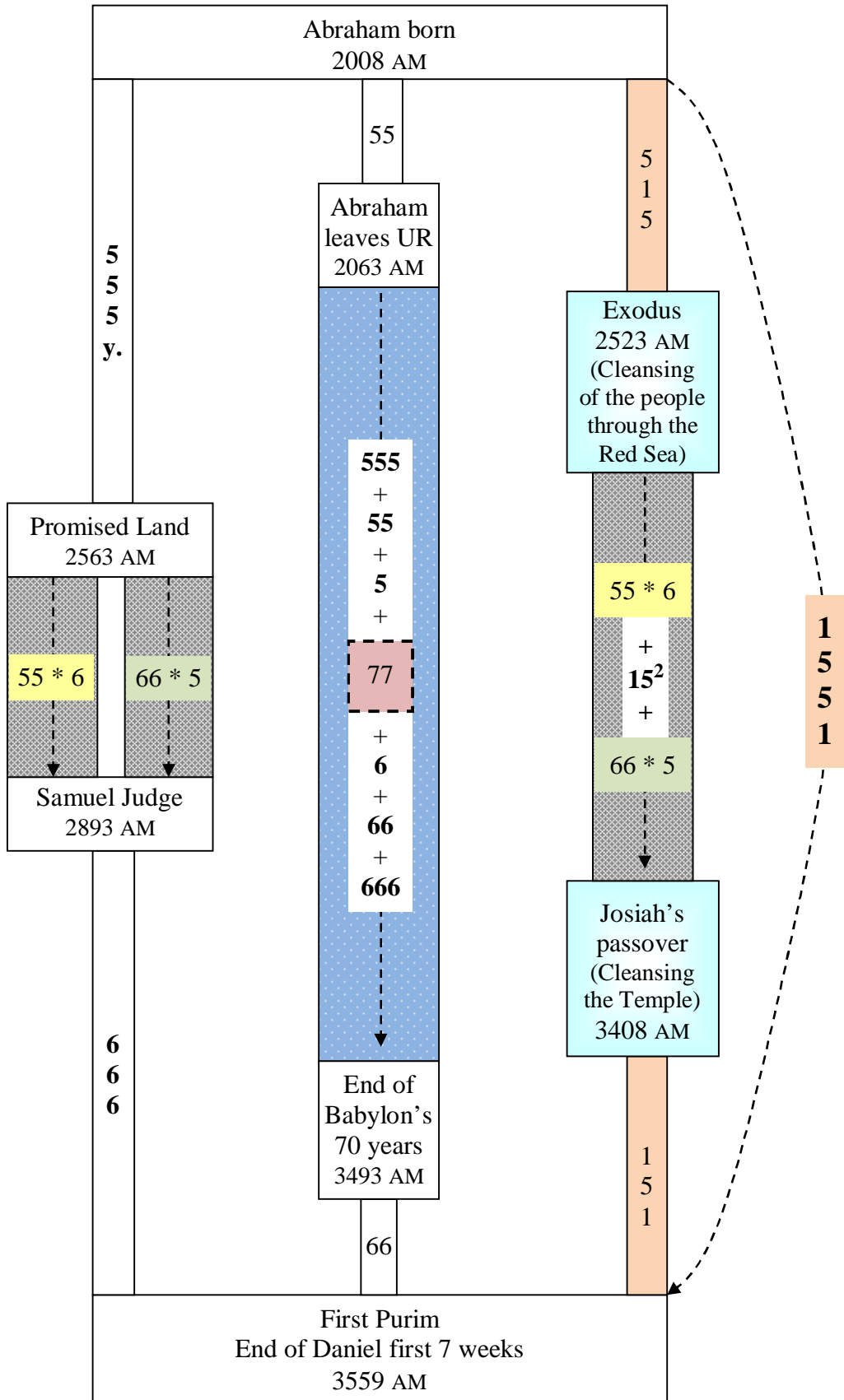

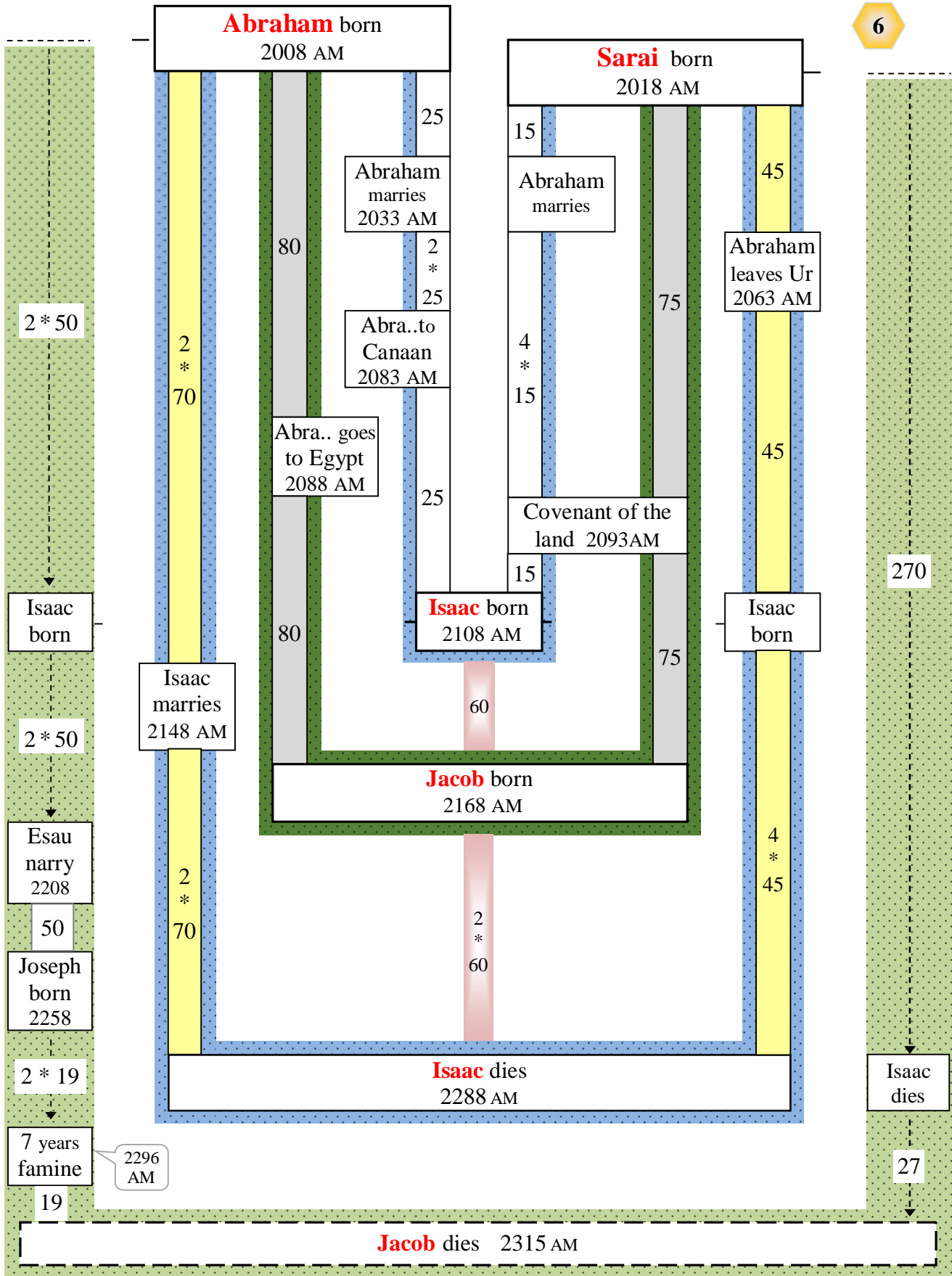

Abram marries

2033 AM

8

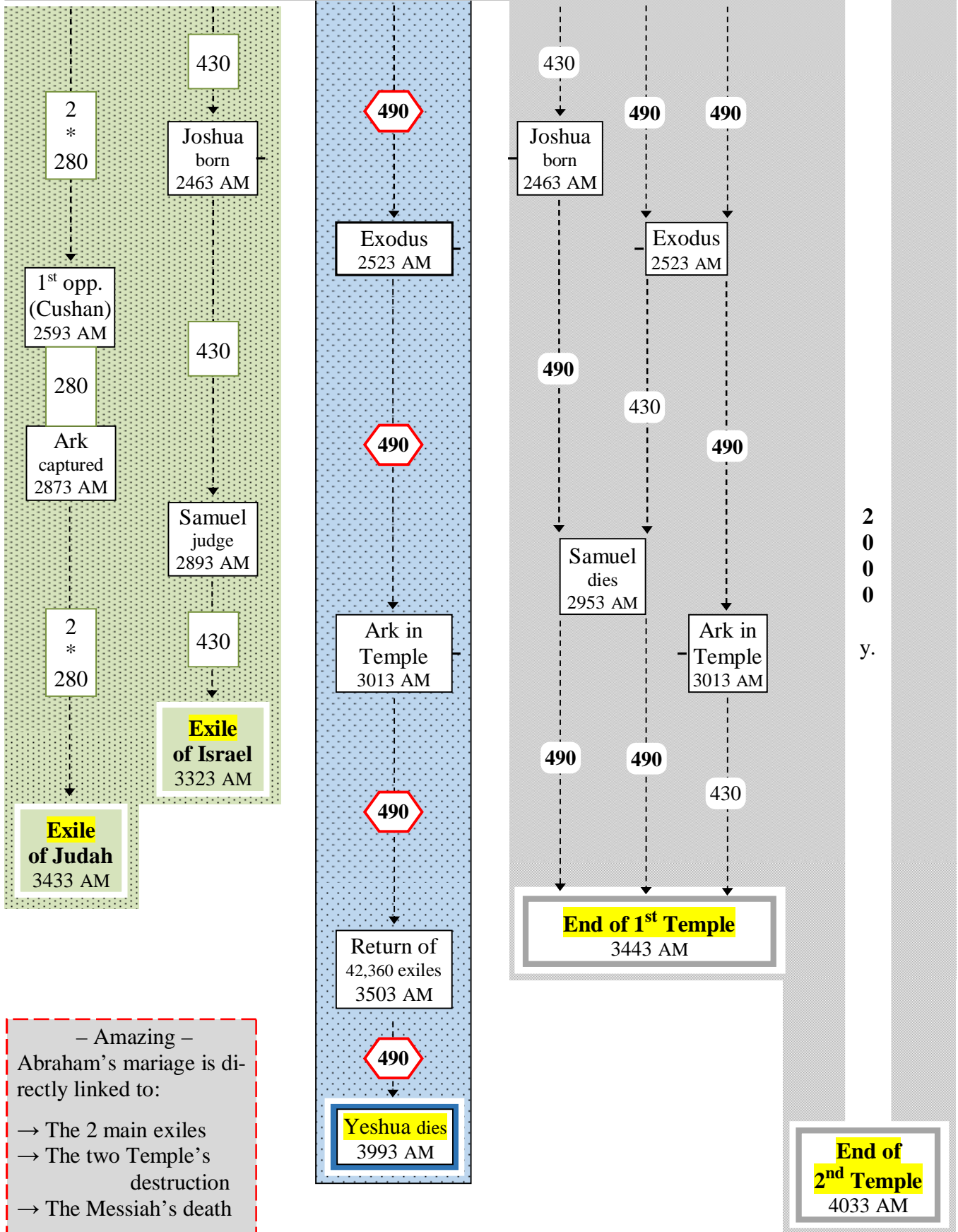

2000 y.

9

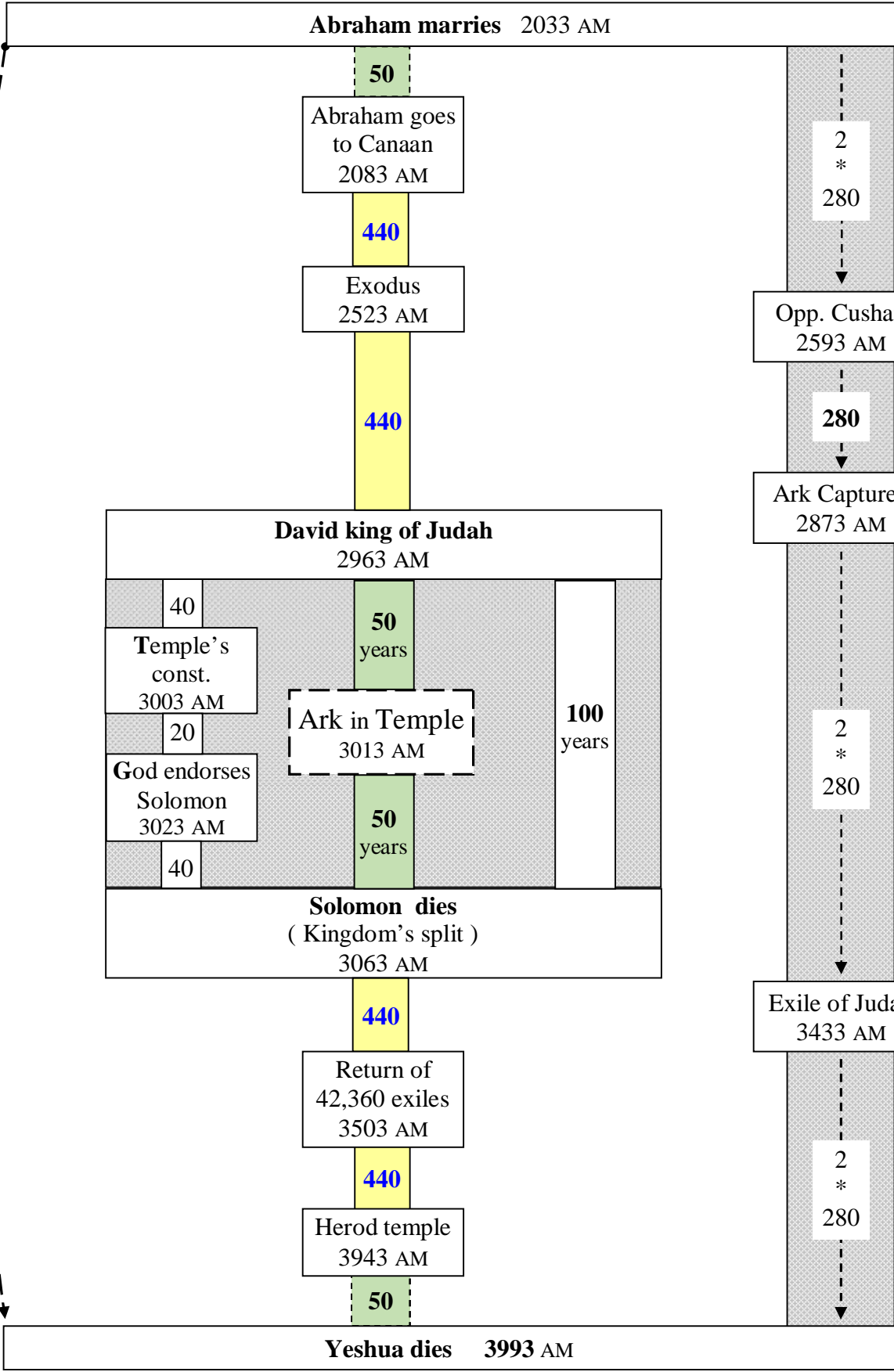

7 * 280

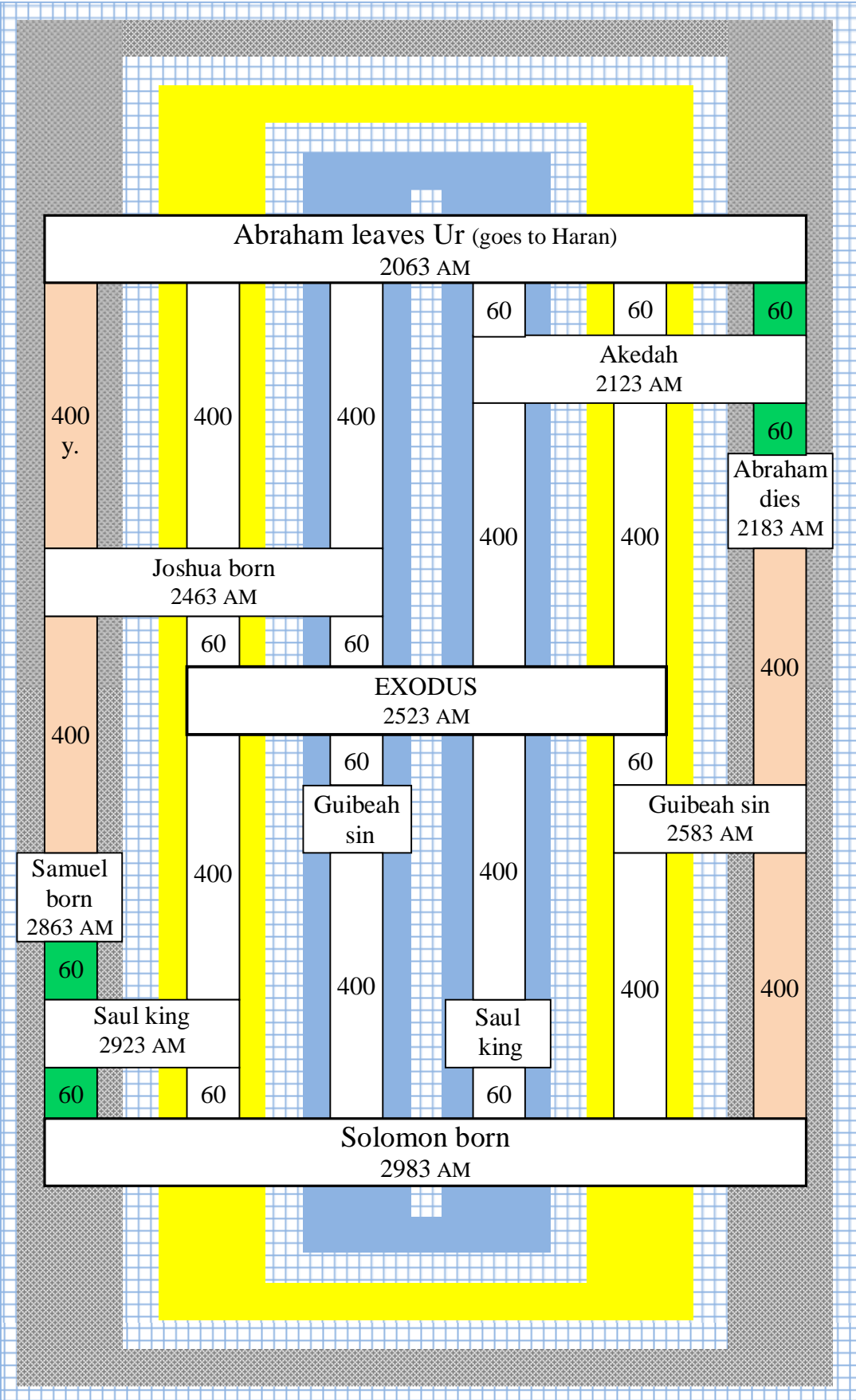

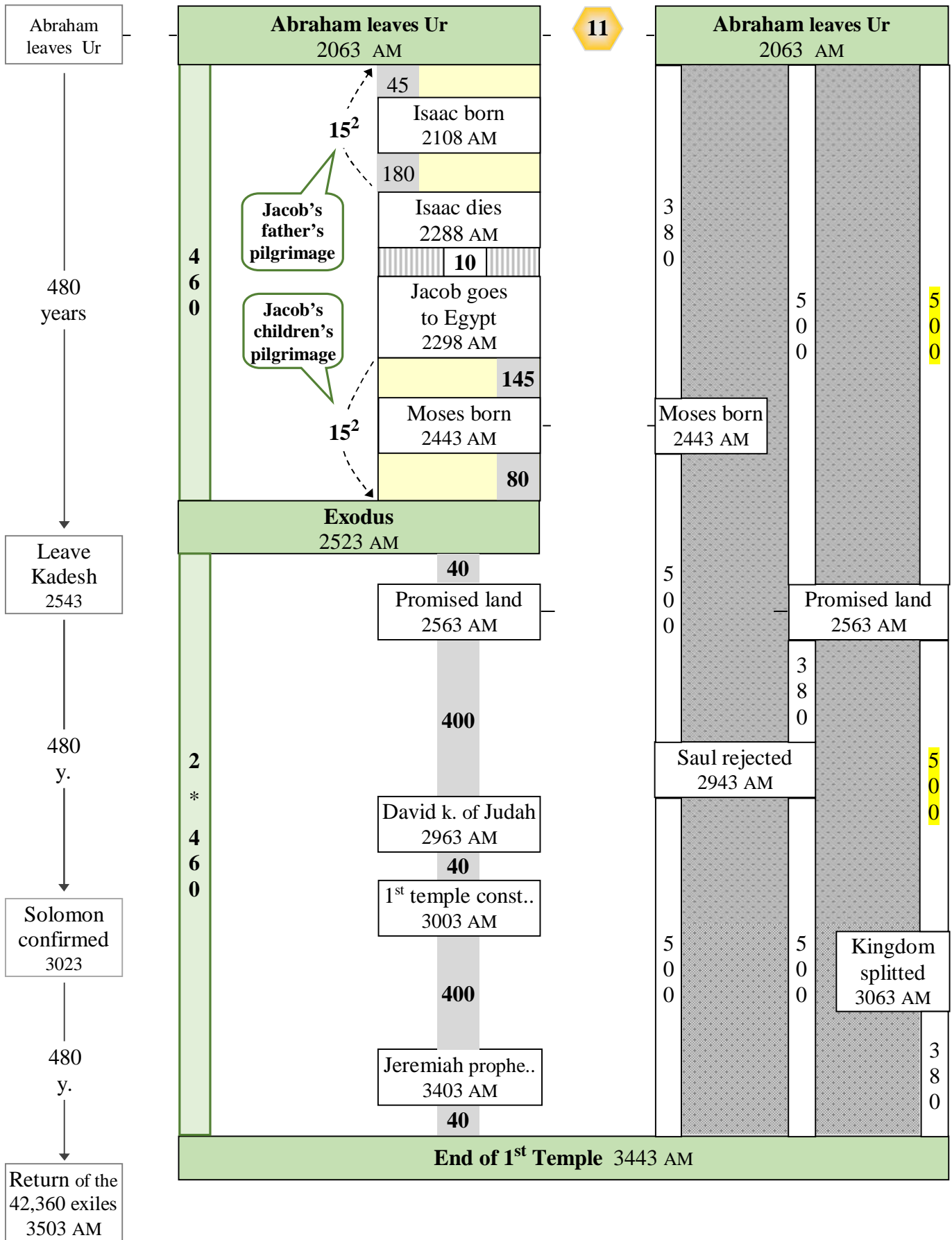

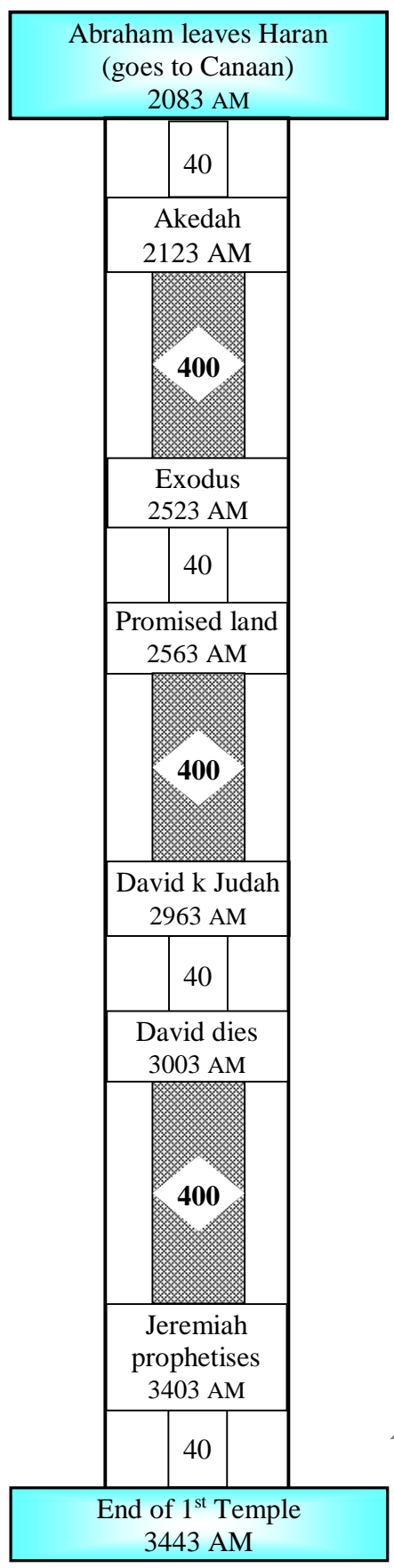

People spent 40 years in front of **God's pillar**.
 Ex 13:22 He did not take away the pillar of cloud by day or the pillar of fire by night from before the people.

During 40 years Jeremiah was **God's pillar**.
 Jer 1:18 For behold, I have made you this day A fortified city and an **iron pillar**

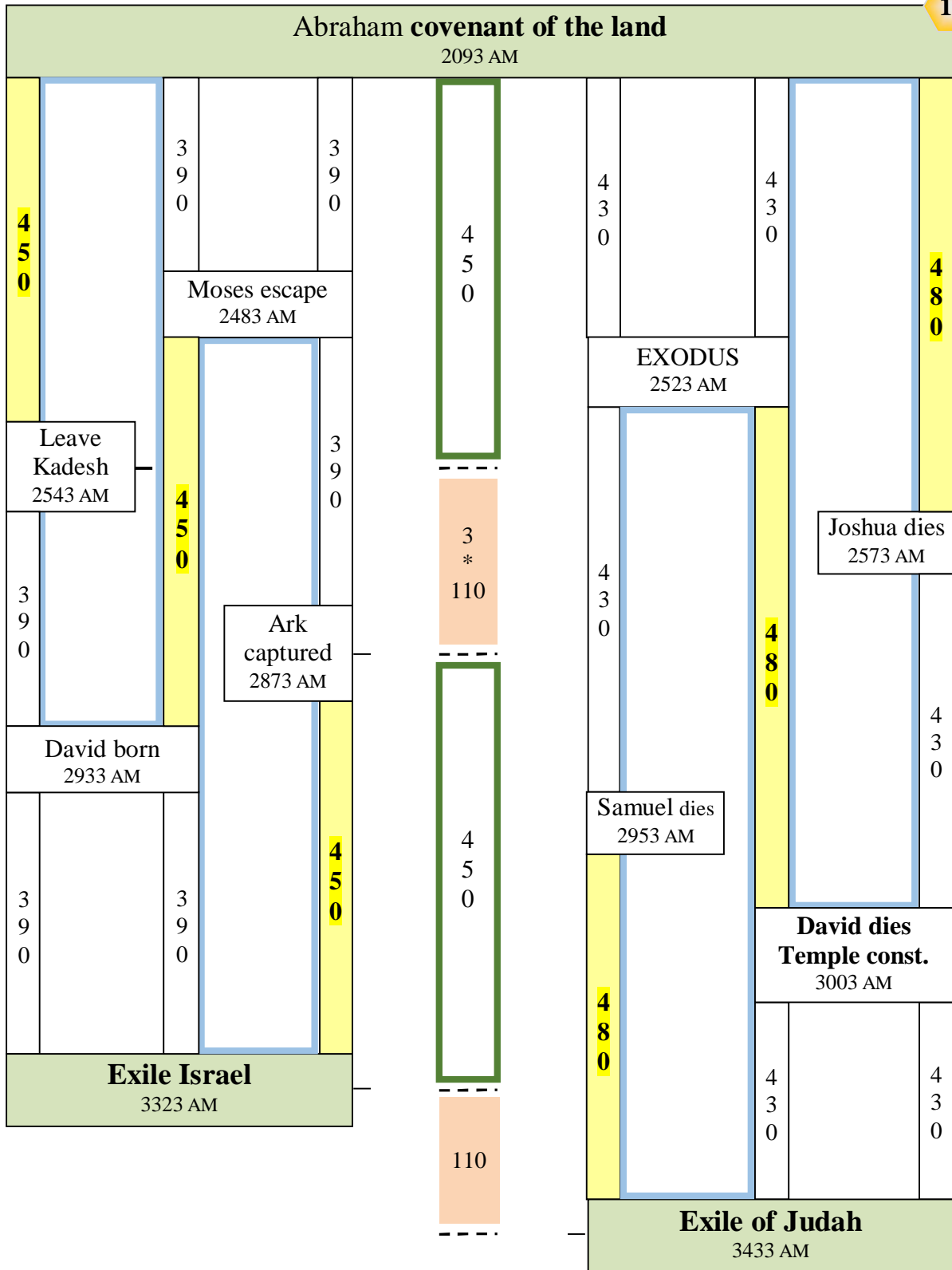

14

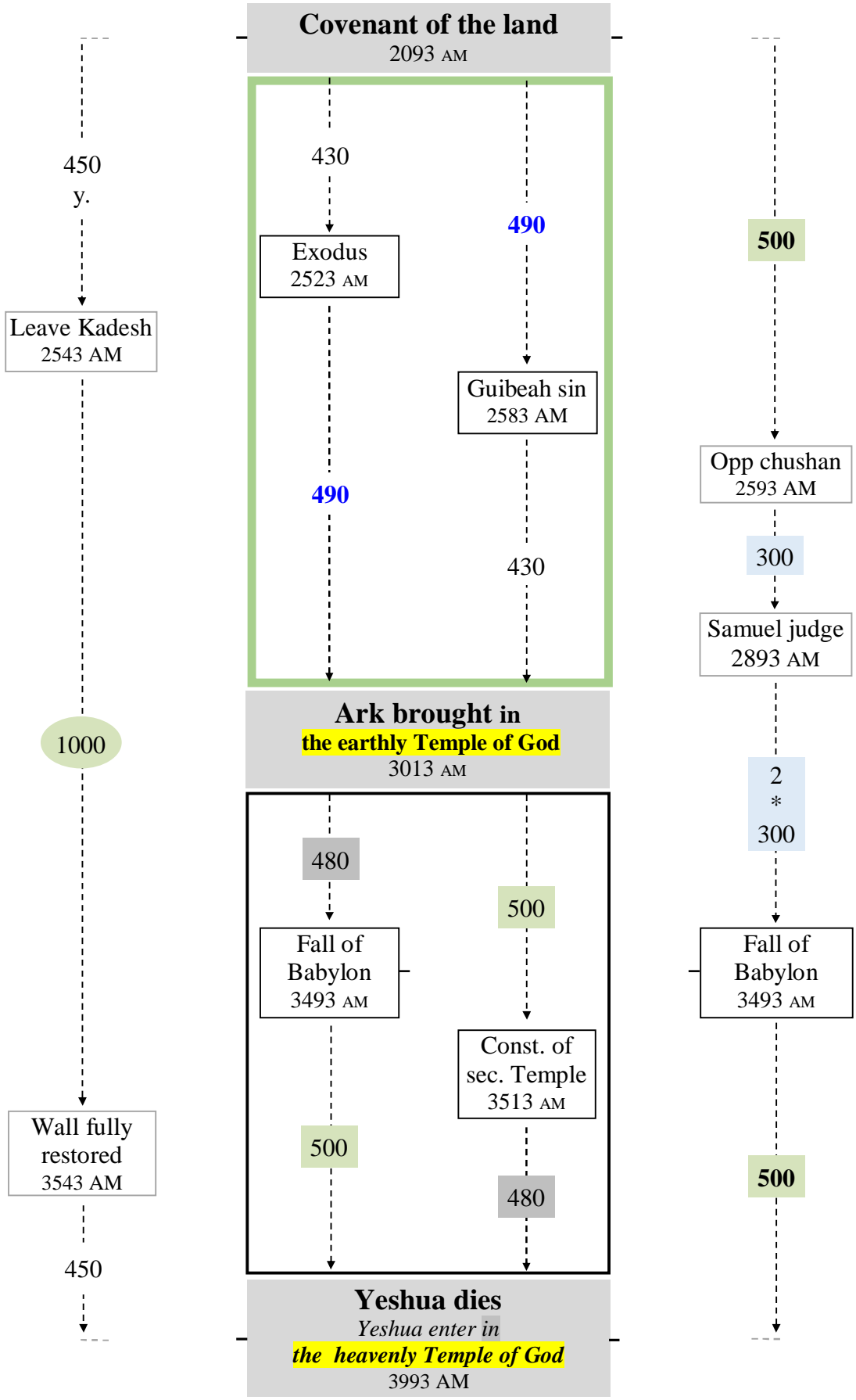

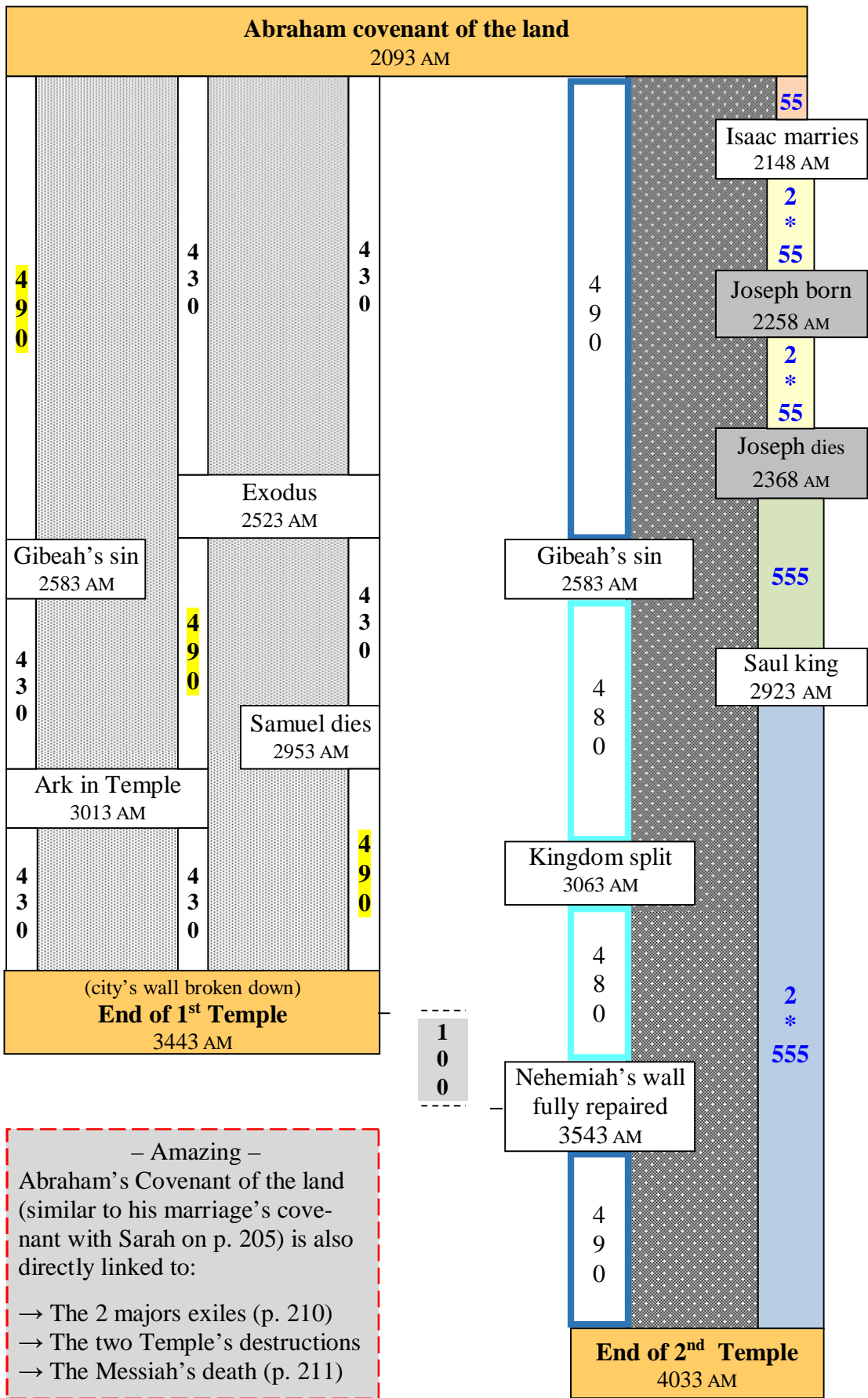

– Amazing –
Abraham's Covenant of the land (similar to his marriage's covenant with Sarah on p. 205) is also directly linked to:
→ The 2 majors exiles (p. 210)
→ The two Temple's destructions
→ The Messiah's death (p. 211)

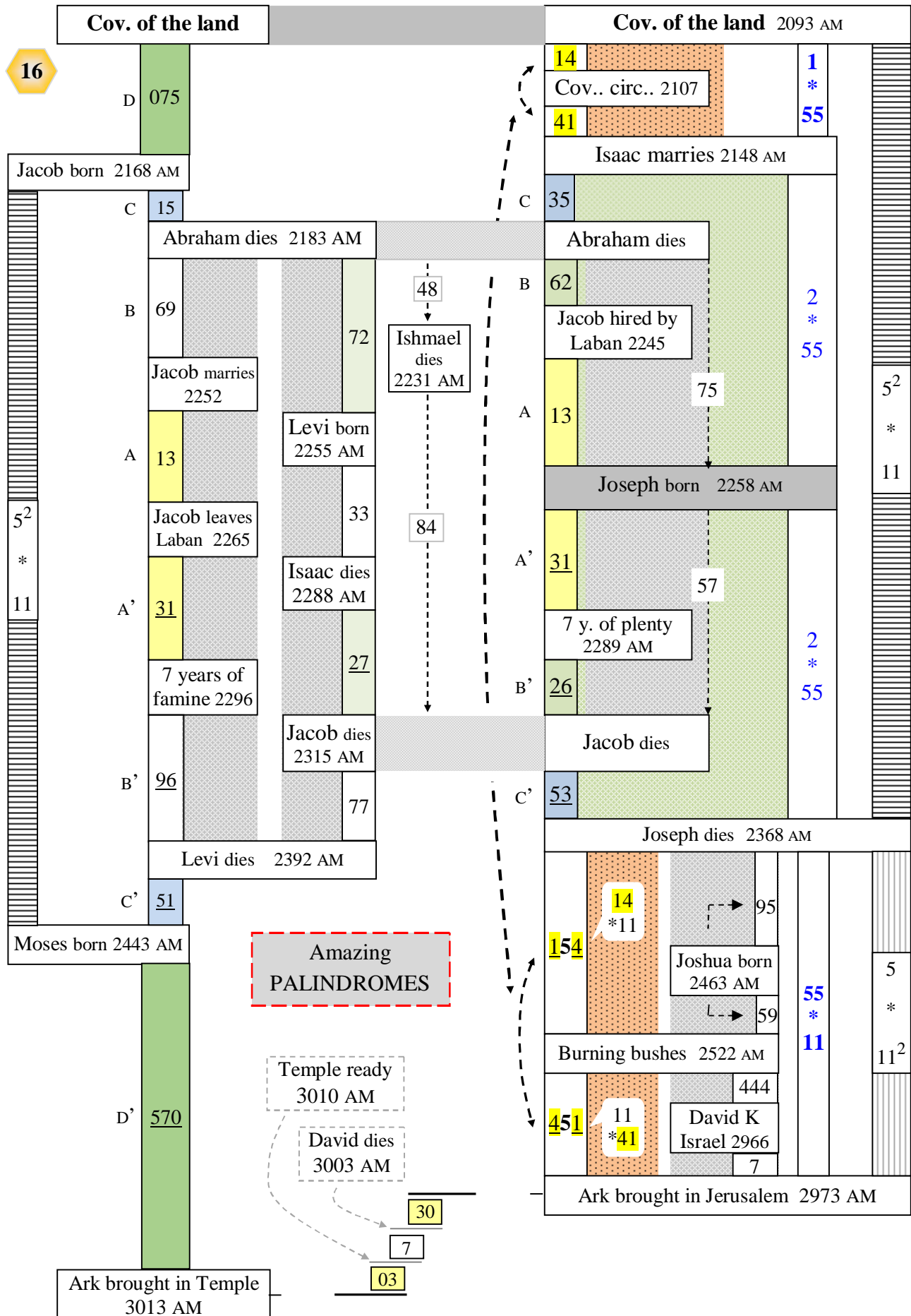

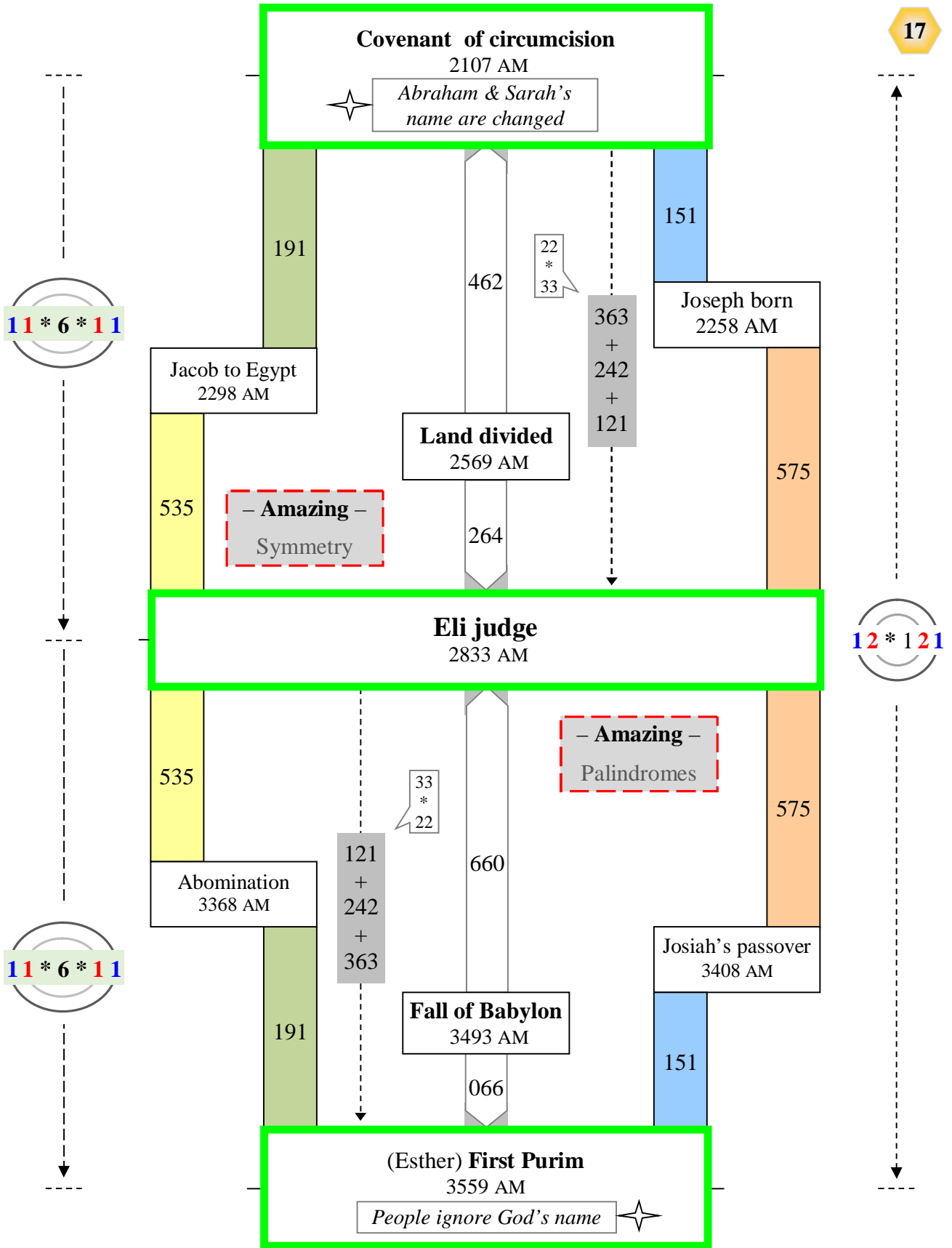

Binding of Isaac (AKEDAH)

2123 AM

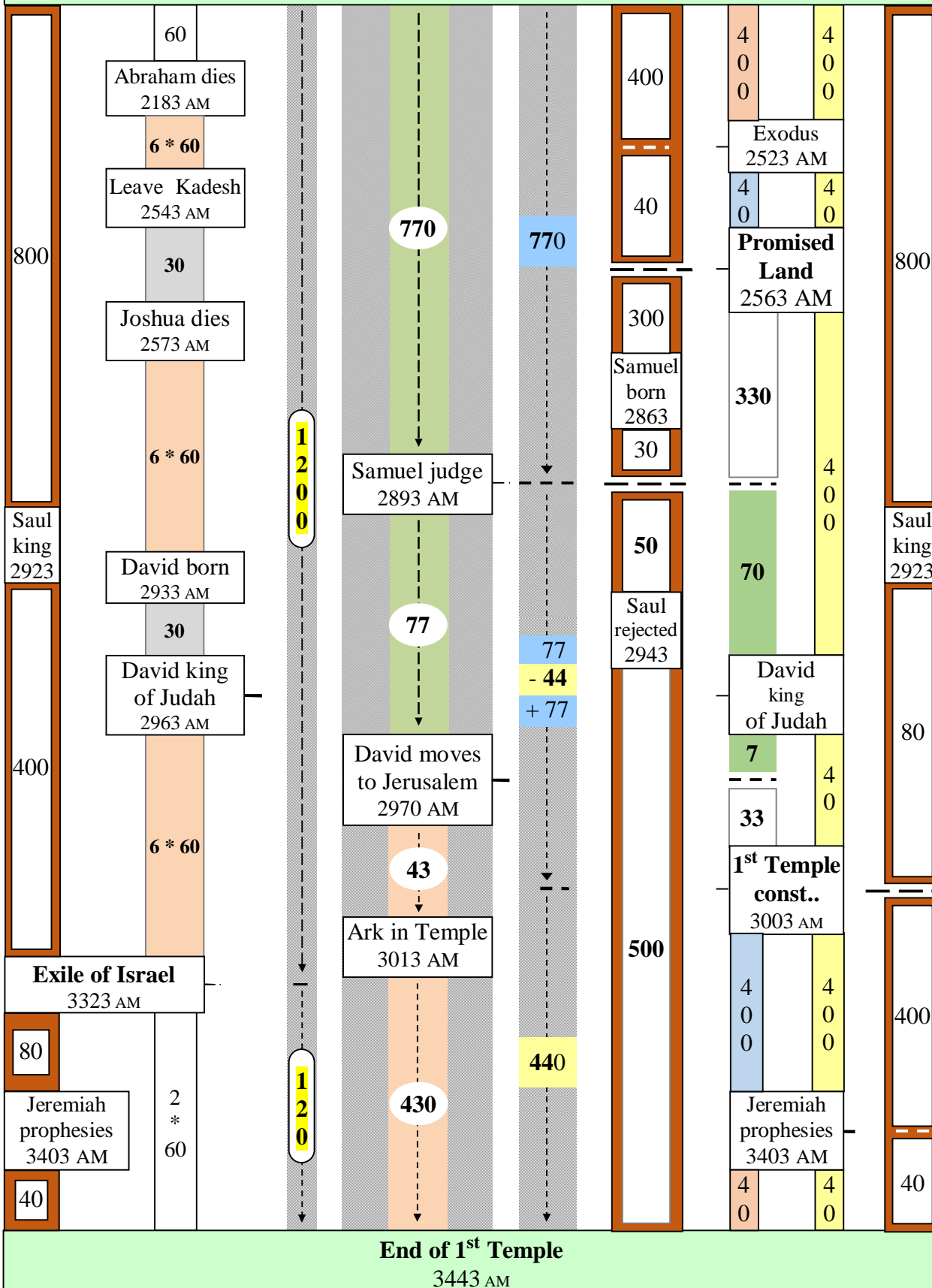

Two servants shared the first part of Isaac's journey. Gen 22 :3, 22 :5

AKEDAH: Binding of Isaac 2123 AM

(a RAM, "with head in a thicket of thorns", replaced Isaac)

At the last instant, the angel call out from heaven, Abraham, Abraham Gen 22:11

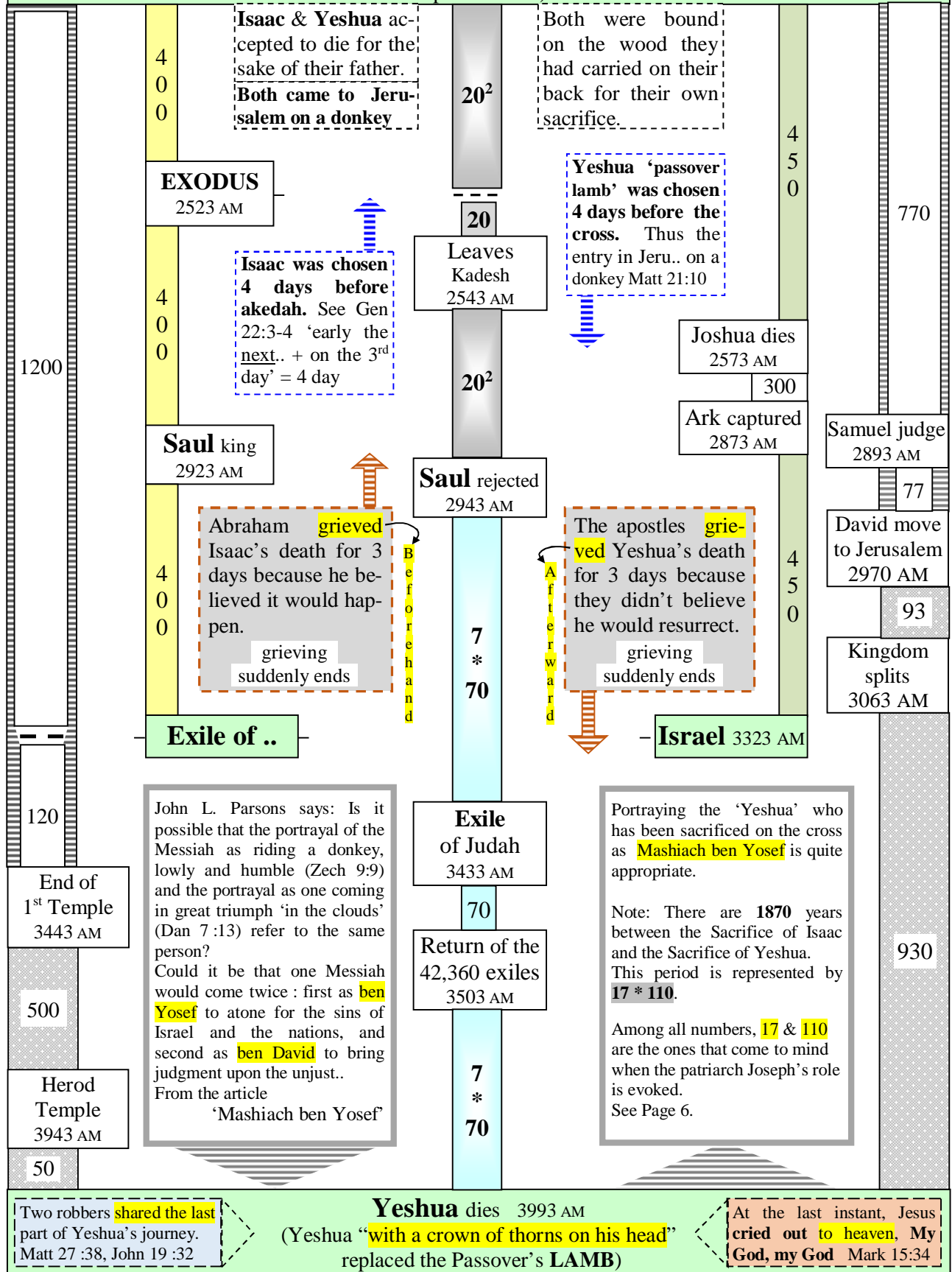

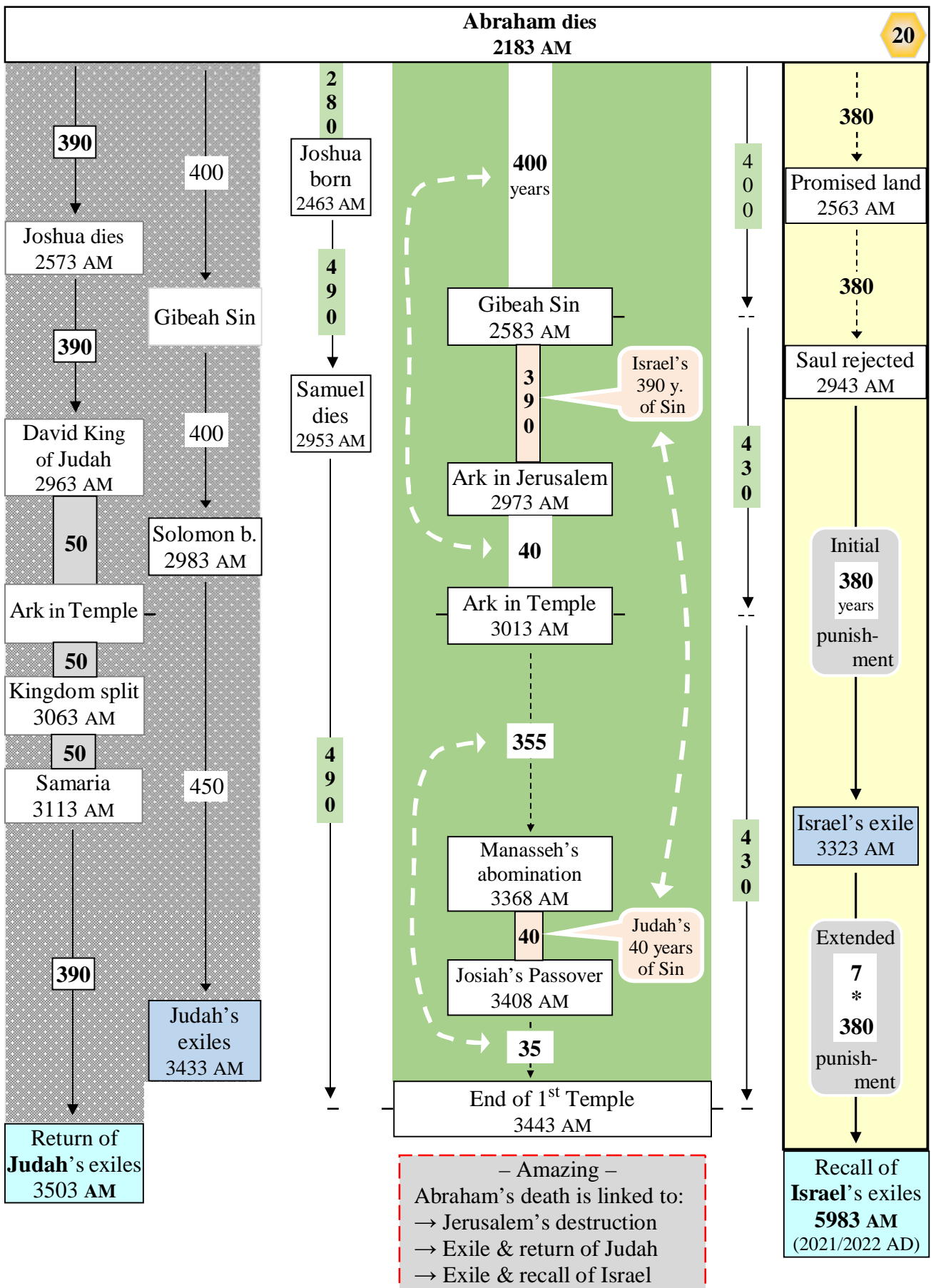

P
A
L
I
N
D
R
O
M
E
S

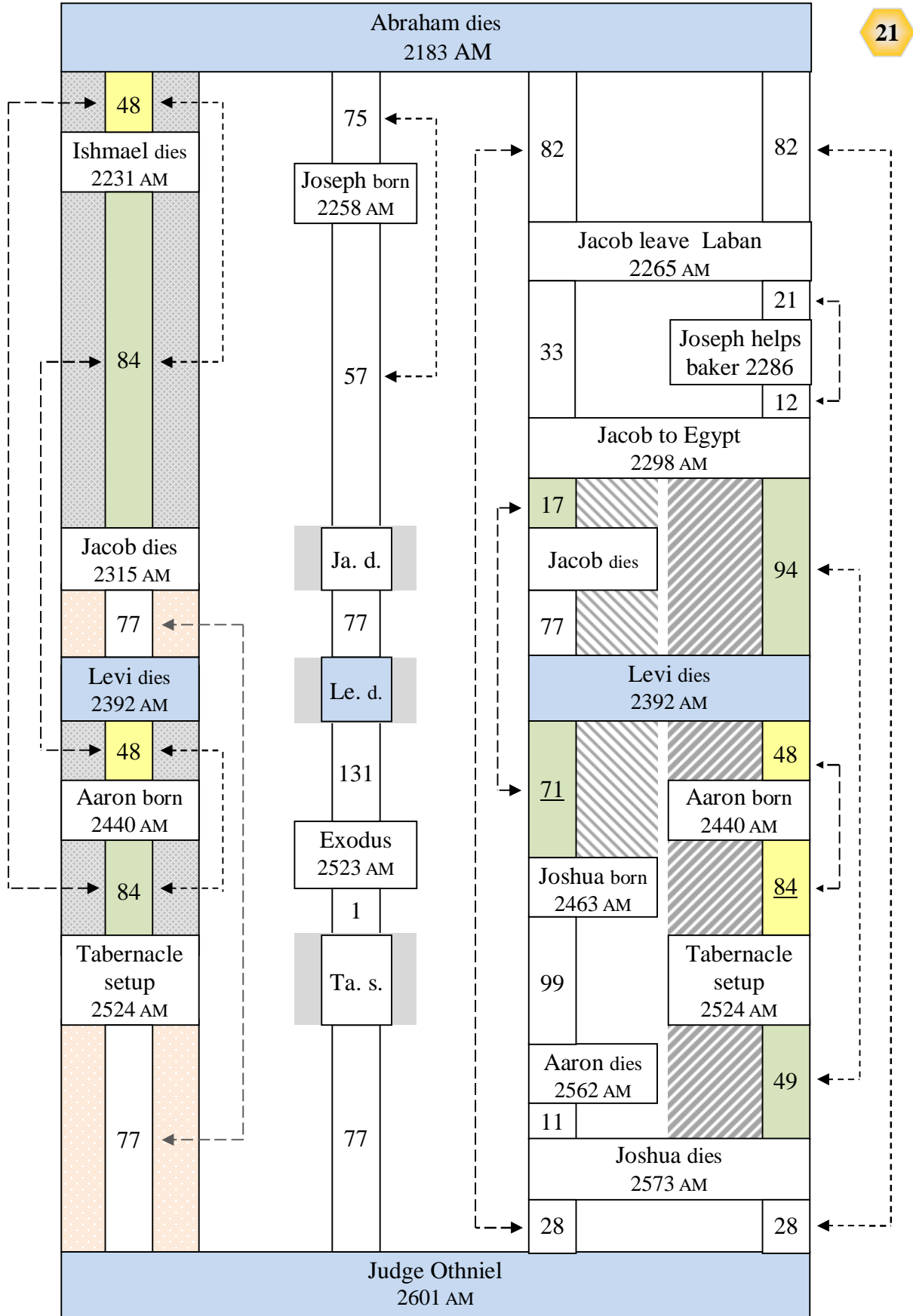

21

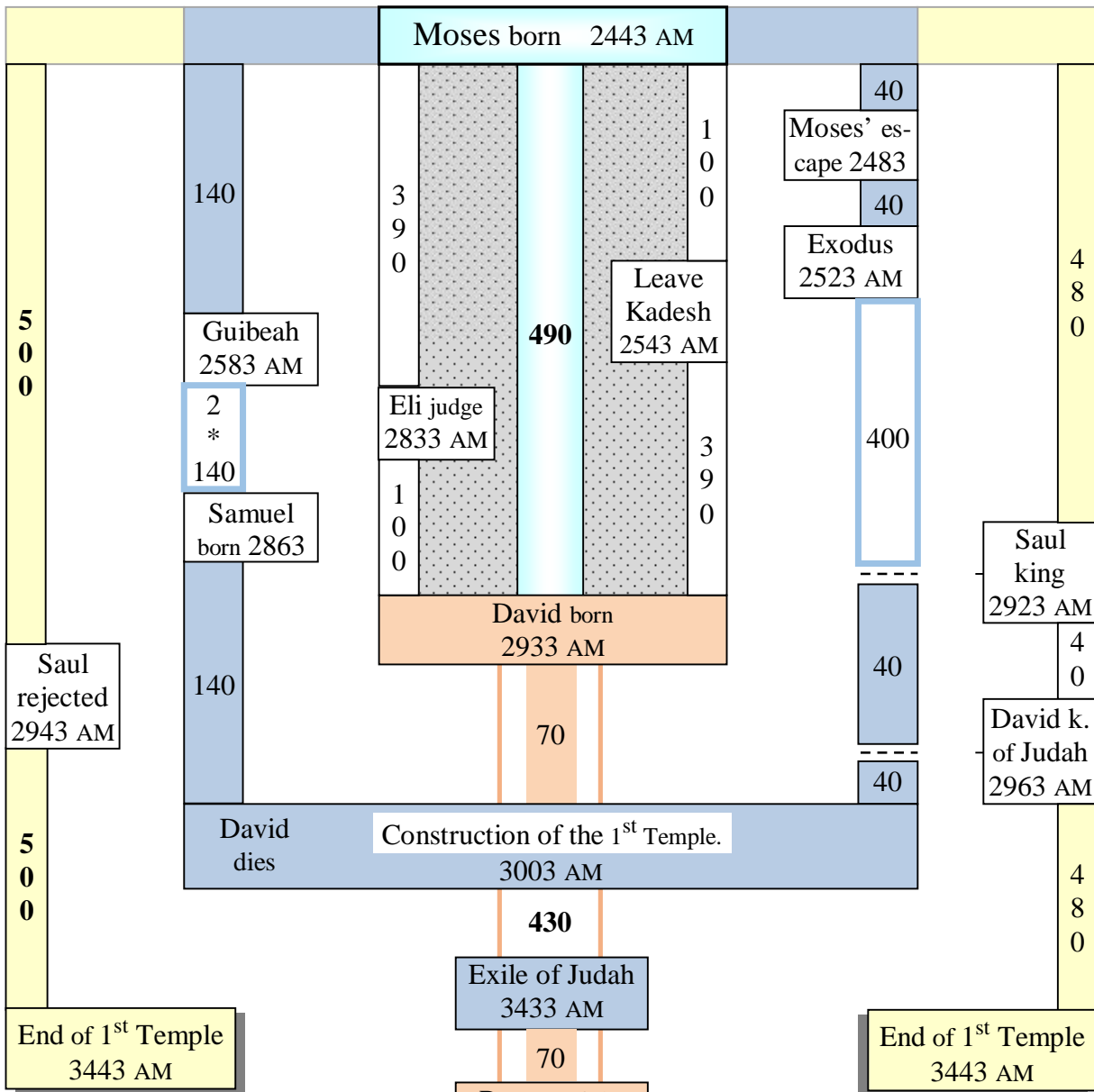

– Amazing –
 Moses' birth is directly linked to
 → Construction of the 1st Temple
 → Destruction of the 1st Temple
 → Exile of Israel
 → Death of Yeshua

Notice →

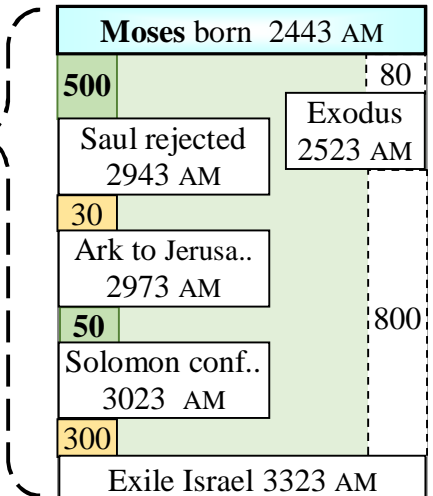

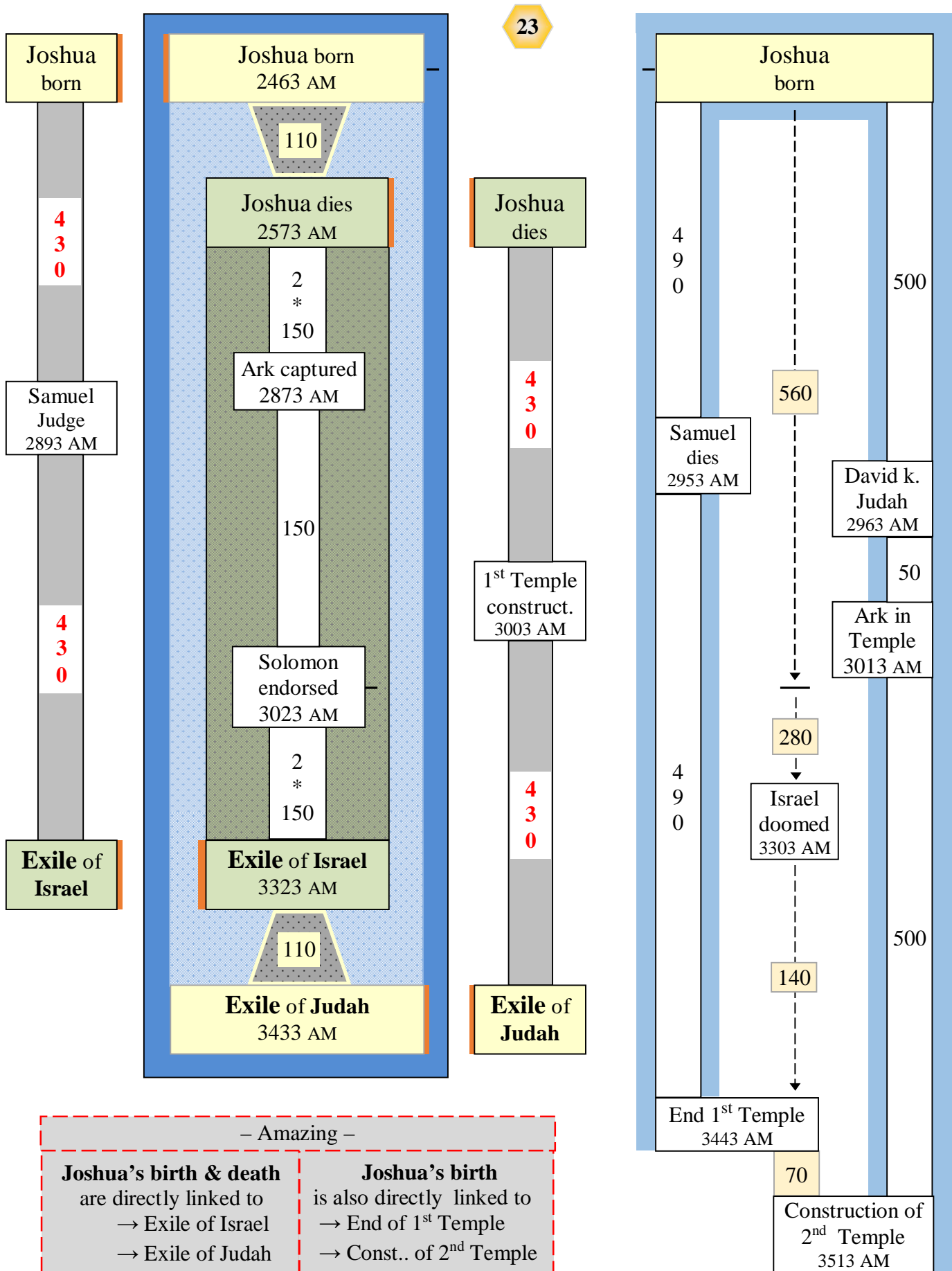

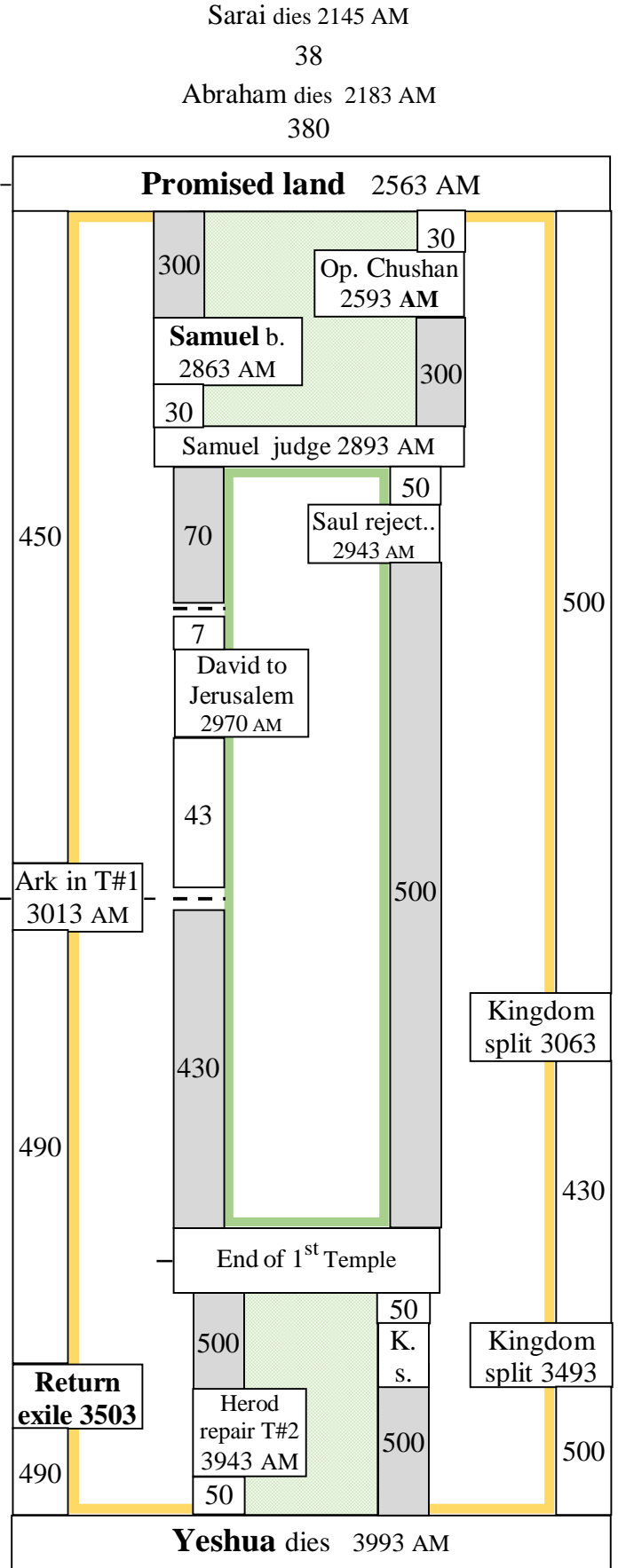
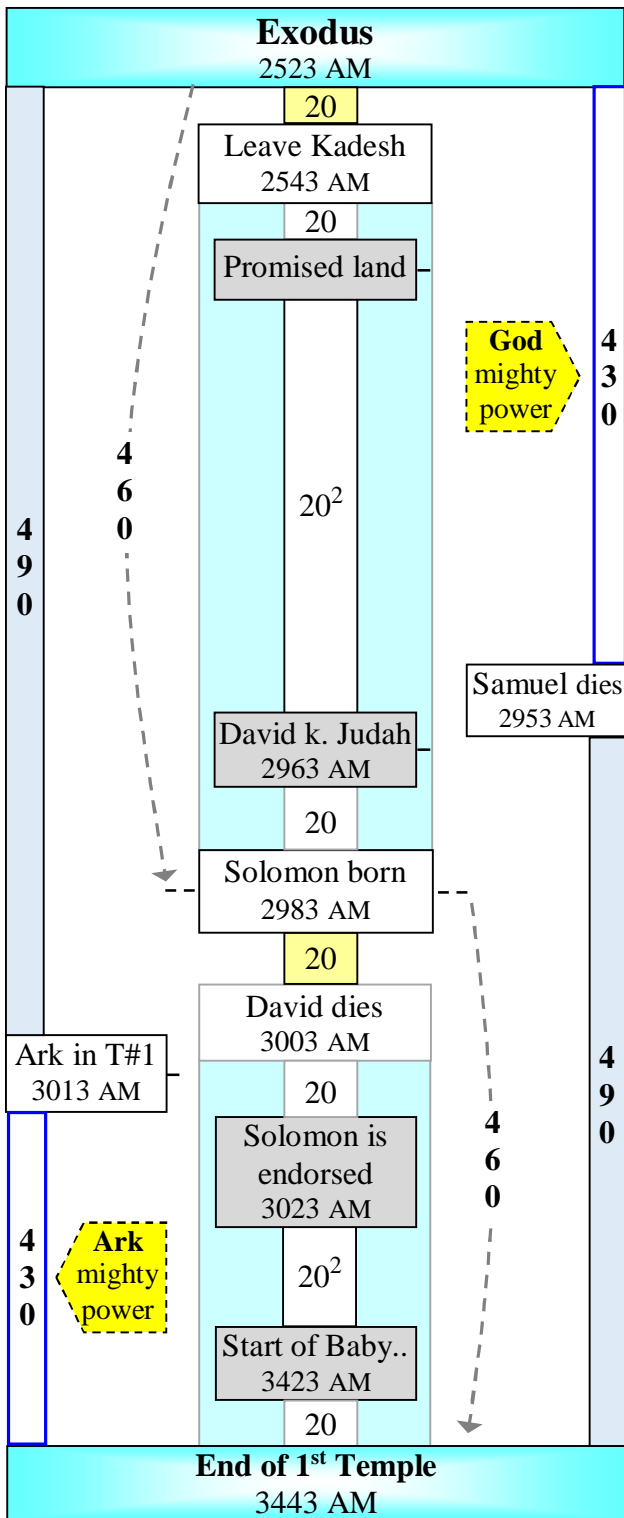

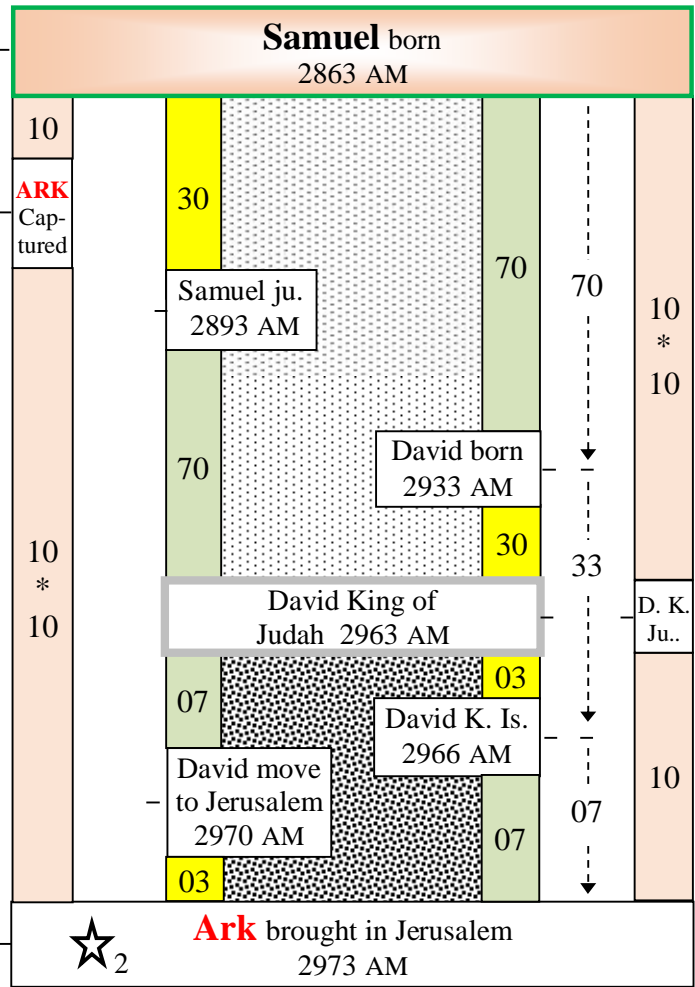
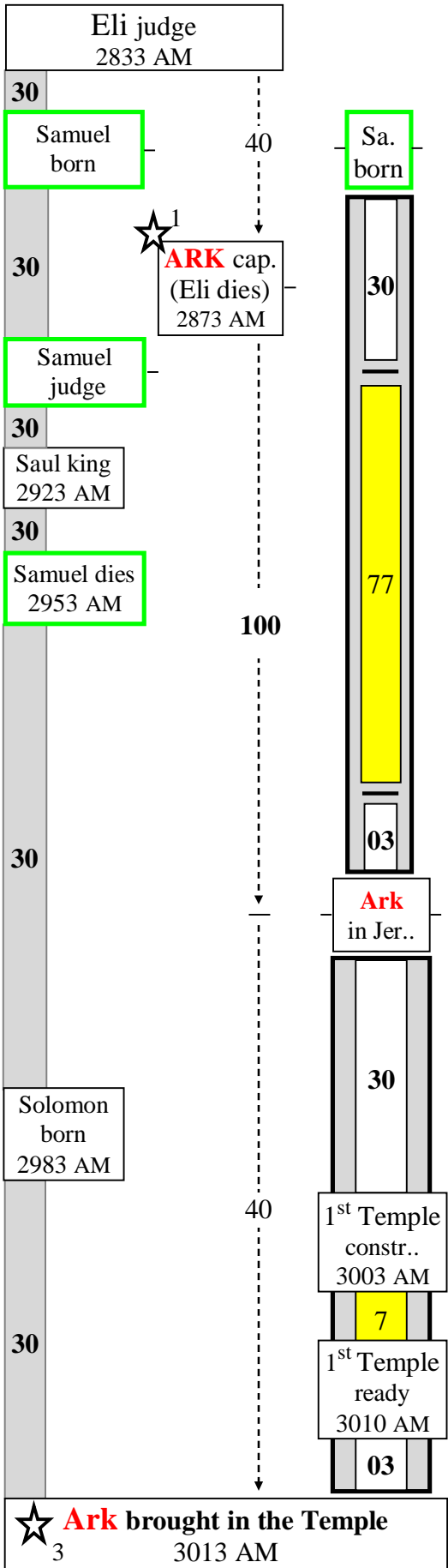

Notice →

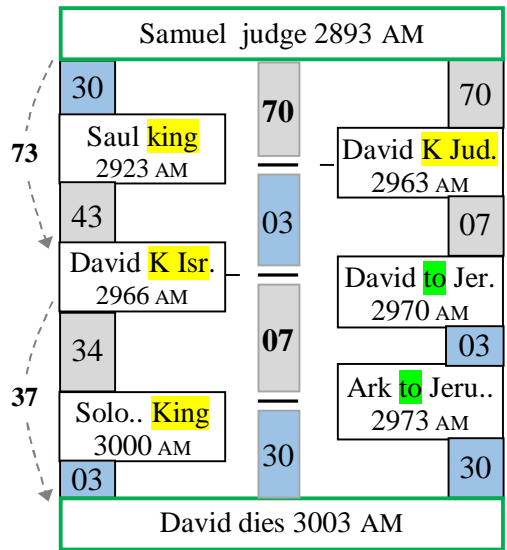

– Amazing –
Eli & Samuel linked to the 3 most critical Ark's episodes. ★

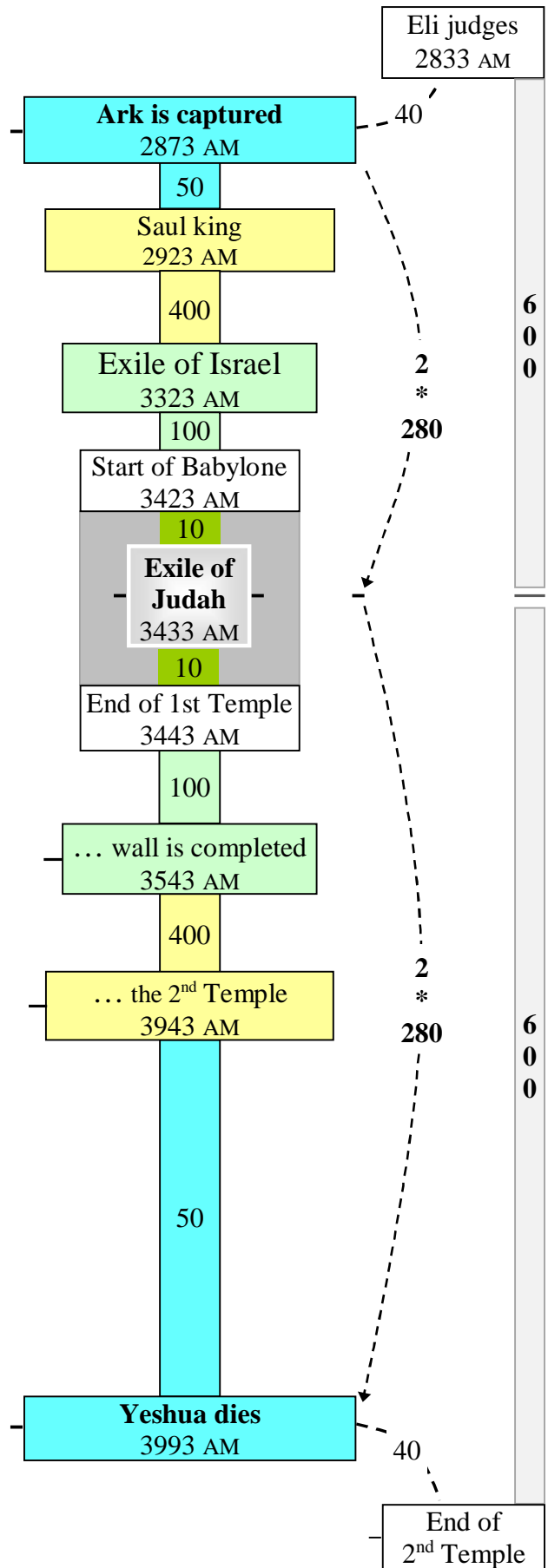
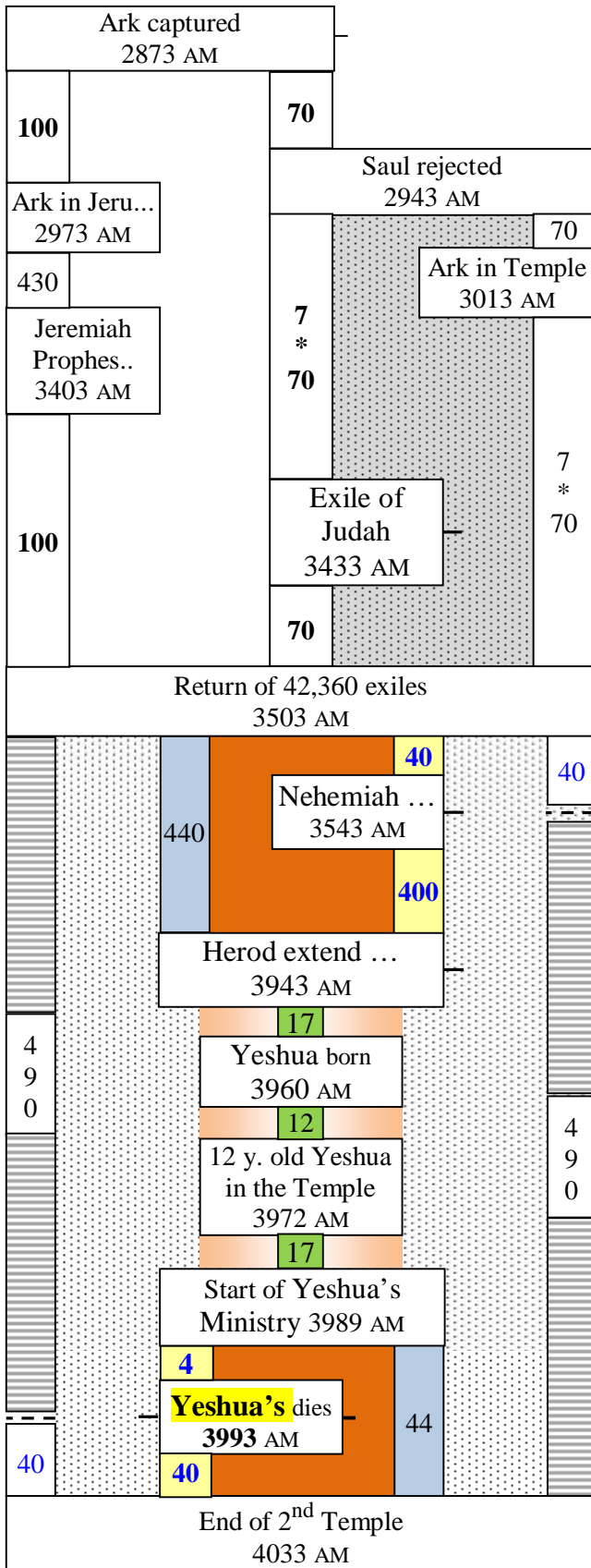

Ish-Bosheth King of Israel 2963
 2 y.
 Ish-Bo.. dies 2965

2 Sam. 2:10 Ish-Bosheth ..., and he reigned two years.

1 Chron. 29:27 He ruled over Israel **forty years**-seven in Hebron and thirty-three in Jerusalem.

27

- **Amazing** -
 Each event of David's life is part of a network of patterns

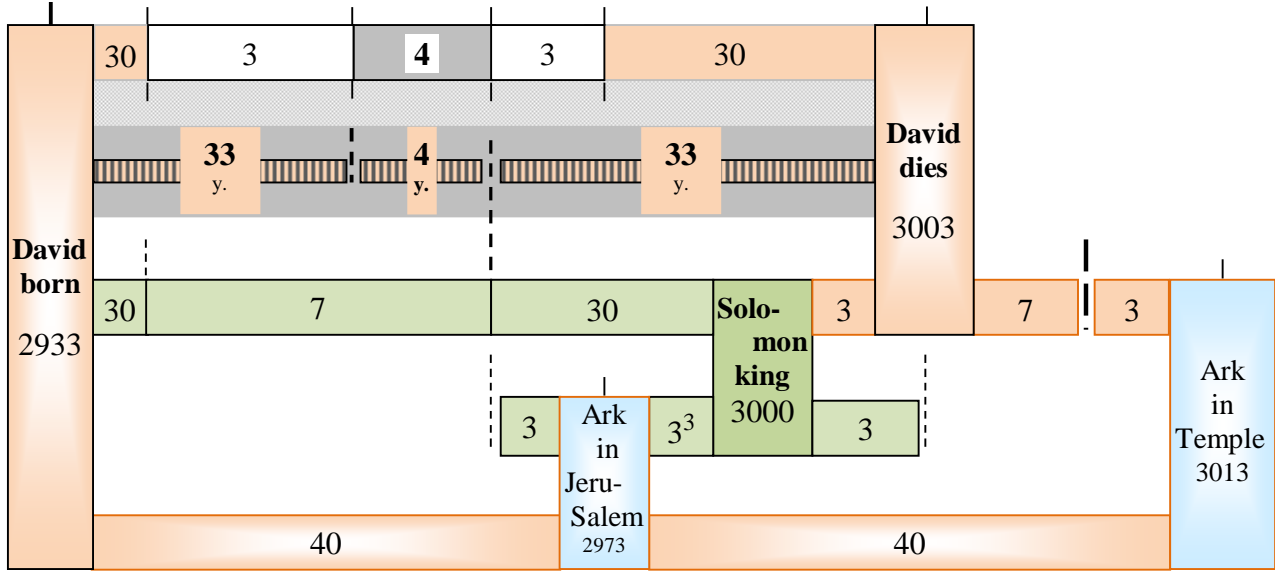
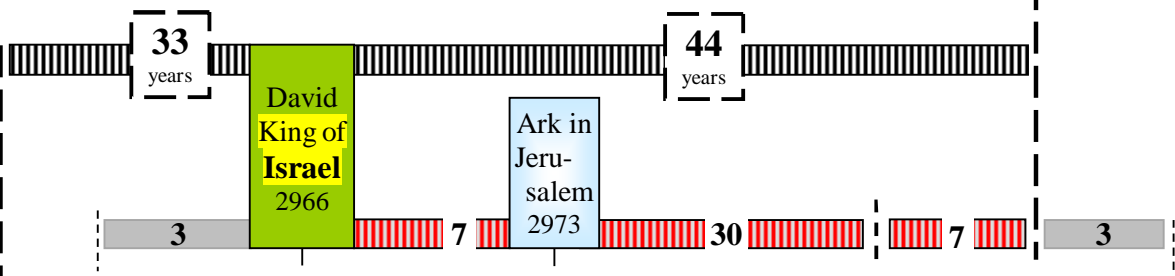
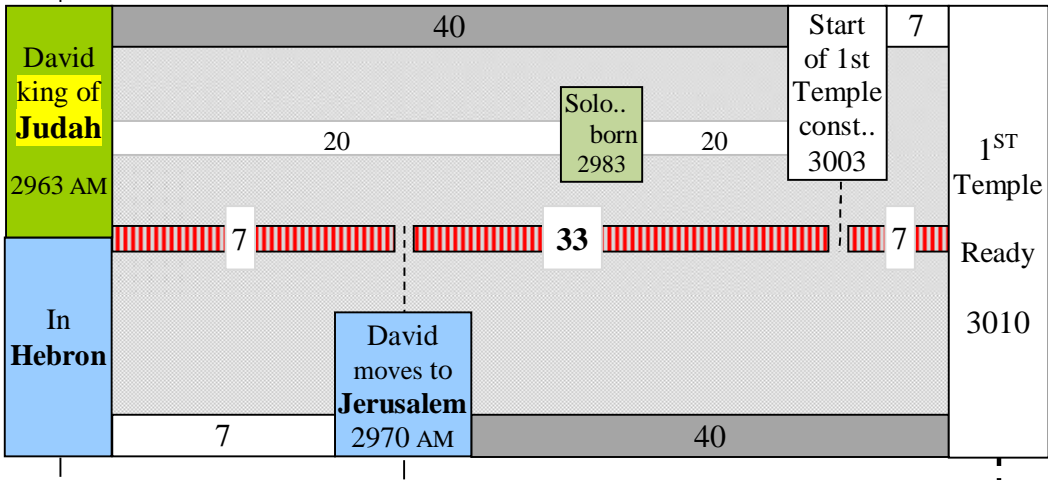

It is often assumed that David become **king of Israel** at the time he moved to Jerusalem in 2970 AM. This is unlikely. In the second year of Ish-Bosheth all Israel were eager to become David's subjects (2 Sam 3:17-18). Eventhough it could have been slightly delayed by the murders of Abner (2 Sam 3:27) and Ish-Bosheth (2 Sam 4:7) we read nothing that could have justify an additional five years wait (2965AM-2970).

1st	1 st Temple const.. 3003AM	T e m p l e
	7 y.	
	First Temple ready 3010 AM	
500		

- Amazing -
Perfect integration
of Daniel's
70 weeks

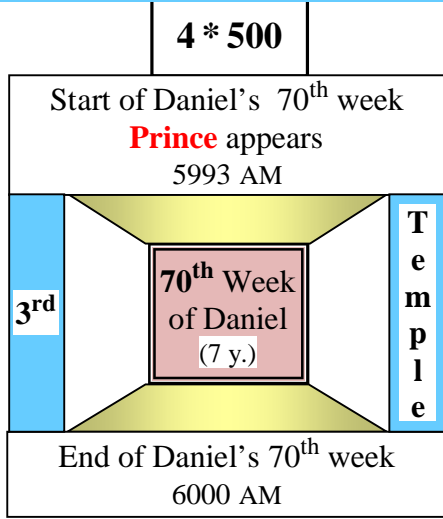
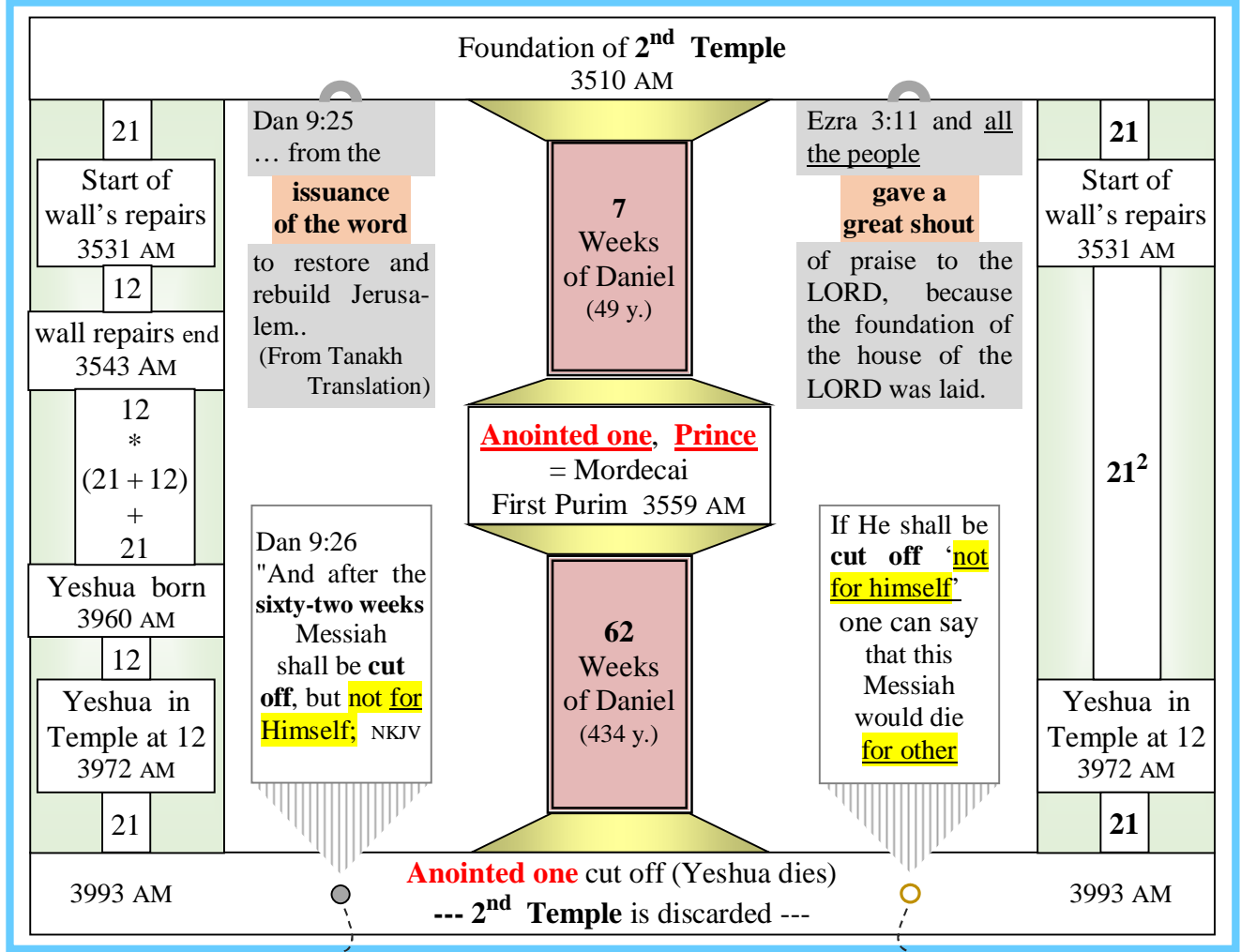

Isa 53:8 ... for
he was **cut off**
out of the land
of the living
KJV

John 11:51-52 Jesus would die for the Jewish nation, and not only for that nation but also for the scattered children of God	1 John 2:2 He is the at- oning sacrifice for our sins, and not only for ours but also for the sins of the whole world.
--	--

Conclusion

Could anyone still doubt the Bible's numeric information after having seen how it can be organized and presented in such a spectacular manner? In the light of all the patterns shown in this book we can deduce with some confidence that for almost 6000 years now, YHVH, the great architect of our universe, the God venerated by Abraham, Isaac, and Jacob, has patiently and subtly stirred mankind's progression across time, allowing some selected events to become special markers in His grand design.

In the present book Ezekiel 4-5 has been used to unlock the Bible's chronology in so many ways that we have now the proper date of more than 190 different events. Yet, during the reading of this book did you notice that a few events became much more highlighted than the others? They are **Abraham's covenant**, Akedah, Exodus, both exiles, events related to 1st and 2nd Temple and **Yeshua's death**. Isn't it surprising and quite revealing to have Yeshua's death among such a limited group? Who could deny that Yeshua's death occupies a major place in history when so many patterns exalt it? Among other thing this book has shown that his death stands on a direct numeric path with Adam and David.

Did you also notice that while Yeshua's death (and resurrection) was emphasized several times, his birth appeared to have been downplayed and kept out from most of the patterns? That was not a deliberate ploy from the author to minimize its weight. All the information related to Yeshua's birth was used in the best possible way, unfortunately in the end, oddly enough, there was very little to present. Is YHVH's chronology showing us, in a subtle way, that Yeshua's birth, by itself, was not that important? If that is the case, and the previous pages seem to claim it, then many people who believe in Yeshua's pre-existence or in his supposedly **innate** 'divinity' should see it as a clue that something doesn't add up. Why wouldn't a major event, like the '**incarnation**' of God among us, generates some of the strongest, most captivating and relevant connections whereas his death does just that?

Isa 43:10 Before me no god was formed, nor will there be one after me.

Deut 4:35-36 the LORD is God; besides him there is no other.

Trinity is irrational & unbiblical.
To say it is a mystery is to admit that the church's fathers, who formulated it more than 300 years after Yeshua's death, didn't understand it either.

1 Cor 8:4-5 We know that ... and that there is no God but one.

1 ≠ **③**

Deut 6:4 Hear, O Israel: The LORD our God, the LORD is one.

At most, trinity is speculative and a superfluous addition to the fundamental characteristic of the Supreme Being known as the God of Abraham, Isaac, Jacob, Ezekiel, Yeshua...

Gal 3:20 but God is one.

James 2:19 You believe that there is one God. Good! Even the demons believe that-and shudder.

In a paper called 'Unweaving The Trinity'¹⁰⁹, Noel Rude said: 'The mother of all Christological heresy, let me suggest, was the Virgin Birth – If it falls this does not take away from what is **central** to the New Testament, namely the **resurrection**.'

The plain truth is that Yeshua was born 'a son of man' and became 'the first son of God' at the **resurrection**. ⇨

Why are there so many people who have it backwards and persist in believing that Yeshua was first 'a son of God' and became 'a son of man' at his birth?

Paul said (Act 13:33) that when He **raised** Yeshua [from the dead] God **fulfilled** the promise written in the Psalms:

You are my son
Today I have become your father Ps 2:3

The following verse, also from Paul, says it in no uncertain terms:

Rom 1:3-4 concerning His Son Jesus Christ our Lord, who was born of the seed of David according to the flesh, and declared to be the Son of God with power according to the Spirit of holiness, **by the resurrection** from the dead.

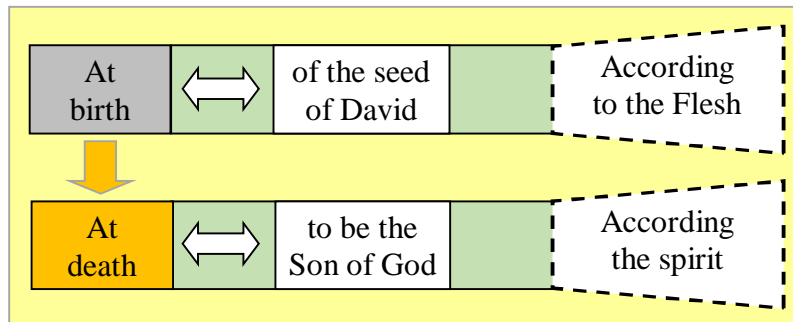

No matter that Yeshua's birth was foretold, that he was continuously filled with the spirit of God (John 3:34), that he manifested a perfect knowledge and observance of the Law, he couldn't have assumed the role of Messiah Ben Joseph if he hadn't carried the seed of Abraham. Let's remember that 'seed' is transmitted from father to son during human conception. It is clear that a virgin birth¹¹⁰ would have broken the chain and disqualified Yeshua.

- Gal 3:16 Now to Abraham and his Seed were the promises made. He does not say, "And to seeds," as of many, but as of one, "And to your Seed," who is Christ. NKJV

To those who recognize the importance of the seed, but argue that God could have miraculously planted the seed (or an embryo) in Mary's womb, it should be asked: What was then achieved with that pregnancy? Was there any need for it given that the unique characteristics of a human conception were all bypassed? YHVH created Adam from the dust of the earth; He could have as easily created the last Adam the same way:

- Matt 3:9 For I say to you that God is able to raise up children to Abraham from these stones. NKJV

Noel Rude asks: 'Why would the Bible preserve father to son genealogies from Adam to Joseph only to have Jesus adopted into this genealogy?' And he adds: '**The Virgin Birth doesn't square with the Torah and the Prophets**, but fits perfectly with the paganism of the period.'

The only scenario who could truly justify a virgin birth would be the one that would allow a celestial entity (God or whoever else) to transit from the spirit world to our physical one. But if you believe that this is what happened and that Yeshua was the personification of one of

¹⁰⁹ <http://www.hebdomad.com/article/list>

¹¹⁰ For more on "rejecting" the Virgin birth googles 'The Fiction of the Virgin Birth Wayne Simpson' .

these spiritual being you need to explain, in a convincing way, the following: Why did Yeshua had to go through a testing phase after his baptism.

- Mark 1:12-13 At once the Spirit sent him out into the desert, and he was in the desert forty days, being tempted by Satan.

It is obvious that this sojourn in the desert was to test his character. Three times he was pressured (Matt 4:3, 4:6,4:8) and had he indulged himself he would have been disqualified as our future savior. Notice that just before he was sent into the desert to be tempted the voice of God was heard (Mark 1:11). A similar thing happened about 1900 years before when Abraham heard God and was then challenged to offer Isaac as a sacrifice.

But contrary to Abraham, if Yeshua was the incarnation of God or some other pure and irreproachable spirit worthy to become our Savior, there was no need to test him. How could he had failed with his pre-existing background? When you think about it **the testing in the desert makes sense only if Yeshua was a simple mortal who was not immune against failure.** In this context the virgin birth was useless and could only have become part of the canon as the result of some well planned alteration of the text.

About the 6000 years. Nobody can deny that science is very good at refuting the timeline proposed in the Bible. To the creationists' 6000 years, science counters with an astronomically proven 14 billion year-old expanding universe. Science by definition extrapolates from what can be seen and what can be formulated. There is no room for faith in any of its equations. If it cannot be confirmed experimentally it cannot be.

That being said, Genesis never proclaimed that the Universe was created in its early stage. Was Adam created as an infant? Certainly not and any scholar who would have met Adam during the 6th day of the creation, would have concluded, from his own observation, that Adam had a mature physical body fully formed and therefore was in his adulthood, much older than the few hours that he really was. The point here is that both the Universe and men were created the way, and at the stage the creator wanted them to be.

If you believe the Bible, but nevertheless choose to confine the Genesis account to the domain of mythology (and many brilliant people do) how do you address the following few issues:

- ⇒ Without the creation week Adam has no special origin and Yeshua's genealogy is meaningless.
- ⇒ If God never rested on the seventh day what was the purpose of asking the Israelites to keep The Sabbath? (see Exodus 20:11)
- ⇒ Without the sin introduced in Eden what was the purpose of Yeshua's death?
- ⇒ If Cain & Abel story is a myth, why did Yeshua believed it? (Luke 11:51)
- ⇒ If the Flood never happened why were Matthew, Luke and Peter referring to it? (Ref Matt 24:38, Luke 6:48, 1 Peter 4:4).
- ⇒ If you believe that the Flood was only local, why did God tell Noah that never again a flood would destroy the earth? (Gen 9:11) Don't you know that local floods occur on a regular basis.
- ⇒ If the numbers mentioned in Genesis are meaningless where do we start accepting those we read at their face value? In Exodus? In Kings? In Ezekiel?

If you don't accept the straightforward reading of Genesis then you must be relating to science to explain our origin. Have you ever wonder what could have initiated the big bang? Do you really believe it is possible to have an 'effect' without a primary 'cause'? Yves Pélouquin

Appendix A From Adam to Abraham (the basic timeline)

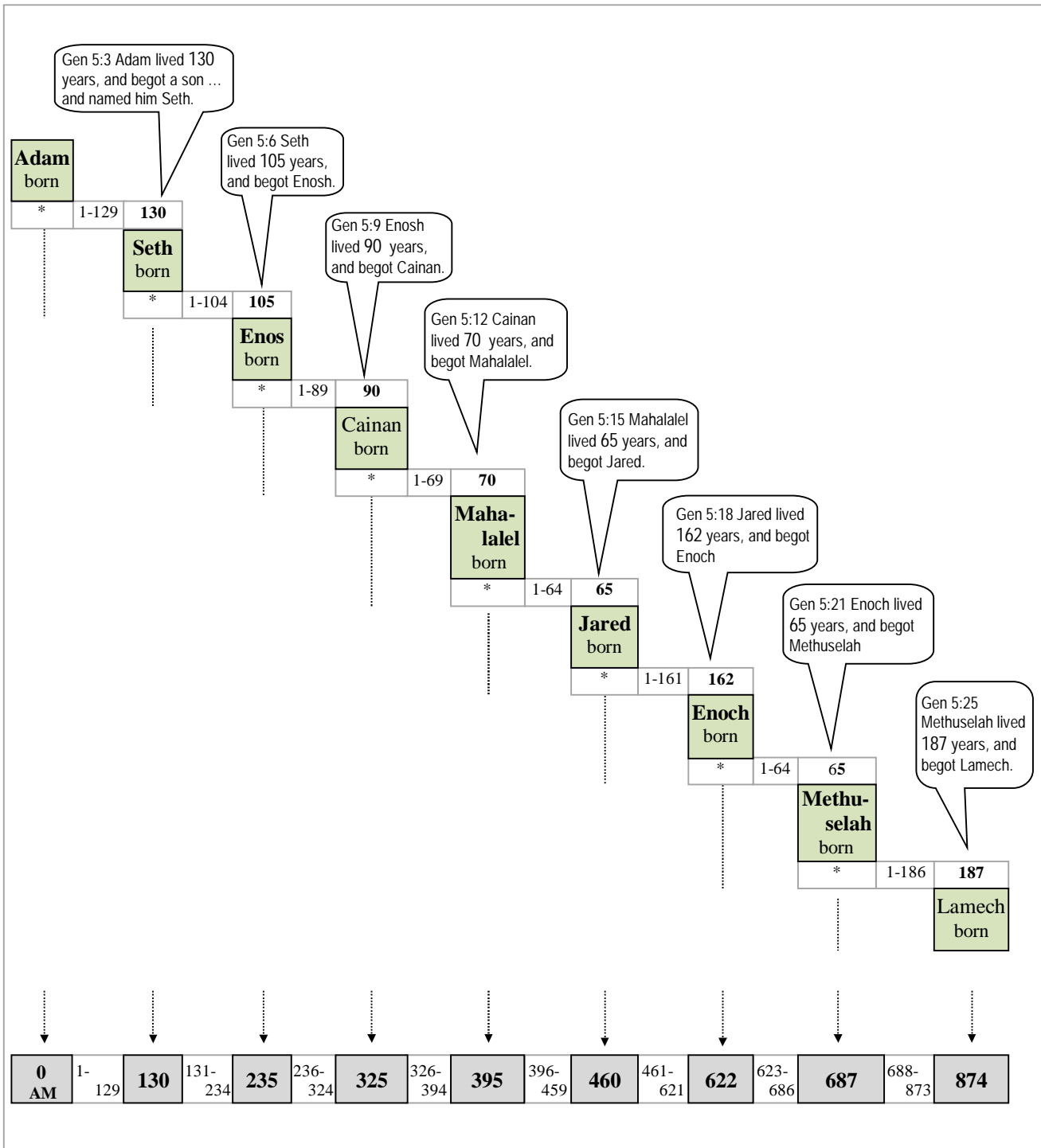

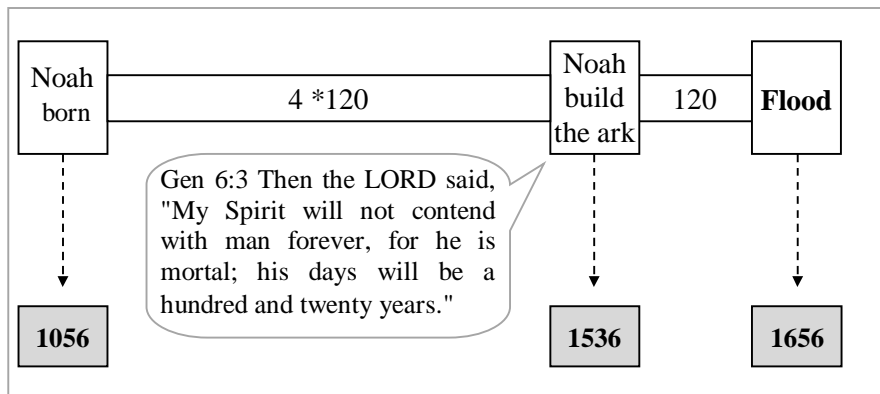
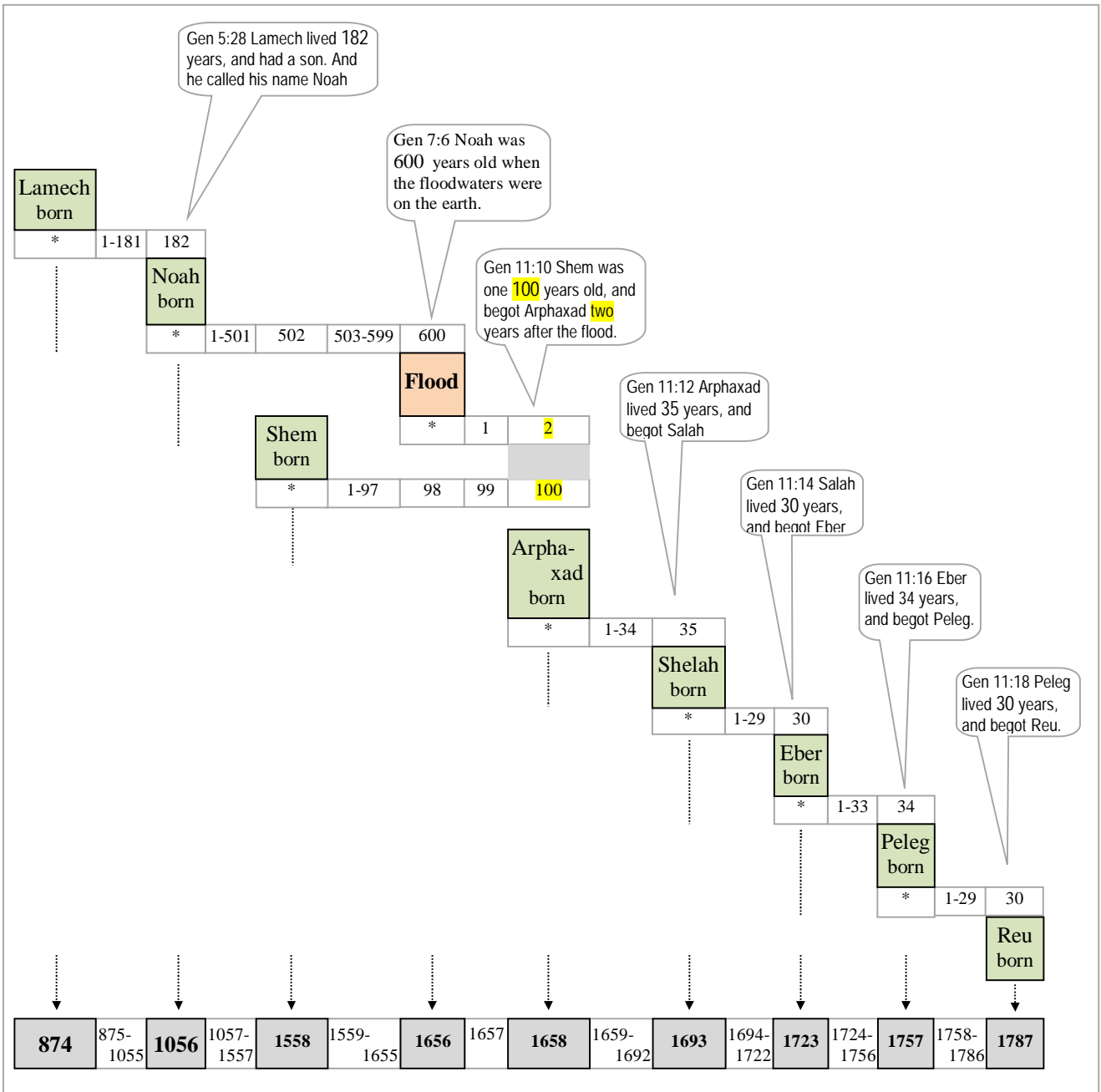

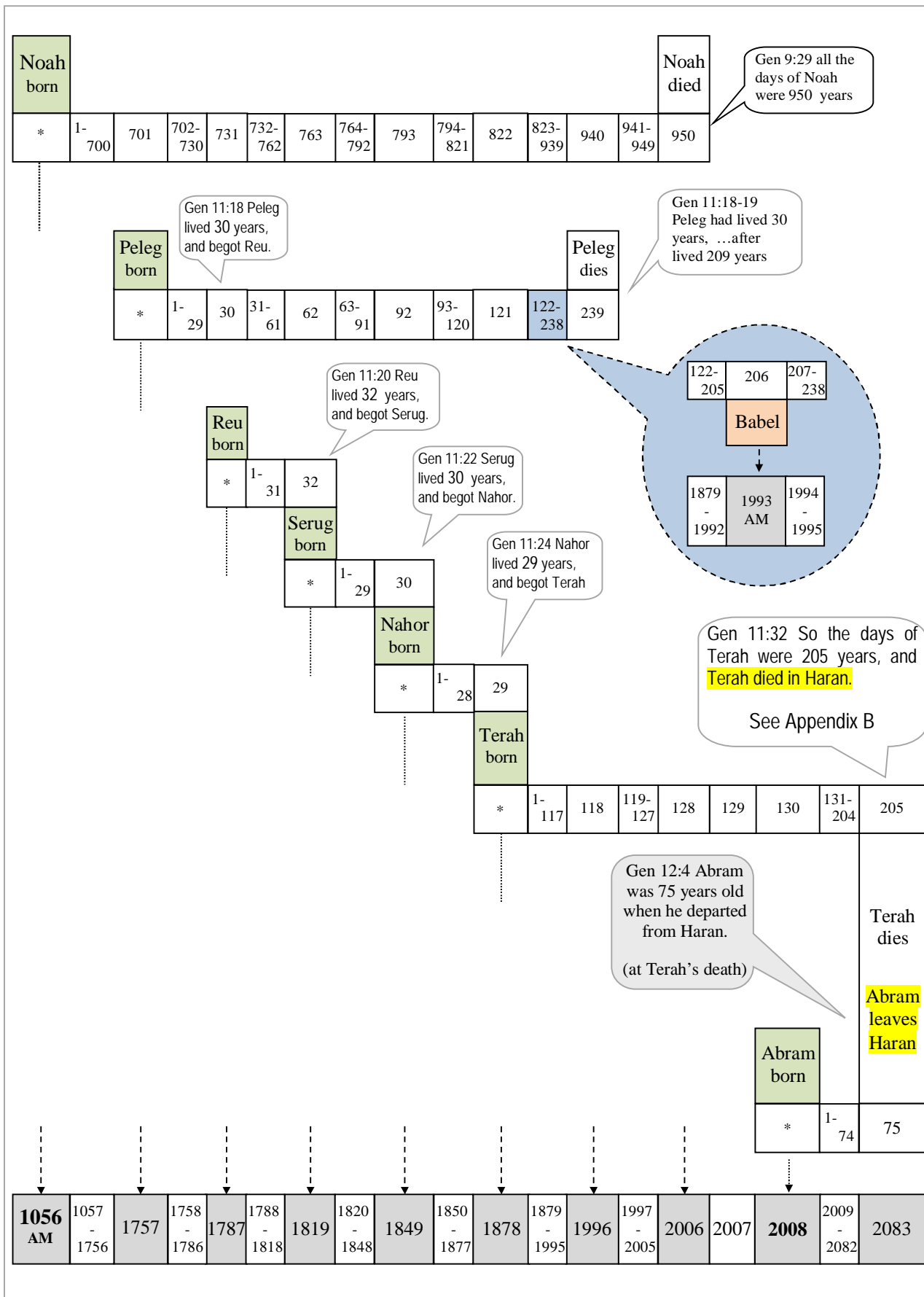

Appendix B Abraham's family tree

When was Abraham born?

- Gen 11:32 Terah lived 205 years, and he died in Haran.
- Gen 12:4 So Abram left, as the LORD had told him; and Lot went with him. Abram was seventy-five years old when he set out from Haran.

According the previous two verses Abraham was 75 years old when he left Haran "at his father's death".

First conclusion : Abraham was born when Terah was 130 years old (205 – 75).

However, according to the next verse, Abraham was born when Terah was 70 years old.

- **Gen 11:26** After Terah had lived 70 years, he became the father of Abram, Nahor and Haran.

Sec. conclusion : Abraham could have been born when Terah got 70 years old.

Given these two conclusions cannot be right at the same time there must be a way to reconcile Gen 11:32, 12:4 and 11:26?

First, unless Terah was the father of triplet, and it is very unlikely given the absence of any Bible's comment on such an extraordinary fact, you have to admit that **Gen 11:26** only say that Terah got his first son when he was 70, the other two sons came to him in the latter years. But, if this is the case, wouldn't it mean that Abraham, the first name to be listed, was born when Terah was 70? No. Being the first in the list doesn't mean that he was the first born. There is a precedent worth to be examined.

From the following two verses you could be inclined to think that **Shem** was Noah first son, after all he is listed first¹¹¹ in both cases.

- Gen 5:32 After Noah was 500 years old, he became the father of **Shem**, **Ham** and **Japheth**.
- Gen 10:1 This is the account of Shem, Ham and Japheth, Noah's sons, NIV

However, here it is clearly said that **Japheth**, not **Shem**, was the oldest son of Noah.

- Gen 10:21 Sons were also born to Shem, whose older brother was **Japheth**;

Back to Abraham. The readers would correctly point to the fact that Gen 11:32,12:4 don't especially say that Abraham left Haran at the death of Terah. I agree with the reader, Gen 12:4 doesn't say it, but, **Stephen, under inspiration did.**

- Acts 6:5 They chose Stephen, a man full of faith and of the Holy Spirit;
- Acts 7:4 "So he left the land of the Chaldeans and settled in Haran. **After the death of his father**, God sent him to this land where you are now living.

In 2008 AM, the 130 years old Terah (born in 1878 AM), got his son Abram.

¹¹¹ Could have been done as a sign of the future prominence of the individual.

Terah had 3 children: Abam, Nahor, Haran

- Gen 11:26 After Terah had lived 70 years, he became the father of **Abram**, **Nahor** and **Haran**.

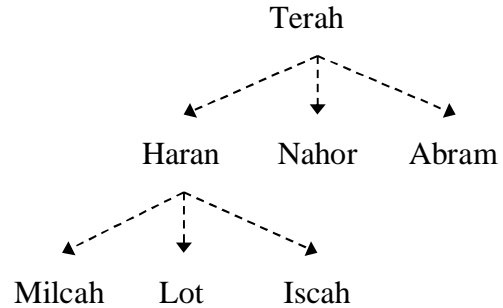

Haran, Abram's brothers, had also three children: Lot, Milcah and Iscah

- Gen 11:27 And Haran became the father of Lot.
- Gen 11:29 ... Haran, the father of both Milcah and Iscah.

It is believe among jewish sages that **Iscah is none other than Sarai**¹¹² (the girl who would become Abraham's wife). Both names, **Iscah and Sarai**, means "princess". Sarai is therefore the sister of Milcah and the niece¹¹³ of Abram.

Immediately **after mentionning Haran's death** the Bible tell us that Abram took a wife called Sarai and Nahor took also a wife called Milcah.

- Gen 11:28-29 And Haran died before his father Terah in the land of his nativity, in Ur of the Chaldees. And Abram and Nahor took them wives: the name of Abram's wife was Sarai; and the name of Nahor's wife, Milcah, the daughter of Haran, the father of Milcah, and the father of Iscah.

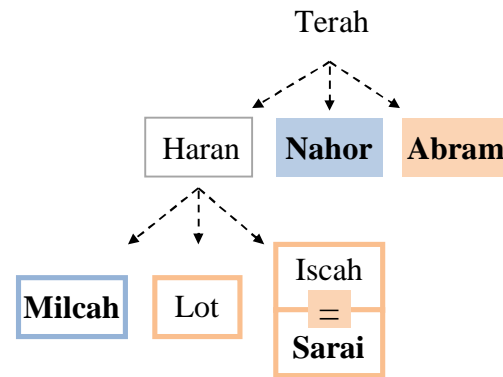

Beside this strange situation (two brothers marrying their nieces), we also learn that Abraham developed a father-son relationship with his nephew Lot.

- Gen 12:5 He took his wife Sarai, his nephew Lot,
- Gen 13:1 So Abram went up from Egypt to the Negev, with his wife and everything he had, and Lot went with him.

It is clear here that, after their father's death, the three children of Haran became the responsibility of their two uncles Abram and Nahor. But why?

Now wouldn't it shed more light on the whole situation if Haran had been the eldest son of Terah, the one born when he was 70 years old? If it was the case we could argue that the two youngest brothers (Nahor and Abraham) assumes the 'unwritten moral obligation' to provide for their oldest brother's posterity.

¹¹² The structure of Gen 11:29 also imply that Iscah and Sarai are the same one.

¹¹³ Doesn't it contradict Gen 20:12 where Abram says that Sarai was his half sister?

- Gen 20:12 And yet indeed she is my sister; she is the daughter of my father, but not the daughter of my mother; and she became my wife. KJV

I asked the opinion of Rabbi David Foreman about this question and here is his answer:

<< its a euphemism of niece; i.e. she is his "sister" in the sense that she is the daughter of his brother. You find a similar expression with Lot, when Abraham says "anashim achim anachnu" we are brothers. It doesn't mean literally brothers, it means we have a "brother like" relationship, in the sense that you are the son of my brother >>

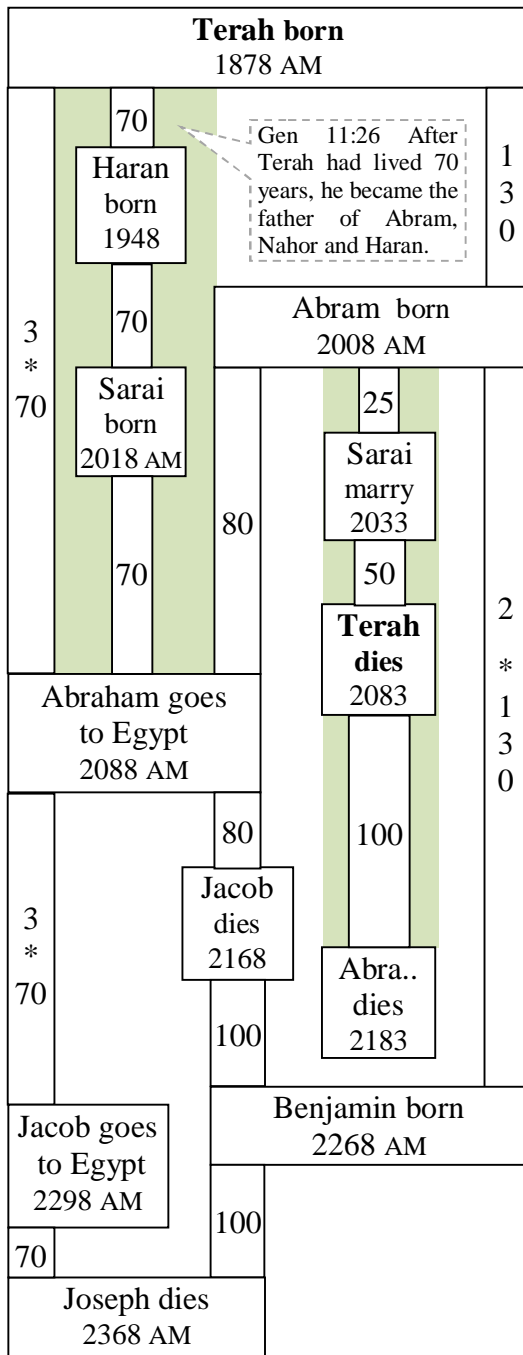
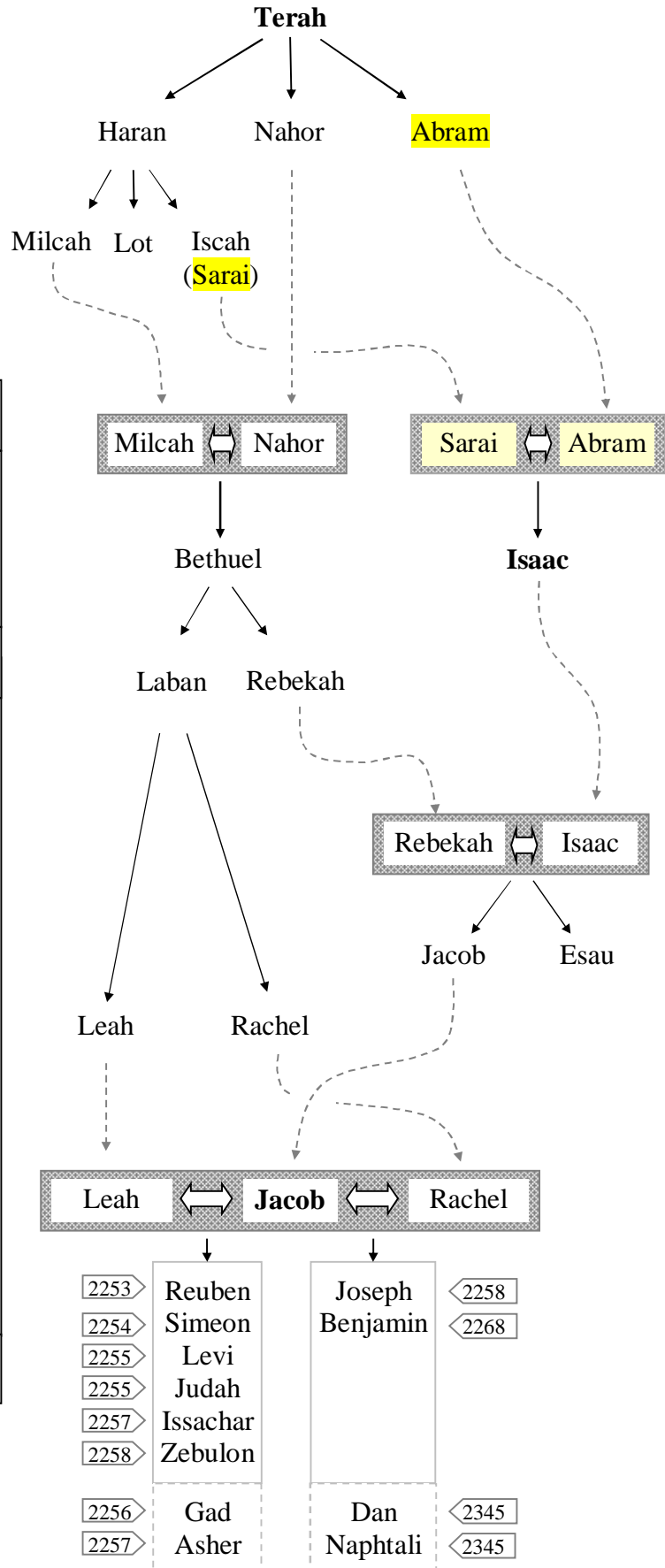

Appendix C Akedah Exodus Crucifixion

We are so familiar with the story of Abraham going to Moriah to ‘bind’ and sacrifice his son Isaac (the Jews call this ‘binding’ AKEDAH), that we never pause to question the incongruity and meaning of some details in the narrative.

- Gen 22:2-4 Then God said, "Take your son, your only son, Isaac, whom you love, and go to the region of Moriah. Sacrifice him there as a burnt offering on one of the mountains I will tell you about." **Early the next morning** Abraham got up and **saddled his donkey**. He took with him two of his servants and his son Isaac. When **he had cut enough wood** for the burnt offering, he set out for the place God had told him about. On the third day Abraham looked up and saw the place in the distance. NIV

→ Why is-it said that Abraham started ‘early’ the next morning?

I read somewhere that “Abraham eagerly awake the next morning anxious to embark on his religious mission”. Really? I think that only a sociopath would have been ‘eager’ to get up that first morning. Was it more pleasing to God that Abraham **express zeal** and show no concern for Isaac instead of some hesitation and perceptible reluctance to start such dreadful and excruciating pilgrimage?

→ Why did Abraham cut the wood 3 days ahead of time?

It doesn’t make sense when you think about it. Why did he bother to bring this heavy and cumbersome payload with him when he knew that on the mountain he was going to, as on any other mountain for that matter, he could have found plenty of wood to feed the fire of the burn offering.

- Gen 22:2 ... and go to the region of Moriah. ... on one of the mountains I will tell you about." NIV

→ Why did Abraham saddle the donkey himself?

Wasn’t it the task of a servant¹¹⁴ to saddle his master’s donkey? Why did Abraham took care of such a meaningless task on one of the worse day of his life? Beside that, isn’t it a little peculiar that the author of Genesis thought it was an essential fact to transmit to us while he kept so much more information under silence?

- Gen 22:3 ... Abraham got up and saddled his donkey. NIV

→ Why did Abraham use only one donkey for an expedition of four people?

¹¹⁴ All the more so since two servants were going to be part of the journey

- Gen 22:5 "Stay here with the donkey while I and the boy go over there.

Abraham had been blessed with a great wealth. He could have provide an animal for everybody.

- Gen 12:16 and Abram acquired sheep and cattle, male and female donkeys, menservants and maidservants, and camels. NIV

The journey between Beersheba and Jerusalem (Mont Moriah) had to cover about 74 km (46 miles). Abraham must have had a very serious raison to decide that most of them would walk the whole distance. Was anybody going to ride the ass? The 115 years old Abraham maybe? Or the young 15 years old Isaac? Probably not one of the servants but then it could have been used to carry the heavy payload of wood, the water, the food, some kind of shelter for the nights. Nobody make a 6 days round trip without the proper supplies. Isn't it a fact that a small caravan of 5 or 6 camels would have been justified to make this journey? Yet Abraham judged otherwise and brought no more than one donkey.



As I have pointed out several elements of the story look peculiar. It would be easy to ignore these oddities if each one was isolated in the text but here they are so closely related that one keep wondering if the text is not trying to tell us something more, something that would be hidden.

Here are the basic facts that don't make sense in the Akedah's story

- Eagerness to start the journey
- Chopping the wood on the first morning and carrying it all the way to Moriah.
- Not asking a servant to saddle the donkey.
- Selecting only one donkey when several would have been handy.

I have given much thought to these discrepancies and I would like to propose the following interpretation which has the merit to clarify and integrate all the facts. **Unfortunately this will also add a new layer of horror to a story that is already awful.**

Let's suppose that after he had putted the saddle on the ass, Abraham took the pieces of wood that he had cut and he attached them on each side of it then asked Isaac to sit and travel on the animal. You are probably thinking that there is nothing unusual at all here. Wasn't it a good way to resolve two problems? Carrying the heavy load of the 'important' wood and pampering his young son for the next three days! This is probably how it happened but if so, Abraham must have been continually miserable. Imagines that you are the old Abraham slowly walking behind the ass, what do you see in front of you if not a constant reminder of the purpose of the whole journey. Indeed, **each time Abraham lifted his eyes** it was not to watch a nice scenery in which the son of his old age was riding on an ass, unfortunately what he saw in front of him was a **moving altar with his son** sitting directly over a pile of burn offering wood. Keep in mind that Abraham was carrying the firestone and the knife generally

use to perform an animal sacrifice, and that the goal of the expedition was to sacrifice his only son on a somewhat similar altar. Abraham had to ‘look up’ each time to see his son on the donkey, a subtle reminder that he had been asked to bring Isaac on the top of a mountain¹¹⁵. Could the scene have been more explicit? It must have drove Abraham constantly mad with grief. The three days journey was never meant to alleviate Abraham distress before the sacrifice took place, on the contrary, every thing was designed to accentuate his mental suffering and test, to the limit, his resolve.

Doesn't it explain, in an obvious way, why three of the elements we found so strange in the story had to be handled the way they were?

- ✓ Abraham cut the wood at the beginning of the journey because it was needed immediately to transform the saddle into an altar.
- ✓ When Abraham lifted the saddle on the donkey at the start of the journey he was then erecting the symbolical altar. No servant could have done that chore for him given its symbolical nature. God had asked Abraham to do the sacrifice, therefore it would have been inappropriate to let anybody else build the altar no matter it was only a type of the real one.
- ✓ Only one animal was part of the voyage because once the ‘symbolical’ altar was erected on it, that animal would become, for the next three days, the focal point of every one following on foot behind it.

Have you notice how the ‘wood’ play such an important role in the whole Akedah story?

1. Abraham cut the wood,
2. Isaac sit over the wood,
3. Abraham place the wood on Isaac,
4. Isaac carry the wood
5. Isaac lay down on the wood.
6. A lamb get caught by the horn in the wood
7. The lamb took the place of Isaac on the wood, and the wood is lighten.

It is the wood of the burn offering, placed on each side of the saddle that creates the mental association with an altar. Of course other elements of the story are needed to accentuate this association. For instance, having Isaac, the future victim, sitting on that saddle, following the animal while carrying the knife and the fire, having the people lift their eyes to see an ‘elevated’ Isaac. And what about the sadness and the silence of Abraham? Don't they bring solemnity to the scene, the way it should be around an altar when a sacrifice is about to be performed?



¹¹⁵ Gen 22:2 sacrifice him there as a burnt offering on one of the mountains NIV

Abraham suffered in silence¹¹⁶ while going through his ordeal. He never complained or lamented to God as he understood that his character was being tested one more time.

- Gen 22:18 and through your offspring all nations on earth will be blessed, because you have obeyed me." NIV

It is true that Abraham could have decide to spare his son at any time and return home immediately. If he had done so, God master plan would have been applied through somebody else¹¹⁷. But Abraham overcame the distress felt during the last three days and he went up the mountain to bound Isaac. This moment marks a turning point in Abraham's determination. If he had not fully intend to sacrifice Isaac, he would never have let Isaac become aware of that goal. As for Isaac, who was never ambushed by his father in any ways, and whose collaboration was essential¹¹⁸, the bounding became a turning point for him too. It doesn't matter how long Isaac took to really make up his mind. It is at the time of the binding, when he offered no resistance, that he fully committed himself to the will of his father¹¹⁹.

At the ultimate instant God prevented the killing, He never needed a human sacrifice, it was a test to validate that they both really fear Him.

- Gen 22:1 Some time later God tested Abraham. NIV
- Gen 22:12 Now I know that you fear God, NIV

Let's explain why Abraham got up and left so 'early' that first morning. Instead of associating Abraham's behavior to some eagerness to please God (dismissing his own pain in the process) I propose a more rational interpretation. What would make someone start a journey early if not to make sure that this journey would be completed in a specific period of time?

Abraham had to cover about 46 miles by foot and offer a sacrifice. Suppose it was important that the journey was done in three days¹²⁰, no less and no more. The only way to accomplish that was to leave early every morning. This explanation leads to a more interesting question, why three days? And the answer is because the binding of Isaac was a type whose echo would resonate 1870 years later during the crucifixion week.

Many parallels connect the 'binding of Isaac' and the 'crucifixion of Yeshua'.

- Both accepted to die for the sake of their father.
- Both came to Jerusalem (or the vicinity) on a donkey

¹¹⁶ Isaac didn't have any clue of what was going on until he and his father left the two servants behind

¹¹⁷ Est 4:14 relief and deliverance for the Jews will arise from another place, but you and your father's family will perish. NIV

¹¹⁸ A 115 years old Abraham wouldn't have been able to bind a resisting 15 years old Isaac.

¹¹⁹ Because Isaac, at that instant, submitted to his father's will he would receive all the blessing (notice that a ram took Isaac's place on the **altar**). Jacob however, got all Isaac's blessing by resisting his father's will. (notice how Jacob took Esau's place at Isaac's **couch**. Ref Gen 27:19 please **sit up**..).

¹²⁰ Gen 22:4 On the third day Abraham looked up and saw the place in the distance. NIV

- Two servants shared the first part of Isaac's journey, two robbers shared the last part of Yeshua journey. (Gen 21:3, Luke 23:32)
- Both carried the wood for the sacrifice on their back. (Gen 21:6, John 19:17)
- Both were bound and lead to a specific location.
Isaac (Gen 22:9) / Yeshua (John 18:12)
- At the last instant, the angel call out from heaven, "**Abraham, Abraham**" (Gen 22:11). At the last instant, Yeshua cried out to heaven, "**My God, my God**" (Mark 15:34)
- Abraham grieve for three days in anticipation of sacrificing Isaac. (He must have thought that he was going to do it all the time)
The apostles grieved for three days following the sacrifice of Yeshua. (They didn't believe that he would resurrect)
- Both grieving ended unexpectedly when an unanticipated resurrection (symbolical for Isaac, real in Yeshua's case) took place.
- A ram, whose head was caught 'IE *surrounded*' in a ticket of thorns, replaced Isaac; Yeshua, with a crown of thorns around his head, became the Passover's Lamb
- Both were sacrificed on an altar.
 - Abraham built an altar 'of stones' for Isaac (Gen 22:9)
 - During 3 hours, Yeshua was stoned almost to death while nailed to the tree. The accumulation of small pebble at the foot of the tree symbolically transformed the site into an altar.

The last parallel could be surprising and very shocking to most people therefore I will digress to explain a little more about that.

Was Yeshua nailed to a tree?

- Acts 5:30 The God of our fathers raised Jesus from the dead-whom you had killed by hanging him on a tree. NIV
- Acts 10:39 They killed him by hanging him on a tree, NIV
- 1 Peter 2:24 He himself bore our sins in his body on the tree, NIV
- Gal 3:13-14 Christ redeemed us from the curse of the law by becoming a curse for us, for it is written: "Cursed is everyone who is hung on a tree."

In his book 'Secrets of Golgotha' Ernest L. Martin argue that Yeshua and the two robbers were not only crucified on a tree, they were crucified on the same tree¹²¹.

¹²¹ If one robber was crucified on a separate cross on Jesus' left side, and the other robber on another cross on his right (so there were three crosses placed side by side with one another with Jesus situated in the middle), we then have a major problem with the death of the two robbers. This is because the soldiers killed first the two robbers and last of all they came to Jesus in the middle to slay him. Being in the middle should have made Jesus the second to be killed. There is no reason to assume that it was more convenient to go from the first 'cross' to the third one and then come back to the one in the middle. However if the three prisoners were around a common tree then the soldiers acted in a natural way.

In her amazing book¹²² 'A Book of Evidence: The Trials and Execution of Jesus' Nancy L. Kuehl argues that the yoke carried by Simon of Cyrene (Mark 15:21) was not a Roman cross neither the cross beam of a cross. It was a piece of wood that could be fitted around a neck like the yoke of an ox. Yeshua's hands were later nailed to that yoke before it was lifted and fixed to a living tree. According Mrs. Kuehl Yeshua's feet were not nailed to anything and this is why in John 20:20 Yeshua identified himself by showing only the holes in his hands and his side. The words 'and feet' in Luke 20:40 don't appear in the early Greek manuscript as they are late addition to conform to a crucifixion on a Roman cross.

Was Yeshua really stoned?

Look at some of the facts. *He predicted that he would be stoned (Matt 23:37, Luc 13:34) and on several occasion the people tried to do it without success (John 8:59, 10:31, 11:8). It could only mean that the prediction was fulfilled at his death.* Keep in mind that Yeshua was living in a Jewish culture at a time when Caiaphas (the high priest) and his father in law Annas (see John 18:13) were very powerful in Jerusalem (a very corrupted priesthood). They had Yeshua brought in front of the Sanhedrin (Jewish criminal court) with a charge of blasphemy. According to the law someone guilty of blasphemy should be stoned to death. (*Lev 24:16 "And he that BLASPHEMES the name of the LORD, he shall surely be put to death, and all the congregation shall certainly STONE HIM*). Pilate didn't want to condemn Yeshua as he found no fault in him¹²³ but under pressure he had to surrender him to the accusers. (Luke 22:24, John 19:6). Yeshua was condemned under the Jewish law.

Many who came near the cross still remembered what he had said in the past (*Matt 27:39-40 Those who passed by hurled insults at him, shaking their heads and saying, ..., save yourself! Come down from the cross, if you are the Son of God!" NIV*)

There are documented cases of people who survived a full week on the cross. Why did Yeshua die after 6 hours but not the two thieves that were crucified with him? (John 19:32-33) Pilate was so surprised when he learned that He was already dead that he sent a centurion to verify the fact. (see Mark 16:44-45.) The stoning more than anything else would explain Yeshua's quick death.

Nancy Kuehl has the following comment about

- Ps 22:16-17 Dogs have surrounded me; a band of evil men has encircled me, they have pierced my hands and my feet. I can count all my bones; NIV

“the only manner in which a man's bones might view him is if they were no longer enclosed in flesh --- **the word 'pierced' doesn't mean 'pierce through'** The Hebrew word here is 'aryeh' ... and it means 'to pluck away skin' ... a stone, especially if sharp, would have the same effect.”

John 19:32-33 Then came the soldiers, and brake the legs of the first, and of the other which was crucified with him. But when they came to Jesus, and saw that he was dead already, they brake not his legs: KJV

¹²² If I had to recommend a single book about the crucifixion that would be the one

¹²³ Matt 27:24 he took water and washed his hands in front of the crowd. "I am innocent of this man's blood," he said. "It is your responsibility!" NIV

Luke 23:20 Wanting to release Jesus, Pilate appealed to them again. NIV

And what about the appearance of Yeshua after the resurrection, doesn't it conform to a man that have been stoned?

- Isa 52:14 Just as there were many who were appalled at him-- his appearance was so disfigured beyond that of any man and his form marred beyond human likeness-- NIV

Wouldn't the 'stoning' explain more than anything else why his followers or apostles weren't able to recognize him?

- John 20:14 At this, she turned around and saw Jesus standing there, but she did not realize that it was Jesus. NIV
- John 20:27 Then he said to Thomas, "Put your finger here; see my hands. Reach out your hand and put it into my side. Stop doubting and believe." NIV

Isn't it peculiar that the land became dark at the exact midpoint of the 6 hours that Yeshua was nailed to the tree (Mark 15:25,33-34)? Why didn't God sent this unnatural darkness right at the start of the crucifixion (09h00 AM) or at the very end of it (03h00 PM) when Yeshua died? In both cases the emphasis would have been more 'dramatic', don't you think? Could the removal of the light at that specific time of the day be justified? I believe the purpose of sending the darkness was to make the stoning of His 'beloved son' impossible to be carried on and force the abusers to **retreat in fear**.

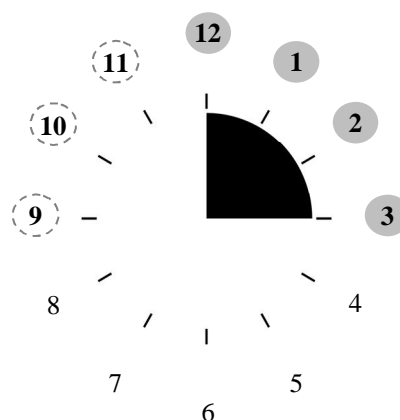

Notice the following two interesting parallels:

- ✓ In the garden of Eden, the first thing Adam and Eve did after the original sin was to **hide in fear**¹²⁴. And 3993 years later, if I am right, just before Yeshua gave his life for that very same 'original sin' people were also **retreating in fear**.
- ✓ Let's start with Melito of Sardis very appropriate quote¹²⁵ :
'Just as from a tree came sin, so also from a TREE came salvation' (New Fragment, Ill. 4)

In Eden, **the snake** incited Adam and Eve to eat a fruit from the tree and to sin against God. And who was behind the scene and condemned Yeshua to be hanged on the tree? The Pharisees¹²⁶ (and the Sadducee) whom Yeshua had associated earlier in his ministry to a bunch of vipers (**Snake**) belonging to Satan¹²⁷

¹²⁴ Gen 3:8-10 ... and they hid from the LORD God among the trees of the garden.

¹²⁵ I learn about this quote in the article "The Messiah's Crucifixion Tree" of John D. Keyser

¹²⁶ Matt 3:7 But when he saw many of the Pharisees and Sadducees coming to where he was baptizing, he said to them: "You brood of vipers! Who warned you to flee from the coming wrath? NIV

¹²⁷ John 8:44 You belong to your father, the devil, and you want to carry out your father's desire. He was a murderer from the beginning, not holding to the truth, for there is no truth in him. NIV

Exodus.

The Bible is clear, the killing of the Passover lamb, was to be done on the 14th day of the first month. (Ex 12:6, Lev 23:5¹²⁸, Num 9:3¹²⁹, Josh 5:10¹³⁰, 2 Chr 35:1¹³¹). What is less obvious is to establish when the Passover lamb was to be killed during that day: a little time after sunset at the start of the day or some time before sunset at the end of the day?

The Bible's day, as we all know, starts at Sun Set and ends at the next Sunset.

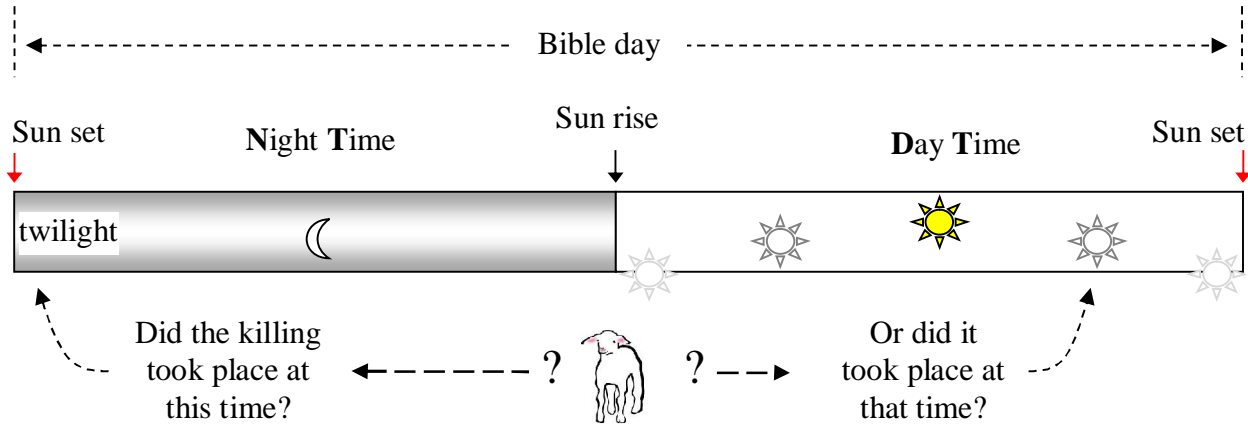

Ex 12:6 And ye shall keep it [*the lamb*] up until the fourteenth day of the same month: and the whole assembly of the congregation of Israel shall kill it **in the evening**. KJV

It is said here that the lamb must be killed on the 14th day in the ?evening?. The Hebrew for the words "in the evening" is **beeyn haa'arbaayim** which literally translate **between the two evenings** (B2E).

There are two schools of thought for the exact meaning of 'between the two evenings'

First solution: Most of today scholars (and late Samaritans) believe this *idiom* means the time between sunset and complete darkness (about 45-minute) at the very beginning of the Jewish day.

Second solution: According to modern Jewish rabbis, the Talmud and the late Pharisees, B2E target the period when the sun begin to decline 'noon' until sunset. (3 o'clock would be right in the middle of the period).

From a Bible point of view, only one understanding can be right..

¹²⁸ Lev 23:5 The LORD's Passover begins at twilight on the fourteenth day of the first month. NIV

¹²⁹ Num 9:3 Celebrate it at the appointed time, at twilight on the fourteenth day of this month NIV

¹³⁰ Josh 5:10 On the evening of the fourteenth day of the month, while camped at Gilgal on the plains of Jericho, the Israelites celebrated the Passover. NIV

¹³¹ 2 Chron 35:1 Josiah celebrated the Passover to the LORD in Jerusalem, and the Passover lamb was slaughtered on the fourteenth day of the first month. NIV

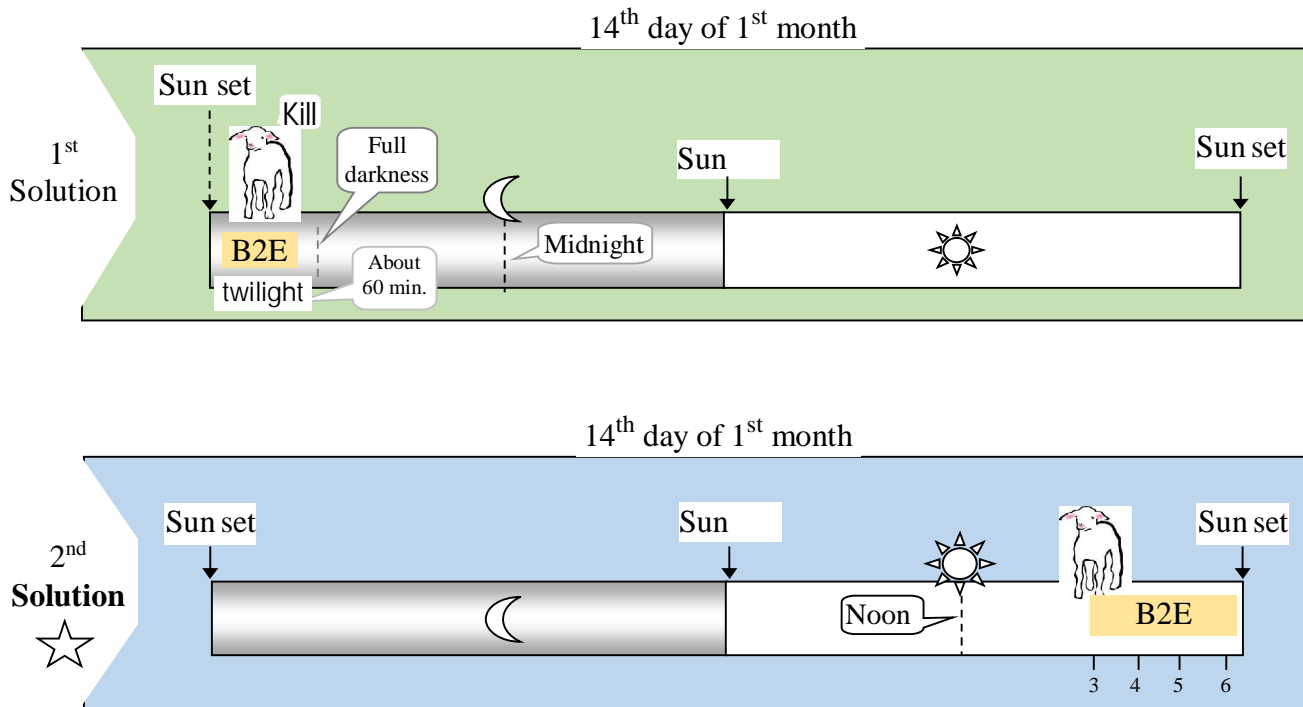

The following three cases will show us that there is only one good way to understand the timing meant by the expression between the two evenings 'B2E' and it is the one presented in solution #2 (in afternoon, before Sunset).

First case: In the book of Numbers the Bible give instructions to sacrifice two lambs every day.

- Num 28:3-4 And thou shalt say unto them, This is the offering made by fire which ye shall offer unto the LORD; two lambs of the first year without spot day by day, for a continual burnt offering. The one lamb shalt thou offer in the morning, and the other lamb shalt thou offer at even; KJV

Note: 'even' is translated from the Hebrew "haa`arbaayim" which means 'between the two evenings'

The first lamb was to be sacrificed in the morning. The second lamb would be sacrificed 'between the evening'. In order to have both lambs sacrificed the same day, the second lamb had to be sacrificed **before** the next sunset. If the expression 'between the two evenings' had meant after sunset then the second lamb would have been sacrificed in the part of the day that belong to the next one. (Remember in the Bible each new day starts at Sunset). Of course I grant you that in the end two lambs are sacrificed every day. But if you give any importance to the sequence used in the Bible's text, it clearly say two lambs every day, with the first one in the morning. Whatever the expression used, the second one had to be before next sunset.

Second case: Here Flavius Josephus describe that hundreds of thousands of lambs were slaughtered before sunset (Solution 2).

"So these high priests, upon the coming of their feast which is called the Passover, when they slay their sacrifices, from the ninth hour to the eleventh, but so that a company of not less than ten belong to every sacrifice, (for it is not lawful for them to feast singly by themselves,) and many of us are twenty in a company, found the number of sacrifices was two hundred and fifty six thousand five hundred;" (The Complete Works of Josephus,

Flavius Josephus, translated by Whiston, *La Sor, Wars of the Jews, Chapter 9 part 3, page 588*)

Clarification: Counting from 6 o'clock in the morning, the 9th hour to the 11th should be understood as from **3 o'clock to 5 o'clock in the afternoon**.

Third case: The following verses tell us that Elijah wait for the time **of the Evening sacrifice** before he intervene at Mount Carmel. As you will see, the ‘evening sacrifice’ couldn’t have refer to the period after Sunset.

- 1 Kings 18:29-30 Midday passed, and they continued their frantic prophesying until the time for the evening sacrifice. But there was no response, no one answered, no one paid attention. Then Elijah said to all the people, "Come here to me."

Now notice what took place once the time of the ‘evening sacrifice’ was reached and while there was still light to see around:

1. Repaired Yahweh’s altar 1 King 18:30-32
2. Dug a trench around the altar 1 king 18:32
3. Laid wood on the altar 1 King 18:33
4. Cut up the bull and laid it on the wood 1 King 18:33
5. Had several jars filled of water three time and emptied on the altar
6. Prayer to Yahweh 1 King 18:36
7. Elijah had the 450 prophets captured and brought down from Mount Carmel to the Kishon Valley where they were killed. 1 King 18:40
8. Send Ahab away 1 King 18:41
9. Go back to Mount Carmel from the Kishon valley 1 King 18:42
10. Send the servant 7 times to **SEE** if the rain was coming 1 King 18:43-44

Now, could have all these actions took place in the short 45 to 75 minutes between Sunset and total darkness? In the end, would it have been possible to Elijah’s servant to distinguish (in an almost dark sky) a cloud not bigger than an hand (1 King 18:44)? However, if the time of the ‘evening sacrifice’ was meant to be in the afternoon, similar to the expression ‘between the two evenings’, there would have been plenty of time to accomplish the previous 10 actions and see a small cloud in a bright late afternoon sky.

Let’s build a timeline

- Ex 12:3 Tell the whole community of Israel that on the tenth day of this month each man is to take a lamb for his family, one for each household.

Nisan 10	Nisan 11	Nisan 12	Nisan 13	Nisan 14
Choose the lamb				Kill the lamb in the afternoon

Ex 12:6 take care of them until the fourteenth day

The day after the killing of the lamb was the first day of unleavened bread.

- Num 28:16-19 **On the fifteenth day of this month there is to be a festival; for seven days eat bread made without yeast.** On the first day hold a sacred assembly and do no regular work. NIV
- Lev 23:6-7 On the fifteenth day of that month the LORD's Feast of Unleavened Bread begins; for seven days you must eat bread made without yeast. NIV

Here we learn that the Unleavened bread would start on the 15 for 7 consecutive days.



7 days festival of the unleavened bread											
Nisan 10	11	12	13	Nisan 14	Nisan 15	16	17	18	19	20	Nisan 21
Chose the lamb				Kill the lamb in the afternoon	First day of Unleavened bread						Last day of Unleavened bread

Let's look at another verse:

- Ex 12:18-19 In the first month you are to eat bread made without yeast, from the **evening of the fourteenth day** until the **evening of the twenty-first day**. For seven days no yeast is to be found in your houses.

It is quite confusing, now the unleavened bread should start on the evening of the 14, which logically points to the beginning of the 14 (remember that a day starts at sunset, therefore darkness comes before the daylight's part of the day). But Ex 12:18 doesn't really say 'on the evening of the 14th day' it says 'at even on the 14th day'. Is it possible that 'at even' here simply means toward the end of the afternoon? If it is the case Ex 12:18-19 is only telling the Israelites to stop eating bread with yeast a little time before the end of the day in anticipation of the start of the Festival of the unleavened bread. As expected, the Bible doesn't contradict itself.

Nisan 14 & 15

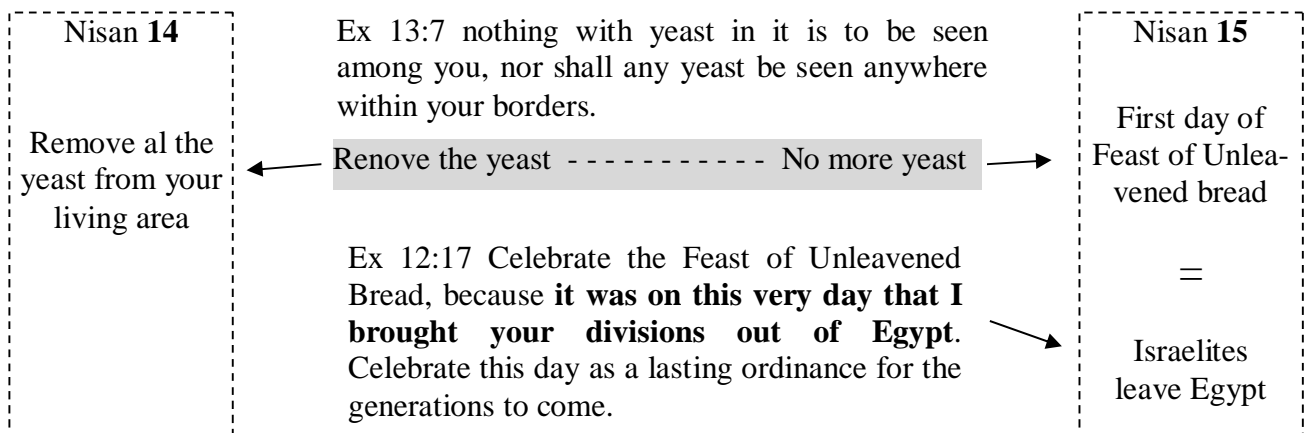

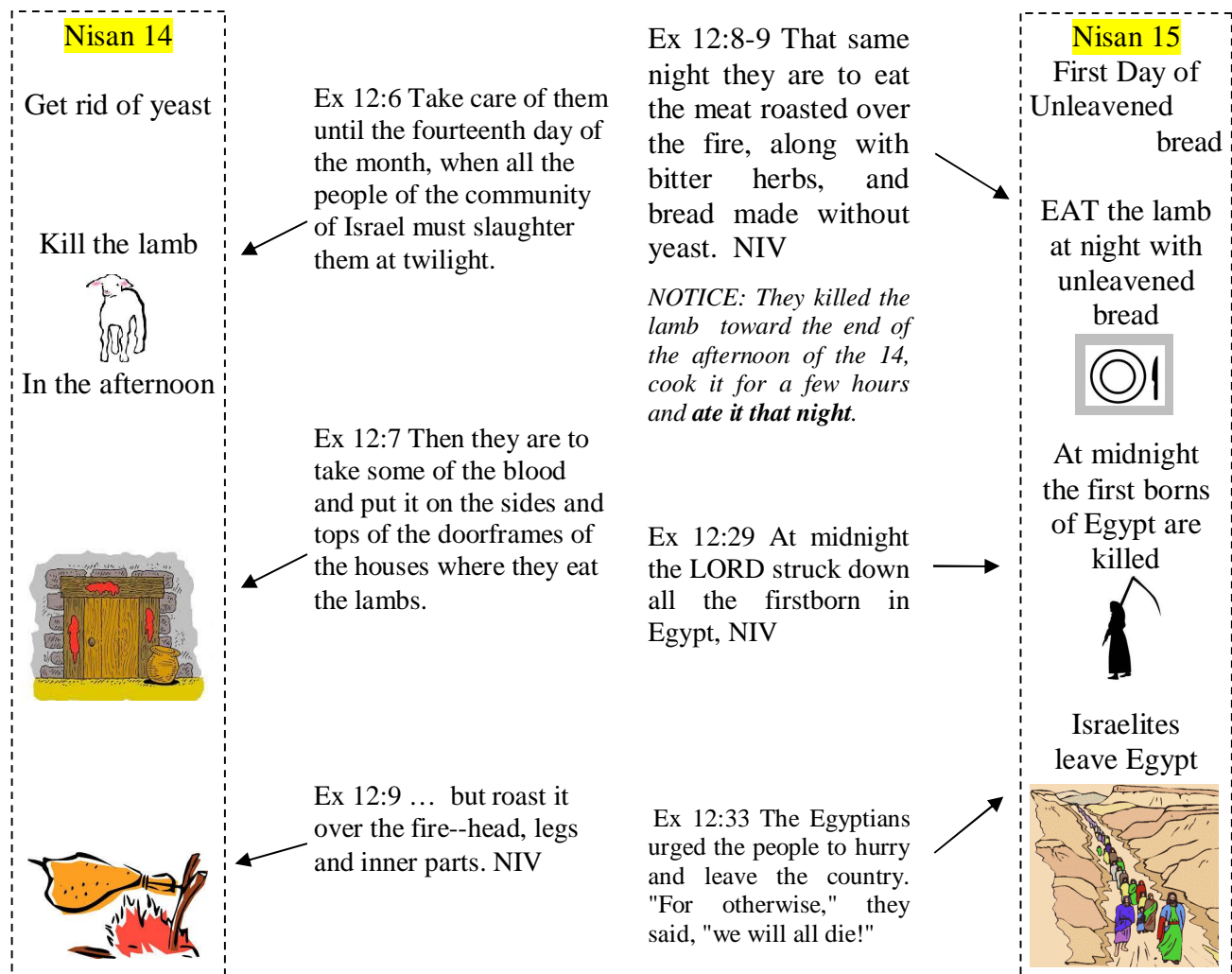

Notice this important point:

The Israelite were told to eat the passover lamb with bread without yeast (Ex 12:8). For obvious reason that meal was taken in the early hours on the night of the 15, ie a few hours after the killing of the lamb in the afternoon of the 14. It would be quite peculiar and incoherent if the passover meal, whose lack of yeast is among the important feature, would have been taken just before the start of a 7-day feast whose main characteristic was a total absence of leavened bread.

- Lev 23:6 On the fifteenth day of that month the LORD's Feast of Unleavened Bread begins; for seven days you must eat bread made without yeast.

The Passover, the phantom day of the Bible.

Any study of the Passover must start with this important distinction of the following 3 elements.

- #1. **The original 'Pass over' meal.** A few hour before¹³² the first born were killed, and on the same day (Nisan 15), the Israelites ate a special meal (meat of a lamb roasted over fire, bitter herbs, bread without yeast, sandal on the feet, staff in the hand. See Gen

¹³² Ex 12:8 That same night they are to eat the meat roasted over the fire, along with bitter herbs, and bread made without yeast. NIV

12:8,11). They ate that meal while they were secluded in their house. The blood of the Lamb they ate had been used to seal the door of that house.

- #2. **The 'passing over' in Egypt** that occurred around midnight on the 15 of Nisan;
- Ex 12:12-13 "On that same night [night of Nisan 15 at midnight¹³³] I will pass through Egypt and strike down every firstborn--both men and animals--and I will bring judgment on all the gods of Egypt. I am the LORD. The blood will be a sign for you on the houses where you are; and when I see the blood, I will **pass over** you. No destructive plague will touch you when I strike Egypt. NIV
- #3. **The 'future' observance** to commemorate the 'passing over' in Egypt. They would have to kill a lamb (that was done until the end of the second Temple) in the afternoon of the 14, have a meal early in the evening of the 15. The meal would consist of the Lamb, bitter herbs, bread without yeast. The people would do it to remember¹³⁴ that God had 'pass over' and spared their house while He stroke down the Egyptian.

NOTE: The killing of the lamb was done in the afternoon of the 14. The original 'pass over' meal took place in the early evening of the 15. The killing of the first born happened at midnight on the 15. The thing to remember is that the OBSERVANCE (memorial) for the 'pass over' has two parts: The killing of the lamb on the afternoon of the 14 and the meal in the early evening of the 15.

If you paid enough attention when reading every verse that mention the word 'Passover' you will discover something quite surprising. The Bible talk about the Passover's sacrifice¹³⁵, feast¹³⁶, offering¹³⁷. But most of the time, even though the Hebrew Bible uses the word 'Passover' alone it does imply one of these: lamb¹³⁸, meal¹³⁹, sacrifice¹⁴⁰ or both¹⁴¹ (lamb and sacrifice). **The Bible never uses the expression 'Passover day'**. Then why do everybody assume that 'Passover' designs the whole day of 14 of Nisan? The answer is probably because the following misunderstood three verses :

Numbers 28:16 Numbers 33:3 Ezek 45:21

¹³³ Ex 12:29 At midnight the LORD struck down all the firstborn in Egypt, NIV

¹³⁴ Ex 12:26-27 And when your children ask you, 'What does this ceremony mean to you?' 27 then tell them, 'It is the Passover sacrifice to the LORD, who passed over the houses of the Israelites in Egypt and spared our homes when he struck down the Egyptians.'" NIV

¹³⁵ Ex 12:26-27 'What does this ceremony mean to you?' 27 then tell them, 'It is the Passover sacrifice to the LORD, NIV

Deut 16:2 And you shall offer the passover sacrifice to the LORD your God, from the flock or the herd, RSV

¹³⁶ Ex 34:25 and do not let any of the sacrifice from the Passover Feast remain until morning. NIV

¹³⁷ 2 Chron 35:9 the leaders of the Levites, provided five thousand Passover offerings NIV

¹³⁸ Ex 12:21 Then Moses called for all the elders of Israel, and said unto them, Draw out and take you a lamb according to your families, and kill the passover [LAMB]. KJV

Deut 16:5 You must not sacrifice the Passover [LAMB] in any town the LORD your God gives you NIV

2 Chron 30:15 Then they killed the passover [LAMB] on the fourteenth day of the second month: KJV

¹³⁹ Ex 12:43 And the LORD said unto Moses and Aaron, This is the ordinance of the passover[MEAL] : There shall no stranger eat thereof: KJV

¹⁴⁰ Ex 34:25 Thou shalt not offer the blood of my sacrifice with leaven; neither shall the sacrifice of the feast of the passover[SACRIFICE] be left unto the morning. KJV

¹⁴¹ Num 9:12 They must not leave any of it [LAMB] till morning or break any of its [LAMB] bones. When they celebrate the Passover[sacrifice] , they must follow all the regulations. NIV

Num 28:16 "On the fourteenth day of the first month the LORD's Passover is to be held. NIV
 Now let me prove¹⁴² to you that Num 28:16 is saying without any doubts that:

“On the 14th day ... the Lord’s Passover **Lamb** is to be offered.”

Notice first that in Num 28:1-2, God tells Moses what food should be offered over fire; Then let’s review the content of Num 28:3-35		
Numbers	The offering	
28:3-8	Continual burnt offerings	2 lambs daily
28:9-10	Sabbaths	2 lambs
28:11-15	New moons	2 bullocks, 1 ram, 7 lambs, 1 goat
28:16	The fourteenth day	the Passover
28:17-25	Feast of Unleavened Bread (each day)	2 bullocks, 1 ram, 7 lambs, 1 goat
28:26-31	First Fruits	2 bullocks, 1 ram, 7 lambs, 1 goat
29:1-6	Feast of Trumpets	1 bullock, 1 ram, 7 lambs, 1 goat
29:7-11	Day of Atonement	1 bullock, 1 ram, 7 lambs, 1 goat
29:12-34	Feast of Tabernacles (each day)	13 bullocks (number decreases by 1 each day of the feast), 2 rams, 14 lambs, 1 goat
29:35	Last great day	1 bullock, 1 ram, 7 lambs, 1 goat
Isn’t it obvious, that when Num 28:16 says: ‘The 14 th day – the Passover’ it could only mean that on the 14 th day the Israelites had to sacrifice a Lamb (call here the ‘Passover’). The verse has nothing to do with a so called Passover day on Nissan 14.		

Num 33:3 The Israelites set out from Rameses on the fifteenth day of the first month, the day after the Passover. NIV

"And they journey from Rameses in the first month, on the fifteenth day of the first month, on the morrow of the Passover have the sons of Israel gone out with a high hand, before the eyes of all the Egyptians" (Num 33:3, Young's Literal Translation)

When it is understood that the word ‘Passover’ is here a reference to the real event ‘the passing over’ in Egypt, which happened at midnight on the night of the 15th day of Nissan, the morrow can only be a few hours later, on the morning of the same day (15 of Nissan).

Ezek 45:21 "In the first month on the fourteenth day you are to observe the Passover, a feast lasting seven days, during which you shall eat bread made without yeast. NIV

But see here how the Tanak translate the same verse in two parts:

"On the fourteenth day of the first month you shall have the Passover sacrifice; and during a festival of seven days unleavened bread shall be eaten." (Eze 45:21, Tanakh)

None of the last three verses can be used to prove that Nissan 14 is the ‘Passover day’,

The Passover could be many things depending of the context where is mentioned but it has never been meant to point to a whole day.

¹⁴² It is very confusing to try to understand how the Bible uses the word ‘Passover’. I learn a great deal reading Ray Foucher very useful e-book ‘Is Nissan 14 the Feast of Passover?’ The e-book give an exhaustive list of every occurrence of the word ‘Passover’ and explains how to understand each one of them. His explanation on Num 28:16 and reproduced on this page, is ome more proof that the Bible is full of surprise for those who study it.

Back to Abraham.

I gave earlier a list of many parallels (page 238) that connect the ‘binding of Isaac’ and the ‘crucifixion of Yeshua’. I would like to elaborate on the parallel of the ‘three days’, I believe we have here nothing less than the key to understand the timing between the crucifixion and the resurrection of Yeshua.

Here are a sequence of events that occurred over several days:

- Abraham is told to go to the region of Moriah
- The following day the expedition start
- On the third day Moriah is reached and the sacrifice take place

Does this
? sequence spread
over 3 or 4 days

Did the words ‘on the third day’ refer back to the day of departure or to the day Abraham was asked to go to Moriah? If the ‘third day’ include the day Abraham was asked to go to Moriah then it would mean that the travelling took place in only two days!

First day	Second day	Third day
Abraham is asked to go to Moriah	Araham and others leave Beersheba	Moriah is reached Sacrifice take place
Did Abraham walked 46 miles in two days ?		

The sequence on the left is impossible.
Abraham couldn't have walk 46 miles and still have time to go up the mountain, build an altar and offer the Ram in sacrifice

On the other hand the ‘third day’ could still refer back to the day Abraham was asked to go to Moriah but with the understanding that the preposition ‘after’ is inferred from the text.

On the day before he left, Abraham was told to go to Moriah. The following days (day #1, #2, #3) he traveled the distance. On the third day (IE day #3) ‘after he was asked to go to Moriah’, his son was symbolically resurrected.

		First day <i>day #1</i>		Second day <i>day #2</i>		Third day <i>day #3</i>	
N.	D.	Nighttime	Daylight	N.	D.	Nighttime	Daylight
Sometime during the day Abraham is asked to go to Moriah			Leave early & Walk		Leave early & Walk		Leave early & walk
						<div style="border: 1px solid black; padding: 2px; display: inline-block;">Sacrifice on the altar late that day</div> 	
Three days journey (they had to cover 46 miles)							

Yeshua was put on the cross (tree) during the day of preparation and he died later in the afternoon.

- John 19:31 Now it was the day of Preparation, and the next day was to be a special Sabbath. Because the Jews did not want the bodies left on the crosses during the Sabbath, they asked Pilate to have the legs broken and the bodies taken down. NIV

What was the ‘special Sabbath’ mentioned in John 19:31? During Exodus Moses had instructed the Israelites about 7 special ‘holy’ convocations (high Sabbath).

Spring Feasts	
<u>First day of unleavened bread</u>	Lev 23:6
Last day of unleavened bread	Lev 23:8
Feast of weeks (Harvest)	Lev 23:21

Fall Feasts	
Feast of Trumpet	Lev 21:24
Day of atonement	Lev 21:27
First day of Tabernacles	Lev 21:35
Heighth day of Tabernacles	Lev 21:36

The preparation day was the day before the ‘first day of unleavened bread’. It was called ‘preparation’ because during that day the Israelietes would search for any trace of ‘yeast’ (see Ex 13:7) in the house and make sure it was removed before the start of the first day of unleavened bread.

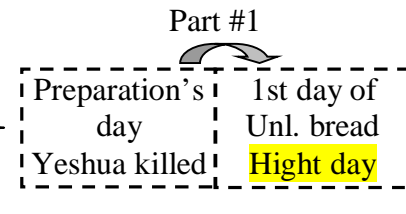

Yeshua was resurrected on the first day of the week.

- Matt 28:1 28:1 After the Sabbath, at dawn on the first day of the week, Mary Magdalene and the other Mary went to look at the tomb.

which is to say that the day before was the weekly Sabbath.

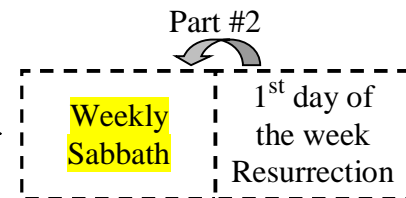

The preceding two partial timelines (#1 & #2) allows us to elaborate the next three timelines scenarios of what could have happened between the crucifixion and the resurrection. (To make it easier I will transpose our traditional days of the week naming convention (Sunday ...) into these timelines. Keep in mind that a day in the Rabbinic Hebrew calendar runs from sunset to sunset. In each scenario the first day of the week is Sunday, therefore we can go backward and name each preceding days, we also know that the ‘preparation day’ was Nissan 14, thus we can move forward and put a date on each succeeding day)

Scenario 1 1st day of Unleavened bread and Weekly Sabbath coincide

Friday Nissan 14		Saturday Nissan 15		Sunday Nissan 16	
Nighttime	Daytime	Nighttime	Daytime	Nighttime	Daytime
Preparation's day Yeshua killed		1st day of unl.. bread Hight day + Weekly Sabbath		1 st day of the week Resurrection	

This scenario won't be retained. It fails to provide **3 perods of daytime & 3 period of nighttime** as required by

Matt 12:40 so the Son of Man will be three days and three nights in the heart of the earth.

Scenario 2 One day is added between ‘First day of Unleavened bread’ and ‘Weekly Sabbath’.

Wednesday Nissan 14	Thursday Nissan 15	Friday Nissan 16	Saturday Nissan 17	Sunday Nissan 18
Preparation's day Yeshua killed	1st day of Unleavened bread High day	<i>Ordinary work day</i>	Weekly Sabbath	1 st day of the week Resurrection

Although there are three full days between the Crucifixion and the Resurrection I won't retain this scenario for the following two reasons.

- A) According Mark 16:1¹⁴³ some women came to the tomb on Sunday morning with spices to anoint Yeshua. They were prevented to do it after the crucifixion on this ‘hypothetical’ Wednesday because they didn't have enough time to perform the task before the start of the ‘High Sabbath’. Here is the problem. Nothing could justify that they didn't do it on the following Friday. Many would argue that they spent the whole day (Friday) to buy and prepare the spices. This argument has little weight considering that Nicodemus managed¹⁴⁴ to find 75 pound of a mixture of myrrh and aloes and apply then on Yeshua body in the few hour before sunset at the end of Wednesday.
- B) To subscribe to this scenario we have also to believe that the women (previous point) came to the tomb to anoint someone that had been dead for four days. Who could see any relevance in such a futile action? A few weeks before, Martha had warned¹⁴⁵ Yeshua against coming near Lazarus' tomb because he had been dead for four days and the smell was strong.

Scenario 3 The 1st of Unleavened bread and the Weekly Sabbath are two successive days.

Thursday Nissan 14	Friday Nissan 15	Saturday Nissan 16	Sunday Nissan 17
Preparation's day Yeshua killed	1st day of Unleavened bread High day (Sabbath)	Weekly Sabbath	1 st day of the week
			Nighttime
Spices brought & prepared	<p>Luke 23:56 Then they went home and prepared spices and perfumes. But they rested on the Sabbath in obedience to the commandment</p> <p>Luke 24:1 On the first day of the week, very early in the morning, the women took the spices they had prepared and went to the tomb.</p>	Re- sur- rec- tion	Daytime
			Spices brought to the tomb

Matt 28:1 After the Sabbath..
In the Greek manuscript the word ‘Sabbath’ is in its plural form. This would be logical (in the context of this scenario) given that **two successive Sabbaths had just took place.**

¹⁴³ Mark 16:1-3 When the Sabbath was over, Mary Magdalene, Mary the mother of James, and Salome bought spices so that they might go to anoint Jesus' body. 2 Very early on the first day of the week, just after sunrise, they were on their way to the tomb NIV

¹⁴⁴ John 19:39-40 Nicodemus brought a mixture of myrrh and aloes, about seventy-five pounds. 40 Taking Jesus' body, the two of them wrapped it, with the spices, in strips of linen. This was in accordance with Jewish burial customs. NIV

¹⁴⁵ John 11:39 "Take away the stone," he said. "But, Lord," said Martha, the sister of the dead man, "by this time there is a bad odor, for he has been there four days." NIV

Yeshua was killed in the afternoon of the preparation day. The following days (day #1, #2, #3) he was in the tomb. And on the third¹⁴⁰ day (i.e. Day #3) he was resurrected.

Using scenario #3
This solution is retained because it is the only one that generates the **same 3 days pattern** that we have seen at Akeda on page 258.

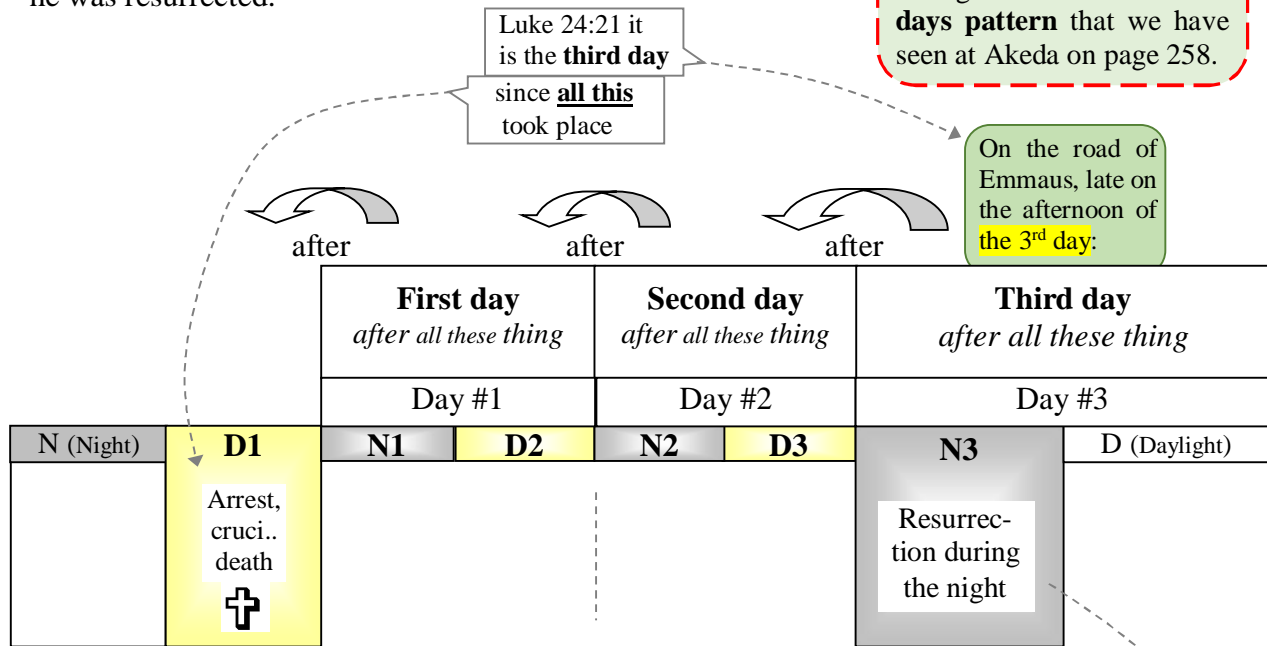

Matt 12:40 so the Son of Man will be three days and three nights in the heart of the earth. **D1, D2, D3 & N1, N2, N3**

Luke 24:46 He told them, "This is what is written: The Christ will suffer and rise from the dead on the third day, NIV

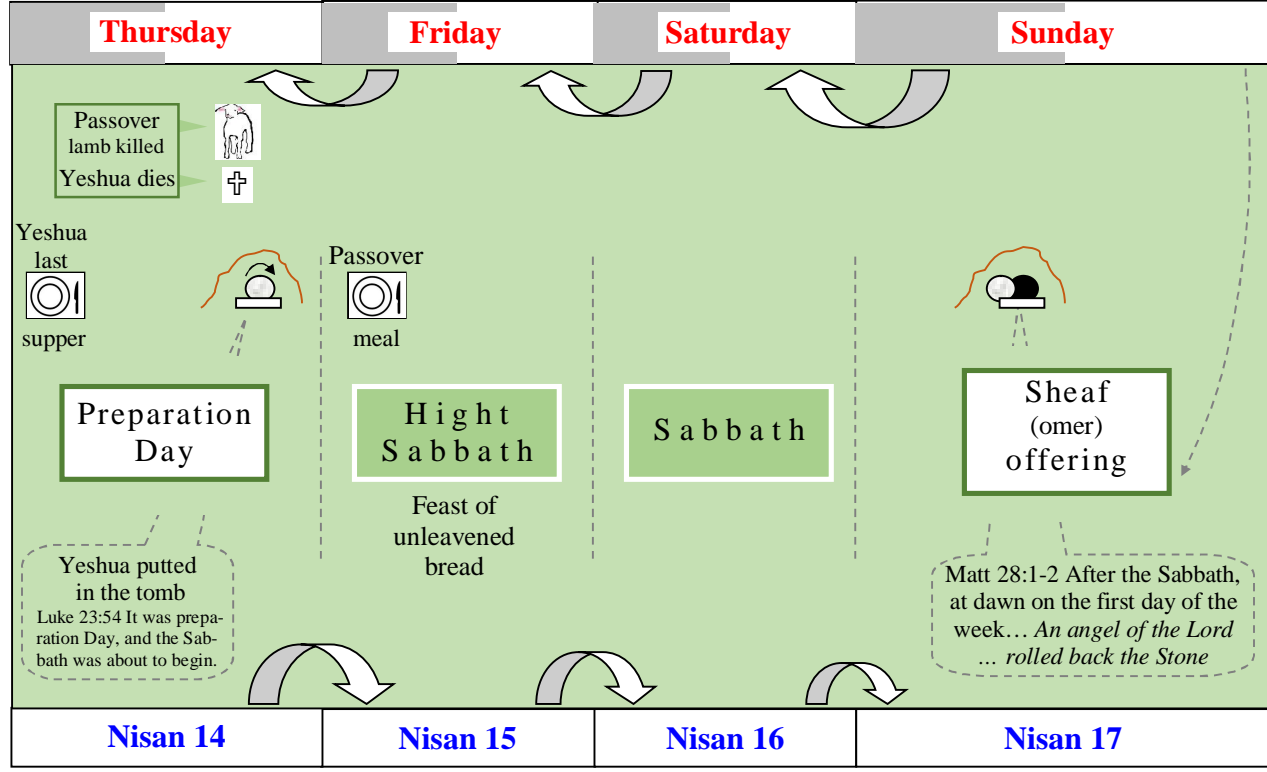

¹⁴⁶ Luke 24:21 it is the third day since all this took place. NIV

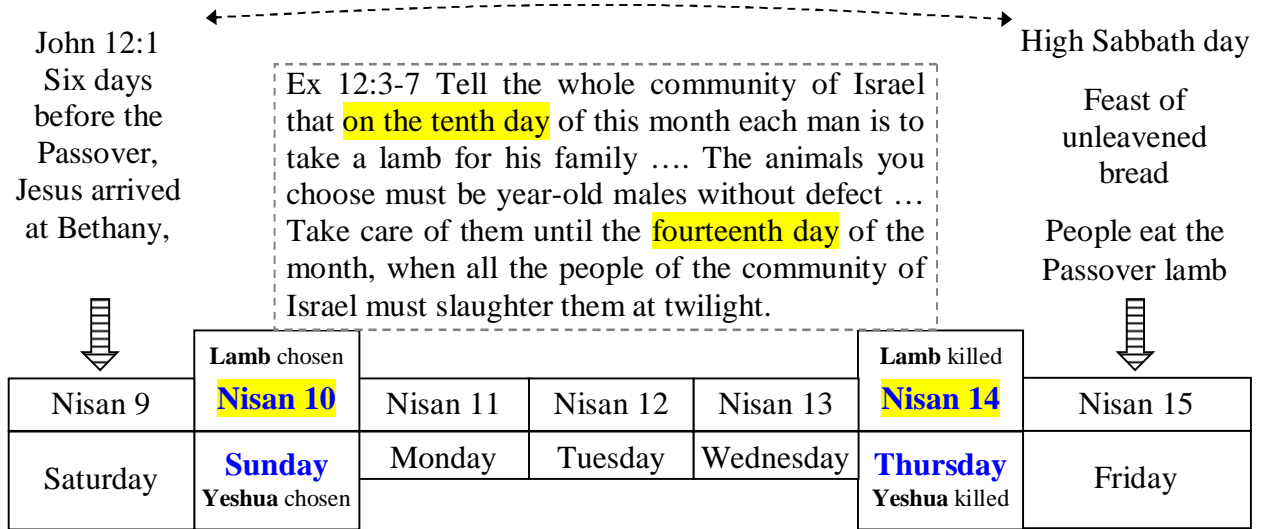

Four days before the crucifixion, Yeshua, the lamb of God, was chosen by the people of Jerusalem.

John 12:12-13 The next day the great crowd that had come for the Feast heard that Jesus was on his way to Jerusalem. They took palm branches and went out to meet him, shouting, "Hosanna!" "Blessed is he who comes in the name of the Lord!"

Yeshua's birth. According to Micah 5:2, Matt 2:1, Luke 2:4, John 7:41, Yeshua (the bread of life, John 6:35) was born in Bethlehem (house of bread). But where¹⁴⁷ exactly in Bethlehem? Few people are aware of the following possibility. According Micah 8:2¹⁴⁸ the 'Messiah' would be born at the watch tower of the flock (known as **Migdal Eder** in Hebrew). This is the tower where Rachel¹⁴⁹ died while giving birth to Jacob's youngest son, Benjamin (see Gen 35:21). A passage of the Talmud¹⁵⁰ associates the tower 'Migdal Eder' with the lambs that were needed for the sacrifices at the Temple¹⁵¹. While the flocks were kept in the fields year around, the ewes were brought to the lower portion of the tower when it was time for birthing.

Once birthed, the priestly shepherds would routinely place the lambs in the hewn depression of a limestone rock known as "the **manger**" and "wrap the newborn lambs in **swaddling clothes**," preventing them from thrashing about and harming themselves "until they had calmed down" so they could be inspected for the quality of being "without spot or blemish" (the Jewish oral tradition)

The night Yeshua was born, there was shepherds (see Luke 2:8-16) living out in the fields at Bethlehem and keeping watch over their flocks. Suddenly the glory of the Lord shone around them and the shepherds were told by an angel that a 'Messiah' had just been born. **And they were given this sign: you will find the baby wrapped in 'swaddling clothes' and lying in a manger**. How could these shepherds have known where to go to find the newly born baby? Here is a fascinating theory¹⁵². They knew exactly where to go because, as the priestly shepherds of the Migdal Eder, they were familiar with Micah 4:8 prophecy. **The sign** would have been useless to help anybody else but to them it could only mean one place, their tower. (Also see Cooper P Abrams¹⁵³ very good article)

¹⁴⁷ Around year 330 AD, Helena, mother of Emperor Constantine, identified a cave and had a church built over it. This church was destroyed in the 6th century and the Basilica of Nativity was rebuilt over it.

¹⁴⁸ Mic 4:8 As for you, O watchtower of the flock, O stronghold of the Daughter of Zion, the former dominion will be restored to you; kingship will come to the Daughter of Jerusalem." NIV

¹⁴⁹ OT:7353 **Rachel** (raw-kale'); from an unused root meaning to journey; a ewe [the females being the predominant element of a flock] (as a good traveller): KJV - **ewe, sheep**.

¹⁵⁰ Babylonian Talmud Book 2 Tract Shekalim chapt VII

¹⁵¹ Each year the Temple's rituals and the Passover required thousands of perfect animals.

¹⁵² I learned all about this from Ray Foucher (<http://www.jesus-resurrection.info>)

¹⁵³ 'Where was the birth place of the Lord Jesus'

A surprising deduction about the last supper.

The last supper could not have been a Passover meal knowing that Yeshua died at 03h00 in the afternoon of the 14 of Nissan. At the very same time thousands of Passover lambs were killed for the Passover meal that would take place a few hours later during the feast of unleavened bread (Nissan 15).

At first glance the following verse convey the idea that Yeshua sent some of his disciples to prepare the Passover meal at the start of Nisan 15 (i.e. at the start of the feast of Unleavened Bread).

- Matt 26:17 "Now the first day of the feast of unleavened bread, the disciples came to Jesus, saying unto Him, Where will You that we prepare for You to eat the Passover?"

But remove these important keywords (day, feast) added by the translator¹⁵⁴ and consider an alternative choice to the word 'first' and the verse don't point to the start of Nisan 15 anymore.

- Matt 26:17 "Now before the unleavened bread, the disciples came to Jesus, saying unto Him, Where will You that we prepare for You to eat the Passover?"

There are no doubt that the disciples went to make some preparation because of the coming Passover meal but it had nothing to do with preparing the Passover meal itself. Remember what was said about the day of preparation on page 245. It was the custom during the day of preparation, i.e. Nissan 14, to remove¹⁵⁵ any trace of yeast from the room or house where the Passover meal would be consume the following day. Yeshua didn't own a house but nevertheless he made some arrangement to have a guess room available for the purpose of having a Passover meal the next day. Given that the disciple were sent to remove the yeast in that guess room, we know it must have been the start of the preparation day and therefore the start of Nissan 14.

Keep in mind this sequence of event.

- At the beginning of the Preparation day (Nisan 14) Yeshua sent some disciples to prepare a guess room for the Passover meal that would take place 24 hours later on Nissan 15.
- Some time later during the dame evening (14th of Nisan.), the disciples assemble together with Yeshua for a meal that would be remembered as the last meal
- After the meal they went to the garden of Gethsemane and Yeshua was arrested later on during the evening.
- During the night and early in the morning Yeshua was judged and condemned. (Nisan 14)
- At 09h00 in the morning (still Nisan 14) Yeshua is hanged on the tree. (Nissan 14)
- At 03h00 in the afternoon He died (at the same time that the lamb were killed).
- Early in the evening of the new day (Nissan 15) the people ate the Passover meal.

Nissan 14	Nissan 15
A	
<u>B</u>	<u>G</u>
C	
D	
E	
	F

¹⁵⁴ These words don't appears in the original text as they were added by the translators for better readability in the English. The problem with that practice is that the translator could have misunderstood the original sense of a verse and oriented his translation accordingly.

¹⁵⁵ Ex 12:15 on the first day **remove the yeast from your houses**, for whoever eats anything with yeast in it from the first day through the seventh must be cut off from Israel. NIV

Three hints that the last supper was not a Passover meal:

1. During the meal they ate leaven bread and we know that the Passover meal was eaten with unleavened bread.
 - Matt 26:26 While they were eating, Jesus took bread¹⁵⁶, gave thanks and broke it, and gave it to his disciples, saying, "Take and eat; this is my body." NIV
2. During that last supper Yeshua told Judas to do what he had to do quickly, hearing this some of the apostles thought that He was sending Judas to buy what was missing for the Feast. (See John 13:27-30) The deduction of these apostles make sense only in a context where they were not already participating in a Passover meal. It would have been strange and inappropriate to send Judas buy some things for the most important meal of the year if that meal was almost already over.
3. Yeshua said that he wouldn't share the Passover meal with them.
 - Luke 22:15-16 And he said to them, "I have eagerly desired to eat this Passover with you before I suffer. For I tell you, I will not eat it **again**¹⁵⁷ until it finds fulfillment in the kingdom of God." NIV

Once the word 'again' is removed from the verse the meaning become quite different. Let's me paraphrase: Yeshua told the disciple that He would have like to share the Passover meal of the next day but now He knew that it wouldn't be possible.

And here is something that nobody realize before: Because the guess room had been ridden of any trace of yeast by the disciples sent by Yeshua, and because leaven bread was eaten¹⁵⁸ during the last meal, we have the certitude that **THE LAST MEAL WAS NOT TAKEN IN THAT GUESS ROOM**. It is inconceivable that they would have polluted that room with leaven bread before the feast of unleavened bread was over 8 days later.

We could still argue: Why did Yeshua send John and Peter to prepare a room for a meal that wouldn't take place? And my answer would be: Ignorance. Although He knew that His death would happened real soon, Yeshua must have believe that he would be allowed to take part of the next Passover meal. (maybe He thought that His death had to coincide with the time when the first born were killed in Egypt, i.e. after the Passover meal at midnight on the 15 of Nisan). I believe the timing of his death was only reveal¹⁵⁹ to Him sometime during 'the last supper'.

- John 13:21 After he had said this, Jesus was troubled in spirit and testified, "I tell you the truth, one of you is going to betray me." NIV

Interesting isn't? Right after He was troubled in spirit He told the others about Judas betrayal. Wouldn't we be troubled in spirit too if we suddenly had a vision of our imminent death? Make me think that Isaac also learned at the last minute that he would be sacrificed, no matter that his father had known for the last three days.

¹⁵⁶ the Greek word (*artos*) refers to an ordinary loaf—not to the *unleavened* flat bread or *matzos* that Jews eat with their Passover meals. From James Tabor 'Jesus Died on a Thursday not on Friday' on the 'Tabor blog'

¹⁵⁷ A later copyist of the manuscript inserted the word "again" to make it say "I won't eat it again," since the tradition had developed that Jesus did observe Passover that night and changed its observance to the Christian Eucharist or Mass. (From James Tabor 'Jesus Died on a Thursday not on Friday' on the 'Tabor blog' .)

¹⁵⁸ Eating unleavened bread before Nisan 15 would have trivialize the Unleavened bread festival



¹⁵⁹ We always assume that Yeshua knew everything a long time in advance, but what if it was not the case? I don't believe in his pre-existence or any form of incarnation. Yeshua was a mortal until his death.

Appendix D

Synchronizing the Hebrew and the Gregorian calendar

It is only once the whole internal Bible's chronology has been figured out, when each event is properly positioned on the timeline 0 to 6,000 AM, that an external Gregorian date is needed but for the sole purpose of synchronizing both the 'AM' and the 'Gregorian' calendars. We saw on page 160 that Yeshua was born in 3960 AM of the Hebrew calendar. According to a research of Ernest Marin¹⁶⁰, based on the apparent motion of several celestial bodies (Sun, Moon, Jupiter, Venus, Mercury, Mars, Regulus) Yeshua was born in 3/2 BC on the Gregorian calendar. Using it (**3960 AM = 3/2 BC**) as an anchoring point, we can, without difficulties, figure out the Gregorian date of every event addressed in the present book.

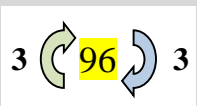
For instance, the **world** was created in **0 AM**. This becomes **3963/3962 BC** in the Gregorian¹⁶¹ calendar. The following facts show that this '3963' is not a meaningless value.

<p>Is it a coincidence that the earth's radius at the equator is 3963 miles?</p> <p>By rotating the two middle digits of 3963 we still obtain 3963.</p>	 	<p>Is-it also a coincidence that the highest peak in Israel, Mount Meron in the upper Galilee, is 3,963 feet?</p> 
---	--	--

On his webpage, Tony Badillo makes a convincing case that Jachin and Boaz, the two pillars of the Temple (1 King 7:21) represent David and Solomon. As shown here, these two kings have also a role of pillar in the present chronology.

2963 AM	David King of Judah	1000 / 999 BC
3000 AM	Solomon King of Israel	963 / 962 BC

¹⁶⁰ The birth of Christ recalculated by Ernest Martin.

¹⁶¹ German protestant mathematician and historian 'Philip Melanchthon' came to the same conclusion in his Chronicle: "The world was created in **3963 B.C.**" - **Philip Melanchthon 1497-1560**

Appendix E

The Bible's timeline

AM	Gregorian Calendar BC/AD	EVENT	Bible Ref.	More details
0	3963/3962 BC	Adam born		
130	3833/3832 BC	Seth born	Gen 5:3	
235	3728/3727 BC	Enosh born	Gen 5:6	
325	3638/3637 BC	Kenan born	Gen 5:9	
395	3568/3567 BC	Mahalalel born	Gen 5:12	
460	3503/3502 BC	Jared born	Gen 5:15	
622	3341/3340 BC	Enoch born	Gen 5:18	
687	3276/3275 BC	Methuselah born	Gen 5:21	
874	3089/3088 BC	Lamech born	Gen 5:25	
930	3033/3032 BC	Adam dies	Gen 5:5	
987	2976/2975 BC	Enoch dies	Gen 5:23	
1042	2921/2920 BC	Seth dies	Gen 5:8	
1056	2907/2906 BC	Noah born	Gen 5:28	
1140	2823/2822 BC	Enosh dies	Gen 5:11	
1235	2728/2727 BC	Kenan dies	Gen 5:14	
1290	2673/2672 BC	Mahalalel dies	Gen 5:17	
1422	2541/2540 BC	Jared dies	Gen 5:20	
1536	2427/2426 BC	Noah starts building the Ark	Gen 6:3 (1656 -120)	
1558	2405/2404 BC	Shem born	Gen 11:10	
1651	2312/2311 BC	Lamech dies	Gen 5:31	
1656	2307/2306 BC	Methuselah dies Flood	Gen 5:27 Gen 7:6	
1658	2305/2304 BC	Arphaxad born	Gen 11:10	
1693	2270/2269 BC	Shelah born	Gen 11:12	
1723	2240/2239 BC	Eber born	Gen 11:14	
1757	2206/2205 BC	Peleg born	Gen 11:16	
1787	2176/2175 BC	Reu born	Gen 11:18	
1819	2144/2143 BC	Serug born	Gen 11:20	

AM	Gregorian Calendar BC/AD	EVENT	Bible Ref.	More details	
1849	2114/2113 BC	Nahor born	Gen 11:22		
1878	2085/2084 BC	Terah born	Gen 11:24		
1948	2015/2014 BC	Haran born	This work		P. 242
1993	1970/1969 BC	Babel	Inference		P. 197
1996	1967/1966 BC	Peleg dies	Gen 11:19		
1997	1966/1965 BC	Nahor dies	Gen 11:25		
2006	1957/1956 BC	Noah dies	Gen 9:29		
2008	1955/1954 BC	Abram born	Gen 12:4		P. 143
2018	1945/1944 BC	Sarai born	Gen 17:17 2108 - 90		P. 148
2026	1937/1936 BC	Reu dies	Gen 11:21		
2033	1930/1929 BC	Abram marries	Inference		P. 181
2049	1914/1913 BC	Serug dies	Gen 11:23		
2063	1900/1899 BC	Abram leaves Ur (goes to Haran)	Inference		P. 179
2083	1880/1879 BC	Terah dies / Abram leaves Haran and goes to Canaan	Gen 11:32/12:4 2008 + 75		
2088	1875/1874 BC	Abraham goes to Egypt	Inference		P. 196
2093	1870/1869 BC	Pregnant Hagar ran away Covenant of the Land	Gen 16:3-4 2083 +10		P. 80
2094	1869/1868 BC	Ishmael born	This work		P. 80
2096	1867/1866 BC	Arphaxad dies	Gen 11:13		
2107	1856/1855 BC	Covenant of circumcision	Gen 17:24 2008 + 99		P. 80
2108	1855/1854 BC	Isaac born	Gen 17:17 (2008 + 100)		P. 148
2123	1840/1839 BC	Binding of Isaac (AKEDAH)	2523 - 400		P. 85
2126	1837/1836 BC	Shelah dies	Gen 11:15		
2145	1818/1817 BC	Sarai dies	Gen 23:1 2018 + 127		
2148	1815/1814 BC	Isaac marries	Gen 25:20 2108 + 40	P. 181	
2158	1805/1804 BC	Shem dies	Gen 11:11		

AM	Gregorian Calendar BC/AD	EVENT	Bible Ref.	More details
2168	1795/1794 BC	Jacob born	Gen 25:26 2108 + 60	P. 202
2183	1780/1779 BC	Abraham dies	Gen 25:7 2008 + 175	P. 80
2187	1776/1775 BC	Eber dies	Gen 11:17	
2208	1755/1754 BC	Esau marries	Gen 26-34 2168 + 40	
2231	1732/1731 BC	Ishmael dies	Gen 25:17 2094 + 137	
2245	1718/1717 BC	Jacob hired by Laban	Gen 31:41 2265 - 14 - 6	P. 146
2252	1711/1710 BC	Jacob marries Leah and Rachel	Gen 29:20 2245 + 7	
2253	1710/1709 BC	Reuben born	Gen 29:31 2252 + 1	P. 200
2255	1708/1707 BC	Levi born	(third son) 2253 + 2	
2258	1705/1704 BC	Joseph born	Gen 41:46 2288 - 30	P. 180
2259	1704/1703 BC	End of first 14 years	Gen 30:25 2258 + 1	
2265	1698/1697 BC	Jacob leaves Laban	Gen 31:41 2245+7+7+6	P. 164
2268	1695/1694 BC	Benjamin born	Inference	P. 144
2275	1688/1687 BC	Joseph goes to Egypt	Gen 37:2 2258 + 17	P. 144
2285	1678/1677 BC	Joseph sent to jail	Inference	P. 144
2286	1677/1676 BC	Joseph helps the chief baker	Gen 41:1 2288 - 2	P. 1464
2288	1675/1674 BC	Isaac dies Joseph meets Pharaoh	Gen 35:28 2108 + 180 Gen 41:25 2289 - 1	P. 180
2289	1674/1673 BC	Start of 7 years of plenty	Gen 41:53 2296 - 7	P. 144
2291	1672/1671 BC	Manasseh born	Inference	P. 144

AM	Gregorian Calendar BC/AD	EVENT	Bible Ref.	More details
2295	1668/1667 BC	Ephraim born	Inference	P. 144
2296	1667/1666 BC	Start of 7 years of famine	Gen 45:10 2298 - 2	P. 144
2298	1665/1664 BC	Jacob in Egypt	Gen 47:28 2315 - 17	P. 146
2315	1648/1647 BC	Jacob dies	Gen 47:28 2168 + 147	P. 200
2368	1595/1594 BC	Joseph dies	Gen 50:26 2258 + 110	P. 144
2392	1571/1570 BC	Levi dies	Exo 6:16 2255 + 137	
2440	1523/1522 BC	Aaron born	Ex 7:7 2443 - 3	
2443	1520/1519 BC	Moses born	Deut 34:7 2562 – 120 Inclusive years	P. 180
2463	1500/1499 BC	Joshua born	Josh 24:29 2573 - 110	P. 169
2483	1480/1479 BC	Moses escape from Egypt	Act 7:23 2443 + 40	P. 55
2484	1479/1478 BC	Caleb born	Josh 14:7 2524 - 40	P. 18
2522	1441/1440 BC	Burning bushes	2523 - 1	P. 177
2523	1440/1439 BC	EXODUS	2093 + 430	P. 85
2524	1439/1438 BC	Tabernacle set up Leaves Sinai Land spied	Ex 40-17 2523 + 1	P. 177
2543	1420/1419 BC	Leaves Kadesh Barnea	Inference	P. 177
2562	1401/1400 BC	Aaron & Moses die	2563 – 1	P. 18
2563	1400/1399 BC	Promised Land	Num 14:33-34 2523 + 40	P. 18
2569	1394/1393 BC	Land divided	Josh 14:10 2484 + 85	P. 18
2573	1390/1389 BC	Joshua dies	Act 13:16-20 2123 + 450	P. 169
2583	1380/1379 BC	Gibeah Sin	2973 - 390	P. 68
2593	1370/1369 BC	#1 Opp. Cushan	Inference	P. 167

AM	Gregorian Calendar BC/AD	EVENT	Bible Ref.	More details
2601	1362/1361 BC	Judge Othniel	Judg 3: 8 2593 + 8	P. 172
2641	1322/1321 BC	#1 Opp. Eglon	Judg 3:11 2601 + 40	P. 172
2659	1304/1303 BC	Judge Ehud	Judg 3:14 2641 + 18	P. 172
2677	1286/1285 BC	#3 Opp. Jabin	2659 + 18	P. 172
2697	1266/1265 BC	Judge Barak	Judge 4:3 2677 + 20	P. 172
2737	1226/1225 BC	12 years Gap no judges, no oppressions	Inference	P. 171
2749	1214/1213 BC	#4 Opp. Median	Judg 6:1 2756 - 7	P. 172
2756	1207/1206 BC	Judge Gideon	Judg 8:28 2796 - 40	P. 172
2775	1188/1187 BC	Eli born	1 Sam 4:15 2873 - 98	
2796	1167/1166 BC	#5 Opp. Abimelec	Judg 8:22 2799 - 3	P. 172
2799	1164/1163 BC	Judge Tola	Judg 10:2 2822 - 23	P. 172
2822	1141/1140 BC	Judge Jair	Judg 10:3 2844 - 22	P. 172
2833	1130/1129 BC	Eli judge	1 Sam 4:18 2873 - 40	P. 55
2844	1119/1118 BC	#6 Opp. Ammon	Judg 10:8 2862 - 18	P. 172
2853	1110/1109 BC	#7 Opp. Philistines	Judg 13:1 2893 - 40	P. 172
2862	1101/1100 BC	Judge Jephtah	Jug 12:7 2868 - 6	P. 172
2863	1100/1999 BC	Samuel birth	Inference	P. 167
2868	1095/1094 BC	Judge Ibzan	Judg 12:9 2275 - 7	P. 172
2872	1091/1090 BC	Judge Samson		Author Other Work
2873	1090/1089 BC	Ark is captured	2483 + 390	P. 55

AM	Gregorian Calendar BC/AD	EVENT	Bible Ref.	More details
2874	1089/1088 BC	Ark is returned	1 Sam 6:1 2873 + 7 mo.	Could be 2873 also
2875	1088/1087 BC	Judge Elon	Judg 12:11 2885 - 10	P. 172
2885	1078/1077 BC	Judge Abdon	Judg 12:14 2893 - 8	P. 172
2892	1071/1070 BC	Samson dies	Judg 16:20 2872 + 20	
2893	1070/1069 BC	Samuel judges	1 Sam 7:2 2873 + 20	P. 55
2923	1040/1039 BC	King Saul (40 y.)	Act 13:21 2963 - 40	P. 55
2933	1030/1029 BC	David born	2 Sam 5:4-5 2963 - 30	P. 55
2943	1020/1019 BC	Saul rejected ????	Inference	P. 185
2953	1010/1009 BC	Samuel dies	2523 + 430	P. 67
2963	1000/999 BC	King David (over Judah) Ish-Bosheth king over Israel	1 Chron 29:27 3003 - 40	P. 224
2965	998/997 BC	King Ish-Bosheth dies	2 Sam 2:10	P. 224
2966	997/996 BC	David king Israel	This work	P. 224
2970	993/992 BC	David moves to Jerusalem	2 Sam 5:4-5 2963 + 7	P. 55
2973	990/989 BC	Ark brought in Jerusalem	1 Chron 15:1 2970 + 3	P. 68
2983	980/979 BC	Solomon born	Inference	P. 196
3000	963/962 BC	King Solomon (17 years old) (will reign 63 years)	1 Kings 6:1 3003 - 4 th year	P. 196
3003	960/959 BC	Start of first Temple const.	2 Sam 5:4-5 2523 + 480	P. 55
3010	953/952 BC	1 st Temple is ready	1 Kings 7:38 3003 + 7	P. 55
3013	950/949 BC	Ark brought to Temple	3010 + 3	P. 68
3023	940/939 BC	Solomon is endorsed by God Palace is ready	1 Kings 7:1 3010 + 13	P. 105
3063	900/899 BC	Solomon dies Kingdom split K Rehoboam South Kingdom #1 K Jeroboam North Kingdom #1	1 Kings 11:42 3023 + 4 0	P. 105

AM	Gregorian Calendar BC/AD	EVENT		More details
3080	883/882 BC	K Abijah SK2		A.O.W
3082	881/880 BC	K Asa SK3		A.O.W
3084	879/878 BC	K Nadab NK2		A.O.W
3085	878/877 BC	K Baasha NK3		A.O.W
3108	855/854 BC	K Elah NK4		A.O.W
3109	854/853 BC	K Zimri NK5 K Tibni NK6 K Omri NK7		A.O.W A.O.W A.O.W
3113	850/849 BC	Foundation of Samaria	3503 - 390	P. 72
3120	843/842 BC	K Ahab NK8		A.O.W
3123	840/839 BC	K Jehoshaphat SK4		A.O.W
3140	823/822 BC	K Jehoram SK5 K Ahaziah NK9		A.O.W
3141	822/821 BC	K Joram NK10		A.O.W
3151	812/811 BC	K Ahaziah SK6		A.O.W
3152	811/810 BC	Q Athaliah SK7 K Jehu NK11 K Joash SK8		A.O.W A.O.W A.O.W
3175	788/787 BC	K Jehoahaz NK12		A.O.W
3189	774/773 BC	K Jehoash NK13		A.O.W
3191	772/771 BC	K Amaziah SK9		A.O.W
3206	857/856 BC	K Jeroboam II NK14		A.O.W
3233	830/829 BC	K Uzzia SK10		A.O.W
3271	692/691 BC	K Zecharia NK15		A.O.W
3272	691/690 BC	K Shallum NK16 K Menahem NK17		A.O.W
3283	680/679 BC	K Pekahiah NK18		A.O.W
3285	678/677 BC	K Pekah NK19 K Jotham SK11		A.O.W
3302	661/660 BC	K Ahaz SK12		A.O.W
3303	660/659 BC	ISAIAH foretells that Ephraim will be broken (Israel doom)	Isa 7:8-9 3368 - 65	P. 98
3314	649/648 BC	K Hoshea NK20		A.O.W

AM	Gregorian Calendar BC/AD	EVENT		More details
3317	646/645 BC	K Hezekiah SK13	A.O.W	A.O.W
3323	640/639 BC	EXILE of Israel	2 Kings 18:10 3314 + 9	P. 94
3328	635/634 BC	Hezekiah's Passover	3368 - 40	A.O.W
3333	630/629 BC	K Manasseh SK14	3443 - 110	P. 15
3368	595/594 BC	Manasseh sets an ABOMINATION in the Temple	3333 + 35	P. 15
3388	575/574 BC	K Amon SK15	2 kings 21:19 3390 - 2	P. 15
3390	573/572 BC	K Josiah SK16	2 kings 22:1 3421 - 31	P. 15
3403	560/559 BC	Jeremiah prophesies	Jer 25:1-3 3390 + 13	P. 58
3408	555/554 BC	Josiah's Passover	2 Kings 23:23 3390 + 18	P. 58
3421	542/541 BC	K Jeohaz SK17 K Jehoiakim SK18	2 Kings 23:36 3432 - 11	P. 15
3423	540/539 BC	Start of Babylon 70 years	Jer 25:11 3493 - 70	P. 103
3424	539/538 BC	King Nebuchadnezzar		P. 103
3432	531/530 BC	K Jehoiachin SK19 K Zedekiah SK20	2 Chron 36:11 3443 - 11	P. 58
3433	530/529 BC	EXILE of Judah	2 King 24 :13-17	P. 72
3443	520/519 BC	<u>End of first Temple</u> (start of 70 years of desolation)	3013 + 430	P. 66
3493	470/469 BC	Fall of Babylon's empire King Darius (the mede)	3063 + 430	P. 104
3502	461/460 BC	King Cyrus	3503 - 1	P. 132
3503	460/459 BC	Return of the 42,360 exiles (end of Judah's exile)	Jer 29:10 3433 + 70	P. 72
3509	454/453 BC	Exiles set an Altar	3503 + 6	P. 123
3510	453/452 BC	<u>Foundation of 2nd Temple</u> (start of Daniel's 70 weeks)	3503 + 7	P. 132
3511	452/451 BC	King Darius (Artaxerxes)	3502 + 9	P. 123

AM	Gregorian Calendar BC/AD	EVENT	Bible Ref.	More details
3513	450/449 BC	Construction of 2 nd Temple starts	3511 + 2	P. 132
3517	446/445 BC	2 nd Temple is ready	Ezra 4:24,6:15 3513 + 4	P. 123
3531	432/431 BC	Start of Nehemiah's wall's repairs	Neh 2:1 3511 + 20	P. 122
3543	420/419 BC	Nehemiah's wall fully repaired	Neh 5:14 3531 + 12	P. 122
3547	416/415 BC	King Xerxes (Book of Esther)	Est 3:7 3559 -12	P. 132
3559	404/403 BC	First Purim (end of Daniel first 7 weeks)	Dan 9:25 3510 + 49	P. 132
3943	20/19 BC	Herod repairs the Temple	3513 + 430	P. 114
3960	3/2 BC	Yeshua born	Inference	P. 160
3972	10/11 AD	Yeshua in Temple at 12 years old	Luc 2:42 3960 + 12	P. 160
3989	27/28 AD	Start of Yeshua's ministry	3559 + 430	P. 138
3993	31/32 AD	Yeshua dies (end of Daniel first 69 weeks)	Dan 9:25 3510 + 483	P. 117
4033	?? 71/72 AD ??	End of 2 nd Temple	Inference	P. 160
5983	2021/2022 AD	Recall of the northern lost tribes? --WAKUP--	Inference	P. 184
5993	2031/2032 AD	Start of Daniel's 70th week	6000 - 7	P. 226

Notice that contrary to the popular belief, I have the destruction of the 2nd Temple in **71 AD**. Have I been careless somehow in my chronology? Do you know that the Jewish sage cannot make their mind if the Temple came down in 69 or 70 AD? In fact the Talmud says that the Temple stood 420 years and the Jewish sage debate if it means that it was destroyed in its 420th year, or after it had been standing up for a full 420 years. According my chronology the Temple came down 520 years after the start of its construction. (Observe how my 520 years value is strangely similar to the Talmud 420 years. Have the earliest Talmudic writers wrongly recorded 420 years instead of 520? I believe so).

To the Jews our Gregorian year 2000 AD was equivalent to their year 5760 AM. They really seem to be offset about 200 years¹⁶². Unfortunately they won't be aware of their mistake as long as they will persist denying that Yeshua was the Messiah they had been waiting for.

¹⁶² R' Azariah dei Rossi, in *Me'or Einayim* (c. 1573), was likely the first Jewish authority to claim that the traditional Hebrew dating is not historically precise regarding the years before the Second Temple.

Appendix F Hidden link between 3443 and 3993

Palindromic connections that highlight the complementarity between 3443 and 3993

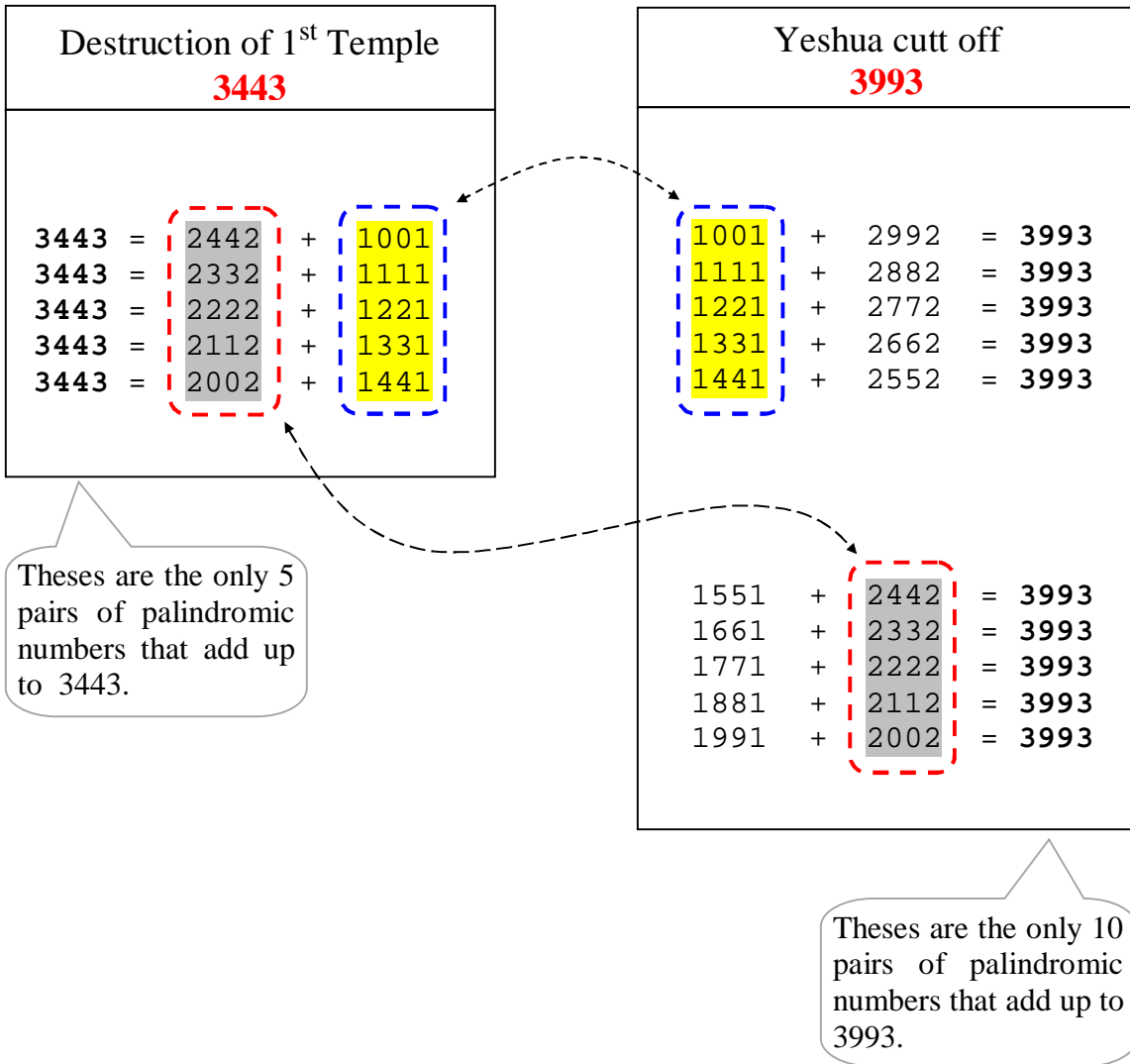

Appendix G Daniel 8:14 ‘2300 evenings and mornings’

The following figure give an overview of some past, present and future kingdom as described in visions in the books of Daniel and Revelation.

				Rev 17 7 heads
	Daniel 2 Male image	Daniel 7 4 beasts	Daniel 8 Ram & Goat	1 Egypt c. 3150 BC
				2 Assyria c. 2500-606 BC
	Head of gold	1 Lion		3 Babylon c. 626-539 BC
	Breast & arms of silver	2 Bear	Ram 2 horns Mede/Persia	4 Persia c. 539-332 BC
	Belly & tights of Brass	3 Leopard (4 heads)	Goat single horn Greece Alexander kingdom Would later split in 4 1 Selucid (north) Mesopotamia and Central Asia 2 Attalid Anatolia 3 Antigonid Macedon 4 Ptolemaic (south) Egypt	5 Greece c. 332 – 63 BC
	Legs of iron Rome kingdom had split in 2: Eastern - Western Rome – Constantinople	4 Powerful beast		6 One is Rome c. 63 BC – 476 AD
				7 One is to come Ottoman c. 1300–1922 AD

Figure 21 Beast vision¹⁶³

¹⁶³ This is an extract from ‘Is WWII on the Horizon?’ from pastor Tony Bosserman

Daniel Chapter 8 describes a vision in which a Goat with a single horn quickly and furiously attacks a two horns Ram. The bible tells us that the Ram and the Goat represent respectively the Persian and the Grecian empire.

It is a know fact that the three defeats of the Persian King, Darius III (**battles of Granicus in 334 BC**, Issus in 333 BC and Gaugamela in 331 BC), against the army of Alexander the great marked the end of the Persian empire and the consolidation of the Grecian empire.

The collapse of the Persian empire brought to an end the peaceful control they had over Jerusalem. (In the past, the Persian had facilitated the return of Judah exiles, contributed to the erection of the second Temple and allowed the rebuilding of the city.) When they invaded Asia for the first time (battle of Granicus 334 BC) the Greeks began an hostile period of domination over Jerusalem and all the other Persian's territories.

A few years ago, in a book called 'Restoring Abrahamic Faith' by James Tabor, I read about a prediction done in 1825 AD by Adam Clarke. According Mr. Clarke, the 2300 'evenings and mornings' period mentioned in Dan 8:14, should be counted from the time of the Battle of Granicus in 334 BC. Unaware of it, Mr. Clarke had just linked, a century before it happens, the 1967 Israel 6-day war and the beginning of the Greek's domination over Jerusalem. During the 6-day war the Jew regained for the first time in the last 2300 years full sovereignty over Jerusalem old city and the Temple mount¹⁶⁴.

In spite of this outstanding coincidence I was never completely convinced that the 2300 evenings and mornings of Daniel 8:14 should be interpreted as 2300 years. Unlike many others I don't believe that there is a systematic 'Day for Year' principle in Bible prophecy¹⁶⁵. What make me fully accept that the 2300 evenings and mornings of Daniel 8:14 was meant to be interpreted as years is a suggestion found in an article of Dan Bruce¹⁶⁶. According Mr. Bruce the key to understand the somewhat cryptic usage of 'evenings and mornings' in Daniel's propcey can be found in Exodus 12:6-10 . And more specifically in

- Ex 12:6 And ye shall keep it up until the fourteenth day of the same month: and the whole assembly of the congregation of Israel shall kill it in the evening¹⁶⁷ KJV
- Ex 12:10 And ye shall let nothing of it remain until the morning; and that which remaineth of it until the morning ye shall burn with fire. KJV

Daniel 'evenings and mornings' (a forgotten idiom ??) don't represent, strictly speaking, a unit of time. It rather refer to the sacrifice of the Passover which occurs 'between the two evening' of the 14th and had to be ended by early morning of the 15th day of the first month of the Hebrew calendar. Incidentally 2300 'evening and morning' (2300 Passover's sacrifices) do represent a period of time that covers 2300 years.

¹⁶⁴ *We have returned to all that is holy in our land. We have returned never to be parted from it again.* -Defense Minister Moshe Dayan, upon reaching the Western Wall

¹⁶⁵ Indeed Ezekiel 4 uses the day = year principle but this is explicitely requested in Ezek 4:5; During Exodus God kept the Israelites 40 years in the desert because of the outcome of the 40-day spy mission. Here too the day = years is justified, see Num 14:34; In Daniel 9 we read about the 70 weeks prophecy. It should be noted here that the original expression is 70 '7' without specifying if 'days' 'months' or 'years' are intended.

¹⁶⁶ 'Want proof of God? Check this out' Ban Bruce

¹⁶⁷ **Evening** (from "haa`arbaayim" IE. Between the two evenings = middle of the afternoon)

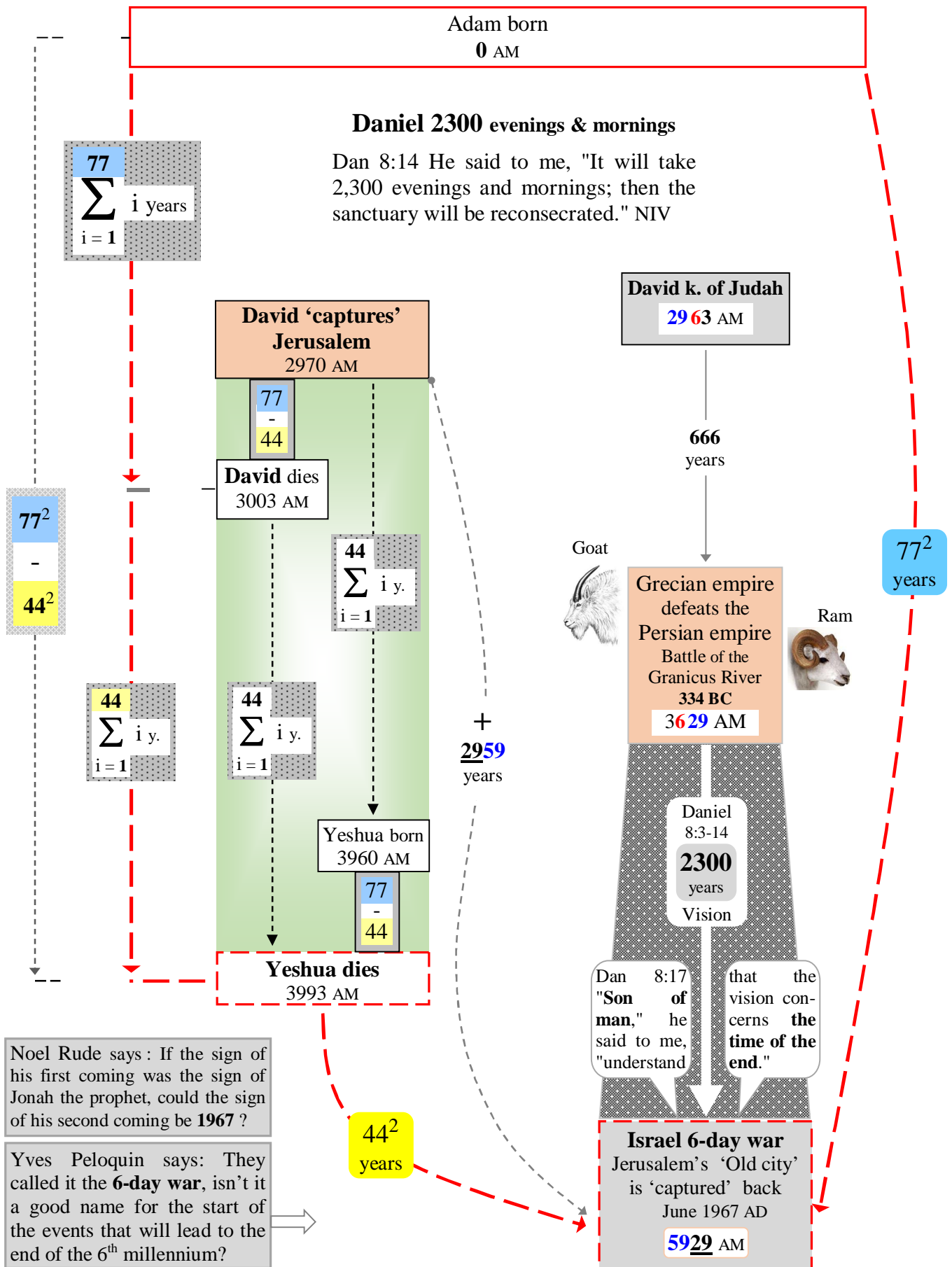

Appendix H Daniel 12:11-12 '1290 days & 1335 days'

(This topic is speculative in spite of two meaningful markers)

Dan 12:11-12 "From the time that the daily sacrifice is abolished and the abomination that causes desolation is set up, there will be **1,290** days. Blessed is the one who waits for and reaches the end of the **1,335** days. NIV

Manasseh's Abomination 3368 AM	Dan 12:11 "From the time that the daily sacrifice is abolished and the abomination that causes desolation is set up, there will be 1,290 days	Let's rephrase	From 'the set up of the abomination that causes desolation' To 'the abolition of the daily sacrifice' there will be 1,290 days
1290 years			
Daily sacrifice is abolished 4658 AM 696/697 AD	What could have happened in years 4658 AM (696/697 AD) that could convince us that the daily sacrifice had really been interrupted? Do you know that the Dome of the Rock, occupying the central point of the Temple Mount in Jerusalem, was completed in 691 AD under the order of <u>Umayyad Caliph Abd al-Malik</u> . Suppose the historical date of 691 AD is 5 years offset and the Dome of the Rock was in fact inaugurated in 696 AD (4658 AM)! Could the presence of that Islamic shrine on the Temple Mount, at the exact location where stood the Jewish Temple, have been enough to interrupt (or nullify) any daily sacrifice perform in this area? I would think so.		
1335 years			
Start of Daniel' 70 th week 5993 AM			

According Daniel 12:9 the meaning of the 1290 and 1335 years will be understood only at the time of the end.	? →	Why would it matter that the prophecy be understood only at the time of the end , unless the period (1290 + 1335 years) ends at that very time?
Dan 12:12 Blessed is the one who waits for and reaches the end of the 1,335 days.	? →	What could be the blessing at the end of the combined period of 1290 & 1335 years? Notice that the period started with the desecration of the Temple (thus an interruption of the sacrifice). Could the blessing be related to the construction of the third Temple and the resuming of the Sacrifice ? It would make a lot of sense!

	there is no proof at this point that the Dome of the Rock became operational in 696 AD instead of 691 AD.	Construction of the 3 rd Temple		
Manasseh's Abomination 3368 AM	1290 years	4658 AM 	1335 years	Start of Daniel's 70 th week 5993 AM

Appendix I Daniel's 70th week

Earlier in this book we have looked at the chronology of the first 69 weeks of Daniel 70 week prophecy (see page 116 & chart 26 on page 225), we will now look at the 70th week.

- Dan 9:27 He will confirm a covenant with many for one 'seven.' In the middle of the 'seven' he will put an end to sacrifice and offering. And on a wing [of the temple] he will set up an abomination that causes desolation, until the end that is decreed is poured out on him." NIV

Here are some interesting facts related to the 70th week:

- The ruler will confirm a 7 years' covenant at the beginning of the 70th week
 - The ruler will break the covenant in the middle of that week. (i.e. after 3.5 years)
 - The ruler will put an end to the sacrifice in the middle of the week
 - we can deduce that the **Sacrifice started** at the beginning of that week (year 5993 AM)
- Note: Isn't it what we concluded in the preceding appendix (H)?

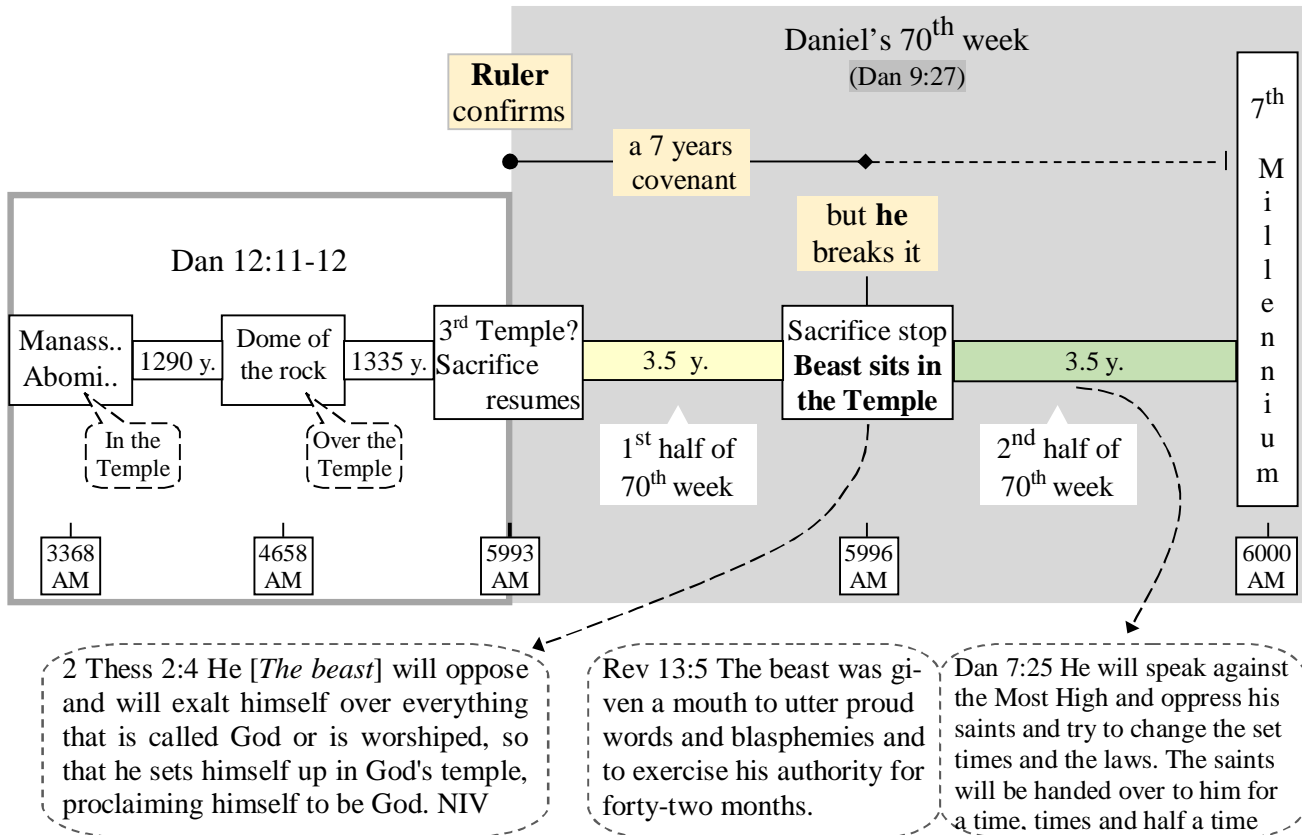

Matt 24:3 As Jesus was sitting on the Mount of Olives, the disciples came to him privately. "Tell us," they said, "when will this happen, and what will be the sign of your coming and of the end of the age?"

Because the question of the disciples is specific to the end time period, the answer given in Matt 24:4-32 can be interpreted in the context of Daniel 70th week. In the previous chart, Daniel's 70th week is divided in two periods, we will see that Yeshua's answer also describes two distinctive periods.

The first period is call the Birth pain

- Matt 24:4-8 "Watch out that no one deceives you. For many will come in my name, claiming, 'I am the Christ,' and will deceive many. You will hear of wars and rumors of wars, but see to it that you are not alarmed. Such things must happen, but the end is still to come. Nation will rise against nation, and kingdom against kingdom. There will be famines and earthquakes in various places. All these are the beginning of birth pains. NIV

The second period is associated with the ‘ruling’ of the beast (antichrist) . The period starts in the middle of Daniel’s 70th week, when the beast pretends to be God and sits in the Temple, and the period ends with the ‘day of the Lord’.

Start	Matt 24:15 "So when you see standing in the holy place 'the abomination that causes desolation, NIV	
	Rev 13:5 The beast was given a mouth to utter proud words and blasphemies and to exercise his authority for forty-two months. NIV	End

Note: Going backward 42 months from the beginning of the new millennium i.e. years 6000 AM (after the End time events are completed) bring us back in the middle of 5996 AM, i.e. in the middle of the 70th week of Daniel (beginning of the second period).

The day of the Lord represents the sum of events that will occur during the apocalyptic time of God's wrath. This final period will come just before the start of the 7th millennium, it will be introduced during the opening of the 7th seal and will conclude with the battle of ARMAGEDDON.

- Rev 8:1-6 When he opened the seventh seal, there was silence in heaven for about half an hour. And I saw the seven angels who stand before God, and to them were given seven trumpets. ... Then the angel took the censer, filled it with fire from the altar, and hurled it on the earth; and there came peals of thunder, rumblings, flashes of lightning and an earthquake. Then the seven angels who had the seven trumpets prepared to sound them.

Note The beast will become the supreme ruler of the world once he has broken the covenant in the middle of the 70th week. He will keep his authority until he is captured at the battle of Armageddon.

- Rev 19:19-20 Then I saw the beast and the kings of the earth and their armies gathered together to make war against the rider on the horse and his army. But the beast was captured, and with him the false prophet who had performed the miraculous signs on his behalf. NIV

Given that the beast will rule for 42 months (Rev 13:5) we can deduce that the Battle of Armageddon will occur at the very end of Daniel’s 70th week.

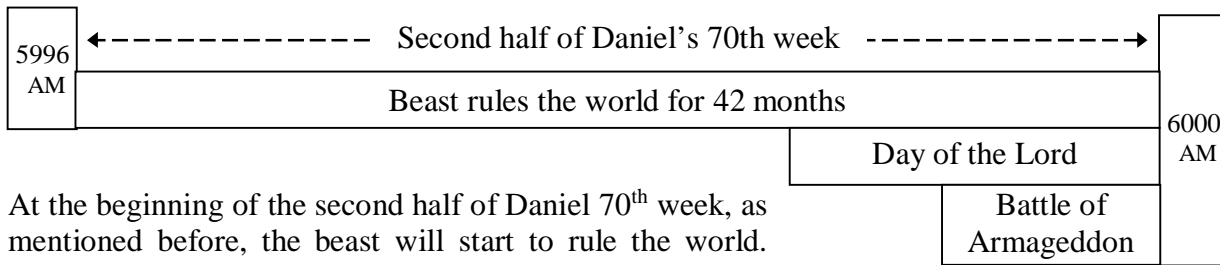

At the beginning of the second half of Daniel 70th week, as mentioned before, the beast will start to rule the world. Here is his the first major outcome of this domination.

- Matt 24:9 "Then you will be handed over to be persecuted and put to death, and you will be hated by all nations because of me. NIV
- Rev 13:7-8 He was given power to make war against the saints and to conquer them. And he was given authority over every tribe, people, language and nation. NIV

Understand here that only a specific group of people will be persecuted¹⁶⁸, put to death, and hated by the whole world. The bible refer to this event as the **Great tribulation**.

- Matt 24:21 For then shall be great **tribulation**, such as was not since the beginning of the world to this time, no, nor ever shall be. KJV
- Matt 24:10-12 At that time many will turn away from the faith and will betray and hate each other, and many false prophets will appear and deceive many people.

Notice also that this persecution will be cut short

The next chart shows that the Great tribulation doesn't occupy the whole 3.5 years of the second half of the 70th week. If it was the case it would contradict Matt 24:22 who says that the tribulation was cut short.

- Matt 24:22 If those days had not been cut short, no one would survive, but for the sake of the elect those days will be shortened. NIV

And what more logical way to cut short the tribulation than having the 'day of the Lord' start immediately after?

- Rev 8:1-2 When he opened the seventh seal, ... And I saw the seven angels who stand before God, and to them were given seven trumpets. NIV

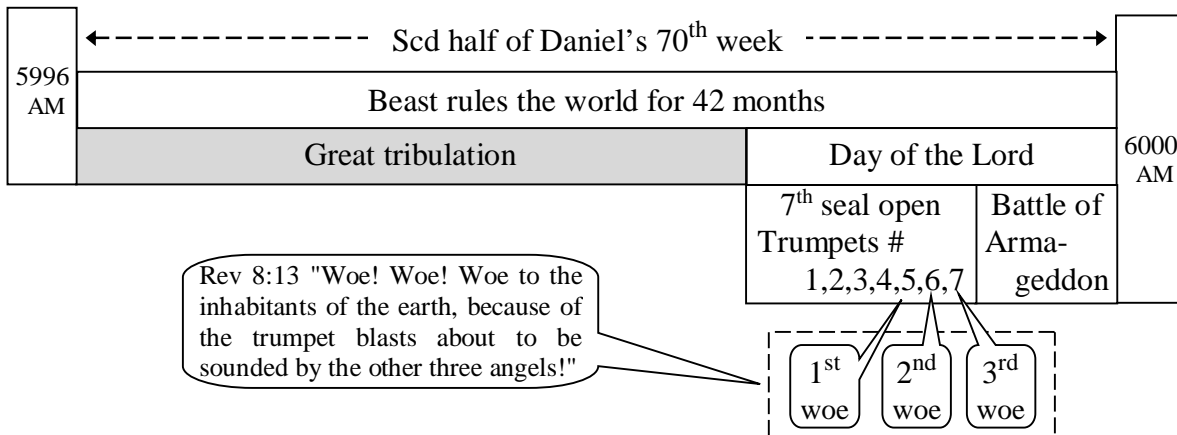

¹⁶⁸ As opposed to the first period (the birth pain) when no individual would be specifically targeted. Wars and rumor of war affect people indiscriminately.

Who will be the persecuted people of the Great Tribulation? Notice that Matt 24:9-14 was given as a private answer to the disciples and it was done in a way that could have made them expect the worse for their own life in the coming years. We know now that the first century's disciples didn't have to endure any apocalyptic tribulation. Why then, did Yeshua intimate that they would?

Could it be that Yeshua's words were pointing at his own disciples because, by formulating them that way, He knew that centuries later the right group of people would understand that the words were for them? It seems to be the proper way to analyze the facts and therefore we should find out who was truly addressed in Yeshua's answer by responding to this simple question. What is the main characteristic one needs to have to be a true 'disciple' of Yeshua? Isn't it to believe the words given by Yeshua and become faithful to Him?

Therefore one can say that by extension the group of people who will be persecuted in Yeshua's answer will be those who believe in him during the second part of the 70th week of Daniel. Don't make the mistake to identify the victims of this tribulation with the Jews. The Jews don't and won't believe in Yeshua until his second coming. And don't think either that the Antichrist, the ruler of the end time, will persecute the multitude who 'will accept' his message. On the contrary those who will submit to the beast will receive a mark and will be under his protection.

- Rev 13:16-17 He also forced everyone, small and great, rich and poor, free and slave, to receive a mark on his right hand or on his forehead, so that no one could buy or sell unless he had the mark, which is the name of the beast or the number of his name. NIV

Thus, the victims of the great tribulation will be the Christians who will refuse to worship the beast. (those who will remain faithful to Yeshua).

- Rev 13:7-8 He [*the beast*] was given power to make war **against the saints** and to conquer them. And he was given authority over every tribe, people, language and nation. All inhabitants of the earth will worship the beast—all whose names have not been written in the book of life belonging to the Lamb NIV

In the previous chart the Tribulation is followed by the Day of the Lord. Now if 'the days of the tribulation' are cut short **to prevent the dramatic consequence of an ongoing persecution** and if the Day of the Lord's purpose is to punish everybody alive at the time then there must be something between these two periods that will protect the elects from having to suffer twice. If it was not the case, the following would be highly misleading

- Matt 24:13 but he who stands firm to the end will be saved. NIV
- Matt 24:31 1 And he will send his angels with a loud trumpet call, and they will gather his elect from the four winds, from one end of the heavens to the other. NIV

When Yeshua will return at the beginning of the 'Day of the Lord', his first action¹⁶⁹ will be to **'rapture'** those alive (i.e. the Christians who won't wear the mark of the beast) and those who died for his name.

¹⁶⁹ 2 Thess 2:1 1 Concerning the coming of our Lord Jesus Christ and our being gathered to him, NIV

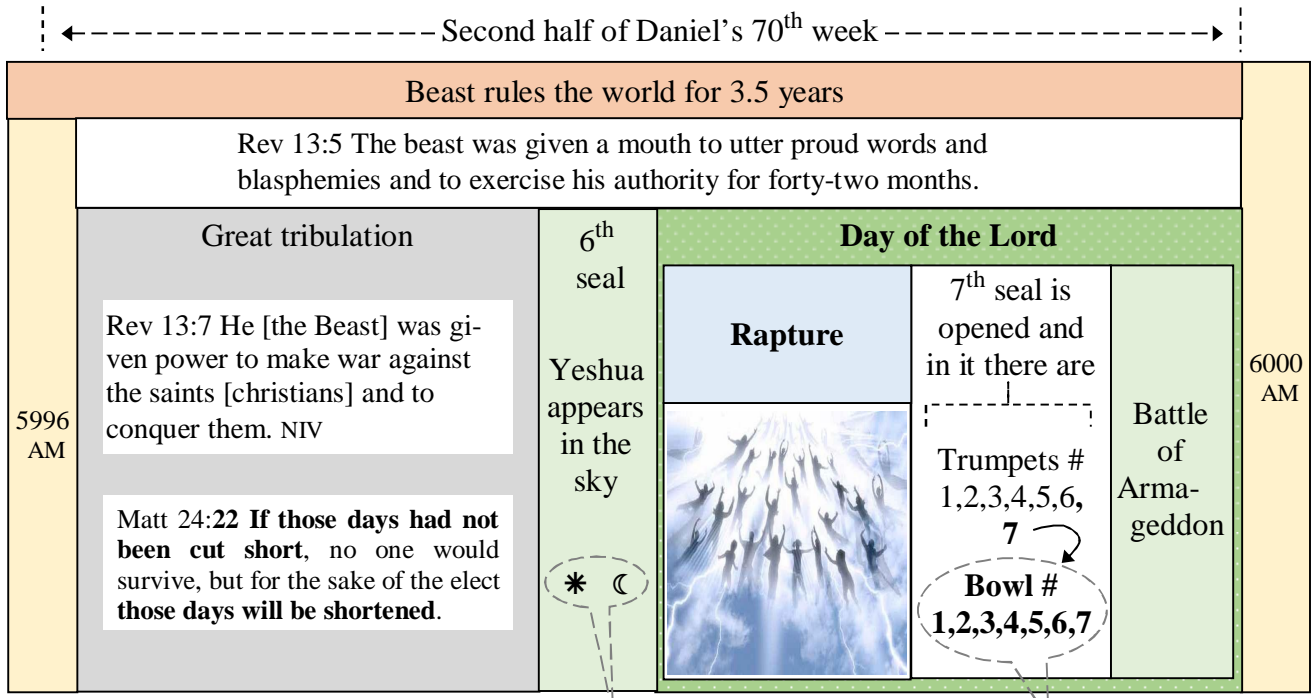

-Joel 2:31 The sun * will be turned to darkness and the moon ☾ to blood before the coming of the great and dreadful day of the LORD.

-Acts 2:20 the sun * will be turned to darkness and the moon ☾ to blood before the coming of the great and glorious day of the Lord.

-Matt 24:29-30 "Immediately after the distress of those days "the sun * will be darkened, and the moon ☾ will not give its light; the stars will fall from the sky, and the heavenly bodies will be shaken.' "At that time the sign of the Son of Man will appear in the sky

-Rev 6:12 I watched as he opened the sixth seal. There was a great earthquake. The sun * turned black like sackcloth made of goat hair, the whole moon ☾ turned blood red

Rev 15:1 seven angels with the seven last plagues- last, because with them God's wrath is completed. NIV

Rev 16:1 saying to the seven angels, "Go, pour out the seven bowls of God's wrath on the earth." NIV

Although it was cut short, we can assume that the Great tribulation will last longer than the other events of the 2nd half of Daniel 70th week. That being said we shouldn't limit the duration of the Day of the Lord to a single 24 hours day. The 5th trumpet alone will last 5 month.

- Rev 9:1,10 he fifth angel sounded his trumpet ... They had tails and stings like scorpions, and in their tails they had power to torment people for **five months**.

The two witnesses

The two witnesses are two prophets that will come to Jerusalem during the end time.

- Rev 11:3 and I will give power to my two witnesses, and they will prophesy for 1,260 days, clothed in sackcloth." NIV

I won't add to the speculation about the identity of these two men, finding the timing of their arrival is much more interesting. I don't think they will be present during the second half of Daniel 70 weeks and here are three raisons why.

A. They will be extremely powerful and nobody will be able to harm them

- Rev 11:5 If anyone tries to harm them, fire comes from their mouths and devours their enemies. This is how anyone who wants to harm them must die. NIV

But the same has been told about the beast who is going to reign in the second half of Daniel's 70 weeks.

- Rev 13:7 and he was given authority over every tribe, people, language and nation.

How could the Beast dominate the whole world and not be able to prevent the two witnesses' ministry?

B. The two witnesses will be able to spit fire and prevent rain from the sky

- Rev 11:5-6 fire comes from their mouths and devours their enemies. This is how anyone who wants to harm them must die. 6 These men have power to shut up the sky so that it will not rain during the time they are prophesying NIV

The beast will be backed by two other entities. One will spew water from his mouth and the other will have fire coming from the sky (*interesting: reversal of action VS the two witnesses*)

The dragon whose mouth had spewed water like a river

- Rev 12:15 Then from his mouth the serpent spewed water like a river, to overtake the woman and sweep her away with the torrent. NIV

A second beast who exercises authority on behalf of the first beast (rev 13:12) like having fire come down from heaven.

- Rev 13:13-14 even causing fire to come down from heaven to earth in full view of men. 14 Because of the signs he was given power to do on behalf of the first beast, he deceived the inhabitants of the earth. NIV

We can imagine how counterproductive it would be to have the two witnesses, two beasts & dragon operate during the same period. Nobody would know who is responsible for what.

C. At the death of the 2 witnesses the whole world will celebrate for 3 and a half days.

- Rev 11:9-10 For three and a half days men from every people, tribe, language and nation will gaze on their bodies and refuse them burial. The inhabitants of the earth will gloat over them and will celebrate

Impossible to imagine that such a worldwide celebration could occur at the very same time of the wrap of God.

Truly, the time of the two witnesses cannot overlap the second half of Daniel 70th week.

Now let's suppose the beast first act, when he emerges in the middle of Daniel 70th week, was to get rid of the two witnesses. Wouldn't he receive every body's esteem for having killed the two who had afflicted them with all kinds of plagues (Rev 11:6) during the previous 3.5 years? I can imagine the whole world proudly acclaiming him (the beast) while he enters the Temple pretending that he is 'god' and that he had just get rid of the beast & the false prophet mentioned in the Bible. *Unfortunately for us this master deception will occur, see Matt 24:15.*

Can we pinpoint the time of the rapture?

We have to be cautious here, trying to predict the timing of a future biblical event is dangerous. No matter how prudent one can be, there is no guaranty that all the biblical facts are known when the prediction is formulated.

I have two propositions for the timing of the Rapture. The extraordinary thing is that they are only 9 days apart.

— Feast of Trumpets on Tishri 1, 5998 AM

In their book 'The Last Shofar', Joseph Lenard & Donald Zoller develops the possibility that the rapture will happen on the Feast of Trumpets.

- 1 Cor 15:52 in a flash, in the twinkling of an eye, at the last trumpet. For the trumpet will sound, the dead will be raised im perishable, and we will be changed.

The 'last trumpet' mentioned here is not related to the 7 trumpets that will be sounded by the seven angels. In ancient Israel, many trumpets were blasted during the Feast of Trumpets 'Rosh Hashanah' (*Jewish civil new year*) and the last one was known as the 'last trumpet'.

– Start of the jubilee year on Tishri 10, 5998 AM (I would rather go with this one)

If you refer to my table on page 151 you will notice that the 70th Jubilee will start on the 10th day of the 7th month of the year 5998 AM. Why would the Jubilee fell so short of year 2000 AM, it seems somehow incomplete. But then, if the announce of this very last Jubilee was the signal for the Rapture it would make perfect sense to have this timing.

- 1 Cor 15:52 in a flash, in the twinkling of an eye, at the last trumpet. For the trumpet will sound, the dead will be raised im perishable, and we will be changed.

No other event in the history could match with the freedom that the Rapture will bring. On the same day people will be rescue from torture, persecution, slavery and from death itself. Could there be a more meaningfull Jubilee then that?

Here are the terms of a Jubilee

Lev 25:9-10 Then **have the trumpet sounded** everywhere on the tenth day of the seventh month; on the Day of Atonement sound the trumpet throughout your land. Consecrate the fiftieth year and **proclaim liberty throughout the land** to all its inhabitants. It shall be a jubilee for you; NIV

Lev 25:13 "In this Year of Jubilee **everyone is to return** to his own property. NIV
Lev 25:54-55 "Even if he is not redeemed in any of these ways, **he and his children are to be released** in the Year of Jubilee, 55 for **the Israelites belong to me as servants**. They are my servants, whom I brought out of Egypt. I am the LORD your God. NIV

What could be more fitting to match with Yeshua's first coming ministry starting in a Jubilee day, than to have Yeshua's second coming first action, the rapture, happening on the very day of the last Jubilee?

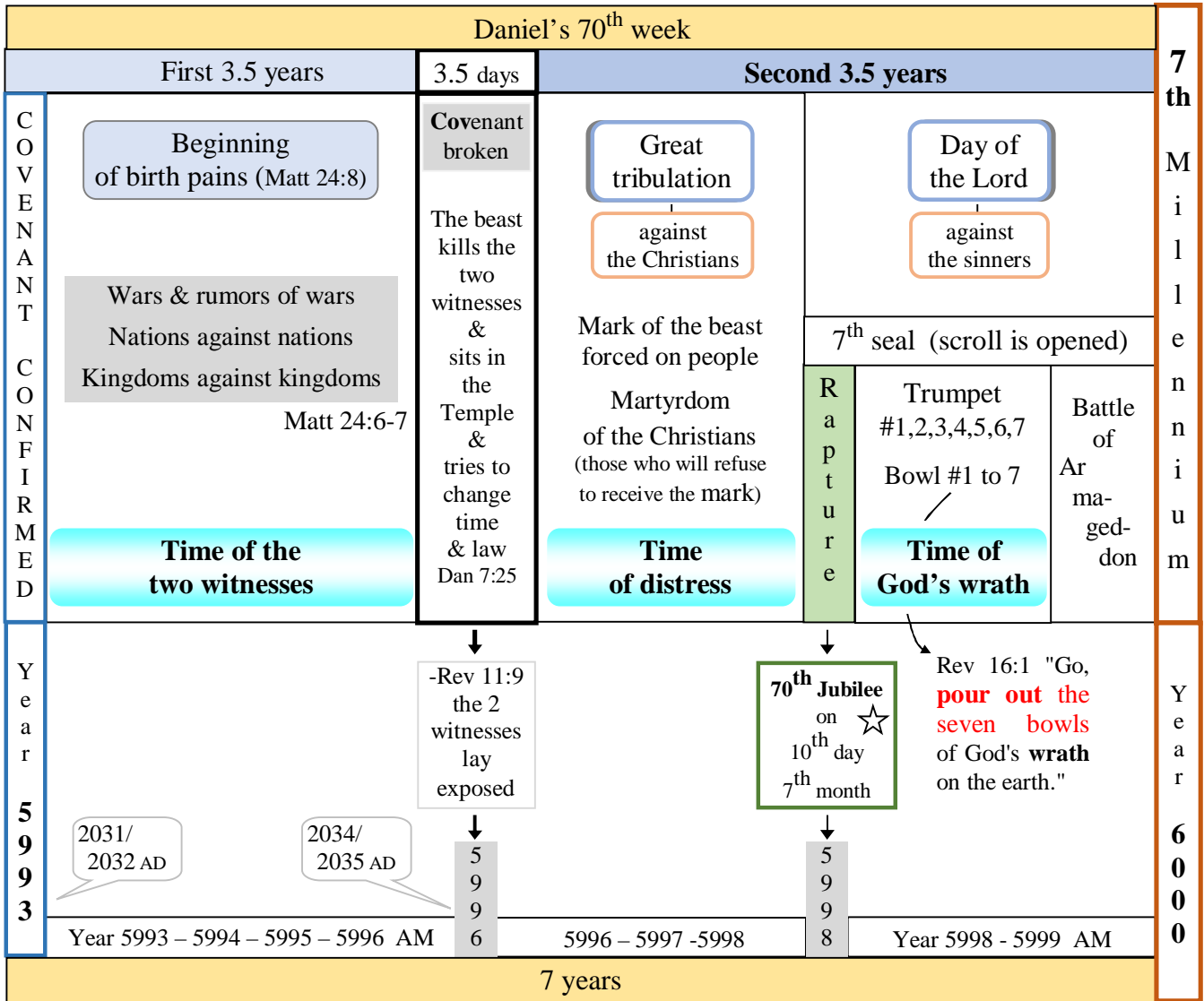

- About the Rapture -

Dan 12:1 There will be a **time of distress** such as has not happened from the beginning of nations until then. But at that time **your people ... will be delivered.**

Matt 24:31 And he will send his angels with a loud trumpet call, and they will gather his elect from the four winds, from one end of the heavens to the other.

1 Thess 4:16-17 For the Lord himself will come down from heaven, with a loud command, with the voice of the archangel **and with the trumpet call of God**, and the dead in Christ will rise first.

Rapture on the Jubilee day 
 1 Cor 15:52 in a flash, in the twinkling of an eye, at the last trumpet. For the trumpet will sound, the dead will be raised imperishable, and we will be changed.



Note: The 'last trumpet' mentioned here is not related to the 7 trumpets that will be sounded by the seven angels. In ancient Israel, on the day of the Jubilee (which occurs every 49 years on the day of Yom Kippur) a trumpet was blasted throughout the land

To the readers: The notions of Pre-Wrath (Tribulation → Rapture → Day of the Lord) is better explained by ALAN E. KURSCHNER in his very good book Antichrist Before the Day of the Lord: What Every Christian Needs to Know about the Return of Christ

Appendix J
The Kings

Access

2923 AM	K. Saul	
2963 AM	K. David	K. Ish-Bosheth
3000 AM	K. Solomon	

Non
Access

N. K.
10 dynasties
(5+5)

Access	SK1	K. Rehoboam 17	3063	3063	Non Access	NK1	K. Jeroboam 22	D1	
	SK2	K. Abijah 3	3080						D2
	SK3	K. Asa 41	3082						
				3084			NK2	K. Nadab 2	D3
				3085			NK3	K. Baasha 24	D4
				3108			NK4	K. Elah 2	
						3109	NK5	K. Zimri 7d	D5
							NK6	K. Tibni 5	
						3120	NK7	K. Omri 12	D5
							NK8	K. Ahab 22	
	SK4	K. Jehoshaphat 25	3123			NK9	K. Ahaziah 2	D5	
						NK10	K. Joram 12		
	SK5	K. Jehoram 8	3145						
	SK6	K. Ahaziah 1	3151						
Access									
	SK7	Q. Athaliah 6	3152	3152		NK11	K. Jehu 28	D6	
	SK8	K. Joash 40 (counting from 3152)	3159			NK12	K. Jehoahaz 17		
				3175		NK13	K. Jehoash 16		
	SK9	K. Amaziah 29	3191					D7	
				3206		NK14	K. Jeroboam II 41		
	SK10	K. Uzzia 52	3233					D8	
				3271		NK15	K. Zecharia 6m		
				3272		NK16	K. Shallum 1m	D8	
				3283		NK17	K. Menahem 10		
	SK11	K. Jotham 16	3285	3285		NK18	K. Pekahiah 2	D9	
	SK12	K. Ahaz 16	3302						
				3314		NK20	K. Hoshea 9	D10	
	SK13	K. Hezekiah 39	3317						
	SK14	K. Manasseh 55	3333						
	SK15	K. Amon 2	3388						
	SK16	K. Josiah 31	3390						
	SK17	K. Jehoahaz 3m	3421						
	SK18	K. Jehoiakim 11							
	SK19	K. Jehoiachin 3m	3432						
	SK20	K. Zedekiah 11							

NOTE: This table give the the first year of each southern (SK) and northern (NK) kings of Israel. It also indicates which king was using the ‘accession’ or ‘non-accession’ year dating.
Ex: In the access mode 3063 + 17 = 3080
In non-access mode 3063 + 22 = 3084
See my book: **The 44 Hebrew monarchs**
(A Chronology of two kingdoms)

Appendix K 77 People of authority (11 + 22 + 44)

11 Judges		22 Patriarchs		44 Monarchs			
1 Othniel	2601	1 Adam	0 AM	Over Israel		Over Judah	
2 Ehud	2659	2 Seth	130	1 Saul	2923	1 David	2963
3 Deborah	2697	3 Enosh	235	2 Ish-Bosheth	2963	2 Solomon	3000
4 Gideon	2756	4 Kenan	325	3 Jeroboam	3063	3 Rehoboam	3063
5 Tola	2799	5 Mahalalel	395	4 Nadab	3084	4 Abijah	3080
6 Jair	2822	6 Jared	460	5 Baasha	3085	5 Asa	3082
7 Jephthah	2862	7 Enoch	622	6 Elah	3108	6 Jehoshaphat	3123
8 Ibzan	2868	8 Methuselah	687	7 Zimri	3109	7 Jehoram	3145
9 Elon	2875	9 Lamech	874	8 Tibni	3109	8 Ahaziah	3151
10 Abdon	2885	10 Noah	1056	9 Omri	3109	9 Athaliah	3152
11 Samuel	2895	11 Shem	1558	10 Ahab	3120	10 Joash	3159
		-- FLOOD --	1656	11 Ahaziah	3140	11 Amaziah	3191
		1 Arphaxad	1658	12 Joram	3141	12 Uzzia	3233
		2 Shelah	1693	13 Jehu	3152	13 Jotham	3285
		3 Eber	1723	14 Jehoahaz	3175	14 Ahaz	3302
		4 Peleg	1757	15 Jehoash	3189	15 Hezekiah	3317
		5 Reu	1787	16 Jeroboam	3206	16 Manasseh	3333
		6 Serug	1819	17 Zecharia	3271	17 Amon	3388
		7 Nahor	1849	18 Shallum	3272	18 Josiah	3390
		8 Terah	1878	19 Menahem	3272	19 Jehoahaz	3421
		9 Abraham	2008	20 Pekahiah	3283	20 Jehoiakim	3421
		10 Isaac	2108	21 Pekah	3285	21 Jehoiachin	3432
		11 Jacob	2168	22 Hoshea	3314	22 Zedekiah	3432

NOTE :

See judges chronology on page 172

See patriarchs chronology in Appendix A on page 229

See kings chronology in my paper

“The 44 Hebrew Monarchs”

Appendix L The 12 Symbolical acts found in Ezekiel 4-5

LYING ON LEFT SIDE (390 days) = 390 years		E Z E K I E L T U R N O V E R	LYING ON RIGHT SIDE (40 days) = 40 years	
Ezekiel prophesies 390 days	L1 Moses' escape from Egypt (2483 AM) → Ark captured (2873 AM)		Ezekiel prophesies 40 days	R1 Jeremiah starts prophesying (3403 AM) → Temple destruction (3443 AM)
Ezekiel bears Israel's sins 390 days	L2 Gibeah's sin (2583 AM) → Ark brought in Jerusalem -2973		Ezekiel bears Judah's sins 40 days	R2 Manasseh's Abomination (3368 AM) → Josiah's Passover (3408 AM)
Ezekiel eats defiled food 390 days	L3 Foundation of Samaria (3113 AM) → Return of the 42,360 exiles -3503		Ezekiel fasts 40 days	R3 Judah returns from Exile-3503 AM → Nehemiah completes the wall-3543
Combined SIDES 390 + 40 days) = 430 years		(The following symbolical acts were not interrupted when Ezekiel turn over)		
Ezekiel lies bare arm for 430 days	Exodus 2523 AM) →	C1	Samuel's death 2953 AM	
Ezekiel shaves his hair 430 days	Ark captured 2873 AM →	C2	Isaiah's foretelling 3303 AM	
Ezekiel holds a siege for 430 days	Ark brought in the first Temple 3013 AM →	C3	Destruction of Jerusalem 3443 AM	
Ezekiel weighs and divides his hair 430 days	Kingdom's split 3063 →	C4	Fall of Babylon 3493 AM	
Ezekiel hair growing for 430 days	Construction of 2 nd Temple 3513 AM →	C5	Herod repairs the Temple 3943 AM	
Ezekiel is mute for 430 days	First Purim 3559 AM →	C6	Start of Yeshua's ministry 3989 AM	

Copyright©2015 by Yves Peloquin
ALL RIGHTS RESERVED

No part of this publication may be used for commercial purposes. The readers are allowed to save, print or send this PDF to whoever they want as far as they don't alter its content.