

**ROSS**  
1879 VALVE

# PUMP CONTROL VALVES

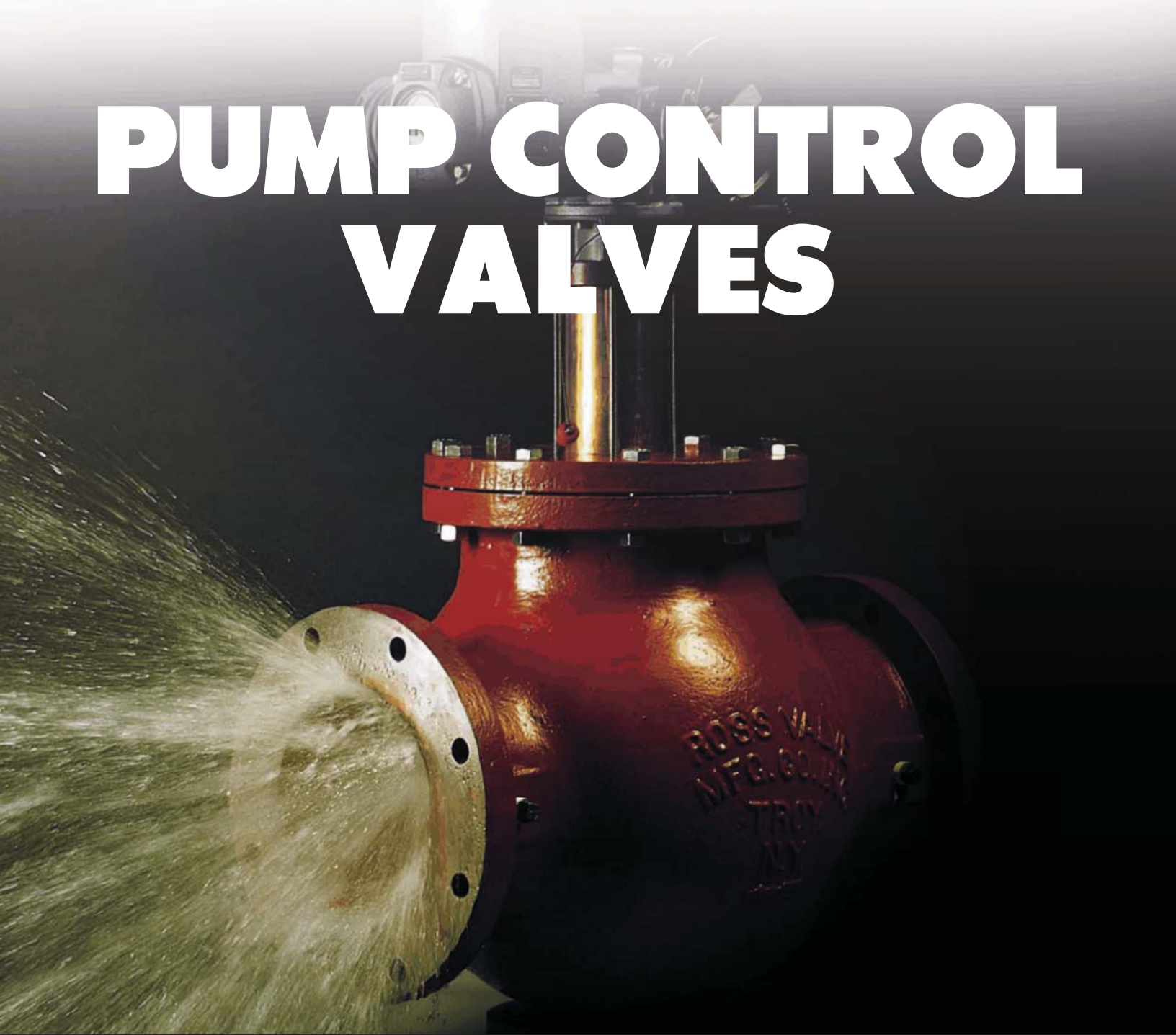

**MODEL ECV  
ELECTRONIC CHECK VALVE  
MINIMIZES PUMP START/STOP SURGES  
PREVENTS BACK FLOW**

# Reliable control where it's needed most.

For pump control applications, you need a solution that's reliable, predictable and won't leave your system open to compromise. Our experience since 1879 has shown us again and again that the most effective approach to managing pump activity is to start and stop a pump against a closed valve, to stop surges before they can start.

The Ross Model ECV pump control valve for water and wastewater achieves this by combining the features of an electrically controlled valve with those of a check valve. The electric controls allow the valve to be precisely synchronized with the pump operation, ensuring smooth pump starting and stopping procedures. The 2-piece piston, with a free-floating lower portion, prevents reverse flow in the event of a power outage or pump failure.

Combined with our rugged piston style design, these features allow the Model ECV to perform several key functions:

- Coordinates with the pump to bring water or other fluid online slowly, in a controlled manner
- Opens fully to minimize headloss and promote efficient pumping operation
- Closes in a controlled manner to avoid surges and water hammer
- Closes quickly in an emergency, to prevent reverse flow that can damage the pump
- Provides adjustments (opening and closing speeds) and system status feedback (via optional control panel) to optimize performance

The Ross ECV is the pro-active approach to take the stress off your system and stop surges before they start.

If you still have concerns about pump surges, demand some additional surge insurance with a Ross relief or surge anticipator valve (Model 70SWR or 70SWR-E). These surge valves are the reactive approach to the Ross ECV pump control valve. Used together, they can provide the ultimate in water and wastewater pump control packages.

Buy American



All Ross Valves are  
100% ARRA Compliant



## Potential Installations

- Raw water & greywater pump stations
- Wastewater & sewage pump stations
- Potable water pump stations
- Cooling, mixing & recirculating systems
- High pressure/performance irrigation systems
- Slurry, mining and pulp applications

# CONSTRUCTION

## THE ROSS ECV ELECTRONIC CHECK VALVE

Designed for the ultimate in pump control performance.

### SIZES

2" – 48" (50mm – 1200mm).

### DESIGN

Based off our proven piston design, and modified for use with most fluids, the Ross ECV valve is designed for accuracy, performance, and long life.

### KEY FEATURES

- 1 Valve actuator and pump are interlocked, assuring a safe, smooth and efficient operation.
- 2 Stainless steel wetted parts resist wear.
- 3 Two-piece stem prevents back flow, ensures closure on power failure.
- 4 Heavy-duty shafts, multiple bearings and dual o-ring seals provide true alignment.
- 5 Angle (90°) and globe (inline) style bodies available (*epoxy-coated cast iron*).

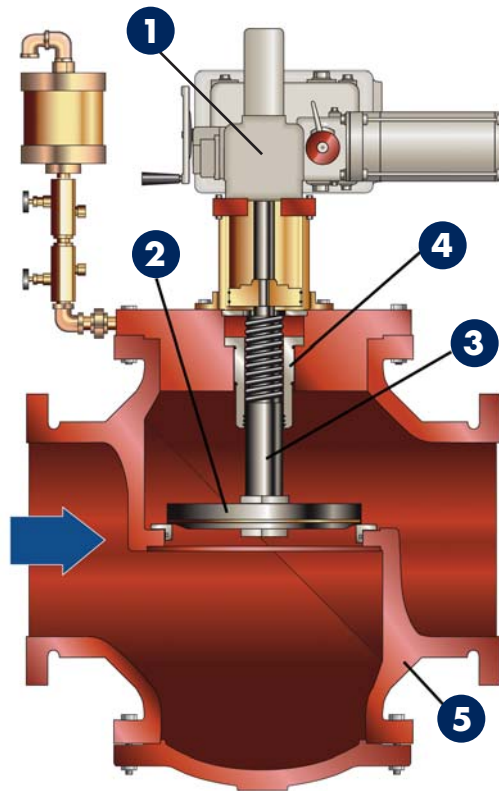

Model ECV Pump Control Valve  
(Globe Body Shown)

### ADDITIONAL FEATURES & BENEFITS

- Throttling and non-throttling designs available.
- Independent adjustable speed controls for both opening and closing speeds.
- Rugged piston style construction provides dependable operation and peace of mind.
- Horizontal or vertical valve and/or shaft mounting.
- Every internal part is replaceable through the top cap, without removing the valve from the line.
- All engineering, manufacturing, and testing done in-house.
- Reliability that you've come to expect from Ross Valve.

## CONTROL PANEL INFORMATION

**Ross Valve offers a variety of pump control panel solutions to precisely coordinate the operation of your Ross Model ECV valve with the pump.**

Our control panels are built on-site in our own panel shop, and offer the following advantages:

- Pre-programmed for each job, based on the valve specifications and pump operating parameters
- Pre-wired to eliminate field wiring errors
- 100% factory tested
- NEMA 4X fiberglass enclosure
- Can be mounted directly onto the valve before shipment



Our base model control panel is a mechanical relay style control panel that offers all the features listed above in an economical package. High-visibility indicator lights signal whether pump and valve are running correctly, or if there is a malfunction.

The Ross Model MC2001 is a PLC-based control panel that provides exceptional accuracy in a highly versatile modular design. It features a message display center that displays system status and alarms, and also serves as the user interface for operator fine-tuning and security verification. Other capabilities include a back-up memory module, battery backup system, adjustable pulse feature, throttling option, and additional alarms and relay contacts.

Let us design a panel that meets your unique requirements and provides a seamless interface between your pump and your Ross Valve.



# HEADLOSS GUIDE

## MODEL ECV

### INSTRUCTIONS

- 1 Locate the desired headloss along the vertical axis, for the appropriate type valve.
- 2 Follow the line horizontally until the desired flow is reached (according to the horizontal axis).
- 3 Follow the line vertically down to the nearest angled line to determine the appropriate valve size.

### ANGLE STYLE

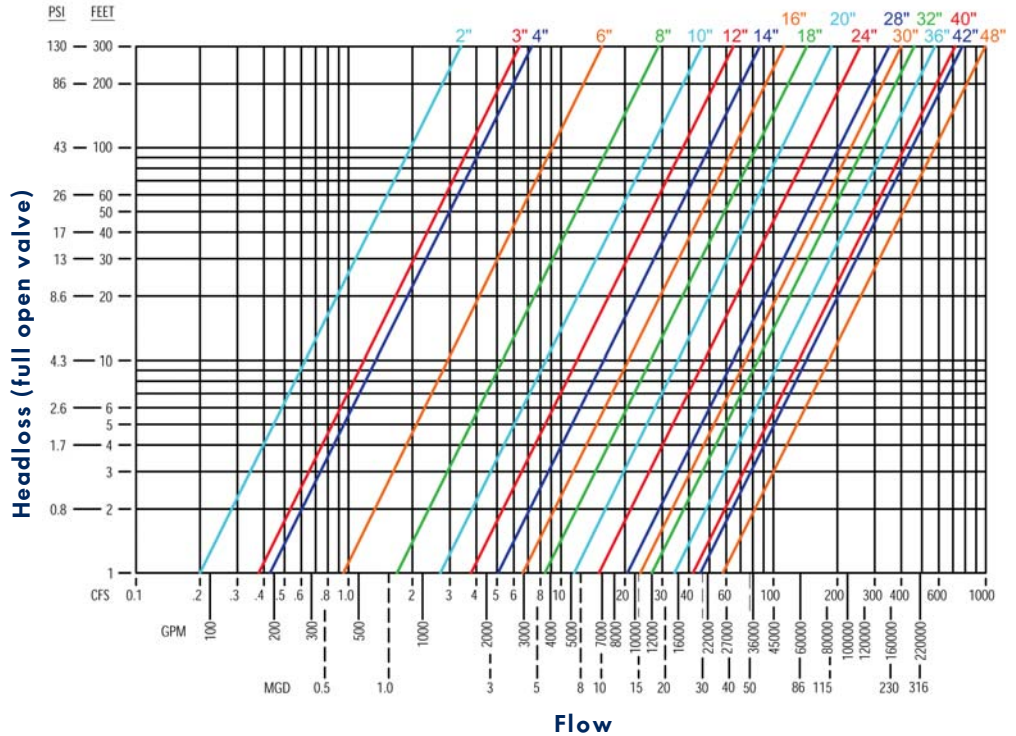
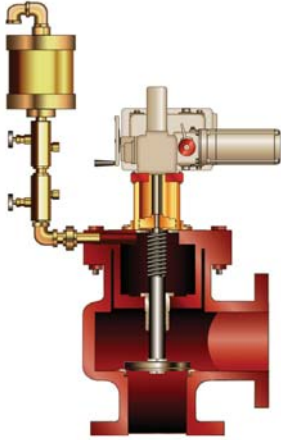

### GLOBE STYLE

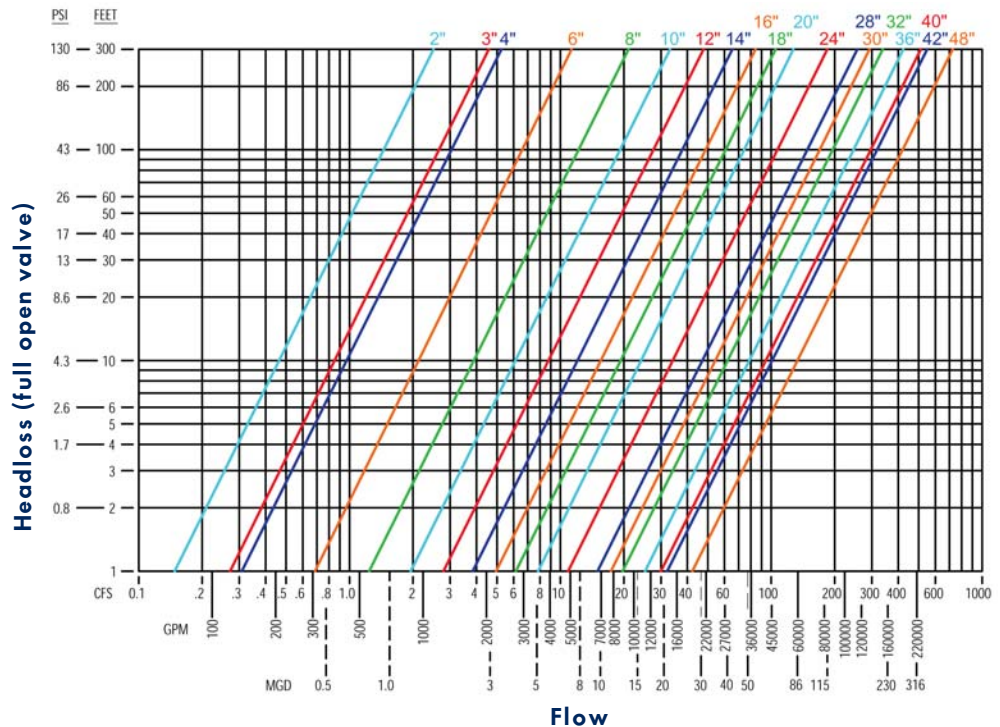
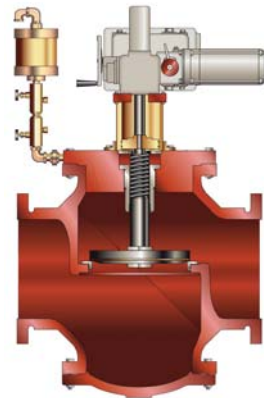

Note: Renderings shown are for reference only and are subject to change at any time. Engineering drawings are provided during the submittal process.

# DIMENSIONS AND WEIGHTS

## MODEL ECV

### ANGLE STYLE (all dimensions in inches)

Valve Size	A		B		C&D	E		F		G*	H	Ship Weight (lbs)	
	125 ANSI	250 ANSI	125 ANSI	250 ANSI		125 ANSI	250 ANSI	125 ANSI	250 ANSI			125 ANSI	250 ANSI
	4"	7.5	7.8125	9		10	4.75	8	8.125			6.25	6.5625
6"	8.625	9.0625	11	12.5	6.625	9.5625	10.125	8	8.4375	30-35	18	360	420
8"	10.5	11	13.5	15	8.75	12.875	13	10	10.5	30-35	20	650	700
10"	12.5	13.125	16	17.5	10	14	14	11.5	12.125	30-35	20	800	895
12"	15	15.5	19	20.5	12	17.25	17.25	12.625	13.125	30-35	24	1,260	1,370
14"	17	17.75	21	23	14	19.25	19.25	14.875	15.625	30-35	24	1,700	1,830
16"	19	19.75	23.5	25.5	15	21	21	16.5	17.25	30-35	24	2,180	2,420
18"	21.25	22.125	25	28	18	23.5	23.5	16.75	17.5625	30-35	36	3,050	3,350
20"	21.25	22.125	27.5	30.5	18	23.5	23.5	18.875	19.6875	30-35	36	3,330	3,630
24"	24.25	25.125	32	36	24	25.75	25.75	20.25	21.125	30-35	36	4,700	5,200
30"	31.875	32.875	38.75	43	26.25	37	37	27	28	30-35	40	9,800	10,800
36"	31.875	32.875	46	50	26.25	37	37	27	28	30-35	40	11,800	12,800

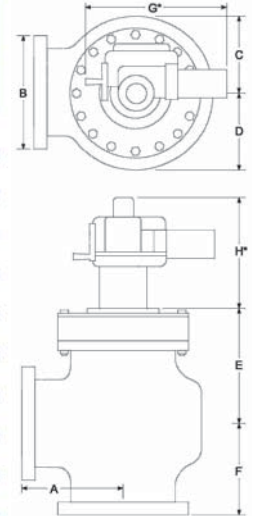

### GLOBE STYLE (all dimensions in inches)

Valve Size	A		B		C&D	E		F		G*	H	Ship Weight (lbs)	
	125 ANSI	250 ANSI	125 ANSI	250 ANSI		125 ANSI	250 ANSI	125 ANSI	250 ANSI			125 ANSI	250 ANSI
	4"	14	14.375	9		10	4.75	7	7			7	7
6"	17.75	17.75	11	12.5	6.625	9	9	9	9	30-35	18	375	430
8"	24	24.8125	13.5	15	8.75	12.5	12.5	12.5	12.5	30-35	20	690	750
10"	24.875	24.25	16	17.5	10	14.25	14.25	14.25	14.25	30-35	20	920	1,000
12"	30	31.5	19	20.5	12	15.5	15.5	15.5	15.5	30-35	24	1,375	1,475
14"	34.125	35.75	21	23	14	18	18	18	18	30-35	24	1,770	1,850
16"	37.875	39.25	23.5	25.5	15	21.5	21.5	21.5	21.5	30-35	24	2,400	2,600
18"	41.875	41.875	25	28	18.375	24	24	24	24	30-35	36	3,300	3,500
20"	42.375	42.375	27.5	30.5	18.375	24	24	24	24	30-35	36	3,550	3,800
24"	47	47	32	36	20	25	25	25	25	30-35	36	5,200	5,500
30"	63.75	65.5	38.75	43	26.25	34	34	34	34	30-35	40	9,800	10,800
36"	65	65	46	50	26.25	34	34	34	34	30-35	40	11,800	12,800
42"	82	82	53	53	35	38.25	38.25	40	40	30-35	40	16,300	17,400
48"	88	88	59.5	65	39.125	44	44	43.25	43.25	30-35	40	21,000	22,500

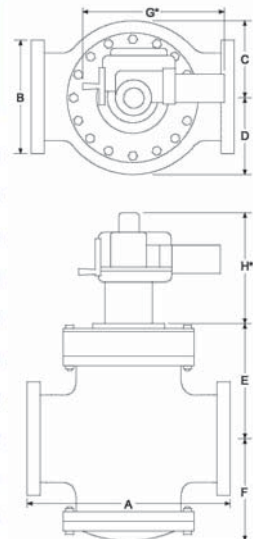

\* Various actuator styles and sizes available. Consult factory for details.



# Ross Valves last longer.

When George Ross founded our company in 1879, he made a product designed to last. He also created a company built on enduring values: integrity of design and engineering, quality of materials, craftsmanship in manufacturing, a high level of customer service, and flexible business systems that have evolved with technology and the times.

Now, much more than a century later, Ross automatic control valves are legendary throughout the world. Over the years, they have played a pivotal part in construction projects both large and small, serving systems as diverse in size and operating conditions as New York City, Los Angeles, Madrid, and Dubai.

Ross offers a complete line of standard valves including pump control, pressure reducing, flow control, altitude, back pressure sustaining, relief, surge control, electronic control valves, and float valves, as well as a complete line of strainers and diaphragm-style valves. Complementing these product lines are high energy dissipation anti-cavitation valves – our “WaterTamer.” Rounding out our product line is a full line of valves for wastewater. Of course, we also have a variety of customized valves and valve features that can be engineered to suit any application, as well as pre-packaged valve vaults for turn-key installation.

Accurate. Ruggedly constructed. Versatile. Reliable. And backed by dedicated technical support and uncompromised field service. No wonder customers around the world always seem to say:

There's nothing like a Ross Valve.



Ross Valve Mfg. Co., Inc.  
P.O. Box 595, Troy, NY 12181-0595, USA  
Tel: 518-274-0961 • Fax: 518-274-0210  
Email: sales@rossvalve.com • www.rossvalve.com



All Ross Valves meet or exceed all current AWWA standards for construction and pressure ratings. ECV 06-10 5000



Ross Valves are known for their exceptional quality. And no wonder, because we control the process in-house from start to finish. After designing the components, molds are made. We then start with the finest raw materials. All metals are poured in our own New York based foundries. All parts are machined to specs. Then each valve is meticulously assembled, pilot valves and controls are set, and the valve is “wet” tested under the designed operating conditions. When you receive your new Ross Valve, you can count on its ability to perform from start to finish.

Buy American



All Ross Valves are 100% ARRA Compliant