

Illustrated Parts Catalog

# ROOTLIEB, INC.

Vintage Auto Sheetmetal  
[www.rootlieb.com](http://www.rootlieb.com)

## Manufacturers and Distributors

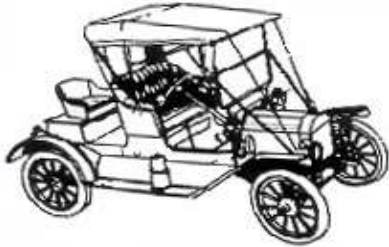

**Vintage Ford**  
**Hoods**  
**Bodies**  
**Fenders**  
**Accessories**  
**Splash Aprons**  
**Speedster Kits**  
**Running Boards\***

\*select items

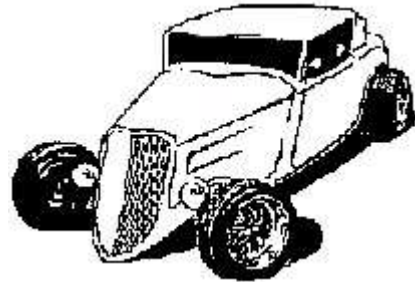

**Street Rod Hoods**  
**Ford**  
**Dodge**  
**Plymouth**  
**Chevrolet**  
**4 Piece Hoods**  
**3 Piece Hoods**

We Gladly Accept



**Prices effective April 1st 2022**

**Mailing Address**  
**Rootlieb, Inc.**  
**P.O. Box 1810**  
**Turlock, CA 95381**  
**Phone - (209) 632-2203**

**Shipping Address**  
**Rootlieb, Inc.**  
**815 S. Soderquist**  
**Turlock, CA 95380**  
**Fax - (209) 632-2201**



## **Sales Policy**

All merchandise is sold without warranty, either expressed or implied. However, satisfaction is guaranteed on all parts. We will gladly exchange merchandise that is in perfect condition within 30 days with copy of receipt and prior authorization. Merchandise is non-returnable after 60 days from date of purchase. A restocking charge will apply on all returned items.

Restocking is based on purchases in the amounts of **\$0.00 - \$200.00** is **25%** of the sale plus the cost of shipping. **\$201.00 or greater** is subject to a **\$55.00** charge plus the cost of shipping.

No COD orders are accepted. California residents, please add sales tax.

### **Check Fit First**

**Please recheck your sizes and part numbers before ordering. We do not accept and are not responsible for the manner in which any of the products listed in our catalog are used. Merchandise that is rusted or has been drilled, cut, ground on, or altered in any manner will not be accepted for exchange. Under no circumstance will we accept primed, painted, chemically treated or media blasted (shell, plastic, sand, etc.) merchandise for exchange.**

Returned merchandise must be packed carefully, as you will be responsible for any damage due to inadequate packing. Replacement will be subject to freight claim settlement.

### **Fine Quality**

The merchandise shown on these pages is the finest quality made. We have thousands of satisfied customers in the country and abroad. Our merchandise is displayed at car shows and in museums throughout the world. All of the stock parts are duplicates of the originals. Careful attention is given to all details. All parts are of the same gauge metal as the originals.

Parts are shipped in boxes or crates to avoid damage.

If you have any questions concerning our merchandise, please call or write. We are glad to help you in anyway we can.

**Prices are subject to change without notice.**

# Table of Contents

Table of Contents ..... 1

## **Ford**

Ford Hood Measurements ..... 2 - 4

Ford Model T Hoods ..... 5 - 7

Ford Model A Hoods 1928-29 ..... 8 - 9

Ford Model A Hoods 1930-31 ..... 10 - 12

Ford 1932 Hoods ..... 13 - 16

Ford 1933 Hoods ..... 17 - 18

Ford 1934 Hoods ..... 19 - 20

Ford 1935 Hoods ..... 21

Ford 1936-37 Side Panels ..... 22

Ford 1933-34 Pickup Hoods ..... 23 - 24

Ford 1935-36 Pickup Hoods ..... 25

Ford 1937 Pickup Hoods ..... 26

Louvers ..... 27

How to Make a Pattern ..... 28

Special Orders ..... 29

Model T Fenders ..... 30 - 32

Model T Engine Pans ..... 32

Splash Aprons ..... 33

Running Boards ..... 34

Model T Accessory Parts ..... 35 - 37

Model T Speedster Kits ..... 38 - 39

Model A Speedster Kits ..... 40 - 41

## **Chevrolet**

Chevrolet Hood Measurements ..... 42

1931 Chevrolet Hoods ..... 42

1932 Chevrolet Hoods ..... 43

1933 Chevrolet Hoods ..... 44

1934-35 Chevrolet Hoods ..... 45 - 46

1936-38 Chevrolet Hoods ..... 47 - 48

49

## **Mopar**

1932 Plymouth Hoods ..... 50

1933-34 Dodge/Plymouth Hoods ..... 51

1935-36 Dodge/Plymouth Hoods ..... 52

# Ford Model T Hood Measurements

How to tell the Correct Hood for Your Car

These pictures show the specific measurements for the various years of Model T cars. If you are in doubt about the correct hood for your car a little measuring should settle the problem. Be sure to note the difference in the height of the side panel between the 1917-23 low hood and the 1924-25 high hood.

If you still have questions concerning the proper hood, please write or call us.

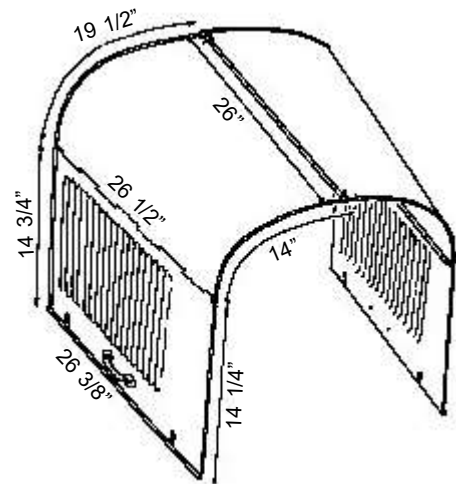
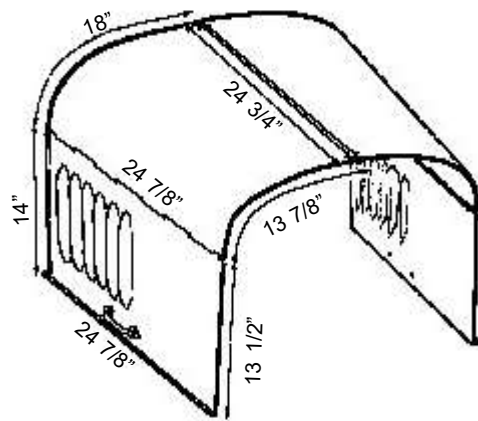
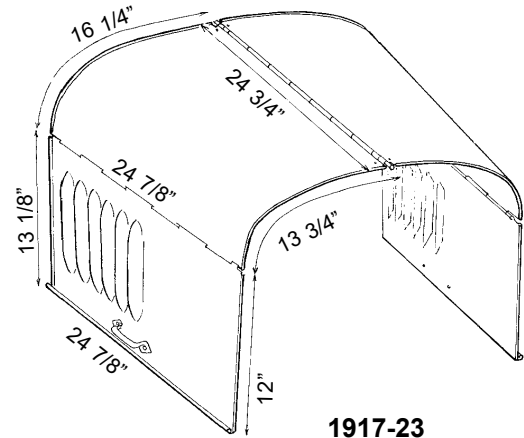
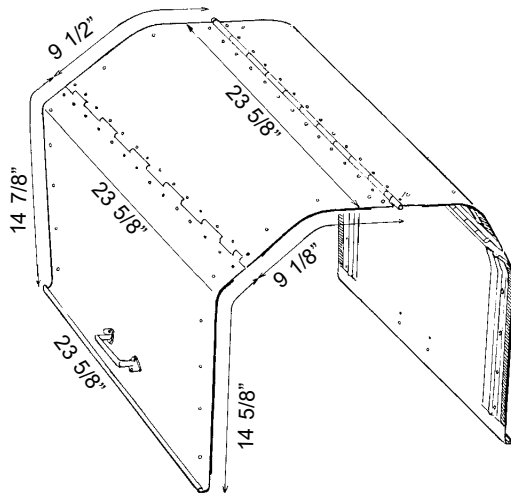
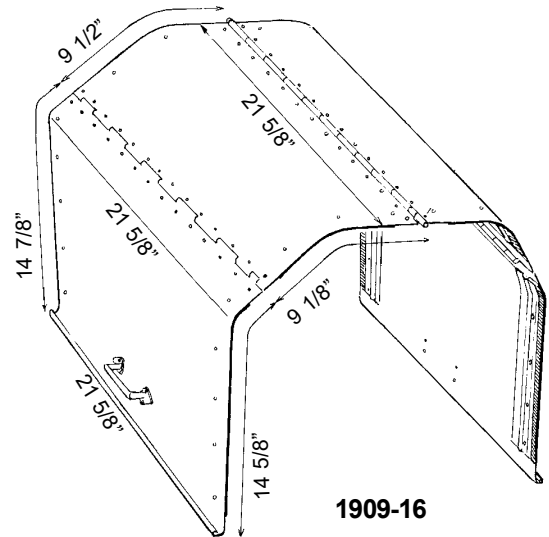

# Ford Hood Measurements

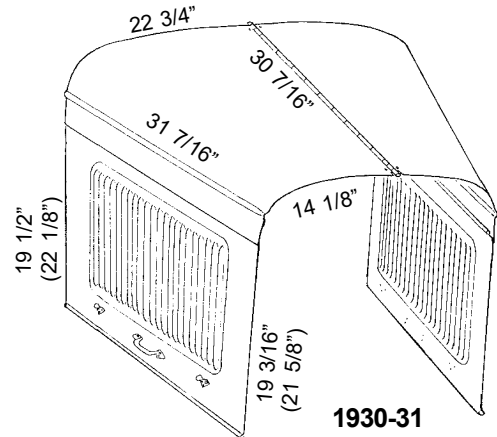
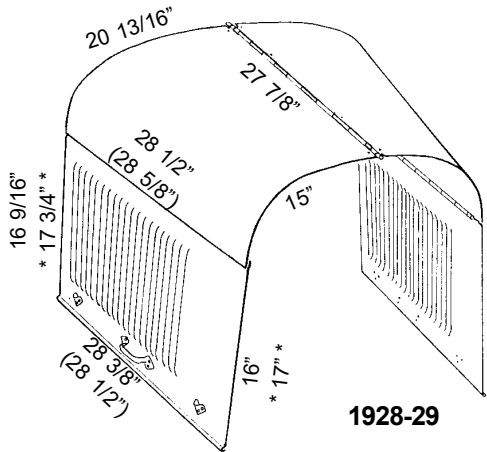

Measurements in parenthesis are for 1928-29 hoods to fit a 1932 grill shell. Measurements in parenthesis are for 1930-31 3 piece hood. Measurements in \* are for the 3 piece hood.

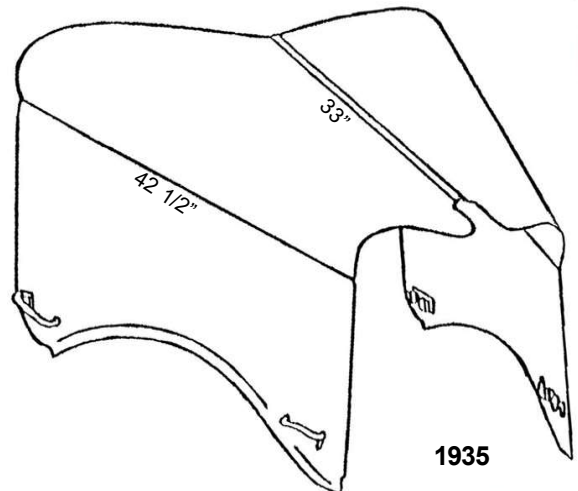
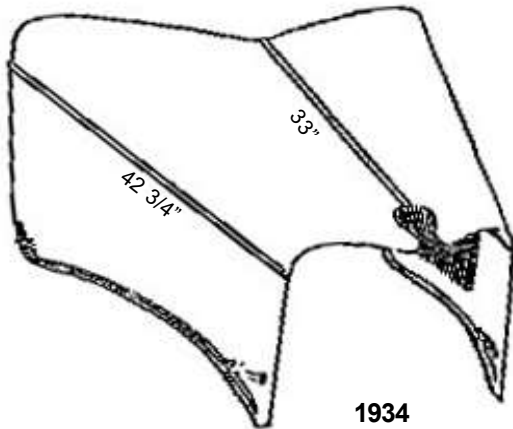
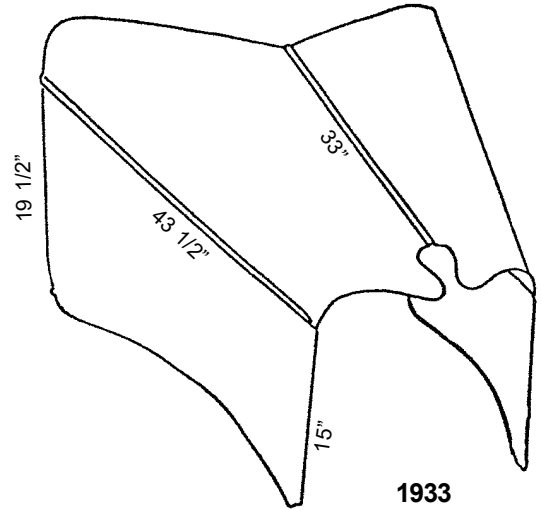
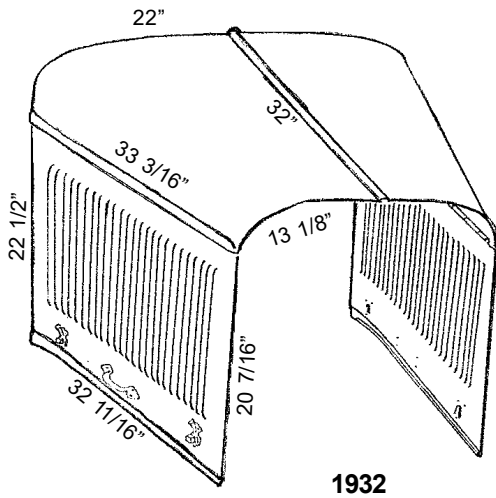

# Ford Pickup Hood Measurements 1933-1937

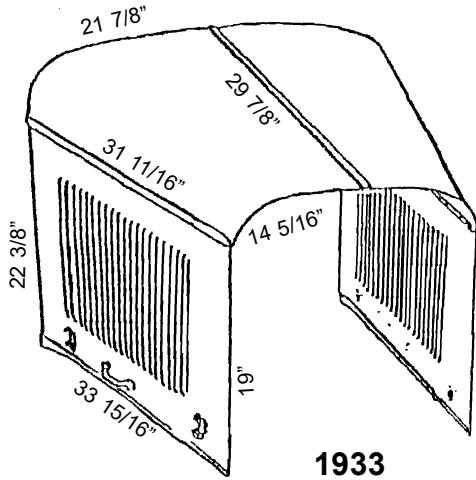

1933

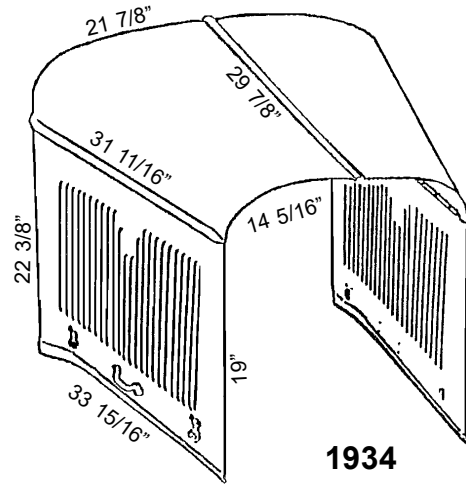

1934

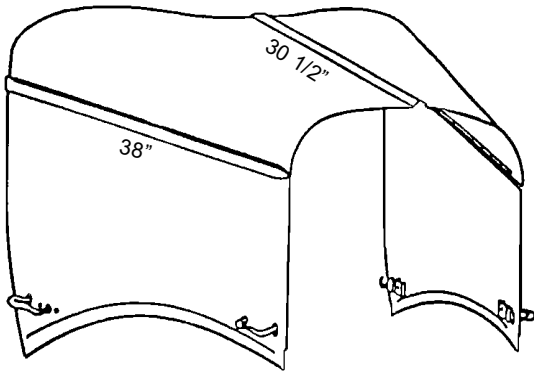

1935

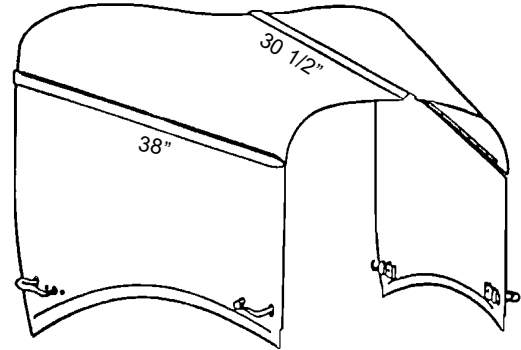

1936

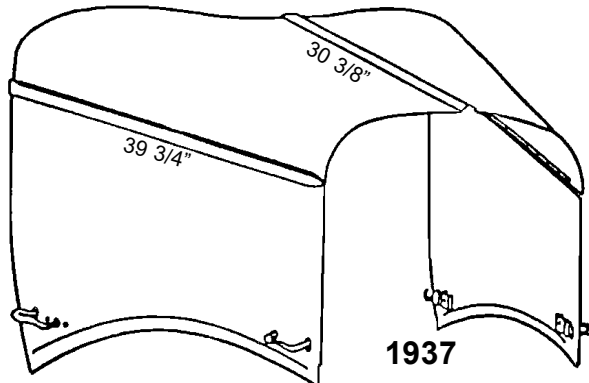

1937

# Ford Model T Hoods

Buy with confidence! Finest quality and expert workmanship. All the stock Model T hoods are exact duplicates of the originals. Same gauge metal, correct size and number of louvers with the correct hardware installed like the original.



#102 Early 1909 Steel Stock \$425.00  
#103 Early 1909 Steel Stock w/brass handles \$465.00

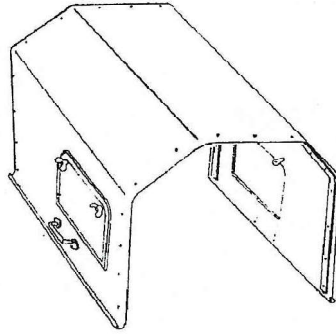

#100 N.R.S. Steel Stock  
Call or write for a price

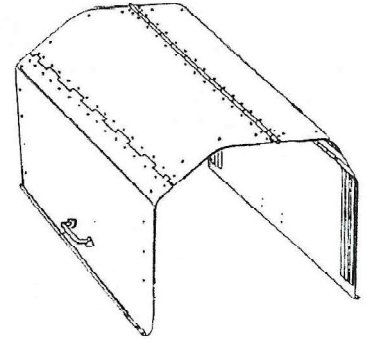

#106 1910-11 Torpedo Aluminum Stock \$425.00



#108 1913-14 Aluminum Stock \$425.00

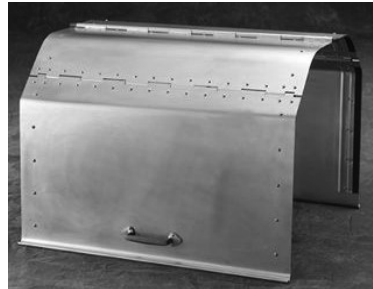

#104 1909-12 Aluminum Stock \$425.00



#110 1915-16 Aluminum Stock \$425.00  
#111 1915-16 Steel Stock \$425.00



#112 1917-23 Steel Stock \$425.00  
Also fits a '17-23 TT truck



#114 1924-25 Steel Stock \$425.00  
Also fits a '24-27 TT truck



#116 1926-27 Plain Tops/Stock Sides \$425.00

# Ford Model T 4 Pc Hoods

Shown below are 1926-27 stock hoods and hot rod hoods with a 1932 center hinge. All 1926-27 hoods are available with a '32 center hinge. Note the part numbers shown under the particular style that you desire. The 1932 center hinge provides ease of opening and helps prevent paint chipping. Stainless steel center strip molding is included with the hood.

Order a pair of part #178 to mount your center hinge molding.

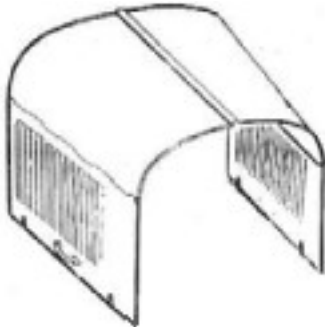

#130 1926-27 Plain Tops/Stock Sides w/32 Center Hinge \$450.00



#133 1926-27 Plain Tops/Plain Sides \$425.00  
#134 1926-27 Plain Tops/Plain Sides w/32 Center Hinge \$450.00



#122 1926-27 Plain Tops/3 Row Sides \$425.00  
#123 1926-27 Plain Tops/3 Row Sides w/32 Center Hinge \$450.00  
#124 1926-27 2 Row Tops/Stock Sides \$525.00  
#125 1926-27 2 Row Tops/Stock Sides w/32 Center Hinge \$550.00

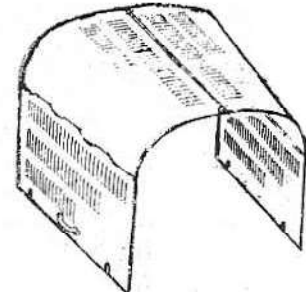

#126 1926-27 2 Row Tops/3 Row Sides \$525.00  
#132 1926-27 2 Row Tops/3 Row Sides w/32 Center Hinge \$550.00  
#128 1926-27 2 Row Tops/Plain Sides \$525.00  
#129 1926-27 2 Row Tops/Plain Sides w/32 Center Hinge \$550.00

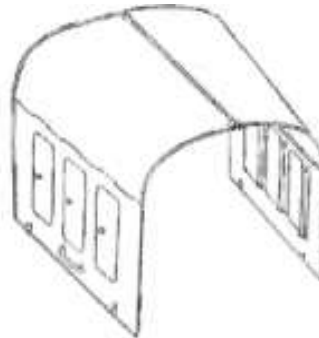

#118 1926-27 Plain Tops/3 Door Sides \$715.00  
#119 1926-27 Plain Tops/3 Door Sides w/32 Center Hinge \$740.00  
#120 1926-27 3 Door Sides Only \$582.50

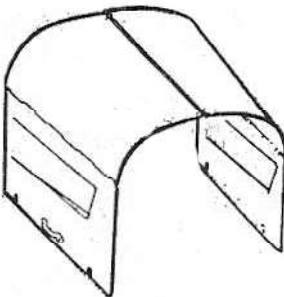

#135 1926-27 Plain Tops/1 Scoop Sides \$725.00  
#136 1926-27 Plain Tops/1 Scoop Sides w/32 Center Hinge \$750.00

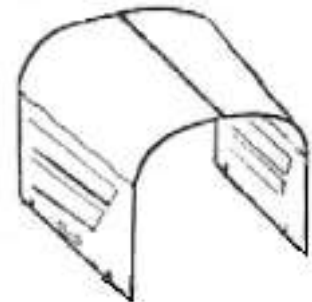

#137 1926-27 Plain Tops/2 Scoop Sides \$1025.00  
#138 1926-27 Plain Tops/2 Scoop Sides w/32 Center Hinge \$1050.00



# Ford Model T 3 Pc Hoods

Be Sure to Specify the Year

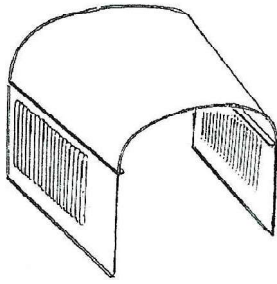

- #140 1917-27 Plain Top/Stock Sides \$415.00
- #141 1917-27 Plain Top Only \$245.00
- #141A 1917-27 Pair Stock Sides Only \$170.00

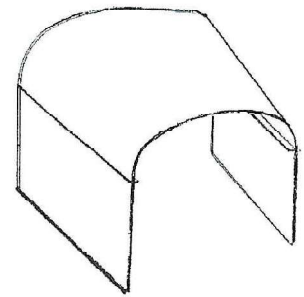

- #144 1917-27 Plain Top/Plain Sides \$415.00
- #144A 1917-27 Pair Plain Sides Only \$170.00



- #142 1917-27 Plain Top/3 Row Sides \$415.00
- #142A 1917-27 Pair 3 Row Sides Only \$170.00

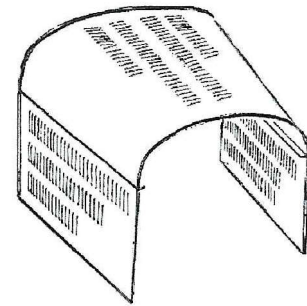
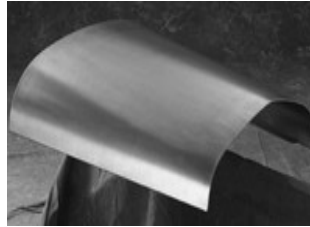

- #146 1917-27 4 Row Top/3 Row Sides \$515.00
- #147 1917-27 4 Row Top Only \$345.00

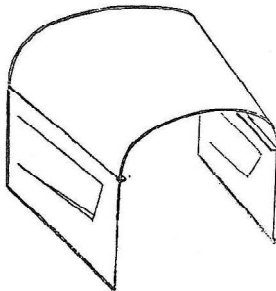

- #148 1917-27 4 Row Top/Stock Sides \$515.00
- #150 1917-27 4 Row Top/Plain Sides \$515.00

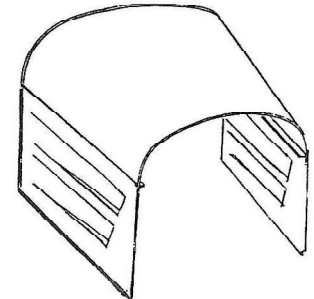
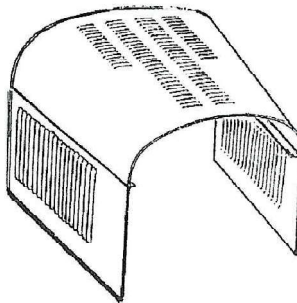

- #151 1917-27 Plain Top/1 Scoop Sides \$715.00
- #151A 1917-27 Pair 1 Scoop Sides Only \$470.00

- #152 1917-27 Plain Top/2 Scoop Sides \$1015.00
- #152A 1917-27 Pair 2 Scoop Sides Only \$770.00

## Model T Hood Accessories

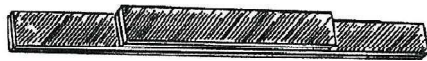

- #160 1909-16 Leather Hood Lacing \$40.00
- #162 1915-16 Hood Clips \$30.00
- #163 1915-16 Brass Clips \$40.00



### Model T Handles Pair

- #164 1909-12 Cast Aluminum Handles \$30.00
- #164A 1909-12 Brass Handles \$65.00
- #165 1913-16 Pressed Steel Handles \$30.00
- #166 1917-27 Pressed Steel Handles \$30.00



- #178 1926-27 Hold Down Clips for a 1932 Center Hinge \$25.00



- #179 1909-10 Coil Box Clips (set) \$30.00



- #176 1926-27 Polished 1932 Center Molding \$35.00

### Model T Hinge Rods Set of 3



- #170 1909-16 Cold Finish Hinge Rods \$30.00
- #171 1909-16 Stainless Steel Hinge Rods \$40.00
- #172 1917-25 Cold Finish Hinge Rods \$30.00
- #173 1917-25 Stainless Steel Hinge Rods \$40.00
- #174 1926-27 Cold Finish Hinge Rods \$30.00
- #175 1926-27 Stainless Steel Hinge Rods \$40.00

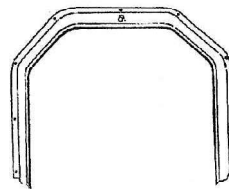

- #180 1911-14 Steel Hood Former \$230.00

### Replacement Rivets

Both round and oval head rivets are available for all Model T hoods. State the year of hood when ordering.

\$.20 each

# Ford 1928-29 Model A 4 Pc Hoods

1928-29 stock Model A Hoods built exactly as the originals using the same gauge metal, correct sizes and louver placement. Pressed steel handles and clips are installed and the hinge rods and center molding is included. Various styles of high quality hot rod hoods are available.



- #400 Early 1928 Tapered Louver \$550.00
- #401 Early 1928 Only Briggs Sedan w/Tapered Louver \$550.00
- #404 Late 1928-29 Briggs Sedan \$550.00



- #402 1928-29 Plain Tops/Stock Sides \$550.00
- #402A 1928-29 Plain Tops Only \$285.00
- #402B 1928-29 Pair Stock Sides Only \$285.00
- #403 1928-29 Plain Tops/Stock Sides w/32 Center Hinge \$575.00
- #403A 1928-29 Plain Tops Only w/32 Center Hinge \$310.00



- #408 1928-29 Plain Tops/Plain Sides \$550.00
- #408A 1928-29 Plain Sides Only \$285.00
- #409 1928-29 Plain Tops/Plain Sides w/32 Center Hinge \$575.00



- #406 1928-29 Plain Tops/3 Row Sides \$550.00
- #406A 1928-29 Pair 3 Row Sides Only \$285.00
- #407 1928-29 Plain Tops/3 Row Sides w/32 Center Hinge \$575.00



- #414 1928-29 2 Row Tops/3 Row Sides \$650.00
- #414A 1928-29 2 Row Tops Only \$385.00
- #415 1928-29 2 Row Tops/3 Row Sides w/32 Center Hinge \$675.00
- #415A 1928-29 2 Row Tops Only w/32 Center Hinge \$410.00
- #420 1928-29 2 Row Tops/Plain Sides \$650.00
- #421 1928-29 2 Row Tops/Plain Sides w/32 Center Hinge \$675.00



- #410 1928-29 Plain Tops/3 Door Sides \$950.00
- #411A 1928-29 Pair 3 Door Sides Only \$685.00
- #412 1928-29 Plain Tops/3 Door Sides w/32 Center Hinge \$1025.00
- #416 1928-29 2 Row Tops/3 Door Sides \$1050.00
- #418 1928-29 2 Row Tops/3 Door Sides w/32 Center Hinge \$1075.00

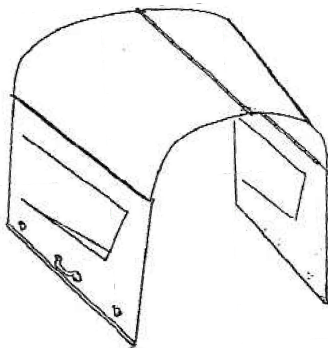

- #417 1928-29 Plain Tops/1 Scoop Sides \$850.00
- #417A 1928-29 Plain Tops/1 Scoop Sides w/32 Center Hinge \$875.00

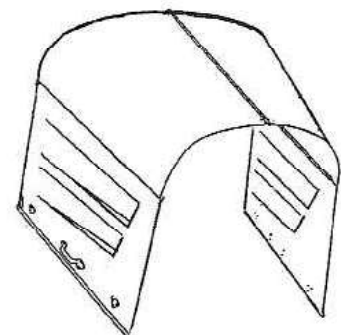

- #419 1928-29 Plain Tops/2 Scoop Sides \$1150.00
- #419A 1928-29 Plain Tops/2 Scoop Sides w/32 Center Hinge \$1175.00

# Ford 1928-29 Model A 3 Pc Hoods

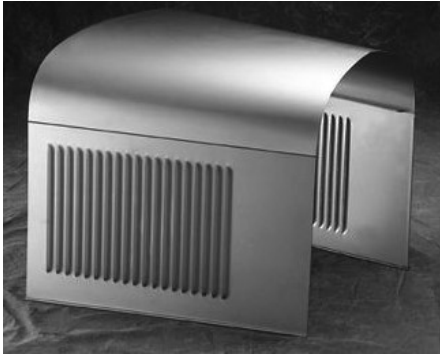

#424 1928-29 Plain Top/Stock Sides \$540.00  
 #425 1928-29 Plain Top Only \$340.00  
 #425A 1928-29 Pair Stock Sides Only \$220.00

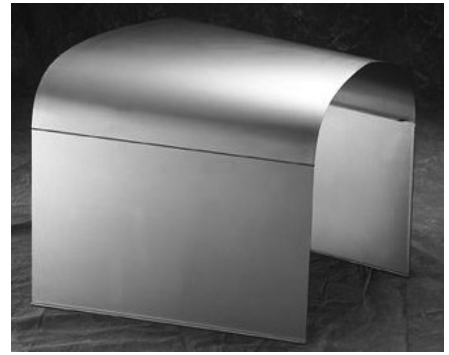

#428 1928-29 Plain Top/Plain Sides \$540.00  
 #428A 1928-29 Pair Plain Sides Only \$220.00

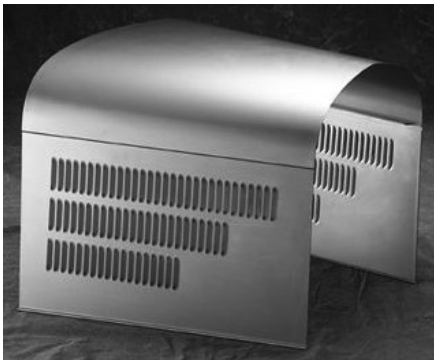

#426 1928-29 Plain Top/3 Row Sides \$540.00  
 #426A 1928-29 Pair 3 Row Sides \$220.00

**Be sure to specify if you are using a 1932 grill shell.**

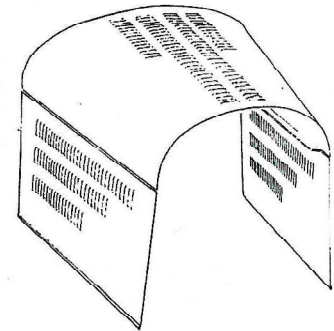

#430 1928-29 4 Row Top/3 Row Sides \$640.00  
 #431 1928-29 4 Row Top Only \$440.00

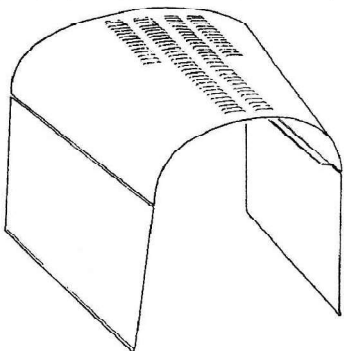

#434 1928-29 4 Row Top/Plain Sides \$640.00

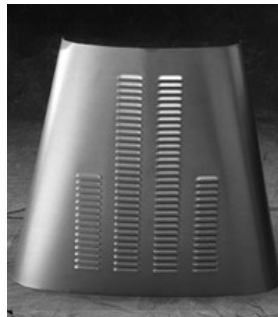

#432 1928-29 4 Row Top/Stock Sides \$640.00

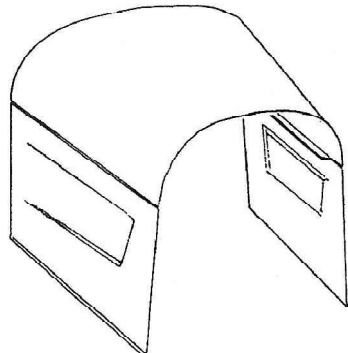
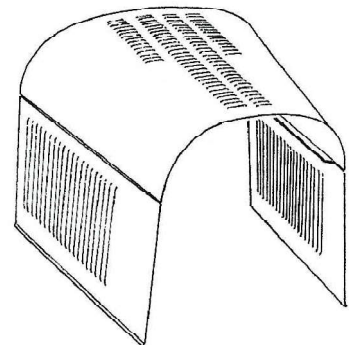

#427 1928-29 Plain Top/1Scoop Sides \$840.00  
 #427A 1928-29 Pair 1 Scoop Sides Only \$520.00

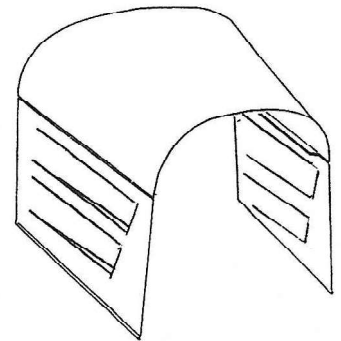

#429 1928-29 Plain Top/2 Scoop Sides \$1140.00  
 #429A 1928-29 Pair 2 Scoop Sides Only \$820.00

## Ford 1930-31 Model A 4 Pc Hoods

Highest quality 1930-31 Model A Hoods. All stock hoods are exactly as the originals with the same gauge metal, correct size and placement of the louvers, pressed steel handles and clips installed and the hinge rods are included. Various styles of hot rod hoods are available with the 1932 center hinge which gives a flat attractive appearance that provides ease of opening and helps prevent paint chipping. Polished stainless steel center hinge molding is included.



**1930-31 with 1932 Henry Louvers**

We took the stock hood and redesigned it by lifting the side hinge up into the beltline on the top panels. This gave us taller side panels that allow us to put the original 1932 Ford louver in the panels. If you have a 1932 grill shell on your 1930-31 Ford, you need this hood. An added benefit is that the hoods go a long way towards eliminating over heating problems.

#455 1930-31 Plain Tops/1932 25 Henry Louver Sides \$1080.00



#450 1930-31 Plain Tops/Stock Sides \$620.00  
 #450A 1930-31 Plain Tops Only \$320.00  
 #450B 1930-31 Pair Stock Sides \$320.00  
 #451 1930-31 Plain Tops/Stock Sides w/32 Center Hinge \$645.00  
 #451A 1930-31 Plain Tops Only w/32 Center Hinge \$345.00



#458 1930-31 Plain Tops/Plain Sides \$620.00  
 #458A 1930-31 Plain Tops/Plain Sides w/32 Center Hinge \$645.00  
 #458B 1930-31 Pair Plain Sides Only \$320.00



#452 1930-31 Plain Tops/3 Row Sides \$620.00  
 #452A 1930-31 Pair 3 Row Sides Only \$320.00  
 #453 1930-31 Plain Tops/3 Row Sides w/32 Center Hinge \$645.00



#462 1930-31 2 Row Tops/3 Row Sides \$720.00  
 #462A 1930-31 2 Row Tops Only \$420.00  
 #463 1930-31 2 Row Tops/3 Row Sides w/32 Center Hinge \$745.00  
 #463A 1930-31 2 Row Tops Only w/32 Center Hinge \$445.00  
 #466 1930-31 2 Row Tops/Stock Sides \$720.00  
 #467 1930-31 2 Row Tops/Stock Sides w/32 Center Hinge \$745.00



- #454 1930-31 Plain Tops/4 Row Sides \$620.00
- #454A 1930-31 Pair 4 Row Sides Only \$320.00
- #460 1930-31 Plain Tops/4 Row Sides  
w/32 Center Hinge \$645.00
- #464 1930-31 2 Row Tops/4 Row Sides \$720.00
- #465 1930-31 2 Row Tops/4 Row Sides  
w/32 Center Hinge \$745.00



- #470 1930-31 Plain Tops/1 Scoop Sides \$920.00
- #470A 1930-31 Plain Tops/1 Scoop Sides  
w/32 Center Hinge \$945.00
- #471 1930-31 Plain Tops/2 Scoop Sides \$1220.00
- #471A 1930-31 Plain Tops/2 Scoop Sides  
w/32 Center Hinge \$1245.00



- #456 1930-31 Plain Top/3 Door Sides \$1020.00
- #459A 1930-31 Pair 3 Door Sides Only \$720.00



- #468 1930-31 2 Row Tops/3 Doors Sides \$1120.00
- #469 1930-31 2 Row Tops/3 Doors Sides  
w/32 Center Hinge \$1145.00

## Model A Hood Parts

### Model A Hinge Rods Set of Three

- #489 1928-29 Cold Finish Hinge Rods \$30.00
- #490 1928-29 Stainless Steel Hinge Rods \$40.00
- #491 1930-31 Cold Finish Hinge Rods \$30.00
- #492 1930-31 Stainless Steel Hinge Rods \$40.00



- #493 1928-29 Center Strip Molding \$35.00
- #494 1930-31 Center Strip Molding \$35.00



### Model A Handles Pair

- #487 1928-31 Pressed Steel Handles (Rivets Included) \$30.00
- #487SS 1928-31 Stainless Steel Handles (Rivets Included) \$40.00

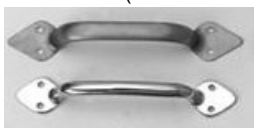

- #497 1928-31 Hood Handle Rivet \$0.20 each
- #498 1928-31 Hood Clip Rivet \$0.20 each

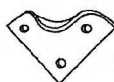

- #488 1928-31 Pressed Steel Clip \$30.00  
(Set of 4 Rivets Included)
- #488SS 1928-31 Stainless Steel Clip \$40.00  
(Set of 4 Rivets Included)



- #495 1928-29 Rear Center Hinge Bracket \$35.00  
'32 Center Hinge



- #496 1932 Front Center Hinge Bracket \$25.00  
Stainless Steel



- #499 1930-31 Rear Center Hinge Bracket \$35.00  
'32 Center Hinge



- #485A 1928-29 Hold Down Latch (Set of 4) \$90.00  
Stainless Steel
- #485B 1930-31 Hold Down Latch (Set of 4) \$90.00  
Stainless Steel

# Ford 1930-31 Model A 3 Pc Hoods

Made to fit a '32 grill shell



- #472 1930-31 Plain Top/Stock Sides \$595.00
- #472A 1930-31 Pair Stock Sides Only \$250.00
- #473 1930-31 Plain Top Only \$365.00
- #473C 1930-31 Top Only w/Cowl Induction \$590.00



- #474 1930-31 Plain Top/Plain Sides \$595.00
- #474A 1930-31 Pair Plain Sides Only \$250.00



- #476 1930-31 Plain Top/3 Row Sides \$595.00
- #476A 1930-31 Pair 3 Row Sides Only \$250.00



- #478 1930-31 Plain Top/4 Row Sides \$595.00
- #478A 1930-31 Pair 4 Row Sides Only \$250.00

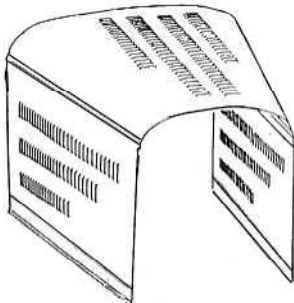

- #484 1930-31 4 Row Top/3 Row Sides \$695.00
- #480 1930-31 4 Row Top/Plain Sides \$695.00
- #481 1930-31 4 Row Top Only \$465.00
- #482 1930-31 4 Row Top/Stock Sides \$695.00

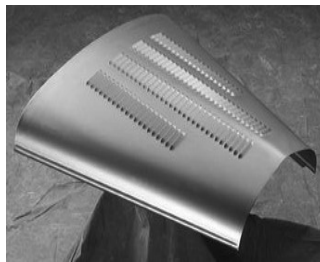

- #486 1930-31 4 Row Top/4 Row Sides \$695.00

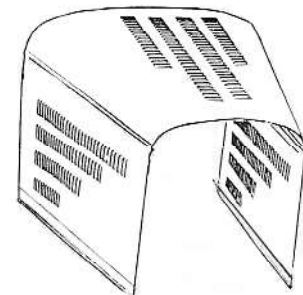

- #477 1930-31 Plain Top/1 Scoop Sides \$895.00
- #477A 1930-31 Pair 1 Scoop Sides Only \$550.00

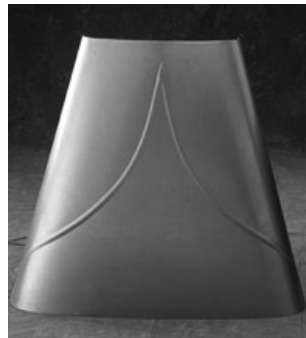

- #475 1930-31 V-Belt Top/Plain Sides \$755.00
- #475A 1930-31 V-Belt Top Only \$525.00

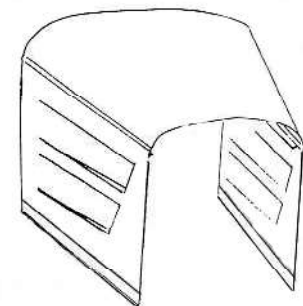

- #479 1930-31 Plain Top/2 Scoop Sides \$1195.00
- #479A 1930-31 Pair 2 Scoop Sides Only \$850.00

# Ford 1932 4 Pc Hoods

The stock hoods are made exactly as the originals with the same gauge metal. Both the 20 and 25 louver hoods are available. All hoods are fit to a cowl and radiator shell to assure an accurate contour. Hot rod styles with various louver patterns are available in the same high quality. Pressed steel handles and clips with rubber bumpers attached. Polished stainless steel center hinge molding included.

After years and years of "When are you going to make correct 25 louver hood sides?", they are here. The louvers are very deep and very open. You can look at the complete engine and then look through the engine bay and out the other side. The louvers are bowed outward from the centerline of the car as well as the dummy louvers at the front and the back. The panels also have the correct twist front to back. These will fit your original Ford top panels. Made in both four-piece and three-piece styles, they can be ordered to fit cars with stretched chassis as well. Made from Ford's blueprints.



#503 1932 Plain Tops/25 Henry Louver Sides \$1,260.00  
 #503A 1932 Pair 25 Henry Louver Sides Only \$890.00



#500 1932 Plain Tops/20 Louver Sides \$760.00  
 #501 1932 Pair Plain Tops Only \$390.00  
 #502 1932 Pair 20 Louver Sides Only \$390.00



#504 1932 Plain Tops/25 Louver Sides \$760.00  
 #505 1932 Pair 25 Louver Sides Only \$390.00



#530 1932 Plain Tops/Plain Sides \$760.00  
 #527 1932 Pair Plain Sides Only \$390.00



#506 1932 Plain Tops/3 Row Sides \$760.00  
 #507 1932 Pair 3 Row Sides Only \$390.00  
 #508 1932 Plain Tops/4 Row Sides \$760.00  
 #509 1932 Pair 4 Row Sides Only \$390.00



#510 1932 2 Row Tops/3 Row Sides \$860.00  
 #511 1932 Pair 2 Row Tops Only \$490.00  
 #512 1932 2 Row Tops/4 Row Sides \$860.00  
 #526 1932 2 Row Tops/Plain Sides \$860.00



#514 1932 3 Row Tops/3 Row Sides \$910.00  
 #515 1932 Pair 3 Row Tops Only \$540.00  
 #516 1932 3 Row Tops/4 Row Sides \$910.00  
 #528 1932 3 Row Tops/Plain Sides \$910.00

# Ford 1932 4 Pc Hoods



#522 1932 3 Row Tops/20 Louver Sides \$910.00  
 #518 1932 2 Row Tops/20 Louver Sides \$860.00



#524 1932 3 Row Tops/25 Louver Sides \$910.00  
 #520 1932 2 Row Tops/25 Louver Sides \$860.00

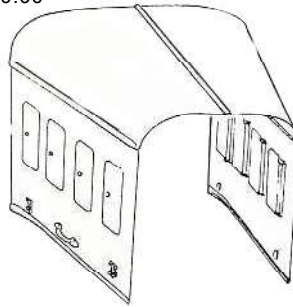

#532 1932 Plain Tops/4 Door Sides \$1260.00  
 #534 1932 Pair 4 Door Sides Only \$890.00



#536 1932 Plain Tops/1 Scoop Sides \$1060.00  
 #537 1932 Pair 1 Scoop Sides Only \$690.00

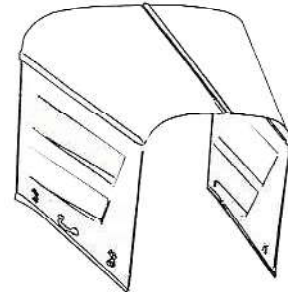

#538 1932 Plain Tops/2 Scoop Sides \$1360.00  
 #539 1932 Pair 2 Scoop Sides Only \$990.00

## 1932 Hood Parts

### Hinge Rods Set of Two

#578 1932 Cold Finish Hinge Rods \$30.00  
 #579 1932 Stainless Steel Hinge Rods \$50.00



#574 1932 Center Strip Molding (32" Long) \$35.00



### Handles Pair

#575 1928-32 Pressed Steel Handles (Rivets Included) \$30.00  
 #575SS 1928-32 Stainless Steel Handles (Rivets Included) \$40.00



#581 1932 Front Center Hinge Hold Down Bracket \$25.00



#582 1932 Rear Center Hinge Hold Down Bracket \$35.00



#576 1932 Pressed Steel Clip (Set of 4) Rubber Bumper Included \$35.00

#577 1932 Stainless Steel Clip (Set of 4) Rubber Bumper Included \$55.00



#583 1932 Hold Down Latch (Set of 4) Stainless Steel \$90.00



# Ford 1932 3 Pc Hoods



#560 1932 Plain Top/Plain Sides \$695.00  
 #551 1932 Plain Top Only \$395.00  
 #560A 1932 Pair Plain Sides Only \$320.00



#556 1932 Plain Top/3 Row Sides \$695.00  
 #556A 1932 Pair 3 Row Sides Only \$320.00  
 #558 1932 Plain Top/4 Row Sides \$695.00  
 #558A 1932 Pair 4 Row Sides Only \$320.00



#550 1932 Plain Top/20 Louver Sides \$695.00  
 #550A 1932 Pair 20 Louver Sides Only \$320.00



#554 1932 Plain Top/25 Louver Sides \$695.00  
 #554A 1932 Pair 25 Louver Sides Only \$320.00

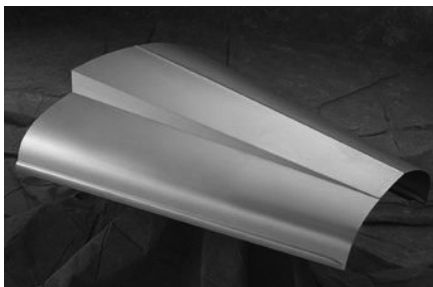

#551A 1932 Cowl Induction Top Only \$570.00

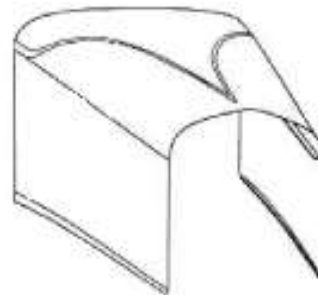

#571 1932 V-Belt Top/Plain Sides \$855.00  
 #571A 1932 V-Belt Top Only \$555.00

# Ford 1932 3 Pc Hoods

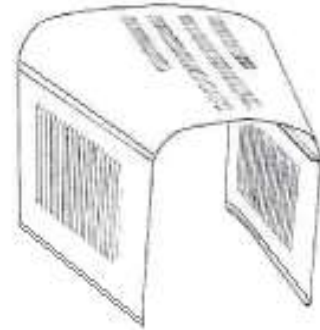
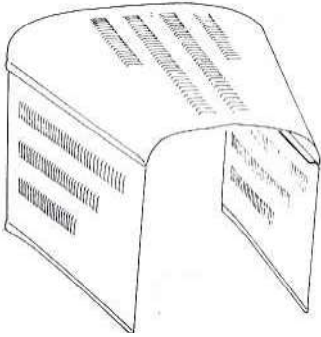

#562	1932 4 Row Top/Plain Sides	\$795.00
#562A	1932 4 Row Top Only	\$495.00
#564	1932 4 Row Top/3 Row Sides	\$795.00
#566	1932 4 Row Tops/4 Row Sides	\$795.00

#568	1932 4 Row Top/20 Louver Sides	\$795.00
#570	1932 4 Row Top/25 Louver Sides	\$795.00



#569	1932 6 Row Top/Plain Sides	\$845.00
#569A	1932 6 Row Top Only	\$545.00

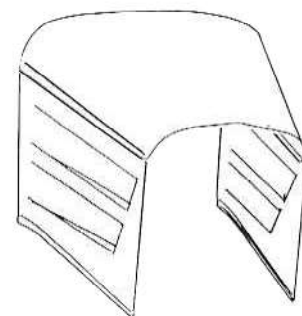
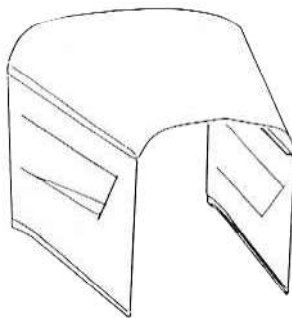

#552	1932 Plain Top/1 Scoop Sides	\$995.00	#553	1932 Plain Top/2 Scoop Sides	\$1295.00
#552A	1932 Pair 1 Scoop Sides Only	\$620.00	#553A	1932 Pair 2 Scoop Sides Only	\$920.00

# Ford 1933 4 Pc Hoods

Quality 1933 hoods using the same gauge metal as originals. All hoods are pre-fit to a cowl and radiator shell to assure the correct contour. Hinge rods and center molding included. No latching hardware or handles available. 1934 handles can be installed upon request.

**1934 Handles Installed Add \$135.00**



- #608B 1933 Plain Tops/Stock Sides (No Bead) \$1150.00
- #608C 1933 Pair Stock Sides Only (No Bead) \$610.00
- #608E 1933 Plain Tops/Stock Sides (With Bead) \$1400.00



- #604 1933 Plain Tops/Plain Sides \$950.00
- #604A 1933 Pair Plain Tops Only \$560.00
- #604B 1933 Pair Plain Sides Only (No Bead) \$410.00

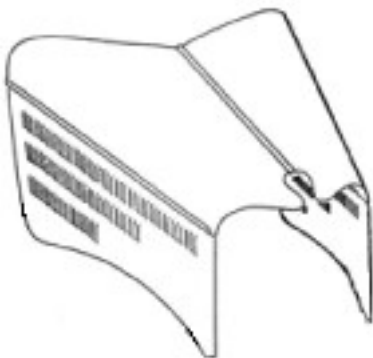

- #605 1933 Plain Tops/3 Row Sides \$950.00
- #605A 1933 Pair 3 Row Sides Only \$410.00
- #605B 1933 3 Row Tops Only \$710.00



- #608 1933 Plain Tops/'34 Louver Sides \$1150.00
- #608A 1933 Pair '34 Louver Sides Only \$610.00

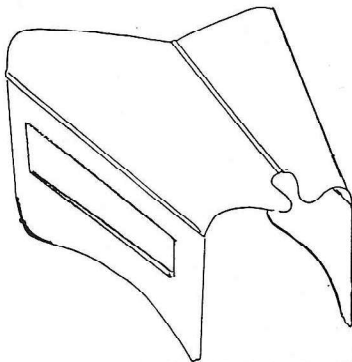

- #606 1933 Plain Tops/1 Scoop Sides \$1250.00
- #606A 1933 Pair 1 Scoop Sides Only \$710.00



- #607 1933 Plain Tops/2 Scoop Sides \$1550.00
- #607A 1933 Pair 2 Scoop Sides Only \$1010.00

# Ford 1933 3 Pc Hoods

Fine quality 1933 three piece hoods. Hoods are made with or without the radiator hole cutout. For a secure installation and smooth appearance view the hidden hinge assembly shown on page #16.

Shipped by Truck

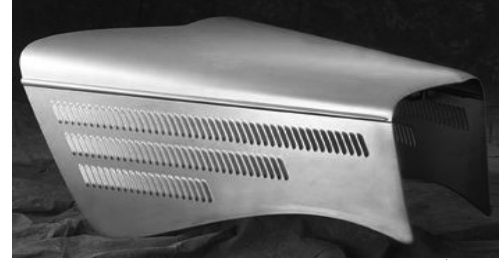

- #612 1933 Plain Top/Plain Sides No Cutout \$990.00
- #612B 1933 Plain Top Only No Cutout \$645.00
- #613 1933 Plain Top/Plain Sides w/Cutout \$990.00
- #613B 1933 Plain Top Only w/Cutout \$645.00
- #609B 1933 Pair Plain Sides Only \$365.00

- #616 1933 Plain Top/3 Row Sides No Cutout \$990.00
- #616B 1933 Plain Top/3 Row Sides w/Cutout \$990.00
- #616A 1933 Pair 3 Row Sides Only \$365.00

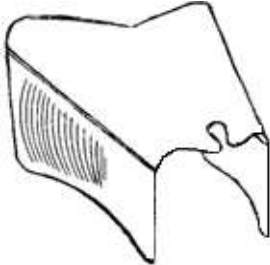

**Important Notice:**

When ordering any 1933 3 Piece Hood, you must specify the type of grill you are using. ie: Original, Plastic, Valley etc.



- #617D 1933 Plain Top/'33 Louver Sides w/Cutout \$1190.00
- #617E 1933 Plain Top/'33 Louver Sides No Cutout \$1190.00
- #617C 1933 Pair '33 Louver Sides Only \$565.00
- #617 1933 Plain Top/'34 Louver Sides w/Cutout \$1190.00
- #617B 1933 Plain Top/'34 Louver Sides No Cutout \$1190.00
- #617A 1933 Pair '34 Louver Sides Only \$565.00

- #614 1933 6 Row Top/3 Row Sides No Cutout \$1140.00
- #614B 1933 6 Row Top Only No Cutout \$795.00
- #615 1933 6 Row Top/3 Row Sides w/Cutout \$1140.00
- #615B 1933 6 Row Top Only w/Cutout \$795.00
- #618 1933 6 Row Top/Plain Sides No Cutout \$1140.00
- #619 1933 6 Row Top/Plain Sides w/Cutout \$1140.00

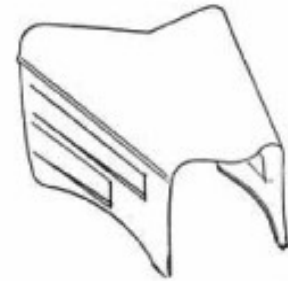

- #610 1933 Plain Top/1 Scoop Sides No Cutout \$1290.00
- #610B 1933 Plain Top/1 Scoop Sides w/Cutout \$1290.00
- #610A 1933 Pair 1 Scoop Sides Only \$665.00

- #611 1933 Plain Top/2 Scoop Sides No Cutout \$1590.00
- #611B 1933 Plain Top/2 Scoop Sides w/Cutout \$1590.00
- #611A 1933 Pair 2 Scoop Sides Only \$965.00



1 pc top w/cutout



- #609 1933 V-Belt Top/Plain Sides No Cutout \$1140.00
- #609A 1933 V-Belt Top Only No Cutout \$795.00



1 pc top no cutout

# Ford 1934 4 Pc Hoods

Superior quality 1934 hoods! The stock hood is exactly as original using the same gauge metal. All hoods are pre-fit to a cowl and radiator shell to assure the correct contour. Hoods are complete with handles, spring assemblies and stainless steel center hinge molding. '34 louvers are on a slant following the hood contours.



- #620 1934 Plain Tops/Stock Sides w/Cutout \$1150.00
- #621 1934 Pair Plain Tops Only w/Cutout \$560.00
- #622 1934 Pair Stock Sides Only \$610.00
- #623 1934 Plain Tops/Stock Sides No Cutout \$1150.00
- #630B 1934 Pair Plain Tops Only No Cutout \$560.00



- #630 1934 Plain Tops/Plain Sides w/Cutout \$950.00
- #630A 1934 Plain Tops/Plain Sides No Cutout \$950.00
- #631 1934 Pair Plain Sides Only \$410.00
- #631A 1934 Plain Tops/'33 Louver Sides w/Cutout \$1150.00



- #624 1934 Plain Tops/3 Row Sides w/Cutout \$950.00
- #624A 1934 Plain Tops/3Row Sides No Cutout \$950.00
- #625 1934 Pair 3 Row Sides Only \$410.00



- #632 1934 3 Row Tops/3 Row Sides w/Cutout \$1100.00
- #633 1934 Pair 3 Row Tops Only w/Cutout \$710.00
- #636 1934 3 Row Tops/Plain Sides w/Cutout \$1100.00



- #627 1934 Plain Tops/1 Scoop Sides w/Cutout \$1250.00
- #627A 1934 Pair 1 Scoop Sides Only \$710.00
- #628 1934 Plain Tops/1 Scoop Sides No Cutout \$1250.00

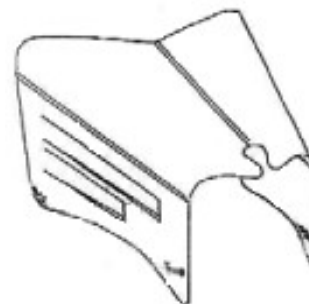

- #629 1934 Plain Top/2 Scoop Sides w/Cutout \$1550.00
- #629A 1934 Pair 2 Scoop Sides Only \$1010.00

## 1934 Hood Parts



- #670 1934 Cast Handles (each) \$35.00



- #671L 1934 Left Spring Assembly (each) \$30.00
- #671R 1934 Right Spring Assembly (each) \$30.00
- #671A 1934 Spring Only \$20.00



- #678 1933-36 Hinge Rail Section \$50.00
- #679 1933-36 Longer Rails \$60.00



### 1933-34 Hood Side Rods

- #673 1933-34 Cold Finish Side Rods \$30.00
- #674 1933-34 Stainless Steel Side Rods \$50.00



- #672 1933-36 33" Stainless Center Molding \$35.00
- #672A 48" Stainless Center Molding \$45.00
- #672B Over 48" Stainless Center Modling \$55.00

# Ford 1934 3 Pc Hoods

Shipped by Truck

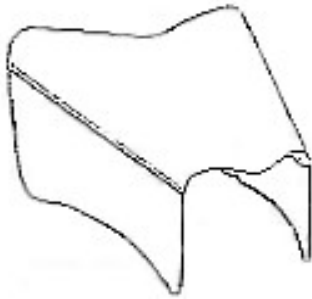

- #644 1934 Plain Top/Plain Sides No Cutout \$990.00
- #639A 1934 Plain Top Only No Cutout \$645.00
- #645 1934 Plain Top/Plain Sides w/Cutout \$990.00
- #639 1934 Plain Top Only w/Cutout \$645.00
- #644A 1934 Pair Plain Sides Only \$365.00

- #643 1934 Plain Top/3 Row Sides No Cutout \$990.00
- #642 1934 Plain Top/3 Row Sides w/Cutout \$990.00
- #642A 1934 Pair 3 Row Sides Only \$365.00

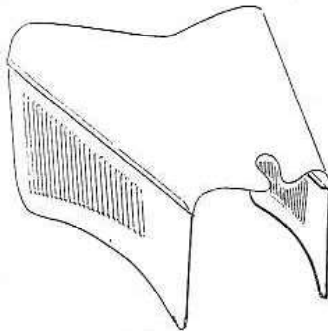

- #638 1934 Plain Top/Stock Sides w/Cutout \$1190.00
- #640 1934 Plain Top/Stock Sides No Cutout \$1190.00
- #639B 1934 Pair '34 Louver Sides Only \$565.00
- #640A 1934 Plain Top/'33 Louver Sides w/Cutout \$1190.00
- #640D 1934 Plain Top/'33 Louver Sides No Cutout \$1190.00
- #640B 1934 Pair '33 Louver Sides Only \$565.00

- #647 1934 6 Row Top/3 Row Sides No Cutout \$1140.00
- #647B 1934 6 Row Top Only No Cutout \$795.00
- #646 1934 6 Row Top/3 Row Sides w/Cutout \$1140.00
- #646B 1934 6 Row Top Only w/Cutout \$745.00
- #651 1934 6 Row Top/Plain Sides No Cutout \$1140.00
- #650 1934 6 Row Top/Plain Sides w/Cutout \$1140.00

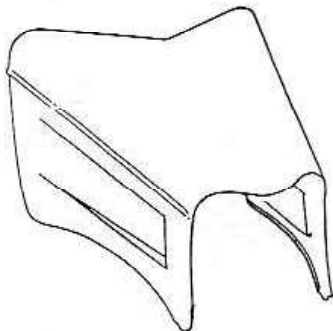
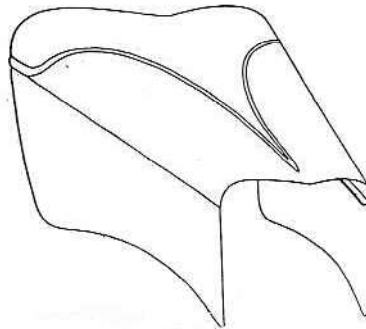

- #635 1934 V-Belt Top/Plain Sides No Cutout \$1140.00
- #635A 1934 V-Belt Top Only No Cutout \$1140.00



- #637 1934 Plain Top/1 Scoop Sides No Cutout \$1290.00
- #637B 1934 Plain Top/1 Scoop Sides w/Cutout \$1290.00
- #637A 1934 Pair 1 Scoop Sides Only \$665.00

- #641 1934 Plain Top/2 Scoop Sides No Cutout \$1590.00
- #641B 1934 Plain Top/2 Scoop Sides w/Cutout \$1590.00
- #641A 1934 Pair 2 Scoop Sides Only \$965.00

# Ford 1935 4 Pc Hoods

Fine quality 1935 hoods. No stock louvers available.  
Hardware included as shown.



- #700 1935 Plain Tops/Plain Sides \$990.00
- #700A 1935 Pair Plain Tops Only \$645.00
- #700B 1935 Pair Plain Sides Only \$365.00



- #703 1935 Plain Tops/3 Row Sides \$990.00
- #703A 1935 Pair 3 Row Sides Only \$365.00
- #709 1935 3 Row Tops/3 Row Sides \$1140.00
- #709A 1935 Pair 3 Row Tops Only \$795.00



- #701 1935 Plain Tops/1 Scoop Sides \$1290.00
- #701A 1935 Pair 1 Scoop Sides Only \$665.00

# Ford 1935 3 Pc Hoods

For Hoods With Cutout Add \$50.00  
Shipped by Truck



- #710 1935 Plain Top/Plain Sides \$990.00
- #710A 1935 Plain Top Only \$645.00
- #710B 1935 Pair Plain Sides Only \$365.00



- #712 1935 Plain Top/3 Row Sides \$990.00
- #712A 1935 Pair 3 Row Sides Only \$365.00

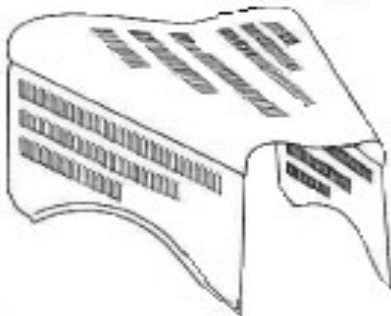

- #713 1935 6 Row Top/3 Row Sides \$1140.00
- #713A 1935 6 Row Top Only \$795.00



- #711 1935 Plain Top/1 Scoop Sides \$1290.00
- #711A 1935 Pair 1 Scoop Sides Only \$665.00

## Ford 1936 Side Panels

Top quality 1936 hood sides available with plain or hot rod louvered sides. No stock louvers available. Hardware is included.

**Tops are not available.**

Will fit stock tops.



#742  
#742A



1936 4 Pc Pair Plain Sides Only  
1936 3 Pc Pair Plain Sides Only

\$450.00  
\$450.00



#740 1936 4 Pc Pair 3 Row Sides Only  
#740A 1936 3 Pc Pair 3 Row Sides

\$450.00  
\$450.00

#741 1936 4 Pc Pair 1 Scoop Sides Only  
#741A 1936 3 Pc Pair 1 Scoop Sides Only

\$750.00  
\$750.00

## Ford 1937 Side Panels

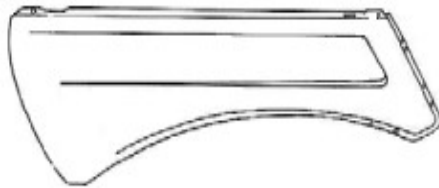

Customer must supply clean no rust, stripped 1937 Ford side panels. **Rootlieb's** will install one scoop per side. There are no exchanges and the panels that the customer sends are the ones that are returned.

Call or write for further information.

#750 Install Scoops in Customers 1937 Side Panels \$590.00 Pair

## Our Founder Mr. Henry Rootlieb





# Ford 1933-34 4 Pc Pickup Hoods

Available only with a 32 center hinge.



Wide variety of 1933-34 pickup hoods complete with hardware. Sides built to fit stock hoods. Order two front style hold down clips for mounting. (Page #14-Item #581)



- #652 1933 Pickup Plain Top/Stock Sides
- #652A 1933 Pickup Pair Plain Tops Only
- #652B 1933 Pickup Pair Stock Sides Only

\$760.00  
\$390.00  
\$390.00

- #660 1934 Pickup Plain Top/Stock Sides
- #661 1934 Pickup Pair Plain Tops Only
- #662 1934 Pickup Pair Stock Sides Only

\$760.00  
\$390.00  
\$390.00

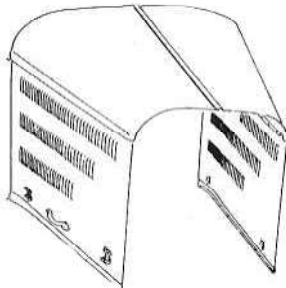

- #663 1933-34 Pickup Plain Tops/Plain Sides
- #663A 1933-34 Pickup Pair Plain Sides Only

\$760.00  
\$390.00

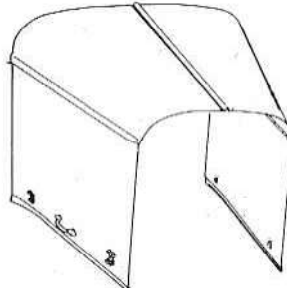

- #653D 1933-34 Pickup Plain Tops/3 Row Sides
- #653E 1933-34 Pickup Pair 3 Row Sides Only

\$760.00  
\$390.00

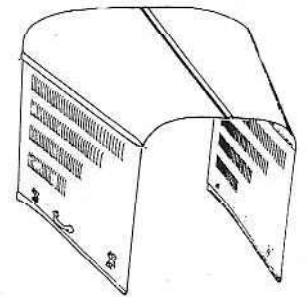

- #653B 1933-34 Pickup Plain Top/4 Row Sides
- #653C 1933-34 Pickup Pair 4 Row Sides Only

\$760.00  
\$390.00

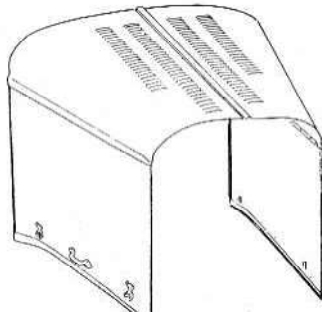

- #664 1933-34 Pickup 2 Row Tops/Plain Sides
- #665 1933-34 Pickup Pair 2 Row Tops Only
- #666 1933-34 Pickup 2 Row Tops/3 Row Sides

\$860.00  
\$490.00  
\$860.00

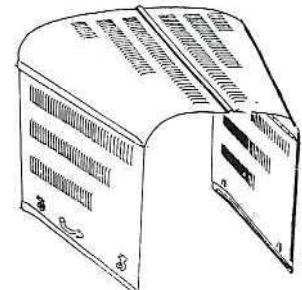

- #653F 1933-34 Pickup 3 Row Tops/3 Row Sides
- #653G 1933-34 Pickup Pair 3 Row Tops Only

\$860.00  
\$540.00

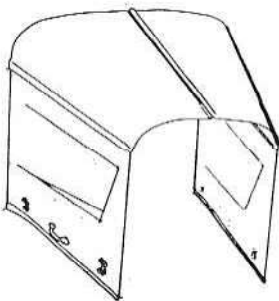

- #653 1933-34 Pickup Plain Tops/4 Door Sides
- #653A 1933-34 Pickup Pair 4 Door Sides Only

\$1260.00  
\$890.00



- #652C 1933-34 Pickup Plain Tops/1 Scoop Sides
- #652D 1933-34 Pickup Pair 1 Scoop Sides Only

\$1060.00  
\$925.00

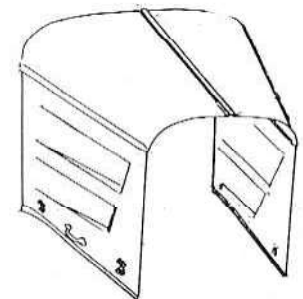

- #652E 1933-34 Pickup Plain Tops/2 Scoop Sides
- #652F 1933-34 Pickup Pair 2 Scoop Sides Only

\$1360.00  
\$990.00

# Ford 1933-34 Pickup 3 Pc Hoods

3 Piece hoods for your pickup.  
 Styles as shown. No hardware.



#654 1933-34 Pickup Plain Top/Plain Sides  
 #655 1933-34 Pickup Plain Top Only  
 #654A 1933-34 Pickup Pair Plain Sides Only

\$695.00  
 \$395.00  
 \$320.00



#654B 1933 Pickup Plain Top/Stock Sides  
 #654C 1933 Pickup Pair Stock Sides Only

\$695.00  
 \$320.00



#654F 1934 Pickup Plain Top/Stock Sides  
 #654G 1934 Pickup Pair Stock Sides Only

\$695.00  
 \$320.00

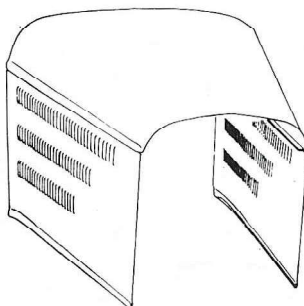

#654D 1933-34 Pickup Plain Top/3 Row Sides  
 #654E 1933-34 Pickup Pair 3 Row Sides Only

\$695.00  
 \$320.00

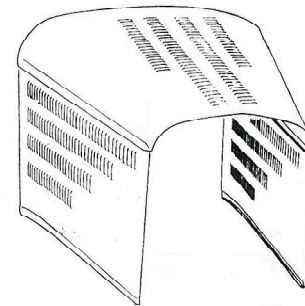

#656 1933-34 Pickup 4 Row Top/4 Row Sides  
 #656A 1933-34 Pickup Pair 4 Row Sides Only  
 #656B 1933-34 Pickup 4 Row Top/Plain Sides  
 #656C 1933-34 Pickup 4 Row Top/3 Row Sides  
 #656D 1933-34 Pickup 4 Row Top/Stock Sides  
 #656G 1933-34 Pickup 6 Row Top/3 Row Sides  
 #656F 1933-34 Pickup 4 Row Tops Only  
 #656H 1933-34 Pickup 6 Row Top Only

\$795.00  
 \$320.00  
 \$795.00  
 \$795.00  
 \$795.00  
 \$845.00  
 \$495.00  
 \$545.00

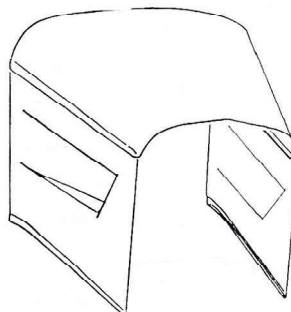

#658 1933-34 Pickup Plain Top/1 Scoop Sides  
 #658A 1933-34 Pickup Pair 1 Scoop Sides Only

\$995.00  
 \$620.00

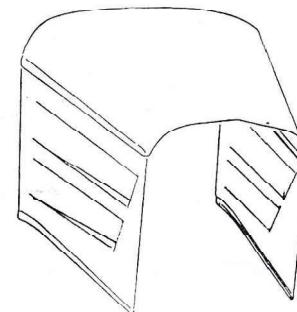

#659 1933-34 Pickup Plain Top/2 Scoop Sides  
 #659A 1933-34 Pickup Pair 2 Scoop Sides Only

\$1295.00  
 \$920.00

# Ford 1935-36 Pickup 4 Pc Hoods

Available only with 1932 center hinge.

Fine quality 1935-36 pickup hoods. Sides built to fit stock tops. Order two front style hold down clips for mounting. (Page #14-Item #581)



- #720 1935-36 Pickup Plain Tops/Plain Sides \$990.00
- #726 1935-36 Pickup Pair Plain Tops Only \$645.00
- #726A 1935-36 Pickup Pair Plain Sides Only \$365.00



- #721 1935-36 Pickup Plain Tops/3 Row Sides \$990.00
- #721A 1935-36 Pickup Pair 3 Row Sides Only \$365.00

Not Pictured

- #722 1935-36 Pickup Plain Tops/1 Scoop Sides \$1290.00
- #723 1935-36 Pickup Pair 1 Scoop Sides Only \$665.00
- #722A 1935-36 Pickup Plain Tops/2 Scoop Sides \$1590
- #723A 1935-36 Pickup Pair 2 Scoop Sides Only \$965.00
- #724 1935-36 Pickup 2 Row Tops/3 Row Sides \$1090.00
- #725 1935-36 Pickup 3 Row Tops/Plain Sides \$1140.00
- #727 1935-36 Pickup Pair 3 Row Tops Only \$795.00

# Ford 1935-36 Pickup 3 Pc Hoods

Stock Sides Not Available  
3 Piece hoods 1935-36 pickup. No hardware.  
Shipped by truck.



- #730 1935-36 Pickup Plain Top/Plain Sides \$990.00
- #731 1935-36 Pickup Plain Top Only \$645.00
- #732 1935-36 Pickup Pair Plain Sides Only \$365.00



- #736 1935-36 Pickup Plain Top/3 Row Sides \$990.00
- #737 1935-36 Pickup Pair 3 Row Sides Only \$365.00



- #734 1935-36 Pickup Plain Top/1 Scoop Sides \$1290.00
- #735 1935-36 Pickup Pair 1 Scoop Sides Only \$695.00
- #734A 1935-36 Pickup Plain Top/2 Scoop Sides \$1590.00
- #735A 1935-36 Pickup Pair 2 Scoop Sides Only \$965.00
- #738 1935-36 Pickup 6 Row Top/3 Row Sides \$1140.00
- #733 1935-36 Pickup 6 Row Top/Plain Sides \$1140.00
- #739 1935-36 Pickup 6 Row Top Only \$795.00

## Ford 1937 4 Pc Pickup Hoods

Available only with 1932 center hinge.

Fine quality 1937 pickup hoods. Sides built to fit stock tops.  
Order two front style hold down clips for mounting. (Page #14-Item #581)



- #760 1937 Pickup Plain Tops/Plain Sides \$990.00
- #766 1937 Pickup Pair Plain Tops Only \$645.00
- #760A 1937 Pickup Pair Plain Sides Only \$365.00



- #761 1937 Pickup Plain Tops/3 Row Sides \$960.00
- #761A 1937 Pickup Pair 3 Row Sides Only \$365.00

Not Pictured

- #762 1937 Pickup Plain Tops/1 Scoop Sides \$1290.00
- #762A 1937 Pickup Pair 1 Scoop Sides Only \$665.00
- #762B 1937 Pickup Plain Tops/2 Scoop Sides \$1590.00
- #762C 1937 Pickup Pair 2 Scoop Sides Only \$965.00
- #764 1937 Pickup 3 Row Tops/3 Row Sides \$1140.00
- #765 1937 Pickup 3 Row Tops/Plain Side \$1140.00
- #767 1937 Pickup 3 Row Tops Only \$795.00

## Ford 1937 Pickup 3 Pc Hoods

3 Piece hoods 1935-36 pickup. No hardware.

Shipped by truck.



- #763 1937 Pickup Plain Top/Plain Sides \$990.00
- #763A 1937 Pickup Plain Top Only \$645.00
- #763B 1937 Pickup Pair Plain Sides Only \$365.00



- #769 1937 Pickup Plain Top/3 Row Sides \$990.00
- #769A 1937 Pickup Pair 3 Row Sides Only \$365.00



- #768 1937 Pickup Plain Top/1 Scoop Sides \$1290.00
- #768A 1937 Pickup 1 Scoop Sides Only \$695.00
- #768B 1937 Pickup Plain Top/2 Scoop Sides \$1590.00
- #768C 1937 Pickup Pair 2 Scoop Sides Only \$965.00
- #769B 1937 Pickup 6 Row Top/3 Row Sides \$1140.00
- #763C 1937 Pickup 6 Row Top/Plain Sides \$1140.00
- #769C 1937 Pickup 6 Row Top Only \$795.00

# Louver Comparison

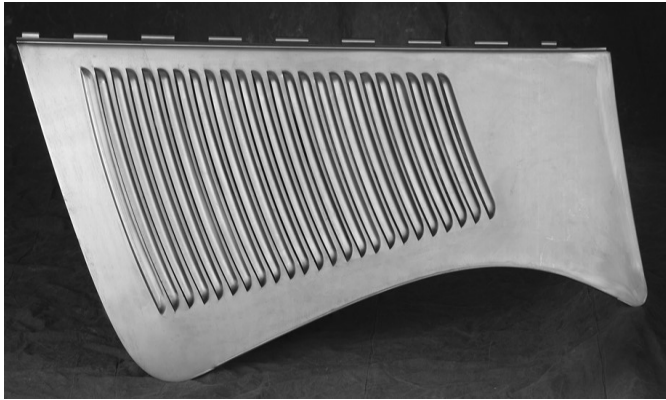

**1933 Curved Louver**



**1934 Straight Louver**

This shows the difference and lets you compare side by side the 1933 and 1934 Ford stock passenger car louvers.



**1932 25 Louver-No Dummy Louver**



**1932 "Henry" 25 Louver w/Dummy Louver**

This side by side comparison is of our 1932 Ford 25 louvered hood sides-All open with no dummy louver at the front and rear. The other is our New 1932 "Original Henry" 25 louver hood sides with the louvers that are very deep and open. You can look at the complete engine and then look through the engine bay and out the other side. The louvers are bowed outward from the centerline of the car as well as the dummy louvers at the front and the back. The first two louvers are shortened to give room for the hold down. The panels also have the correct twist front to back.



**Contemporary Louver**

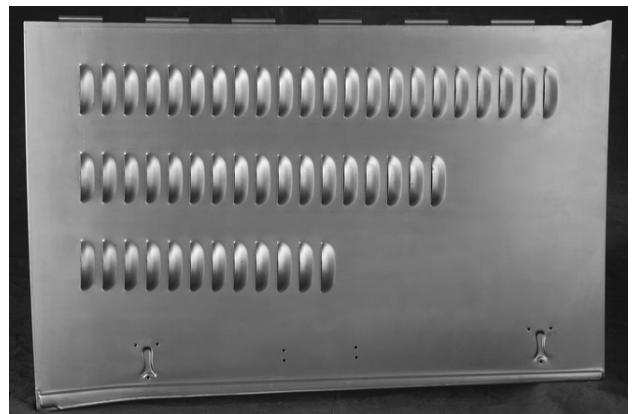

**Dry Lakes Louver**

This side by side comparison of our 3" hot rod louvers shows the Contemporary louver and our Dry Lakes louver styles both on a 1932 Ford hood side panel.

# How to Make a Hood Pattern

## Making a Pattern for a One-Piece Top

Starting in the middle of the door, place 3/4" masking tape under the beltline with the top edge of the tapeline placed into the bottom fold of the belt. Tape should be flat on the field area of door and not on any portion of the beltline. Continue forward on the car placing tapeline under beltline on the cowl area. Then moving to the front of the car, stretch tape line making sure you are projecting the belt in a straight line across the engine opening. When the projected beltline looks correct stick tape to the side of the grill shell. Repeat the process on the other side of the car. Be sure both of the tapelines are the same height on the grill shell.

Start on one side by moving up 1" from the first tapeline that was started and run another tapeline from the grill to the cowl. Repeat this process until you come to the tapeline on the other side of the car. You will have what looks like a see thru top panel of tapelines.

Next go to the meat market and ask the butcher for a couple of large pieces of butcher paper. Tape together if need be and lay paper over tape area. Trim it down to approximately 2" larger than finished size pattern. Tape the four corners down without pulling tapelines out of shape. Using a sharpened pencil lay it on its side and trace the edge of the cowl thru the paper. Repeat this step on the grill shell as well. Then go back to the two bottom tape lines and mark the top of the tapeline where it meets the cowl and grill. This is marking where the bottom of the beltline on the hood will be. Now mark on the paper where the top of the beltline on the cowl is. With all of the different bodies made today the belt width can vary greatly. Now you have a full pattern. No gap at the shell and no gap at the cowl. **(We recommend a 1/8" gap so trim pattern accordingly)** If you wish to grind the ends to fit that is fine also.

Please remember -

**“What you send to us is what you get back from us!”**

Making a paper pattern also lets you see what the car will look like on completion. If you do not like the look now is the time to change things. It is much cheaper than having us build another hood.

We have made thousands of hoods from this pattern method with excellent results and we recommend a pattern for custom hoods over a 3" stretch to ensure the best quality and fit possible. If you have any questions please feel free to call us at (209) 632-2203.

# Special Orders

## Stock Hoods

We can manufacture reproduction hoods for nearly all pre-1935 automobiles if we have a pattern. In case of only one car in existence or other various circumstances, we require drawings or photographs and dimensions for the hood. Special stock hoods of many designs can be made upon request. We can make hood panels of steel, aluminum (polished, satin or natural finish) copper and brass where required.

## Street Rod Hoods

Hood tops may be lengthened or shortened to any length required. Hood sides may be lengthened or shortened front to back and top to bottom. We can make special top panels to fit blowers or to accomodate other engine alterations.

## Fenders

We make southern wide track fenders and Canadian Model T fenders.

## Special Sheet Metal

If you have a special sheet metal need, send us several detailed photos of your part. We will evaluate the possibily of production and the approximate time and cost for the reproduction.

## Rootlieb, Inc

Our plant is located near freeway 99 at 815 S. Soderquist in Turlock, California. Our plant was started in 1973 and has grown to a 14,000 square foot establishment.

A wide range of specialized tooling enables us to produce the large variety of items in this catalog. Our careful attention to quality and detail has made us one of the largest manufactures of vintage sheet metal in the world. We always have several items in the tooling stage and more in the planning stage. If you are ever in our area, please feel free to stop and visit us. We are open Monday through Friday from 7:30 am to 4:30 pm. We shall be glad to have you come for a tour.

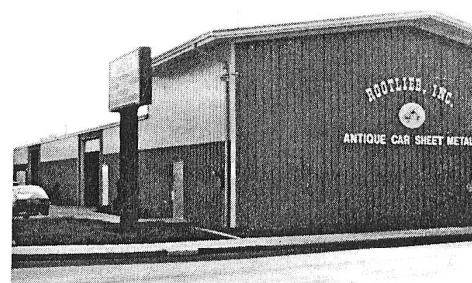

# Ford Model T Fenders

Finest quality Model T fenders that are made exactly as the originals using the same gauge metal. Early 1909-1916 fenders have the correct brackets riveted into place using the correct size and shaped rivets. Southern tread, wide track fenders that are 2" wider than stock fenders are available. Additional width is also available for street rods by special order only.



1909-12 Fenders have round head rivets.  
1913-16 Fenders have oval head rivets.  
See Page #30

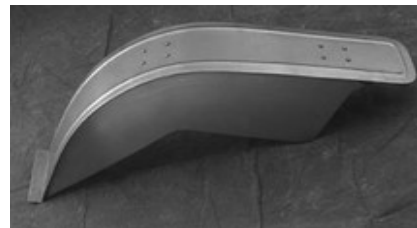

- #200 Early 1909 Right Front Fender \$410.00
- #201 Early 1909 Left Front Fender \$410.00

- #202 Early 1909 Right Rear Fender \$410.00
- #203 Early 1909 Left Rear Fender \$410.00

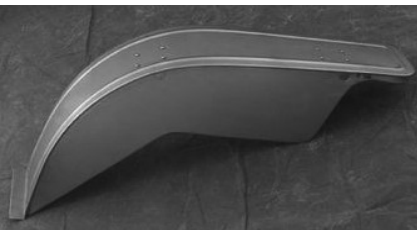
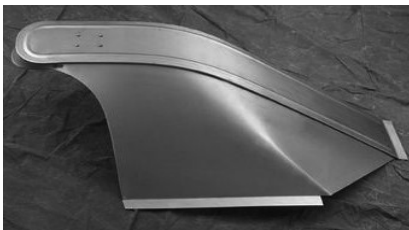

- #204 Late 1909-10 Right Front Fender \$410.00
- #205 Late 1909-10 Left Front Fender \$410.00

- #206 Late 1909-10 Right Rear Fender \$410.00
- #207 Late 1909-10 Left Rear Fender \$410.00

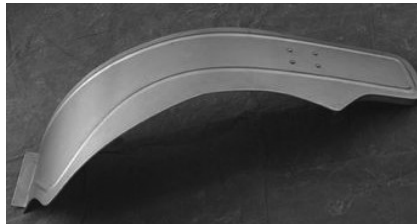

- #212 1911-12 Right Front Fender \$410.00
- #213 1911-12 Left Front Fender \$410.00

- #214 1911-12 Touring Right Rear Fender \$410.00
- #215 1911-12 Touring Left Rear Fender \$410.00

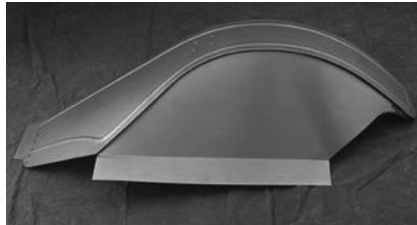

- #208 1910-11 Torpedo Right Front Fender \$430.00
- #209 1910-11 Torpedo Left Front Fender \$430.00

- #210 1910-11 Torpedo Right Rear Fender \$430.00
- #211 1910-11 Torpedo Left Rear Fender \$430.00

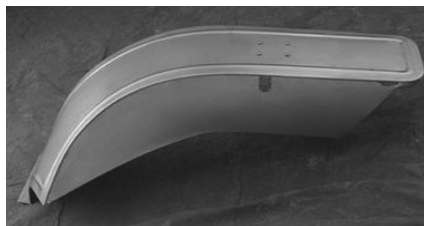

- #218 1912 Roadster Right Rear Fender \$410.00
- #219 1912 Roadster Left Rear Fender \$410.00

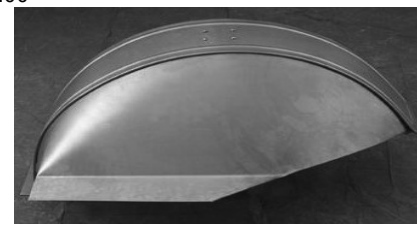
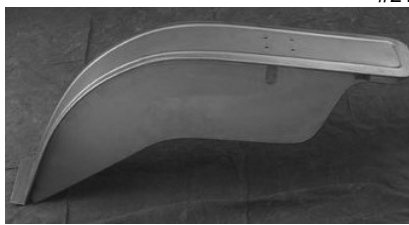

- #216 1912 Hack/C Cab Right Rear Fender \$410.00
- #217 1912 Hack/C Cab Left Rear Fender \$410.00

- #220 1912 Torpedo Right Rear Fender \$470.00
- #221 1912 Torpedo Left Rear Fender \$470.00



# Ford Model T Fenders



#222 Early 1913 Right Front Fender \$410.00  
 #223 Early 1913 Left Front Fender \$410.00

1909-12 Fenders have round head rivets.  
 1913-16 Fenders have oval head rivets.  
 See Page #30

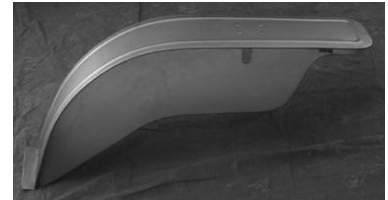

#228 1913 Hack Right Rear Fender \$410.00  
 #229 1913 Hack Left Rear Fender \$410.00



#224 Late 1913 Right Front Fender \$410.00  
 #225 Late 1913 Left Front Fender \$410.00

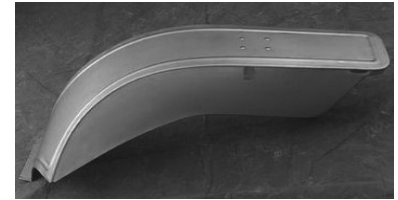

#226 1913 Touring & Roadster Right Rear \$410.00  
 #227 1913 Touring & Roadster Left Rear \$410.00

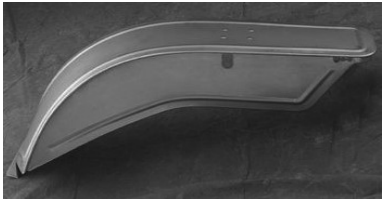

#232 1914 Touring & Roadster Right Rear \$410.00  
 #233 1914 Touring & Roadster Left Rear \$410.00

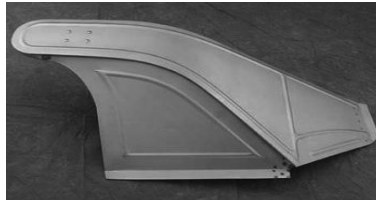

#230 1914 Right Front Fender \$410.00  
 #231 1914 Left Front Fender \$410.00

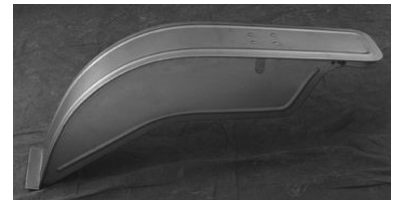

#234 1914 Hack Right Rear Fender \$410.00  
 #235 1914 Hack Left Rear Fender \$410.00



#236 1915-16 Right Front Fender \$410.00  
 #237 1915-16 Left Front Fender \$410.00

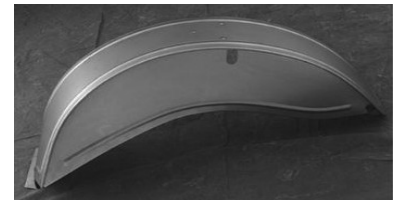

#238 1915-16 Touring & Roadster Right Rear \$410.00  
 #239 1915-16 Touring & Roadster Left Rear \$410.00



#240 1915-16 Center Door Right Rear \$470.00  
 #241 1915-16 Center Door Left Rear \$470.00

**No Brackets**

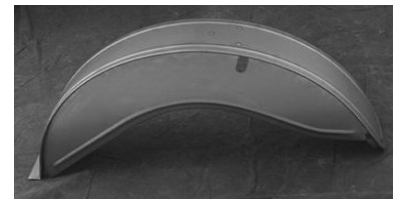

#242 1915-16 Hack Right Rear Fender \$410.00  
 #243 1915-16 Hack Left Rear Fender \$410.00



#244 1917-23 Passenger Right Front \$585.00  
 #245 1917-23 Passenger Left Front \$585.00

**No Brackets**

Southern wide track  
 and Canadian fenders  
 available. Call or write  
 for information.

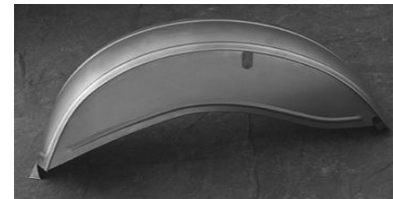

#246 1917-25 Touring & Roadster Right Rear \$450.00  
 #247 1917-25 Touring & Roadster Left Rear \$450.00

**No Brackets**

# Ford Model T Fenders

Fine quality fenders made of same gauge metal as originals. Mounting holes are not punched to enable you to align the fender with the holes on your frame, aprons and running boards. The headlight mounting holes are punched and the offset area is die-stamped into the fender skirt. If your fenders do not have an offset, please advise and we will make your fenders without an offset.

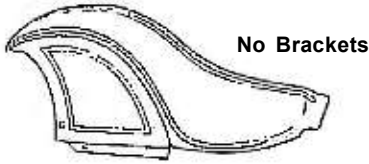

- #248 1917-23 Commercial Right Front \$585.00
- #249 1917-23 Commercial Left Front \$585.00

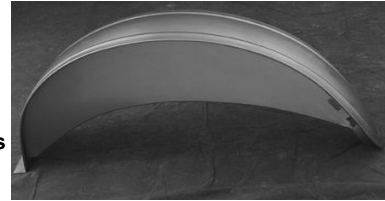

- #250 1917-25 Hack Right Rear Fender \$450.00
- #251 1917-25 Hack Left Rear Fender \$450.00

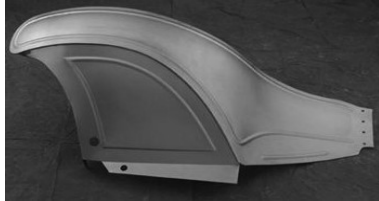

- #252 1924-25 Passenger Right Front \$585.00
- #253 1924-25 Passenger Left Front \$585.00

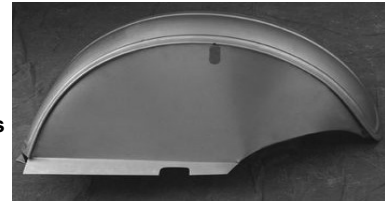

- #254 1924-25 Coupe Right Rear \$545.00
- #255 1924-25 Coupe Left Rear \$545.00

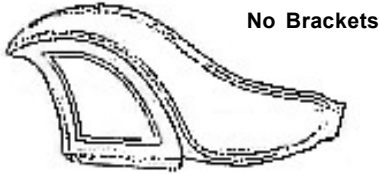

- #256 1924-25 Commercial Right Front \$585.00
- #257 1924-25 Commercial Left Front \$585.00
- Fits 1924-27 TT Truck

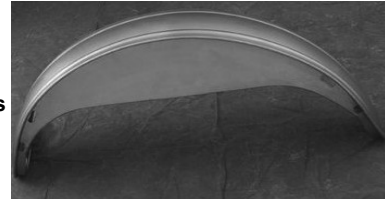

- #258 1917-25 TT Truck Right Rear \$465.00
- #259 1917-25 TT Truck Left Rear \$465.00



- #260 1925 Sedan Right Rear Fender \$650.00
- #261 1925 Sedan Left Rear Fender \$650.00



- #264 1926-27 Right Front Fender \$675.00
- #265 1926-27 Left Front Fender \$675.00

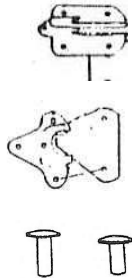

- Fender Brackets**
- #270 1909-14 Fender Brackets w/reinforcement pads & rivets \$10.00  
Specify round or oval.
  - #271 1915-16 Fender Brackets w/reinforcement pads & rivets \$10.00
  - #272 1909-12 Round Fender Rivets \$0.15
  - #273 1913-26 Oval Fender Rivets \$0.15

## Model T Engine Pans

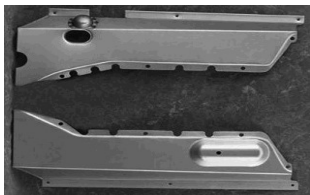

#EP330 1909-11 \$220.00



#EP332 1912-14 \$220.00



#EP334 1915-18 \$220.00

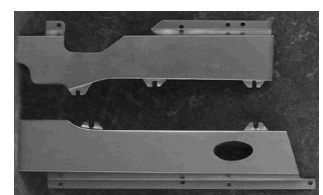

#EP336 1919-27 \$195.00

# Ford Model T Splash Aprons

Quality splash aprons for all Model T's  
Same gauge as originals with the correct  
contours and holes on all models.

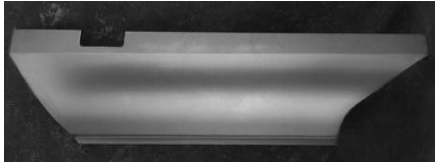

#300 Early 1909 Splash Aprons \$165.00

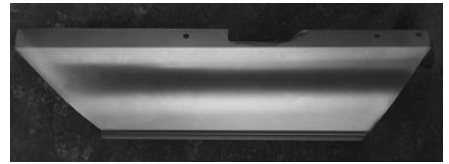

#302 1909-10 Splash Aprons \$165.00

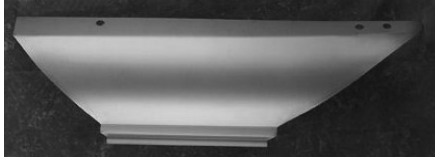

#304 1910-11 Torpedo Splash Aprons \$180.00



#306 1911 Splash Aprons w/bulge \$445.00



#308 1912-14 Splash Aprons \$205.00

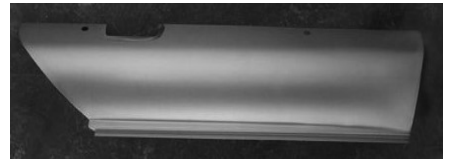

#310 1915-16 Splash Aprons \$205.00

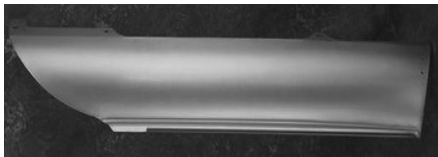

#312 1917-25 Touring & Roadster Aprons \$245.00

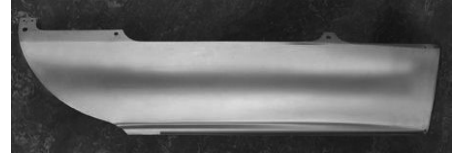

#313 1917-25 Hack Splash Aprons \$245.00



#314 1917-23 Sedan Splash Aprons \$230.00

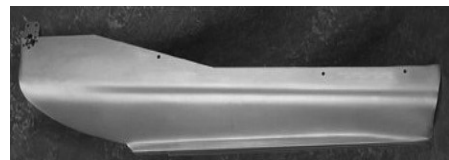

#315 1924-25 Sedan Splash Aprons \$230.00

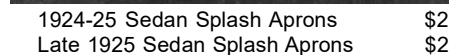

#316 Late 1925 Sedan Splash Aprons \$230.00



#318 1926-27 Stock Splash Aprons \$245.00

#320 1926-27 Louvered Splash Aprons \$355.00

## Ford 1928-29 Splash Aprons



#440 1928-29 Splash Aprons No Bulge \$245.00

#440A 1928-29 Splash Aprons w/Bulge \$320.00



#441 1928-29 Louvered Aprons No Bulge \$355.00

#442 1928-29 1 Scoop Aprons No Bulge \$565.00



#443 1928-29 AA Truck Aprons 96" long \$315.00

## Ford Model T Running Boards

Superior running boards made from the only set of Ford blueprint dies. Same gauge metal as the originals. Accurate sharp script and diamond pattern and the contour and the shapes of the holes on the ends are exactly as the originals with the edges folded. Running boards are only sold in pairs.



#352 1909 Running Boards \$215.00

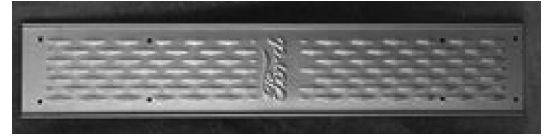

#358 1913-25 Running Boards \$360.00

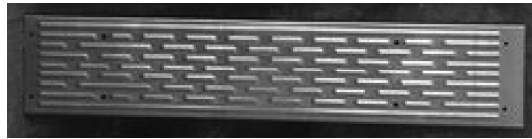

#354 1910 Running Boards \$215.00

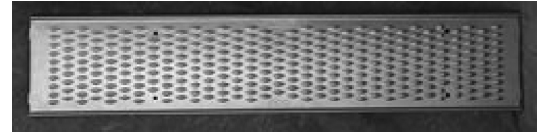

#360 1926-27 Running Boards \$360.00

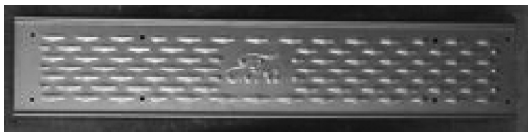

#356 1911-12 Running Boards \$360.00

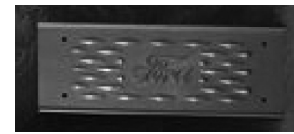

#350 1910-11 Torpedo Boards \$315.00

## Ford Model A Running Boards

Finest quality Model A running boards made from the original Ford blueprint dies. Same gauge metal as the originals. Edges are folded and the holes and contours are exactly as the originals. The diamond pattern on the commercial boards is sharp and even. On the 1928-29 running boards the script is sharp and clear and the tops are genuine rubber molded. The 1931 passenger boards are vulcanized with genuine rubber at 250 pounds of pressure at 350 degree heat with the rubber protruding through the holes on the bottom. The passenger boards have zinc molding strips included.

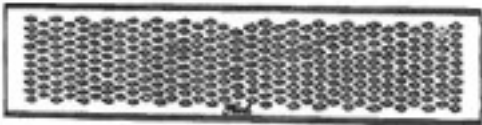

#362 1928-29 Commercial Boards \$490.00

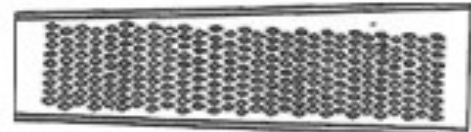

#366 1930-31 Commercial Boards \$340.00

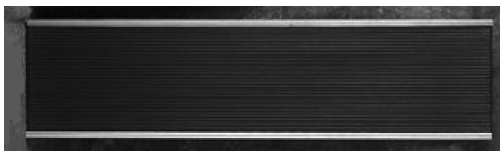

#364 1928-29 Passenger w/rubber \$370.00



#368 1931 Passenger w/rubber \$715.00

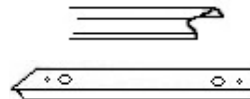

#371 1928-29 Molding (8 pc set) \$90.00

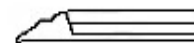

#377 1930-31 Molding (Pair) \$30.00

## Body to Top Brackets



#TB60



#TB64



#TB66



#TB78



#TB85



#TB50

#TB60	1912 Touring Front Extension	\$45.00	#TB78	1912 Touring Back Extension	\$45.00
#TB64	1912 Touring & Roadster Front Extension	\$45.00	#TB85	1911-12 Roadster Front Extension	\$45.00
#TB66	1911 Touring & Roadster Front Extension	\$45.00	#TB50	Hand Brake Cam	\$45.00

## Body Brackets



#1010



#1011



#1207

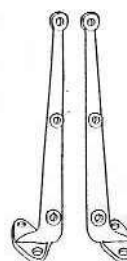

#1432

#1010	1909 Firewall to Body Bracket	\$15.00
#1011	1909-16 Body to Frame Brackets	\$20.00
#1207	1910-11 Torpedo From Frame to Body Bracket	\$15.00
#1432	1911-14 Frame to Firewall Brackets	\$80.00

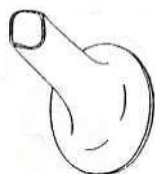

#1428 1910-11 Torpedo Steering Column Flange-Brass \$70.00

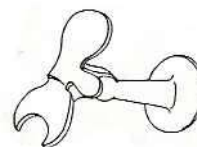

#1440 1909-12 Stewart Clock Speedometer Combo Dash Mounting Bracket \$100.00

## Top Bows

Steam bent oak top bows with hand finished ends ready to install in your sockets.

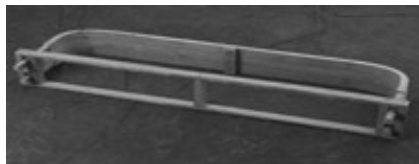

#TB 1909-17 Roadster Top Bows \$225.00

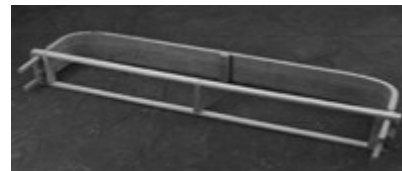

#TB 1909-17 Touring Top Bows \$300.00

Need to state year desired.

# Accessory Parts



1909-10 466 Headlight



1911-12 666 Headlight

- #L101 1909-10 E&J #466 Headlight \$350.00 each
- #L102 1911-12 E&J #666 Headlight \$350.00 each
- #L466 1909-10 Set of Five Lights \$1,725.00
- #L666 1911-12 Set of Five Lights \$1,725.00



#L103 1909-12 E&J Cowl Light \$350.00 each



#L104 1909-12 E&J Tail Light \$350.00 each



#L100T 1910-11 Torpedo Cowl Lamp Bracket (pair) \$70.00



#L100B 1911-14 Cowl Light Bracket (pair) \$20.00

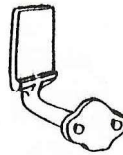

- #L100R 1909-12 Touring & Roadster Tail Light Bracket \$35.00 each
- #L100S 1913-14 Touring Tail Light Bracket \$35.00 each

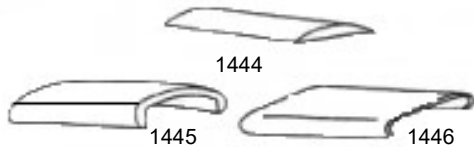

- #1444 1909-10 Solid Brass Dash Molding \$100.00
- #1445 1911-12 Solid Brass Dash Molding \$100.00
- #1446 1912-14 Solid Brass Dash Molding \$100.00



- #847 1909-10 Flat Tube Brass Radiator State Year Desired \$1,295.00
- #848 1911-16 Flat Tube Brass Radiator State Year Desired \$1,200.00

# Model T Windshield

1909-12 Replacement Windshields (No Glass)  
Includes Frame, Hinges and Brass Rods

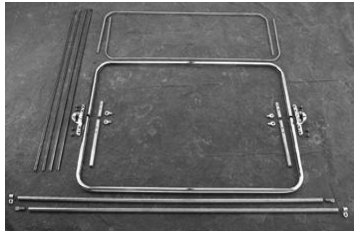
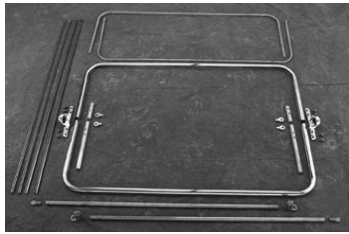

1910-11 Torpedo 41 1/2" x 13 3/4"  
1909-12 Touring  
Top 41 1/2" x 12 3/4"  
Bottom 41 1/2" x 14 3/4"

<b>1410 TORP</b>	<b>1910-11 Torpedo Complete Windshield</b>	<b>\$795.00</b>
1411 TORP	1910-11 Torpedo Windshield Frame Only	\$485.00
1412 TORP	1910-11 Torpedo Windshield Hinges Only (pair)	\$85.00
1413 TORP	1910-11 Torpedo Windshield Rods	\$195.00
1415 TORP	1910-11 Deflector	\$30.00
<b>1410</b>	<b>1912 Complete Windshield</b>	<b>\$760.00</b>
1411	1912 Windshield Frame Only	\$485.00
1412	1912 Windshield Hinges Only (pair)	\$85.00
1413	1912 Windshield Rods	\$160.00
1415	1912 Deflector	\$30.00



#1416



#1417



#1418



#1419

#1416	1911 Torpedo Windshield Support Brackets	\$60.00
#1417	1909-11 2 pc Dash to Windshield Brackets (set of 4)	\$45.00
#1418	1909-11 2 pc Dash Brackets (set of 5)	\$25.00
#1419	1912-14 1 pc Dash to Windshield Brackets (set of 4)	\$25.00

## Top Accessory Parts Available

1909-17 Top Bows  
1909-17 Top Sockets  
1909-1912 Inside Body Top Irons  
Please inquire about the above items

## Gas Tanks



1910-11 Torpedo Gas Tank



1911-12 Gas Tank



1912-13 Round Gas Tank



1913-20 Round Gas Tank



1920-26 Oval Gas Tank

#GT910	1909-10 Gas Tank (End Outlet)	\$200.00	
#GT1112	1911-12 Gas Tank w/attached Sediment Bowl	\$245.00	
#GT1213	1912-13 Gas Tank (Center Outlet)	\$200.00	
#GT1320	1913-20 Gas Tank (10 gallon Round)	\$180.00	28" L x 10 5/8" W
#GT1320B	1913-20 Gas Tank Mounting Brackets	\$30.00	
#GT2026	1920-26 Gas Tank (10 gallon Oval)	\$180.00	28" L x 13" W x 8 3/4" H
#GT2026B	1920-26 Gas Tank Mounting Brackets	\$30.00	
#GT11	1911 Torpedo Gas Tank & Cap w/attached Feet (16 gallon Round)	\$310.00	26" L x 14 1/4" W x 15 1/2" H
#GT12	1912 Torpedo Gas Tank & Cap	\$285.00	
#GT12S	1912 Torpedo Saddles & Straps	\$125.00	

No Ford Script  
Made w/galvanized steel

## Model T Speedster Kit

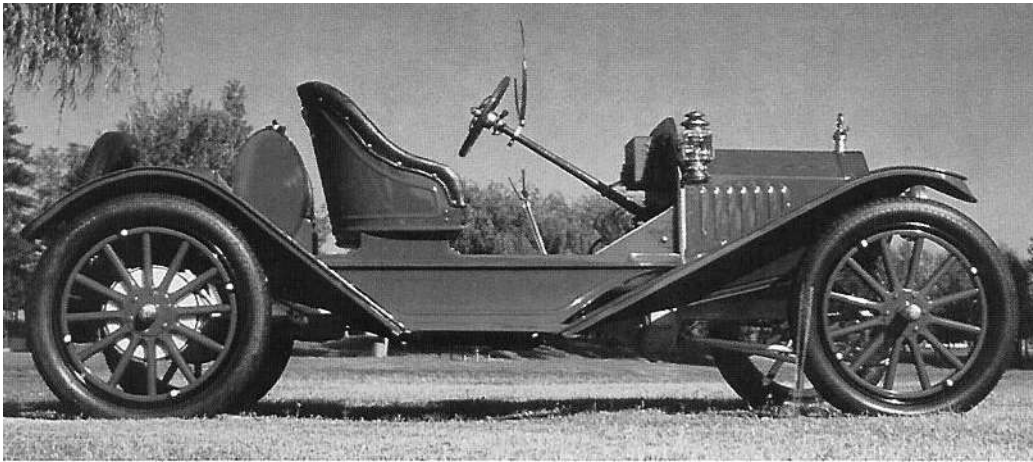

Curved Fender



Straight Fender

A speedster of classic design and elegance! A speedster that will provide you with hours of enjoyment as well as being an excellent investment. The T Speedster is easy to assemble, even for a beginner. You will need to provide your own chassis and running gear. The kit is designed to fit perfectly on any 1909 to 1925 chassis. For a low, racy look as shown in the above picture, use a dropped axle and lowered rear cross-member. Choose either the curved top or flat top special speedster fenders (as shown) with a free floating skirt. The Torpedo style hood gives a longer look and provides more ventilation. Use a monacle windshield as shown, or order a straight top fire-wall to use with a stock windshield. If you prefer a standard type speedster, use a stock axle and cross-member with our T Speedster body kit. Add your choice of early Model T stock fenders with corresponding splash aprons and running boards. You will have a speedster with a very pleasing design and proportion. Your own creativity will add the distinctive finishing touches. Complete speedster kit available as shown on the opposite page.

Shipped by Truck



# Model T Speedster Kit

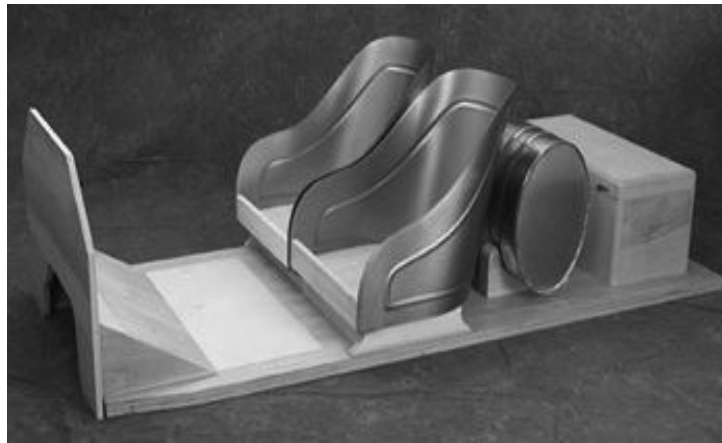

**Tool Box**  
12" high  
12" wide  
27 1/2" long



#817 - T Speedster Hood

**Seats**  
27 1/4" High  
17 7/8" Wide  
17 3/4" Deep

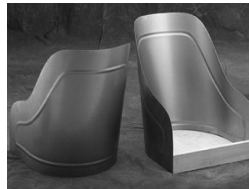

#815 - T Speedster Seat Skins

**Gas Tank**  
16 5/8" High  
10 1/4" wide  
28 1/4" long  
12-13 gallons



#814 - T Speedster Gas Tank  
#813 - T Speedster Tank Blocks  
#827 - T Speedster Brass Tank Straps  
#828 - T Speedster Brass Filler Neck  
#829 - T Speedster Lower Gas Outlet

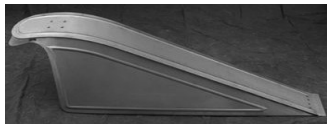

#818 - T Speedster Curved Front Fender



#818 - T Speedster Curved Rear Fender



#821 - T Speedster Splash Aprons

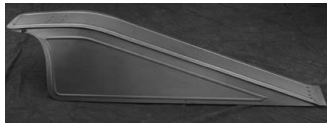

#819 - T Speedster Straight Front Fender

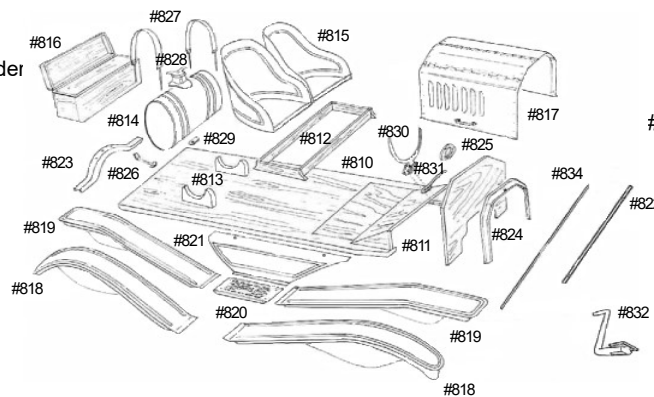

#820 - T Speedster Running Boards

#800 Complete T Speedster Kit (Includes #810-835) \$6,115.00  
#805 Body Kit Only (Includes #810-816) \$2,025.00

#810	Deck, Floorboards & Riser	\$715.00	#823	Rear Crossmember 2" drop	\$90.00
#811	Firewall	\$100.00	#824	Hood Former	\$230.00
#812	Seat Riser 18"	\$170.00	#825	Steering Column Wedge	\$30.00
#813	Tank Blocks	\$80.00	#826	Tail Light Bracket	\$75.00
#814	Gas Tank	\$275.00	#827	Brass Tank Straps 28 3/4"	\$95.00
#815	Seat Skins w/Wood Base & 3/4" Molding	\$285.00	#828	Brass Filler Neck	\$225.00
#816	Tool Box (No Hardware)	\$400.00	#829	Brass Lower Gas Outlet	\$20.00
#817	Hood	\$425.00	#830	Brass Windshield Monocle	\$275.00
#818	Curved Fenders (Set of 4)	\$1525.00	#831	Steering Column Bracket	\$90.00
#819	Straight Fenders (Set of 4)	\$1525.00	#832	Rear Fender Brackets (pair)	\$50.00
#820	Running Boards 8" x 21 3/8"	\$315.00	#833	Wooden Hood Shelves	\$80.00
#821	Splash Aprons	\$190.00	#834	Brass Dash Molding 79 1/4" long	\$150.00
#822	Brass Floor Molding 6-5' strips 3/4" x 1/4" x 60"	\$150.00	#835	Aluminum Seat Molding	\$75.00

## Model A Speedster Kit

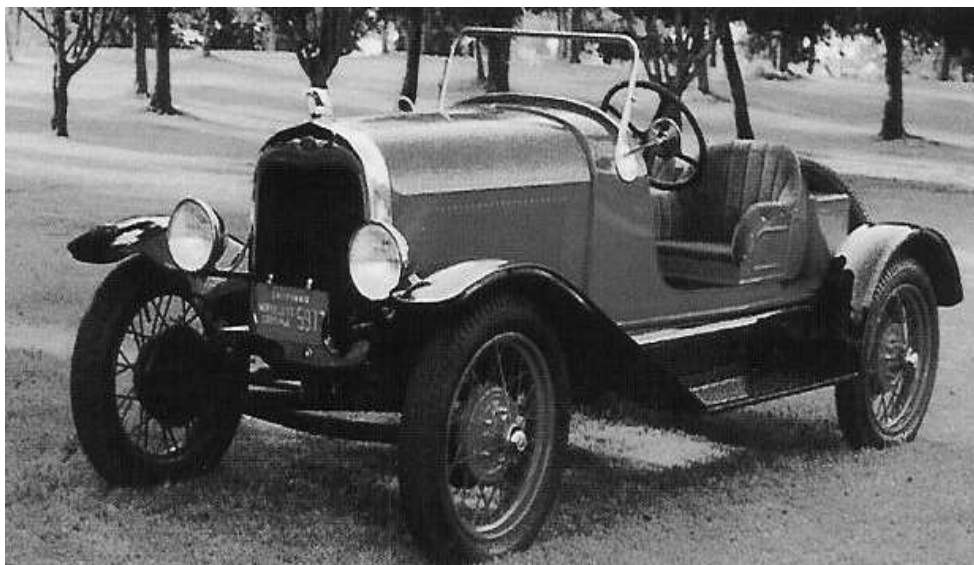

For those who prefer the open wheel style of the dirt-track racers, so popular in the 1920's & 1930's, we offer the Model A body kit. With its lean and racy look it draws attention everywhere it goes. The best racer body in terms of ease of construction, ease on pocketbook, and most important-it will give you the satisfaction of building a car you can be proud of. Full assembly instructions now come with the body, making it perfect for the beginning enthusiast.

Order now, so you will be ready to spend the next season with the wind in your hair and the crisp note of the exhaust in your ear.

Shipped by Truck

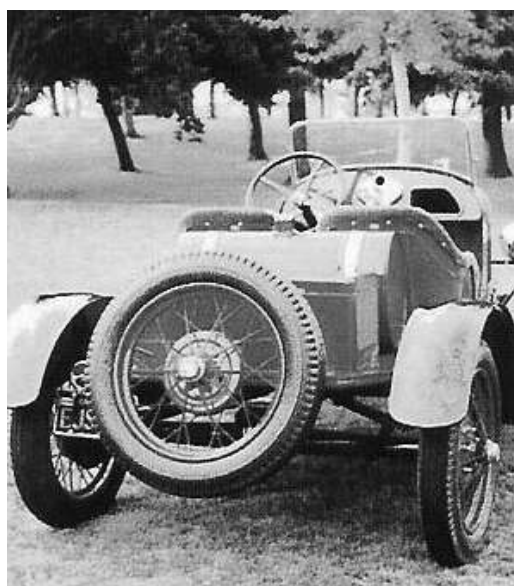

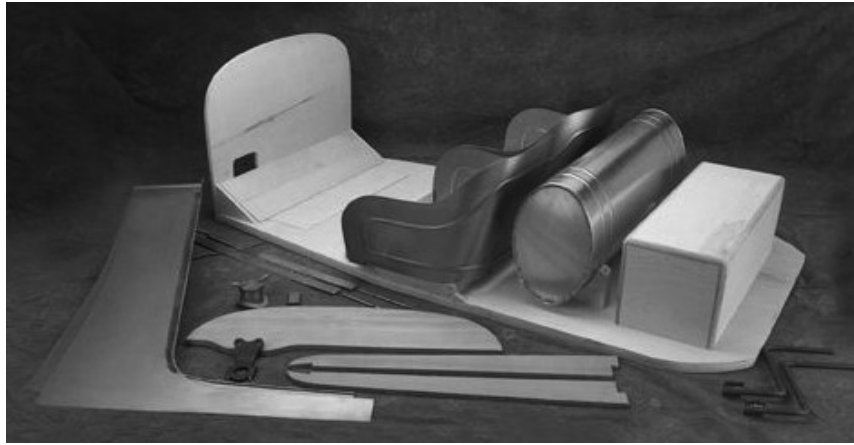

**Seats**  
 20 1/4" Wide  
 18" High  
 17 3/4" Deep

**Gas Tank**  
 35 5/8" Wide  
 16 5/8" High  
 10 1/8" Side  
 15-16 Gallons



#951 - A Speedster Hood

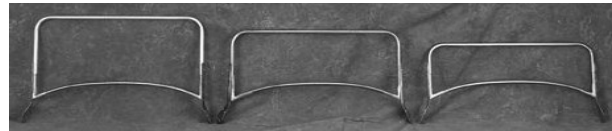

#970 - A Speedster 9 1/2" Tall Windshield Frame  
 #970A - A Speedster 12 1/2" Tall Windshield Frame  
 #970B - A Speedster 15 1/2" Tall Winshield Frame



#966 - A Speedster Front Fender

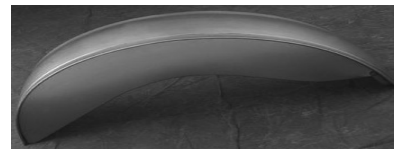

#967 - A Speedster Rear Fender

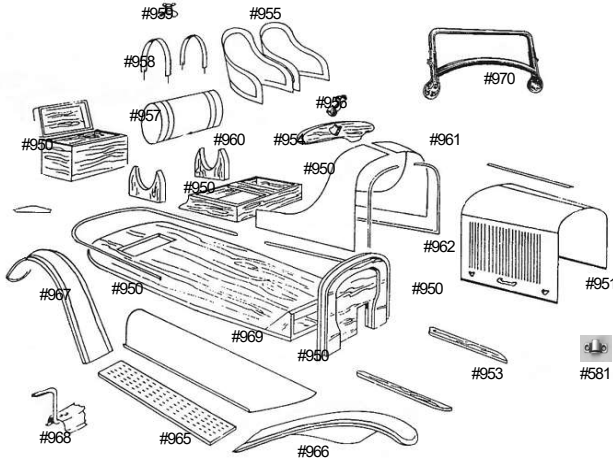

#900 Model A Speedster Kit Complete  
 (Includes Parts #950-970) \$7020.00

#905 Model A Body Kit Only  
 (Includes Parts #950-962) \$3735.00

Free Color Brochure Upon Request

#950 Deck, Floorboards & Risers, Seat Risers, Tank Blocks, Fire-wall & Tool Box \$1,610.00

#951	Hood	\$550.00	#961	Metal Cowl	\$200.00
#581	Center Hinge Bracket (2 Needed)	\$25.00	#962	3/4" Molding (36 feet)	\$175.00
#953	Hood Blocks (pair)	\$80.00	#965	Running Boards	\$490.00
#954	Dash	\$95.00	#966	Front Fenders (pair)	\$1140.00
#955	Seat Skins w/Wood Base & 3/4" Molding	\$285.00	#967	Rear Fenders (pair)	\$890.00
#956	Steering Column Bracket	\$75.00	#968	Rear Fender Brackets (pair)	\$60.00
#957	Gas Tank	\$275.00	#969	Splash Aprons	\$205.00
#958	Tank Straps	\$95.00	#970	9 1/2" Tall Windshield Frame	\$500.00
#959	Brass Filler Neck	\$225.00	#970A	12 1/2" Tall Windshield Frame	\$500.00
#960	Brass Lower Gas Outlet	\$20.00	#970B	15 1/2" Tall Windshield Frame	\$500.00

# Chevrolet 1931-35 Hood Measurements

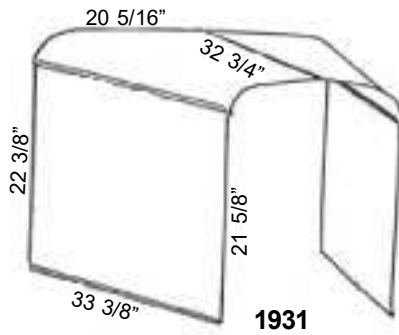

**1931**

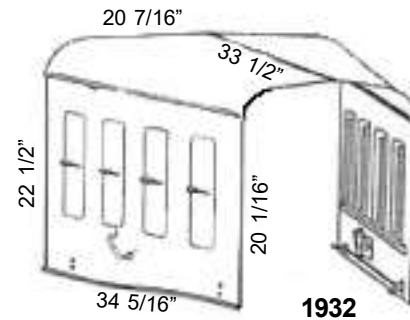

**1932**

Top width measurements of hoods shown below are from the bottom of the belt line to the center line of the hinge.

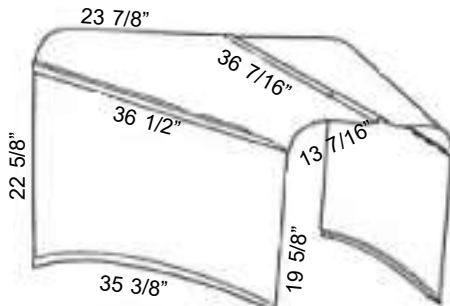

**1933 Master**

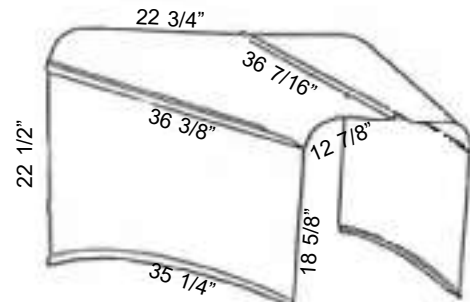

**1933 Mercury**

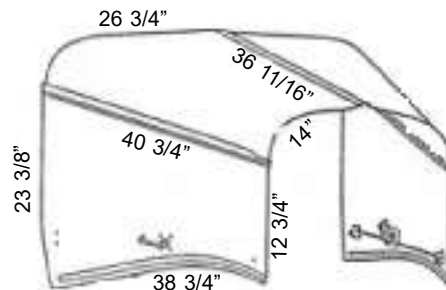

**1934-35 Standard**

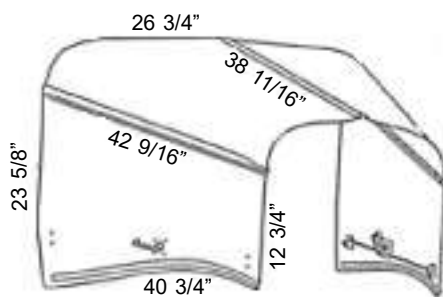

**1934 Master**

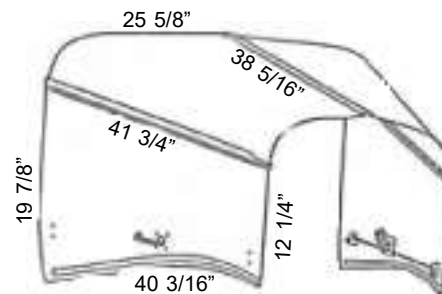

**1935 Master**

# Chevrolet 1931 4 Pc Hoods

Fine quality 1931 Chevrolet hoods. Styles available as shown. No stock louvers available.  
Prices are without handles and clips and are not available.

1928-30 Chevrolet hoods are available.  
Please inquire

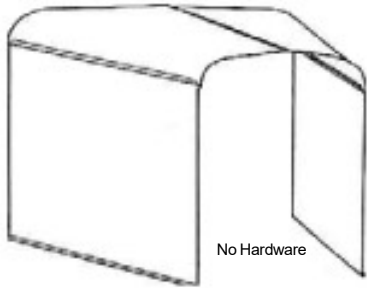

No Hardware

- #9300 1931 Plain Tops/Plain Sides \$620.00
- #9301 1931 Pair Plain Tops Only \$320.00
- #9302 1931 Pair Plain Sides Only \$320.00

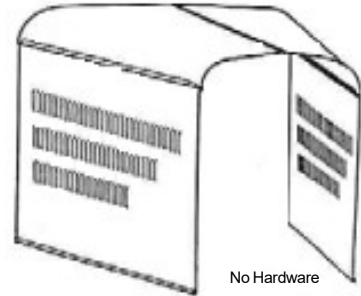

No Hardware

- #9315 1931 Plain Tops/3 Row Sides \$620.00
- #9316 1931 Pair 3 Row Sides Only \$320.00
- #9317 1931 3 Row Tops/3 Row Sides \$770.00
- #9318 1931 Pair 3 Row Tops Only \$470.00

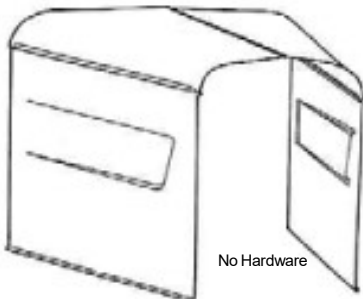

No Hardware

- #9305 1931 Plain Tops/1 Scoop Sides \$920.00
- #9306 1931 Pair 1 Scoop Sides Only \$620.00

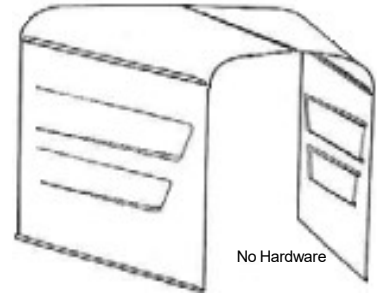

No Hardware

- #9310 1931 Plain Tops/2 Scoop Sides \$1220.00
- #9311 1931 Pair 2 Scoop Sides \$920.00

# Chevrolet 1931 3 Pc Hoods

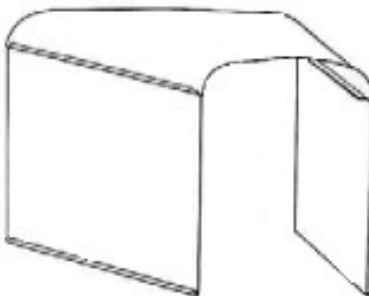

- #9320 1931 Plain Top/Plain Sides \$595.00
- #9321 1931 Plain Top Only \$365.00
- #9322 1931 Pair Plain Sides only \$250.00

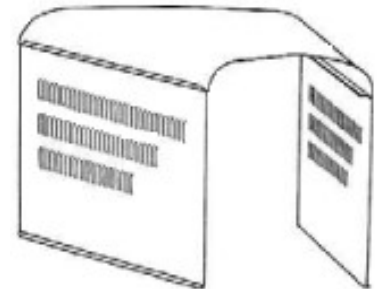

- #9325 1931 Plain Top/3 Row Sides \$595.00
- #9326 1931 Pair 3 Row Sides Only \$250.00
- #9327 1931 4 Row Top/3 Row Sides \$695.00
- #9328 1931 4 Row Top Only \$465.00
- #9327A 1931 6 Row Top/3 Row Sides \$695.00
- #9328A 1931 6 Row Top Only \$515.00

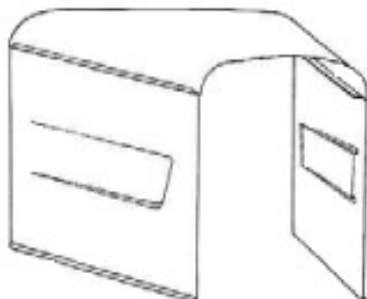

- #9330 1931 Plain Top/1 Scoop Sides \$895.00
- #9331 1931 Pair 1 Scoop Sides Only \$550.00

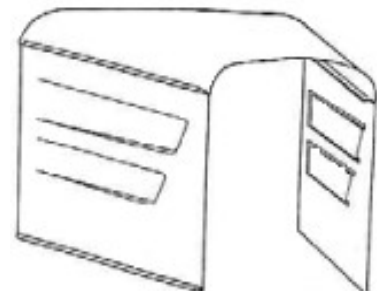

- #9335 1931 Plain Tops/2 Scoop Sides \$1195.00
- #9336 1931 Pair 2 Scoop Sides Only \$810.00

# Chevrolet 1932 4 Pc Hoods

Prices shown do not include latching hardware. If hardware is needed add \$150.00  
 Stock 1932 hood doors in cold rolled steel and polished stainless steel are available.

Chrome spears are available.

For 1932 Ford style center hinge add \$25.00

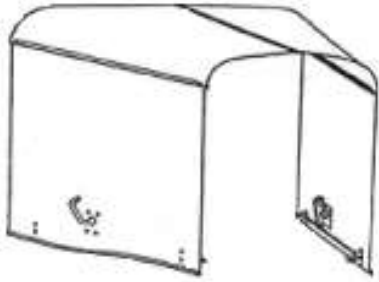

- #9400 1932 Plain Tops/Plain Sides \$760.00
- #9401 1932 Pair Plain Tops Only \$390.00
- #9402 1932 Pair Plain Sides Only \$390.00

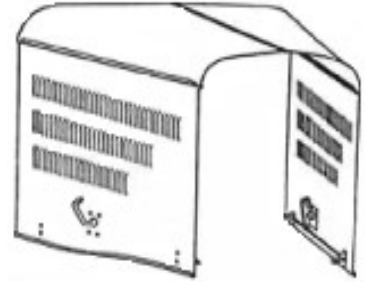

- #9405 1932 Plain Tops/3 Row Sides \$760.00
- #9406 1932 Pair 3 Row Sides Only \$390.00
- #9407 1932 3 Row Tops/3 Row Sides \$910.00
- #9408 1932 Pair 3 Row Tops Only \$540.00



- #9410 1932 Plain Tops/4 Steel Door Sides \$2160.00
- #9411 1932 Pair 4 Steel Door Sides Only \$2160.00
- #9410A 1932 Plain Tops/4 Stainless Door Sides \$2260.00

Hardware not shown in picture. Price includes hardware.

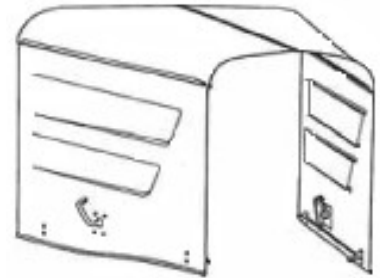

- #9415 1932 Plain Tops/1 Scoop Sides \$1060.00
- #9416 1932 Pair 1 Scoop Sides Only \$690.00

- #9420 1932 Plain Tops/2 Scoop Sides \$1360.00
- #9421 1932 Pair 2 Scoop Sides Only \$990.00

# Chevrolet 1932 3 Pc Hoods

A vareity of 1932 hoods available as shown.

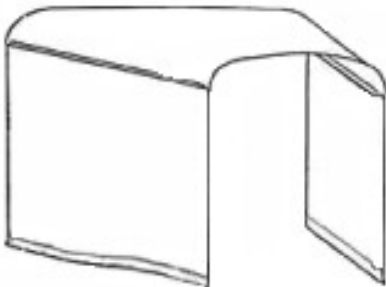

- #9425 1932 Plain Top/Plain Sides \$715.00
- #9426 1932 Plain Top Only \$405.00
- #9427 1932 Pair Plain Sides Only \$330.00



- #9430 1932 Plain Top/3 Row Sides \$715.00
- #9431 1932 Pair 3 Row Sides Only \$330.00
- #9432 1932 4 Row Top/3 Row Sides \$715.00
- #9432A 1932 6 Row Top/3 Row Sides \$865.00
- #9433 1932 4 Row Top Only \$505.00
- #9433A 1932 6 Row Top Only \$555.00

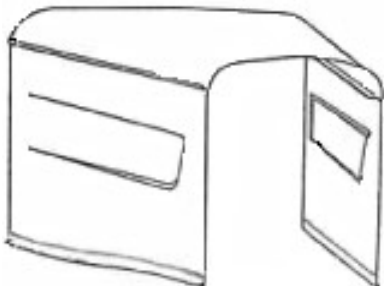

- #9445 1932 Plain Top/1 Scoop Sides \$1015.00
- #9446 1932 Pair 1 Scoop Sides Only \$630.00



- #9447 1932 Plain Top/2 Scoop Sides \$1315.00
- #9448 1932 Pair 2 Scoop Sides Only \$930.00

# Chevrolet 1933 4 Pc Hoods

Fine quality 1933 Chevrolet hoods.  
 Available in Master and Mercury styles with a 1932 Ford Center Hinge.  
 No stock louvers or hardware are available.  
 Two front hold down clips on page #14

Other styles of 1933 Chevrolet hoods available if patterns are furnished.

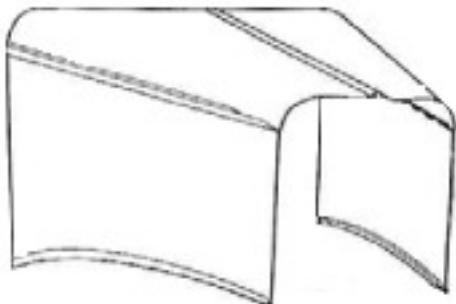

- #9450 1933 Master Plain Top/Plain Sides \$950.00
- #9451 1933 Master Plain Tops Only \$560.00
- #9452 1933 Master Pair Plain Sides Only \$410.00

- #9455 1933 Mercury Plain Tops/Plain Sides \$950.00
- #9456 1933 Mercury Plain Tops Only \$560.00
- #9457 1933 Mercury Pair Plain Sides Only \$410.00

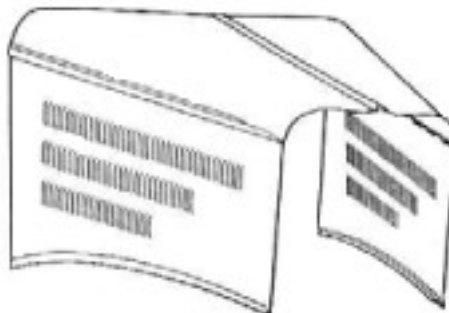

- #9460 1933 Master Plain Top/3 Row Sides \$950.00
- #9461 1933 Master Pair 3 Row Sides Only \$410.00
- #9462 1933 Master 3 Row Tops/3 Row Sides \$1100.00
- #9463 1933 Master 3 Row Tops Only \$710.00

- #9465 1933 Mercury Plain Tops/3 Row Sides \$950.00
- #9466 1933 Mercury Pair 3 Row Sides Only \$410.00
- #9467 1933 Mercury 3 Row Tops/3 Row Sides \$1100.00
- #9468 1933 Mercury 3 Row Tops Only \$710.00

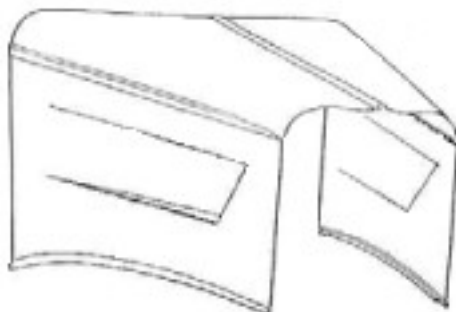

- #9470 1933 Master Plain Tops/1 Scoop Sides \$1250.00
- #9471 1933 Master Pair 1 Scoop Sides Only \$710.00
- #9473 1933 Mercury Plain Tops/1 Scoop Sides \$1250.00
- #9474 1933 Mercury Pair 1 Scoop Sides Only \$710.00

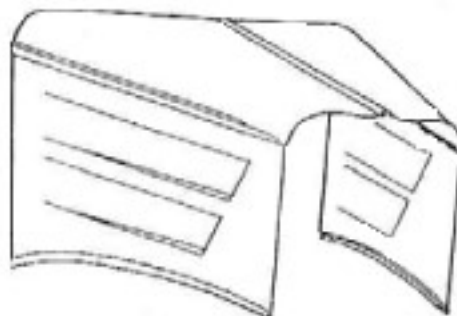

- #9475 1933 Master Plain Tops/2 Scoop Sides \$1550.00
- #9476 1933 Master Pair 2 Scoop Sides Only \$1010.00
- #9478 1933 Mercury Plain Tops/2 Scoop Sides \$1550.00
- #9479 1933 Mercury Pair 2 Scoop Sides Only \$1010.00

# Chevrolet 1933 3 Pc Hoods

A variety of 1933 3 piece hoods available in both Master and Mercury styles.

Shipped by Truck.

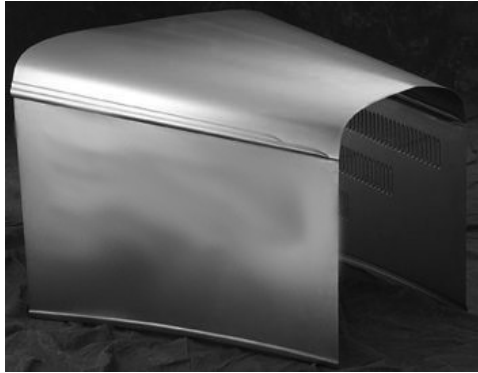

- #9480 1933 Master Plain Top/Plain Sides \$990.00
- #9480A 1933 Master Plain Top Only \$645.00
- #9480B 1933 Master Pair Plain Sides Only \$365.00

- #9485 1933 Master Plain Top/3 Row Sides \$990.00
- #9485A 1933 Master 3 Row Sides Only \$365.00
- #9486 1933 Master 6 Row Top/3 Row Sides \$1140.00
- #9486A 1933 Master 6 Row Top Only \$795.00

- #9481 1933 Mercury Plain Top/Plain Sides \$990.00
- #9481A 1933 Mercury Plain Top Only \$645.00
- #9481B 1933 Mercury Pair Plain Sides Only \$365.00

- #9488 1933 Mercury Plain Top/3 Row Sides \$990.00
- #9488A 1933 Mercury 3 Row Sides Only \$365.00
- #9489 1933 Mercury 6 Row Top/3 Row Sides \$1140.00
- #9489A 1933 Mercury 6 Row Top Only \$795.00

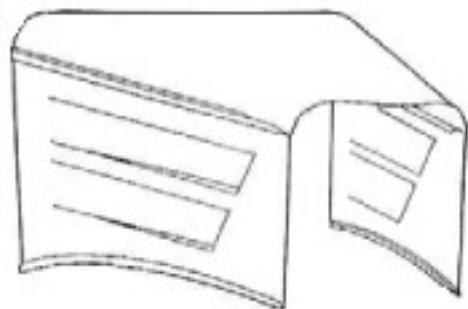
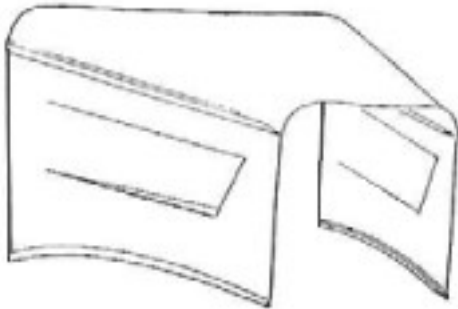

- #9495 1933 Master Plain Top/1 Scoop Sides \$1290.00
- #9495A 1933 Master Pair 1 Scoop Sides Only \$665.00
- #9496 1933 Mercury Plain Top/1 Scoop Sides \$1290.00
- #9496A 1933 Mercury Pair 1 Scoop Sides Only \$665.00

- #9490 1933 Master Plain Top/2 Scoop Sides \$1590.00
- #9490A 1933 Master Pair 2 Scoop Sides Only \$965.00
- #9491 1933 Mercury Plain Top/2 Scoop Sides \$1590.00
- #9491A 1933 Mercury Pair 2 Scoop Sides Only \$965.00



# Chevrolet 1934-35 4 Pc Hoods

Fine quality 1934-35 Chevrolet hoods.  
Available in Standard or Master styles with a 1932 Ford Center Hinge.

Two front hold down clips on page #14.

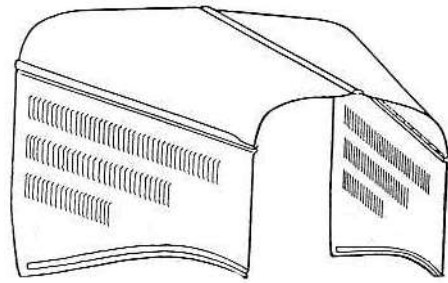
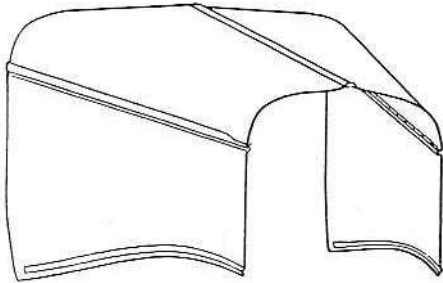

#9500	1934-35 Standard Plain Tops/Plain Sides	\$950.00
#9501	1934-35 Standard Plain Tops Only	\$560.00
#9502	1934-35 Standard Pair Plain Sides Only	\$410.00
#9505	1934 Master Plain Top/Plain Sides	\$950.00
#9506	1934 Master Plain Tops Only	\$560.00
#9507	1934 Master Pair Plain Sides Only	\$410.00
#9508	1935 Master Plain Tops/Plain Sides	\$950.00
#9509	1935 Master Plain Tops Only	\$560.00
#9509A	1935 Master Pair Plain Sides Only	\$410.00

#9510	1934-35 Standard Plain Tops/3 Row Sides	\$950.00
#9511	1934-35 Standard Pair 3 Row Sides Only	\$410.00
#9520	1934-35 Standard 3 Row Tops/3 Row Sides	\$1100.00
#9521	1934-35 Standard 3 Row Tops Only	\$710.00
#9515	1934 Master Plain Tops/3 Row Sides	\$950.00
#9516	1934 Master Pair 3 Row Sides Only	\$410.00
#9525	1934 Master 3 Row Tops/3 Row Sides	\$1100.00
#9526	1934 Master 3 Row Tops Only	\$710.00
#9517	1935 Master Plain Tops/3 Row Sides	\$950.00
#9518	1935 Master Pair 3 Row Sides Only	\$410.00
#9527	1935 Master 3 Row Tops/3 Row SideS	\$1100.00
#9528	1935 Master 3 Row Tops Only	\$710.00

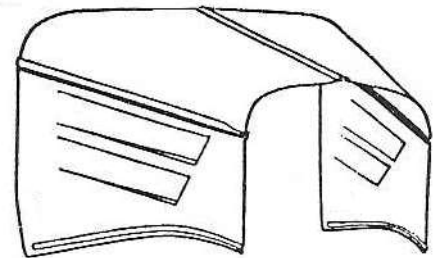
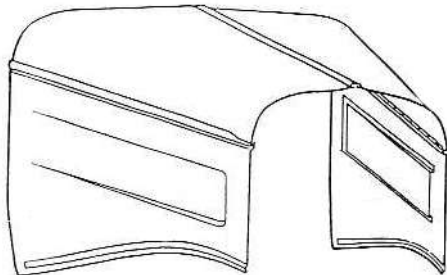

#9530	1934-35 Standard Plain Tops/1 Scoop Sides	\$1250.00
#9531	1934-35 Standard Pair 1 Scoop Sides Only	\$710.00
#9535	1934 Master Plain Tops/1 Scoop Sides	\$1250.00
#9536	1934 Master Pair 1 Scoop Sides Only	\$710.00
#9537	1935 Master Plain Tops/1 Scoop Sides	\$1250.00
#9538	1935 Master Pair 1 Scoop Sides Only	\$710.00

#9540	1934-35 Standard Plain Tops/2 Scoop Sides	\$1550.00
#9541	1934-35 Standard Pair 2 Scoop Sides Only	\$1010.00
#9545	1934 Master Plain Tops/2 Scoop Sides	\$1550.00
#9546	1934 Master Pair 2 Scoop Sides Only	\$1010.00
#9547	1935 Master Plain Tops/2 Scoop Sides	\$1550.00
#9548	1935 Master Pair 2 Scoop Sides Only	\$1010.00

#9549 1934-35 Stainless Center Hinge Molding \$35.00

# Chevrolet 1934-35 3 Pc Hoods

A variety of 3 Piece hoods for your 1934-35 Chevrolet.

Available in styles as shown.

Shipped by Truck.

1934-36 Pickup hoods available.  
Please Inquire.



- #9550 1934-35 Standard Plain Top/Plain Sides \$990.00
- #9551 1934-35 Standard Plain Top Only \$645.00
- #9552 1934-35 Standard Pair Plain Sides Only \$365.00

- #9555 1934 Master Plain Top/Plain Sides \$990.00
- #9556 1934 Master Plain Top Only \$645.00
- #9557 1934 Master Pair Plain Sides Only \$365.00

- #9558 1935 Master Plain Top/Plain Sides \$990.00
- #9559 1935 Master Plain Top Only \$645.00
- #9559A 1935 Master Pair Plain Sides Only \$365.00



- #9560 1934-35 Standard Plain Top/3 Row Sides \$990.00
- #9561 1934-35 Standard Pair 3 Row Sides Only \$365.00
- #9570 1934-35 Standard 6 Row Top/3 Row Sides \$1140.00
- #9571 1934-35 Standard 6 Row Top Only \$755.00

- #9565 1934 Master Plain Top/3 Row Sides \$990.00
- #9566 1934 Master Pair 3 Row Sides Only \$365.00
- #9575 1934 Master 6 Row Top/3 Row Sides \$1140.00
- #9576 1934 Master 6 Row Top Only \$755.00

- #9567 1935 Master Plain Top/3 Row Sides \$990.00
- #9568 1935 Master Pair 3 Row Sides Only \$365.00
- #9577 1935 Master 6 Row Top/3 Row Sides \$1140.00
- #9578 1935 Master 6 Row Top Only \$755.00



- #9580 1934-35 Standard Plain Top/1 Scoop Sides \$1290.00
- #9581 1934-35 Standard Pair 1 Scoop Sides Only \$665.00
- #9585 1934 Master Plain Top/1 Scoop Sides \$1290.00
- #9586 1934 Master Pair 1 Scoop Sides Only \$665.00
- #9587 1935 Master Plain Top/1 Scoop Sides \$1290.00
- #9588 1935 Master Pair 1 Scoop Sides \$665.00



- #9590 1934-35 Standard Plain Top/2 Scoop Sides \$1590.00
- #9591 1934-35 Standard Pair 2 Scoop Sides Only \$965.00
- #9595 1934 Master Plain Top/2 Scoop Sides \$1590.00
- #9596 1934 Master Pair 2 Scoop Sides Only \$965.00
- #9597 1935 Master Plain Top/2 Scoop Sides \$1590.00
- #9598 1935 Master Pair 2 Scoop Sides Only \$965.00

## Chevrolet 1936 3 Pc Hoods

3 Piece hoods for your 1936 Chevrolet.

Available in styles as shown.

Shipped by Truck.



#9750 1936 Plain Top/Plain Sides  
#9751 1936 Plain Top Only  
#9752 1936 Pair Plain Sides Only

\$990.00  
\$645.00  
\$365.00

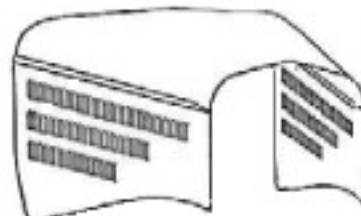

#9760 1936 Plain Top/3 Row Sides  
#9761 1936 Pair 3 Row Sides Only  
#9770 1936 3 Row Top/3 Row Sides  
#9771 1936 3 Row Top Only

\$990.00  
\$365.00  
\$1140.00  
\$755.00

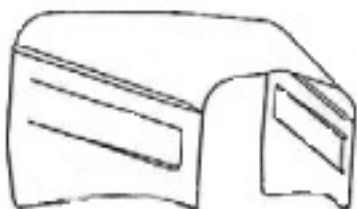

#9780 1936 Plain Top/1 Scoop Sides  
#9781 1936 Pair 1 Scoop Sides

\$1290.00  
\$665.00

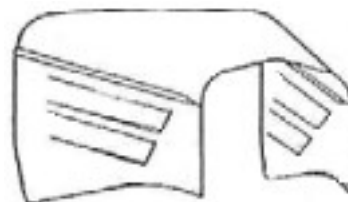

#9790 1936 Plain Top/2 Scoop Sides  
#9791 1936 Pair 2 Scoop Sides Only

\$1590.00  
\$965.00

## Chevrolet 1937 Hood Side Panels

Fine quality 1937 Chevrolet hood side panels.

Available in styles as shown.

No hardware.



#9600 1937 Pair Plain Sides Only \$410.00

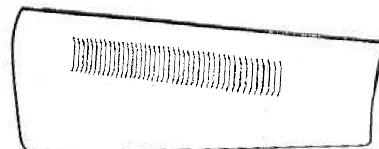

#9601 1937 Pair 1 Row Sides Only \$410.00



#9605 1937 Pair 1 Scoop Sides Only \$710.00

## Chevrolet 1938 Hood Side Panels

Fine quality 1938 Chevrolet hood side panels.

Available in styles as shown.

No hardware.

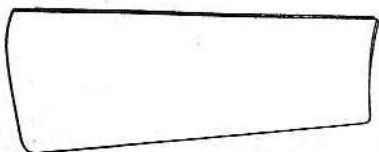

#9650 1938 Pair Plain Sides Only \$410.00



#9655 1938 Pair 1 Scoop Sides Only \$710.00

## Plymouth 1932 4 Pc Hood Sides

Finest quality side panels for 1932 PB Plymouth 4 piece hoods.

Top panels are not available.

Side panels with stock louvers or doors are not available.

No latching hardware.



#8302 1932 PB Plain Sides Only \$390.00

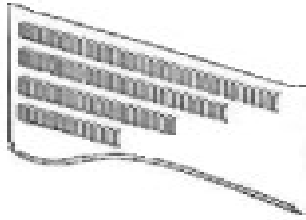

#8316 1932 PB 3 Row Sides Only \$390.00



#8306 1932 PB 1 Scoop Sides Only \$690.00

#8326 1932 PB 4 Row Sides Only \$390.00

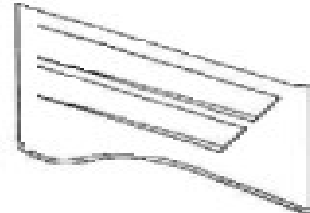

#8311 1932 PB 2 Scoop Sides Only \$990.00

## Plymouth 1932 3 Pc Hoods

When ordering a Plymouth hood specify the year and a beltline measurement is required.

Shipped by Truck.

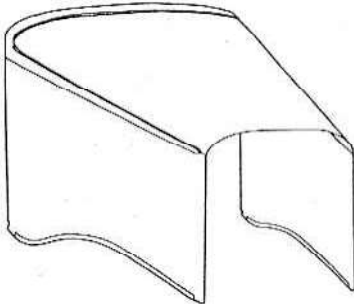

#8330 1932 PB Plain Top/Plain Sides \$715.00

#8331 1932 PB Plain Top Only \$405.00

#8332 1932 PB Pair Plain Sides Only \$330.00

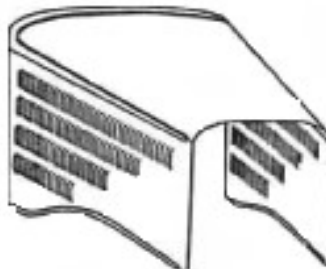

#8350 1932 PB Plain Top/4 Row Sides \$715.00

#8351 1932 PB Pair 4 Row Sides Only \$330.00

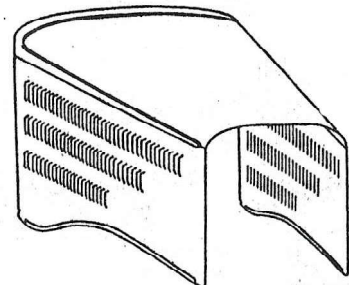

#8345 1932 PB Plain Top/3 Row Sides \$715.00

#8346 1932 PB Pair 3 Row Sides Only \$330.00

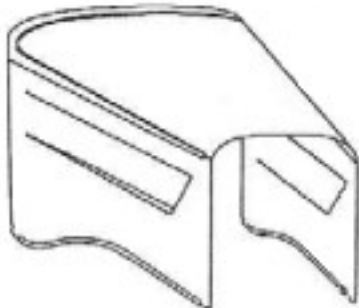

#8335 1932 PB Plain Top/1 Scoop Sides \$1015.00

#8336 1932 PB Pair 1 Scoop Sides Only \$630.00

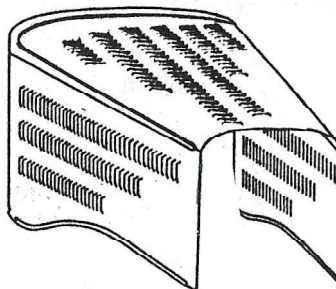

#8355 1932 PB 6 Row Top/3 Row Sides \$865.00

#8356 1932 PB 6 Row Top Only \$545.00

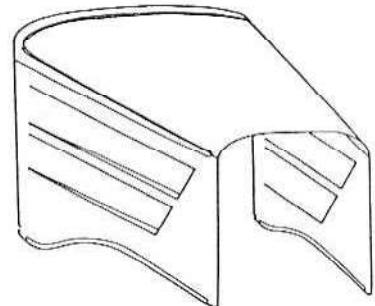

#8340 1932 PB Plain Top/2 Scoop Sides \$1,315.00

#8341 1932 PB Pair 2 Scoop Sides Only \$930.00

# Dodge/Plymouth 1933-34 4 Pc Hood Sides

A variety of side panel styles are available for 1933-34 Dodge/Plymouth 4 piece hoods.

Top panels are no longer available.  
 Side panels with stock louvers or doors are not available.  
 No latching hardware.



#8402 1933-34 Pair Plain Sides Only \$410.00

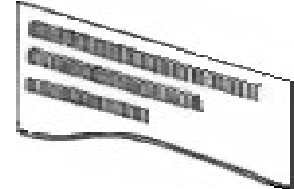

#8416 1933-34 Pair 3 Row Sides Only \$410.00



#8406 1933-34 Pair 1 Scoop Sides Only \$710.00

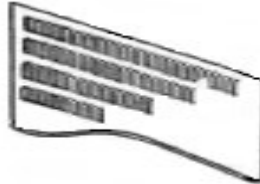

#8421 1933-34 Pair 4 Row Sides Only \$410.00



#8411 1933-34 Pair 2 Scoop Sides Only \$1010.00

**Make Sure to specify the year, make and belt-line measurement.**

# Dodge/Plymouth 1933-34 3 Pc Hoods

Fine quality 3 piece hoods to fit your 1933-34 Dodge/Plymouth.  
 For a 1934 Dodge with 50" belt-line add \$150.00 to the price.  
 Shipped by Truck.

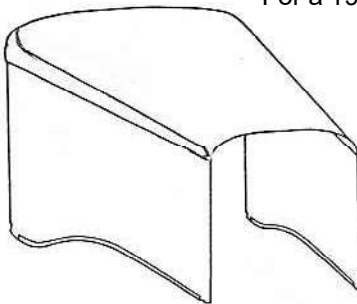

#8500 1933-34 Plain Top/Plain Sides \$990.00  
 #8501 1933-34 Plain Top Only \$645.00  
 #8502 1933-34 Pair Plain Sides Only \$365.00

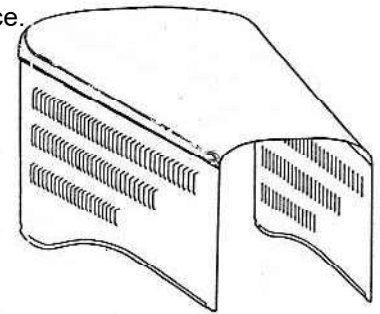

#8515 1933-34 Plain Top/3 Row Sides \$990.00  
 #8516 1933-34 Pair 3 Row Sides Only \$325.00  
 #8525 1933-34 6 Row Top/3 Row Sides \$1140.00  
 #8526 1933-34 6 Row Top Only \$790.00

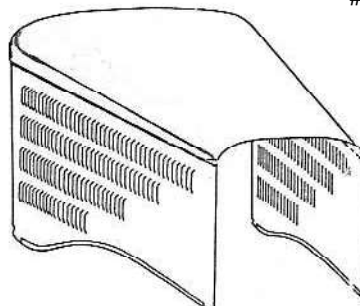

#8520 1933-34 Plain Top/4 Row Sides \$990.00  
 #8521 1933-34 Pair 4 Row Sides Only \$365.00

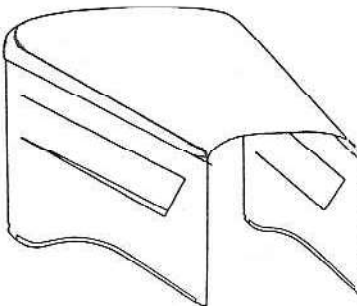

#8505 1933-34 Plain Top/1 Scoop Sides \$1290.00  
 #8506 1933-34 Pair 1 Scoop Sides Only \$665.00

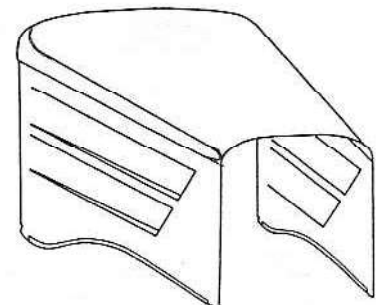

#8510 1933-34 Plain Top/2 Scoop Sides \$1590.00  
 #8511 1933-34 Pair 2 Scoop Sides Only \$965.00

## Dodge/Plymouth 1935-36 4 Pc Sides

Finest quality side panels to fit your 1935-36 Dodge or Plymouth stock tops.

Top panels are no longer available.

Stock side louvers not available.

When ordering your hood be sure to specify the year, the make and the belt-line measurements.

No hardware available.



#8602 1935-36 Pair Plain Sides Only \$410.00



#8611 1935-36 Pair 3 Row Sides Only \$410.00

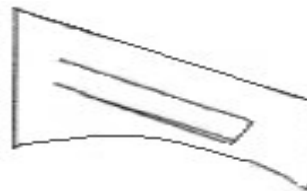

#8606 1935-36 Pair 1 Scoop Sides Only \$710.00

## Dodge/Plymouth 1935-36 3 Pc Hoods

3 Piece hoods to fit your 1935-36 Dodge or Plymouth.

Stock side louvers not available.

Specify if center panel is to be smooth or with a raised offset.

On the hoods listed below if 6 rows of louvers are desired, add \$250.00 to the listed price.

When ordering your hood be sure to specify the year, the make and the belt-line measurement.

Shipped by Truck.

See page #16 for Hinge and Latch information.



#8630 1935-36 Plain Top/Plain Sides \$990.00

#8631 1935-36 Plain Top Only \$645.00

#8632 1935-36 Pair Plain Sides Only \$365.00

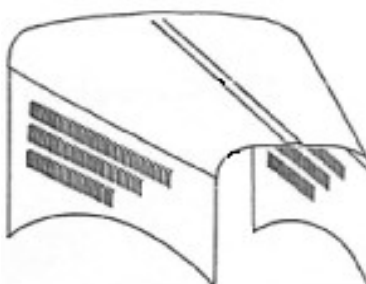

#8640 1935-36 Plain Top/3 Row Sides \$990.00

#8641 1935-36 Pair 3 Row Sides Only \$365.00



#8635 1935-36 Plain Top/1 Scoop Sides \$1290.00

#8636 1935-36 Pair 1 Scoop Sides Only \$665.00

## Important Measurements

When ordering a 1933-36 Dodge or Plymouth hood, you must specify the year, the make and the belt-line measurement.

This information is necessary to insure the correct hood for your car.

Shown below are the belt-line measurements for patterns that we have available.

1933-35	Dodge (short wheel base)	44 1/2"	Belt-line
1933	Dodge (long wheel base)	48"	Belt-line
1934	Dodge (long wheel base)	50"	Belt-line
1936	Dodge	47 1/2"	Side Hinge
1936	Dodge Pickup	43 5/8"	Belt-line
1933	Plymouth PC	43"	Belt-line
1933	Plymouth PD	45"	Belt-line
1934	Plymouth PE	46 1/2"	Belt-line
1934	Plymouth PF & PG	43 1/2"	Belt-line
1935	Plymouth	42 3/16"	Side Hinge
1936	Plymouth	45 1/2"	Belt-line

If your measurements are not listed please call or write for further information.





# ROOTLIEB

Manufactures and Distributors of Vintage Automobile Sheetmetal and Related Products

~ Serving the Restoration and Hot Rod After Markets ~



## Purchase Order

**Bill To:**

Name \_\_\_\_\_

Address \_\_\_\_\_

City \_\_\_\_\_

State \_\_\_\_\_ Zip \_\_\_\_\_

Telephone \_\_\_\_\_

**No COD Orders**

I have enclosed my check or money order \_\_\_\_\_

Please charge to my credit card

Visa \_\_\_\_\_

Mastercard \_\_\_\_\_

Discover \_\_\_\_\_

**Ship To:**

Name \_\_\_\_\_

Address \_\_\_\_\_

City \_\_\_\_\_

State \_\_\_\_\_ Zip \_\_\_\_\_

Telephone \_\_\_\_\_

Account Number \_\_\_\_\_

\_\_\_\_\_/\_\_\_\_\_  
Expiration Date

3 Security #'s on back of card \_\_\_\_\_

Quantity	Item #	Description	Price	Extension

<b>Subtotal</b>	
<b>CA Tax</b>	
<b>Shipping</b>	
<b>Balance Due</b>	

Rootlieb, Inc.  
P.O. Box 1810  
Turlock, CA 95381  
phone (209) 632-2203  
fax (209) 632-2201



