



Controls

Diagnostics

Communications

**Static Controls Corporation**

# **1000 SERIES DISPLAY OPERATOR MANUAL**

---

---



## **S.C.C. 1000 Operator Interface Manual**

**Static Controls Corporation**

**30460 Wixom Road**

**Wixom, MI 48393**

**Phone: (248) 926-4400**

**Fax: (248) 926-4412**

**MN-1000-001**

**1000 Display Manual**

**Rev. K**

# Table of Contents

## S.C.C. 1000 Operator Interface Manual

<b>INITIAL SETUP</b>	<b>Section A-Page 1</b>
<b>Setup Conditions</b>	<b>Section A-Page 1</b>
Entering Setup.	Section A-Page 1
<b>Setup Options</b>	<b>Section A-Page 1</b>
Modes - Single Unit	Section A-Page 1
Modes - Multi-Drop	Section A-Page 1
Modes - Slave	Section A-Page 1
Modes - Message Files	Section A-Page 2
Modes - Diagnostic	Section A-Page 2
Modes - 1000 Network	Section A-Page 2
Display Address = xxx	Section A-Page 2
Priority	Section A-Page 2
Baud Rate	Section A-Page 2
Data Bits	Section A-Page 2
Stop Bits	Section A-Page 2
Parity	Section A-Page 2
Handshake	Section A-Page 3
Show Setup Info.	Section A-Page 3
<b>Parallel Set-Up</b>	<b>Section A-Page 4</b>
Input Lines	Section A-Page 4
Variables	Section A-Page 4
In Sample Time	Section A-Page 4
Input Format	Section A-Page 4
Variable Format	Section A-Page 4
Logic Inputs	Section A-Page 4
Variable Data Digits	Section A-Page 4
Outputs	Section A-Page 5
Constant	Section A-Page 5
Timed	Section A-Page 5
Scanned	Section A-Page 5
Delay Time	Section A-Page 5
Special Messages = x	Section A-Page 6
Parallel Output Character Codes	Section A-Page 6
<b>Clock Set-Up</b>	<b>Section A-Page 7</b>
Set Time / Date	Section A-Page 7
Clock is Message #0000	Section A-Page 7
Blank Before Clock	Section A-Page 7
Clock Is Set To Line # x	Section A-Page 7
Clock Is Set To Term. / Cont.	Section A-Page 7
Clock message display format.	Section A-Page 7
<b>INSTALLATION</b>	<b>Section B-Page 1</b>
Mechanical	Section B-Page 1
Wiring	Section B-Page 1
Power Supply	Section B-Page 1
<b>SERIAL COMMUNICATIONS/OPERATION</b>	<b>Section C-Page 1</b>
Control Codes	Section C-Page 1
Escape Codes	Section C-Page 3
<b>KEYPAD</b>	<b>Section D-Page 1</b>

**OPTIONS****Section R-Page 1**

<b>3 or 13 Keypad</b>	<b>Section R-Page 1</b>
<b>Memory</b>	<b>Section R-Page 1</b>
<b>Clock</b>	<b>Section R-Page 1</b>
<b>Parallel Inputs</b>	<b>Section R-Page 1</b>
<b>Data Logging</b>	<b>Section R-Page 1</b>
<b>Interface Driver</b>	<b>Section R-Page 1</b>
<b>4 / 14 Key Fault Display</b>	<b>Section R-Page 2</b>
<b>Marquee Display</b>	<b>Section R-Page 4</b>

**DISPLAY PART NUMBERS****Section S-Page 1****SPECIFICATIONS****Section T-Page 1****POWER SUPPLY POWER UP GRAPHS.****Section U-Page 1**

12 volt power supply.	Section U-Page 1
24 volt power supply	Section U-Page 2

**SOFTWARE OPERATIONAL REVISIONS****Section V-Page 1****DRAWINGS****Section W-Page 1****NOTES:****Section W-Page 2**

DD-1000-001-A	Section W-Page 3
DD-1000-002-A	Section W-Page 4
DD-1000-003-A	Section W-Page 5
DD-1000-011-A	Section W-Page 6
DD-1000-060-A	Section W-Page 7
DD-1000-078-A	Section W-Page 8
DD-1100-077-A	Section W-Page 9
AD-1000-005-A	Section W-Page 10
AD-1000-006-A	Section W-Page 11
AD-1000-007-A	Section W-Page 12
AD-1000-008-A	Section W-Page 13
AD-1000-010-A	Section W-Page 14
AD-1000-030-A	Section W-Page 15
AD-1000-047-A	Section W-Page 16
AD-1000-056-A	Section W-Page 17
ED-1000-012-A	Section W-Page 18
ED-1000-013-A	Section W-Page 19
ED-1000-021-A	Section W-Page 20
ED-1000-027-B (1 of 3)	Section W-Page 21
ED-1000-027-B (2 of 3)	Section W-Page 22
ED-1000-027-B (3 of 3)	Section W-Page 23
ED-1000-055-A	Section W-Page 24
ED-1000-057-A	Section W-Page 25
ED-1000-060-A	Section W-Page 26
ED-1000-070-A	Section W-Page 27
ED-1000-071-A	Section W-Page 28
NP-1000-089-A	Section W-Page 29

# **INITIAL SETUP**

## **Setup Conditions**

The S.C.C. 1000 Display requires that some of the units operating parameters be set up by the user. These will contain some of the units operating modes, communication modes and other basic operating conditions.

### **Entering Setup.**

When a unit is installed for the first time, the unit will enter the setup menu automatically. After the initial setup, a group of conditions need to be met to enter the setup menu:

1. Press and hold the *ENTER* button as the unit goes through it's self test routine at power up.
2. Unit will prompt "SET UP MODE? YES"
3. Depress *ENTER* key to access setup menu Once the setup menu is accessed, the user may press the arrow keys to alter selections. When the desired selection is displayed, depressing the *ENTER* key commits it to memory.

## **Setup Options**

### **Modes - Single Unit**

This is the basic operating mode for the unit. This mode allows for 2 way communication between the host device and the display unit.

### **Modes - Multi-Drop**

This mode operates the same as the Single Unit Mode, but allows for addressing of multiple displays from one host unit.

### **Modes - Slave**

In this mode, the unit will operate as a slave device under control from a master device with a master-slave protocol. The display may act as a SCC900 slave, SCC1000 slave or a Uticor slave.

### **Modes - Message Files** Soft. Rev. #2

This mode is used to upload or download message files from the SCC Offline Message Programming software. SCC offline message programming is done on an IBM compatible computer.

### **Modes - Diagnostic**

This mode is used for debugging of the character string being sent to the display unit. This is not a normal operating mode, and is for testing or debugging only.

This mode is used when the display is operating under control of the SCC Networking controller. This is a remotely located networking communications controller for sending files and logged display information.

**Display Address = xxx**

This allows the user to program the display's address. Used in Slave Mode and Multi-drop Mode. Units address can range from 0 to 255 depending on the application.

**Priority**

Allows for 2 different methods of priority. With Display priority, the display of character data takes priority. With Input priority, incoming data takes priority over the actual display of characters. This selection should only be made if the amount of data being generated is so large that the display is unable to "keep up". With Input priority selected, it's possible that some flickering of the display may be observed.

The below 5 items are to be set for each of 2 serial ports.

**Serial Port "x"**

**Baud Rate**

This allows for selecting the baud rate for serial inputs. Baud rates are 300, 600, 1200, 2400, 4800, 9600, 19,200 and 38,400 bits per second.

**Serial Port "x"**

**Data Bits**

Allows for 7 or 8 data bits on incoming serial port stream.

**Serial Port "x"**

**Stop Bits**

Allows for 1 or 2 stop bits on incoming serial port stream.

**Serial Port "x"**

**Parity**

Allows for Odd, Even or No parity check on incoming serial port stream.

**Serial Port "x"**

**Handshake**

Allows for hardware (CTS/RTS ), software (XON/XOFF ) or no handshaking of the serial data stream between the host device and the display unit.

## **Show Setup Info.**

This allows the user to determine if all setup parameters are to be displayed at power up (i.e. baud rate, data bits, etc.). If no is selected, the power up sequence takes less time to complete. Once power up is complete, the unit automatically goes into a run mode and will begin communicating.

# Parallel Set-Up

There are additional set-up parameters that need to be set before operation of the operator interface display can be used in the parallel mode:

## Input Lines

The input data lines to the display can be set for a time sample of the input data lines, or the data may be strobed in. If sample is selected then the sample time for the input lines must also be entered. If strobe is selected, the data is accepted when the strobe line becomes active. The strobe line is to be left open if time sampling is used.

## Variables Soft. Rev. #1

The variables that are inserted into message text can be strobed in or sampled in the same manner as the message number. If sampled, the sample time is the same as the sample time for the message number.

## In Sample Time

The sample time can range from 0 to 15 with each count equal to approx. 10 mSEC of sample time. If sample is selected, and "2" selected as the sample time, the input data lines will be accepted if the input lines remain stable for at least 20 mSEC. Only used if SAMPLE is selected for the input lines.

## Input Format

The data on the input lines that is used to select a message can be entered as a 4 digit B.C.D. coded number or it can be entered as a 16 bit Binary number.

## Variable Format

The variable data to the display can be entered as a B.C.D. number, a Binary number, or an ASCII character. This does not have to be the same format as the input message format.

## Logic Inputs

The logic value of the input lines (and strobe if used) can be set for a HI true logic or for a LO true logic. If a HI logic is selected all 0 volt inputs will be treated as a value of 0000. If LO logic is selected all inputs would require a voltage level on all of the inputs to be treated as a value of 0000.

## Variable Data Digits

The variable data that is sent to the display can be entered as a 1, 2, 3 or 4 digit value. This determines the number of digits that are input to a variable location per strobe (or sample). This does not limit the size of the variable that can be used in a message, as the variable may be larger, but require more than 1 strobe (or sample) to enter all of the variable characters.



## Outputs

The display can send out characters from the keypad to another device. There are three types of parallel output types. These types are listed below.

### Constant

Constant outputs will cause all outputs to appear at the parallel output until they are replaced by another output. These will be outputted for a minimum time of the time delay set, and have no maximum time that the output will be active.

### Timed

When Timed Output is selected each output will be sent out the parallel port with a specific time delay for each output. The Timed selection will output a value for 3 total time delays.

### Scanned Soft. Rev. #7

Scanned outputs will output the value of for the duration that the keypad is being pressed. As long as the operator has a key depressed, the output will remain active.

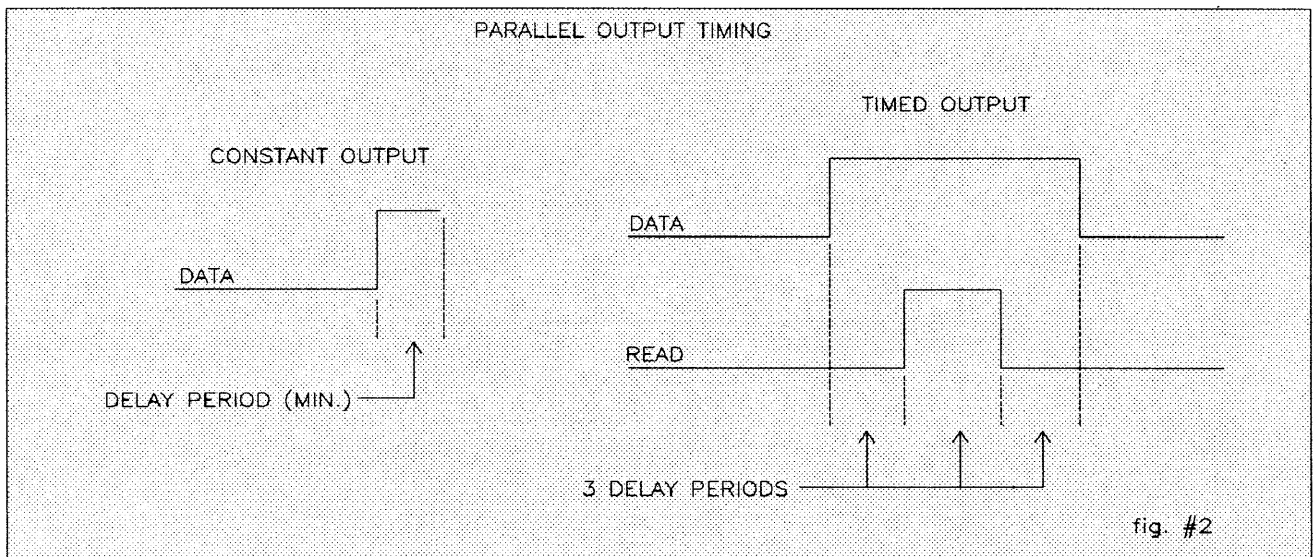

## Delay Time

There is a time delay that is to be entered for the parallel output. When CONSTANT output is used, the output will remain for a minimum of 1 delay period. When TIMED is selected, the data will be put on the output for 3 delay periods, with the READ output on for 1 delay period with the data stable for 1 delay period before and after the READ strobe. The delay period is not used for "SCANNED" output type.

Setting	Delay Time
1	1 mSec.
2	50 mSec.
3	150 mSec.
4	300 mSec.

## Special Messages = x Soft. Rev. 9

The parallel input can call up special messages if desired. If the special messages are not to be used, set the special messages to 0.

### Parallel Output Character Codes

KEY	OUT 8	OUT 4	OUT 2	OUT 1	HEX
0	0	0	0	0	0
1	0	0	0	1	1
2	0	0	1	0	2
3	0	0	1	1	3
4	0	1	0	0	4
5	0	1	0	1	5
6	0	1	1	0	6
7	0	1	1	1	7
8	1	0	0	0	8
9	1	0	0	1	9
UP	1	0	1	0	A
DOWN	1	0	1	1	B
ENTER	1	1	0	1	D

Note: Codes shown are for HI logic. If LO logic is selected, invert values shown.

# Clock Set-Up

There are additional set-up parameters that need to be set up before operation of the operator interface display can be used with a clock option.

## Set Time / Date

This will display the current time and date on the display. If the time and / or date needs to be changed answer yes to this question and change the time and / or date. Use the up and down arrow keys to change the value. The clock is set using a 24 hour format. But is displayed on the display in a 12 hour format. In 24 hour format, 00 hour is equal to 12:00 midnight.

## Clock is Message #0000

When message number 0000 is called up from the stored message memory, the clock can be displayed in a running format. Normally no message text is assigned at number 0000. This clock will remain on the display until another message is called up to replace the clock message.

## Blank Before Clock

If the clock is set to be shown as message #0000, the entire display can be blanked before the clock is displayed. Answer yes to this question if the display is to be entirely blanked before the clock is to be displayed.

## Clock Is Set To Line # x

When calling up the clock to be displayed as message #0000, the clock can be displayed on any line on the display. Set the line number that the clock is to be displayed on.

## Clock Is Set To Term. / Cont.

The clock can continue the display process to display message #0001 after the clock is displayed. Set to Continue if message #0001 is to automatically be displayed after the clock is displayed. Set to terminate if message #0001 is not to be displayed automatically after the clock.

## Clock message display format.

The clock message is displayed across 20 characters of text, or 1 line on the display.

12:22:34 01/12/92

Note that the message #0000 clock is sent out the slave port to all slaves attached to a master display.

# INSTALLATION

## Mechanical

Cut out panel with the template included with the unit, or according to the correct mounting dimension drawing for the type of unit to be installed.

## Wiring

Wire power supply leads, serial port leads and parallel input leads to the connector(s) on rear of the display.

Wiring to or from the display is all low voltage D.C. power. **DO NOT** run wiring to the display with any other wiring that may cause noise to be generated in the display. This would include all 120v A.C. control wiring, all 220 or 480v A.C. wiring, and any other D.C. wiring that carries any power to any other device.

All wiring to either of the display's serial ports, are to be shielded, twisted pair types of cables. These cables should **NOT** be broken by a terminal strip, or any other connector that would provide a non-shielded portion of the cable. Handshake wires should be run even if not required at the time of installation. Future capabilities can be added or used that may require the handshaking of the serial port lines.

In a noisy electrical environment, all wires to the power supply, and in extreme cases, all parallel input wiring may need to be shielded cable. The parallel inputs and outputs are optically coupled, and normally do not need shielding if the wiring distance is less than 30 feet.

## Power Supply

Whenever possible use a 24v D.C. power supply to operate the display. The higher the power supply voltage to the display, the better the signal to noise ratio becomes.

Use a power supply that powers up from 0v D.C. to full voltage in a quick ramp (approx. 50 milliseconds). A power supply that powers up to full voltage slowly, may not reset and power up the display correctly. Commercially available linear power supplies will normally power up in this time or less.

Use a power supply that can provide the display with enough amperage to provide the surge current required to energize the display tube. (See Specifications Section)

Whenever possible use a power supply that is dedicated to the display operation, and not one that is used for several devices. This eliminates ground loop problems, and fluxuating voltage levels.



**Note 3** - This code will return to the host a 3 byte answer as to the keys that are currently being pressed. The answer is formatted as:

**\$0B \$XX \$XX**

The first byte is an echo of the control character, followed by 2 hex bytes of keypad information. See the key code table below for each key's code.

**Note 4** - This code will return an ASCII decimal 7 byte answer as to the keys that are currently being pressed. The answer is formatted as:

**\$0E \$2B \$XX \$XX \$XX \$XX \$XX**

The first byte is an echo of the control character, followed by a plus sign and 5 bytes of ASCII decimal characters of keypad information. See the key code table below for each keys code.

**Key Code Table**

KEY	HEX KEY DATA	DECIMAL KEY DATA
0	\$0001	+ 00001
1	\$0002	+ 00002
2	\$0004	+ 00004
3	\$0008	+ 00008
4	\$0010	+ 00016
5	\$0020	+ 00032
6	\$0040	+ 00064
7	\$0080	+ 00128
8	\$0100	+ 00256
9	\$0200	+ 00512
UP	\$1000	+ 4096
DOWN	\$2000	+ 08192
ENTER	\$4000	+ 16384

## Escape Codes

Escape codes are identified by an escape character followed by an escape number. The escape code is a hex \$1B or a decimal 27. The escape number is an ASCII character.

**ESC, 0** Reset the display to power on conditions

**ESC, 1** Disable the displays keyboard

**ESC, 2** Enable the displays keyboard

**ESC, 3** Enable pass thru mode      note 9

**ESC, 4** Display bargraph characters      note 3

**ESC, 5** Display a repetitive bargraph      note 4

**ESC, 6** Clear remaining line after cursor      note 5

**ESC, 7** Echo characters      note 6

**ESC, 8** Send line out port      note 7

**ESC, 9** Set keyboard buffer length      note 8

**ESC, A** Disable pass thru mode      note 9

**ESC, B** Read porting buffer      note 10

**ESC, C** Clear porting buffer      note 11

**ESC, D** Clear out keyboard buffer

**note 3** - Displaying bargraph characters allows numeric data to be represented as a bar graph. There are 100 columns across the width of the display. To utilize this function, send the escape code followed by 2 ASCII digits. The following string \$1B \$34,\$31,\$31 would be displayed as shown in figure 4 below. The cursor will be in the first location following the bar graph.

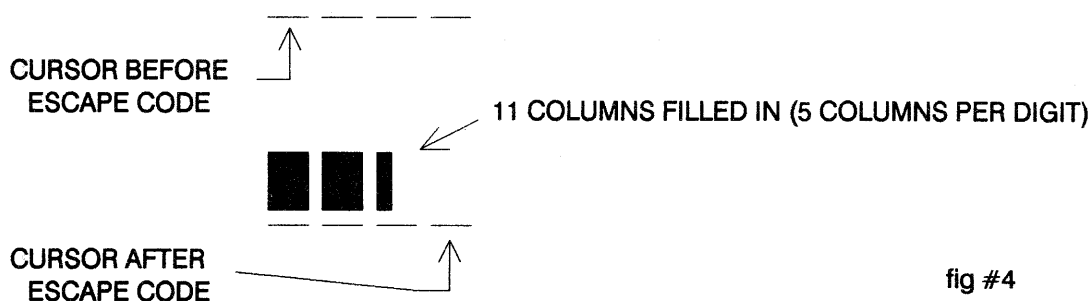

fig #4

**note 4** - Display a repetitive bar graph functions like the display bar characters, but will clear out the remainder of the current line, and place the cursor back to it's original position. This will allow repetitive graphs at the same location, and clear out any old graph data on the display.

**note 5** - Clear the remainder of the line from the current cursor position to the end of the line. The cursor will remain in the same position as it was before the escape code was issued.

**note 6** - The escape code is followed by an ASCII or hex digit from 1 to 10 that sets the number of characters that are to be echoed back to the transmitting device. This is followed by the characters that are to be echoed back.

example:

**\$1B,\$37,\$33,\$42,\$4E,\$0D**  
**[ Esc ] 7 3 B N [ CR ]**

This will echo the three characters "B", "N", and a carriage return back to the transmitting device.

**note 7** - The escape code is to be followed by an ASCII digit (1,2,3 or 4). This will set the line that is to be sent out from the display through serial port #2. The entire 20 character ASCII string will be sent out for use by another device. The 20 character message sent will contain control codes for slaving the message line to another 1000 series display that is operating in the Single Unit Mode. This port may be changed to another port if required. See Extended Set-up.

**note 8** - This escape code will set the maximum number of digits that can be entered from the keypad for each entry. The default value is 40. The escape code is to be followed by 2 ASCII digits that represent the maximum buffer size. The operator will not be able to enter any more digits per entry, than the max. buffer size.

**note 9** - These codes will enable and disable a mode that will allow characters to enter the main input port, and be sent out the printer port. When enabled, the display will not act on any incoming characters but will re-transmit the characters out the printer port characters \$02, \$03 and the escape character **CANNOT** be sent to the pass thru port. When the display is in the "pass thru mode" a message will be displayed on the display that will confirm that the mode is in operation.

**note 10** - An internal porting buffer can be read in to the host device with this command. The Escape code will return the displays address, the number of data bytes to follow, and all of the data bytes.

**Example: 001 003 1 2 [CR]**

The first 3 bytes are the displays address in ASCII. Shown here is an address of 001. The second 3 bytes are the number of data bytes to be sent. This number is in ASCII. Shown here is 3 data bytes are to follow. The next 3 bytes are the data. Shown here are the ASCII characters "1" , "2" followed by a carriage return character.

**note 11** - This code will clear out the internal porting buffer in the display.



# KEYPAD

The display unit is available with a 3 or 13 button keypad on the faceplate. ( There are a 4 and a 14 keypad units, with the extra key used for internal operations) The 3 righthand keys are an up arrow, down arrow, and an enter key. These keys are used to send data to the host device. The other 10 keys are numeric values of 0 thru 9. Special keypads are available for custom applications.

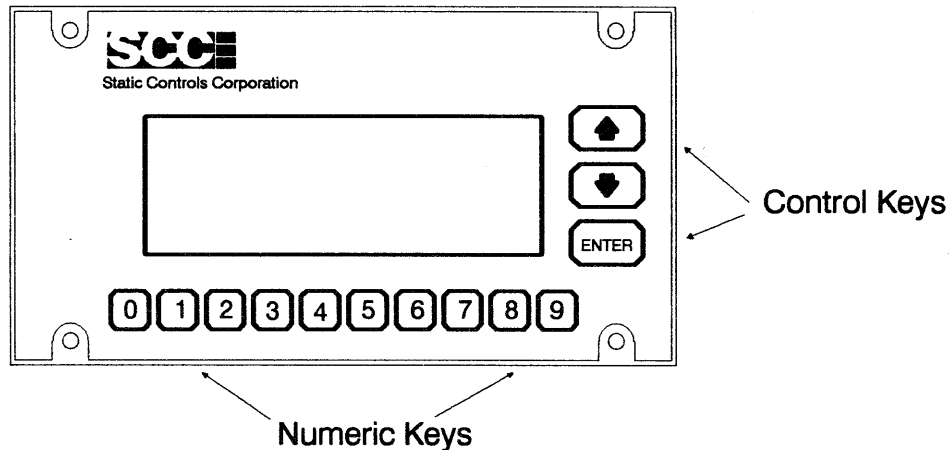

There are 4 different methods for outputting numeric keypad data to a host device.

## 1 ) BUFFERED / HDX (Buffered output / Half Duplex ) Soft. Rev. #5

In this mode the numeric keys are placed on the display at the current cursor position, and placed in a buffer when any numeric key is pressed. When the ENTER key is pressed, the keys stored in the buffer are sent out to the host device. When characters are being inputted into the buffer, the UP arrow key allows for backspacing of an incorrect numeric entry. If there are no numeric keys in the buffer, the UP and DOWN arrow keys will send codes when the key is pressed. If there are numeric keys in the buffer, the UP arrow acts as a backspace, and the DOWN arrow key places the down character into the buffer.

## 2 ) BUFFERED / FDX (Buffered output / Full Duplex ) Soft. Rev. #5

This mode works like BUFFERED / HDX with the exception that the keys are not displayed on the display.

## 3 ) INSTANT / HDX (Instant output / Half Duplex ) Soft. Rev. #5

In this mode, the keys are displayed on the display at the current cursor position, and the key character code is sent when the key is pressed.

## 4 ) INSTANT / FDX (Instant output / Full Duplex ) Soft. Rev. #5

This mode works like INSTANT / HDX with the exception that the keys are not displayed on the display. This mode is used to emulate a standard dumb terminal.

When the unit is powered up the default size of the key buffer is 40 characters, and the keyboard is enabled. (See control and escape codes to modify the buffer size and keyboard enable). The unit also is shipped with the key operating in BUFFERED / HDX. See Extended Set-up to alter the key operation modes.

A 3 button keypad works in the same manner as the 13 button keypad with the exception of the numeric keys.

### Keypad Character Values

KEY	ASCII	HEX	DECIMAL
0	0	\$30	48
1	1	\$31	49
2	2	\$32	50
3	3	\$33	51
4	4	\$34	52
5	5	\$35	53
6	6	\$36	54
7	7	\$37	55
8	8	\$38	56
9	9	\$39	57
UP		\$FC	252
DOWN		\$FA	250
ENTER	CR	0D	13

The character values that are sent for the *UP*, *DOWN* and *ENTER* keys can be altered by the end user. See section VIII on Extended Setup to allow changing of the codes sent for these keys.

**When operating in Single Unit Mode, pressing both the up and down arrow at the same time will allow the operator to change the operating mode of the display. This is usefull for changing into the message loading mode, and back to an operating mode when the need to send a new message file into the display is required. Both up and down arrow keys need to be pressed within approx. 50 mSeconds of each other.**

# SINGLE UNIT MODE

This is the normal operating mode for the display. In this mode the unit will accept all serial commands and operate all of the available options. This mode is used when a display is used as a single unit on the machine or process that is connected to.

This mode will respond to all serial commands and characters, and operate the optional parallel inputs.

# MULTI-DROP MODE

The display unit can operate in a multi-drop mode with multiple display units connected to a host unit. Each of the display units has an address that is user programmable. The display unit operates in this mode in the same manner as the single unit mode, with the addition of an addressing protocol.

A packet of data to the display unit must be preceded by a STX character (\$02) and a display unit address. The address is to be sent as a single byte of binary information. Follow this with any data that is to be sent to the display unit. Terminate the packet with an EOT character (\$04).

If the display unit is programmed with an address of \$00 it will receive ALL packets of data sent by the host unit. If the host unit sends a packet with an address of \$00 it will be received by ALL display units. These two conditions are referred to as "RECEIVE BROADCAST" and "SEND BROADCAST". If neither broadcast is active, the display unit will only respond to packets that contain it's own address.

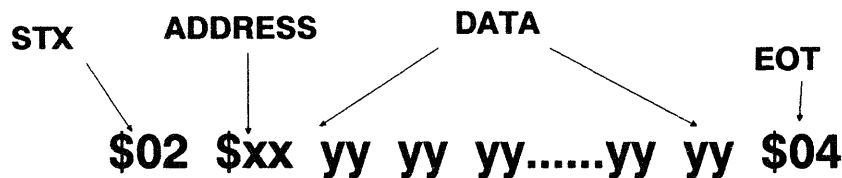

**DATA** is equal to control code, escape sequences, and ASCII strings as previously described in the manual for single unit mode.

When addressing units, **DO NOT** use address #4 for any of the displays. When sending out address #4, the display will interpret that as an end of transmission character. Addresses 0 thru 3, and 5 thru 255 are valid addresses for multi-drop use.

Terminate the serial transmission wires with a single 100 ohm resistor at the end of each transmit wire pair that are used in the multi-drop system.

**Note 1:** In multi-drop mode, the keyboard is set to be disabled at power up. See Escape Codes for keyboard enable and disable codes.

**Note 2:** The keyboard (and other outputting portions of the display) can be set to "output" to a porting buffer in the display. The buffer can then be read by a host device. This can be used to avoid contention with multiple slaves connected on the same RS-485 wires. See Extended Setup and Escape Codes for more information on these.

# SLAVE MODE

This mode allows the display to operate as a "dumb" display for a few different type of display "masters". In this mode, the display will receive a message from a "master", and decode the correct slave message packet, and show the message on the display.

The slave mode requires the display to receive and act on messages that are sent to it in a specific format generated by a master device. A SCC1000 display can be wired to a SCC900 master as a standard slave, when SCC900 slave is selected.

When the display is used as a slave, the display will only act or function in the manner allowed by the slave protocol. None of the single unit functions will operate when in a slave mode.

Most slave formats are not generally used unless the display is being connected to an existing system that uses one of the supported slave protocols. If the display is to used in a system where addressing the slaves is required, running the display in the Multi-drop mode allows for the display to function as a single unit, with addressing of each unit.

Current slave message protocols are listed below:

**1) SCC900 Slave Display**

**2) SCC1000 Slave Display**

**3) Uticor Slave Display**

When operating as a SCC900 slave, the serial port configuration requires port #1 to be a RS-485 type, operating at 1200 baud, 1 stop, 8 data and no parity.

When operating a slave from a SCC1000 Master in a network system, the slave display is to set as a SCC1000 slave.

# MESSAGE LOAD MODE

When loading message files into or out of the Series 1000 Display, the display must be in the Message Loading mode of operation. This is used to download or upload message text files between the display and a I.B.M. compatible computer. The computer will be running the S.C.C. program "SCCOFFL" offline message programming.

The display's port #1 will be set to a RS-232 type of port when in the message loading mode. If the display is ordered with a RS-485 configuration on port #1, the port will internally switch to a RS-232 type of port automatically. If the display was ordered with a RS-232 type of port, no switching is done internally.

On parallel input options, the RS-232 port is a 9 pin "D" connector located on the rear of the display. Any connections to the RS-485 terminal strip **MUST BE UNPLUGGED** before connecting the computer to the 9 pin "D" connector.

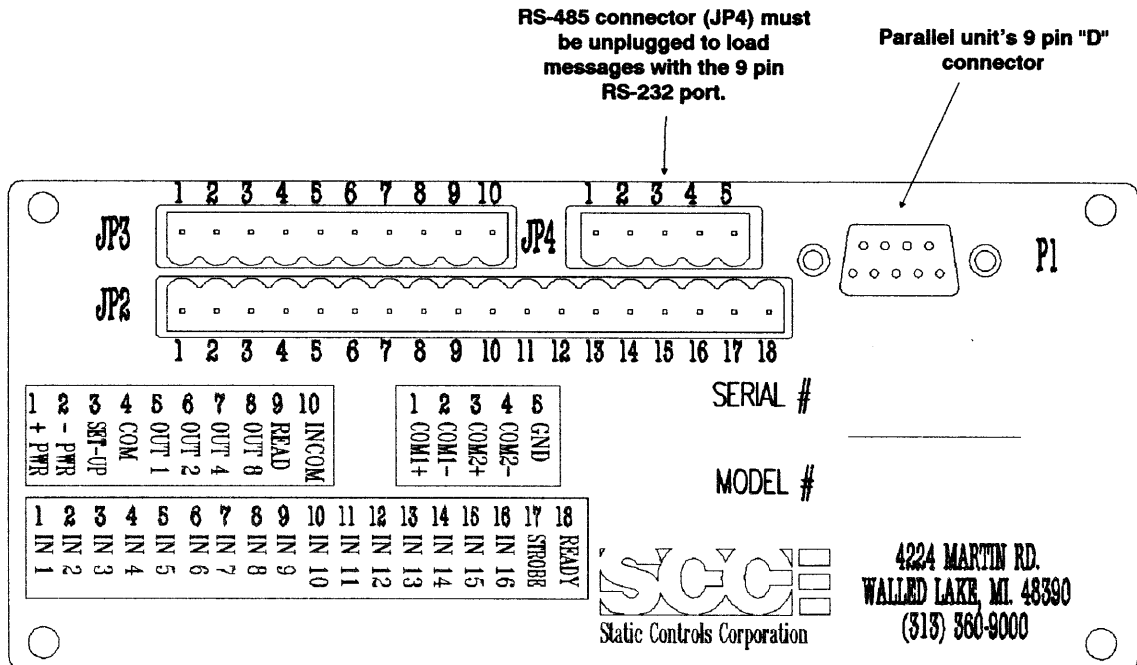

Refer to S.C.C. drawing #'s AD-1000-005-A and AD-1000-006-A for serial units cable connections.

Refer to S.C.C. drawing #'s AD-1000-007-A and AD-1000-008-A for parallel units cable connections.

Refer to Keypad Section for quick 2 button mode changing feature. This allows for changing modes to enter *Message Loading Mode* under normal operation.

# **DIAGNOSTIC MODE**

Diagnostic mode allows for some testing of the displays I/O ports.

## **Read In Serial Port**

This diagnostic mode is used for viewing the data stream sent from the host to the display unit. When in diagnostic mode the cursor will be flashing. When data is sent to the display, if the character is greater than a ASCII space (\$20), the character is displayed on the display. If the character is less than an ASCII space, the hex value of that character is displayed as 2 flashing characters on the screen. The display will not act on any control characters, but simply display them on the display.

This mode is used to check cabling from the host device to the display, and the output from the host device to the display.

## **Read In Parallel Port**

This diagnostic mode will display the value on the parallel input port. This will display the parallel input data formatted with the correct logic setting (Hi or Lo). The display will show the port input value in a hexadecimal format. The strobe line will be displayed when active with the word "Strobe".

## **Read In Keypad**

This diagnostic mode will display the keypad keys as each of the keys is pressed.

## **Send Out Serial Port**

This diagnostic mode will read in any key pressed on the keypad and send that character out both serial ports.

## **Send Out Parallel Port**

This diagnostic mode will read in any key pressed on the keypad and send that character out the parallel port.

## **Run Dry Cycle Characters**

This diagnostic mode will run a test pattern of all of the displayable characters across the display.

# 1000 NETWORK MODE

This mode allows for communications with a host computer operating under the `SCC_NET` networking program. The display for the most part, operates as it would in the `SINGLE UNIT Mode`.

Networked displays require that some options be installed on the display. The displays will need the parallel input option, 128K memory, clock, and fault network option.

Additional functions of the display are to log messages that are displayed in an internal log buffer. The network controller will communicate with the display to upload log files from the display.

In addition the network controller will maintain message files for each display and allow the message files to be uploaded and downloaded to the display.

The networking system allows multiple displays to be tied to the controller via a 2 wire half duplex RS-485 network. These displays are used for statistical information with the network controller compiling all information from each display.

To operate in the 1000 Network Mode, the display must be ordered with the network option.

The display will show a message on it's screen when it's receiving a command from the network controller. When the display is communicating with the network controller, it will read in the parallel port for message information from a P.L.C. and store those inputs into an internal buffer. When the display is done communicating with the network controller, it will act on the parallel inputs that it has stored in the buffer.

## Select Key Network Functions Soft. Rev. #10

When operating in the "1000 Network Mode" or the "1000 Slave Mode", the display will allow the operator to change into the "Message Loading Mode", setting the default network parameters, running the fault display, or displaying the current software version by using the "SELECT" key. After the "SELECT" key is pressed, the display will display a set of selectable operations that can be done from the display. These choices can be scrolled thru using the up and down arrow keys. If the operator does not make a selection after the "SELECT" key has been pressed, the display will begin to time out, and the display will flash for a short period of time, and then return to the "1000 Network Mode" of operation.

When using the "Message Loading Mode", the Network communications lines (JP4) **MUST** be disconnected from the back of the unit, and the RS-232 connection from the I.B.M. computer connected into the 9 pin "D" connector (P1) on the rear of the unit. Using the `SCCOFFL` offline message programming software, download a new message file into the display. When the transfer is completed, the unit will return to the Network Mode of operation.



# Network Mode Set-Up

When operating in the Network Mode, some set-up parameters need to be set to insure proper operation.

**Change SCC default setting . Set to 1000 Network Mode.** →

```

MODE  [X]SINGLE UNIT
      [ ]MULTI-DROP
      [ ]SLAVE           [ ]ISCC900
      [ ]MESSAGE FILES  [ ]ISCC1000
      [ ]DIAGNOSTIC     [ ]UTICOR
      [X]1000 NETWORK
GROUP ADDRESS [000]
  
```

**Set an unique address for each display.** →

```

DISPLAY ADDRESS (0-255) [000]
PRIORITY [X]DISPLAY [ ]INPUT
  
```

**Serial Port #1 is to be set as shown here.** →

```

SERIAL PORT #1
BAUD RATE [ ]38.4K [ ]119.2K [X]19600 [ ]14800
          [ ]12400 [ ]11200 [ ]1600 [ ]1300
DATA BITS [X]8 [ ]7
STOP BITS [X]1 [ ]2
PARITY [X]NONE [ ]ODD [ ]EVEN
HANDSHAKE [X]NONE [ ]CTS [ ]XON

SERIAL PORT #2
BAUD RATE [ ]38.4K [ ]119.2K [X]19600 [ ]14800
          [ ]12400 [ ]11200 [ ]1600 [ ]1300
DATA BITS [X]8 [ ]7
STOP BITS [X]1 [ ]2
PARITY [X]NONE [ ]ODD [ ]EVEN
HANDSHAKE [X]NONE [ ]CTS [ ]XON

PARALLEL PORT
INPUT LINES [ ]SAMPLED [X]STROBED
VARIABLES [ ]SAMPLED [X]STROBED
INPUT SAMPLE TIME [ ]9 [ ]10 [X]120 [ ]130 [ ]140 [ ]150
                  [ ]160 [ ]170 [ ]180 [ ]190 [ ]1100 [ ]1110
                  [ ]1120 [ ]1130 [ ]1140 [ ]1150mSEC.
INPUT FORMAT [X] B.C.D. [ ] BINARY
VARIABLE FORMAT [X] B.C.D. [ ] BINARY [ ] ASCII
LOGIC INPUTS [X]HI [ ]LO
VARIABLE DATA DIGITS [ ]1 [ ]2 [ ]3 [X]4 [ ]5
OUTPUTS [X]TIMED [ ]CONSTANT [ ]SCANNED
OUTPUT DELAY TIME [ ]1 [X]150 [ ]1150 [ ]1300mSEC

CLOCK
CLOCK DISPLAYED AS MESSAGE #0000 [X]YES [ ]NO
BLANK BEFORE CLOCK [X]YES [ ]NO
DISPLAY CLOCK ON LINE # [X]1 [ ]2 [ ]3 [ ]4
CLOCK IS SET TO [X]TERMINATE [ ]CONTINUE

SHOW SETUP INFO. [X]YES [ ]NO
  
```

Other parameters that are not highlighted, can be set to the operators preference.

# Network Mode Extended Set-Up

The Extended Set-Up settings for the networking display should not need to be altered from the factory default settings. However some settings are critical to the network operation, and may need to be checked if the system is not operating correctly.

```

EXTENDED SETUP
ENTER KEY = [ ]NONE [X]CR [ ]LF [ ]BOTH
UP ARROW KEY = [X]DEFAULT UP OTHER [ ]
DOWN ARROW KEY = [X]DEFAULT DOWN OTHER [ ]
FILL CHARACTER = [X]DEFAULT OTHER [ ]
ESC. CHARACTER = [X]DEFAULT $1B OTHER [ ]
    
```

These ports should be set as shown.

### PORTING

```

MAIN INPUT PORT [ ]0 [X]11 [ ]12 [ ]13 [ ]14
MSG. INPUT PORT [ ]0 [X]11 [ ]12 [ ]13 [ ]14
MSG. OUTPUT PORT [ ]0 [X]11 [ ]12 [ ]13 [ ]14
DATA OUTPUT PORT [ ]0 [X]11 [ ]12 [X]13 [ ]14
KEY CONTROL PORT [ ]0 [X]11 [ ]12 [X]13 [ ]14
PRINTER OUT PORT [ ]0 [ ]11 [X]12 [ ]13 [ ]14
SLAVE OUT PORT [ ]0 [ ]11 [X]12 [ ]13 [ ]14
REPEATER PORT [X]0 [ ]11 [ ]12 [ ]13 [ ]14
    
```

NOTE #1  
NOTE #1

If the display has 2 RS-485 ports, each should be set to a single RS-485 and not 1 single RS-422 port.

```

KEYPAD [X]BUFFERED/HDX [ ]BUFFERED/FDX
[ ]INSTANT/HDX [ ]INSTANT/FDX

USE AS [ ]1)422 PORT [X]2)485 PORTS NOTE #2

STROBE DELAY [ ]10 [X]110 [ ]120 [ ]130 [ ]140
[ ]150 [ ]160 [ ]170 [ ]180 [ ]190mSEC

INVALID MESSAGE # [X]TIMED [ ]SHOWN

KEYPAD REPEAT [ ]ON [X]OFF
    
```

These network timers should be set to the shown values.

```

NETWORK MODE TIMERS
RECEIVE CHARACTER TIMER = [1500] mSEC
TRANSMIT CHARACTER TIMER = [011] mSEC
INTER COMMAND TIMER = [050] mSEC
TURN AROUND TIMER = [50] mSEC
INTER LOG TIMER = [060] mSEC
INTER MESSAGE TIMER = [060] mSEC
    
```

NOTE #1 SET TO PORT #1 IF NO PARALLEL OPTION IN DISPLAY. IF PARALLEL OPTION IS PRESENT, PORT IS SET TO #2.

NOTE #2 NOT REQUIRED UNLESS BOTH SERIAL PORTS ARE OF RS-485 TYPE.

Other settings may be changed if required.

# Network Displays Installation

## Wiring

Each of the network display is connected to the network converter via a pair of shielded wires. This cable is to be **SHIELDED** cable, with no breaks in the cable between the network adapter and the display. Also each end of each cable run is to be terminated with a resistor at the **LAST** display on the cable run.

Refer to S.C.C. Manual #MN-1000-010 SCC\_NET NETWORK SYSTEM for more information.

## Set-Up

Refer to the critical set-up parameters that are listed on the last two pages or in the Network manual. A unique address is required to be set into each master unit on the network.

Message text files that are generated from the SCCOFFL offline program, need to have the "Log Selected Messages" parameter turned ON for the display to be set to log messages. Also each message that is to be logged has it's log select set to ON. See Offline Manual for more information.

# PARALLEL SPECIAL MESSAGES

## Versions #3.38 and up.

Soft. Rev 9

Provisions have been added to the 1000 series displays to allow a parallel message call up to call a set of special function messages. These messages can be input just as a message, but perform a special operation to the display, rather than call up a stored message in the display's memory.

To activate the special message feature, during set-up of the display, set the special messages to a **NON ZERO NUMBER**. When the special messages are set to zero, the feature is disabled, and any message call up will call up a stored message.

When setting the special messages, if the message input method is B.C.D., the special messages are set on a 10 unit boundry. (ie. 10, 20, 100, 9990 ect.) When the input method is binary, the special messages are set on 16 unit boundry. (ie. 16, 32, 256, 65520 ect.).

When the special messages are used, the display will assign 10 special messages from the boundry that was selected. For example if the special messages in B.C.D. were set to #9000, messages from 9000 thru 9009 would all call a special message function and not a stored message. In this example, messages 0000 thru 8999, and messages 9010 thru 9999 would still call up a stored message.

## Message Definitions

- 1) Clear out all parallel input buffers. This would clear out all pending messages and all pending variables that have been loaded into the parallel input buffers.
- 2) Reset the display. This will re-start the display as if power was applied to the display.
- 3) Clear the display. This will clear off the display of all characters on the display.
- 4) Lamp test. This will light up all segments of the display.
- 5) Clear keyboard buffer. This will clear out the keyboard buffer of any keystrokes that have been loaded into the keyboard buffer pending being sent to the host device.
- 6) Disable the keyboard. This will disable the operator from entering any keystrokes to the buffer or to the display screen.
- 7) Enable the keyboard buffer. This will re-enable the keypad for an operator.
- 8) Reserved for future use.
- 9) Reserved for future use.
- 10) Reserved for future use.

All of the special messages are detected when the parallel port reads in the number that is put on the input wires. The special messages are acted upon as soon as the message is detected. This will not put a special message into the input buffer, and will act on the special message before any other messages in the input buffer.

**Caution:**

When using the special messages, if the message and the variable text data are both inputted into the display in the same manner, (ie. both strobed in or both read on time sample) The possibility of a variable data being read in as a special message exists. If the messages and the variables are being inputted in different manners, this would not occur. It is recommended that special messages use the highest group of message numbers that can be inputted by the system.

# POWER UP

The display will go thru a set of operations at power up. initially it will read an internal memory, and load operating parameters and set-up information. The display will initially display:

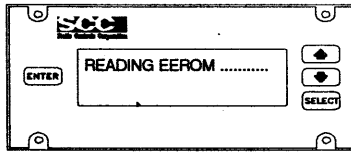

Then the display will show a full screen of "fill" characters.

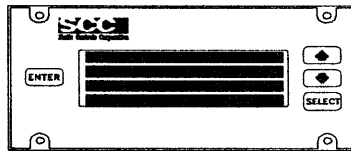

Then go thru a set of internal tests, and display:

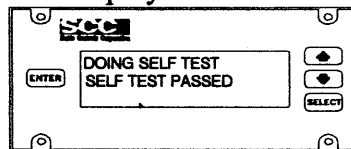

If all tests pass. If the display has detected a failure it will notify the operator and wait for the operator to press a key to acknowledge the failure. The display will now show all port set-up information if it has been set to do so.

Then the display will show:

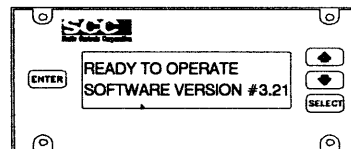

The number shown on line #2 will reflect the software version in operation in the display. The display will then show:

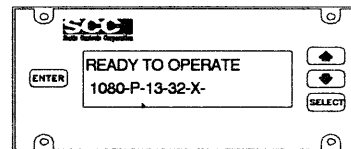

**The number on line #2 is the model number of the display.**

The display will now go blank, and is ready to operate.

### Note:

When calling the factory for assistance, have both the model #, and software versions available.

# EXTENDED SET-UP

The 1000 display unit has an extended set-up mode that can be used to alter some of the default settings in the display. The extended set-up will allow for changing of the 3 non-numeric control keys, a set of special characters, and the porting of all of the I/O functions in the display.

**CAUTION.** Do not attempt to alter these settings if they do not need to be changed. Altering these settings can **RENDER THE DISPLAY INOPERABLE**. If the settings need to be altered, change the settings with extreme care.

To enter the extended set-up **BOTH UP** and **DOWN** keys are to be held down and power is applied to the display. The unit will detect these keys only at power up and will confirm that detection of both keys pressed with the message " RELEASE KEYS ".

## Extended Set-up Control keys

This will set the display to prompt a series of 3 questions that the operator must answer.

The first question is           "0 = 1 = CR, 2 = LF, 3 = BOTH "  
  "TERM CHAR ?                    x                    "

Using the up arrow to change the value of "x" from 0 thru 3, select the required output for the *ENTER* key. When the correct value is shown for "x", press the *ENTER* key to complete the selection.

The 4 outputs are:   0 = no character transmitted  
                          1 = send out a carriage return (\$0D)  
                          2 = send out a line feed (\$0A)  
                          3 = send out a carriage return and a line feed (\$0D, \$0A)

The second and third questions ask for the character to be sent out for the *UP* and *DOWN* arrow keys. These two keys can send any character from \$20 (space) to a \$FF character. Using the *UP* and *DOWN* arrow keys, select the character that is to be sent, and press the *ENTER* key to complete the selection. All 3 selections will be saved and maintained in memory until altered again.

## Extended Set-up Special Characters

Two special characters can be entered. The first is the character that can be used to display a "fill" character on the display. This character will fill in the entire 5x7 dot matrix as a character. This character is a normal display character with a value of hex \$F8 ( See character set drawing #ED-1000-021-A). The display is shipped with a default character of "\_" (underscore) set as the "fill" character. Some driving devices cannot generate ASCII characters greater than hex \$7F, and in order to display a "fill" character, need a character that is less than hex \$7F. If this "fill" character

needs to be something other than a "\_" character, change this character using the *UP* or *DOWN* keys to alter the "fill" replacement character.

The second special character is the "ESC" character used for escape codes. The normal "ESC" character is a non-displayable character with a hex value of \$1B. The display is shipped with this being the default value of the "ESC" character. If the sending device cannot generate an "ESC" character, this can be altered to any ASCII hex value from \$00 to \$FF. Changing the character is done in the same manner as altering the "fill" character.

Note: For normal operation of Special text characters, **DO NOT** use the "\*" or the "^" characters as a "fill" or "ESC" characters.

## Extended Set-up Porting

Within the SCC1000 display, there are functions that require input and output data to be sent or received with the display. There are 8 different I/O device operations that are set in the display. They are listed below:

**MAIN INPUT PORT** = The port that receives all ASCII characters, control and ESC codes.

**MSG. INPUT PORT** = The port that will be used to receive a message file downloaded from the SCC offline message generating I.B.M. program.

**MSG. OUTPUT PORT** = The port that is used to send data to the SCC offline message program. This port is also used for the buffer output port when #4 is selected for other output ports.

**DATA OUTPUT PORT** = Output responses from the display to the host device are sent out this port.

**KEY CONTROL PORT** = The port used to send keys from the display to the host device.

**PRINTER OUT PORT** = The port used to send out a stored message when printing of the message is called for. Also used for sending out a message line under "ESC - 8" function.

**SLAVE OUT PORT** = The port used to send a stored message to slave displays.

**REPEATER PORT** = The port used to repeat any data coming in the MAIN INPUT PORT. This will re-transmit any data coming in the MAIN INPUT PORT out this port. Normally used only to chain together slave displays with large distances between slave displays.

Each of these 8 I/O operations can be set to 1) serial port #1, 2) serial port #2, 3) parallel port, 4) internal 800 character buffer, or 0) null port. (No operation). Not all of the I/O operations will function correctly with each of the port selections. (I.E. The printer cannot operate correctly being sent out the parallel port since the parallel port is only 4 bits wide.) **EXTREME CAUTION** must be used when changing any of the porting information. **INCORRECT SETTINGS CAN RENDER THE DISPLAY INOPERABLE.**



## Extended Set-up Keypad

The outputting of characters from the keypad to the host device can be set in one of 4 different methods.

**BUFFERED / HDX** = Buffered output, Half duplex operation (Display the keys on the display).

**BUFFERED / FDX** = Buffered output, Full duplex operation (Don't display the keys).

**INSTANT / HDX** = Instant output, Half duplex operation (Display the keys).

**INSTANT / FDX** = Instant output, Full duplex operation (Don't display the keys).

The keypad operation is explained in Serial Communications / Operations.

If the display unit is equipped with 2 RS-485 ports, the ports can be set up with the 2 ports being 2, two wire half-duplex ports, or 1, four wire full duplex RS-422 port. When used as a RS-422 port serial port #1 becomes the receive input to the display and port #2 becomes the transmitting port out of the display. The porting numbers must also be set in the same manner.

**STROBE DELAY TIME** When using the parallel input, a delay can be set to determine the time between a strobe input and reading in the parallel port data for that strobe. If the data and the strobe line are all brought active at the same time, this delay will wait this period of time before reading in the parallel data. This delay can be set from 0 to 90 milliseconds.

**INVALID MESSAGE #** When the display is asked to display a message number from internal storage, and that message number is not stored in the internal message memory, there are 2 options for displaying that the message is invalid. **INVALID MSG # TIMED** will display the invalid message number for a timed period (Approx. 2 seconds), and then the display will return to normal operation. **INVALID MSG # SHOWN** will display the invalid message number on the display, and this information will stay on the display until a valid message writes (displays) over the invalid message number.

**KEYREPEAT** When this is set to ON, the keypad will repeat the current key being pressed. When this is OFF, the pressing of a key on the keypad will produce only one keystroke, and the operator must release the key before another key pressed is detected. Soft. Rev. #8

If any of the extended set-up changes are needed, and the end user is unsure on any of the options, call the factory for an acceptable extended set-up change.

# SET UP SELECTIONS

Below are the listings of all of the Set Up selections that can be made from the keypad on the display. All addresses are shipped with a value of 0.

```

MODE  [X]SINGLE UNIT
      [ ]MULTI-DROP
      [ ]SLAVE          [ ]SCC900
      [ ]MESSAGE FILES [ ]SCC1000
      [ ]DIAGNOSTIC    [ ]UTICOR  → GROUP ADDRESS [000]
      [ ]1000 NETWORK

DISPLAY ADDRESS (0-255) [000]

PRIORITY  [X]DISPLAY      [ ]INPUT

SERIAL PORT #1
  BAUD RATE  [ ]38.4K [ ]19.2K [X]9600 [ ]4800
              [ ]2400 [ ]1200 [ ]600  [ ]300
  DATA BITS [X]8      [ ]7
  STOP BITS  [X]1      [ ]2
  PARITY     [X]NONE   [ ]ODD  [ ]EVEN
  HANDSHAKE  [X]NONE   [ ]CTS  [ ]XON

SERIAL PORT #2
  BAUD RATE  [ ]38.4K [ ]19.2K [X]9600 [ ]4800
              [ ]2400 [ ]1200 [ ]600  [ ]300
  DATA BITS [X]8      [ ]7
  STOP BITS  [X]1      [ ]2
  PARITY     [X]NONE   [ ]ODD  [ ]EVEN
  HANDSHAKE  [X]NONE   [ ]CTS  [ ]XON

PARALLEL PORT
  INPUT LINES      [ ]SAMPLED [X]STROBED
  VARIABLES        [ ]SAMPLED [X]STROBED
  INPUT SAMPLE TIME [ ]0      [ ]10  [X]20  [ ]30  [ ]40  [ ]50
                   [ ]60  [ ]70  [ ]80  [ ]90  [ ]100 [ ]110
                   [ ]120 [ ]130 [ ]140 [ ]150mSEC.
  INPUT FORMAT     [X]B.C.D.  [ ]BINARY
  VARIABLE FORMAT  [X]B.C.D.  [ ]BINARY [ ]ASCII
  LOGIC INPUTS     [X]HI     [ ]LO
  VARIABLE DATA DIGITS [ ]11 [ ]12 [ ]13 [X]14 [ ]15
  OUTPUTS          [X]TIMED  [ ]CONSTANT [ ]SCANNED
  OUTPUT DELAY TIME [ ]11 [X]50 [ ]150 [ ]300mSEC

CLOCK
  CLOCK DISPLAYED AS MESSAGE #0000 [X]YES [ ]NO
  BLANK BEFORE CLOCK                [X]YES [ ]NO
  DISPLAY CLOCK ON LINE # [X]1 [ ]2 [ ]3 [ ]4
  CLOCK IS SET TO [X]TERMINATE [ ]CONTINUE

SHOW SETUP INFO. [X]YES [ ]NO
  
```

[X] = SCC DEFAULT VALUE

# EXTENDED SET UP SELECTIONS

Below are all of the Extended Set Up selections that can be made from the keypad on the display.

## EXTENDED SETUP

ENTER KEY = [ ]NONE [X]CR [ ]LF [ ]BOTH  
 UP ARROW KEY = [X]DEFAULT UP OTHER [\_\_\_\_]  
 DOWN ARROW KEY = [X]DEFAULT DOWN OTHER [\_\_\_\_]  
 FILL CHARACTER = [X]DEFAULT OTHER [\_\_\_\_]  
 ESC. CHARACTER = [X]DEFAULT \$1B OTHER [\_\_\_\_]

## PORTING

MAIN INPUT PORT [ ]0 [X]1 [ ]2 [ ]3 [ ]4  
 MSG. INPUT PORT [ ]0 [X]1 [ ]2 [ ]3 [ ]4  
 MSG. OUTPUT PORT [ ]0 [X]1 [ ]2 [ ]3 [ ]4  
 DATA OUTPUT PORT [ ]0 [X]1 [ ]2 [X]3 [ ]4  
 KEY CONTROL PORT [ ]0 [X]1 [ ]2 [X]3 [ ]4  
 PRINTER OUT PORT [ ]0 [ ]1 [X]2 [ ]3 [ ]4  
 SLAVE OUT PORT [ ]0 [ ]1 [X]2 [ ]3 [ ]4  
 REPEATER PORT [X]0 [ ]1 [ ]2 [ ]3 [ ]4

NOTE #1  
 NOTE #1

KEYPAD [X]BUFFERED/HDX [ ]BUFFERED/FDX  
 [ ]INSTANT/HDX [ ]INSTANT/FDX

USE AS [ ]1)422 PORT [X]2)485 PORTS NOTE #2

STROBE DELAY [ ]0 [X]10 [ ]20 [ ]30 [ ]40  
 [ ]50 [ ]60 [ ]70 [ ]80 [ ]90mSEC

INVALID MESSAGE # [X]TIMED [ ]SHOWN

KEYPAD REPEAT [ ]ON [X]OFF

## NETWORK MODE TIMERS

RECEIVE CHARACTER TIMER = [1500] mSEC  
 TRANSMIT CHARACTER TIMER = [01] mSEC  
 INTER COMMAND TIMER = [050] mSEC  
 TURN AROUND TIMER = [50] mSEC  
 INTER LOG TIMER = [060] mSEC  
 INTER MESSAGE TIMER = [060] mSEC

NOTE #1 SET TO PORT #1 IF NO PARALLEL OPTION  
 IN DISPLAY. IF PARALLEL OPTION IS  
 PRESENT, PORT IS SET TO #3.

NOTE #2 NOT REQUIRED UNLESS BOTH SERIAL PORTS  
 ARE OF RS-485 TYPE.

[X] = SCC DEFAULT VALUE

# **DISPLAY PORT CONFIGURATION**

There are two serial ports and optionally one parallel port on the SCC 1000 display. For extended set-up purposes there is also a "NULL" port which is a method for "sending" or "receiving" display information to or from a imaginary port. This would send an output to no ports, and receive no characters for an input. To disable an output or input the port would be set to "NULL". In addition to these, a buffer port can be set on the display. This will send an output from the display to an internal buffer that can be retrieved by a host unit on command.

Each of the two serial ports on the display can be ordered with the hardware for a RS-232 port or a RS-485 port. When the serial port is a RS-232 port, the port is a full duplex transmission type, with hardware handshaking lines. When a port is ordered as a RS-485 port, the port operates as a half duplex transmission type, 2 wire port, with no hardware handshaking.

The display can emulate a RS-422 full duplex transmission type with a 4 wire port, if the display unit contains 2 RS-485 ports. In order to do this serial port #1 acts as the receiving 2 wires, and serial port #2 acts as the display's transmission port.

## **RS-422 Four Wire and RS-485 Two Wire**

When a RS-485 port is ordered on the display, the port is configured as a RS-485, 2 wire, half duplex port. This means that the 2 wires that run into the display are used as both "transmit" and a "receive" wires. The host and the display cannot transmit to each other at the same time as they could in full duplex. This requires that the host device must control all transmissions on the 2 wires as a "master". For the host device to control the display's transmissions, the display MUST have its outputs sent to the internal buffer, and the host can command the display to send the display's buffer when the host is able to receive the characters.

When the RS-485 port is switched between transmit to receive, a 5 millisecond time must be allowed for the hardware to switch between transmit and receive.

The 2 RS-485 ports can be configured to emulate a single RS-422 port. When using the ports as a RS-422 port, no delay is required between transmit and receive. The port will act as a normal four wire full duplex port. This allows both devices to be transmitting at the same time.

When using a serial communications that are RS-422 or RS-485 types of drives, a 100 ohm resistor should be placed between the + and - receiving terminals on the display and on the host devices receive terminal.

# Typical Extended Setup Porting Examples

## Display to operate as a single ended unit with a host device

Requirements:

Display has 1)RS-232 port and second port is RS-232 or RS-485

```
MAIN INPUT PORT = 1
MSG. INPUT PORT = 1
MSG. OUTPUT PORT = 1
KEYPAD DATA PORT = 1
KEY CONTROL PORT = 1
PRINTER OUT PORT = 2
SLAVE OUT PORT = 2
REPEATER PORT = 0
```

= Results: All incoming data and keystrokes are sent out of port #1 (RS-232). Message file loading and unloading is done on port #1. Printer and slaves are connected to port #2.

## Display to emulate a single RS-422 full Duplex Port

Requirements:

Display has 2) RS-485 serial ports

```
MAIN INPUT PORT = 1
MSG. INPUT PORT = 1
MSG. OUTPUT PORT = 2
KEYPAD DATA PORT = 2
KEY CONTROL PORT = 2
PRINTER OUT PORT = 2
SLAVE OUT PORT = 2
REPEATER PORT = 0
USE PORTS AS 1) 422
```

= Results: All incoming data is on port #1. All outgoing data is sent from port #2.

## Display to run with a "master" host controlling transmissions on a RS-485 two wire communications.

Requirements:

Display has 1)RS-232 port & 1)RS-485 port

```
MAIN INPUT PORT = 2
MSG. INPUT PORT = 1
MSG. OUTPUT PORT = 1
KEYPAD DATA PORT = 4
KEY CONTROL PORT = 4
PRINTER OUT PORT = 4
SLAVE OUT PORT = 4
REPEATER PORT = 0
```

= Results: All incoming data is on port #2. (RS-485) Message file loading and unloading is done with port #1. (RS-232). All outgoing data is stored in an internal buffer, and will be sent out port #2 when the buffer is commanded to send.

## Display to run as a "master" with a parallel port, with slave displays attached to the "master".

Requirements:

Display has 1)RS-232 port & 1)RS-485 port & parallel port.

```
MAIN INPUT PORT = 1 * note1
MSG. INPUT PORT = 1
MSG. OUTPUT PORT = 1
KEYPAD DATA PORT = 3
KEY CONTROL PORT = 3
PRINTER OUT PORT = 0
SLAVE OUT PORT = 2
REPEATER PORT = 0
```

= Results: All incoming data is on port #1 (RS-232). All keystroke data is sent out the parallel port to the P.L.C. Slave information is sent out port #2 (RS-485). Message call up data is from port #3 (Parallel port).

\* note 1: When a parallel port option is ordered, the display will always read in the parallel port for message call up data. In addition, serial port #1 can also be used to send data to the display. If the serial port input is not desired, set the MAIN INPUT PORT to #3. This will disable the main input from the serial port.

# SPECIAL TEXT CHARACTERS

## Insert Variable Characters

These text characters can be inserted into stored message text. They only operate as special characters when they are inserted into stored messages.

There are two special text characters into the text of a message to retrieve a variable and insert into the text when the message is displayed.

\* This character is the "insert variable" character. When this character is inserted into the text, the display will retrieve a character or number from the input buffer and load those characters or numbers into the spaces occupied by the insert variable characters. The insert variable character will be replaced character by character until all of the insert variable characters are filled with a variable. If the input is from the parallel input, the number will be inserted from the low order digit up to the highest order digit. If the input is from the serial port, the characters or numbers are inserted from the high order digit. The insert variable character can be changed to another character from the SCC Offline Message Programming software.

^ This character is the "keypad variable" character. This acts in the same way as the insert variable character but gets it's numeric variable from the display keypad. The display will flash a block type of character on the display to indicate to the operator that a keypad variable is to be entered.

## Clock Option Characters

If the display has the clock option, there are 2 sets of special text strings, that if inserted into the stored message text, will display the time or the date. The time or date will take up 8 characters on the display each. These are only valid when used in stored message text. The strings are:

**\$ - TIME - \$** This displays the time.

**\$ - DATE - \$** This displays the date.

## Replace Fill Character

A character is provided to fill in the entire character position if needed. This character is in the upper ASCII range, and some host devices cannot send this type of character. A "replace character" is provided to replace a character with a full block "fill" character. The default value for this is an underscore "\_". When the "replace character" is inserted into the text of a message, the replace character is replaced with a "fill" character. The "fill" character lights up the entire 5x7 matrix that is at the current cursor position. The "replace character" may be changed to another character if required. (See Extended Set-up)

# **1000 SERIES APPLICATION NOTES**

## **Setup Considerations**

Static Controls recommends a starting point for all setup parameters. The display units are all shipped with a default set up parameters stored in the display.

### **MODE = SINGLE UNIT**

<b>PORT #1</b>	<b>PORT #2</b>
<b>BAUD RATE = 9600</b>	<b>BAUD RATE = 9600</b>
<b>DATA BITS = 8</b>	<b>DATA BITS = 8</b>
<b>STOP BITS = 1</b>	<b>STOP BITS = 1</b>
<b>PARITY = NONE</b>	<b>PARITY = NONE</b>
<b>HANDSHAKE = NONE</b>	<b>HANDSHAKE = NONE</b>
<b>DISPLAY PRIORITY</b>	

Baud rate, Data bits, Stop bits and Parity must match the transmitting device. If possible, the default settings should be used. If any of the serial communication set up parameters need to be altered, match these settings to the transmitting device.

Handshaking should be set to "NONE" if at all possible. If handshaking is required, there are two methods of handshaking available. One is hardware handshaking with wires between the display and the transmitting device. This is labeled "CTS/RTS". A software handshake is also provided using "XON/XOFF". Large amounts of data (500 bytes or more) sent to the display, or higher baud rates may require handshaking. CTS/RTS hardware handshaking is the more common and faster of the 2 handshaking types. The hardware handshaking wires should be run between devices on each of the serial ports (RS-232). If handshaking is required later due to a program change, or use of a function on the display itself, the wires would be available.

The unit should also be set to "DISPLAY PRIORITY" for most applications. If the transmitting device is sending a lot of data to the display constantly, setting the display into "INPUT PRIORITY" will allow the display to receive character data faster than in the "DISPLAY PRIORITY" setting. The input priority may cause the display to flicker slightly if a large character data string is sent to the display.

Normal operating mode is "SINGLE UNIT". A diagnostic mode is provided that will display incoming characters which can be used for troubleshooting the characters from the transmitting device.

# Transmitting Data Considerations

When setting up the transmitting device a few things are recommended for most applications. When first powering up the transmitting device, a routine should send reset command and a keyboard disable command to the display. This will ensure that the display is in a known starting position.

When sending data to the display, if the unit is being used as 4 lines of data, a cursor position command should be sent to the display to insure that the cursor is in a known position for each line of data sent to the display. A clear line command may also be sent after the cursor position command if the display may have existing message on the line that is to be updated to new information. If all messages are 20 characters in length, a clear line command is not needed as the new 20 character message will completely write over the old 20 character message.

If possible during operations, when blanking the display entirely for a new group of messages, send a clear screen command to the display.

Blink on command must be sent to the display before the first character that is to be blinking, and then send characters, then a blink off command.

In a Multi-drop mode of operation, an enable and disable keypad command should be sent when soliciting variable data from the keyboard. Also if multiple units are connected with a RS-485 port, sending keypad data to the displays internal buffer is recommended. The host device can read the displays internal buffer and avoid contention of the RS-485 wires by 2 or more sending displays. The host can read the displays internal buffer under the hosts control.



# SCC Offline Message Programming Software For SCC1000 Series Displays.

Most of the SCC Offline Software will operate correctly with the SCC1000 series displays. Most of the message generating portions, uploading and downloading and terminal emulation function the same as with a SCC 900 series displays. The Offline Program requires that the serial port be set to 8 data bits for proper operation.

```
Static Controls Corporation  Offline Programmer and Emulator  U 1.04  3/92

----- STATIC CONTROLS CORPORATION -----
F1 - Edit communication parameters
F2 - Transfer message file from the display
F3 - Transfer message file to the display
F4 - Dumb terminal mode
F5 - Print data file
F6 - Simulator
F7 - Transfer from the datalogger
F8 - Transfer to the datalogger
F9 - Exit to Dos
F10 - HELP

COMMUNICATION PARAMETERS
COM PORT : COM1
BAUD RATE : 9600
DATA BITS : 8
STOP BITS : 1
PARITY : None
```

All functions on the main menu will operate correctly. When creating message files in the "F6" Simulator selections, some functions are not applicable and others operate in a slightly different manner than in the 900 series displays. The system parameters that are alterable in the SCC900 program have differences from the 900 series displays. The system parameters are shown below, and thier functions described with them.

Be sure to use cable supplied by SCC to transfer messages, or make a cable that conforms with the SCC supplied drawing of your computer type and display type.

Below is the System Parameter list from the SCC Offline Program.

\*\*\*\*\* SYSTEM PARAMETERS \*\*\*\*\*

AUTO BLANK BEFORE CLOCK .....	ON	
BYPASS DISPLAY OF CLOCK .....	ON	USED ON DISPLAYS WITH CLOCK OPTION.
THE CLOCK IS SET TO LINE.....	#1	
THE CLOCK IS SET TO .....	TERM	
SCROLL DELAY TIME IS .....	7	
FLASH TIME IS .....	9	
NUMBER OF FLASHES IS .....	5	
DELAY AFTER MESSAGE IS .....	3	USED ON ALL 1000 SERIES DISPLAYS.
INSERT CHARACTER IS .....	*	
PRINTER IS SET TO .....	ON	
# OF COLUMNS FOR PRINTER .....	20	
PRINTER BAUD RATE IS .....	DIP SETTING	
PRINTER LINE FEED DELAY IS .....	10	
PARALLEL LOGIC TRUE IS .....	HI	
PARALLEL STROBE / SAMPLE .....	STROBE	
PARALLEL DEBOUNCE TIME IS .....	9	USED ON DISPLAYS WITH PARALLEL OPTION.
PARALLEL MSG# SELECT IS .....	BINARY	
PARALLEL VARIABLE DATA IS .....	B.C.D.	
NUMBER OF B.C.D. DIGITS IS .....	4	
NUMBER OF BINARY BITS IS .....	16	
LOG SELECTED MESSAGES IS .....	ON	USED ON DISPLAYS WITH NETWORK OPTION.
CLEAR LOG BUFFER WHEN READ IS .....	ON	

The items that are highlighted above are system parameters that are passed from the SCC Offline program to the 1000 series displays. Other settings are not applicable to the operation of the 1000 series display.

```
                STATIC CONTROLS CORP.

USED MESSAGES ->    0                FREE MESSAGES -> 1890

-----  M A I N  M E N U  -----

(C) CARTRIDGE STORAGE
(X) EXIT PROGRAM MODE (SAVE/DISREGARD DATA)
(I) CREATE A NEW BLOCK OF FORMATTED MESSAGES
(T) TRANSFORM MESSAGE FILE (2 <-> 4 LINES)
(S) STORE A NEW MESSAGE
(M) MESSAGE MAINT. MENU
(U) VIEW MESSAGES STORED
(A) SPECIAL FEATURE MENU
(D) DISPLAY A STORED MESSAGE
(F) FORMAT STORAGE PARAMETERS
(H) VIEW MANUAL

Enter or Return after entry. ? for help.
Enter selection :
```

All of the above selections are valid for the series 1000 display.

Message programming for each of the individual messages has some differences from the 900 series displays.

MSG #	LINE #	TYPE	CNT	PNTR	ALRM	SLU #	[— MESSAGE —]	TERM	RPT	DELAY
0001	#1	BLK	000	ON	ON	01	STATION #1 DOWN	CONT	OFF	OFF
0001	#2	BLK	000	ON	ON	01	TRANSFER NOT ADU'D.	TERM	OFF	OFF
0002	#1	BLK	000	OFF	ON	01	PRODUCTION RUNNING.	CONT	OFF	OFF
0002	#2	BLK	000	OFF	ON	01	NO FAULTS!	TERM	OFF	OFF
0003	#1	BLK	000	OFF	ON	01	CY. TIME ***.* SECS.	CONT	OFF	OFF
0003	#2	BLK	000	OFF	ON	01	9.8 SECS STANDARD.	TERM	OFF	OFF
0004	#1	BLK	000	ON	ON	01	PRODUCTION COUNT:	CONT	OFF	OFF
0004	#2	BLK	000	ON	ON	01	485 PCS.	TERM	OFF	OFF
0005	#1	BLK	000	ON	ON	01	IDLE TIME: *.* SECS.	CONT	OFF	OFF
0005	#2	BLK	000	ON	ON	01	1.7 SECS. STANDARD.	TERM	OFF	OFF
0006	#1	BLK	000	OFF	ON	01	LIGHT CURTAIN	CONT	OFF	OFF
0006	#2	BLK	000	OFF	ON	01	FAULT.	TERM	OFF	OFF
0007	#1	BLK	000	ON	ON	01	WAITING FOR PARTS	CONT	OFF	OFF
0007	#2	BLK	000	ON	ON	01	NO FAULTS.	TERM	OFF	OFF
0008	#1	BLK	000	OFF	ON	01	CYCLE START	CONT	OFF	OFF
0008	#2	BLK	000	OFF	ON	01	A.O.K.	TERM	OFF	OFF
0009	#1	BLK	000	ON	ON	01	END OF	CONT	OFF	OFF
0009	#2	BLK	000	ON	ON	01	CYCLE.	TERM	OFF	OFF
0010	#1	BLK	000	ON	ON	01	CHANGEOVER TO #A77D	CONT	OFF	OFF
0010	#2	BLK	000	ON	OFF	01	AT LUNCH BREAK	TERM	OFF	OFF

[ESC] [HOME] [END] [PGUP] [PGDN] [↑] [↓]

1) **TYPE** Series 1000 messages do not have scrolling messages, scrolling messages will appear as a block message. Also flashing messages will flash until the message is replaced with another message on the display.

2) **ALRM** When this is set on a 1000 display (version #3.40 and higher) the display will show the message in a normal fation. When the message is completed, the display will display the clock .A clock option must be ordered for this function to operate. The clock will be displayed on the line that the clock parameters were set for. (See section on the clock).

Basic programming of a message or set of messages starts with the operator selecting "F6 - Simulator" to start the message programming. Select "S" to store a message. Answer the questions that are used on the Series 1000 display, using an "X" to exit each screen when done. Use "F3 - Transfer to the display" to send the newly created message file to the display.

# Parallel Considerations

The parallel option does not affect the main serial port input. All of the control codes, ESC codes and ASCII input will still function as they would with a non-parallel input. In some cases, the output from some of the functions (Keypad data and key control) will be sent out the parallel output port and not out the serial port. (This can be disabled if required, see Extended Set-up).

Parallel inputs and outputs are isolated from the power supply, and require a common or ground connection to be made to the INCOM terminal on the back of the display.

The parallel inputs require a sourcing input (PNP type). Approx. 8mA required to turn the input ON.

The parallel outputs are sinking outputs (NPN type). The parallel outputs are not pulled up internally, and require a load of minimum 2mA, and a maximum load of 18mA.

Parallel outputs have different, selectable time outputs. Select a time delay that would allow the host device (P.L.C. or other device) time to always be able to read the outputs from the display to avoid missing character outputs from the display.

Parallel input units **MUST** contain internal message memory storage.

## Parallel Input Timing.

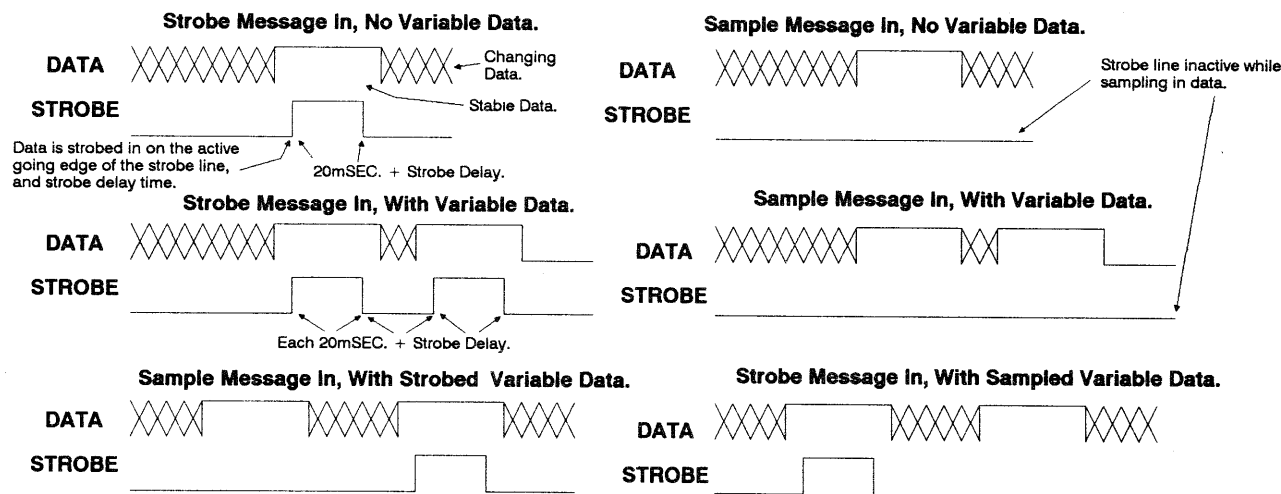

When strobing in data, the strobe must be active for a minimum of 20 milliseconds + Strobe Delay time. The strobe line must also go inactive for a minimum of 20 milliseconds between any two strobes. The data is shown stable before the strobe for 5mSEC. If both data and strobe become active at the same time, set strobe delay to a minimum of 10 milliseconds to insure stable data when the strobe is detected to input new data. (Display strobe delay is defaulted to 10mSec. when shipped.)

When sampling in data, the strobe line must remain inactive. If the strobe line is active, the display will not accept data as a sampled input. The data must remain stable for a minimum of the sample time selected, plus 20 milliseconds.

Typical application using strobes to call up a message. This example uses Allen-Bradley logic symbols, but the same method can be used with about all P.L.C. types.

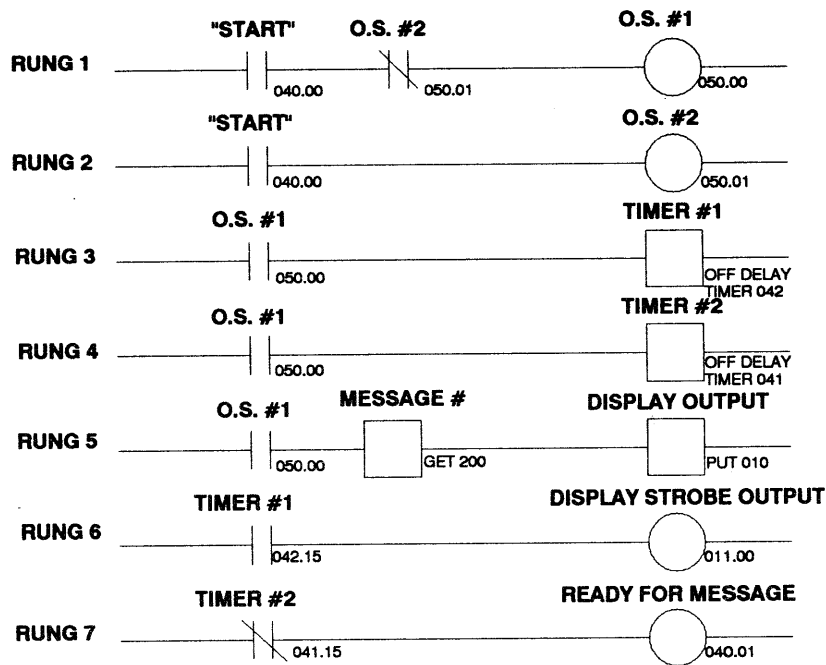

In the above example, first the message number to be displayed is put into word 200, and "START" contact is closed.

When the "START" contact closes, along with relay "O.S. #1" and "O.S. #2", creates a contact closure for 1 scan with relay "O.S. #1". The one scan contact will first initiate a set of off delay timers "TIMER #1" and "TIMER #2". Then it will load the message number to the output connected to the display's input labeled "DISPLAY OUTPUT".

The timer "TIMER #1" contact will then cause the "DISPLAY STROBE OUTPUT" to turn the strobe line to the display active for 0.1 seconds. "TIMER #2" contact will turn on relay "READY FOR MESSAGE" after another 0.1 seconds.

Load in a message number into word 200, close contact 040.00, and when contact 040.01 closes, the display will be ready for a new message number, or a variable to be strobed into the display.

**When wiring up a parallel input, note that terminal #10 on JP3 is to be connected to the common of the power supply that is used for the input data bits. If the same power supply is operating both the display's power and the input data bits, jumper between terminal #10 and #2 on JP3.**

# OPTIONS

There are a number of options that can be ordered with the SCC1000 series displays. Below is a listing of the options and their operation.

## 3 or 13 Keypad

The keypad allows data to be sent from the display back to the host device. A 3 button keypad would allow for control keys to be sent (*UP*, *DOWN*, and *ENTER* keys). A 13 button keypad would allow for numeric data to be sent back to the host device.

*Note: The 3 button keypad also is used to change the operation of the display and to perform some diagnostic operations. If a 0 button keypad is ordered, the setup of the unit cannot change from the factory settings, and no diagnostics can be done.*

## Memory

The memory option allows for messages to be stored internally to the display. These messages can be called up from the host device without the host device needing to generate the ASCII string required to show a message. 4 different memory sizes are available.

## Clock

Allows the current time and date to be used as a message and displayed. The time and date may be stored in the message text of a stored message. When the message is called up, the current time and/or date will be displayed. Also message number 0 may be set to display a running time and date.

The time or the date can be inserted into the text of a stored message also. See section on Special Text Characters for insertable time or date characters.

## Parallel Inputs

Allows a parallel device to call up messages by the message number from a host device with a parallel I/O modules. Message memory is also required if the parallel option is used.

## Data Logging

Allows the display to internally log all fault messages that were called up in the display. Creates a "log" file that will store fault messages and when they happened. Requires that 128K message memory, and the clock option also be installed.

## Interface Driver

Allows direct communication with a P.L.C.'s memory areas and other host devices and systems. (Call factory for P.L.C. types and operation).

## 4 / 14 Key Fault Display

A fault display option can be installed that utilizes an "extra" key on the display. This key is labeled **SELECT**. This allows the operator to view and/or print messages that have been shown on the display. Each stored message in the displays memory has a counter with the message, and this option allows an operator to see messages that have been called up on the display and used as a fault message. Each time a message has been called up on the display from memory, its counter is incremented by one. Maximum counter value is 255. The operation is as follows:

Press the **SELECT** key. A message will be displayed.

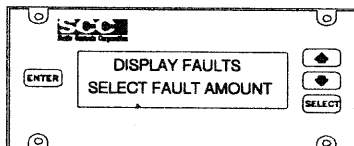

This message will be replaced after approx. 1 second by the message

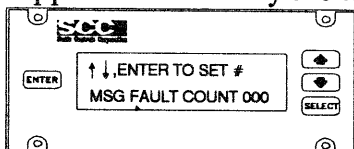

Using the up and down arrow keys, set the minimum value of the counter of each message that is to be shown. Press **ENTER** when the count value is set. The next message that will appear is

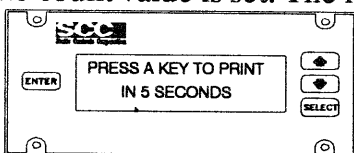

This message will count down in 1 second increments. If the up, down or enter key is pressed while it is counting down, the display will print the messages out to a printer. If no key is pressed within the 5 second countdown, the message will be displayed on the display. A message

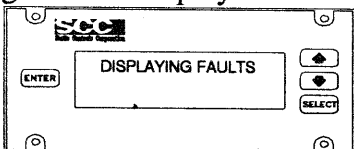

will appear for approx. 1 second. Then the messages with a count that is equal or greater to the minimum count that was entered.

Each message is shown as:

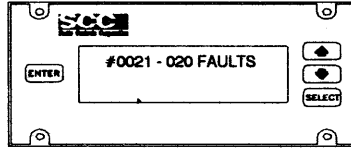

with the message number followed by the number of times the message was displayed. This is followed by the message text. Each of these 2 screens is shown for approx. 1 second each.

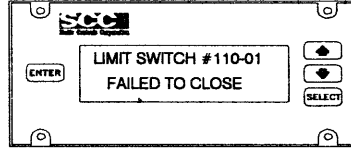

These 2 screens will cycle thru until all messages with the minimum count has been displayed. During the displaying of the messages, pressing the enter key and holding it down for approx. 1 second will stop displaying of the messages. When they are all shown the message



will appear. Then a message

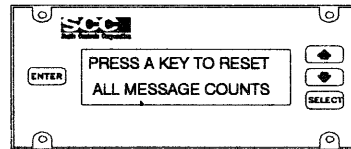

will appear. If all message counts are to be reset to 0, press a key while message

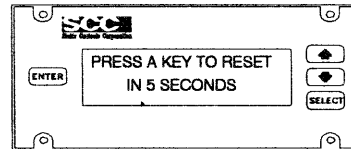

is counting down. This will reset all message counts to 0. If the message counters are not to be reset, let the message count down to 0. After this the display will return to normal operation.



## Marquee Display

The SCC 1000 series displays may also have a large overhead Marquee display attached that would "mirror" the small display on the unit. These Marquee offer a 2" or a 4" character size for visibility of the display at a large distance away from the SCC 1000 unit itself. Marquee displays may also be connected as a "slave" display to show only specific messages on a large overhead display. Contact the factory for configurations.

# DISPLAY PART NUMBERS



4224 Martin Road x Walled Lake, MI 48390 x Phone (313) 360-9000 x Fax (313) 360-8962

## S.C.C. SERIES 1000 OPERATOR INTERFACE DISPLAY PRICE LIST

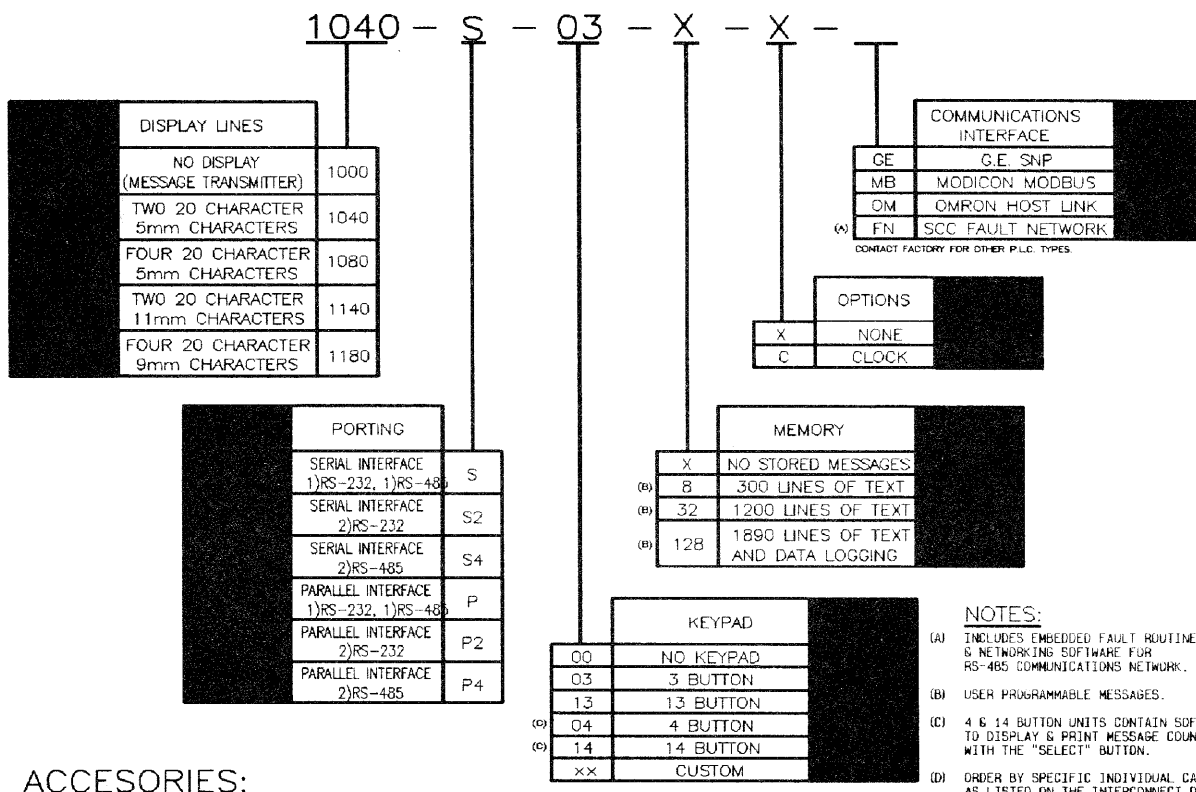

### ACCESSORIES:

910	MESSAGE LOGGER
920PS-12-2	12VDC @ 3.4A POWER SUPPLY
920PS-12-3	12VDC @ 5.1A POWER SUPPLY
920PS-24-2	24VDC @ 2.4A POWER SUPPLY
920PS-24-3	24VDC @ 3.6A POWER SUPPLY
AD-1000-xxx-A	CABLE ASSEMBLY
NAB-3	RS-232 TO RS-485 CONVERTER

### REPLACEMENT TERMINAL STRIPS

1000JP-1	12 POSITION (SERIAL)
1000JP-2	10 POSITION (PARALLEL)
1000JP-3	18 POSITION (PARALLEL)
1000JP-4	5 POSITION (PARALLEL)
1000DB9P	9 POSITION "D" + HOOD

CONTACT YOUR LOCAL DISTRIBUTOR OR STATIC CONTROLS CORP. FOR INFORMATION ON CUSTOM KEYPADS, DIRECT P.L.C. COMMUNICATIONS, OFFLINE MESSAGE PROGRAMMING SOFTWARE & NETWORKING SOFTWARE.

### ORDERING INFORMATION:

1040-S-03-X-X =

# SPECIFICATIONS

---

## > VOLTAGE

- Input voltage - 12VDC to 24VDC

---

## > CURRENT

- Input current 10xx - 2.4A inrush, 250mA operating @ 24VDC
- Input current 11xx - 2.9A inrush, 425mA operating @ 24VDC

---

## > SERIAL PORTS

- Serial ports - 2 ports, RS-232 or RS-485

---

## > PARALLEL PORTS

- Parallel I/O - 17 inputs, 6 outputs, optically coupled, 12 to 24Vdc, 8mA, sourcing inputs, sinking outputs

---

## > MESSAGE MEMORY

- Message memory - 8K (300 messages), 32K (1200 messages), 128K (1890 messages + data logging)

---

## > DISPLAY

- Display 10xx - 40 character (2 lines x 20 character) 5.0mm, 80 character (4 lines x 20 character) 5.0mm  
Visible from 10 feet.
  - Display 1140 - 40 character (2 lines x 20 character) 11.0mm Visible from 22 feet.
  - Display 1180 - 80 character (4 lines x 20 character) 9.0mm Visible from 18 feet.

---

## > KEYPAD

- Keypad - 3, 4, 13 and 14 key, full duplex transmission on serial port, constant or timed on parallel port

---

## > SIZE

- Size 10xx - approx. 7.0 x 3.75 x 3.5
- Size 11xx - approx. 12.2 x 4.2 x 4.0

---

## > CHARACTER SET

- Character set - extended ASCII character set, 244 displayable characters

# POWER SUPPLY POWER UP GRAPHS.

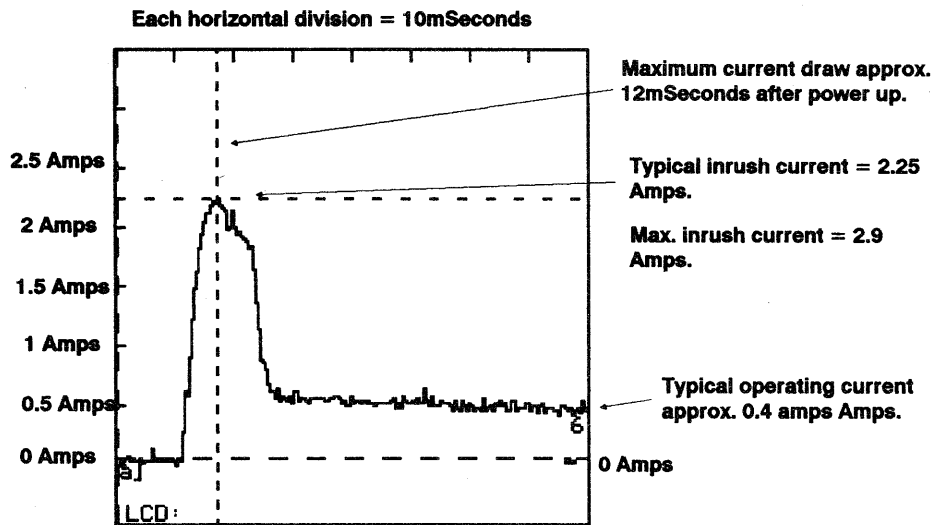
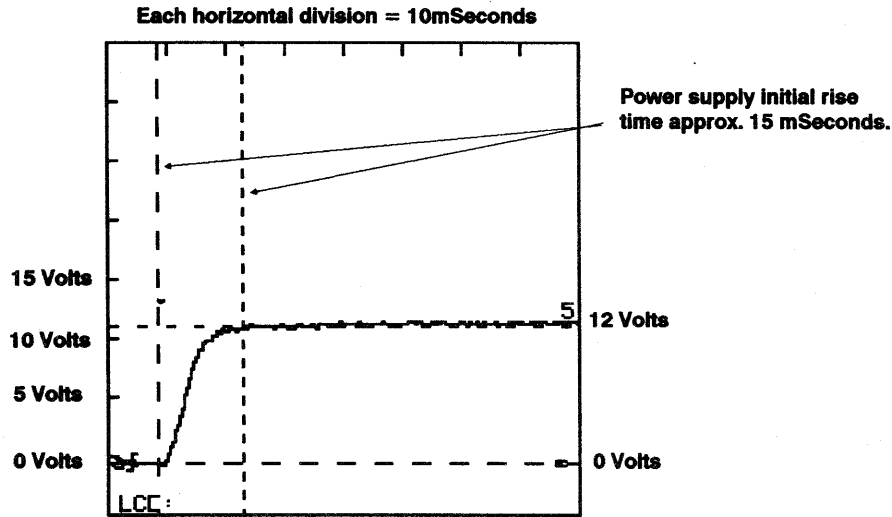

## 12 volt power supply.

Each horizontal division = 10mSeconds

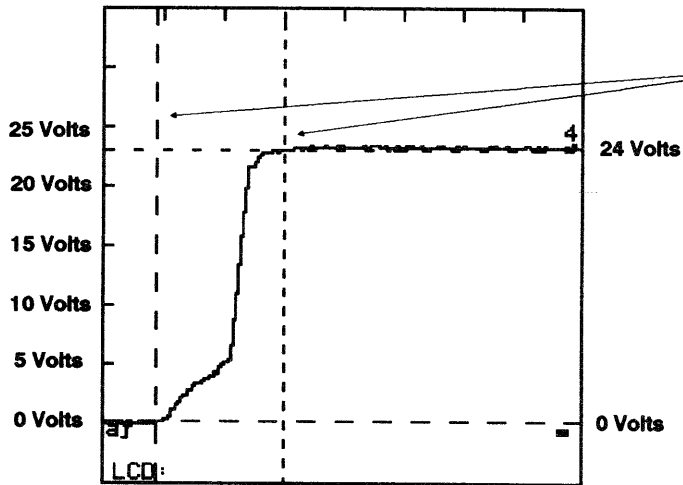

Power supply initial rise time approx. 22 mSeconds.

Each horizontal division = 10mSeconds

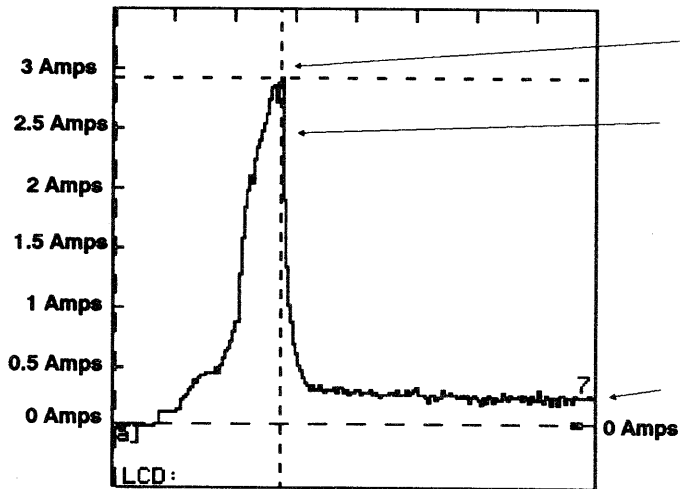

Maximum current draw approx. 22mSeconds after power up.

Typical inrush current = 2.8 Amps.

Max. inrush current = 3.0 Amps.

Typical operating current approx. 0.2 amps Amps.

## 24 volt power supply

# SOFTWARE OPERATIONAL REVISIONS

---

**Soft. Rev. #1** On software versions 1.xx the variable data is inputted to the display in the same manner as the message number. If the message number is strobed in, the variable data is also strobed in. If sampling is done to input the message number, the variable data is also sampled.

On software version 2.00 the variables are always strobed in, no matter how the message is inputted.

On software versions greater than 2.00 the variables are set by the operator during the display set-up to be strobed in or sampled.

---

**Soft. Rev #2** On software versions 1.xx messages are uploaded to the display or downloaded from the display while in "SINGLE UNIT" Mode. Software versions 2.xx and up require that the display be in the "MESSAGE FILE" mode to upload or download messages to the displays internal memory.

---

**Soft Rev #3** On software versions 2.xx and up, the hex characters \$02 and \$03 can be sent thru the pass thru port. The escape character cannot be sent thru the pass thru port on any version.

---

**Soft Rev #4** On software versions 3.xx and up, SCC Networking is a selectable mode if the -FN fault networking option is ordered.

---

**Soft Rev #5** On software versions 3.xx and up, the keypad output options listed are available. On versions before 3.xx, the keypad operates in BUFFERED OUTPUT / HDX mode.

---

**Soft Rev #6** The mode changing 2 button keys were added for versions #3.08 and greater.

---

**Soft Rev #7** This output mode for parallel outputs was added in version #3.23 and up.

---

**Soft Rev #8** The key repeat function was added in version #3.23 and up. Versions prior to this operated as key repeat is off.

---

**Soft Rev #9** This function was added to version #3.38 and up.

---

**Soft Rev #10** The default settings, changing into message load mode, and displaying of the software version was added for versions #3.37 and up.

---

# DRAWINGS

BELOW IS A LISTING OF DRAWINGS IN THE MANUAL

DD-1000-001-A

DD-1000-002-A

DD-1000-003-A

DD-1000-011-A

DD-1000-060-A

DD-1000-078-A

DD-1100-077-A

AD-1000-005-A

AD-1000-006-A

AD-1000-007-A

AD-1000-008-A

AD-1000-010-A

AD-1000-030-A

AD-1000-047-A

AD-1000-056-A

ED-1000-012-A

ED-1000-013-A

ED-1000-021-A

ED-1000-027-B (1 of 3)

ED-1000-027-B (2 of 3)

ED-1000-027-B (3 of 3)

ED-1000-055-A

ED-1000-057-A

ED-1000-060-A

ED-1000-070-A

ED-1000-071-A

NP-1000-089-A





REDUCED DRAWING

SYM	REVISION	APP	DATE
A	REVISED DEPTH	TCS	11/28/90
B	PARALLEL DEPTH	TCS	2/19/91

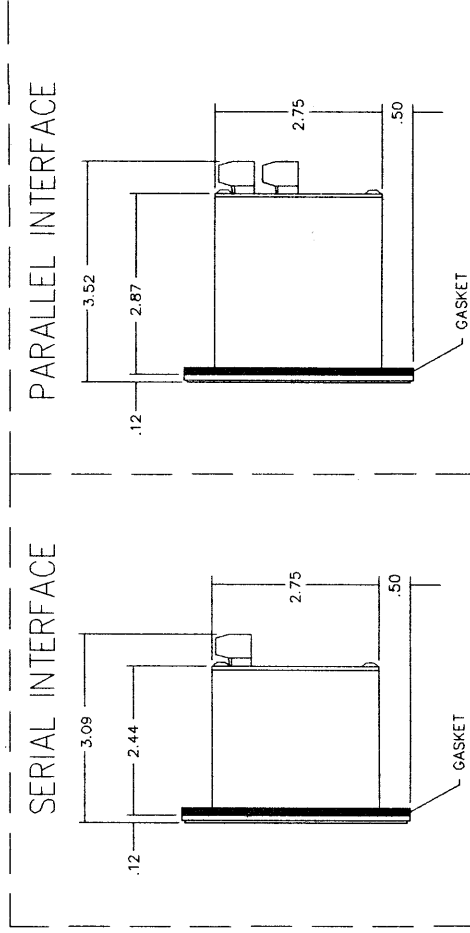
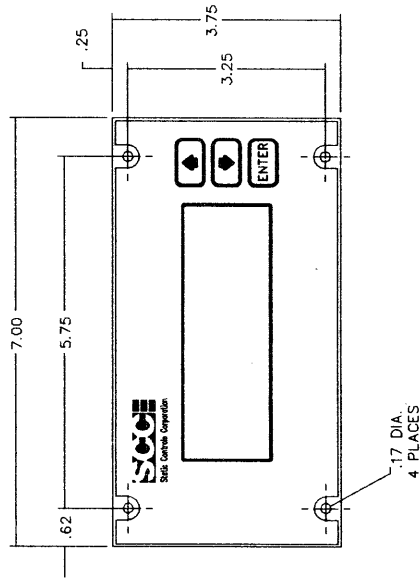
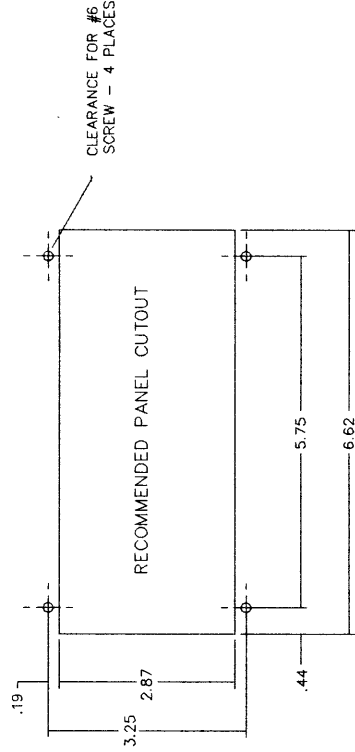
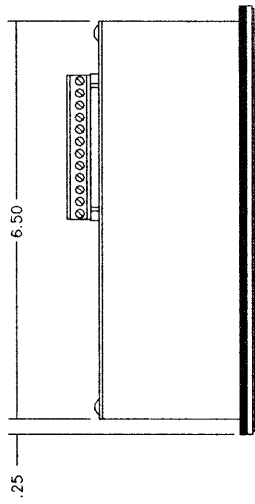

 Static Controls Corporation 4224 MARTIN ROAD WALLED LAKE, MI. 48390 (313) 360-9000 FAX (313) 360-8962	Dr.	TCS	Title	1000 OPERATOR INTERFACE
	App	TCS	File #	DD100001.SKD
	Date	8/15/90	Part #	SCC_1000
	Scale	NTS	DWG #	DD-1000-001-A
			Page #	1 of 1

NOTE: ALL BUTTON OPTIONS ARE IN THE SAME SIZE ENCLOSURE.

SYM	REVISION	APP	DATE

INPUT VOLTAGE: 120 VAC

OUTPUT VOLTAGE: 24 VDC @ 2.4A

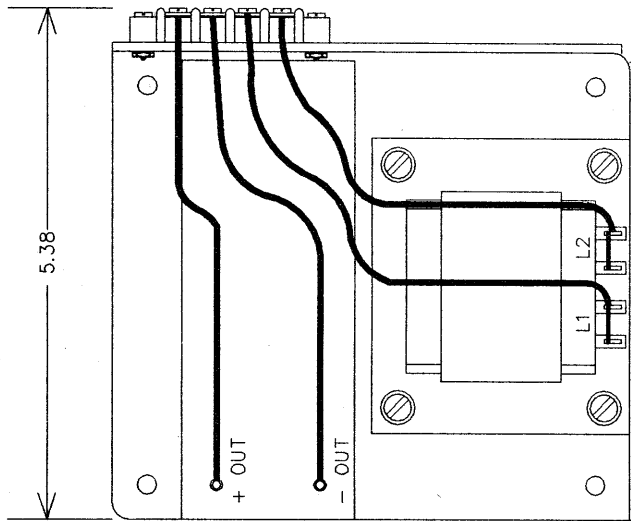
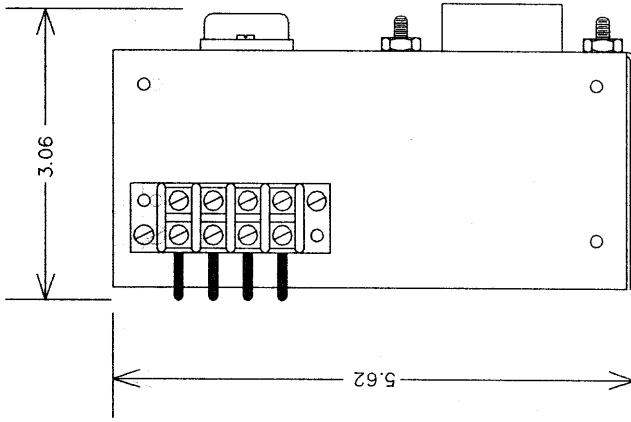

ORDERING INFORMATION:  
920PS-24-2

NOTE:  
THIS POWER SUPPLY IS CAPABLE OF DRIVING ONE 1040 OR 1080 DISPLAY. LARGER SUPPLIES ARE AVAILABLE TO DRIVE MULTIPLE DISPLAYS. CONSULT FACTORY FOR ADDITIONAL INFORMATION.

 <p>Static Controls Corporation 4224 MARTIN ROAD WALLED LAKE, MI. 48390 (313) 360-9000 FAX (313) 360-8962</p>	TCS App	Title DIMENSIONS FOR 24VDC @ 2.4A POWER SUPPLY 1000 SERIES
	Date 11/11/81	Part # 920PS-24-2 (C) 1 of 1
Scope NTS	File # ED087011 SKD (Page 1 of 1)	DWG # DD-1000-002-A

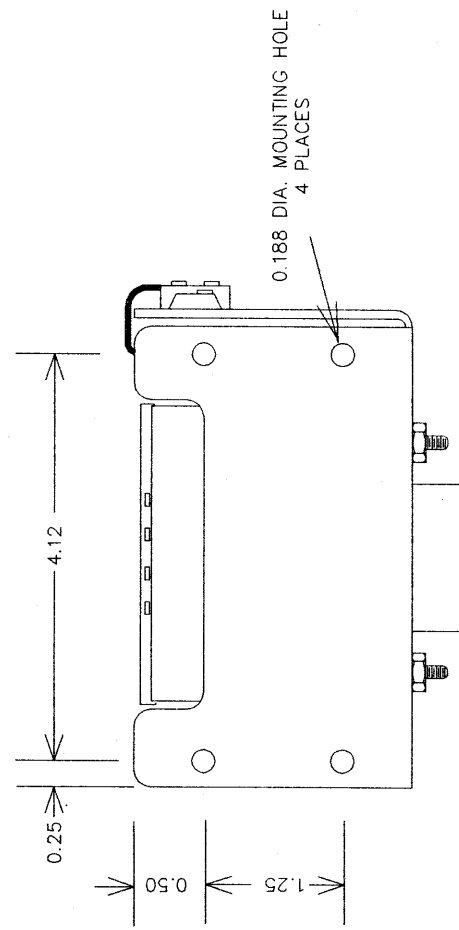

REDUCED DRAWING

SYM	REVISION	APP	DATE

INPUT VOLTAGE: 120 VAC

OUTPUT VOLTAGE: 24 VDC @ 3.6A

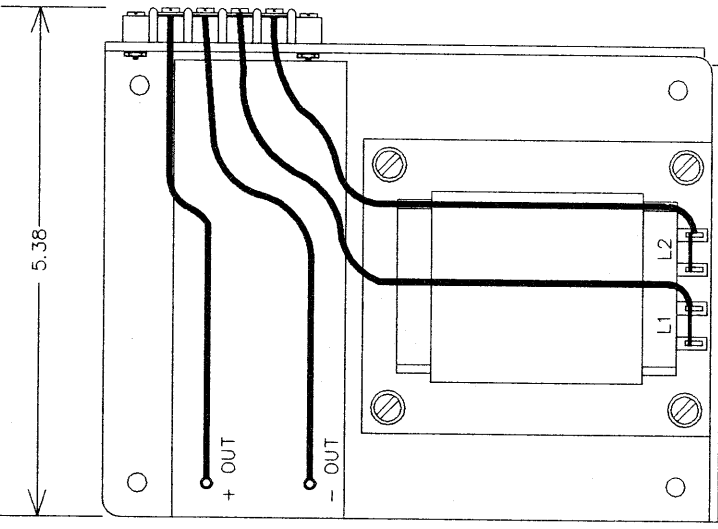
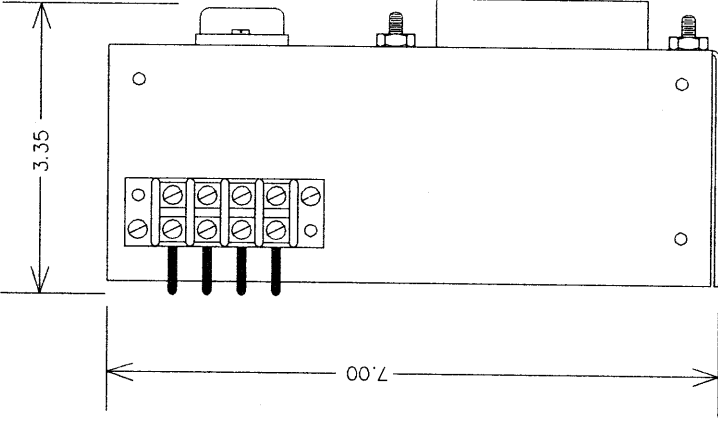



ORDERING INFORMATION:

920PS-24-3

NOTE:

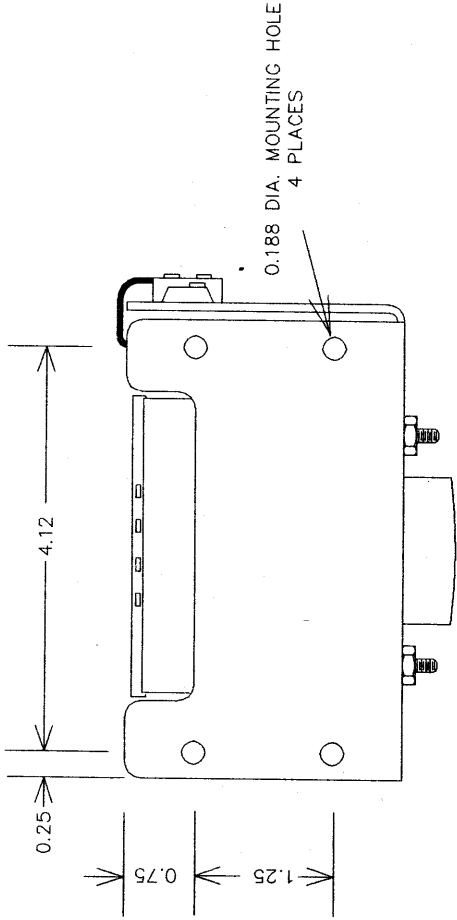
THIS POWER SUPPLY IS CAPABLE OF DRIVING ONE 1140 OR 1180 DISPLAY.



 Static Controls Corporation 4224 MARTIN ROAD WALLED LAKE, MI 48390 (313) 369-8862 FAX (313) 369-8862	Title <b>POWER SUPPLY</b> 24VDC @ 3.6A DIMENSIONS	Part # SCC 920-1000 Rev # 1 Date 4/22/82 Scale	Drawn by TCS App TCS Checked by NTS
	File # DD100003.SKD Page # 1 of 1 DWG # DD-1000-003-A	0.188 DIA. MOUNTING HOLE 4 PLACES	

REDUCED DRAWING

SYM	REVISION	APP	DATE

NOTE: MOUNT COVER WITH (4) #6 FLAT HEAD SCREWS

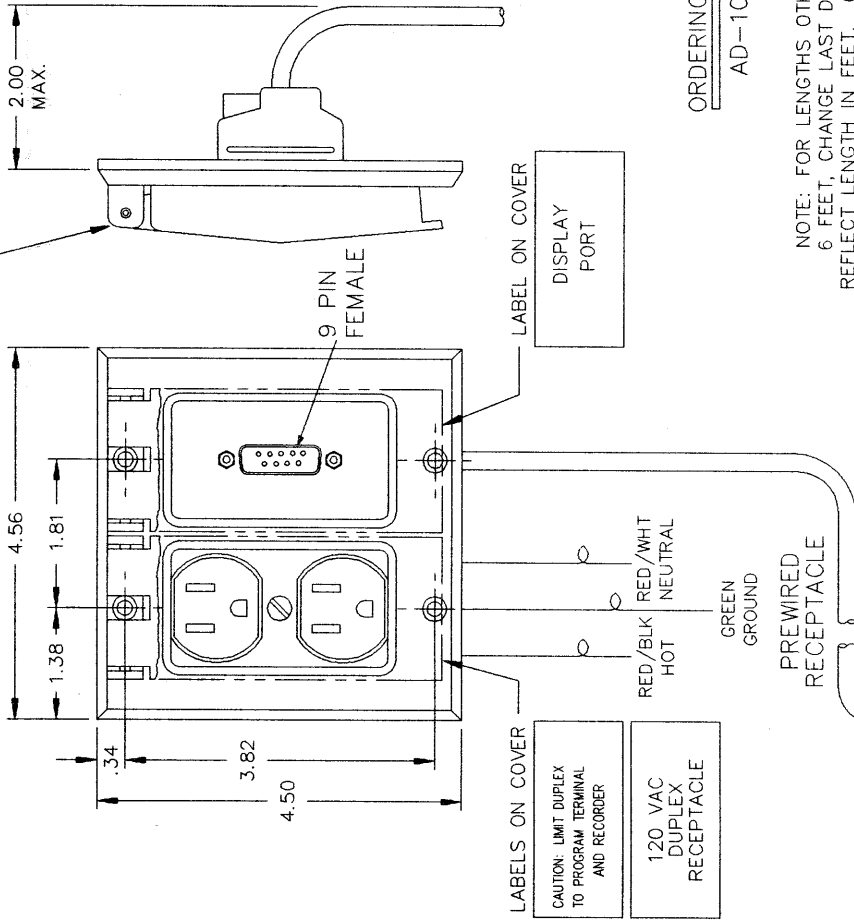

RECOMMENDED PANEL CUTOUT

ORDERING INFORMATION:

AD-1000-011-A-6 : WEATHERPROOF COVER ASSEMBLY WITH PREWIRED DUPLEX AND 6' 9 PIN DISPLAY CABLE EXTENDER

NOTE: FOR LENGTHS OTHER THAN 6 FEET, CHANGE LAST DIGIT(S) TO REFLECT LENGTH IN FEET. (MAX. 20 FT.)

 <p>Static Controls Corporation 4224 MARTIN ROAD WALLED LAKE, MI. 48390 (313) 360-9000 FAX (313) 390-8962</p>	Dr	TCS	Title
	App	TCS	WEATHERPROOF COVER WITH PREWIRED DUPLEX & 9 PIN EXTENDER
	Date	10/30/91	Part # SCC 1000 SERIES
	Scale	NTS	File # DD100011.SKD (Page # 1 of 1)
			DWG # DD-1000-011-A

REDUCED DRAWING

SYM	REVISION	APPL	DATE

MOUNTS WITH 2 EXISTING SCREWS TO COVER PLATE OF T-60.

CONFIGURE DIP SWITCHES.

RS-485 CONNECTIONS FOR 2 WIRE NETWORK. (PLUG IN T.S.)

120 VAC JUMP TO SAME ON BACK OF T-60. (PLUG IN T.S.)

CONFIGURE DIP SWITCHES.

RS-232 9 PIN CONNECTOR TO COM2 OF T-60. (6 FOOT CABLE)

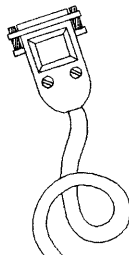

SCC NAB-3 RS-232 TO RS-485 CONVERTER.

VIEW OF RS-232 SIDE OF CONVERTER.

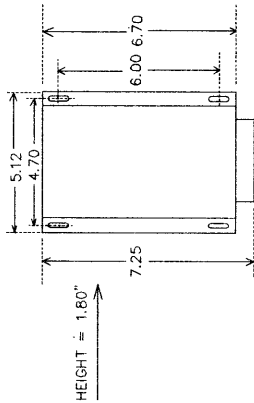
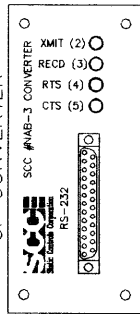

NOTES:

- 1) 254 MASTERS PER COMM. PORT (MAX).
- 2) 30 SLAVES PER MASTER (MAX).
- 3) 4000 FOOT MAX. LENGTH OF NETWORK WIRING WITHOUT REPEATER.
- 4) EACH REPEATER INCREASES LENGTH ANOTHER 4000 FEET.

2 WIRE NETWORK Belden Cable #9463

SCC1080 4 LINE MASTER DISPLAYS

2 WIRE SLAVE COMMUNICATIONS Belden Cable #9463

RS-485 CONNECTION TO SCC1080 SLAVE FROM ANY MASTER. (MULTIPLE SLAVES)

CONVERTER

T-60

SCC1080 4 LINE SLAVE DISPLAYS

<p>Static Controls Corporation</p> <p>4224 MARTIN ROAD WALLED LAKE, MI. 48390 (313) 360-9000 FAX (313) 360-8962</p>		<p>Title</p> <p>SCC NAB-3 NETWORK ADAPTER</p>
<p>TCS App</p>	<p>Date</p> <p>3/23/92</p>	<p>Part #</p> <p>SCC NAB-3</p>
<p>Scale</p> <p>NTS</p>	<p>File #</p> <p>DD100060.SKD</p>	<p>Page #</p> <p>1 of 1</p>
<p>DD-1000-060-A</p>		

DRILL THRU FOR  
6-32 SCREW  
4 PLACES

6.625  
5.750

3.250  
2.875

0.438

0.188

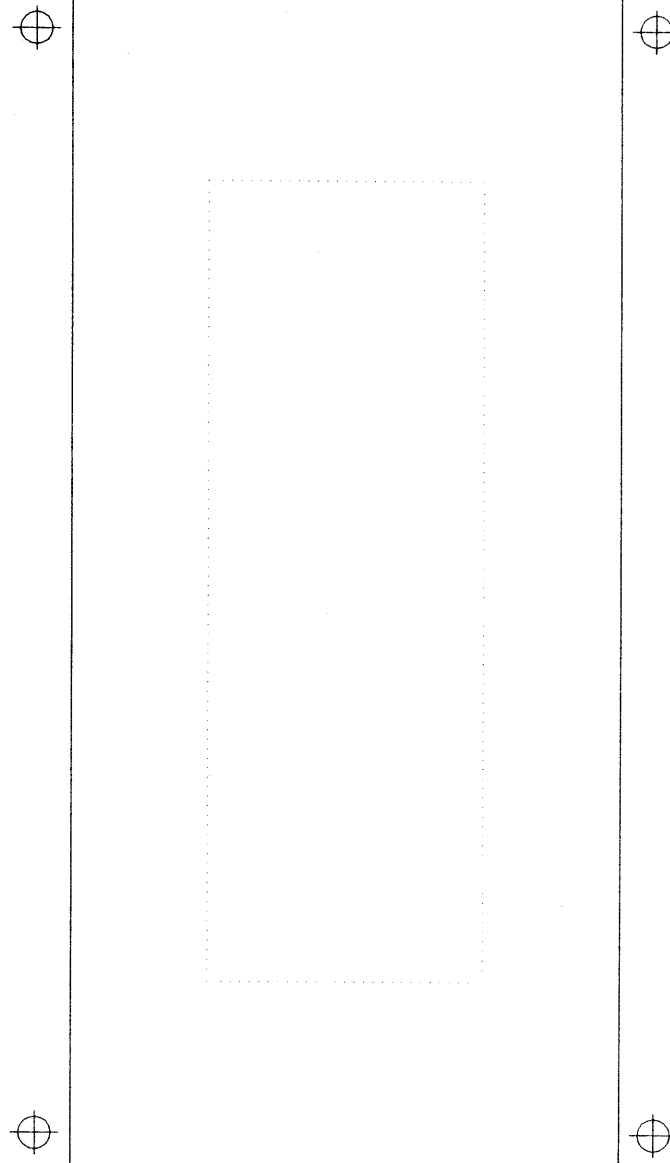

SYM	REVISION	APP	DATE

**SCC**  
Static Controls Corporation

4224 MARTIN ROAD  
WALLED LAKE, MI 48390  
(313) 360-9000  
FAX (313) 360-8962

Dr. TCS  
App. TCS  
Date: 7/9/92  
Scale: FULL

Title: SCC 1000 SERIES  
DISPLAY  
CUTOUT  
TEMPLATE

Part # SCC 1000 (Layer 1)  
File # DD100078.SKD (Page # 1 of 1)  
DWG # DD-1000-078-A

# RECOMENDED CUTOUT TEMPLATE

REDUCED DRAWING

SYM	REVISION	APP DATE
	ALL DIMENSIONS FOR EXTRUSION FINAL DIMENSIONS	TS 2/92 TS 8/92

RECOMENDED PANEL CUTOUT

DRILL HOLES FOR  
CLEARANCE FOR 10-24  
SCREWS  
(6 PLACES)

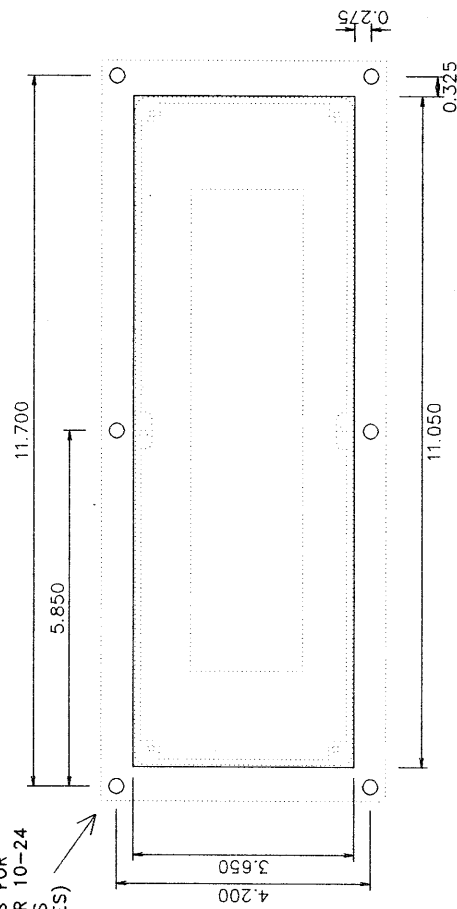
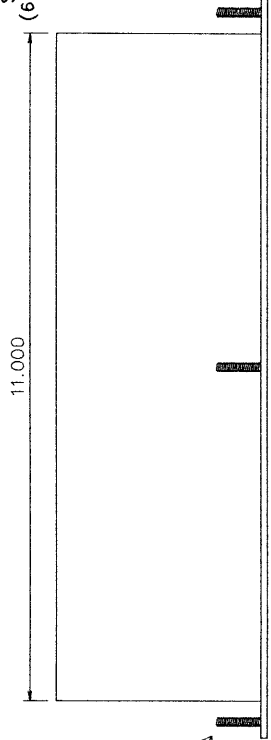

PARALLEL UNIT  
DEPTH

SERIAL UNIT  
DEPTH

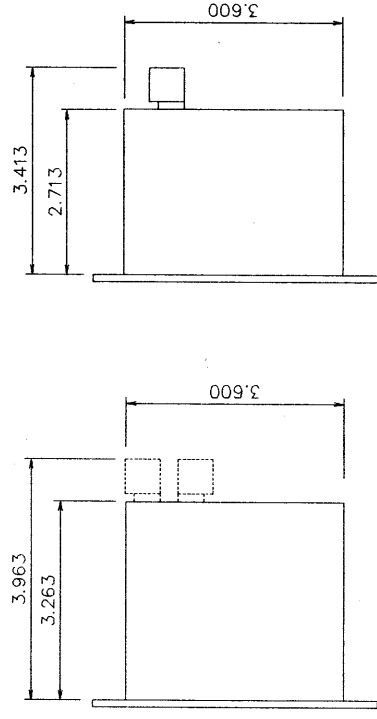
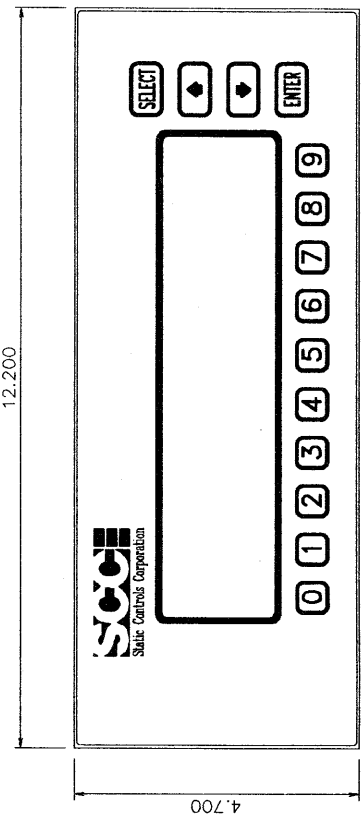

	Dr	TCS	Title	SCC1100
	App	TCS	OPERATOR INTERFACE DIMENSIONS	
Controls Diagnostics Communications Static Controls Corporation 4224 MARTIN ROAD WALLED LAKE, MI. 48390 (313) 360-9000 FAX (313) 360-8962		Date	Part #	Layer #
		2/12/92	SCC 1100	1
		Scale	File #	Page #
		NTS	DD110077-SKD	1 of 1
			DWG #	DD-1100-077-A

SYM REVISION	APP DATE
ADDED PART #S	10/91

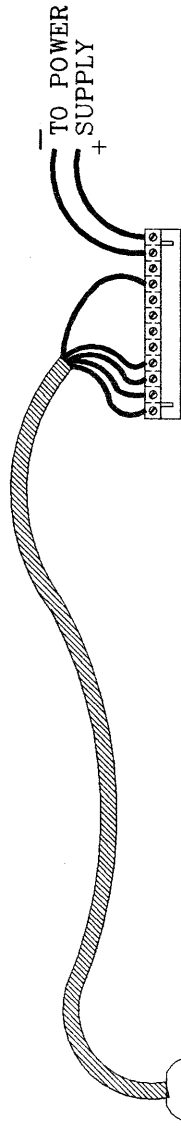

25 PIN FEMALE "D" CONNECTOR

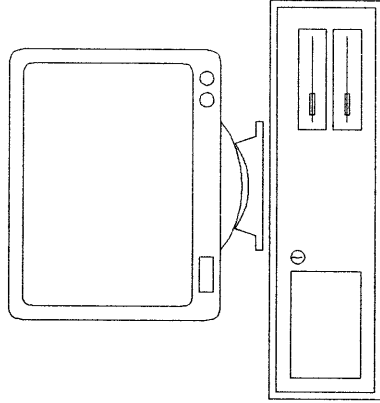

IBM OR COMPATIBLE COMPUTER

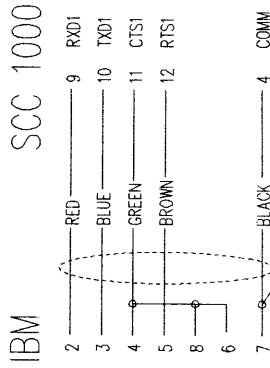

IBM SCC 1000

SCC 1xxx DISPLAY  
W/ SERIAL INPUTS

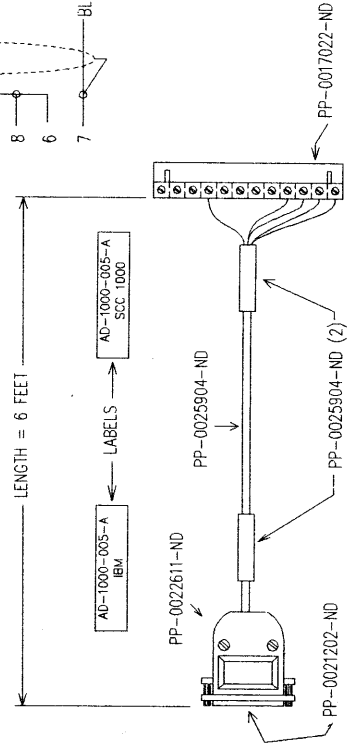
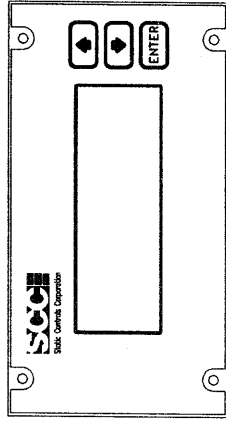

 <b>Static Controls Corporation</b> 4224 MARTIN ROAD WALLED LAKE, MI. 48390 (313) 360-9000 FAX (313) 360-8962	Title <b>1000 OPERATOR INTERFACE</b>	Part # <b>SCC 1000</b>
	App <b>TCS</b>	Date <b>5/22/91</b>
File # <b>AD100005.SKD</b>	Scale <b>NTS</b>	Page # <b>1 of 1</b>
DWG # <b>AD-1000-005-A</b>		



SYM	REVISION	APP	DATE
	IBM PINOUT REVISED		6/5/91
	ADDED PART #'S		10/91

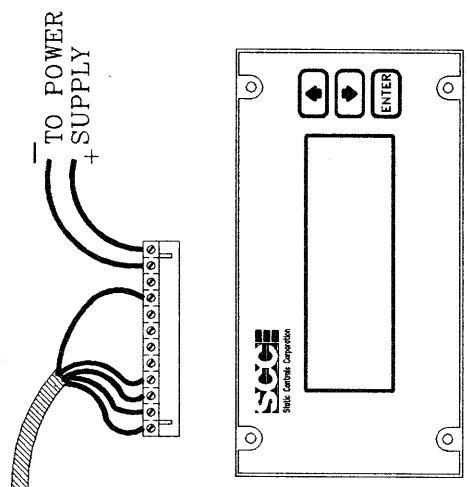

SCC 1000 DISPLAY  
W/ SERIAL INPUTS

9 PIN FEMALE "D" CONNECTOR

IBM SCC 1000

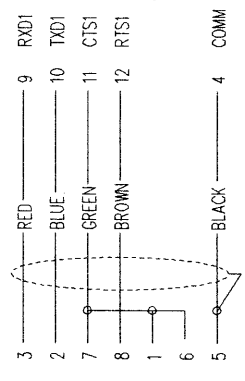

IBM OR COMPATIBLE COMPUTER

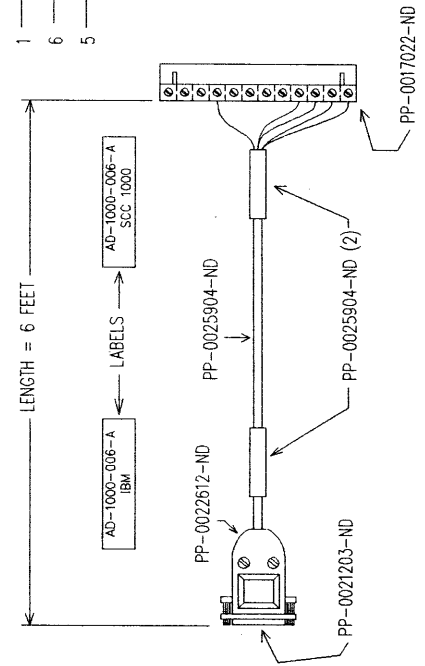
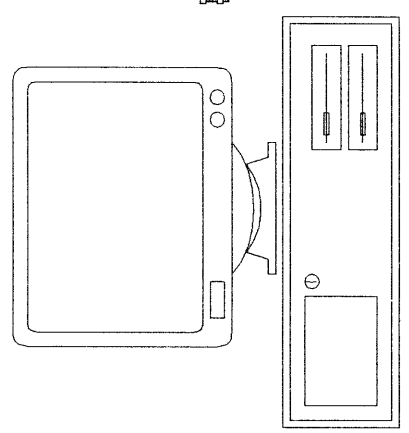

<p>Static Controls Corporation</p>		<p>Controls Diagnostics Communications</p>	
Dr	TCS	Title	1000 OPERATOR INTERFACE
App	TCS	Serial Port Connections	SERIAL PORT CONNECTIONS
Date	5/23/91	I.B.M. 9 PIN PORT	I.B.M. 9 PIN PORT
Scale	NTS	Part #	SCC 1000
		File #	AD1000G.SKD (Page # 1 of 1)
		DWG #	AD-1000-006-A
<p>4224 MARTIN ROAD WALLED LAKE, MI. 48390 (313) 360-9000 FAX (313) 360-8962</p>			

REDUCED DRAWING

SYM	REVISION	APP	DATE
	IBM PINOUT REVISED		6/5/91
	ADDED PART #'S		10/91

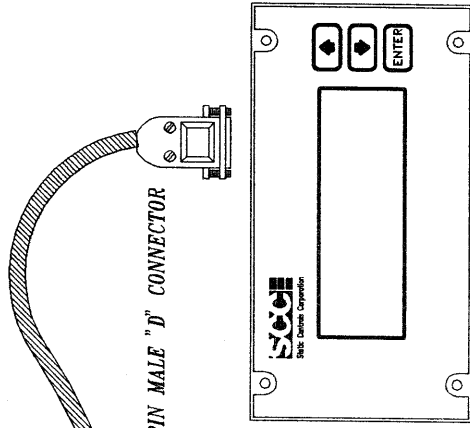

SCC 1xxx DISPLAY  
W/ PARALLEL INPUTS

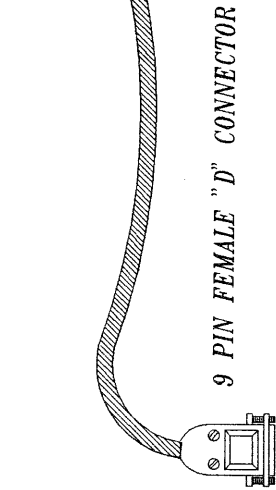

9 PIN FEMALE "D" CONNECTOR

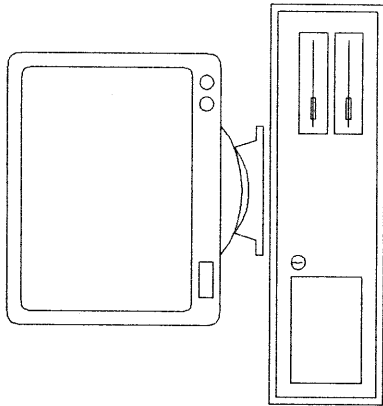

IBM OR COMPATIBLE COMPUTER

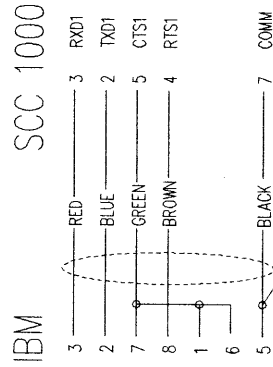

IBM SCC 1000

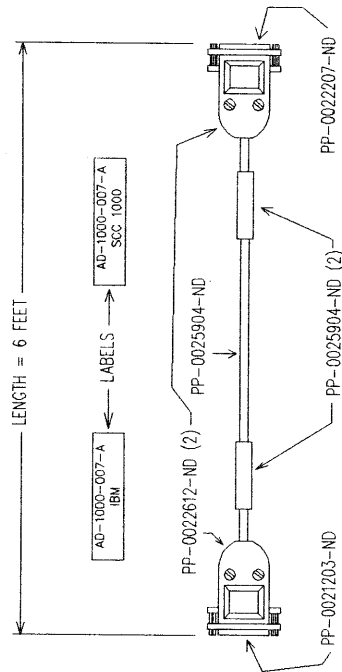

 Static Controls Corporation 4224 MARTIN ROAD WALLED LAKE, MI. 48390 (313) 360-9000 FAX (313) 360-8962	Dr. TCS App TCS Date 5/18/91 Scale NTS	Title 1000 OPERATOR INTERFACE SERIAL PORT CONNECTIONS PARALLEL INTERFACE I.B.M. 9 PIN PORT Part # SCC 1000 File # AD100007.SKD (Edge # 1 of 1) DWG # AD-1000-007-A
	Dr. TCS App TCS Date 5/18/91 Scale NTS	

REDUCED DRAWING

SYM	REVISION	APP	DATE
	ADDED PART #S		10/91

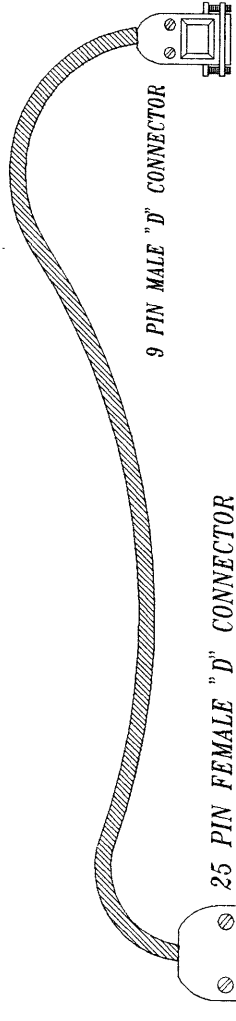

25 PIN FEMALE "D" CONNECTOR

9 PIN MALE "D" CONNECTOR

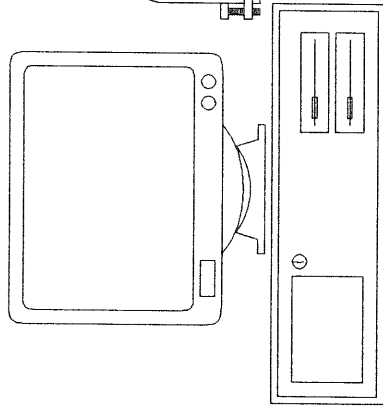

IBM OR COMPATIBLE COMPUTER

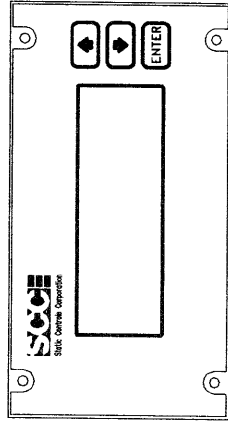

SCC 1xxx DISPLAY

W/ PARALLEL INPUTS

IBM

SCC 1000

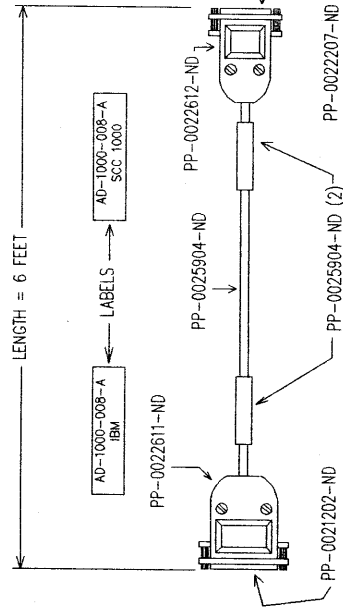
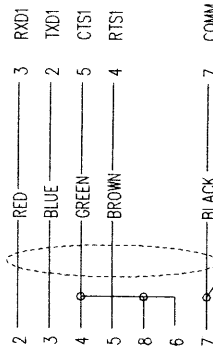

LENGTH = 6 FEET

 Static Controls Corporation 4224 MARTIN ROAD WALLED LAKE, MI. 48390 (313) 360-9000 FAX (313) 360-8962		Title 1000 OPERATOR INTERFACE SERIAL PORT CONNECTIONS PARALLEL INTERFACE I.B.M. 25 PIN PORT
Dr	TCS	Part # SCC 1000
App	TCS	File # AD100008.SKD
Date	5/19/91	DWG # AD-1000-008-A
Scale	NTS	Page # 1 of 1

SYM	REVISION	APP DATE
	ADDED PART #S	10/91

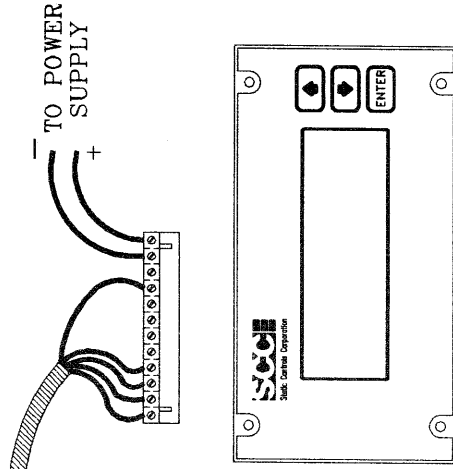

SCC 1000 DISPLAY  
W/ SERIAL INPUTS

25 PIN MALE "D" CONNECTOR

- TERMINAL SCC 1000
- 2 RED 9 RXD1
  - 3 BLUE 10 TXD1
  - 4 GREEN 11 CTS1
  - 5 BROWN 12 RTS1
  - 7 BLACK 4 COMM

STANDARD "DUMB" TERMINAL

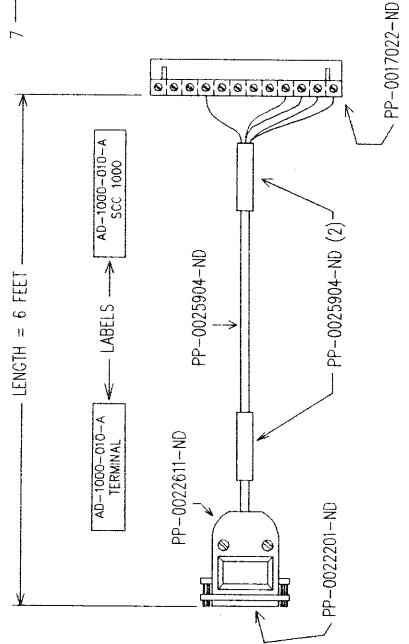
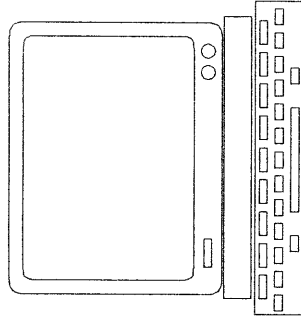

Static Controls Corporation

4224 MARTIN ROAD  
WALLED LAKE, MI. 48390  
(313) 566-9000  
FAX (313) 560-8962

Dr TCS

App TCS

Date 5/22/91

Scale

NTS

Title 1000 OPERATOR INTERFACE  
SERIAL PORT CONNECTIONS  
SERIAL INTERFACE  
DUMB TERMINAL 25 PIN PORT

Part # SCC 1000

File # AD100010.SKD (Page # 1 of 1)

DWG # AD-1000-010-A

SYM	REVISION	APP	DATE

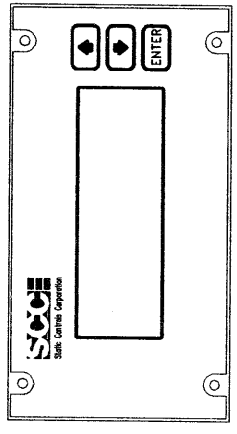
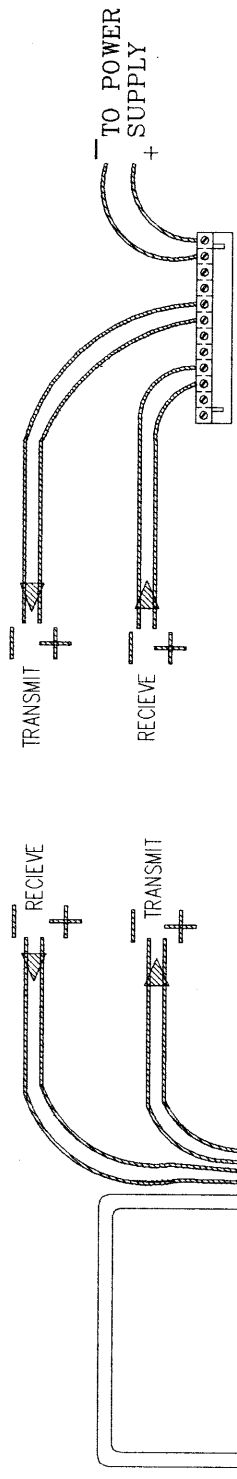

SCC 1xxx DISPLAY  
W/ SERIAL INPUTS

SCC 1000 DISPLAY  
PINOUT

TRANSMIT +	COM2+	PIN #6
TRANSMIT -	COM2-	PIN #5
RECEIVE +	COM1+	PIN #10
RECEIVE -	COM1-	PIN #9

IBM OR COMPATIBLE COMPUTER  
WITH RS-422 or RS-485  
4 WIRE PORT

SCC1000 DISPLAY  
With  
2) RS-485 PORTS

Static Controls 1000 Series Display  
RS-422, 4 Wire, Full Duplex Communications.

PORT #1 = RECEIVE  
PORT #2 = TRANSMIT

	Dr	TCS	Title	1000 OPERATOR INTERFACE
	App	TCS	Serial Port Connections	RS-422, 4 WIRE
Static Controls Corporation 4224 MARTIN ROAD WALLED LAKE, MI. 48390 (313) 360-9000 FAX (313) 360-8962		Date	7/8/91	FULL DUPLEX COMMUNICATIONS
		Part #	SCC 1000	
		File #	AD100030.SKD	Page # 1 of 1
		DWG #	AD-1000-030-A	
		Scale	NTS	

REDUCED DRAWING

SYM	REVISION	APP	DATE

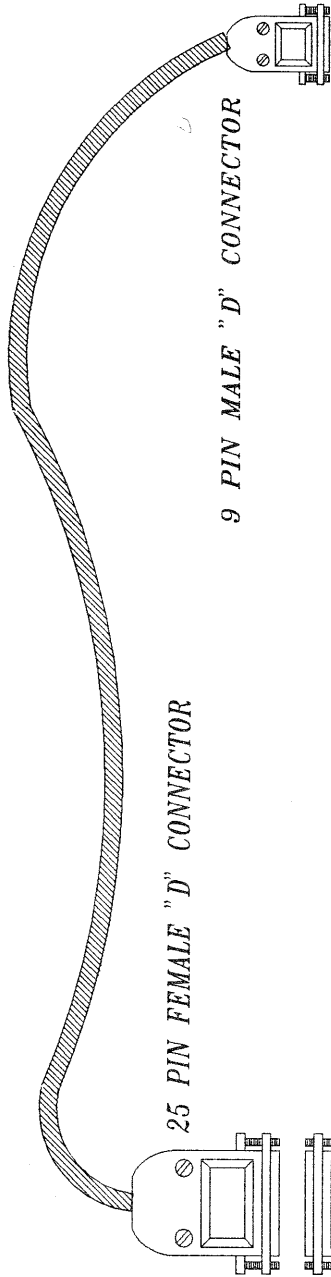

25 PIN FEMALE "D" CONNECTOR

9 PIN MALE "D" CONNECTOR

SCC 910 MESSAGE LOGGER

SCC 1000 DISPLAY

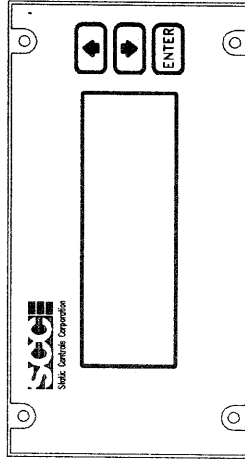
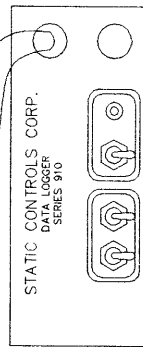
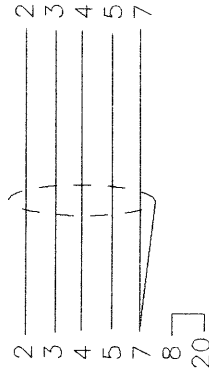

SCC 1xxx DISPLAY  
W/ PARALLEL INPUTS

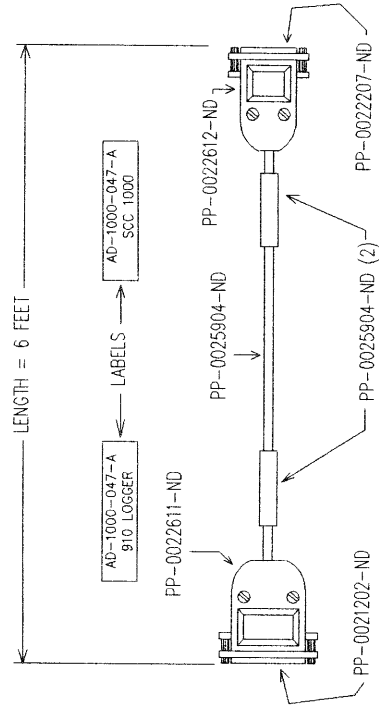

<p>Static Controls Corporation 41224 MARTIN ROAD WALLED LAKE, MI 48390 FAX (313) 360-8962</p>	Dr	TCS	Title	SERIES 910 LOGGER
	App	TCS	SERIES 1000 DISPLAY	COMMUNICATION CABLE
	Date	7/27/82	Part #	SCC 1000
Scale	NTS	File #	AD100047.SKD	Page # 1 of 1
		OWS #	AD-1000-047-A	

SYM	REVISION	APP	DATE

25 PIN MALE "D" CONNECTOR

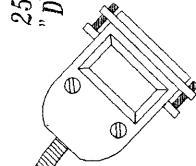

9 PIN FEMALE "D" CONNECTOR

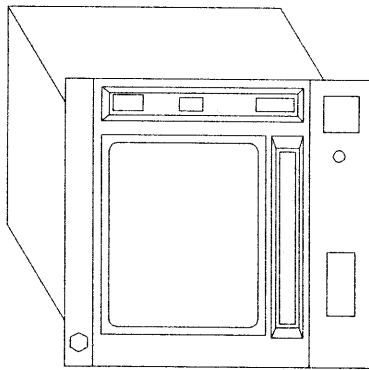
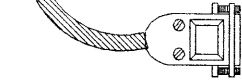

ALLEN BRADLEY T-60 TERMINAL  
OR IBM COMPATIBLE COMPUTER

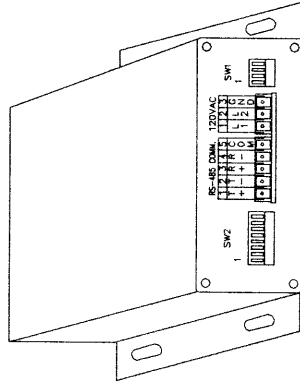
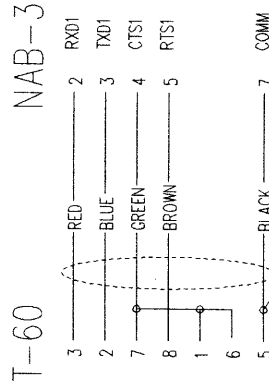

SCC NAB-3 CONVERTER

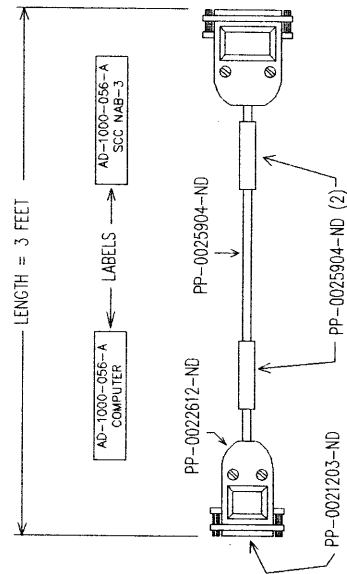

<p>Static Controls Corporation</p> <p>4224 MARTIN ROAD WALLED LAKE, MI. 48390 (313) 360-9000 FAX (313) 360-8962</p>	Title NAB-3 CONVERTER SERIAL PORT CONNECTIONS I.B.M. 9 PIN PORT (AB T-60 TERMINAL)	Part # SCC 1000 File # AD100056.SKD Page # 1 of 1
	Date 7/6/92	Scale NTS

REDUCED DRAWING

SYM	REVISION	APP	DATE

CABLES THAT CONNECT TO THE I.B.M. ARE AVAILABLE WITH 9 PIN OR 25 PIN CONNECTORS.

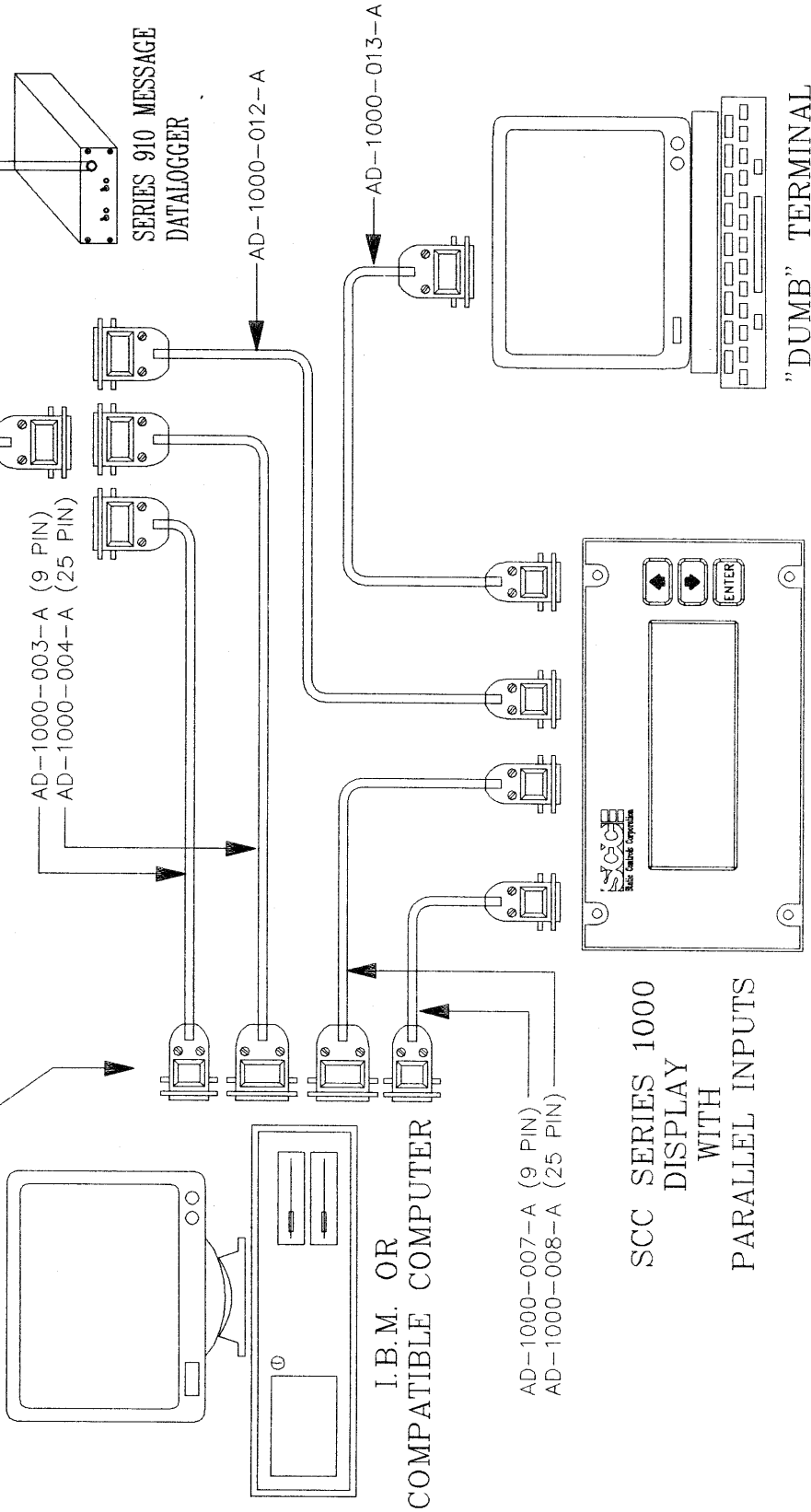

SERIES 1000 & 1100 SERIAL COMMUNICATION CABLES.

 <p>Static Controls Corporation</p>	<p>Controls Diagnostics Communications</p>	<p>Title COMMUNICATIONS CABLES FOR 1000 SERIES DISPLAY PARALLEL INPUT</p>
	<p>App TCS</p>	<p>Date 11/14/91</p>
<p>4224 MARTIN ROAD WALLED LAKE, MI. 48390 (313) 360-9000 FAX (313) 360-8962</p>	<p>Part # SCC 1000</p>	<p>File # ED100012.SKD Page # 1 of 1</p>
<p>Scale NTS</p>	<p>DWG # ED-1000-012-A</p>	<p>Layer 3</p>



REDUCED DRAWING

SYM	REVISION	APP	DATE

CABLES THAT CONNECT TO THE I.B.M. ARE AVAILABLE WITH 9 PIN OR 25 PIN CONNECTORS.

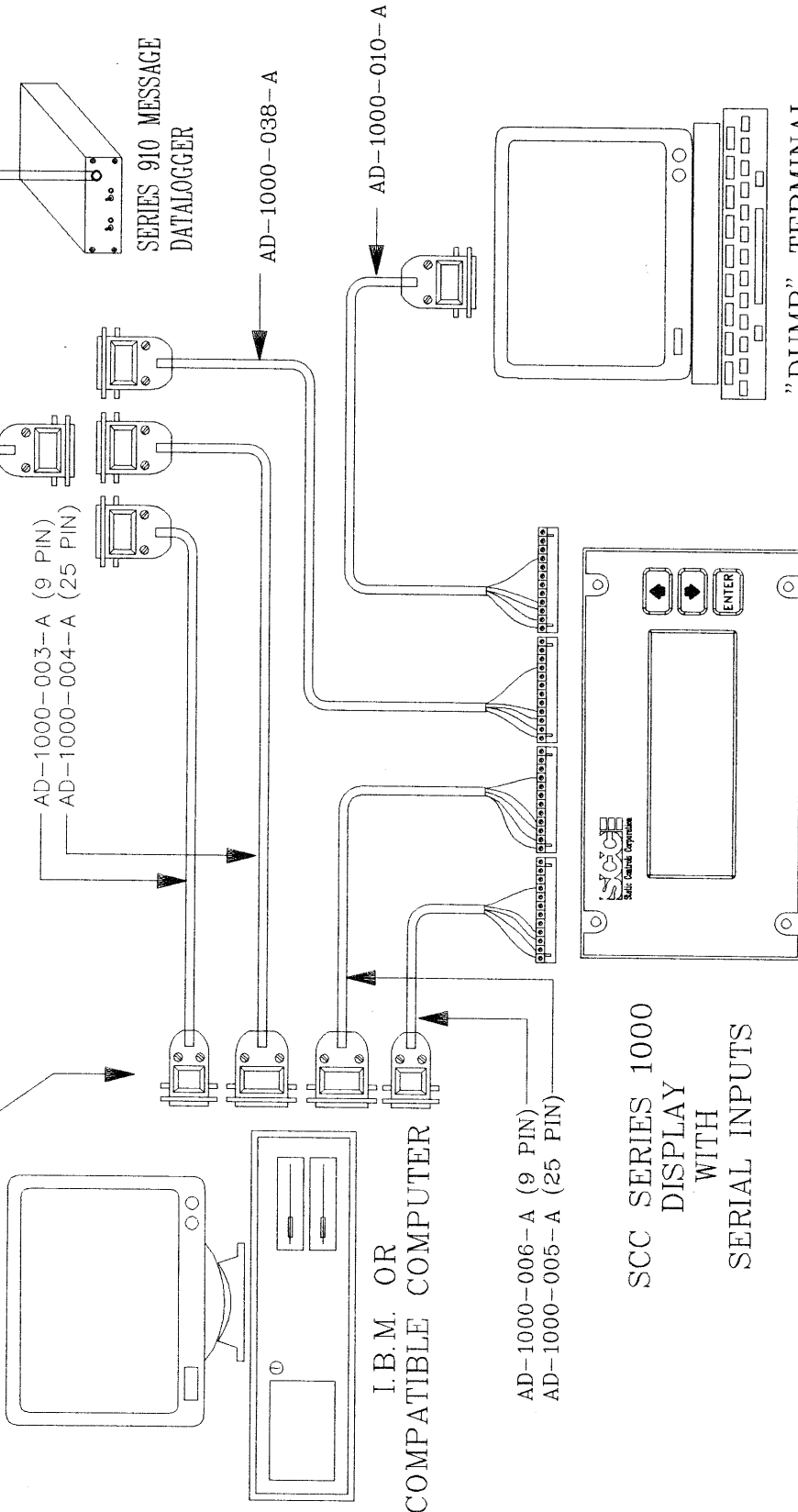

I.B.M. OR COMPATIBLE COMPUTER

AD-1000-006-A (9 PIN)  
AD-1000-005-A (25 PIN)

SCC SERIES 1000 DISPLAY WITH SERIAL INPUTS

"DUMB" TERMINAL

SERIES 910 MESSAGE DATALOGGER

AD-1000-038-A

AD-1000-010-A

SERIES 1000 & 1100 SERIAL COMMUNICATION CABLES.

<p>Static Controls Corporation 4224 MARTIN ROAD WALLED LAKE, MI. 48390 (313) 360-9000 FAX (313) 360-8962</p>	Dr	TCS	Title	COMMUNICATIONS CABLES FOR 1000 SERIES DISPLAYS SERIAL INPUT
	App	TCS	Date	11/14/81
		Part #	SCC 1000	Layer 1
		File #	ED100012.SKD	Page # 1 of 1
		Scale	DWG #	ED-1000-013-A

Reduced Drawing

SYM	REVISION	APP	DATE

### UPPER NIBBLE

x0	BLK ON	SPC	0	@	P	'	Q	R	S	T	U	V	W	X	Y	Z	{		]	^	_	
x1	XON	!	1	A	Q	a																
x2	BLK OFF	"	2	B	R	b	r															
x3	XDF	#	3	C	S	c	s															
x4	SET CUR	\$	4	D	T	d	t															
x5	DIS CUR	%	5	E	U	e	u															
x6	CUR OFF	&	6	F	V	f	v															
x7		'	7	G	W	g	w															
x8	BS	<	8	H	X	h	x															
x9	FWD MSG	>	9	I	Y	i	y															
xA	LF	*	:	J	Z	j	z															
xB	ESC	+	;	K	[	k	[															
xC	CLR	,	<	L	\	l	\															
xD	CR	-	=	M	]	m	]															
xE		.	>	N	^	n	^															
xF		/	?	O	_	o	_															

### LOWER NIBBLE

### OUTPUT CHARACTERS

- 0 \$30
- 1 \$31
- 2 \$32
- 3 \$33
- 4 \$34
- 5 \$35
- 6 \$36
- 7 \$37
- 8 \$38
- 9 \$39
- ENTER \$0D
- UP \$FC
- DOWN \$FA

## CHARACTER SET 1000 OPERATOR INTERFACE

	Dr	TCS	Title
	App	TCS	CHARACTER SET 1000 OPERATOR INTERFACE
Date		5/28/81	Part # SCC 1000
Scale			File # ED100021.SKD Page # 1 of 1
			DWG # ED-1000-021-A

4224 MARTIN ROAD  
WALLED LAKE, MI 48390  
(313) 360-9000  
FAX (313) 360-8962

REDUCED DRAWING

RECOMMENDED WIRING METHOD #1 - FULLY SHIELDED TWISTED PAIR CABLE  
 BELDEN #9729

SYM	REVISION	APP	DATE
A	ADDED MASTER/SLAVE PART #'S		6/26/91
B	ADDED SHIELD PIN #'S		7/9/91

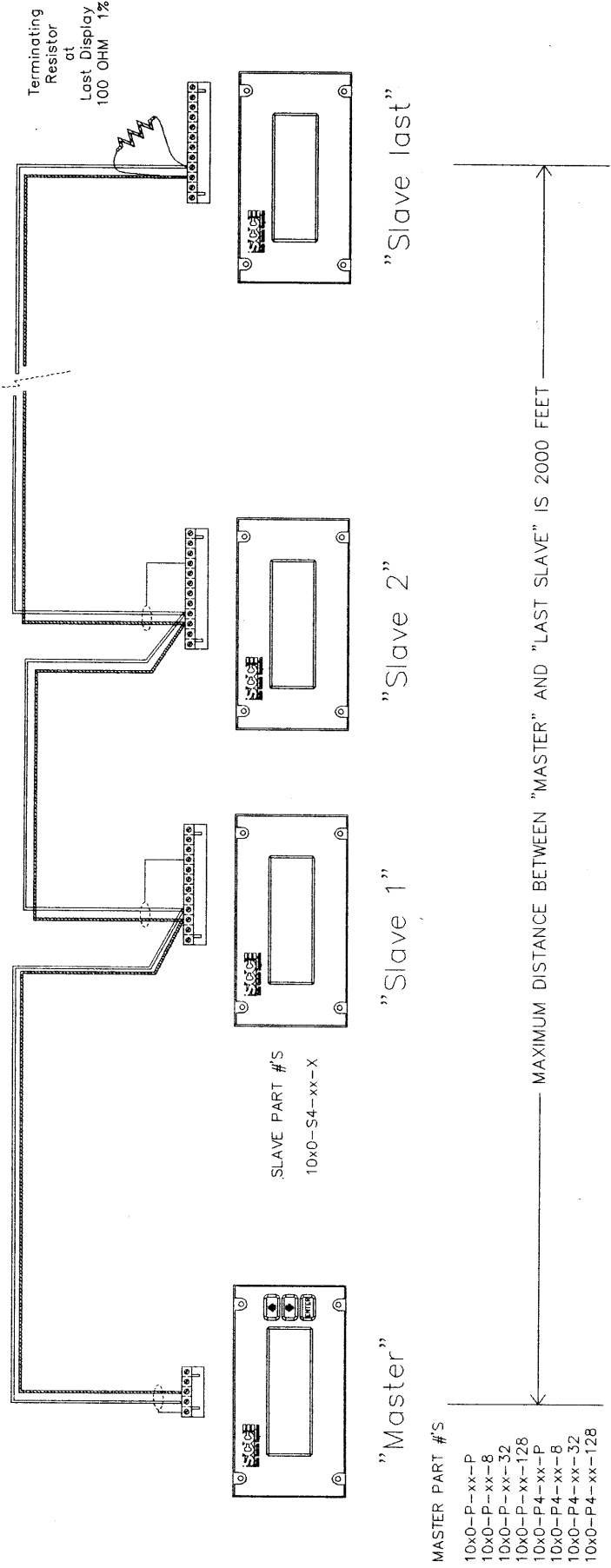

- MASTER PART #'S
- 10x0-P-xx-P
  - 10x0-P-xx-8
  - 10x0-P-xx-32
  - 10x0-P-xx-128
  - 10x0-P4-xx-P
  - 10x0-P4-xx-8
  - 10x0-P4-xx-32
  - 10x0-P4-xx-128

SCC900 type "Master" & "Slave" communications wiring.

- Master J4 pin #3 ----- Slave J1 pin #10
- Master J4 pin #4 ----- Slave J1 pin #9
- Master Shield J4 pin #5
- Slave Shield J1 pin #4

For RS-485 communications only.

See additional drawings for complete wiring of Master or Slave display.

<p>Static Controls Corporation</p> <p>4224 MARTIN ROAD          WALL L3, LA SEL, MI 4806390          TEL (313) 360-8962          FAX (313) 360-8962</p>	Dr. TCS App. TCS Date 6/19/91 Scale NTS	Title Master / Slave Communication Wiring SCC1000 Series Display Part # SCC 1000 File # ED100027.SKD (Page # 1 of 3) DWG # ED-1000-027-B
---	--	---

REDUCED DRAWING

RECOMMENDED WIRING METHOD #2 - FULLY SHIELDED TWISTED PAIR CABLE  
BELDEN #9729

SYM	REVISION	APP	DATE
A	ADDED MASTER/SLAVE PART #'S		6/26/91
B	ADDED SHIELD PIN #'S		7/9/91

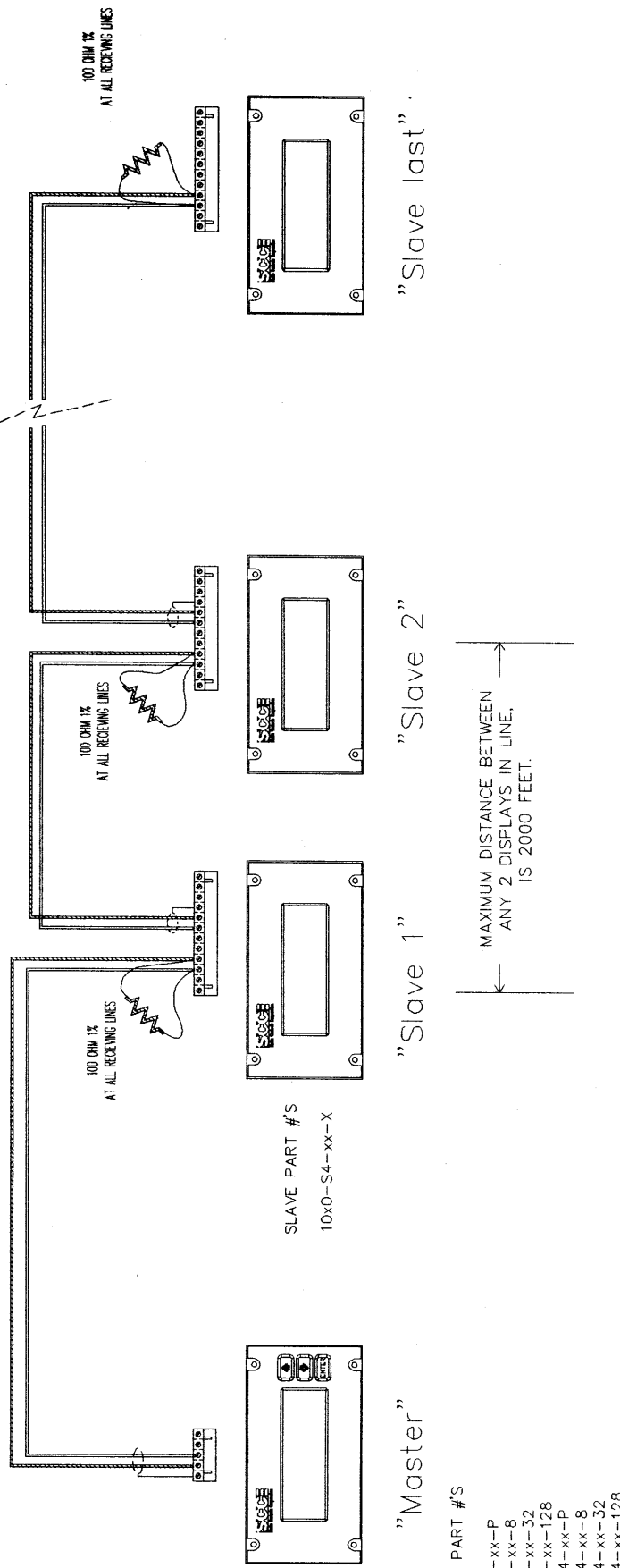

"Master"

"Slave 1"

"Slave 2"

"Slave last"

MASTER PART #'S

- 10x0-P-xx-P
- 10x0-P-xx-8
- 10x0-P-xx-32
- 10x0-P-xx-128
- 10x0-P4-xx-P
- 10x0-P4-xx-8
- 10x0-P4-xx-32
- 10x0-P4-xx-128

SCC900 type "Master" & "Slave" repeater communications wiring.

- Master J4 pin #3 ----- Slave J1 pin #10
- Master J4 pin #4 ----- Slave J1 pin #9

- Slave J1 pin #6 ----- Slave J1 pin #10
- Slave J1 pin #5 ----- Slave J1 pin #9

- Master Shield J4 pin #5
- Slave Shield J1 pin #4

For RS-485 communications only.

See additional drawings for complete wiring of Master or Slave display.

		Gr	Title	
		TCS	Master / Slave	
Controls Diagnostics Communications		App	Communication Wiring	
Static Controls Corporation 4224 MARTIN ROAD WALLED LAKE, MI 48390 (313) 360-9000 FAX (313) 360-8962		TCS	SCC1000 Series Display	
		Date	Part #	SCC 1000
		6/13/91	File #	ED100027.SKD
			Page #	2 of 3
		Scale	DWG #	
		NTS	ED-1000-027-B	

REDUCED DRAWING

RECOMENDED WIRING METHOD #1 - FULLY SHIELDED TWISTED PAIR CABLE  
BELDEN #9729

SYM	REVISION	APP	DATE
A	ADDED MASTER/SLAVE PART #'S		6/26/91
B	ADDED SHIELD PIN #'S		7/9/91

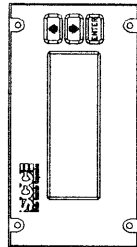
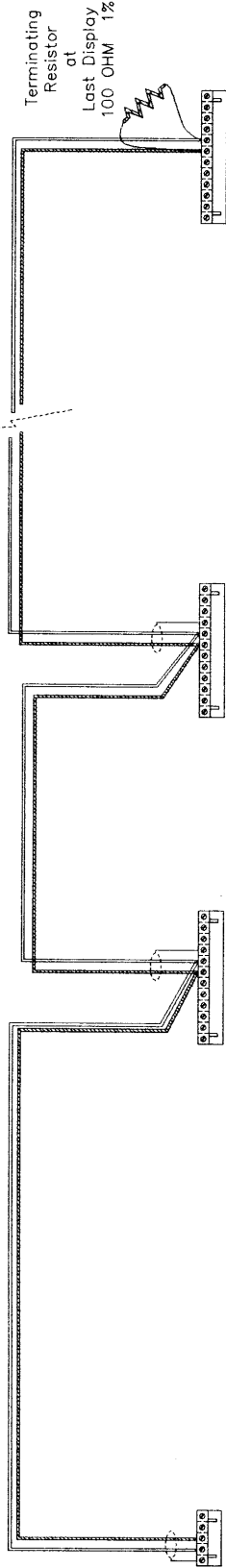

"Master"

- MASTER PART #'S
- 10x0-P-xx-P
  - 10x0-P-xx-8
  - 10x0-P-xx-32
  - 10x0-P-xx-128
  - 10x0-P4-xx-P
  - 10x0-P4-xx-8
  - 10x0-P4-xx-32
  - 10x0-P4-xx-128

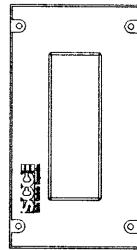

"Slave 1"

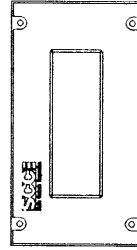

"Slave 2"

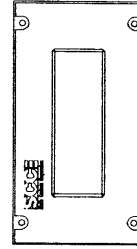

"Slave last"

MAXIMUM DISTANCE BETWEEN "MASTER" AND "LAST SLAVE" IS 2000 FEET

SCC900 type "Master" & "Slave" communications wiring.

- Master J4 pin #3 ----- Slave J1 pin #6
- Master J4 pin #4 ----- Slave J1 pin #5
- Master Shield J4 pin #5
- Slave Shield J1 pin #4

For RS-485 communications only.

See additional drawings for complete wiring of Master or Slave display.

	Dr	TCS	Title	Master / Slave
	App	TCS	Communication Wiring	SCC1000 Series Display
4224 MARTIN ROAD WALLED LAKE, WA 98390 (313) 360-9000 FAX (313) 360-8962		Date	Part #	SCC 1000
		6/13/91	File #	ED100027.SKD
		Scale	OWG #	ED-1000-027-B
		NTS	Page #	3 of 3

REDUCED DRAWING

SYM	REVISION	APP DATE
	CHANGED RESISTOR VALUE. CORRECTED JP3 CONNECTOR	9/15/92

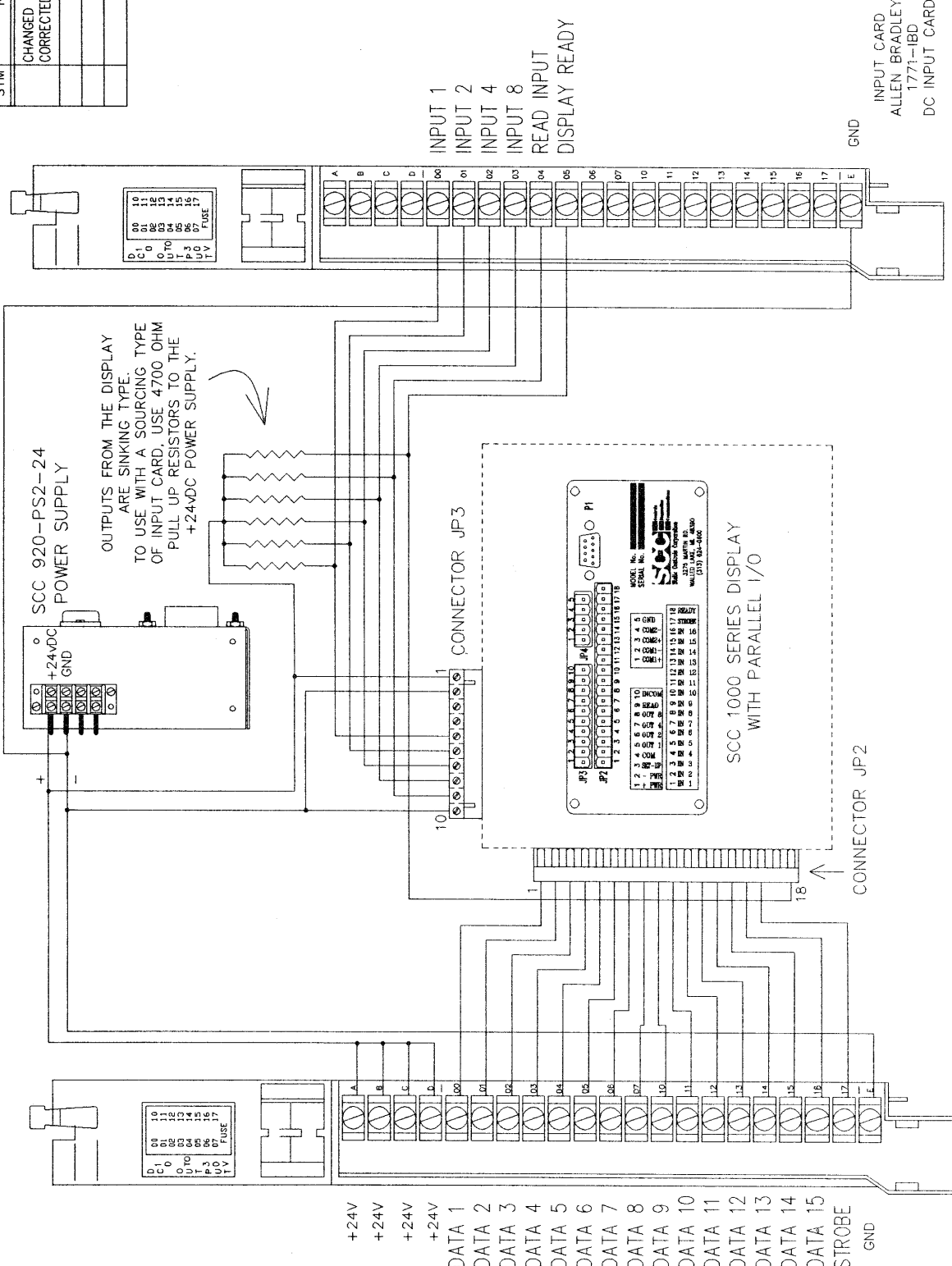

**SCC** Controls Diagnostics Communications  
 Slatic Controls Corporation  
 4224 MARTIN ROAD  
 WALLED LAKE, MI. 48390  
 (313) 360-9000  
 FAX (313) 360-8562

Part # SCC-1000  
 File # ED100055.SKD  
 Page # 1 of 1  
 Date 8/5/92  
 Scale  
 NTS

Dr TCS  
 App TCS  
 Title TYPICAL 1000 AB TO SCC PARALLEL WIRING  
 Layer 1

FD-1000-055-A

TYPICAL PARALLEL INPUT AND OUTPUT WIRING WITH SOURCING OUTPUT CARD & SOURCING INPUT CARD

OUTPUT CARD  
 ALLEN BRADLEY  
 1771-OB0  
 DC OUTPUT CARD

INPUT CARD  
 ALLEN BRADLEY  
 1771-1B0  
 DC INPUT CARD

SYM	REVISION	APP	DATE

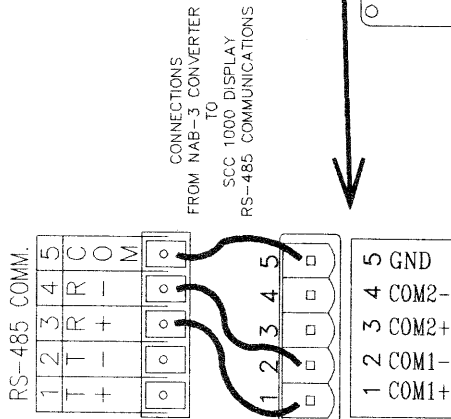
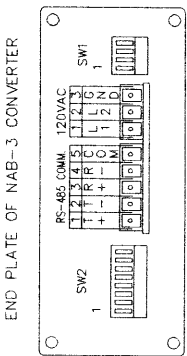

NAB-3  
RS-485  
TERMINAL

SCC1000 DISPLAY  
RS-485  
TERMINALS

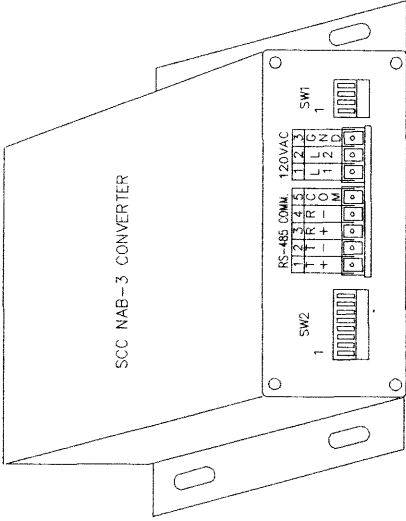

END PLATE OF NAB-3 CONVERTER

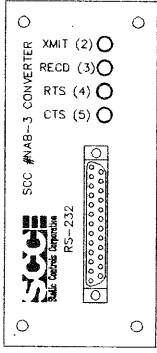

LED'S INDICATE  
CONDITION OF  
T-60'S RS-232 PORT

SCC #AD-1000-056-A  
NAB-3 to AB T-60  
CABLE

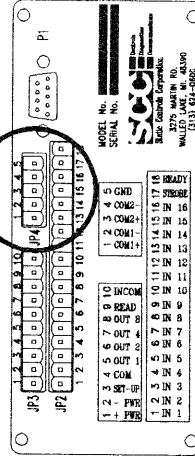

NAB-3 CONVERTER

CONVERTS ALLEN BRADLEY'S  
RS-232 SERIAL PORT  
TO  
STATIC CONTROLS  
RS-485 SERIAL PORT  
ON NETWORK DISPLAYS

NETWORK DIP SWITCH SETTINGS	
SW1-1	ON
SW1-2	OFF
SW1-3	OFF
SW1-4	OFF
SW2-1	ON
SW2-2	OFF
SW2-3	OFF
SW2-4	ON
SW2-5	ON
SW2-6	OFF
SW2-7	OFF
SW2-8	ON

SW1 SETS TYPE OF CONVERTER OPERATION

SW2 SETS CONFIGURATION OF PINOUT ON RS-232 PORT

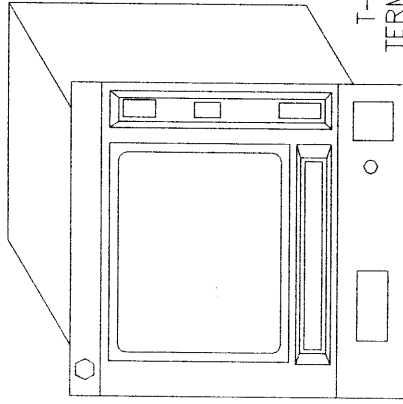

**Static Controls Corporation**  
4224 MARTIN ROAD  
WALLED LAKE, MI. 48390  
(313) 360-9000  
FAX (313) 360-8962

for TCS  
App  
TCS  
Date  
7/8/92  
Scale  
NTS

Title  
NAB-3 CONVERTER  
NETWORK  
SETUP  
AND DIP SWITCHES  
Layer 1  
Cert # SCC 1000  
File # ED100057.SKD (Page # 1 of 1)  
GWS # ED-1000-057-A

REDUCED DRAWING

SYM	REVISION	APP. DATE

# SCC NAB-3 RS-232 TO RS-485 CONVERTER.

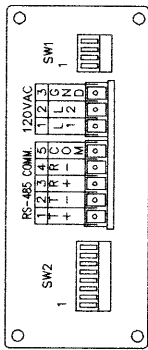

NOTE: WIRING CAN EXIT FROM THE CONVERTER IN TWO DIRECTIONS MAX.

## NETWORK TO MASTER DISPLAY WIRING

NAB-3 CONVERTER	DISPLAY #1	DISPLAY #2	DISPLAY #x
JP2 #3	JP4 #1	JP4 #1	JP4 #1
JP2 #4	JP4 #2	JP4 #2	JP4 #2
JP2 #5	JP4 #5	JP4 #5	JP4 #5

COM +  
COM -  
SHIELD

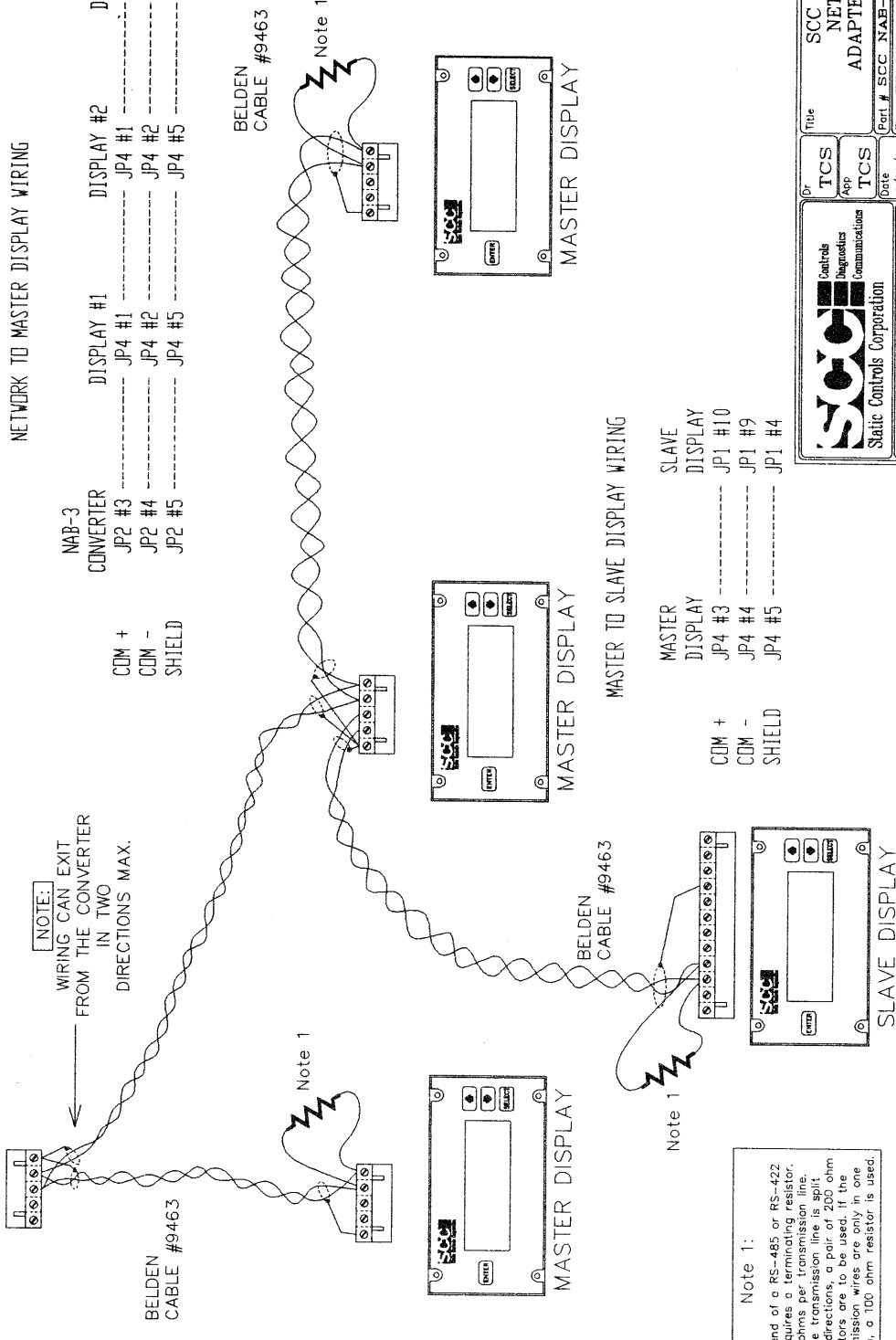

Note 1:  
Each end of a RS-485 or RS-422 line requires a terminating resistor, 100 ohms per transmission line. If the transmission line is split in two directions, a pair of 200 ohm resistors are to be used, if the transmission wires are only in one direction, a 100 ohm resistor is used.

 Static Controls Corporation 4224 MARTIN ROAD WALLED LAKE, WA 98090 FAX (313) 560-8962	Title SCC NAB-3 NETWORK ADAPTER WIRING
	Part # SCC NAB-3 File # ED100060.SKD (Page # 1 of 1) DWG # ED-1000-060-A
Of TCS App TCS Date 3/23/82 Scale	NTS



REDUCED DRAWING

SYM	REVISION	APP	DATE

IBM TO MASTER DISPLAY COMMUNICATIONS CABLE.

SCC #AD-1000-008-A (25 PIN I.B.M. PORT)  
 SCC #AD-1000-007-A (9 PIN I.B.M. PORT)

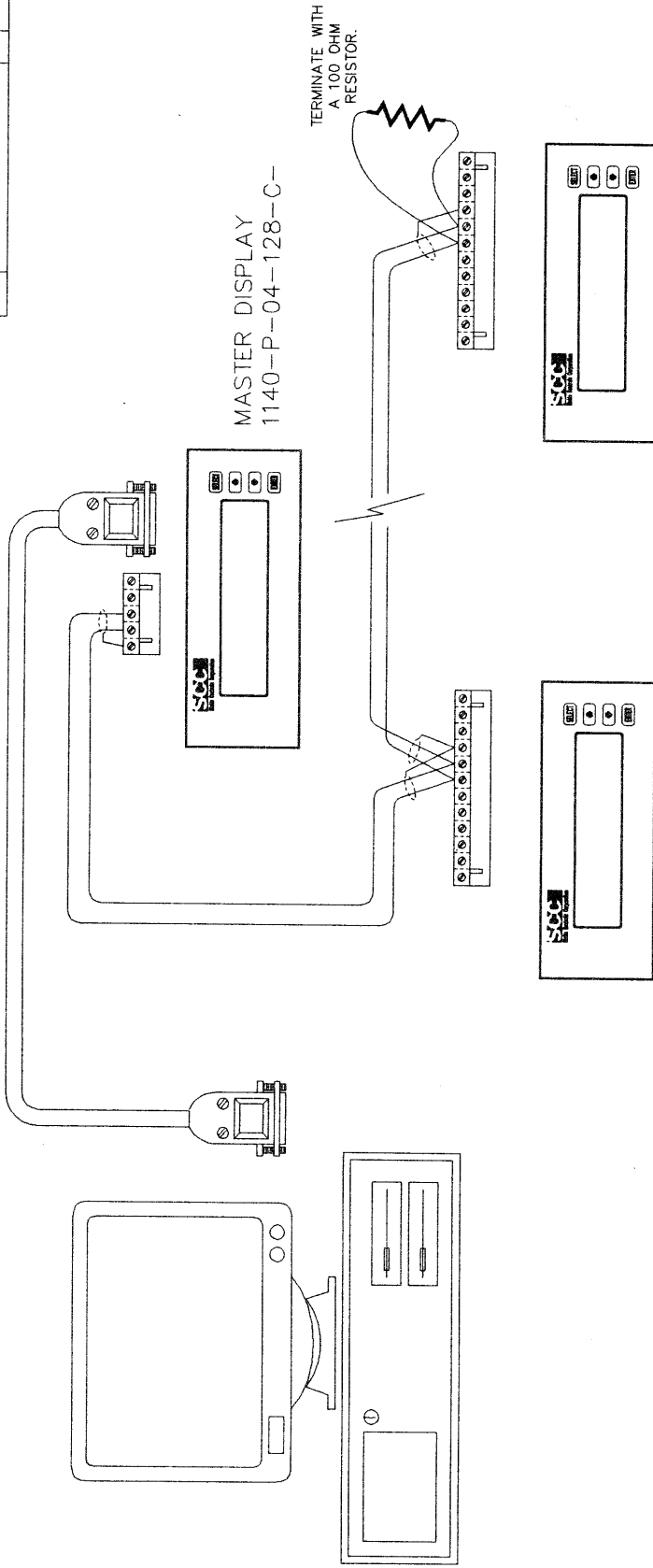

COMMUNICATIONS WIRING

MASTER DISPLAY	SLAVE 1 DISPLAY	SLAVE X DISPLAY
COM2 + JP4 PIN #3 -- JP1 PIN #6 -- JP1 PIN #6		
COM2 - JP4 PIN #4 -- JP1 PIN #5 -- JP1 PIN #5		
GND JP4 PIN #5 -- JP1 PIN #4 -- JP1 PIN #4		

USE TWISTED PAIR, FULLY SHIELDED CABLE.  
 SHIELD USED TO CARRY GROUND CONNECTION.

<p>Static Controls Corporation                  4224 MARTIN ROAD                  WALLED LAKE, MI. 48390                  (313) 360-9000                  FAX (313) 360-8962</p>	Dr	TCS	Title	COMMUNICATIONS
	App	TCS	1140-P-04-128-C- MASTER	WIRING
	Date	4/7/92	1140-S-04-X-X- SLAVE	TO
	Scale	NTS	Part # SCC 1100	FILE # ED110070.SXD
			Page # 1 of 1	Layer 1
			DWG #	ED-1000-070-A

REDUCED DRAWING

SYM	REVISION	APPL	DATE

IBM TO MASTER DISPLAY COMMUNICATIONS CABLE.

SCC #AD-1000-008-A (25 PIN I.B.M. PORT)  
 SCC #AD-1000-007-A (9 PIN I.B.M. PORT)

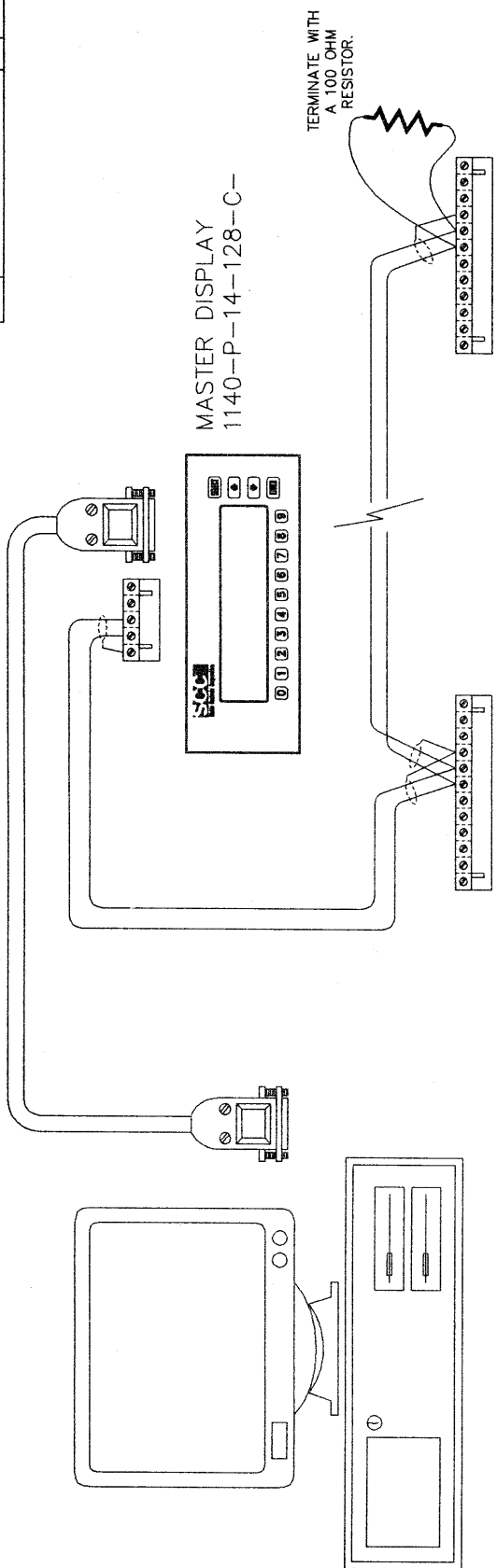

MASTER DISPLAY  
 1140-P-14-128-C

TERMINATE WITH  
 A 100 OHM  
 RESISTOR.

SLAVE DISPLAY  
 1140-S-04-X-X

SLAVE DISPLAY  
 1140-S-04-X-X

COMMUNICATIONS WIRING

MASTER DISPLAY	SLAVE 1 DISPLAY	SLAVE X DISPLAY
----------------	-----------------	-----------------

COM2 +	JP4 PIN #3	--	JP1 PIN #6	--	JP1 PIN #6
COM2 -	JP4 PIN #4	--	JP1 PIN #5	--	JP1 PIN #5
GND	JP4 PIN #5	--	JP1 PIN #4	--	JP1 PIN #4

USE TWISTED PAIR, FULLY SHIELDED CABLE.  
 SHIELD USED TO CARRY GROUND CONNECTION.

<p>Static Controls Corporation                  4224 MARTIN ROAD                  WALLACE, NC 28078-5390                  TEL (313) 360-9000                  FAX (313) 360-8962</p>	Dr	TCS	Title	COMMUNICATIONS
	App	TCS	1140-P-14-128-C	WIRING TO MASTER
	Date	4/7/92	1140-S-04-X-X	SLAVE
	Scale		Part # SCC 1100	Layer 1
		File #	ED10070.SKD	Page # 1 of 1
		Scale		Part #
		NTS		FD-1000-071-A

