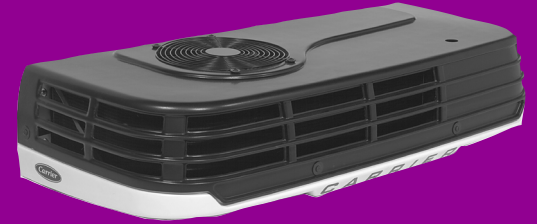
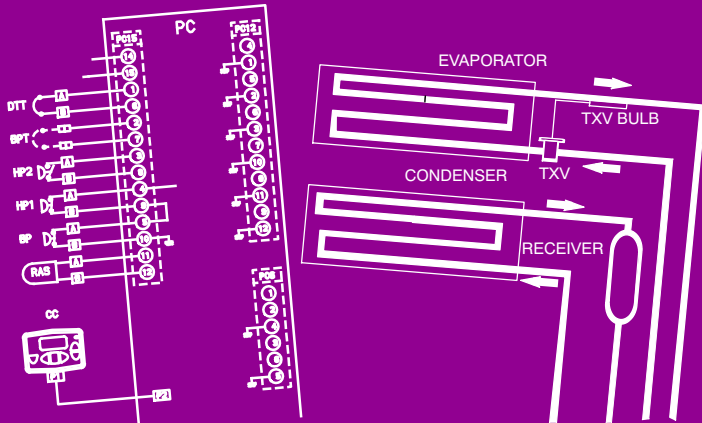




Truck Refrigeration



Operation and Service Manual for **INTEGRA 30S** Truck Refrigeration Units Beginning with S/N PB 225225



Operation and Service Manual for INTEGRA 30S

Truck Refrigeration Units
Beginning with S/N PB 225225

Table of Contents

PARAGRAPH NUMBER	PAGE
SAFETY SUMMARY	1-1
1.1 SAFETY PRECAUTIONS	1-1
1.2 FIRST AID	1-1
1.3 OPERATING PRECAUTIONS	1-1
1.4 MAINTENANCE PRECAUTIONS	1-1
1.5 REFRIGERANTS	1-1
1.6 SPECIFIC WARNING AND CAUTION STATEMENTS	1-2
UNIT DESCRIPTION	2-1
2.1 INTRODUCTION	2-1
2.2 GENERAL DESCRIPTION	2-1
2.3 CONDENSING SECTION	2-1
2.3.1 Condenser/Subcooler	2-1
2.3.2 Filter Drier	2-1
2.3.3 Oil Separator	2-3
2.3.4 Hot Gas Solenoid Valve (HGS1)	2-3
2.3.5 Condenser Pressure Control Valve (HGS2)	2-3
2.3.6 Compressor	2-3
2.3.7 Standby Motor	2-3
2.3.8 Receiver	2-3
2.3.9 High Pressure Switch (HP1)	2-4
2.3.10 Condenser Pressure Control Switch (HP2)	2-4
2.4 EVAPORATOR SECTION	2-4
2.4.1 Thermostatic Expansion Valve	2-4
2.4.2 Compressor Pressure Regulating Valve (CPR) (115V Only)	2-4
2.4.3 Defrost Termination Thermostat (DTT)	2-4
2.4.4 Quench Valve (BPV)	2-4
2.4.5 Evaporator	2-4
2.4.6 Low Pressure Switch (LP)	2-4
2.5 SYSTEM OPERATING CONTROLS AND COMPONENTS	2-7
2.6 UNIT SPECIFICATIONS	2-8
2.6.1 Compressor Data	2-8
2.6.2 Refrigeration System Data	2-8
2.6.3 Electrical Data	2-9
2.6.4 Torque Values	2-9
2.7 SAFETY DEVICES	2-10
2.8 REFRIGERANT CIRCUIT	2-11
2.8.1 Cooling	2-11
2.8.2 Heat And Defrost	2-11
OPERATION	3-1
3.1 CONTROL SYSTEM	3-1
3.1.1 Introduction	3-1
3.1.2 Microprocessor Module	3-1
3.1.3 Cab Command	3-1

3.2	START-UP	3-3
3.2.1	Inspection	3-3
3.2.2	Connect Power	3-3
3.2.3	Starting	3-3
3.3	SET POINT ADJUSTMENT	3-3
3.4	MANUAL DEFROST	3-4
3.5	DEFROST CYCLE ADJUSTMENT	3-4
3.6	ALARM DISPLAY	3-4
3.6.1	Accessing Alarm Messages	3-4
3.6.2	Low Battery Voltage Alarm for Road Only Units	3-5
3.6.3	Clearing Alarm Messages	3-5
3.7	CHECKING THE EEPROM VERSION	3-5
3.8	STOPPING THE UNIT	3-5
3.9	MICROPROCESSOR CONFIGURATION	3-6
3.9.1	Road Only Functional Settings	3-6
3.9.2	Road/Standby Functional Settings	3-7
	TEMPERATURE CONTROL	4-1
4.1	SEQUENCE OF OPERATION	4-1
4.1.1	Perishable Mode	4-1
4.1.2	Frozen Mode	4-1
4.2	DEFROST CYCLE	4-2
4.3	MINIMUM OFF TIME	4-2
	SERVICE	5-1
5.1	MAINTENANCE SCHEDULE	5-1
5.2	BELT MAINTENANCE AND ADJUSTMENT	5-3
5.2.1	Standby Motor-Compressor V-Belt	5-3
5.3	INSTALLING R-134A MANIFOLD GAUGE SET	5-3
5.3.1	Preparing Manifold Gauge/Hose Set For Use	5-3
5.3.2	Connecting Manifold Gauge/Hose Set	5-3
5.3.3	Removing the Manifold Gauge Set	5-4
5.4	REMOVING THE REFRIGERANT CHARGE	5-4
5.4.1	Refrigerant Removal From a Non-Working Compressor	5-4
5.5	REFRIGERANT LEAK CHECKING	5-4
5.6	EVACUATION AND DEHYDRATION	5-5
5.6.1	General	5-5
5.6.2	Preparation	5-5
5.6.3	Procedure for Evacuating and Dehydrating System	5-5
5.7	CHARGING THE REFRIGERATION SYSTEM	5-6
5.7.1	Checking The Refrigerant Charge	5-6
5.7.2	Installing a Complete Charge	5-6
5.7.3	Adding a Partial Charge	5-6
5.8	CHECKING FOR NON-CONDENSABLES	5-6
5.9	REPLACING THE COMPRESSOR	5-6
5.9.1	Removing Compressor	5-6
5.9.2	Installing Compressor	5-7
5.10	CHECKING AND REPLACING FILTER DRIER	5-7
5.10.1	Checking Filter Drier	5-7
5.10.2	Replacing Filter Drier	5-7

5.11	HIGH PRESSURE (HP1) AND CONDENSER PRESSURE (HP2) SWITCHES	5-7
5.11.1	Removing Switch	5-7
5.11.2	Checking Pressure Switch	5-7
5.12	CHECKING AND REPLACING CONDENSER FAN MOTOR BRUSHES	5-8
5.13	HOT GAS (HGS1) AND CONDENSER PRESSURE CONTROL SOLENOID VALVES	5-8
5.13.1	Replacing Solenoid Coil	5-8
5.13.2	Replacing Valve Internal Parts	5-8
5.14	ADJUSTING THE COMPRESSOR PRESSURE REGULATING VALVE (CPR) (115V ONLY)	5-
9		
5.15	THERMOSTATIC EXPANSION VALVE	5-9
5.15.1	Replacing expansion valve	5-9
5.15.2	Measuring Superheat	5-9
5.16	DIAGNOSTIC TOOL	5-10
5.17	MICROPROCESSOR	5-10
5.18	EVAPORATOR COIL CLEANING	5-10
5.19	CONDENSER COIL CLEANING	5-10
	TROUBLESHOOTING	6-1
6.1	INTRODUCTION	6-1
6.2	REFRIGERATION	6-3
6.2.1	Unit Will Not Cool	6-3
6.2.2	Unit Runs but has Insufficient Cooling	6-3
6.2.3	Unit Operates Long or Continuously in Cooling	6-3
6.2.4	Unit Will Not Heat or Heating Insufficient	6-3
6.2.5	Defrost Malfunction	6-3
6.2.6	Abnormal Pressure - Cooling	6-4
6.2.7	Abnormal Pressure - Heating	6-4
6.2.8	Abnormal Noise	6-4
6.2.9	Cab Command Malfunction	6-5
6.2.10	No Evaporator Air Flow or Restricted Air Flow	6-5
6.2.11	Expansion Valve	6-5
6.2.12	Malfunction Hot Gas Solenoid or Condenser Pressure Regulating Valve	6-5
6.2.13	Standby Compressor Malfunction	6-5
	ELECTRICAL SCHEMATIC WIRING DIAGRAM	7-1
7.1	INTRODUCTION	7-1
7.2	WIRING SCHEMATIC	7-1
	INDEX	INDEX-1

GLOSSARY

Absolute Humidity	Amount of moisture in the air, indicated in grains per cubic foot.
Absolute Pressure	Gauge pressure plus atmospheric pressure (14.7 lbs. per sq. in.)
Absolute Temperature	Temperature measured from absolute zero
Absolute Zero Temperature	Temperature at which molecular motion ceases
Absorbent	Substance with ability to take-up, or absorb another substance
Absorber	A solution or surface that is capable of soaking up (taking in) another substance or energy form
Absorption Chiller	A chiller that uses a brine solution and water to provide refrigeration without the aid of a com-pressor.
Absorption Refrigerator	Refrigerator which creates low temperatures by using the cooling effect formed when a refrigerant is absorbed by chemical substance.
Accelerate	To add to speed; hasten progress of development
Accumulator	Storage tank which receives liquid refrigerant from evaporator and prevents it from flowing into suc-tion line.
Acid Condition	Condition in which refrigerant and/or refrigeration oil have become contaminated by the formation of acids. Typically caused by moisture introduced into system due to improper evacuation/dehydration of system after being open to, and exposed to the atmosphere.
ACR Tubing	Tubing used in refrigeration which has ends to keep tubing clean and dry.
Activated Alumina	Chemical used as a drier or desiccant.
Activated Carbon	Specially processed carbon used as a filter drier; commonly used to clean air
Actuator	That portion of a regulating valve that converts mechanical fluid, thermal energy, or electrical energy into mechanical motion to open or close valve seats.
Adiabatic Compression	Compressing refrigerant gas without removing or adding heat.
Adsorbent	Substance which has property to hold molecules of fluids without causing a chemical or physical change.
Adsorption	The adhesion of a thin layer of molecules of a gas or liquid to a solid object
Ampere	Unit of measure referring to the flow of electrons within a circuit. Both voltage (pressure) as well as amperage (flow) are required, or must be available to produce work (watts). In a circuit with a fixed resistance (Ohms), the value of volts vs. amps will change inversely in relation to each other.
Back Pressure	Pressure in low side of refrigerating system; also called suction pressure or low side pressure.
Back Seating	Fluid opening/closing such as a gauge opening; to seat the joint where the valve stem goes through the valve body.
BTU	British Thermal Unit. In scientific terms, it represents the amount of energy required to raise one pound of water one degree Fahrenheit. One BTU is the approximate equivalent to the heat given off by a single wooden kitchen match.
Calcium Sulfate	Chemical compound (CaSO ₄) which is used as a drying agent or desiccant in liquid line (high side) filter-driers.
Calibrate	To correlate the readings of (an instrument) with those of a standard in order to check the instrument's accuracy
Capacitance (C)	Property of nonconductor (condenser or capacitor) that permits storage of electrical energy in an electrostatic field.

GLOSSARY

Capacitor, Motor Running	Single or dual rated (two posts vs. three posts) device which limits current and is permanently (hence phrase PSC - Permanent Split Capacitor) installed, in series, between the motors run and start windings. The current limiting characteristics prevent the start winding from burning. Also improves motor's efficiency (improves power factor) by realigning the motor's voltage and current sin waves. A PSC motor will generally consume 40-50% less electricity when compared to an equivalent Shaded Pole design motor.
Capacitor, Motor Starting	Device utilized in single phase compressors and/or electric motors to boost starting torque. Reduces inrush current (lights dimming) and associated internal heat generated with the motor windings. Typically black in color and cylindrical.
CFM	A standard of airflow measurement. Cubic feet per minute.
Coil, Condenser	The coil dissipates heat from the refrigerant. Hot vapor refrigerant is compressed by the compressor, and the refrigerant condenses from a vapor to a liquid state. Subcooling of condensed liquid occurs when all vapor is condensed.
Coil, Evaporator	Where heat is absorbed by warm air passing across. Liquid refrigerant boils as it is metered into coil, and changes from liquid to vapor.
Cold	A sensation felt as a result of the absence of heat.
Compressor	The heart or "pump" within an air conditioning or heat pump system. The compressor maintains adequate pressure to cause refrigerant to condense and flow in sufficient quantities to meet the cooling requirements of the system.
Damper	Valve for controlling airflow. Found in duct work, movable plate opens and closes to control airflow. Can be manually or automatically controlled to regulate airflow to desired system zones.
Decibel (dB)	Unit used for measuring relative loudness of sounds. One decibel is equal to approximate difference of loudness ordinarily detectable by human ear, the range of which is about 130 decibels on scale beginning with one for faintest audible sound.
Ductwork	Round or rectangular pipes or controlled paths acting as conduit for return, mixed, makeup, supply or exhaust air. Supply air is downstream of high pressure side of fan. Return air is upstream of low pressure inlet of fan.
Ebulator	A pointed or sharp edged solid substance inserted in flooded type evaporators to improve evaporation (boiling) of refrigerant in coil.
Economizer	A mechanism that removes flash gas from the evaporator.
Eddy Currents	Induced currents flowing in a core.
Fahrenheit Scale	On a Fahrenheit thermometer, under standard atmospheric pressure, boiling point of water is 212 degrees. and freezing point is 32 degrees above zero on its scale.
Fan	A radial or axial flow device used for moving or producing artificial currents of air.
Farad	Unit of electrical capacity; capacity of a condenser which, when charged with one coulomb of electricity, gives difference of potential of one volt.

GLOSSARY

Field Pole	Part of stator of motor which concentrates magnetic field of field winding.
Filter	Device for removing small particles from a fluid.
Flame Test for Leaks	Tool which is principally a torch and when an air-refrigerant mixture is fed to flame, this flame will change color in presence of heated copper.
Gas	Vapor phase or state of a substance.
Gauge Manifold	A device constructed to hold compound and high pressure gauges containing hand valves to control flow.
Gauge, Vacuum	Instrument used to measure pressures below atmospheric pressure.
Halide Refrigerants	Family of refrigerants containing halogen chemicals.
Halide Torch	Type of torch used to detect halogen refrigerant leaks.
Head Pressure	Pressure which exists in condensing side of refrigerating system.
Head Pressure Control	Pressure operated control which opens electrical circuit if high side pressure becomes excessive.
Head, Static	Pressure of fluid expressed in terms of height of column of the fluid, such as water or mercury.
Head, Velocity	In flowing fluid, height of fluid equivalent to its velocity pressure
Heat	Invisible energy (except high intensity infra-red) caused by the motion of molecules within any substance or matter. Will always travel from warm/hot to cold, via either or a combination of conduction, convection or radiation. Materials which resist flow or transfer of heat are called insulators, or insulation.
Heat Exchanger	A device for the transfer of heat energy from the source to the conveying medium, with the latter often being air or water. Most common combinations are: Refrigerant to air or refrigerant to water (DX), water to air (hydronic), steam to air, steam to water.
Humidity	The total amount of moisture in air. Relative humidity (RH), is the amount of moisture in air, relative to its total capability based upon its temperature (dewpoint). Moisture will condense on surfaces which are below this dewpoint.
Induction Motor	An AC motor which operates on principle of rotating magnetic field. Rotor has no electrical connection, but receives electrical energy by transformer action from field windings.
Insulation	Any material or substance which has the ability to retard the flow or transfer of heat.
Joule	Thomson Effect-Change in temperature of a gas on expansion through a porous plug from a high pressure to a lower pressure.
Junction Box	Group of electrical terminals housed in protective box or container.
Kilowatt	Unit of electrical power, equal to 1000 watts.
Latent Heat	Heat energy absorbed in process of changing form of substance (melting, vaporization, fusion) without change in temperature or pressure. Also referred to as "hidden" heat.
Leak Detector	Device or instrument such as a halide torch, an electronic sniffer; or soap solution used to detect leaks.
Limit Control	Control used to open or close electrical circuits as temperature or pressure limits are reached.
Manifold, Service	A device equipped with gauges and manual valves, used by serviceman to service refrigerating systems.

GLOSSARY

Manometer	Instrument to measuring pressure of gases and vapors. Gas pressure is balanced against column of liquid such as mercury, in U-shaped tube.
Metering Device	TXV, capillary tube assembly, constant pressure expansion valve or bullet type piston orifice designed to regulate flow of liquid refrigerant entering the evaporator. Creates pressure drop to allow liquid refrigerant to boil and absorb latent heat. Separates high side of system from low side (as does the compressor).
Neutralizer	Substance used to counteract acids, in refrigeration system.
Off Cycle	That time period of a refrigeration cycle when the system is not operating.
OHM	A standard unit of measure for electrical resistance. One ohm of resistance will allow one ampere of current to flow when one volt of electricity is applied to a circuit.
Ohmmeter	An instrument for measuring resistance in ohms.
Ohm's Law	Mathematical relationships between voltage, current and resistance in an electric circuit, discovered by George Simon Ohm. It is stated as follows: voltage ($E = \text{Amperes (I)} \times \text{Ohms (R)}$); or $E = I \times R$.
Pascal's Law	A pressure imposed upon a fluid is transmitted equally in all directions.
Pinch-Off Tool	Device used to press walls of a tubing together until fluid flow ceases.
Piston	Close fitting part which moves up and down in a cylinder.
Piston Displacement	Volume displaced by piston as it travels length of stroke.
PSC Motor	High-efficiency design motor used on virtually all of today's HVAC and R equipment requiring motors over 1/10hp. An upgrade from Shaded Pole design motors. See Capacitor, Motor Running.
Psychrometer	Either a sling type, or electronic. Instrument used to determine wet bulb temperatures and relative humidity. Combining RH with dry bulb temperature will yield total heat.
Range	Pressure or temperature settings of a control; change within limits
Receiver Heating Element	Electrical resistance mounted in or around liquid receiver, used to maintain head pressures when ambient temperature is at freezing or below freezing.
Refrigerant	A substance produces a refrigerating or cooling (heat absorbing) effect while expanding or vaporizing.
Refrigeration	The moving of heat from an undesirable location, to that of a location where its presence is less undesirable.
Saddle Valve (Tap-A-Line)	Self-piercing valve body designed to be permanently silver brazed or clamped to refrigerant tubing surface. Provides system access to monitor pressure, charge or evacuate refrigerant.
Safety Control	Device used to electrically shut down a refrigerating unit when unsafe pressures and/or temperatures exist.
Safety Motor Control	Electrical device used to open circuit if the temperature, pressure, and/or the current flow exceed safe conditions.
Safety Plug	Device which releases the contents of a container above normal pressures, and before rupture pressures are reached.
Saturation Temperature	The temperature where a refrigerant exists in both liquid and vapor form relative to its measured pressure.
Super Heat	The temperature rise within an evaporator/suction line assembly from the evaporator's saturation temperature.

GLOSSARY

Sub-Cooling	Process whereas additional sensible heat (as opposed to latent heat) is removed from condensed refrigerant liquid prior to the metering device. The proper method for charging a system utilizing a TXV.
Temperature	Degree of hotness or coldness as measured by a thermometer; measurement of speed of motion of molecules.
Test Light	Light provided with test leads, used to test or probe electrical circuits to determine if they are alive.
Thermostat	A temperature control device. Typically mounted in conditioned space.
Thermostatic Expansion Valve (TXV)	Thermostatic Expansion Valve. A metering valve which acts as a superheat controller. Most are mechanically operated, and utilize a remote sensing bulb attached to the outlet of the evaporator assembly (via a sealed capillary tube) to regulate flow of sub-cooled liquid refrigerant at the evaporator inlet.
Therm	Quantity of heat equivalent to 100,000 Btu
Ton	A unit of measurement used for determining cooling capacity. One ton is the equivalent of 12,000 BTUs per hour.
Vacuum	Reduction in pressure below atmospheric pressure.
Vacuum Control Systems	In some air conditioning systems, vacuum is used to operate dampers and controls in system.
Vacuum Pump	Special high efficiency device (pump) used create deep vacuum within an AC/R systems, for the purpose of moisture removal (dehydration), removal of non-condensibles and can also be used, as well, for leak checking.
Valve, Service	Typically, a multi-ported valve used by service technicians to isolate remote system components, as well as check pressures and charge refrigerating units.
Valve, Solenoid	Valve actuated by magnetic action by means of an electrically energized coil.
Volt	Electrical "pressure" applied to a circuit. One volt will cause one ampere of current (volume) to flow in a circuit containing one ohm of resistance.
Water-Cooled Condenser	Condensing unit which is cooled through use of water.
Watt	Unit of electrical power. Volts x Amps = Watts.
Wax	Undesirable component in many refrigeration lubricants, which may separate out of solution if cooled sufficiently.
Wet Valve	Device used in measurement of relative humidity. Evaporation of moisture lowers temperature of wet bulb compared to dry bulb temperature in same area.

SECTION 1

Safety Summary

1.1 Safety Precautions

Your Carrier Transicold refrigeration unit has been designed with the safety of the operator in mind. During normal operation, all moving parts are fully enclosed to help prevent injury. During all pre-trip inspections, daily inspections, and problem troubleshooting, you may be exposed to moving parts. Stay clear of all moving parts when the unit is in operation and when the ON/OFF switch is in the ON position.

1.2 First Aid

No injury, no matter how slight, should go unattended. Always obtain first aid or medical attention immediately.

1.3 Operating Precautions

Always wear safety glasses. Wear hearing protection as required.

Keep hands, clothing and tools clear of the evaporator and condenser fans.

No work should be performed on the unit until all circuit breakers are turned off and battery power supply is disconnected.

Always work in pairs. Never work on the equipment alone.

In case of severe vibration or unusual noise, stop the unit and investigate.

1.4 Maintenance Precautions

Beware of unannounced starting of the unit. This unit is equipped with Auto-Start in both the road and standby modes. The unit may start at any time. When performing any check of the system, make certain all circuit breakers are turned off and battery power supply is disconnected.

Be sure power is turned off before working on motors, controllers, solenoid valves and electrical control switches. Tag circuit breaker and vehicle ignition to prevent accidental energizing of circuit.

Do not bypass any electrical safety devices, e.g. bridging an overload, or using any sort of jumper wires. Problems with the system should be diagnosed, and any necessary repairs performed, by qualified service personnel.

When performing any arc welding on the unit or container, disconnect all wire harness connectors from the micro-processor. Do not remove wire harness from the modules unless you are grounded to the unit frame with a static safe wrist strap.

In case of electrical fire, open the circuit switch and extinguish with CO₂ (never use water).

1.5 Refrigerants

The refrigerant contained in your unit can cause frostbite, severe burns, or blindness when in direct contact with the skin or eyes. For this reason, and because of legislation regarding the handling of refrigerants during system service, we recommend that you contact your nearest Carrier Transicold authorized repair facility whenever your unit requires refrigeration system service.

1.6 Specific Warning and Caution Statements

To help identify the label hazards on the unit and explain the level of awareness each one carries, an explanation is given with the appropriate consequences:

DANGER: Means an immediate hazard which WILL result in severe personal injury or death.

WARNING: Means to warn against hazards or unsafe conditions which COULD result in severe personal injury or death.

CAUTION: Means to warn against potential hazard or unsafe practice which could result in minor personal injury, product or property damage.

The statements listed below are applicable to the refrigeration unit and appear elsewhere in this manual. These recommended precautions must be understood and applied during operation and maintenance of the equipment covered herein.

WARNING

Beware of unannounced starting of the unit. The unit may cycle the fans and operating compressor unexpectedly as control requirements dictate. Press the OFF key on the Cab Command and disconnect the power plug.

WARNING

Inspect battery cables for signs of wear, abrasion or damage at every pre-trip inspection and replace if necessary. Also check battery cable routing to ensure that clamps are secure and that cables are not pinched or chafing against any components.

WARNING

Do not attempt to connect or remove power plug before ensuring the unit is OFF (press OFF key on Cab Command) and external power circuit breaker is open.

WARNING

Beware of V-belt and belt-driven components as the unit may start automatically.

WARNING

Ensure power to the unit is OFF, power plug is disconnected and circuit breaker is open or vehicle engine is OFF and negative battery cable is connected before replacing compressor.

WARNING

Slowly open the plug on the suction and discharge valves of the new compressor to vent the nitrogen holding charge.

WARNING

Do not use a nitrogen cylinder without a pressure regulator. (See [Figure 5.5](#)) Cylinder pressure is approximately 2350 psig (160 bars). Do not use oxygen in or near a refrigerant system as an explosion may occur.

 **CAUTION**

Under no circumstances should anyone attempt to repair the microprocessor module or Cab Command! Should a problem develop with these components, contact your nearest Carrier Transicold dealer for replacement.

 **CAUTION**

If starting the unit for the first time after installation or starting after adding/removing an optional feature or if Owner's operating parameters have changed, the Configuration will need to be reset.

 **CAUTION**

Compressor failure will occur if inert gas brazing procedures are not used on units with R-134A and POE oil. For more information see Technical Procedure 98-50553-00 - Inert Gas Brazing.

 **CAUTION**

To prevent trapping liquid refrigerant in the manifold gauge set be sure set is brought to suction pressure before disconnecting.

 **CAUTION**

Do not damage or over tighten the enclosing tube assembly. Place all parts in the enclosing tube in proper sequence in order to avoid premature coil burn-out.

 **CAUTION**

Observe proper polarity when installing battery, negative battery terminal must be grounded.

 **CAUTION**

Under no circumstances should a technician electrically probe the processor at any point, other than the connector terminals where the harness attaches. Microprocessor components operate at different voltage levels and at extremely low current levels. Improper use of voltmeters, jumper wires, continuity testers, etc. could permanently damage the processor.

 **CAUTION**

Most electronic components are susceptible to damage caused by electrical static discharge (ESD). In certain cases, the human body can have enough static electricity to cause resultant damage to the components by touch. This is especially true of the integrated circuits found on the microprocessor. Use proper board handling techniques. (See [Section 5.17](#)).

SECTION 2

Unit Description

2.1 Introduction

Beware of unannounced starting of the unit. The unit may cycle the fans and operating compressor unexpectedly as control requirements dictate. Press the OFF key on the Cab Command and disconnect the power plug.

This manual contains Operating Data, Electrical Data and Service Instructions for the Carrier Transicold Model 30S truck refrigeration units listed in [Table 2-1](#).

Additional support manuals are listed in [Table 2-2](#).

The model/serial nameplate is located on the cover.

2.2 General Description

The unit ([Figure 2.1](#)) is of the split system type with the condenser mounted outside the truck body, evaporator mounted in the body, and a Cab Command control center mounted in the driver's compartment. Two types of compressor drive are available:

- Road operation: The road compressor is located in the engine compartment and is driven by the engine of the vehicle when in operation over-the-road
- Road/Standby operation: A second compressor is mounted in the condensing section and is driven by an electric motor when in standby mode.

2.3 Condensing Section

The condensing section (see [Figure 2.2](#)) contains the condenser fan and coil, filter drier, oil separator, hot gas solenoid valve, receiver, and a condenser pressure control valve. On road/standby units the condensing section also houses the standby compressor, control box and rectifier and houses the transformer assembly (see [Figure 2.2](#) and [Figure 2.5](#)).

2.3.1 Condenser/Subcooler

The condenser is of the tube and fin type and acts as a heat exchanger in which the compressed refrigerant gas is condensed into a liquid and lowered in temperature. Air movement over the condenser is provided by a fan mounted in the condensing section.

A portion of the condenser is occupied by the sub-cooler. Refrigerant leaving the receiver is passed through the subcooler where additional heat is removed. Removal of this additional heat helps to ensure that only liquid refrigerant enters the thermal expansion valve.

2.3.2 Filter Drier

The drier is a cylindrical shell containing a drying agent and screen. It is installed in the liquid line and functions to keep the system clean and remove moisture from the refrigerant.

Table 2-1 Model Chart

Model No.	Description	R-134A	Road Compressor	Standby Compressor	Condenser Weight	Evaporator Weight
8002189	Road Only	4 lb (1.8 kg)	TM 16	---	Road: 88 lb (40 kg) Road and Standby: 165 lb (75 kg)	66 lb (30 kg)
8002191	Road/Standby 115/1/60Hz			TM 16		
8002193	Road/Standby 230/1/60Hz					
8002195	Road/Standby 230/3/60Hz					

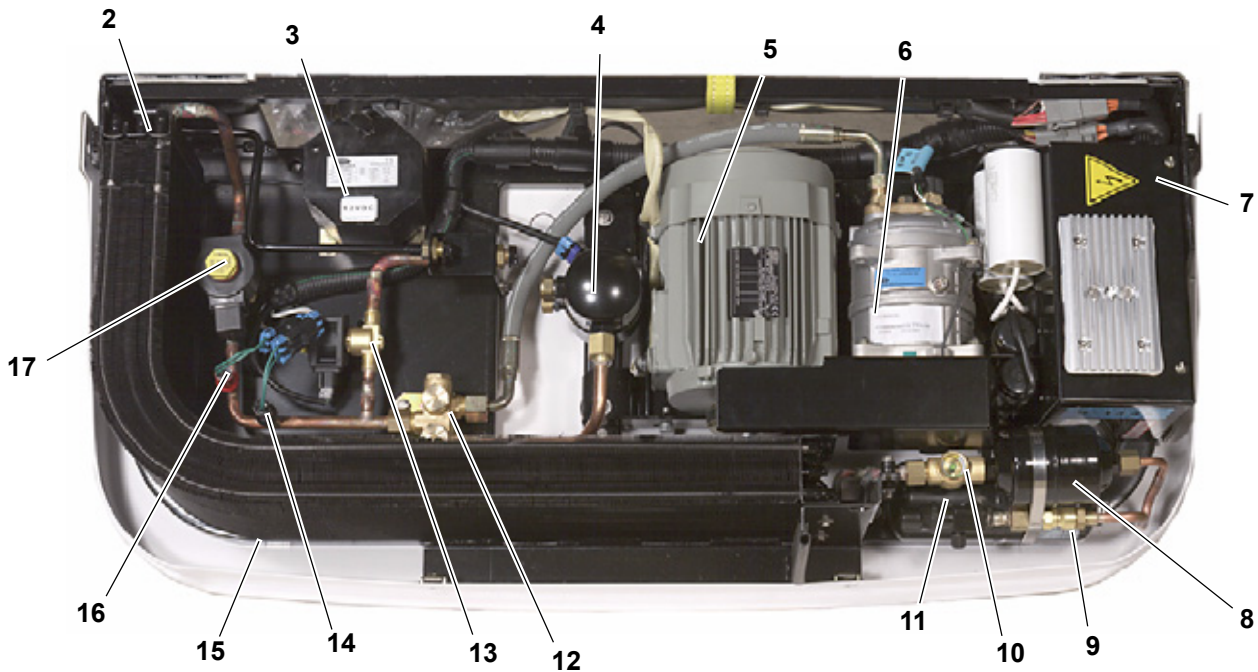
Table 2-2 Additional Support Manuals

Manual Number	Equipment Covered	Type of Manual
62-10835	Integra 30S	Parts List
62-10847	Integra 30S	Easy to Run
62-10849	Integra 30S	Operator's Manual

Figure 2.1 Integra 30S

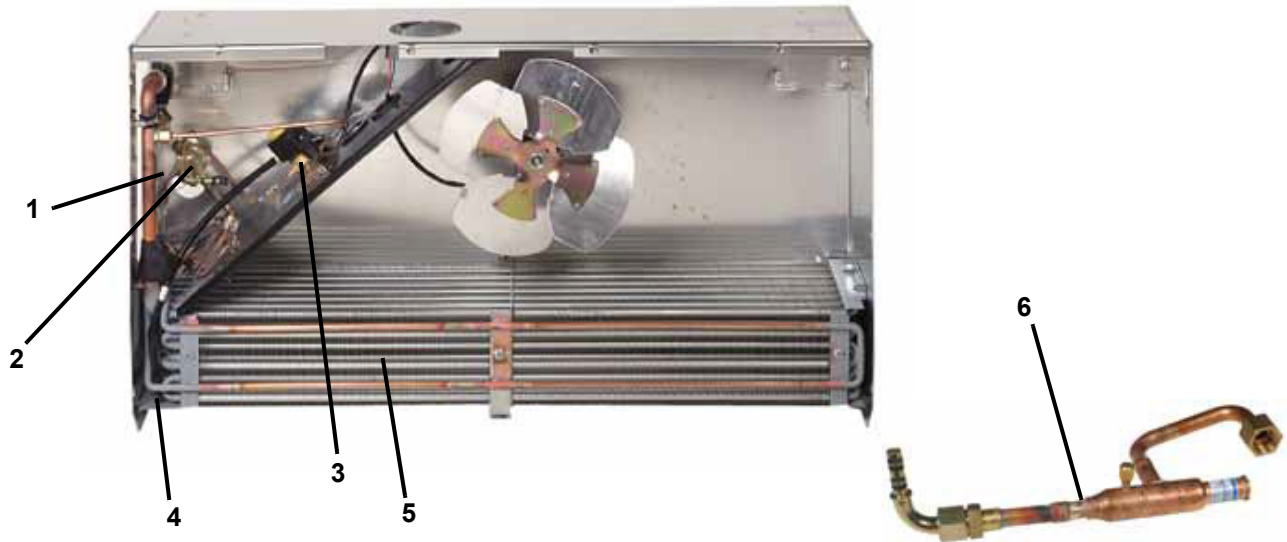


Figure 2.2 Top View



- | | |
|---------------------------------------|---|
| 1. Nameplate | 10. Sight Glass |
| 2. Condenser Coil | 11. Receiver |
| 3. Transformer (TR) | 12. Discharge Manifold |
| 4. Oil Separator | 13. Hot Gas Solenoid Valve (HGS1) |
| 5. Standby Motor | 14. Condenser Pressure Control Switch (HP2) |
| 6. Standby Compressor (See Table 1-1) | 15. Frame |
| 7. Control Box | 16. High Pressure Switch (HP1) |
| 8. Filter Drier | 17. Condenser Pressure Control Valve (HGS2) |
| 9. Liquid Line Check Valve | |

Figure 2.3 Rear View Evaporator

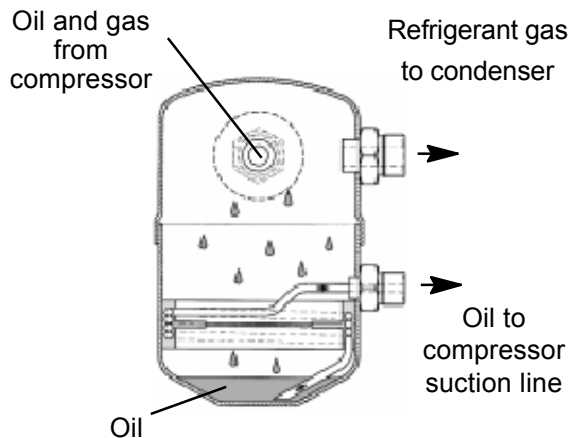


- | | |
|--|---|
| <ul style="list-style-type: none"> 1. Low Pressure Switch (LP) 2. Expansion Valve (TXV) 3. Quench Valve (BPV) | <ul style="list-style-type: none"> 4. Defrost Termination Thermostat (DTT) 5. Evaporator coil 6. Compressor Pressure Regulating Valve (CPR)115V only |
|--|---|

2.3.3 Oil Separator

The oil separator is installed in the discharge line from the road compressor. The hot gas coming from the compressor is forced through a filter which separates the gas from the oil. The oil collects at the bottom after passing through a second filter and then returns to the compressor via a capillary tube.

Figure 2.4 Oil Separator



2.3.4 Hot Gas Solenoid Valve (HGS1)

HGS1 is normally closed and prevents discharge gas from entering the evaporator. The valve opens to allow hot gas refrigerant to be delivered from the compressor to the evaporator during heat or defrost modes.

2.3.5 Condenser Pressure Control Valve (HGS2)

The condenser pressure control valve (or condenser closing valve) is a normally open valve that is powered when the condenser pressure control switch (HP2) is closed. With the solenoid coil de-energized, the valve is in the cool mode and the compressor discharge gas is delivered to the condenser. In the cool mode, heat is removed from the air inside the truck body and rejected to the surrounding air. With the solenoid coil energized, the valve is in the heat mode and the compressor discharge gas is diverted to the evaporator and rejected to the air inside the truck body.

2.3.6 Compressor

The compressor withdraws refrigerant gas from the evaporator and delivers it to the condenser at an increased pressure. The pressure is such that refrigerant heat can be absorbed by the surrounding air at ordinary temperatures.

2.3.7 Standby Motor

The standby motor operates on nominal 115v-1ph-60hz or 208/230v-1ph-60hz or 230v-3ph-60hz power. An overload and short cycle protection is provided along with automatic reset. Units are also equipped with a remote mounted power receptacle.

2.3.8 Receiver

Liquid refrigerant from the condenser is delivered to the receiver. The receiver serves as a liquid reservoir when there are surges due to load changes in the system; as a storage space when pumping down the system and as a liquid seal against the entrance of refrigerant gas into the liquid line.

2.3.9 High Pressure Switch (HP1)

HP1 is a normally closed switch which monitors the system for high pressure and shuts down the unit when pressure rises above a predetermined setting. For HP1 settings see [Section 2.6.2](#).

2.3.10 Condenser Pressure Control Switch (HP2)

HP2 is a normally open switch which closes to signal the microprocessor to activate the condenser fan. HP2 also cycles the condenser pressure control valve (HGS2) and the quench valve (BPV) in addition to the condenser fan in order to maintain head pressure for heating capacity. For HP2 settings see [Section 2.6.2](#).

2.4 Evaporator Section

The evaporator assembly consists of an evaporator fan, evaporator coil, thermostatic expansion valve, defrost termination thermostat, a compressor pressure regulating valve (115V only) and a quench valve.

2.4.1 Thermostatic Expansion Valve

The thermostatic expansion valve is an automatic device which controls the flow of liquid to the evaporator according to changes in superheat to the refrigerant leaving the evaporator. The thermal expansion valve maintains a relatively constant degree of superheat in the gas leaving the evaporator regardless of suction pressure. Thus, the valve has a dual function; automatic expansion control and preventing liquid from returning to the compressor. For TXV superheat settings see [Section 2.6.2](#). To adjust the TXV, refer to [Section 5.15.2](#).

2.4.2 Compressor Pressure Regulating Valve (CPR) (115V Only)

(See [Figure 2.3](#))

The CPR valve is installed on the suction line of the standby compressor to regulate the suction pressure

entering the compressor. The CPR valve is set to limit the maximum suction pressure. For CPR settings refer to [Section 2.6.2](#).

The suction pressure is controlled to avoid overloading the electric motor during high refrigerated compartment temperature operation. To adjust the CPR valve, refer to [Section 5.17](#)

2.4.3 Defrost Termination Thermostat (DTT)

This normally closed thermal switch is on Standby units only. As the evaporator cools to set point, the switch closes and signals microprocessor that defrost may be initiated. Switch terminates defrost by opening at predetermined set point. For DTT settings refer to [Section 2.6.2](#).

2.4.4 Quench Valve (BPV)

The quench valve is a normally closed solenoid valve controlled by the quench thermostat (BPT) mounted on the road compressor discharge line. The valve allows metered liquid refrigerant to enter the suction line in the evaporator in order to provide compressor cooling. For BPT settings refer to [Section 2.6.2](#).

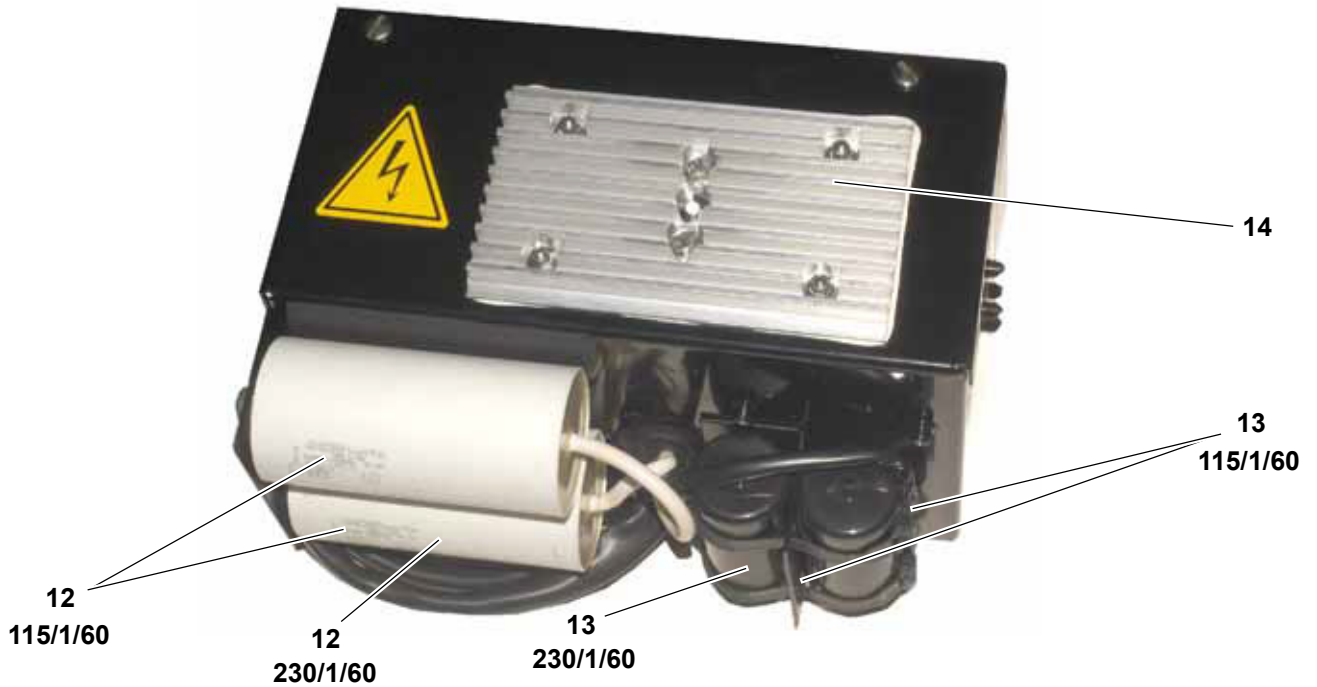
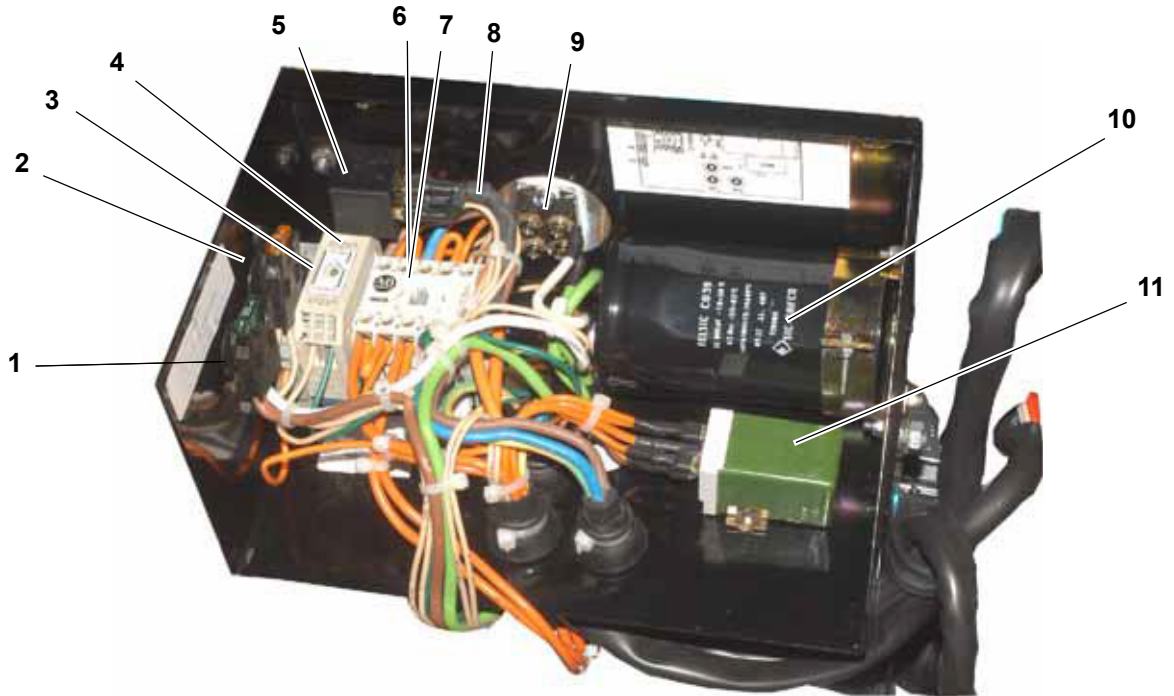
2.4.5 Evaporator

The evaporator is of the tube and fin type. The operation of the compressor maintains a reduced pressure within the coil. At this reduced pressure, the liquid refrigerant evaporates at a temperature sufficiently low enough to absorb heat from the air. Air movement over the evaporator is provided by an electric fan.

2.4.6 Low Pressure Switch (LP)

The low pressure switch is a normally closed switch which signals the microprocessor to shut down the unit when the system is outside of the low pressure limit. For LP settings refer to [Section 2.6.2](#).

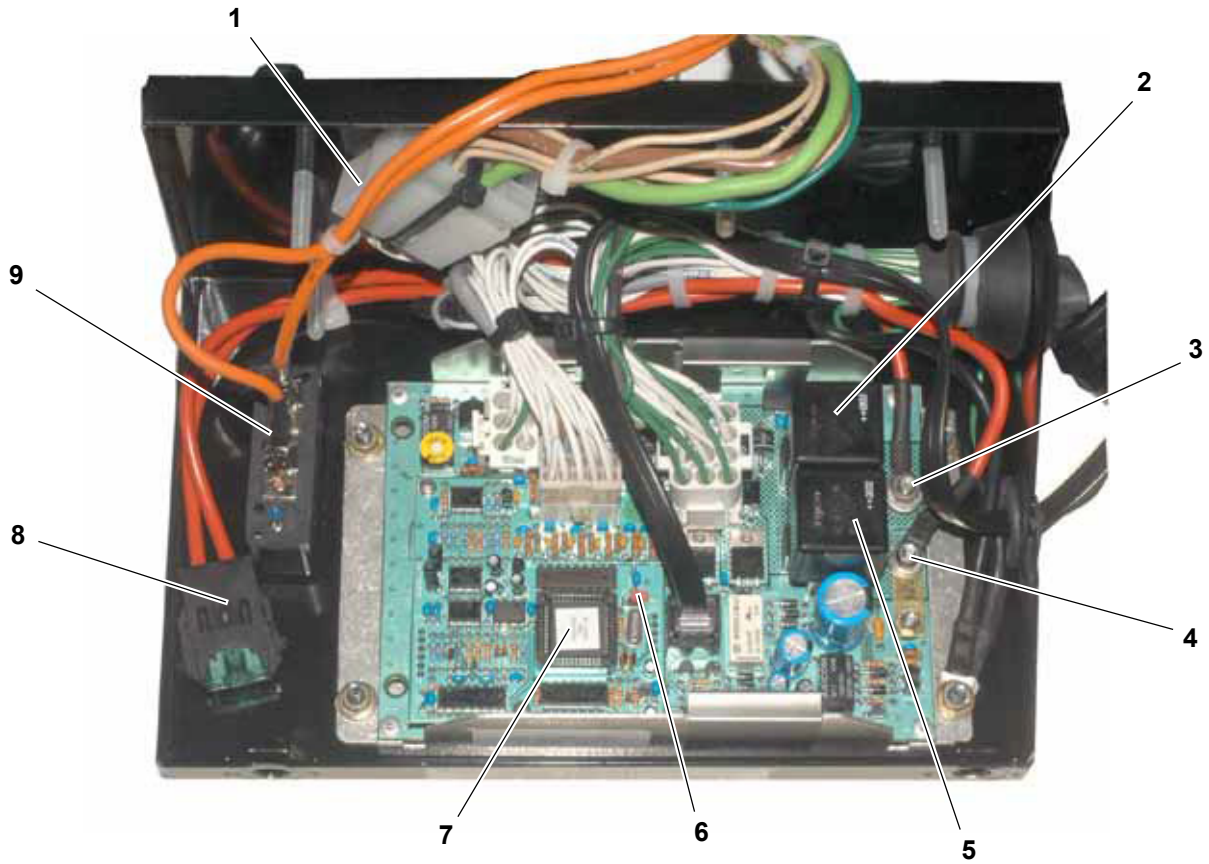
Figure 2.5 Typical Standby Control Box



- 1. Standby clutch fuse (F2) - 30 Amp
- 2. Standby Fuse (F3) - 5 Amp
- 3. Transformer Fuse (F4) - 5 Amp
- 4. Clutch Time Delay Relay (CT) - Single Phase Only
- 5. Clutch Relay (CR)
- 6. Motor Contactor (MC)
- 7. Overload Relay (OL) (230V Only)

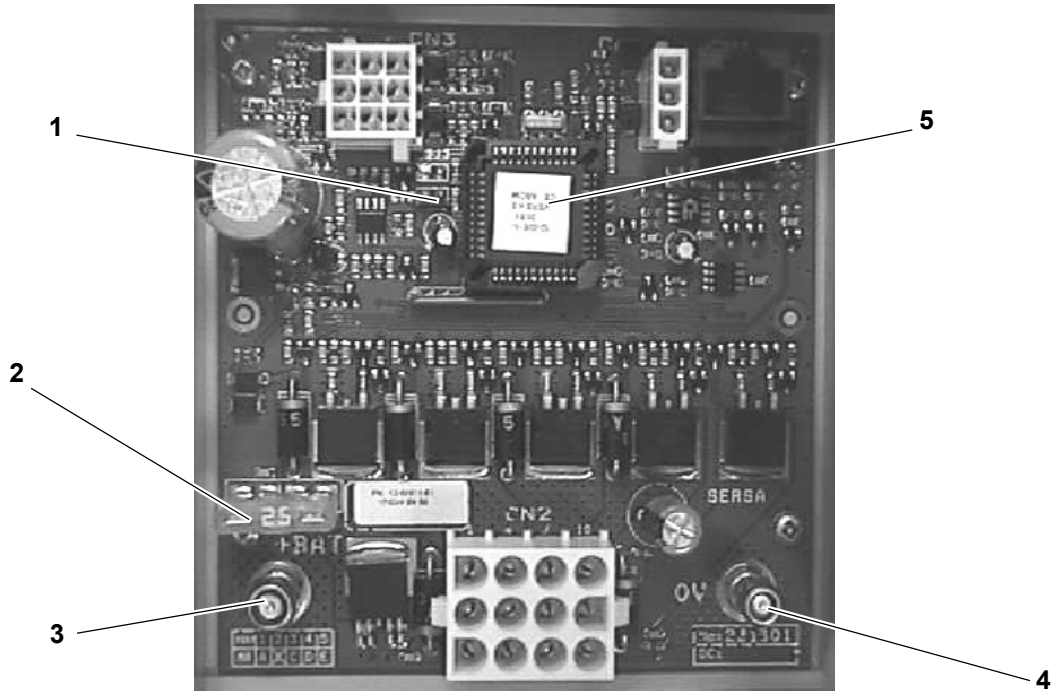
- 8. Diode
- 9. Rectifier Bridge Assembly (BR)
- 10. Filter Capacitor (C1)
- 11. Start Relay (STBR)
- 12. Run Capacitor (CR)
- 13. Start Capacitor (CS)
- 14. Heat sink (rectifier bridge)

Figure 2.6 Standby Microprocessor Module



- | | |
|----------------------------------|--|
| 1. Connector | 6. °C or °F Temperature Selector |
| 2. Road Relay (RR) | 7. Microprocessor (PC) |
| 3. 12 Volt dc Road Connection | 8. Road Fuse (F1) 30A |
| 4. 12 Volt dc Standby Connection | 9. Overload Relay (OL) 25A (115V Only) |
| 5. Standby Relay (SR) | |

Figure 2.7 Road Microprocessor Module



- | | |
|--|--|
| <ul style="list-style-type: none"> 1. °C or °F Temperature Selector 2. Road fuse (25A) 3. + Positive Battery Connection | <ul style="list-style-type: none"> 4. - Negative Battery Connection 5. - Microprocessor (PC) |
|--|--|

2.5 System Operating Controls and Components

The unit is furnished with a microprocessor control system. Once the set point is entered at the Cab Command, the unit will operate automatically to maintain the desired temperature within very close limits.



Beware of unannounced starting of the standby motor, evaporator fan or condenser fan. The unit may cycle the standby motor or fans unexpectedly as control requirements dictate.

The control system consists of the Cab Command located in the driver's section (Figure 2.8) and the microprocessor module (Figure 2.6) located in the control box.

The Carrier Transicold Control System incorporates the following features:

- a. Control return air temperature to tight limits by providing refrigeration control, heat and defrost to ensure conditioned air delivery to the load.
- b. Permanently displays the return air temperature and on request the set point temperature.
- c. Digital display and selection of data.



Under no circumstances should anyone attempt to repair the microprocessor module or Cab Command! Should a problem develop with these components, contact your nearest Carrier Transicold dealer for replacement.

Figure 2.8 Cab Command



2.6 Unit Specifications

2.6.1 Compressor Data

Table 2-3 Compressor Data

Model	TM16
Displacement	9.9 in ³ (162 cm ³)
No. Cylinders	6
Weight	15.5 lbs (7 kg)
Oil Change	5.07 in ³ (180 cm ³)
Approved Oil	Mobil Arctic EAL68

2.6.2 Refrigeration System Data

Defrost Timer

Automatic triggering or at preset intervals: 0 (Disabled), auto, 1h, 2h, 3h, 4h, 5h, 6h

Defrost Termination Thermostat (DTT) (Standby Only)

Opens at: 48° ± 5_F (9° ± 3°C)

Closes at: 37° ± 5_F (3° ± 3°C)

High Pressure Switch (HP1)

Opens at: 355 psig ± 10 psi (24.5 bars)

Closes at: 290 psig ± 10 psi (20 bars)

Condenser Pressure Control Switch (HP2)

Opens at: 130 psig ± 10 psi (9 bars)

Closes at: 175 psig ± 10 psi (12 bars)

Refrigerant charge

Refer to Table 1-1.

Compressor Pressure Regulating Valve (CPR)

115V only

19 ± 1 psig (1.3 Bar)

Thermostatic Expansion Valve (TXV)

Superheat setting = 4°C (7.2°F) at refrigerated compartment temperature of - 20°C (0°F).

Low Pressure switch (LP)

Opens at: -13.23 in HG ± 6 in HG

(- 0.45 ± 0.2 bar)

Closes at: + 6.5 psig ± 3 psig

(+0.44 ± 0.2 bar)

Quench Thermostat (BPT)

Opens at: 248°F (120°C)

Closes at: 220°F (104°C)

2.6.3 Electrical Data

Fan Motors

Table 2-4 Fan Motors Data

Evaporator Fan Motor (EFM)		Condenser Fan Motor (CFM)	
Bearing Lubrication	Factory Lubricated	Bearing Lubrication	Factory Lubricated
Horsepower	0.1 kw		
Operating Amps	10.8 amps	Operating Amps	10 amps
Speed	2800/3000 rpm	Speed	3300 rpm

Standby Compressor Speed

1740 rpm - 60 hz

Standby Motor Ratings

Table 2-5 Standby Motor Ratings

Voltage	Type of Connection	Phase	kW	HP	Speed	Contractor Data	
						MRA*	LRA*
115/1/60	Δ	1	1.5	2	1745 rpm	18.3	132.5
208/1/60	Δ	1			1690 rpm	9.2	70
230/1/60	Δ	1			1715 rpm	8.5	60
230/3/60	Δ	3			1700 rpm	5.9	40

* MRA = Maximum Rotor Amps LRA = Locked Rotor Amps

Resistance = 9.2Ω

Road Compressor Clutch

Amp Draw = 3.75A; Resistance = 3.2Ω

Hot Gas Solenoid Valve (HGS1) Coil

Amp Draw = 1.33 Amp; Resistance = 9.2Ω

Condenser Pressure Control Valve (HGS2) Coil

Amp Draw = 1.65 Amp; Resistance = 7.3Ω

Quench Valve (BPV) Coil

Amp Draw = 1.16 Amp; Resistance = 10.3Ω

Standby Motor Contactor Coil

Amp Draw = 0.19 Amp; Resistance = 60Ω

2.6.4 Torque Values

Table 2-6 Torque Values

Assembly	ft-lb	kg-m
Standby compressor platform	40	5.5
Standby motor platform	40	5.5
Standby motor pulley	32	4.5
Evaporator fan motor	13	1.8
Evaporator fan	7	1.0
Condenser - frame	7	1.0
Mounting Bolts	44 to 60	6 to 8

2.7 Safety Devices

System components are protected from damage caused by unsafe operating conditions by automatically shutting down the unit when such conditions occur. This is accomplished by the following fuses and safety devices.

Table 2-7 Safety Devices

Unsafe Conditions	Safety Device	Automatic restart with fault cleared	Device Setting
Excessive drop in pressure	Automatic reset of low pressure switch (LP)	YES	Cutout: -13.23 in HG (- 0.45 bar) Timer 5 min
Excessive current draw on all microprocessor outputs (evaporator and condenser fan)	Electronic relay	YES	Self-protected opening
Excessive current draw control circuit	Fuse on electronic board	NO	Self-protected opening
Excessive current draw motor compressor	230 = Overload relay 115/1/60 = Circuit Breaker	YES/NO NO	Depending on Selection See electrical wiring diagram
Excessive current draw evaporator and condenser fan motors	Electronic relay	YES	Self-protected opening
Excessive compressor discharge pressure	Automatic reset of High pressure switch (HP1)	YES	Cutout: 355 psig (24.5 bar)
Excessive current draw standby clutch	Fuse F3 (a)	NO	Opens at 5 A (12 V)
Excessive current draw unit in standby operation	Standby fuse F2 (a)	NO	Opens at 30 A (12 V)
Excessive current draw unit in road operation	Fuse F1 (b)	NO	Opens at 30 A (12 V)
Connection error on primary transformer	Fuse F4 and/or F5 (a)	NO	Opens at 4 A
Excessive temperature on standby motor bearing	Internal Motor Thermostat (PT0)	YES	Self-protected opening
Clutch malfunction - road (excessive current draw)	Electronic relay	YES	Self-protected opening Opens 311° F (155° C)
Clutch malfunction - road (insufficient current draw)	Electronic relay	YES	Detection of min. threshold at 750 mA
Double power supply (road + standby)	Microprocessor	YES	Display on Cab Command until one of the 2 power supplies have been disconnected.
Low battery voltage	Microprocessor	YES	Cutout/cut-in at 10 V
Excessive current draw on ignition circuit (Neiman)	Fuse FI	NO	Opens at 1 A

(a) On road/standby unit only (b) This fuse is located close to the vehicle battery (12 v).

2.8 Refrigerant Circuit

2.8.1 Cooling

(See [Figure 2.9](#))

When cooling, the unit operates as a vapor compression refrigeration system. The main components of the system are the reciprocating compressor, air-cooled condenser, thermostatic expansion valve and the direct expansion evaporator.

The compressor raises the pressure and temperature of the refrigerant and forces it through the discharge check valve and condenser pressure control valve into the condenser tubes. The discharge check valves prevent reverse flow through the non operating compressor.

When operating on the road compressor, the flow also passes through the oil separator where oil is removed and returned to the road compressor.

The condenser fan circulates surrounding air over the outside of the condenser tubes. Heat transfer is thus established from the refrigerant gas (inside the tubes) to the condenser air (flowing over the tubes). The condenser tubes have fins designed to improve the transfer of heat. This removal of heat causes the refrigerant to liquefy. Liquid refrigerant flows from the condenser to the receiver.

The receiver stores the additional charge necessary for low ambient operation and for heating and defrost modes.

The refrigerant leaves the receiver and flows through a manual receiver shut-off valve (king valve).

The refrigerant then flows through a check valve. The check valve serves to prevent reverse flow of refrigerant during the heating/defrost cycle.

The refrigerant then flows through the filter drier, where an absorbent keeps it dry and clean. The refrigerant then flows through a sight glass. The sight glass is fitted with an indicator that changes color to indicate moisture content of the refrigerant. The refrigerant then flows through the subcooler which removes additional heat from the liquid to improve system efficiency.

The liquid then enters the thermostatic expansion valve (with external pressure equalizer) which regulates the flow rate of refrigerant towards the evaporator in order to obtain maximum use of the evaporator heat transfer surface.

The evaporator tubes have aluminum fins to increase heat transfer; therefore heat is removed from the air circulating through the evaporator. This cold air is circulated throughout the truck to maintain the cargo at the desired temperature.

The transfer of heat from the air to the low temperature liquid refrigerant causes the liquid to vaporize. The vapor at low temperature and is then drawn out by the compressor. From this point, the cycle starts over.

On 115v units the refrigerant then enters the compressor regulating valve (CPR) which regulates refrigerant pressure entering the compressor. The cycle then starts over.

The quench valve opens as required to maintain a maximum discharge temperature. (Refer to [Section 2.6.2](#) for settings.)

2.8.2 Heat And Defrost

When refrigerant vapor is compressed to a high pressure and temperature in a compressor, the mechanical energy necessary to operate the compressor is transferred to the gas as it is being compressed. This energy is referred to as the "heat of compression" and is used as the source of heat during the heating or defrost cycle.

When the microprocessor activates heating or defrost, the hot gas solenoid valve energizes and the condenser pressure control valve energizes, closing the port to the condenser and opening a port which allows heated refrigerant vapor to flow directly to the evaporator coil.

The main difference between heating and defrosting is that when in heating mode the evaporator fans continue to run thus circulating the air throughout the truck to heat the product. When in defrost, the evaporator fans stop, thus allowing the heated vapor to defrost any ice build-up on the coil.

When the pressure is above the setting of the condenser pressure control switch, the condenser pressure control valve (HGS2) is closed to prevent additional pressure rise in the system. When pressure is below the setting of the condenser pressure control switch, the valve is opened to pressurize the receiver and force additional refrigerant into the system and increase heating capacity.

Figure 2.9 Refrigeration Circuit Cooling Cycle

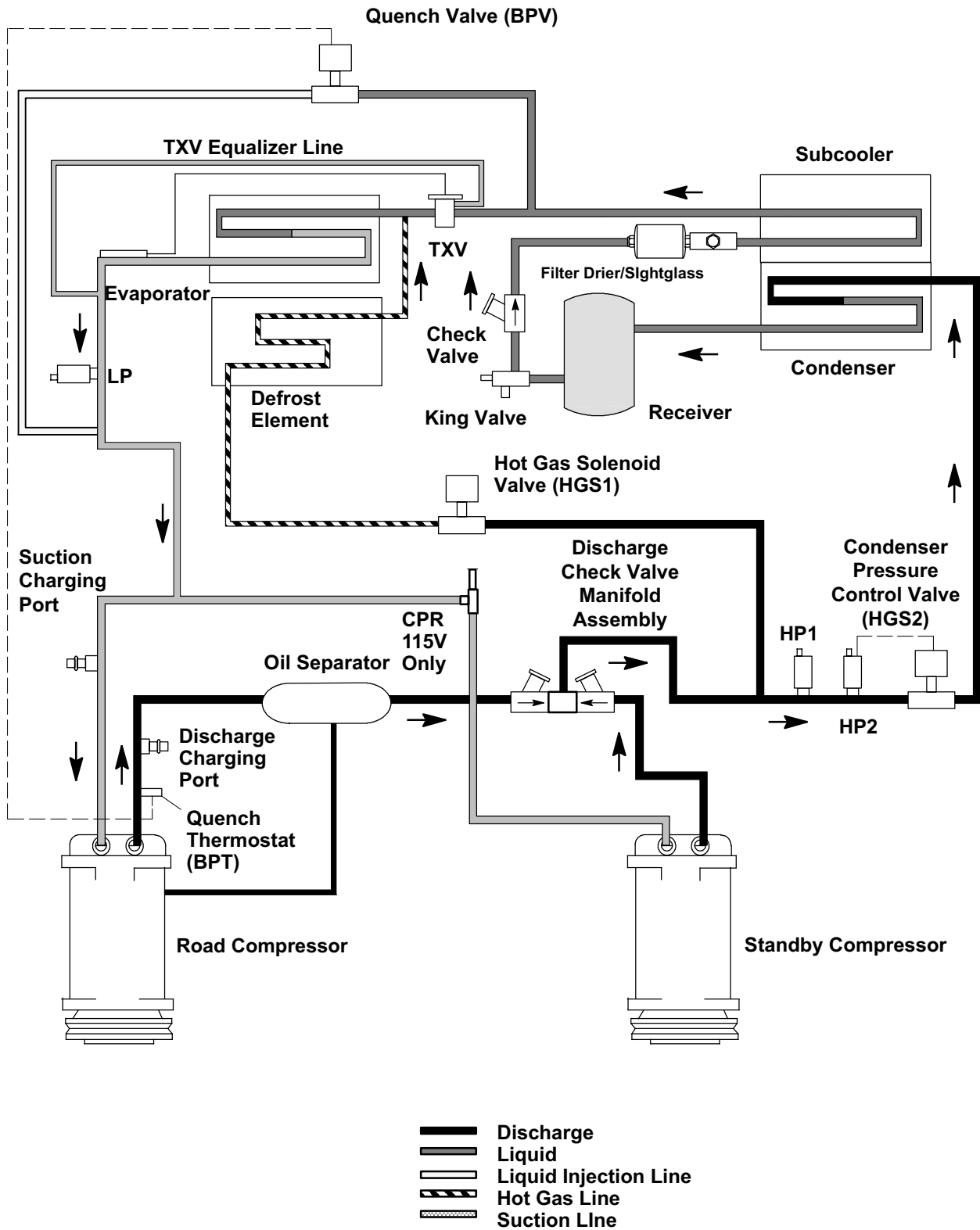
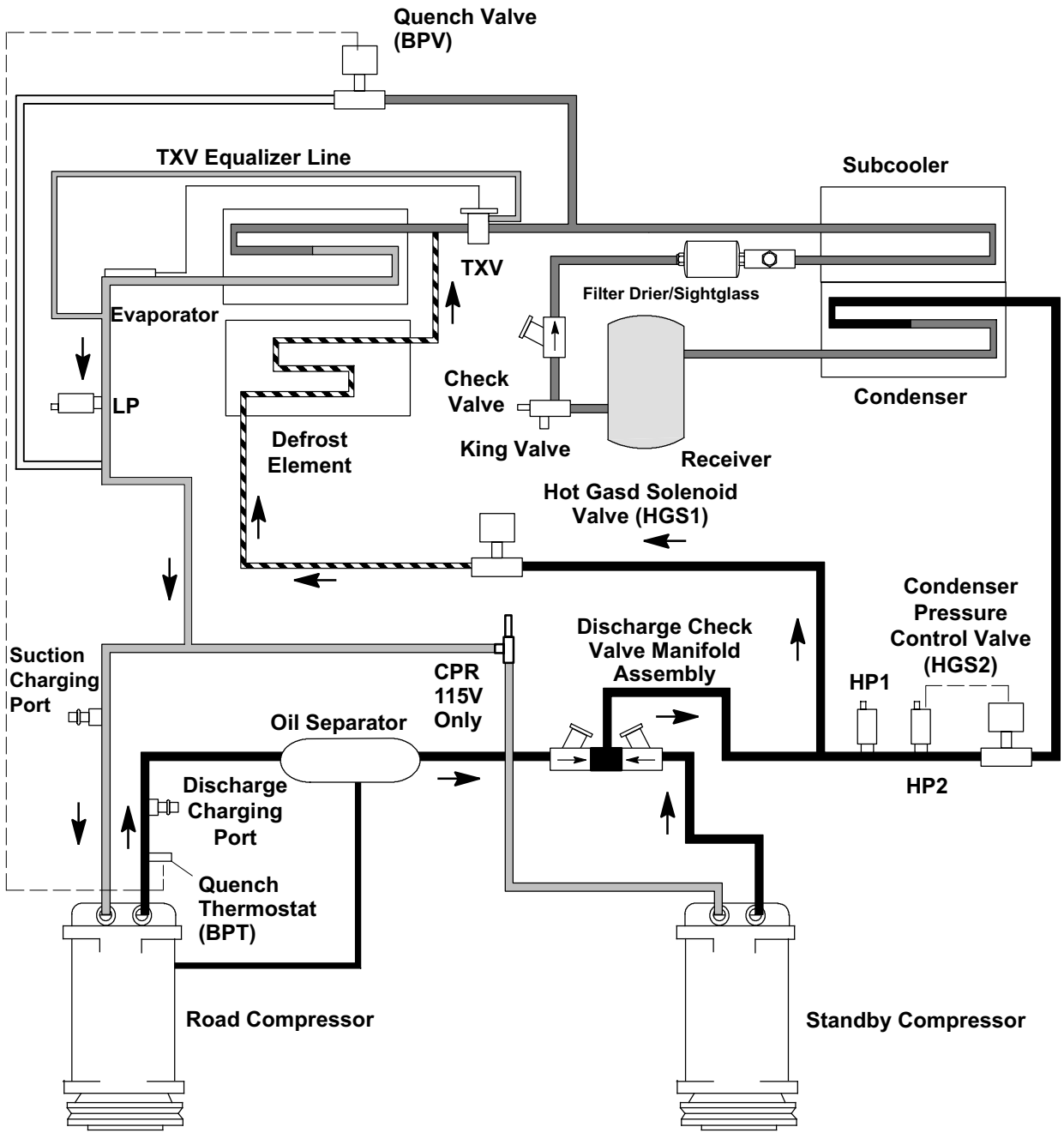


Figure 2.10 Refrigeration Circuit Heating Cycle



- Discharge
- Liquid
- - -** Liquid Injection Line
- ▨** Hot Gas Line
- ⋯** Suction Line

SECTION 3

Operation

3.1 Control System

3.1.1 Introduction



Under no circumstances should anyone attempt to service the microprocessor module and Cab Command! Should a problem develop with the control system, contact your nearest Carrier Transicold dealer for replacement components.

The Control System consists of the microprocessor module (Figure 2.6), Cab Command (Figure 3.1) and interconnecting wiring.

- The Microprocessor Module includes the temperature control software and necessary input/output circuitry to interface with the unit controls.
- The Cab Command is remotely mounted in the truck. The Cab Command includes the LCD display and keypad. The keypad and display provide user access and readouts of microprocessor information. The information is accessed by keypad selections and viewed on the display.

3.1.2 Microprocessor Module

The microprocessor controls the following functions:

- Maintains the refrigerated compartment temperature at set point by regulating the cooling, heat, off mode and automatic defrost cycles.
- Permanently displays the return air temperature and on request the set point temperature.
- Digital display and selection of data.

For further details on digital message display, see Section 3.6.

3.1.3 Cab Command

The Cab Command is mounted in the cab and allows the driver to carry out the control operations:

- Start up and shut-down the unit
- Automatic start-up in road or standby mode
- Adjust the set point
- Defrost

The driver can display the refrigerated compartment temperature, and see whether the set point is being maintained by checking the green indicator. The indicator lights up red in the event of a malfunction.

When the battery voltage is too low, a fail-safe system shuts down the unit. Unit restart is automatic and time-delayed if the voltage rises to the normal level.

The command consists of the display and the keypad. The keypad and display serve to provide user access and readouts of microprocessor information. The information is accessed by keypad selections and viewed on the display.

Figure 3.1 Cab Command



a. Display

The digital display consists of three alphanumeric characters. The default value displayed is the refrigerated compartment temperature. The microprocessor enables selection of the display in degrees Celsius or Fahrenheit. The display also includes settings for defrost operation (dF). The display also includes three LEDs:

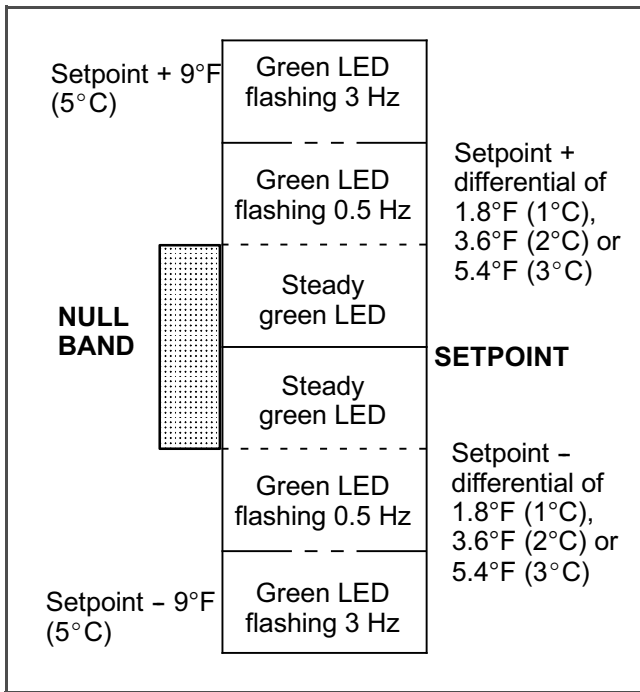
888	Digital Display
	Standby operation LED
	Road operation LED
	Unit operating LED <ul style="list-style-type: none"> • Green: cycling (left-hand side) • Red: malfunction (right-hand side)

Unit operating LEDs

a. Green Light Status for Standby Units

Under normal operation, the green LED will indicate the temperature control status as follows:

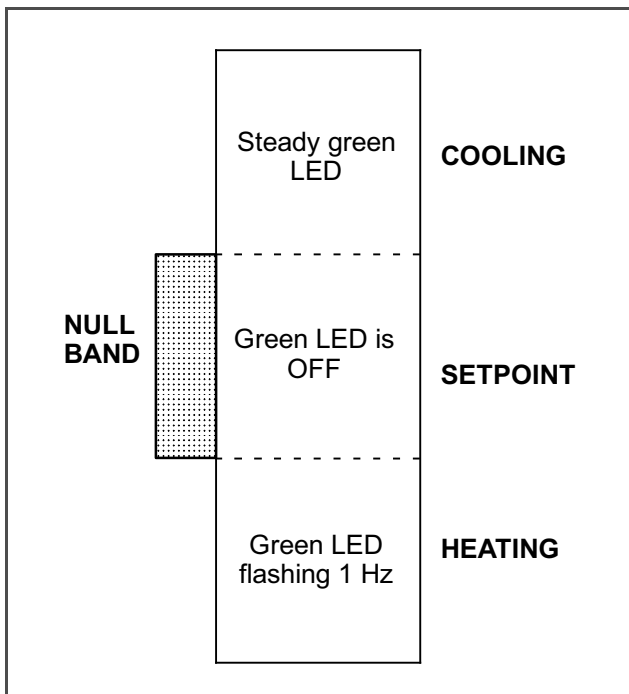
Figure 3.2 Green Light Status - Standby



b. Green Light Status for Road Only Units

Under normal operation, the green LED will indicate the temperature control status as follows:

Figure 3.3 Green Light Status - Road Only



c. Red Light Status

After an alarm has been present for 15 minutes, the red unit indicating light flashes at 3 Hz. The light will continue to flash at 0.5 Hz until the temperature returns to set point \pm differential. At that point the steady green indicator light will light and the alarm become inactive.

d. Keypad

The keypad consists of six keys that enable the operator to activate various functions, display operating data and modify operating parameters.

	Manual defrost control key
	Unit start-up key
	Unit shut-down key in standby or road mode. On road operation, the unit can also be shut down with the ignition key.

Unit data and function modification keys

	The SET key, together with the + and - keys, enables display and modification of unit operating data. The display scrolls through parameters each time the SET key is pressed.
	Decrease key for selected data
	Increase key for selected data

3.2 Start-Up

3.2.1 Inspection

Before starting the truck engine or connecting standby power check the following:

- Check condenser coil for cleanliness.
- Check condition of refrigerant hoses.
- Check condition and tension of compressor belt(s).
- Check condition of condenser fan blade, motor and brushes.
- Check truck battery fluid level.
- Check truck battery and terminal connections - clean and tighten as necessary.

WARNING

Inspect battery cables for signs of wear, abrasion or damage at every Pre-Trip inspection and replace if necessary. Also check battery cable routing to ensure that clamps are secure and that cables are not pinched or chafing against any components.

- Check defrost water drains from evaporator.
- Check evaporator coil for cleanliness.
- Check condition of evaporator fan blades, motor and brushes.
- Check oil level in standby compressor sight glass.

3.2.2 Connect Power

If the unit is to be operated in the standby mode, connect power as follows:

WARNING

Do not attempt to connect or remove power plug before ensuring the unit is OFF (press OFF key on Cab Command) and external power circuit breaker is open.

WARNING

Make sure the power plug is clean and dry before connecting to any power source.

- Check that the external power source corresponds to the characteristics of the unit (see [Section 2.6.3](#)). Make sure external power source circuit breaker is open.
- Make sure unit is OFF by pressing the OFF button on the Cab Command.
- Plug the power cord into unit receptacle.

3.2.3 Starting



CAUTION

If starting unit for the first time after installation the compressor pressure regulating valve will need to be reset (refer to [Section 5.14](#))

CAUTION

If starting unit for the first time after installation or starting after adding/removing an optional feature or if Owners operating parameters have changed the Configuration will need to be reset (refer to [Section 3.9](#))





Depending on desired mode of operation, either start the vehicle engine or close the power source circuit breaker.

	Press the ON key to start the unit (For Standby units, start up is time delayed for 10 seconds. For Road units, start up is time delayed for 40 seconds.) The digital display of the Cab Command displays the refrigerated compartment temperature.
	Check that temperature set point is correct by pressing the SET key. The set point temperature is highlighted on the digital display.

3.3 Set Point Adjustment

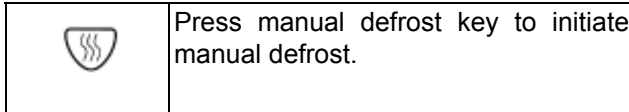
It is possible to increase or decrease the set point by whole numbers until the required set point is displayed. If the display stays highlighted, the set point displayed has not been validated.

The new setting for the set point is validated by pressing the SET key.

	Displays the set point temperature
	Decrease the set point.
	Increase the set point.
	Validate set point temperature. Return to display of refrigerated compartment temperature

3.4 Manual Defrost

Check that refrigerated compartment temperature is 40°F (4.4°C) or lower.



3.5 Defrost Cycle Adjustment

Defrost parameters may be set to eliminate defrost, decrease the time between defrosts, allow full automatic defrost, increase the time between defrosts or set a forced interval between defrosts. To adjust the defrost cycle, do the following:

1. Press the OFF key to shut down the unit.
2. Press the Manual Defrost and ON keys to display parameters.
3. Press the + or - keys to modify parameters.
4. Press the SET key to validate the modified settings. This will return the display to the refrigerated compartment temperature.

NOTE

If no key is pressed within five seconds of adjusting settings, the system reverts to displaying the refrigerated compartment temperature. Only validated changes are recorded.

3.6 Alarm Display

In the event of a malfunction, the unit will shut down and the Cab Command will display an error message or alarm message. The message will remain displayed until the malfunction is corrected. If standby power is connected and the malfunction is such that standby operation can be allowed, the unit will start in the standby mode.

3.6.1 Accessing Alarm Messages

To access the alarm messages:

1. Press the SET key for five seconds. This enables access to alarm messages.
2. In the event of more than one alarm, press the + or - keys to list them.

Table 3-1 Alarms For Road Units

Malfunction Codes	Description	Alarm Only	Alarm and Unit Shut Down
A00	Red LED flashes No malfunction. Unit in operation.		
A01	High or Low pressure switch		X
A02	High or Low pressure switch		X
A04	Road clutch malfunction	X	
A06	Condenser fan motor fault	X	
A07	Evaporator fan motor fault	X	
A09	Hot gas solenoid valve malfunction (HGS1)	X	
A10	Quench valve malfunction (BPV)	X	
A11	Condenser pressure control valve (HGS2)	X	
A15	Setpoint adjusted out of the range -20.2 to 86°F (-2.9°C / + 30°C) or below the programmed low threshold.	X	
BAT	Low battery voltage	X	
EE	Probe malfunction or evaporator temperature out of limits [- 49° to 174°F (- 45° to 79°C)]	X	
Err	Programming error on part of operator		X

Table 3–2 Alarms For Standby Units

Malfunction Codes	Description	Alarm Only	Alarm and Unit Shut Down
A00	Red LED flashes No malfunction. Unit in operation.		
A01	Low pressure switch		X - after 3 successive faults
A02	High pressure switch		X - after 5 successive faults
A03	Electric motor overload protection on start-up		X - after 3 successive faults
A04	Road clutch malfunction	X	
A05	Standby clutch and contactor	X	
A06	Condenser fan motor fault	X	
A07	Evaporator fan motor fault	X	
A08	Heating option command	X	
A09	Hot gas valve malfunction (HGS1)	X	
A10	Quench valve malfunction (BPV)	X	
A11	Condenser pressure control valve (HGS2)	X	
A12	High temperature alarm	X	
A13	Low temperature alarm	X	
A14	Defrost alarm > 45 minutes	X	
A15	86°F (- 29°C/+ 30°C) or below the programmed minimum set point	X	
BAT	Low battery voltage	X	See Section 3.6.2
EE	Probe malfunction or evaporator temperature out of limits [- 49°to 174°F (- 49°to 79°F)]	X	
Err	Programming error on part of operator		X

3.6.2 Low Battery Voltage Alarm for Road Only Units

There is a 40 second time delay during start-up. After this delay if the battery voltage drops below 10V ± 0.2V for Standby units or 10.5V ± 0.5V for Road only units, the microprocessor will react 20 seconds later and the unit will go out of temperature control mode. The microprocessor will check the voltage after another 20 seconds. If battery voltage still has not risen, the unit will remain out of temperature control mode for another 10 minutes, and the battery alarm will be activated and the Cab Command will display the message “bAt”. Unit will return to temperature control mode if battery voltage has risen after 10 minutes. If the battery voltage has not risen after this 10 minute period, the unit will remain out of temperature control mode another two minutes and the microprocessor will check the battery voltage every two minutes. Unit will return to temperature control mode in its current configuration when battery voltage rises to 10V ± 0.2V for Standby units or 10.5V ± 0.5V for Road only units.

3.6.3 Clearing Alarm Messages

The alarm list provides information on current alarms and past alarms which may be helpful in trouble shooting unit problems. Once all the alarm information has been noted and service is complete, the alarm list may be cleared.

To clear the alarm messages:

1. Press the ON key, + key and - key at the same time.

3.7 Checking the EEPROM Version

1. Press the ON key to start up the unit.
2. Press the SET key to display EEPROM version number.
3. Press the SET key again to return to the refrigerated compartment temperature.

3.8 Stopping the Unit

Press the OFF key or turn the ignition key to the off position.

3.9 Microprocessor Configuration



If starting the unit for the first time after installation or starting after adding/removing an optional feature or if Owners operating parameters have changed, the Configuration will need to be reset.

3.9.1 Road Only Functional Settings

The procedure for adjusting the functional parameters is as follows:

1. The temperature display is selectable between Fahrenheit and Celsius. Units are configured for Celsius from the factory. To set the display to Fahrenheit, the selection jumper must be removed and discarded. See [Figure 2.6](#).

NOTE

The board contains another set of pins similar to the Degrees C/Degrees F selection jumper, marked as J1. This jumper is not used for unit operation, but it is used during the microprocessor controller manufacturing process. **DO NOT CONNECT THE J1 PINS TOGETHER.**

2. Press the OFF key to shut down the unit.

NOTE

The following steps must be performed with the unit OFF.

3. Press the Defrost and ON keys simultaneously in order to display parameters.

NOTE

If no buttons are pressed within 5 seconds of pressing the Defrost and ON keys or modifying parameters, the Cab Command reverts to refrigerated compartment temperature display and the configuration procedure is aborted.

4. Press the + or - keys to modify parameters.
 - a. The defrost duration parameter is displayed. This setting determines the length of time in minutes the unit will remain in defrost once defrost is initiated. The defrost duration can be selected by scrolling through available options (10, 20, 25, 30 or 45 minutes) using the (+) or (-) keys. Selection MUST be validated by pressing the SET key.

- b. The defrost interval parameter is displayed next. This setting determines the time between defrosts in hours. The defrost interval can be selected by scrolling through available options (0, 1, 1.5, 2, 2.5, 3, 4, 5, 6 hours) using the (+) or (-) keys. Selection MUST be validated by pressing the SET key.

5. Press the SET key to validate modified settings.

6. Press the ON key to start-up the unit.

NOTE

The following steps must be performed with the unit OFF.

7. Press the + key, then - key, then Defrost keys. All keys should be held momentarily after pressing in the correct sequence.

NOTE

If no buttons are depressed within five seconds of pressing the ON key or modifying parameters, the Cab Command reverts to refrigerated compartment temperature display and the configuration procedure is aborted.

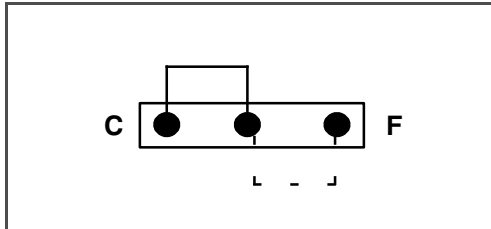
8. Press the + or - keys to modify parameters.
 - a. The minimum set point parameter is displayed. The minimum set point can be selected by scrolling through available options [- 20°F (- 28.9°C), - 4°F (- 20°C), 32°F (0°C)] using the (+) or (-) keys. Factory setting is - 32°F (0°C). Selection MUST be validated by pressing the SET key.
 - b. The null mode differential temperature is displayed next. This setting determines the temperature difference between refrigerated compartment temperature and set point that controls compressor cycling. The differential can be selected by scrolling through available options [1.8°F (1°C), 3.6°F (2°C), or 5.4°F (3°C)] using the (+) or (-) keys. Factory setting is 3.6°F (2°C). Selection MUST be validated by pressing the SET key.
 - c. The ON/OFF (Continuous airflow) parameter for the evaporator fan is displayed next. This feature determines whether the evaporator fan is on or off when the unit cycles off upon reaching set point. The factory setting is OFF. Change setting by using the (+) or (-) keys. Selection MUST be validated by pressing the SET key.
 - d. The return air temperature will be displayed after the above sequence.
9. Press the SET key to validate modified settings.

3.9.2 Road/Standby Functional Settings

The procedure for adjusting the functional parameters is as follows:

1. The temperature display is selectable between Fahrenheit and Celsius. Units are configured for Celsius from the factory. To set the display to Fahrenheit, move the Celsius end of the jumper to the Fahrenheit pin as shown in [Figure 3.4](#).

Figure 3.4 Temperature Selection Jumper



NOTE

The board contains another set of pins similar to the Degrees C/Degrees F selection jumper, marked as J1. This jumper is not used for unit operation, but it is used during the microprocessor controller manufacturing process. **DO NOT CONNECT THE J1 PINS TOGETHER.**

2. Press the OFF key to shut down the unit.

NOTE

The following steps must be performed with the unit OFF.

3. Press and hold both the Defrost key and ON key simultaneously in order to display parameters.

NOTE

If no buttons are depressed within 5 seconds of pressing the ON key or modifying parameters, the Cab Command reverts to refrigerated compartment temperature display and the configuration procedure is aborted.

4. Press the + or - keys to modify parameters.
 - a. The defrost interval parameter is displayed. This setting determines the time between defrosts in hours. The defrost interval can be selected by scrolling through available options. Settings are for either automatic defrost (AUT) or fixed time intervals between 1 to 6 hours. The setting can be selected by pressing the (+) or (-) keys. Selection MUST be validated by pressing the SET key.
5. Press the SET key to validate modified settings.
6. Press the ON key to start-up the unit.

NOTE

The following steps must be performed with the unit ON.

7. Press the + key, then - key, then Defrost keys. All keys should be held momentarily after pressing in the correct sequence.

NOTE

If no buttons are depressed within five seconds of pressing the ON key or modifying parameters, the Cab Command reverts to refrigerated compartment temperature display and the configuration procedure is aborted.

8. Press the + or - keys to modify parameters.
 - a. The minimum set point parameter is displayed. The minimum set point can be selected by scrolling through available options [- 20°F (- 28.9°C), - 4°F (- 20°C), 32°F (0°C)] using the (+) or (-) keys. Factory setting is - 20°F. Selection MUST be validated by pressing the SET key.
 - a. The null mode differential temperature is displayed next. This setting determines the temperature difference between refrigerated compartment temperature and set point that controls compressor cycling. The differential can be selected by scrolling through available options [1.8°F (1°C), 3.6°F (2°C), or 5.4°F (3°C)] using the (+) or (--) keys. Factory setting is 3.6°F (2°C). Selection MUST be validated by pressing the SET key.
 - a. The ON/OFF (Continuous airflow) parameter for the evaporator fan is displayed next. This feature determines whether the evaporator fan is on or off when the unit cycles off upon reaching set point. The factory setting is OFF. Change setting by using the (+) or (--) keys. Selection MUST be validated by pressing the SET key.
 - a. The 2ET or 3ET parameter is now displayed. This feature determines heating mode operation based on the presence of a condenser pressure control valve. Since all 30S units covered by this manual have a condenser pressure control valve installed, 3ET must be selected. This enables cooling, null, and heating modes of operation. Selection MUST be validated by pressing the SET key. Change setting by using the (+) or (-) keys. Selection MUST be validated by pressing the SET key. Press the SET key to validate modified settings.



Beware of unannounced starting of the unit. The unit may cycle the fans and operating compressor unexpectedly as control requirements dictate. Press the OFF key on the Cab Command and disconnect power plug.

SECTION 4

Temperature Control

4.1 Sequence of Operation

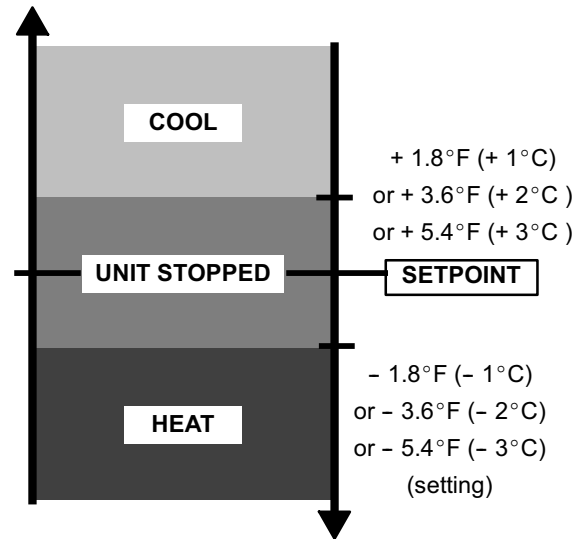
General operation sequences for cooling, null, and heating are provided in the following paragraphs. The microprocessor automatically selects the mode necessary to maintain refrigerated compartment temperature at set point.

4.1.1 Perishable Mode

The unit operates in the perishable mode with set points above 10°F (-12°C)

- a. With return air temperature above set point and decreasing, the unit will be cooling with the compressor and evaporator fans operating. (See [Section 2.8.1](#) for a description of the refrigeration circuit during cooling) The condenser fan will operate for the first three minutes after start up then operate under the control of the condenser pressure control switch (HP2). The green unit operating LED will operate in accordance with [Figure 3.2](#) or [Figure 3.3](#).
- b. If discharge temperature increases to the set point of the quench thermostat (BPT), the thermostat will close, energizing the quench valve (BPV). This will allow liquid into the suction line in order to cool compressor. Once the discharge temperature decreases to the certainty of the PPT, the thermostat will open, DE-energizing the PP.
- c. Once temperature decreases to the certainty, the unit will enter the null mode. If the continuous air flow parameter is set to ON, the evaporator fans will continue to operate with all other components OFF. If the continuous air flow parameter is OFF, the evaporator fans and all other components will be OFF. A 5 minute delay is required before restart is allowed.
- d. If temperature increases during the null mode, the unit will restart in cooling.
- e. If temperature continues to decrease, the unit will enter the heating mode with the compressor and evaporator fans operating and the hot gas solenoid valve (HGS1) energized (open). The condenser fan and condenser pressure control valve (HGS2) will operate under the control of the condenser pressure switch (HP2). If the engine coolant or electric heat option is installed, the optional heaters will also be energized. (See [Figure 2.8.2](#) for a description of the refrigeration circuit during heat and defrost.)

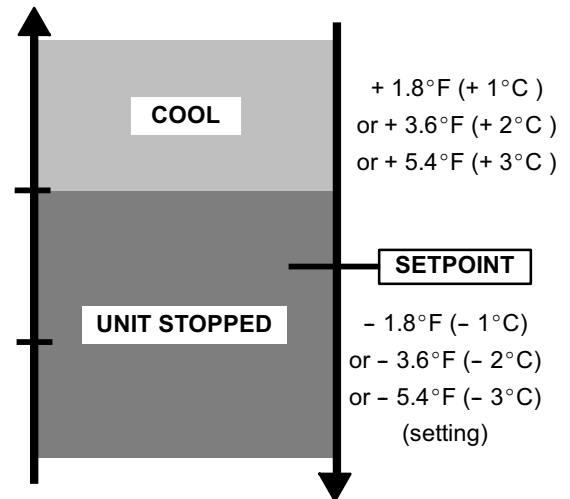
Figure 4.1 Operating Sequence - Perishable Mode



4.1.2 Frozen Mode

The unit operates in the frozen mode with set points at or below 10°F (-12°C). Operation in the frozen mode is the same as in the perishable mode except no heating takes place.

Figure 4.2 Operating Sequence - Frozen Mode



4.2 Defrost Cycle

Defrost is an independent cycle overriding cooling and heating functions in order to melt frost and ice from the evaporator when necessary. Defrost may be initiated by the microprocessor or manually by the operator once the defrost termination thermostat has closed. (See [Section 2.6.2](#) for settings). In defrost mode, the microprocessor displays “dF” on the cab command and set point is no longer displayed.

During defrost, the evaporator fans shut down and operation of the condenser fan is controlled by the microprocessor. The end of the cycle is controlled by

the opening of the defrost termination thermostat. (See [Section 2.8.2](#) for a description of the refrigeration circuit during heat and defrost.)

4.3 Minimum Off Time

Once the unit has cycled off, it will remain off for the minimum off time of five minutes. This prevents the unit from rapid cycling due to changes in air temperature. Air temperature in the refrigerated compartment changes rapidly but it takes time for the product temperature to change.

SECTION 5

Service

WARNING

Beware of unannounced starting of the unit. The unit may cycle the fans and operating compressor unexpectedly as control requirements dictate. Press OFF key on the cab command and disconnect power plug.

CAUTION

Compressor failure will occur if inert gas brazing procedures are not used on units with R-134A and POE oil. For more information see Technical Procedure 98-50553-00 - Inert Gas Brazing.

NOTE

To avoid damage to the earth's ozone layer, use a refrigerant recovery system whenever removing refrigerant. When working with refrigerants you must comply with all local government environmental laws, U.S.A. EPA section 608.

5.1 Maintenance Schedule

Regular servicing is required in order to optimize the life and reliability of your unit. The recommended scheduled maintenance intervals and categories are provided in [Table 5-1](#) while descriptions of the service procedures to be carried out under each category are provided in [Table 5-2](#).

Table 5-1 Maintenance Schedules

Kilometers	Miles	Service A	Service B	Service C	Service D
5,000	3,000	X			
30,000	18,000	X	X		
60,000	36,000	X	X	X	
90,000	54,000	X	X		
120,000	72,000	X	X	X	X
150,000	90,000	X	X		
180,000	108,000	X	X	X	
210,000	126,000	X	X		

Refrigerant: Type R-134A.

Road compressor oil type: The road compressors are supplied with CARRIER POLYESTER (POE) oil. Oils of PAG type are strictly incompatible with the operation of this unit, never use an oil other than that approved by CARRIER.

Table 5–2 Service Category Descriptions

Service A	<ol style="list-style-type: none">1. Check the tension of the compressor belt(s).2. Check that the vehicle engine idles correctly with unit operating. Check compressor mounting hardware and belt tension. (Section 5.2)3. Check the tightness of bolts and screws and that the unit is correctly fastened onto the box.
Service B	<ol style="list-style-type: none">1. Clean evaporator and condenser. (Section 5.18 and Section 5.19)2. Replace the road and standby compressor belt(s).3. Check and if required replace the filter drier. (Section 5.10)4. Check the operation of cab command.5. Check the defrost<ul style="list-style-type: none">• Cut-in• Fan shut-down• Cut-out• Defrost water drain
Service C	<ol style="list-style-type: none">1. Check the operation of the evaporator and condenser fans. Change the condenser/ evaporator motor brushes.2. Change the compressor oil. Use polyester oil (POE) approved by CARRIER. Refer to Section 2.6.1.
Service D	<ol style="list-style-type: none">1. Change the removable relays, fuses and capacitor (if any) in the control box.

5.2 Belt Maintenance and Adjustment

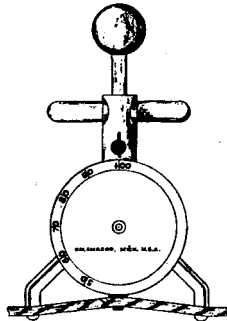


Beware of V-belt and belt-driven components as the unit may start automatically.

A belt tension gauge provides an accurate and easy method of adjusting belts to their proper tension. Properly adjusted belts give long lasting and efficient service. Too much tension shortens belt and bearing life, and too little tension causes slippage and excessive belt wear. It is also important to keep belts and sheaves free of any foreign material which may cause the belts to slip.

The Belt Tension gauge can be used to adjust all belts. The readings which we specify for Carrier Transicold units are applicable only for our belts and application, as the tension is dependent on the size of the belt and distance between sheaves. When using this gauge, it should be placed as close as possible to the midpoint between two sheaves.

Figure 5.1 Belt Tension Gauge

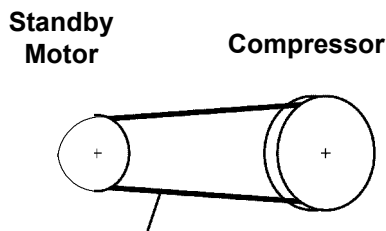


Carrier Part Number 07-00203-00

Belt tension depends on each kit. Refer to Installation Instructions provided with the kit for belt tension requirements. In each kit installation instruction, we indicate the belt tension (given with belt tension gauge P/N 07-00203-00).

When installing a new V-belt the tension should be somewhat higher than specified and readjusted after allowing the unit to run for some time.

Figure 5.2 Layout of V-Belt



Standby Motor/Compressor V-Belt

Table 5-3 Belt Tension (See Figure 5.2)

BELTS	New Install Tension	Running Tension
Standby Motor to Compressor	90 ft./lbs (122 Nm)	80 to 90 ft./lbs (108 to 122 Nm)

5.2.1 Standby Motor-Compressor V-Belt

- Loosen the retaining bolts of the standby motor support plate.
- Replace the V-belt. Position the motor to correct belt tension. Tighten the motor retaining bolts.

5.3 Installing R-134A Manifold Gauge Set

A R-134a manifold gauge/hose set with self-sealing hoses is required for service of models covered within this manual. The manifold gauge/hose set is available from Carrier Transicold. (Carrier Transicold P/N 07-00294-00, which includes items 1 through 6, [Figure 5.3](#)). To perform service using the manifold gauge/hose set, do the following:

5.3.1 Preparing Manifold Gauge/Hose Set For Use

- If the manifold gauge/hose set is new or was exposed to the atmosphere it will need to be evacuated to remove contaminants and air as follows:
 - Back seat (turn counterclockwise) both field service couplers (see [Figure 5.3](#)) and midseat both hand valves.
 - Connect the yellow hose to a vacuum pump and an R-134a cylinder.
 - Evacuate to 10 inHg (254 mmHg) and then charge with R-134a to a slightly positive pressure of 1.0 psig (0.07 Bar).
 - Front seat both manifold gauge set hand valves and disconnect from cylinder. The gauge set is now ready for use.

5.3.2 Connecting Manifold Gauge/Hose Set

To connect the manifold gauge/hose set for reading pressures, do the following:

- Remove access valve cap.
- Connect the field service coupler (see [Figure 5.3](#)) to the access valve.
- Turn the field service coupling knob clockwise, which will open the system to the gauge set.
- Read system pressures.
- Repeat the procedure to connect the other side of the gauge set.

5.3.3 Removing the Manifold Gauge Set

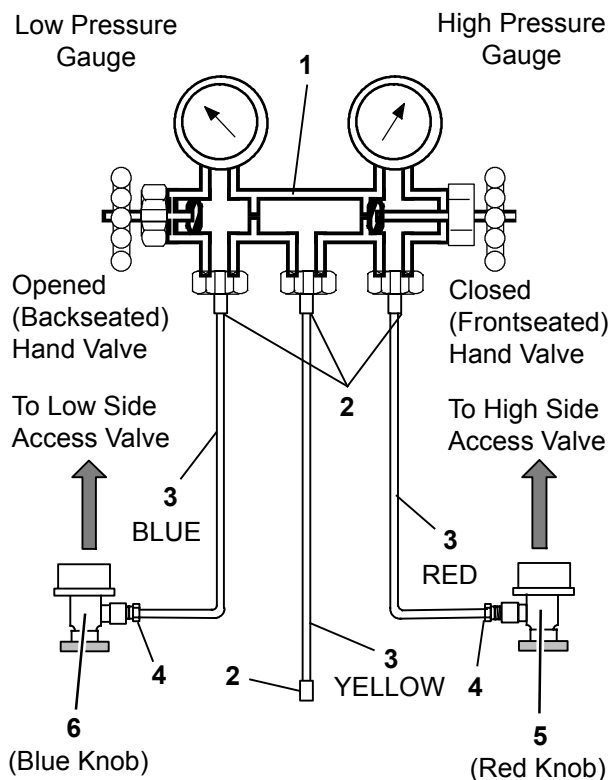
1. While the compressor is still ON, backseat the high side service valve.
2. Midseat both hand valves on the manifold gauge set and allow the pressure in the manifold gauge set to be drawn down to low side pressure. This returns any liquid that may be in the high side hose to the system.



To prevent trapping liquid refrigerant in the manifold gauge set, be sure set is brought to suction pressure before disconnecting.

3. Backseat the low side service valve. Backseat both field service couplers and frontseat both manifold set hand valves. Remove the couplers from the access valves.
4. Install both service valve stem caps and access valve caps (finger-tight only).

Figure 5.3 Manifold Gauge Set (R-134A)



1. Manifold Gauge Set
2. Hose Fitting (0.5-16 Acme)
3. Refrigeration and/or Evacuation Hose (SAE J2196/R-134a)
4. Hose Fitting w/O-ring (M14 x 1.5)
5. High Side Field Service Coupler
6. Low Side Field Service Coupler

5.4 Removing the Refrigerant Charge

NOTE

To avoid damage to the earth's ozone layer, use a refrigerant recovery system whenever removing refrigerant.

Connect a refrigerant recovery system (Carrier P/N MVS-115-F-L-CT (115V) or MVS-240-F-L-CT (240V)) to the unit to remove refrigerant charge. Refer to instructions provided by the manufacturer of the refrigerant recovery system.

5.4.1 Refrigerant Removal From a Non-Working Compressor

To remove the refrigerant from a compressor that is not operational, do the following:

- a. Attach a manifold gauge set as shown in [Figure 5.3](#).
- b. Recover refrigerant with a refrigerant recovery system.
- c. Service or replace components as required and leak check the entire system. (See [Section 5.5](#)).

5.5 Refrigerant Leak Checking

A refrigerant leak check should always be performed after the system has been opened to replace or repair a component. To check for leaks in the refrigeration system, perform the following procedure:

NOTE

Use only R-134A to pressurize the system. Any other gas or vapor will contaminate the system which will require additional purging and evacuation of the high side (discharge) of the system.

- a. If system is without refrigerant, charge system with refrigerant to build up pressure between 30 to 50 psig (2 to 3.4 Bars). Remove refrigerant cylinder and leak check all connections.
- b. Add sufficient nitrogen to raise system pressure to 150 to 200 psig (10.21 to 13.61 bar).
- c. Check for leaks. The recommended procedure for finding leaks in a system is with an electronic leak detector. (Carrier P/N 07-00295-00). Testing joints with soap suds is satisfactory for locating large leaks but be necessary when an electronic leak detector will not function correctly.
- d. Remove refrigerant using a refrigerant recovery system and repair any leaks. Evacuate and dehydrate the unit. (Refer to [Section 5.6](#)) Charge unit with refrigerant. (Refer to [Section 5.7](#))

5.6 Evacuation and Dehydration

5.6.1 General

Moisture can seriously damage refrigerant systems. The presence of moisture in a refrigeration system can have many undesirable effects. The most common are copper plating, acid sludge formation, “freezing-up” of metering devices by free water, and formation of acids, resulting in metal corrosion.

5.6.2 Preparation

- Evacuate and dehydrate only after pressure leak test. (Refer to [Section 5.5](#))
- Essential tools to properly evacuate and dehydrate any system include a good vacuum pump (5 cfm = 8m³H volume displacement, P/N07-00176-01) and a good vacuum indicator such as

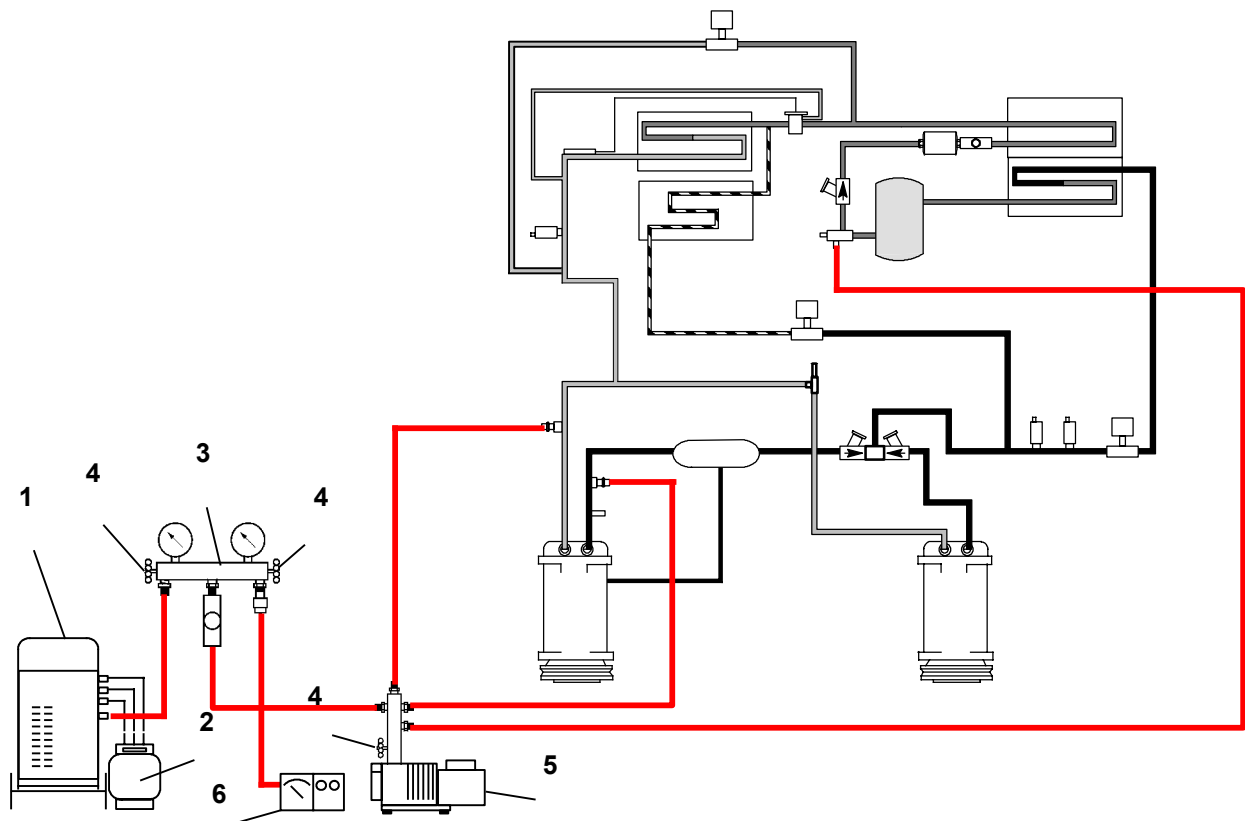
a thermocouple vacuum gauge (vacuum indicator). (Carrier P/N 0700414-00).

NOTE

Use of a compound gauge is not recommended because of its inherent inaccuracy.

- Keep the ambient temperature above 60°F (15.6°C) to speed evaporation of moisture. If ambient temperature is lower than 60°F (15.6°C), ice might form before moisture removal is complete. Heat lamps or alternate sources of heat may be used to raise system temperature.
- Additional time may be saved during a complete system pump down by replacing the filter drier with a section of copper tubing and the appropriate fittings. Installation of a new filter drier may be performed during the charging procedure.

Figure 5.4 Vacuum Pump Connection



- | | |
|------------------------------|----------------------------|
| 1. Refrigerant Recovery Unit | 4. Valve |
| 2. Refrigerant Cylinder | 5. Vacuum Pump |
| 3. Evacuation Manifold | 6. Electronic Vacuum Gauge |

5.6.3 Procedure for Evacuating and Dehydrating System

- Remove refrigerant using a refrigerant recovery system.
- The recommended method to evacuate and dehydrate the system is to connect three evacuation hoses (Do not use standard service hoses, as they are not suited for evacuation purposes.) as shown in [Figure 5.4](#) to the vacuum pump and refrigeration unit. Also, as shown, connect a
- evacuation manifold, with evacuation hoses only, to the vacuum pump, electronic vacuum gauge, and refrigerant recovery system.
- Connect lines to unit and manifold and make sure vacuum gauge valve is closed and vacuum pump valve is open.
- Start vacuum pump. Slowly open valves halfway and then open vacuum gauge valve.

- e. Evacuate unit until the electronic vacuum gauge indicates 2000 microns. Close the electronic vacuum gauge and vacuum pump valves. Shut off the vacuum pump. Wait a few minutes to be sure the vacuum holds.
- f. Break the vacuum with clean dry nitrogen. Raise system pressure to approximately 2 psig (0.14 Bar).
- g. Purge nitrogen from system.
- h. Repeat steps e through g one time.
- i. Evacuate unit to 500 microns. Close off vacuum pump valve and stop pump. Wait five minutes to see if vacuum holds. This checks for residual moisture and/ or leaks.
- j. With a vacuum still in the unit, the refrigerant charge may be drawn into the system from a refrigerant container on a scale. The correct amount of refrigerant may be added by observing the scale. (Refer to [Section 5.7](#))

5.7 Charging the Refrigeration System

5.7.1 Checking The Refrigerant Charge

- a. Start unit in cooling mode and run for approximately ten minutes.
- b. Partially block off air flow to condenser coil so discharge pressure rises to 174 psig (12 Bars).
- c. The unit is correctly charged when there are no bubbles in the sight glass.

5.7.2 Installing a Complete Charge

NOTE

It may be necessary to finish charging the unit using the partial charge method, due to pressure rise in the high side of the system. (Refer to [Section 5.7.3](#))

- a. Dehydrate unit and leave in deep vacuum. (Refer to [Section 5.6](#))
- b. Place refrigerant cylinder on scale and connect charging line from cylinder to receiver outlet (king) valve. Purge charging line at outlet valve.
- c. Note weight of refrigerant cylinder.
- d. Open liquid valve on refrigerant cylinder. Open king valve half way and allow the liquid refrigerant to flow into the unit until the correct weight of refrigerant has been added as indicated by scale. Correct charge will be found in [Table 2-1](#).

NOTE

It is possible that all liquid may not be pulled into the receiver, as outlined in step d. above. In this case, vapor charge remaining refrigerant through the suction service port (See [Section 5.7.3](#)).

- e. When refrigerant cylinder scale indicates that the correct charge has been added, close the liquid line valve on cylinder and backseat the king valve.
- f. Replace all valve caps.
- g. Start unit and check for non-condensables.

5.7.3 Adding a Partial Charge

NOTE

When partially charging the refrigeration system with R-134A, install a vapor charge.

- a. Place refrigerant cylinder on scale and connect charging line between suction port and refrigerant cylinder.
- b. Note weight of refrigerant cylinder.
- c. Run unit on high speed cool and open cylinder vapor valve.
- d. If necessary, partially block off air flow to condenser coil so discharge pressure rises to 174 psig (12 Bars).
- e. The unit is correctly charged when there are no bubbles in the sight glass.
- f. Start unit and check for non-condensables.

5.8 Checking for Non-Condensables

To check for non-condensables, proceed as follows:

- a. Stabilize system to equalize pressure between the suction and discharge side of the system.
- b. Check temperature at the condenser and receiver.
- c. Check pressure at the receiver outlet (King) valve.
- d. Check saturation pressure as it corresponds to the condenser/receiver temperature using the Temperature- Pressure Chart, [Table 5-4](#).
- e. If gauge reading is 3 psig (0.2 Bar) or more than the calculated P/T pressure in step d., non-condensables are present.
- f. Remove refrigerant using a refrigerant recovery system. (Refer to [Section 5.4](#))
- g. Evacuate and dehydrate the system. (Refer to [Section 5.6](#))
- h. Charge the unit. (Refer to [Section 5.7](#))

5.9 Replacing the Compressor

5.9.1 Removing Compressor

WARNING

Ensure power to the unit is OFF, power plug is disconnected and circuit breaker is open or vehicle engine is OFF and negative battery cable is connected before replacing compressor.

- a. Remove the refrigerant. (See [Section 5.4.1](#)).

WARNING

Slowly open the plug on the suction and discharge valves of the new compressor to vent the nitrogen holding charge.

- b. Remove bolts from flanges.

- c. Release and remove belt.
- d. Remove the bolts mounting the compressor. Remove the compressor from chassis.
- e. Remove the pulley from the compressor.

5.9.2 Installing Compressor

- a. To install the compressor, reverse the procedure outlined when removing the compressor. Refer to [Section 2.6.4](#) for torque values.

NOTE

The service replacement compressor is sold without flanges.

- b. Pump down the compressor. (See [Section 5.4](#))
- c. Charge compressor. (See [Section 5.7.2](#))

NOTE

It is important to check the compressor oil level of the new compressor and fill if necessary. (Refer to [Section 2.6.1](#))

- d. Check refrigerant cycles.

Compressor oil type: The road compressors are supplied with CARRIER POLYESTER (POE) oil. Ensure compressor is marked with a factory sticker indicating the correct oil has been installed. Oils of PAG type are **strictly incompatible** with the operation of this unit, **never use an oil other than that approved by CARRIER.**

5.10 Checking and Replacing Filter Drier

5.10.1 Checking Filter Drier

Check for any obstruction of the filter drier by feeling the inlet and outlet connections of the liquid line on the filter cartridge. If the temperature of the outlet connection seems lower than the temperature of the inlet connection, replace the filter drier.

5.10.2 Replacing Filter Drier

Remove refrigerant charge (See [Section 5.4](#)). Remove the drier mounting clip, then replace the filter drier. Following drier replacement, evacuate and recharge unit (refer to [Section 5.6](#) and [Section 5.7](#)).

5.11 High Pressure (HP1) and Condenser Pressure (HP2) Switches

5.11.1 Removing Switch

- a. A Schrader valve is located under each switch to allow removal and installation without removing the refrigerant charge.
- b. Remove switch and test in accordance with [Section 5.11.2](#).
- c. Replace or reinstall switch.

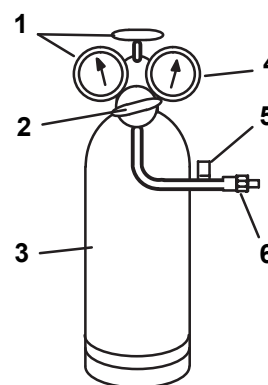
5.11.2 Checking Pressure Switch



Do not use a nitrogen cylinder without a pressure regulator. (See [Figure 5.5](#)) Cylinder pressure is approximately 2350 psig (160 bars). Do not use oxygen in or near a refrigerant system as an explosion may occur.

- a. Remove switch as outlined in [Section 5.11.1](#).
- b. Connect ohmmeter across switch terminals. Ohmmeter will indicate resistance if switch is closed (HP1) or open (HP2) after relieving pressure.
- c. Connect switch to a cylinder of dry nitrogen (see [Figure 5.5](#)).
- d. Set nitrogen pressure regulator higher than cut-out point on switch being tested. Pressure switch settings points are provided in [Section 2.6.2](#).
- e. Close valve on cylinder and open bleed-off valve.
- f. Open cylinder valve. While observing meter, slowly close bleed-off valve and increase pressure until the switch opens (HP1) or closes (HP2). Slowly open bleed-off valve (to decrease pressure) until switch reverts to normal position.
- g. The meter will indicate open. Open pressure on gauge. Slowly open bleed-off valve (to decrease pressure) until switch closes (ohmmeter will move).
- h. If switch does not activate within tolerances provided, replace switch. Test new switch before installation.

Figure 5.5 Typical Setup for Testing Pressure Switches HP1 and HP2

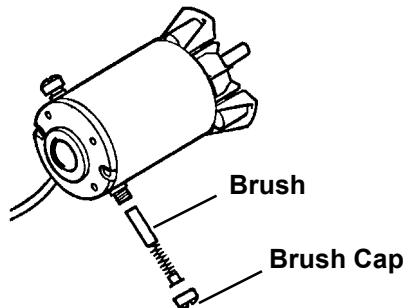


- 1. Cylinder Valve and Gauge
- 2. Pressure Regulator
- 3. Nitrogen Cylinder
- 4. Pressure Gauge (0 to 400 psig = 0 to 28 bars)
- 5. Bleed-off Valve
- 6. 1/4 inch connection

5.12 Checking and Replacing Condenser Fan Motor Brushes

To maintain proper operation of the fan motors, the fan motor commutator and brushes should be checked periodically for cleanliness and wear.

Figure 5.6 Fan Motor Brushes



To check brushes proceed as follows:

- With unit off and battery disconnected, remove brush cap (two per motor). See [Figure 5.6](#).
- Remove brushes (two per motor) and check the length of the brush. If the length is less than 1/4 inch (6 mm) the brushes should be replaced.
- Blow out the brush holder with low pressure air to remove any carbon dust in the holder. This dust could prevent a good contact between the brushes and commutator.
- Remove the back cover of the motor and inspect the commutator. If the commutator is heavily grooved, polish it using fine sandpaper. Do not use abrasive paper. Wipe out any accumulation of greasy material using a clean rag dampened with solvent. Reassemble the motor. Install new brushes and replace cap.

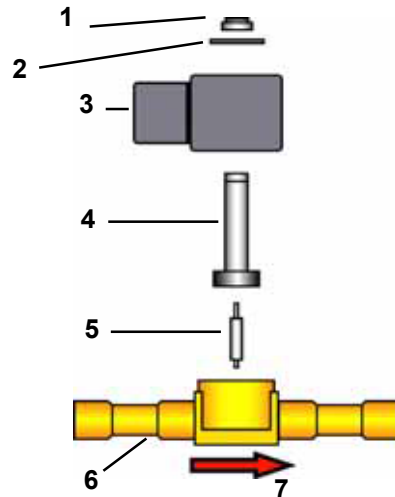
5.13 Hot Gas (HGS1) and Condenser Pressure Control Solenoid Valves

5.13.1 Replacing Solenoid Coil

It is not necessary to remove the refrigerant charge to replace the coil (see [Figure 5.7](#)).

- Remove coil snap cap, voltage plate and coil assembly. Disconnect leads and remove coil junction box if necessary.
- Verify coil type, voltage and frequency. This information appears on the coil voltage plate and the coil housing.
- Place new coil over enclosing tube and then install voltage plate and snap cap.

Figure 5.7 Hot Gas or Condenser Pressure Control Solenoid



- Snap cap
- Voltage plate
- Coil assembly
- Enclosing tube
- Plunger assembly
- Valve body assembly
- Direction of flow

5.13.2 Replacing Valve Internal Parts

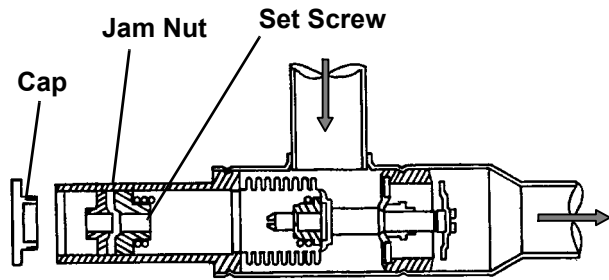
- Remove the refrigerant charge. (See [Section 5.4](#)).
- Remove coil snap cap, voltage cover and coil assembly. Remove the enclosing tube.
- Check for foreign material in valve body.
- Check for damaged plunger and o-ring. If o-ring is to be replaced, always put refrigerant oil on o-rings before installing.



Do not damage or over tighten the enclosing tube assembly. Place all parts in the enclosing tube in proper sequence in order to avoid premature coil burn-out.

- Tighten enclosing tube.
- Install coil assembly, voltage cover and snap cap.
- Evacuate, dehydrate and recharge unit. See [Section 5.6](#) and [Section 5.7](#).
- Start unit and check operation.

Figure 5.8 Compressor Pressure Regulating Valve



5.14 Adjusting the Compressor Pressure Regulating Valve (CPR) (115V Only)

When adjusting the compressor pressure regulating valve (CPR) (see [Figure 5.8](#)), the unit must be running in heating or defrost mode. This will ensure a suction pressure above the proper CPR setting. To adjust the CPR valve, proceed as follows:

- a. Install a gauge on the suction line.
- b. Remove cap from CPR valve.
- c. With an 8 mm Allen wrench, loosen the jam nut.
- d. Using the 8 mm Allen wrench, adjust the set screw. To raise the suction pressure, turn the set screw clockwise; to lower the suction pressure, turn counterclockwise. Refer to [Section 2.6.2](#) for CPR valve setting.
- e. When the setting has been adjusted, tighten the jam nut securely against the set screw. This will prevent any movement of the set screw due to vibrations in the unit. Replace the cap.

5.15 Thermostatic Expansion Valve

The thermal expansion valve is an automatic device which maintains constant superheat of the refrigerant gas leaving the evaporator regardless of suction pressure. The valve functions are: (a) automatic response of refrigerant flow to match the evaporator load and (b) prevention of liquid refrigerant entering the compressor. Unless the valve is defective, it seldom requires any maintenance.

NOTE

Due to the time involved in adjusting the superheat, replace the valve rather than adjusting it.

5.15.1 Replacing expansion valve

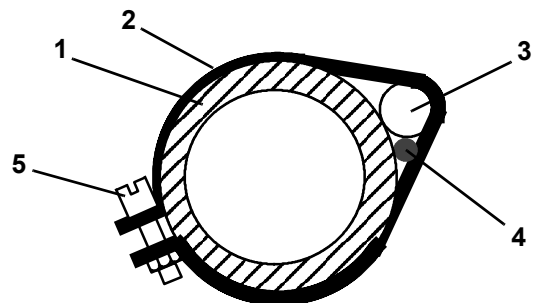
- a. Remove refrigerant charge (See [Section 5.4](#)).
- b. Remove insulation from expansion valve bulb and then remove bulb from suction line.
- c. Loosen flare nut and disconnect equalizer line from expansion valve.

- d. The txv bulb is located below the center of the suction line. This area must be clean to ensure positive bulb contact. Strap bulb to suction line and insulate both.
- e. Braze the equalizer tubes to expansion valve.
- f. Evacuate, dehydrate and recharge unit. (See [Section 5.6](#) and [Section 5.7](#)).
- g. Check superheat (See [Section 2.6.2](#)).

5.15.2 Measuring Superheat

- a. Remove insulation from expansion valve bulb and suction line. See [Figure 5.9](#)
- b. Loosen one TXV bulb clamp and make sure area under clamp (above TXV bulb) is clean.
- c. Place thermocouple above (parallel to) the TXV bulb and then secure loosened clamp making sure both bulbs are firmly secured to suction line as shown in [Figure 5.9](#).
- d. Connect an accurate gauge to the 1/4" port on the suction service valve.
- e. Run unit until stabilized at - 4°F (- 20°C) refrigerated compartment temperature.
- f. From the temperature/pressure chart ([Table 5-4](#)), determine the saturation temperature corresponding to the evaporator outlet pressure.
- g. Note the temperature of the suction gas at the expansion valve bulb.
- h. Subtract the saturation temperature determined in Step f. from the average temperature measured in Step g. The difference is the superheat of the suction gas. Refer to [Section 2.6.2](#) for superheat setting.
- i. If required, adjust superheat by turning the adjusting screw located under the cap on the side of the valve.

Figure 5.9 Thermostatic Expansion Valve Bulb and Thermocouple



1. Suction Line (end view)
2. TXV Bulb Clamp
3. TXV Bulb
4. Thermocouple
5. Nut and Bolt (Clamp)

5.16 Diagnostic Tool

NOTE

The Cab Command diagnostic tool comes with two jumpers. These are not applicable to the 30S system and should not be used in this application.

Figure 5.10 Cab Command Diagnostic Tool (CTD P/N 07-00440-00)



- Testing a cab command cable that is already installed on the unit and routed into the truck cab requires the use of both pieces of the diagnostic tool.
- Unplug the cab command cable from the microprocessor and also from the back of the cab command module.
- Plug one end of the cable into the primary tool and the other end into the remote tool.
- Begin the test by turning on the power switch and observing the sequence of green lights. As each circuit is tested, the corresponding light is illuminated. If a fault is found in the cable, the light that corresponds to that particular circuit is not illuminated.
- To test a cable that is not installed on a unit, simply plug each end of the cable into the primary tool and perform the test as above.

5.17 Microprocessor



Under no circumstances should anyone attempt to repair the microprocessor module or Cab Command! Should a problem develop with these components, contact your nearest Carrier Transicold dealer for replacement.

Although there is less danger of electrical static discharge (ESD) damage in the outdoor environment, where the processor is likely to be handled, proper board handling techniques should be stressed. Boards should always be handled by their edges, in much the

same way one would handle a photograph. This not only precludes the possibility of ESD damage, but also lowers the possibility of physical damage to the electronic components. Although the microprocessor boards are fairly rugged when assembled, they are more fragile when separated and should always be handled carefully.

When welding is required on the unit frame, or on the front area of the truck, ALL wiring to the microprocessor MUST be disconnected. When welding is performed on other areas of the truck and van, the welder ground connection MUST be in close proximity to the area being welded. It is also a good practice to remove both battery cables before welding on either the unit frame or the truck to prevent possible damage to other components such as the alternator and voltage regulator.

5.18 Evaporator Coil Cleaning

The use of recycled cardboard cartons is increasing. The recycled cardboard cartons create much more fiber dust during transport than "new" cartons. The fiber dust and particles are drawn into the evaporator where they lodge between the evaporator fins. If the coil is not cleaned on a regular basis, sometimes as often as after each trip, the accumulation can be great enough to restrict air flow, cause coil icing, repetitive defrosts and loss of unit capacity. Due to the "washing" action of normal defrost the fiber dust and particles may not be visible on the face of the coil but may accumulate deep within.

It is recommended to clean the evaporator coil on a regular basis, not only to remove cardboard dust, but to remove any grease oil film which sometimes coats the fins and prevents water from draining into the drain pan.

Cardboard fiber particles after being wetted and dried several times can be very hard to remove. Therefore, several washings may be necessary.

- Spray coil with a mild detergent solution such as any good commercial-grade automatic dish washer detergent and let the solution stand for a few minutes. Reverse flush (opposite normal air flow) with clean water at mild pressure. A garden hose with spray nozzle is usually sufficient. Make sure drain lines are clean.
- Run unit until defrost mode is initiated to check for proper draining from drain pan.

5.19 Condenser Coil Cleaning

Remove all foreign material from the condenser coil by reversing the normal air flow. (Air is pulled in through the front.) Compressed air or water may be used as a cleaning agent. It may be necessary to use warm water mixed with any good commercial dishwasher detergent. Rinse coil with fresh water if a detergent is used.

Table 5-4 R-134A Temperature-Pressure Chart

Temperature		Pressure	
°F	°C	Psig	Bar
-40	-40	14.5 (in Hg)	1.00 (in Hg)
-35	-37	12.3 (in Hg)	0.85 (in Hg)
-30	-34	9.7 (in Hg)	0.67 (in Hg)
-25	-32	6.9 (in Hg)	0.48 (in Hg)
-20	-29	3.6 (in Hg)	0.25 (in Hg)
-18	-28	2.3 (in Hg)	0.16 (in Hg)
-16	-27	0.8 (in Hg)	0.06 (in Hg)
-14	-26	0.03 (in Hg)	0.02 (in Hg)
-12	-24	1.1	0.08
-10	-23	1.9	0.13
-8	-22	2.8	0.19
-6	-21	3.6	0.25
-4	-20	4.5	0.31
-2	-19	5.5	0.38
0	-18	6.5	0.45
2	-17	7.5	0.52
4	-16	8.5	0.59
6	-14	9.6	0.66
8	-13	10.8	0.75
10	-12	12.0	0.83
12	-11	13.1	0.90
14	-10	14.4	1.00
16	-9	15.7	1.08
18	-8	17.1	1.18
20	-7	18.5	1.28
22	-6	19.9	1.37
24	-4	21.4	1.48
26	-3	22.9	1.58
28	-2	24.5	1.69
30	-1	26.1	1.80

Table 5-4 R-134A Temperature-Pressure Chart (Continued)

Temperature		Pressure	
°F	°C	Psig	Bar
32	0	27.8	1.92
34	1	29.5	2.04
36	2	31.3	2.16
38	3	33.2	2.29
40	4	35.1	2.42
42	6	37.0	2.55
44	7	39.1	2.70
46	8	41.1	2.84
48	9	43.3	2.99
50	10	45.5	3.14
55	13	51.2	3.53
60	16	57.5	3.97
65	18	64.1	4.42
70	21	71.2	4.91
75	24	78.7	5.43
80	27	86.8	5.99
85	29	95.4	6.58
90	32	104.4	7.20
95	35	114.1	7.87
100	38	124.3	8.58
105	41	135.1	9.32
110	43	146.5	10.11
115	46	158.6	10.94
120	49	171.3	11.82
125	52	184.8	12.74
130	54	198.9	13.72
135	57	213.8	14.74
140	60	229.4	15.83
145	63	245.8	16.95
150	66	263.0	18.15

SECTION 6

Troubleshooting



WARNING

Beware of unannounced starting of the unit. The unit may cycle the fans and operating compressor unexpectedly as control requirements dictate. Press OFF key on the cab command, turn vehicle engine off or disconnect power plug and open circuit breaker.



CAUTION

Under no circumstances should anyone attempt to service the microprocessor module and cab command. Should a problem develop with the control system, contact your nearest Carrier Transicold dealer for replacement components.

6.1 Introduction

Under normal circumstances, unit problems will be indicated by an active alarm in the alarm list. Suggested troubleshooting actions for each alarm indication are provided in [Table 6-1](#). Suggested corrective actions for mechanical type problems are listed under subject headings in [Table 6-2](#).

Table 6-1 Alarm Indications

Alarm	Description	Corrective Action	Reference Section
A00	No Malfunction	All components functioning normally	--
A01	Low Pressure Switch (LP) or High Pressure Switch (HP1) Open (Road)	Unit undercharged	5.7.1
		Liquid line filter drier restricted	5.10.1
		TXV strainer plugged with foreign material/ice.	5.15
		TXV malfunction	5.15
		Verify operation of evaporator fans.	--
		Failed switch	5.11.2
A02	Low Pressure Switch (LP) or High Pressure Switch (HP1) Open	Unit overcharged	5.7.1
		Verify operation of condenser fan	--
		Non-condensibles in system	5.8
		Discharge check valve failed closed (standby only)	Replace
		Failed switch	5.11.2
A03 Standby Units Only	Electric motor overload	Thermal overload open in motor windings.	
		Current overload tripped.	
		Verify line voltage	
A04	Road Compressor Clutch (CLHR) Malfunction	Current draw of road clutch coil either high or low	Replace
A05 Standby Units Only	Standby Contactor (MC) high amp draw	Contactors coil either high or low (0.2A for 3 phase; 0.5A for 1 phase)	--
		Verify plunger moves freely	--
		Replace contactor	--

Table 6–1 Alarm Indications (Continued)

A06	Condenser Fan Motor (CFM) high amp draw	Verify motor rotates freely	--
		Verify condition of brushes	5.12
		Replace motor	--
A07	Evaporator Fan Motor (EFM) high amp draw	Verify motor rotates freely.	--
		Replace motor	--
A08 Standby Units Only	Heating option control - Either the hot water control relay or the electric heat contactor coil amp draw is high	Verify coil resistance	--
		Check wiring to controls	--
A09	Hot Gas Solenoid Valve (HGS1) high amp draw	Current draw of coil high or low (approx 1.6 amp)	--
		Replace coil	5.13.1
A10	Quench Valve (BPV) high amp draw	Current draw of coil high or low (approx 1.2 amp)	--
		Replace coil	5.13.1
A11	Condenser Pressure Control Valve (HGS2) high amp draw	Current draw of coil high or low (approx 1.6 amp)	--
		Replace coil	5.13.1
A12 Standby Units Only	Out of Range - High Temperature	Unit out of range for 15 minutes	--
		Verify cooling operation of unit	5.13.1
		Hot gas solenoid open	Verify setting
A13 Standby Units Only	Out of Range - Low Temperature	Unit out of range for more than 15 minutes	--
		Verify heating operation of unit	3.9
		Heating option not active (Set configuration)	--
A14 Standby Units Only	Defrost Cycle > 45 minutes	Unit terminated defrost after 45 minutes	--
		Verify HGS1/HGS2 valve operation	5.13
A15	Set point adjusted out of the range -20.2 to 86°F (-29°C/ +30°C) or below the programmed low threshold	Check set point	3.3
EE	Return Air Sensor	Return air sensor defective	Replace
bAt	Low Battery Voltage	Vehicle battery voltage low	Correct
		Check alternator system	--
---	Using Road and Standby operation at the same time	If operating on road, disconnect standby power supply	--
		If operating on standby, shut down vehicle engine.	--
Err	Set point error	Programming error. Reset.	3.3

Table 6–2 Mechanical Indications

Indication/Trouble	Possible Causes	Reference Section
6.2 Refrigeration		
6.2.1 Unit Will Not Cool		
Compressor malfunction	Compressor drive (clutch) defective	Replace
	Compressor defective	5.9
Refrigeration system	Defrost cycle has not terminated	6.2.5
	Abnormal pressure	6.2.6
	Hot gas solenoid malfunction (HGS1)	5.13
6.2.2 Unit Runs but has Insufficient Cooling		
Compressor	Compressor defective	5.9
Refrigeration System	Abnormal pressure	6.2.6
	Expansion valve malfunction	6.2.10
	Non-existent or restricted evaporator airflow	6.2.9
6.2.3 Unit Operates Long or Continuously in Cooling		
Refrigerated compartment	Hot Load	Insufficient pull down time
	Defective refrigerated compartment insulation or air leak	Correct
Refrigeration system	Abnormal pressure	6.2.6
	Temperature microprocessor malfunction	6.2.8
Compressor	Defective	5.9
6.2.4 Unit Will Not Heat or Heating Insufficient		
Refrigeration	Abnormal pressure	6.2.6
	Temperature microprocessor malfunction	6.2.8
	Hot gas solenoid malfunction (HGS1)	5.13
Compressor	Compressor drive (clutch) defective	Check
	Compressor defective	5.9
6.2.5 Defrost Malfunction		
Automatic defrost will not initiate	Defrost thermostat (DTT) open or defective	Replace
	Hot gas solenoid valve malfunction	5.13
	Defrost disabled through cab command	3.5
Manual defrost will not initiate	Microprocessor defective	Replace
	Defrost thermostat (DTT) open or defective	Replace
Defrost cycle initiates but does not defrost	Hot gas solenoid malfunction (HGS1)	5.13
	Condenser Pressure Control valve malfunction (HGS2)	5.13
Frequent defrost	Wet load	--
	Defrost settings too low	3.5
Does not terminate or cycles on defrost	Defrost thermostats (DTT) shorted closed	Replace

Table 6–2 Mechanical Indications (Continued)

Indication/Trouble	Possible Causes	Reference Section
6.2.6 Abnormal Pressure - Cooling		
High discharge pressure	Condenser coil dirty	5.19
	Non-condensibles in system	5.8
	Refrigerant overcharge	5.7.1
	Condenser fan/motor defective	5.12
Low discharge pressure	Compressor defective	5.9
	Hot gas solenoid malfunction	5.13
	Low refrigerant charge	5.7.1
High suction pressure	Compressor defective	5.9
	Hot gas solenoid malfunction	5.13
	Compressor pressure regulator mis-adjusted (CPR)	5.14
Low suction pressure	Filter–drier partially plugged	5.10
	Low refrigerant charge	5.7.1
	Expansion valve malfunction	6.2.10
	No evaporator air flow or restricted air flow	6.2.9
	Excessive frost on coil	Check
Suction and discharge pressures tend to equalize when unit is operating	Compressor defective	5.9
	Hot gas solenoid malfunction	5.13
6.2.7 Abnormal Pressure - Heating		
High discharge pressure	Overcharged system	5.7.1
	Condenser fan or HP2 pressure switch defective	5.11
	Non-condensibles in system	5.8
	Condenser motor/fan defective	5.12
Low discharge pressure	Compressor defective	5.9
	Hot gas solenoid valve malfunction	5.13
Low suction pressure	Low refrigerant charge	5.7.1
	Compressor pressure regulating valve mis-adjusted (CPR)	5.14
	Condenser Pressure Regulating valve fault (HGS2)	5.13
6.2.8 Abnormal Noise		
Compressor	Loose mounting bolts	Tighten
	Worn bearings	5.9
	Worn or broken valves	5.9
	Liquid slugging	6.2.10
	Insufficient oil	Check
Condenser or evaporator fan	Loose shroud	Check
	Bearings defective	Check
	Fan loose on shaft	Check
	Bent shaft	

Table 6–2 Mechanical Indications (Continued)

Indication/Trouble	Possible Causes	Reference Section
6.2.9 Cab Command Malfunction		
Cab Command non-operational	Fuse open	Replace
	Microprocessor malfunction	Replace
	Microprocessor/Cab command cable	Check
6.2.10 No Evaporator Air Flow or Restricted Air Flow		
Evaporator coil blocked	Heavy frost on coil	Check
	Coil dirty	5.18
No or partial evaporator air flow	Evaporator fan loose or defective	Check
	Evaporator fan rotating backwards	Check
	Evaporator air flow blocked in refrigerated compartment	Check
	Fan motor(s) malfunction	Replace
6.2.11 Expansion Valve		
Low suction pressure with high superheat	Low refrigerant charge	5.7.1
	External equalizer line plugged	Repair
	Broken capillary	Repair
	Superheat setting too high	5.15.2
Low superheat and liquids lugging in compressor	Superheat setting too low	5.15.2
	External equalizer line plugged	Repair
	Pin and seat of expansion valve eroded or held open by foreign material	5.15
Fluctuating suction pressure	Improper bulb location or installation	5.15
	Insulation missing from sensing bulb	Replace
	Low superheat setting	5.15.2
High superheat	Expansion Valve setting	5.15.2
6.2.12 Malfunction Hot Gas Solenoid or Condenser Pressure Regulating Valve		
Valve does not function properly	No power to valve	Check
	Improper wiring or loose connections	Check
	Valve improperly assembled	5.13
	Coil or coil sleeve improperly assembled	
	Movement of plunger restricted due to: a. Corroded or worn parts b. Foreign material lodged in valve c. Bent or dented enclosing tube	
Valve shifts but refrigerant continues to flow	Foreign material lodged under seat	5.13
	Defective seat	
6.2.13 Standby Compressor Malfunction		
Standby compressor fails to start	Motor contactor defective	Replace
	Motor Overload open	Check
	Improper power supply	Correct
	5-minute timer active	Check
Standby motor starts, then stops	Motor Overload open	Check

SECTION 7

Electrical Schematic Wiring Diagram

7.1 Introduction

This section contains electrical schematic wiring diagrams covering the models listed in Table 1-1. The following general safety notices supplement the specific warnings and cautions appearing elsewhere in this manual. They are recommended precautions that must be understood and applied during operation and maintenance of the equipment covered herein.

WARNING

Beware of unannounced starting of the unit. The unit may cycle the fans and operating compressor unexpectedly as control requirements dictate. Press OFF key on the cab command and disconnect power plug.

WARNING

Under no circumstances should ether or any other starting aids be used to start engine.

WARNING

Under no circumstances should anyone attempt to repair the microprocessor module or Cab Command! Should a problem develop with these components, contact your nearest Carrier Transicold dealer for replacement.

CAUTION

proper polarity when installing battery, negative battery terminal must be grounded.

CAUTION

Under no circumstances should a technician electrically probe the processor at any point, other than the connector terminals where the harness attaches. Microprocessor components operate at different voltage levels and at extremely low current levels. Improper use of voltmeters, jumper wires, continuity testers, etc. could permanently damage the processor.

CAUTION








Most electronic components are susceptible to damage caused by electrical static discharge (ESD). In certain cases, the human body can have enough static electricity to cause resultant damage to the components by touch. This is especially true of the integrated circuits found on the microprocessor. Use proper board handling techniques. (See Section 4.17).








7.2 Wiring Schematic

Refer to [Electrical Wiring Diagrams](#) on the following pages

NOTES :

1. UNIT SHOWN "OFF" POSITION.
2. WIRE IDENTIFICATION SYSTEM:
 COLOR: WHITE - DC CONTROL CIRCUITS
 GREEN - DC GROUNDS CIRCUITS
 RED - POSITIVE BATTERY CIRCUITS
 BLACK - NEGATIVE BATTERY CIRCUITS
3. ADDRESS SYSTEM: EXAMPLE: CN2-8/CFM-A
 INDICATES A WIRE BETWEEN CONNECTOR CN2
 (PIN 8) AND PLUG CFM (PIN A).

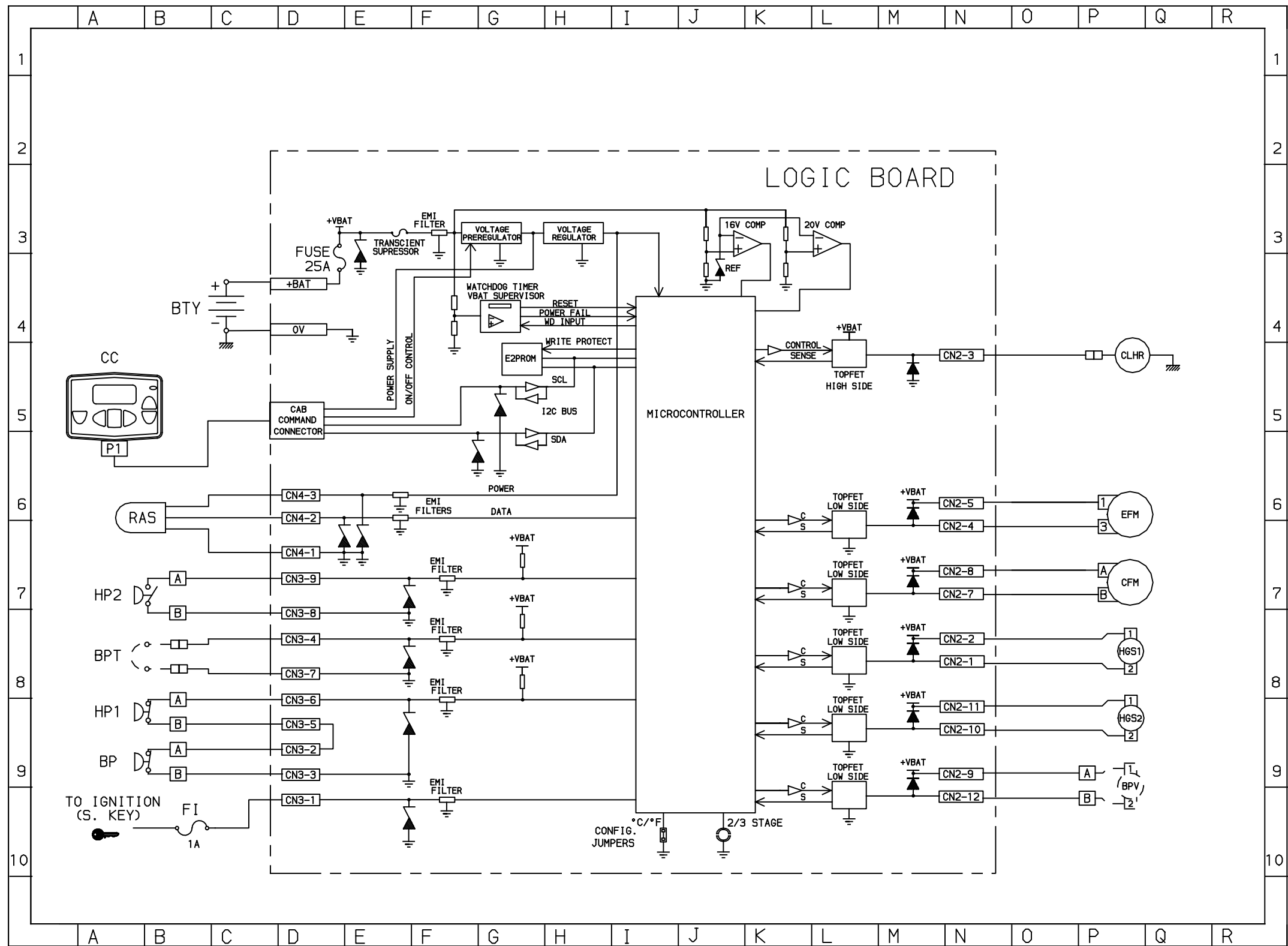
-  INDICATES A SOLDERED SPLICE POINT.
-  PIN CONNECTION.
-  LIGHT LINES INDICATES WIRES IN THE SYSTEM.
-  NORMALLY CLOSED CONTACTS.
-  NORMALLY OPEN CONTACTS.
-  MULTIPLE PLUG CONNECTION NUMBER.
-  JUNCTION BLOCK CONNECTION

-  SWITCH SYMBOL INDICATES MOMENTARY CONTACTS.
-  INDICATES A WIRE GROUND.
-  INDICATES A CHASSIS GROUND (NO WIRE).
-  INDICATES STANDARD OPTIONS.
-  INDICATES A CONNECTION, WIRE, LUG, ETC.
-  INSULATING PLUG
-  COMPONENT CONNECTION NUMBER OR LETTER.

ROAD ONLY

LOCATION	SYMBOL	DESCRIPTION	LOCATION IN UNIT
B-9	LP	LOW PRESSURE SWITCH	EVAPORATOR
B-8	BPT	QUENCH THERMOSTAT	ROAD COMPRESSOR
P-9	BPV	QUENCH VALVE	EVAPORATOR
A-5	CC	CAB COMMAND	CAB
P-7	CFM	CONDENSER FAN MOTOR	CONDENSER
P-4	CLHR	ROAD CLUTCH	ENGINE COMPARTMENT
P-6	EFM	EVAPORATOR FAN MOTOR	EVAPORATOR
B-10	FI	IGNITION FUSE	ENGINE COMPARTMENT
D-3	FUSE	25A FUSE	LOGIC BOARD
B-9	HP1	HIGH PRESSURE SWITCH	CONDENSER
B-7	HP2	CONDENSER PRESSURE SWITCH	CONDENSER
P-8	HGS1	HOT GAS SOLENOID VALVE	CONDENSER
P-9	HGS2	CONDENSER PRESSURE CONTROL VALVE	CONDENSER
B-7	RAS	RETURN AIR SENSOR	EVAPORATOR

Figure 7-1 Electrical Schematic Wiring Diagram - Based On Dwg. No. 62-61350 Rev D



ROAD ONLY

Figure 7-2 Electrical Schematic Wiring Diagram - Based On Dwg. No. 62-61350 Rev E

INDEX

A

- Accessing Alarm Messages 4
- Adjusting the Compressor Pressure Regulating Valve (CPR) 9
- Alarm Display 4

B

- Belt Maintenance and Adjustment 3
- BPV 4

C

- Cab Command 1
- Charging the Refrigeration System 6
- Checking and Replacing Condenser Fan Motor Brushes 8
- Checking and Replacing filter drier 7
- Checking for Non-Condensables 6
- Checking the EEPROM Version 5
- Clearing Alarm Messages 5
- Compressor 3
- Compressor Data 8
- Compressor Pressure Regulating Valve (CPR) 4
- Condenser Coil Cleaning 10
- Condenser Pressure Control Solenoid Valves 8
- Condenser Pressure Control Switch (HP2) 4
- Condenser Pressure Control Valve (HGS2) 3
- Condenser Pressure Switch (HP2) 7
- Condenser/Subcooler 1
- Condensing Section 1
- Connecting Manifold Gauge/Hose Set 3
- Control System 1
- Cooling 11
- CPR 4

D

- Defrost Cycle 2
- Defrost Cycle Adjustment 4
- Defrost Termination Thermostat (DTT) 4
- Diagnostic Tool 10
- DTT 4

E

- Electrical Data 9
- Evacuation and Dehydration 5
 - Preparation 5
- Evaporator 4
- Evaporator Coil Cleaning 10
- Evaporator Section 4

F

- Filter Drier 1
- First Aid 1
- Frozen Mode 1

G

- General Description 1

H

- HGS1 3
- HGS2 3
- High Pressure Switch (HP1) 4, 7
- Hot Gas Solenoid Valve (HGS1) 3, 8
- HP1 4
- HP2 4

I

- Installing R-134A Manifold Gauge Set 3
- Introduction 1

L

- Low Battery Voltage Alarm for Road Only Units 5
- Low Pressure Switch (LP) 4
- LP 4

M

- Maintenance Precautions 1
- Maintenance Schedule 1
- Manual Defrost 4
- Measuring Superheat 9
- Microprocessor 10
- Microprocessor Configuration 6
- Microprocessor Module 1
- Minimum Off Time 2

O

- Oil Separator 3
- Operating Precautions 1

P

- Perishable Mode 1
- Preparing Manifold Gauge/Hose Set For Use 3
- Procedure for Evacuating and Dehydrating System 5

Q

- Quench Valve (BPV) 4

R

Receiver	3
Refrigerant Circuit	11
Refrigerant Leak Checking	4
Refrigerant Removal From a Non-Working Compressor	4
Refrigerants	1
Refrigeration System Data	8
Removing the Manifold Gauge Set	4
Removing the Refrigerant Charge	4
Replacing the Compressor	6
Road Only Functional Settings	6
Road/Standby Functional Settings	7

S

Safety	
First Aid	1
Maintenance Precautions	1
Operating Precautions	1
Refrigerants	1

Safety Precautions	1
Safety Devices	10
Safety Precautions	1
Sequence of Operation	1
Set Point Adjustment	3
Specific Warning and Caution Statements	2
Standby Motor	3
Standby Motor-Compressor V-Belt	3
Start-Up	3
Stopping the Unit	5
System Components	7
System Operating Controls	7

T

Thermostatic Expansion Valve	4, 9
Torque Values	9

U

Unit Specifications	8
---------------------	---

CALIFORNIA
Proposition 65 Warning

Diesel engine exhaust and some of its constituents are known to the State of California to cause cancer, birth defects, and other reproductive harm.

North America

Carrier Transicold
700 Olympic Drive
Athens, GA 30601 USA
Tel: 1-706-357-7223
Fax: 1-706-355-5435

Central America and Mexico

Ejercito Nacional 253-A Piso 5
Colonia Anahuac
11320 Mexico, D.F.
Tel: 55315010
Fax: 55315010 ext. 1005



Carrier Transicold
P.O. Box 4805
Syracuse, NY 13221 USA