



KILOTECH
www.kilotech.com

Energizer

Beghelli

BIOS
Diagnostics

REED

MATRIX
INDUSTRIAL PRODUCTS



ELECTRICAL PRODUCTS & INSTRUMENTS



HVAC	1466 - 1476
Lamps	1477 - 1482
Electrical Devices, Tapes & Accessories	1483 - 1485
Emergency Lights	1486 - 1487
Flashlights & Batteries.....	1488 - 1500
Task Lights & Magnifier	1501 - 1502
Work Lights & Cord Reels	1503 - 1510
Extension Cords, Outlets & Batteries	1511 - 1520
Multimeters & Voltage Tester	1521 - 1524
Equipment Cases	1525
Amperage, Capacitance, Phase & Earth Ground Testers ..	1526 - 1528
Infrared Thermometers	1529 - 1530
Thermometers.....	1531 - 1533
Temperature/Humidity Meters, Loggers & Recorders ...	1534 - 1536
Moisture Meters	1537
Thickness, Coating & Hardness Meters.....	1538 - 1539
Sound & Light Meters.....	1540 - 1541
Speed, Distance & Length Measurers	1542 - 1543
Vibration & Force Gauges	1544
Inspection Cameras.....	1545
Air Velocity Meters	1546 - 1547
Manometers & Pressure Gauges.....	1548 - 1551
Flowmeters, Switches, Refractometers & pH Meters.....	1552 - 1554
Scales.....	1555 - 1561



LIGHT INDUSTRIAL-DUTY AIR CIRCULATING FANS

- All-metal construction
- 6' SJT power cord
- Stem length for pedestal: 89-124 cm



Model No.	Description	HP	Voltage	CFM Max.	CFM Min.	No. of Speeds	Price /Each
OSCILLATING							
EA282*	26" Pedestal	1/4	120	7525	4050	2	
EA283*	30" Pedestal	1/3	120	8778	6780	2	
EA284	26" Wall Mount	1/4	120	7525	4050	2	
EA654	30" Wall Mount	1/3	120	8775	6780	2	
NON-OSCILLATING							
EA657*	26" Pedestal	1/4	120	7700	6060	2	
EA571*	30" Pedestal	1/3	120	8000	7000	2	
EA655	26" Wall Mount	1/4	120	7700	6060	2	
EA656	30" Wall Mount	1/3	120	8000	7000	2	

*Features adjustable height and a heavy-duty round base for added stability

HEAVY-DUTY INDUSTRIAL AIR CIRCULATING FANS

- 115 V, 1/3 HP, 1 phase, 3 speed, totally enclosed air over ball bearing motor
- Patented modular motor end dome for easy maintenance
- Oscillating and non-oscillating
- Energy efficient - lowest watts per CFM
- Ultra quiet die cast aluminium airfoil propeller
- Wall and I-beam mounts able to be installed by one individual
- Includes: Cord and plug
- Meets OSHA standards



5-YEAR WARRANTY



Model No.	Description	F.L. Amps	High	CFM Med	CFM Low	RPM High	RPM Med	RPM Low	Wt. lbs.	Price /Each
OSCILLATING										
EA353	24" Pedestal	2.5	5387	4356	3125	1070	850	628	89	
EA355	30" Pedestal	2.6	7996	5859	4063	1045	789	561	95	
EA354	24" Wall Mount	2.5	5387	4356	3125	1070	850	628	60	
EA356	30" Wall Mount	2.6	7996	5859	4063	1045	789	561	64	
NON-OSCILLATING										
EA349	24" Pedestal	2.5	5588	4556	3325	1110	900	700	85	
EA351	30" Pedestal	2.8	8402	6259	4463	1098	880	660	87	
EA350	24" Wall Mount	2.5	5588	4556	3325	1110	900	700	56	
EA352	30" Wall Mount	2.8	8402	6259	4463	1098	880	660	60	

Note: Performance Ratings are conducted in accordance with AMCA Standard 230-99

INDUSTRIAL-DUTY AIR CIRCULATING FANS

- All-metal construction
- 9.8' SJT power cord
- Stem length for pedestal: 89-124 cm



Model No.	Description	HP	Voltage	CFM Max.	CFM Min.	No. of Speeds	Price /Each
OSCILLATING							
EA645	24" Wall Mount	1/3	120	11 500	7680	2	
EA649	30" Wall Mount	1/4	120	10 780	7760	2	
EA643*	24" Pedestal	1/4	120	11 800	7760	2	
EA647*	30" Pedestal	1/3	120	13 200	6700	2	
NON-OSCILLATING							
EA644	24" Wall Mount	1/4	120	11 500	7680	2	
EA648	30" Wall Mount	1/4	120	10 780	7440	2	
EA642*	24" Pedestal	1/4	120	11 800	7760	2	
EA646*	30" Pedestal	1/4	120	10 780	7440	2	

*Features adjustable height and a heavy-duty round base for added stability

HEAVY-DUTY OSCILLATING FANS

PEDESTAL

- All-metal construction, chrome grill and base painted black
- Can be used in oscillating or non-oscillating mode
- Adjustable height and heavy-duty round base for added stability
- 9.8' SJT power cord
- Base Dia. Cm: 69.3

WALL MOUNTED

- All-metal construction
- Fully enclosed motor



Model No.	Description	HP	No of Speeds	CFM Max.	Price /Each
EA666	30" Pedestal	1/3	3	13 200	
EA667	30" Wall Mount	1/3	3	13 400	

24" ROLL-ABOUT AIR FANS

- 120V, 1/5 HP, 3 speed motor
- 9.8' SJT power cord
- Cart mounted fan for increased air circulation and optimal mobility
- Can be tilted/ positioned to maximise ventilation
- Cart and frame configuration provide stable quiet operation
- CFM: 10760 (high), 7770 (medium), 7040 (low)

Model No. EA476
Price/Each \$



6" CLIP-ON & DESK FANS

- 2-speed, low and high settings
- Tilting head
- Fully assembled and ready for use
- Convertible clip and desk feature
- Weight: 2.21 lbs.

Model No. EA304
Price/Each \$



OSCILLATING DESK FANS WITH PUSH BUTTONS

- 3-speed push buttons controls
- Rotating or fixed air direction
- Portable and easy to assemble
- Topples resistant base



Model No.	Dia."	Wt. lbs.	Price /Each
EA305	12	5.5	
EA306	16	6.83	



16" WALL MOUNT OSCILLATING FANS

- Remote with timer mode included
- 3 speed with Eco mode feature
- Rotating or fixed air direction
- Easy to assemble
- Weight: 8.82 lbs.

Model No. EA526
Price/Each \$



20" BOX FANS

- 3-speed control
- Five slim blades
- Fully assembled and ready to use
- This fan is designed to efficiently circulate airflow to reach desired comfort levels with a three speed-settings feature.
- Top-mounted controls
- Material: Plastic
- Weight: 9.92 lbs.

Model No. EA527
Price/Each \$



OSCILLATING PEDESTAL FANS

- 3-speed push button front control
- Adjustable height
- Rotating or fixed air direction
- Easy to assemble



Model No.	Dia."	Wt. lbs.	Price /Each
EA658	16	7.5	
EA551	18	10	

HIGH VELOCITY FLOOR FANS

- 120 V/60 Hz, 1/4 HP, 3-speed motor
- All metal construction, chrome grill and base



Model No.	Diameter"	High	CFM Med	Low	Wt. lbs.	Price /Each
EA528	16	2370	1950	1560	10	
EA290	18	4725	3850	2975	16	



20" HIGH VELOCITY PEDESTAL FANS

- 120 V/60 Hz, 1/5 HP, 3-speed motor
- All-metal construction, chrome grill, black painted base
- Adjustable pedestal base
- 6' SJT power cord
- CFM: 5950 high, 4550 medium, 3850 low
- Overall height: 134-157.5 cm
- Base dia.: 48.5 cm
- Stem length: 63-86.5 cm
- Weight: 36 lbs.

Model No. EA289
Price/Each \$



OSCILLATING PEDESTAL FANS

- Pedestal models feature adjustable height and heavy-duty round base for added stability
- 9.5' power cord with UL GFCI plug
- Enclosed/Waterproof motor type
- All-metal construction, chrome grill stand and base painted black
- HP: 1/7
- Base Diameter: 27"
- CFM High: 7200
- CFM Low: 3780
- CFM Mid: 5470
- Weight: 47 lbs.
- Watts: 220 W
- Diameter: 30"
- No. of Speeds: 3

Model No. EA779
Price/Each \$



STAINLESS STEEL FOOD SERVICE WASHDOWN AIR CIRCULATING FANS

- Designed to withstand moist/wet environments, high pressure cleaning with concentrated caustic solutions without affecting performance or function
- Constructed with electro-polished 304 stainless steel
- All stainless steel motor
- Non-oscillating, 1 phase, totally enclosed non-vented ball bearing
- BISSC approved motor
- Motor washdown specification is IEC-IP55
- Available in non-adjustable pedestal or wall mount
- Safety cable kit is included in all overhead mounted air circulators
- Meets the USDA and the NSF for food zones
- 10-year warranty

Model No.	Description	Voltage	HP	CFM	RPM	Wt. lbs.	Price /Each
EA339	20" Pedestal	115 V	1/15	2670	1600	69	
EA341	24" Pedestal	115/230 V	1/4	5220	1075	79	
EA343	30" Pedestal	115/230 V	1/3	8800	1075	81	
EA340	20" Wall mount	115 V	1/15	2670	1600	52	
EA342	24" Wall mount	115/230 V	1/4	5220	1075	62	
EA344	30" Wall mount	115/230 V	1/3	8800	1075	64	



 **Airmaster® Fan Company**

CHEMICAL RESISTANCE RATING CHART

Chemical	Concentration	Stainless Steel Part
WATER		
De-ionized boiling	100%	Excellent
Salt (immersed)	30%	Excellent
Salt (spray)	5%	Excellent
Tap - 250 °F/120 °C @ 10 000 psi	100%	Excellent
ACIDS		
Hydrochloric	35%	Poor
Sulfuric	25%	Poor
Nitric	35%	Excellent
Picric	Saturated solution	Excellent
BASE		
Caustic	100%	Excellent
Caustic	12 pH	Excellent
Caustic - 125°F/50°C	9.5 pH	Excellent
SOLVENTS		
	-	Excellent

Notes: Performance ratings are conducted in accordance with AMCA Standard 230-99. When assembling fans, use only the stainless steel fasteners supplied with the motors. Fans and motors should be cleaned and inspected regularly. Cord and plug not provided. Must be hard wired. Wiring must conform to all national, provincial and local codes.

CEILING FANS

- A major source of untapped energy is available at the ceiling in most industrial and commercial buildings
- Air stratification causes heat build-up at the ceiling as much as 25 °F or more above floor level temperatures
- By installing ceiling fans, this warm air can be recirculated down to floor level to maintain a uniform air temperature from floor to ceiling
- The result saving can be as much as 30 %
- Electro-static white paint

- When ceiling fans are used for cooling people during the summer, they should be spaced 15' to 20' apart in the occupied area
- In warehouse storage areas, best results will be obtained if fans are mounted over aisle ways
- Fans should not be mounted less than 10' above the floor, the use of a safety cable is required on all ceiling fans



MARK I

- 1-year commercial warranty

JETPROOF

- Moisture and dust resistant
- Preassembled with watertight power cord and safety cable
- 2-year commercial warranty

MARK VI

- 2-year commercial warranty

 **Airmaster® Fan Company**

Model No.	Blade Size"	Fan Style	Down Length"	CFM	RPM	Voltage	Amps	Watts Full Speed	Wt. lbs.	Price /Each
EA357	56	Mark I	30/15	26 400	290	120	0.52	62	15	
EA358	56	Mark VI	32/14	32 900	311	120	1.12	120	17	
EA362	56	Jetproof (JP-CP)	24	32 900	311	115	1.12	120	16	

Note: Safety cable included. Cord and plug not provided, must be hard wired, wiring must conform to all national, state and local code (except EA362).

ACCESSORIES

Model No.	Description	Wt. lbs.	Price /Each
CONTROLS FOR CEILING FANS			
EA363	Variable speed control regulates 1 to 6 fans. Not to exceed a maximum amp draw of 6 amps	1	
EA364	Variable speed control regulates 7 to 12 fans. Not to exceed a maximum amp draw of 10 amps	1	
EA365	Variable speed control, 277 V, regulates 1 to 3 fans. 1.5 Amps	1	
GUARD KIT FOR 56" FANS			
EA366	61" dia. nickel chrome plated top and bottom protective guard kit	21	

THERMOSTAT PROTECTORS

- Molded of 1/8" thick, heavy-duty polycarbonate
- Offer excellent protection against tampering, abuse and accidental damage without affecting operation of thermostat or sensor
- Holes in the frame allow air to circulate freely
- Inner wall prevents tampering with dials and levers
- All thermostat covers have a key lock assembly
- Easy and quick installation
- Available for flush and surface mount applications (with use of spacer)
- Spacer adds 2" in depth and can mount around existing conduit
- Thick polycarbonate cover is backed by a lifetime guarantee against damage in normal use
- Polycarbonate rated -40°F (-40°C) to 120°F (49°C)

Model No.	Mfg. No.	Description	Colour	Size W" x D" x H"	Price /Each
SAN648	STI-9110	Thermostat Protector, Large	Clear	8.5 x 3.62 x 5.37	
SAN649	STI-9105	Thermostat Protector, Small	Clear	5.5 x 3 x 4.62	
SAN650	STI-9105-S	Thermostat Protector, Small	Smoke	5.5 x 3 x 4.62	
SAN651	SUB-901	Spacer for SAN649 and SAN650	Clear	5.5 x 2 x 5	



 **Safety Technology International, Inc.**



18" CART MOUNTED FANS

- 115 V, 1/8 HP, 1 phase, 3-speed, open drip proof, ball bearing motor
- Adjusts on 360°
- Nickel chrome guards meet OSHA regulations
- Four-position easy reach switch with 10' three-conductor cord and plug
- Aluminum propellers
- 4" casters
- CFM: 2966 high, 2437 medium, 2013 low
- RPM: 1600 high, 1350 medium, 1180 low
- Weight: 23 lbs.
- 1-year warranty

Model No. EA335
Price/Each \$



DEHUMIDIFIERS

- Provides efficient dehumidification power for healthier air quality and a drier, more comfortable environment
- Energy efficient
- Digital controls allows you to set desired humidity level, fan speed and 24 hour timer
- Restarts after a power outage at previous setting
- Easy guide castor and built-in handle makes unit easy to move from room to room



EA765



Model No.	Capacity Pt.	Coverage sq.ft.	Price /Each
EA765	30	1550	
EA766	70	4500	
EA767*	70	4500	

*Automatically pumps water up to 10 vertical feet

MOBILE 3 IN 1 AIR CONDITIONERS

- 3-in-1 Air comfort system (Air, Fan and dehumidify)
- Use with remote control or control panel
- Less than 65 dB sound
- Rolling caster wheels for easy portability
- 24 hour timer and 2 fan speeds
- Window kit included



EA763

Model No.	Pints /Day	Coverage sq.ft.	Dimensions				BTU Rating	Price /Each
			W"	x	D"	x	H"	
EA763	40	350	13	x	11	x	26 3/4	8000
EA764	72	550	13 3/5	x	12 3/5	x	31 1/4	12 000

DEHUMIDIFIERS

- Water bucket full indicator
- Portable unit on casters allows for easy movement of the unit
- Electronic controls with LED display
- Timer feature
- Clean filter reminder with LED indicator
- External drain connector
- Automatic defrost



Model No.	Capacity Pints	Coverage sq.ft.	Dimensions				Wt. lbs.	Price /Each
			W"	x	D"	x	H"	
EA568	45	2500	20 7/8	x	16	x	13	35.3
EA570	70	4000	25 3/4	x	17 1/3	x	13 2/3	54

99.97% HEPA AIR PURIFIERS

- Effectively removes up to 99.97% of airborne particulate pollutants as small as 0.3 microns such as dust, pollen, smoke, mould spores and pet dander from air passing through the filter
- Digital control
- Space saving design can be placed upright or on side
- Carbon filter enhanced with baking soda to absorb and eliminate odours
- Filter service check - reminds you when it's time to clean the filter
- Timer
- CADR smoke 168, dust 174 and pollen 140



EA554



Model No.	Recommended Room Size sq.ft.	Price /Each
EA554	256	

REPLACEMENT FILTERS

Model No.	Type	Price/Each
EA787	HEPA filter	
BB226	Carbon filter	

SUNBEAM® WHOLE HOUSE COOL MIST HUMIDIFIER

- Up to 24-hour run time per tank filling with auto shut-off
- Shatterproof Tank
- 3-speed settings
- Removable, flat tank for easy filling and cleaning
- Antimicrobial Product Protection is infused into the plastic to help prevent the growth of bacteria that can cause stains and odors or adversely affect performance
- Easy to fill tank with side fill option for easy filling in sinks
- Type: Cool Mist
- Tank Capacity: 2.44 Gal
- Coverage: 2000 sq. ft.

Model No. EA668
Price/Each \$



ELECTRONIC WINDOW HORIZONTAL AIR CONDITIONERS

- 3-Speed Fan
- 4 way directional louvers
- Auto Restart
- Digital Display and Remote Control
- 24-H Timer
- Energy Saver mode
- Filter cleaning indicator
- Washable filter
- Compressor start-stop protection



Model No.	BTU Rating	Dimensions				Wt. lbs.	Price /Each
		W"	x	D"	x	H"	
EA761	8000	19	x	19	x	14	57

24" DIRECT DRIVE DRUM FAN

- Made from durable corrosion resistant galvanized steel housing which is built to last
- Tilting floor stand to move air where needed
- 3 prong heavy duty 10ft power cord
- Diameter: 24"
- No. of Speeds: 2
- HP: 1/5

Model No. EA758
Price/Each \$



shop-air
A Shop-Vac® Company

GALVANIZED STEEL BELT DRIVE DRUM FAN

- Made from durable corrosion resistant galvanized steel housings which are built to last
- Non-skid front legs keep fan in place while in operation
- Metal handles for portability
- 3-prong heavy duty power cord
- Size: 36"
- No. of Speeds: 2
- HP: 0.5

Model No. EA672
Price/Each \$



shop-air
A Shop-Vac® Company

STAINLESS STEEL DIRECT DRIVE DRUM FAN

- Durable stainless steel housing built to last a long time
- Non-skid front legs to keep your fan in position while operating
- Metal handle for portability
- No. of Speeds: 2

shop-air
A Shop-Vac® Company

Model No.	Dia. "	HP	Price /Each
EA759	24	1/3	
EA760	36	1/2	



HEAVY-DUTY FIXED BELT DRIVE DRUM FAN

- Fully enclosed motor
- All-metal construction
- 12' power cord
- Size: 42"
- No. of Speeds: 2
- HP: 3/4
- Max. CFM: 20945

Model No. EA662
Price/Each \$

MATRIX
INDUSTRIAL PRODUCTS



HIGH VELOCITY FLOOR FAN

- All-metal construction
- Vertical pivot fan head
- Copper motor for longer lifetime
- Size: 20"
- No. of Speeds: 3
- HP: 0.2

Model No. EA661
Price/Each \$

MATRIX
INDUSTRIAL PRODUCTS



HIGH-VELOCITY OSCILLATING WALL FAN

- Adjustable tilting fan head
- Sliding switch at front of base
- Rotating or fixed air direction
- Type: Wall Mounted
- Size: 20"
- No. of Speeds: 3

Model No. EA660
Price/Each \$

MATRIX
INDUSTRIAL PRODUCTS



LIGHT INDUSTRIAL DIRECT-DRIVE SLIM DRUM FAN

- All-metal construction, painted black & chrome with aluminum blades
- 6' SJT power cord
- 5" casters and easy-moving handle
- Open motor type
- 360° vertical tilt angle
- Diameter: 24"
- No. of Speeds: 3
- HP: 3/10
- Motor: 120 V/60 Hz, 3-speed
- CFM High: 7770
- CFM Low: 4200
- Weight: 25.09 lbs.
- Watts: 215 W

Model No. EA778
Price/Each \$

MATRIX
INDUSTRIAL PRODUCTS



LIGHT INDUSTRIAL DIRECT DRIVE DRUM FANS

- 120 V/60 Hz, 2-speed motor
- All-metal construction, painted black
- 6' SJT power cord
- 6" casters and easy moving handle



Model No.	Blade size"	HP	Watts	CFM		Wt. lbs.	Price /Each
				High	Low		
EA286	28	2/5	290	8050	6650	22	
EA288	36	3/5	405	11200	9100	30.5	

24" DIRECT DRIVE DRUM FANS

- 115 V, 1/4 HP, 2-speed, 1-phase, ball bearing motor
- 3-bladed galvanized steel propellers
- 2-speed rocker switch
- Epoxy coated barrel and steel resilient mounted guards
- Two steel wheels with rubber tires
- Handle with cord wrap for 10' cord with three-prong plug
- Tilttable
- CFM: 4000 (high), 2100 (low)
- RPM: 1100 (high), 800 (low)
- Weight: 70 lbs.

Model No. EA338
Price/Each \$



2-YEAR WARRANTY

Airmaster® Fan Company

42" BELT DRIVE DRUM FANS

- 115 V, 1 HP, 2-speed, 1-phase, ball bearing motor
- Motor out of air stream – stays clean
- Aluminum 4-bladed propellers
- Rocker switch
- Epoxy coated steel spiral, resilient mount guards
- Steel hubbed wheels, swivel locking casters
- 20-gauge roll form epoxy coated housing
- 10' three-conductor cord and plug
- CFM: 17 100 (high), 9558 (low)
- RPM: 430 (high), 285 (low)
- Quiet operation: 75 dB (high), 67 dB (low)
- Weight: 130 lbs.

Model No. EA319
Price/Each \$



2-YEAR WARRANTY

Airmaster® Fan Company

DIRECT DRIVE 4-IN-1® DRUM FANS

- 115 V, 1 phase, ball bearing motor
- One fan with four mounting options in the same carton: Hanging mount, ceiling mount, wall mount, portable barrel
- Guards, barrel mountings epoxy coated
- Pull chain switch
- Tilttable

2-YEAR WARRANTY



Airmaster® Fan Company

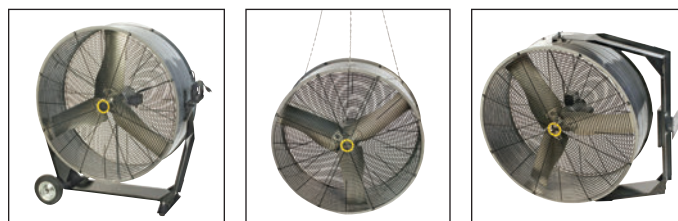

Model No.	Blade Size"	HP	# of Speeds	CFM			RPM		Wt. lbs.	Price /Each
				High	Med	Low	High	Low		
EA336	30	1/4	3	5670	4590	3410	1110	810	600	97
EA337	36	1/2	2	11200	-	8090	830	-	600	119

36" BELT DRIVE DRUM FANS

- 115 V, 1/2 HP, 2-speed, 1-phase, ball bearing motor
- 3-bladed aluminum propellers
- 2-speed rocker switch
- Epoxy coated barrel and steel resilient mounted guards
- Steel wheels with rubber tires
- Easy grip handle with cord wrap
- 10' cord with three-prong plug
- Tilttable
- CFM: 7800 (high), 5300 (low)
- RPM: 660 (high), 450 (low)
- Weight: 116 lbs.

Model No. EA318
Price/Each \$



2-YEAR WARRANTY

Airmaster® Fan Company

GALVANIZED STEEL BELT DRIVE DRUM FAN

- Made from durable corrosion resistant galvanized steel housings which are built to last
- Non-skid front legs keep fan in place while in operation
- Metal handles for portability
- 3-prong heavy duty power cord
- Size: 48"
- No. of Speeds: 2
- HP: 0.75

Model No. EA674
Price/Each \$

shop-air®
A Shop-Vac® Company



SMOKE EJECTORS

Remove smoke, welding fumes and undesirable contaminants from the air or bring clean air in. Reversible smoke ejectors are equipped with a totally enclosed ball bearing motor with automatic overload protection. Units are CSA approved. Explosion-proof models in accordance with Class 1 Group D/ Class II Group EFG. All are 115 VAC, 1/3 HP, 1725 RPM equipped with a 6' power cord, cord holder and cadmium plated protection guards. Hoses are fire safe single ply neoprene impregnated nylon.



Model No.	Type	CFM @ 0.10" SP	L"	x	Box Dim. W"	x	H"	Fan Size"	Price /Each
BA099	Standard	1620	17	x	14 1/8	x	14 1/8	12	
BA101	Standard	3151	17	x	19 1/8	x	19 1/8	16	
BA103	Standard	3700	17	x	21 3/8	x	21 3/8	18	
BA102	Exp. Proof	3151	17	x	19 1/8	x	19 1/8	16	
BA104	Exp. Proof	3700	17	x	21 3/8	x	21 3/8	18	



COLLAR ADAPTORS

Model No.	Fan Size"	Price /Each
BA026	12	
BA028	16	
BA029	18	

FLEXIBLE HOSES

Model No.	Length'	Dia."	Price /Each
BA049	15	12	
BA050	20	16	
BA051	20	18	

SHUTTER FANS

- 115 V motor 1 phase
- Totally enclosed motor
- Direct drive, low pressure
- Fully assembled, ready to Install
- Rear guard meets OSHA standards
- 24" and 30" : 3 speeds with pull chain motor, plug and cord included

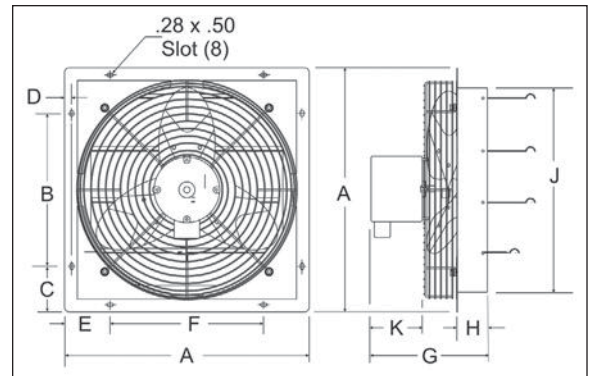

Model No.	Fan Dia."	CV	0" S.P. CFM	1/8" S.P. CFM	A"	B"	F"	Dimensions			Panel Size (square)	Wall Opening (square)	Weight lbs.	Price /Each	
					G"	H"	J"	K"							
EA368	7	1/30	121	60	11.1	4	4	8.06	2.38	8	3	11 1/8"	8 1/2"	10	
EA369	10	1/30	611	318	13.1	6	6	8.06	2.38	10	3	13 1/8"	10 1/2"	10	
EA370	12	1/30	815	490	15.1	8	8	8.06	2.38	12	3	15 1/8"	13"	12	
EA371	16	1/20	1216	765	19.1	12	12	9.06	2.38	16	4	19 1/8"	17"	20	
EA372	18	1/15	1877	752	21.1	14	14	11	2.5	18	4.8	21 1/8"	18 1/2"	25	
EA373	20	1/15	2235	920	23.1	16	16	11	2.5	20	4.8	23 1/8"	20 1/2"	35	
EA374	24	1/4	3214	2015	27.1	20	20	12.7	3	24	5	27 1/8"	25"	48	
EA375	30	1/4	4970	3510	33.1	26	26	12.7	3	30	5	33 1/8"	30 1/2"	57	

ALL PURPOSE WALL FANS

- 115 V motor
- Direct drive, low pressure
- Totally enclosed sleeve bearing motors
- Non-overloading propeller
- High efficiency, low operating cost
- Built-in rear guard
- Commercial-duty
- Four holes .38" dia.

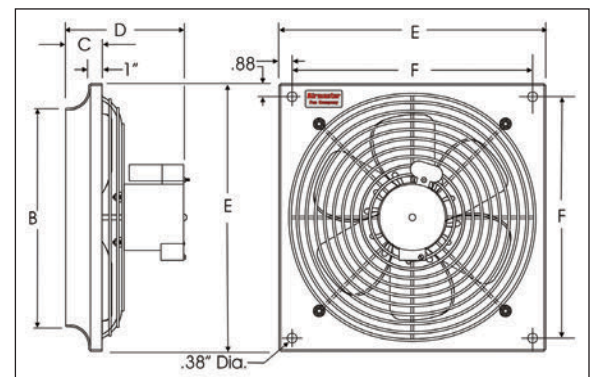

Model No.	Fan Dia."	HP	RPM	0"	Capacity (CFM) @ SP In. W.G.					Dimensions					Weight lbs.	Price /Each
					0.05"	0.10"	0.125"	0.20"	0.250"	A"	B"	C"	D"	E"		
EA376	10	1/30	1550	630	469	418	394	309	234	10	10 1/4	11/2	6	14	12.3	12
EA377	12	1/30	1550	897	843	754	689	503	378	12	12 1/4	11/2	8	16	14.3	14
EA378	16	1/9	1050	1881	1766	1626	1540	1169	814	16	16 1/2	13/4	9 1/2	20	18.3	24
EA379	18	1/9	1050	2504	2345	2149	2035	1553	884	18	18 1/2	13/4	10	22	20.3	27

30/30® HIGH-CAPACITY PLEATED PANEL FILTERS

Features and benefits:

- High capacity pleated panel filter available in 1", 2" or 4" depths
- A welded wire grid to maintain the radial pleat and eliminates distortion of the media pack even under turbulent or high airflow conditions
- Exclusive MERV 8 Media, blended from cotton and polyester fibres, providing consistent dirt removal efficiency throughout the life of the filter
- The 30/30 meets today's medical facility requirements
- A low initial and maintained low resistance to airflow, over the life of the filter that saves energy dollars
- A high wet-strength beverage board frame for maintained filter rigidity in any application
- Maximum continuous operating temperature of 200°F (93°C)
- Proprietary blend of cotton and synthetic fibres in a uniform lofted media blanket

Efficiency: Value of 8 for MERV and MERV-A when evaluated under ASHRAE Testing Standard 52.2.

Typical applications: Pre-filters to higher efficiency filters, stand-alone filter for rooftops, split systems, free-standing units and package systems and air handlers. Ideal for commercial, industrial, institutional or any other application where the ultimate level of protection of equipment and indoor air quality is a concern.



Model No.	Nominal Size					Actual Size					CFM		Resistance*		Media Area sq-ft.	Pleats /foot	Price /Each
	W"	x	D"	x	H"	W"	x	D"	x	H"	Medium	High	Medium	High			
EA157	16	x	4	x	20	15.38	x	3.75	x	19.38	550	1100	0.07	0.27	15.7	11	
EA158	20	x	4	x	20	19.38	x	3.75	x	19.38	695	1390	0.07	0.27	18.9	11	
EA159	12	x	4	x	24	11.38	x	3.75	x	23.38	500	1000	0.07	0.27	13.9	11	
EA160	24	x	4	x	24	23.38	x	3.75	x	23.38	1000	2000	0.07	0.27	27.7	11	
EA161	16	x	4	x	25	15.38	x	3.75	x	24.38	695	1390	0.07	0.27	19.7	11	
EA162	20	x	4	x	25	19.38	x	3.75	x	24.38	870	1740	0.07	0.27	23.6	11	
EA163	16	x	2	x	20	15.5	x	1.75	x	19.5	550	1100	0.08	0.28	9.9	15	
EA164	20	x	2	x	20	19.5	x	1.75	x	19.5	695	1390	0.08	0.28	11.9	15	
EA165	12	x	2	x	24	11.38	x	1.75	x	23.38	500	1000	0.08	0.28	8.4	15	
EA166	24	x	2	x	24	23.38	x	1.75	x	23.38	1000	2000	0.08	0.28	17.3	15	
EA167	16	x	2	x	25	15.5	x	1.75	x	24.5	695	1390	0.08	0.28	12.4	15	
EA168	20	x	2	x	25	19.5	x	1.75	x	24.5	870	1740	0.08	0.28	14.9	15	
EA169	12	x	1	x	24	11.5	x	0.88	x	23.5	350	700	0.11	0.25	4.9	16	
EA170	16	x	1	x	20	15.5	x	0.88	x	19.5	390	780	0.11	0.25	5.4	16	
EA171	20	x	1	x	20	19.5	x	0.88	x	19.5	485	970	0.11	0.25	6.6	16	
EA172	24	x	1	x	24	23.5	x	0.88	x	23.5	700	1400	0.11	0.25	9.8	16	
EA173	16	x	1	x	25	15.5	x	0.88	x	24.5	485	970	0.11	0.25	6.7	16	
EA174	20	x	1	x	25	19.5	x	0.88	x	24.5	610	1220	0.11	0.25	8.3	16	

*Initial resistance to airflow (inches w.g.)

Other sizes also available.

AEROPLEAT® III STANDARD CAPACITY PLEATED PANEL FILTERS

Features and benefits:

- Medium capacity pleated panel filter
- Optimum blend of cotton and synthetic fibres provides medium grade ASHRAE performance and increased dust-holding capacity
- Welded wire media grid is treated for corrosion resistance and prevents media oscillation or pull-away
- High wet-strength beverage board frame creates a rigid and durable filter pack
- Efficiency MERV 8 when evaluated per ASHRAE Standard 52.2-2007 and a MERV-A of 8 when evaluated under Appendix J of that Standard
- Applications include commercial buildings, educational facilities and specialty manufacturing
- As a pre-filter the AeroPleat III offers protection for the higher efficiency final filters required for today's high technology applications



Model No.	Nominal Size					Actual Size					CFM		Resistance*		Media Area sq-ft.	Pleats /foot	Price /Each
	W"	x	D"	x	H"	W"	x	D"	x	H"	Medium	High	Medium	High			
EA139	16	x	4	x	20	15.38	x	3.75	x	19.38	555	1110	0.07	0.21	12.6	9	
EA140	20	x	4	x	20	19.38	x	3.75	x	19.38	695	1390	0.07	0.21	15.7	9	
EA141	12	x	4	x	24	11.38	x	3.75	x	23.38	500	1000	0.07	0.21	11.3	9	
EA142	24	x	4	x	24	23.38	x	3.75	x	23.38	1000	2000	0.07	0.21	22.7	9	
EA143	16	x	4	x	25	15.38	x	3.75	x	24.38	695	1390	0.07	0.21	15.7	9	
EA144	20	x	4	x	25	19.38	x	3.75	x	24.38	870	1740	0.07	0.21	19.7	9	
EA145	16	x	2	x	20	15.5	x	1.75	x	19.5	555	1110	0.08	0.23	6.5	10	
EA146	20	x	2	x	20	19.5	x	1.75	x	19.5	695	1390	0.08	0.23	8.6	10	
EA147	12	x	2	x	24	11.38	x	1.75	x	23.38	500	1000	0.08	0.23	6.1	10	
EA148	24	x	2	x	24	23.38	x	1.75	x	23.38	1000	2000	0.08	0.23	12.1	10	
EA149	16	x	2	x	25	15.5	x	1.75	x	24.5	695	1390	0.08	0.23	7.8	10	
EA150	20	x	2	x	25	19.5	x	1.75	x	24.5	870	1740	0.08	0.23	10.7	10	
EA151	12	x	1	x	24	11.5	x	0.88	x	23.5	350	700	0.11	0.23	3.8	12	
EA152	16	x	1	x	20	15.5	x	0.88	x	19.5	390	780	0.11	0.23	4.3	12	
EA153	20	x	1	x	20	19.5	x	0.88	x	19.5	485	970	0.11	0.23	5.4	12	
EA154	24	x	1	x	24	23.5	x	0.88	x	23.5	700	1400	0.11	0.23	7.8	12	
EA155	16	x	1	x	25	15.5	x	0.88	x	24.5	485	970	0.11	0.23	5.4	12	
EA156	20	x	1	x	25	19.5	x	0.88	x	24.5	610	1220	0.11	0.23	6.7	12	

*Initial resistance to airflow (inches w.g.)

Other sizes also available.

PORTABLE FAN-FORCED UTILITY HEATERS

- Two heat settings (1300 W and 1500 W) provide full comfort and economic operation
- Adjustable thermostat
- Fan-only setting
- Tip over safety switch
- Built-in carrying handle with front safety guards



Model No.	Volts	Watts	BTU/H	Amps	Price /Each
EA598	120	1300/1500	4435/5120	10.8/12.5	

PORTABLE OPEN COIL HEATERS

- Two heat settings (1500 W and 1000 W)
- Provide full comfort and efficient operation
- Fully adjustable automatic thermostat
- Safety overload switch
- Power signal light
- Top mounted handle and controls
- Grounded plug and controls



Model No.	Volts	BTU/H	Watts	Amps	Price /Each
EA469	120	3410/5120	1000/1500	8.3/12.5	

PORTABLE FAN-FORCED CONVECTION HEATERS

- Two heat settings (1500W and 750W) provide full comfort and efficient operation
- Adjustable thermostat
- Wide-angle oscillation
- Tip over safety switch and thermal limit control



Model No.	Volts	Watts	BTU/H	Amps	Price /Each
EA597	120	750/1500	2560/5200	6.25/12.5	

PORTABLE FAN-FORCED/RADIANT UTILITY HEATERS

- Three heat settings provides full comfort and efficient operation
- 600 W radiant
- 900 W fan forced
- 1500 W fan forced and radiant
- Chrome-plated safety grill
- Automatic built-in thermostat
- Ceramic core element
- Tip over safety switch and thermal limit



Model No.	Volts	Watts	BTU/H	Amps	Price /Each
EA466	120	600/900/1500	2048/3072/5120	5.0/7.5/12.5	

PORTABLE CERAMIC HEATERS

- Two heat settings (1500 W and 750 W) provide full comfort and efficient operation
- Adjustable thermostat
- PTC heating element
- Tip over safety switch and thermal safety fuse



Model No.	Volts	Watts	BTU/H	Amps	Price /Each
EA599	120	750/1500	2560/5200	6.25/12.5	

OIL-FILLED HEATERS

- 7-fin, oil-filled heater
- Three heat settings provide full comfort and efficient operation
- Adjustable thermostat
- Built-in over heating protection



Model No.	Volts	Watts	BTU/H	Amps	Price /Each
EA612	120	1500	5120	12.5	

PORTABLE CERAMIC HEATERS

- Two heat settings provide full comfort and efficient operation
- Adjustable thermostat
- Convenient carry handle

CONTRACTOR HEATERS

- Built-in thermostat
- Safety high temperature limit
- Steel spiral fin brazed to metal sheath elements for maximum heat transfer
- 6' heavy-duty cord
- Built-in handle/cord storage
- Permanently lubricated motor



Model No.	Volts	PH	Watts	BTU/H	Amps	Plug Type	Wt. lbs.	Price /Each
EA477	240	1	5600	19 110	23.34	#6-30P	12	
EA561	240	1	4800	16380	20	#6-30P	12	



Model No.	Volts	Watts	BTU/H	Price /Each
EA785	120	750/1500	2600/5200	
EA650	120	900/1500	2560/5200	

PORTABLE UNDER DESK RADIANT HEATER

- Thin and lightweight
- Includes fold-out metal floor stand
- Type: Radiant Heat
- Power Source: Electric
- Min BTU Rating: 580 BTU/H
- Max BTU Rating: 580 BTU/H
- Voltage: 120 V

Model No. EA651
Price/Each \$



HEAVY-DUTY CEILING MOUNT HEATERS

- Multi wattage covering 3000-5000 W (3000 W, 4000 W, 5000 W)
- Rugged heavy-duty industrial heater
- Ideal for use in storage rooms, workshops, garages, warehousing
- Built-in ceiling bracket for easy mounting
- Automatic fan delay



Model No.	Volts	BTU/H Min./Max.	Price /Each
EA532	240	8530/17 060	
EA652	240	8530/25 600	



PORTABLE ELECTRIC BLOWER HEATERS

- Heavy-duty fin-tube metal heating element
- Fan-only operation for summer cooling
- Safe to operate in unattended areas
- Shipped fully assembled
- 240 V, 10 kW, 41.7 A, 32 120 BTU/H

Note: for indoor use only with ceiling heights of 15' or less

Model No. EA101
Price/Each \$



Area Size sq.ft.	Temperature Rise	
	10°C	19°C
1000	70 min	140 min
1500	105 min	210 min

FAN-FORCED ZONAL WALL HEATERS

- Built-in thermostat
- European styling: sleek rounded corners
- Dual protection: thermal cutout with indicator light and one time thermal fuse
- Fast coil response element assures quick heat and low maintenance



Model No.	Volts	Watts	Amps	BTU/H	Price /Each
EA031	240	2000/1500/1000/500	8.3/6.3/4.2/2.1	6824/5118/3412/1706	
	208	1500/1125/750/375	12.5/9.4/6.3/3.1	5118/3838/2560/1280	

PORTABLE SALAMANDER HEATERS

- Manufactured for long lasting, this portable heater for warehouses, factories, garages, construction sites, pavilions and other open areas, raise temperature to the desired level gradually for worksite comfort
- Adjustable thermostat
- Adjustable tilt angle
- Mounted on 10" solid rubber wheels
- Over heat protection
- Easy to move to different areas of the site
- One heat setting, fan forced
- Voltage: 240V
- Wattage: 10000 W
- Fan Motor Type: Enclosed air over, Ball bearing
- Colour: Orange with Black Cart
- Type: Contractor
- BTU Rating: 34 121 BTU/H

Model No. EA786
Price/Each \$



SUN BLAST® HEATERS

- Efficient, heats radiantly, directly, no loss of heat to the air
- Economical, no electricity required
- Fits on a standard 20 lb. LP cylinder
- Variable BTU output
- Manual ignition
- Front and back protective grill
- No assembly required
- Heater shuts off automatically with loss of flame
- Natural gas version also available



Model No.	Mfg. No.	Description	Rating BTU/H		Price /Each
			Min.	Max.	
JG966	SUN BLAST 15	Single Tank-Top Radiant Heater	9000	15 000	
JG967	SUN BLAST 30	Double Tank-Top Radiant Heater	9000	30 000	

TRADESMAN™ FORCED AIR PROPANE HEATERS

- Tradesman® forced air heaters feature a unique 3-trial ignition system, the industry's heaviest gauge combustion chamber and burner plate
- Variable output control for maximized fuel efficiency
- Electronic spark ignition
- Thermostatic temperature control
- Tri-Shield finish provides protection against abrasion and corrosion
- Adjustable front leg provides easy direction of heat
- 15' hose
- Voltage: 115 V



JG953



JG954

Model No.	Mfg. No.	Amperage (Starting/Continuous Operation)	Wattage (Starting/Continuous Operation)	BTU Rating	Price /Each
JG953	TRADESMAN 170	3.7/2.4	425.5/241.5	125 000 to 170 000	
JG954	TRADESMAN 400	4.0/1.5	460/172.5	240 000 to 400 000	

TRADESMAN™ FORCED AIR KEROSENE HEATERS

- Tradesman® kerosene heaters provide instant, efficient, directional heat
- A dependable dual-prong electronic spark ignition, heavy-duty enclosed motor and long lasting composite fuel fittings are just a few of the features that provide long life and trouble free operation
- Dual-prong electronic spark ignition
- Auxiliary 110 V power receptacle
- Temperature display and thermostat
- Fuel gauge indicates remaining run time
- Threaded drain plug
- Wheels and handles make it easier to maneuver (JG958, JG959, JG960 only)
- Includes pressure gauge (JG958, JG959, JG960 only)
- Voltage: 115 V



Model No.	Mfg. No.	Amperage (Continuous Operation)	Wattage (Continuous Operation)	BTU Rating	Tank Capacity US Gallons	Price /Each
JG957	TRADESMAN K75	1.6	184	75 000	5	
JG958	TRADESMAN K125	2.5	287.5	125 000	10	
JG959	TRADESMAN K175	3.2	368	175 000	13	
JG960	TRADESMAN K210	3.7	425.5	210 000	13	

JG957



JG958

PREMIER™ FORCED AIR KEROSENE HEATER

- Premier™ heaters are ideal for small or large work spaces, renovation jobs, and any applications where low noise or an enclosed flame is important
- Can be used to provide heat or simple air circulation inside or be ducted in from the outside
- Quiet operation
- Can be used with or without ducting
- Dependable electronic spark ignition
- Tri-Shield finish provides protection against abrasion and corrosion
- 15' hose and regulator included
- 20' remote start thermostat
- Vent mode for circulation of air
- Easy to transport
- Voltage: 115 V



Model No.	Mfg. No.	Amperage (Starting/Continuous Operation)	Wattage (Starting/Continuous Operation)	BTU Rating	Price /Each
JG963	PREMIER 80	5.0/1.5	575/172.5	80 000	

SUN BLAST® FLAT PANEL RADIANT HEATER

- Sun Blast® flat panel is great for spot heating large areas
- Folding handle and wheels for easy transport
- Piezo pilot ignition
- Tip over switch shuts product down for safety
- Works with standard 20 lb. cylinder
- Lightweight for easy maneuverability
- Directional heating
- Natural gas version also available



Model No.	Mfg. No.	Rating BTU/H	Price /Each
JG968	SUN BLAST 35	35 000	

SUN BLAST® RADIANT HEATER

- Sun Blast® round provides 360° radiant heating
- High handle and wheels for easy transport
- Durable rugged construction ideal for any construction site
- Piezo pilot ignition
- Tip over switch shuts product down for safety
- Natural gas version also available



Model No.	Mfg. No.	Rating BTU/H	Price /Each
JG969	SUN BLAST 125	125 000	

CONTRACTOR SERIES LED A19 LAMP

- Great value LED light bulb
- Offers years of service at reduced energy and maintenance cost
- Suitable for damp environments
- UV and IR-free
- Non-dimmable
- Lamp Life: 11000 hrs.
- Colour Temperature: 2700 K
- Bulb Shape: A19
- Base Type: Medium
- CRI: 80
- Bulb Finish: Frosted



Model No.	Watts	Lumens	Equivalent to	Price /Each
XG992	6	450	40W incandescent	
XG993	8.5	800	60W incandescent	
XG994	14	1500	100W incandescent	

CONTRACTOR SERIES LED PAR20 LAMP

- Great value LED light bulb
- Offers years of service at reduced energy and maintenance cost
- Suitable for damp environments
- UV and IR-free
- Non-dimmable
- Lamp Life: 11000 hrs.
- Colour Temperature: 3000 K
- Bulb Shape: PAR20
- Base Type: Medium
- CRI: 82
- Lamps per Pack: 2



Model No.	Watts	Lumens	Equivalent to	Price /Pack
XG996	6	425	50W halogen	

CONTRACTOR SERIES LED PAR30 LAMP

- Great value LED light bulb
- Offers years of service at reduced energy and maintenance cost
- Suitable for damp environments
- UV and IR-free
- Non-dimmable
- Lamp Life: 11000 hrs.
- Colour Temperature: 3000 K
- Bulb Shape: PAR30
- Base Type: Medium
- CRI: 82
- Lamps per Pack: 2



Model No.	Watts	Lumens	Equivalent to	Price /Pack
XG997	9	800	65W halogen	

CONTRACTOR SERIES LED PAR38 LAMP

- Great value LED light bulb
- Offers years of service at reduced energy and maintenance cost
- Suitable for damp environments
- UV and IR-free
- Non-dimmable
- Lamp Life: 11000 hrs.
- Colour Temperature: 3000 K
- Bulb Shape: PAR38
- Base Type: Medium
- CRI: 82
- Lamps per Pack: 2



Model No.	Watts	Lumens	Equivalent to	Price /Pack
XG998	13	1050	90W halogen	

CONTRACTOR SERIES LED PAR16 LAMP

- Great value LED light bulb
- Offers years of service at reduced energy and maintenance cost
- UV and IR-free
- Dimmable
- Lamp Life: 11000 hrs.
- Colour Temperature: 3000 K
- Bulb Shape: PAR16
- Base Type: GU10
- CRI: 81
- Lamps per Pack: 3



Model No.	Watts	Lumens	Equivalent to	Price /Pack
XG999	4	350	35W halogen	

CONTRACTOR SERIES LED MR16 LAMP

- Great value LED light bulb
- Offers years of service at reduced energy and maintenance cost
- UV and IR-free
- Non-dimmable
- Lamp Life: 11000 hrs.
- Colour Temperature: 3000 K
- Bulb Shape: MR16
- Base Type: GU5.3
- CRI: 81
- Lamps per Pack: 3



Model No.	Watts	Lumens	Equivalent to	Price /Pack
XH001	5	350	35W halogen	

LAMPS

CONTRACTOR SERIES LED BR30 REFLECTOR LAMP

- Great value LED light bulb
- Offers years of service at reduced energy and maintenance cost
- Dimmable
- Lamp Life: 11000 hrs.
- Colour Temperature: 2700 K
- Bulb Shape: BR30
- Base Type: Medium
- CRI: 80
- Lamps per Pack: 2



Model No.	Watts	Lumens	Equivalent to	Price /Pack
XH002	9	650	65W halogen	

SUBSTITUTE® VALUE LED T8 LAMPS

- Energy saving LED lamp that is designed to replace traditional fluorescent T8 lamps
- Provide instant and uniform light distribution
- Can be operated on existing instant start and select programmed rapid start electronic T8 ballasts
- Wattage: 17 W
- Base Type: Medium Bi-Pin
- Bulb Shape: T8
- Nominal Length: 48"
- CRI: 82
- Lamps per Case: 10
- Lamp Life: 36000 hrs.
- Lumens: 2200



Model No.	Colour Temperature	Price /Case
XG990	3000 K	
XG995	4100 K	

ECONOMY LINE LAMPS



XC571



XC568



XC551

Model No.	Watts	Volts	Lamp	Life average rated hours	Base	Qty /Pkg.	Price /Pkg.
XC550	10	120	Fluorescent spiral	8000	E27	2	
XC622	13	120	Fluorescent spiral	8000	E27	2	
XC551	13	120	Fluorescent spiral	10 000	E27	4	
XC553	13	120	Fluorescent spiral bug light (yellow)	8000	E27	1	
XC552	23	120	Fluorescent spiral	10 000	E27	2	
XC563	150	130	Incandescent A21 inside frost	7000	E27	1	
XC561	150	130	Incandescent A21 clear	7000	E27	1	
XC562	200	130	Incandescent A21 clear	7000	E27	1	
XC564	50	130	Incandescent rough service	2500	E27	2	
XC565	100	130	Incandescent rough service	2500	E27	2	
XC566	120	130	Incandescent BR38 flood	5000	E27	2	
XC567	65	130	Incandescent BR30 flood	5000	E27	2	
XG966	60	120	Incandescent A19 clear	8000	Medium	6	
XC568	50	120	Halogen GU10	2000	GU10	1	
XC569	50	130	Halogen PAR20 Narrow flood	2000	E27	2	
XC570	75	120	Halogen PAR30 flood	5000	E27	1	
XC571	90	130	Halogen PAR38 flood	5000	E27	1	

SPILL CONTROL
EYEWEAR

ZENITH®
Safety Products

SAFETY

TRAFFIC CONTROL
GLOVES

HIGH INTENSITY DISCHARGE LAMPS (HID)



HID lamps offer long life, maximum efficiency, and brighter light than an incandescent light source for a variety of indoor and outdoor applications. Product benefits such as long life, high lumen output per watt and improved colour rendering make HID lamps one of the fastest growing products on the market.

High pressure sodium lamps deliver more lumens per watt over rated life than most other HID light sources available today.

High pressure sodium lamps are ideally used in:

- Industrial installations
- Parking areas
- Terminals
- Walkways
- Building facades
- Bridges

Metal halide is the most efficient source of white light available today.

Metal halide lamps are excellent choices in:

- Shopping malls
- Greenhouses
- Warehouses
- Retail facilities
- Street and sports lighting



Watts	Lamp	Base	Model No.	Mfg. No.	Qty /Case	Description	Life avg. rated hours	Approx. initial lumens	Approx. mean lumens	Colour rend. index	Colour temp	Price /Each
HIGH PRESSURE SODIUM												
50	ET-23 1/2"	Mogul	XB196	LU50/ECO	20	Clear	24 000+	4000	3600		1900 K	
70	ET-23 1/2"	Mogul	XB197	LU70/ECO	20	Clear	24 000+	6300	5500		1900 K	
100	ET-23 1/2"	E39 Mogul	XG955	LU100/PLUS/ECO	20	Clear	4000	10 000	7940		2100 K	
250	ET-18	Mogul	XB201	LU250/ECO	20	Clear	24 000+	29 000	26 100		2100 K	
400	ET-18	Mogul	XB202	LU400/ECO	20	Clear	24 000+	50 000	45 000		2100 K	
50	E-17	Medium	XB205	LU50/MED	20	Clear	24 000+	4000	3600		1900 K	
70	E-17	Medium	XB206	LU70/MED	20	Clear	24 000+	6300	5350		1900 K	
100	E-17	Medium	XB207	LU100/MED	20	Clear	24 000+	9500	8000		2100 K	
METAL HALIDE												
70	E-17	Med.	XB209	MP70/U/MED	20	Clear, univ. burn	15 000V, 10 000H	5200	3900	75	3000 K	
100	E-17	Med.	XB210	MP100/U/MED	20	Clear, univ. burn	15 000V, 10 000H	8500	6400	75	3000 K	
150	E-17	Med.	XB211	MP150/U/MED	20	Clear, univ. burn	15 000V, 10 000H	13 300	10 000	75	3000 K	
175	ED-17	Med.	XB212	M175/U/MED	20	Clear, univ. burn	10 000V, 7500H	14 400V, 12 800H	10 800V, 9500H	65	4000 K	
1000	BT-56	Mogul	XB217	M1000/U	6	Clear, univ. burn	15 000V, 9000H	11 000V, 10 7800H	88 000V, 86 300H	65	4000 K	

HALOGEN LAMPS



Energy Used Nominal Watts	Base	Model No.	Mfg. No.	Volts	Qty /Case	Description	Life avg. rated hours	Lumens	Price /Each
PAR16 HALOGEN									
50	GU10	XG921	50PAR16/HAL/GU10/FL40 120V	120	10	Directional reflector	2000	400	
PAR30 HALOGEN									
39	E26 Medium	XG981	60PAR30/HAL/S/WFL50 120V	120	10	Directional reflector	1500	1070	
39	E26 Medium	XG980	139PAR30/HAL/WFL50 130V	130	10	Directional reflector	1500	550	
50	Medium	XB138	50PAR30LN/CAP/NFL	130	15	Narrow flood	2500	600	
75	Medium	XB140	75PAR30LN/CAP/WFL	130	15	Wide flood	2500	1100	
75	Medium	XB141	75PAR30LN/CAP/NFL	130	15	Narrow flood	2500	1100	
PAR38 HALOGEN									
75	Medium	XB134	75PAR38/CAP/SPL/FL/30/130V	130	15	Flood	2500	1060	
90	Medium	XB135	90PAR38/CAP/SPL/FL/30/130V	130	15	Flood	2500	1300	
90	Medium	XB136	90PAR38/CAP/SPL/SP/9/130V	130	15	Spot	2500	1310	
MR16 HALOGEN									
20	GU5.3	XC305	20MR16/FL35	12	20	Reflector, flood beam	4000	250	
35	GU5.3	XG920	35MR16/FL35/(CFMW)12V	12	20	UV filter with dichroic reflector	2000	500	
50	GU5.3	XB153	50MR16/FL40 (EXN)	12	20	Reflector, flood beam	4000	700	

LAMPS

COMPACT FLUORESCENT LAMPS



Nominal Watts	Description	Base	Model No.	Mfg. No.	Qty /Case	Life rated hours	Colour Temp. (K)	Price /Package
MICRO-MINI TWIST								
13	Micro-Mini Twist 2/pkg.	Medium	XG974	CF13EL/SPIRAL/827	6	10 000	2700	
13	Micro-Mini Twist 3/pkg.	Medium	XG982	CF13EL/SPIRAL/827	6	10 000	2700	
13	Micro-Mini Twist 1/pkg.	Medium	XG983	CF13EL/SPIRAL/841	6	10 000	4100	
13	Micro-Mini Twist 2/pkg.	Medium	XG986	CF13EL/SPIRAL/865	6	10 000	6500	
23	Micro-Mini Twist 3/pkg.	Medium	XG985	CF23EL/SPIRAL/827	6	10 000	2700	
MINI TWIST								
13	Mini Twist 1/pkg.	Medium	XB913	CF13EL/SUPER/CVP	12	10 000	2700	
23	Mini Twist 2/pkg.	Medium	XC378	CF23EL/SUPER 827/RP2	6	10 000	2700	

Nominal Watts	Lamp	Base	Model No.	Mfg. No.	Qty /Case	Description	Life rated hours	Light output approx. initial lumens	Price /Each
UNIVERSAL									
26	T-4	G24Q-3	XC527	CF26DD/E/835/ECO	50	3500 K, 82 CRI	12 000	1470	
26	T-4	G24Q-3	XC528	CF26DD/ E/841/ECO	50	4100 K, 82 CRI	12 000	1470	
32	T-4	GX24Q-3	XC535	CF32DT/E/IN/841/ECO	50	4100 K, 82 CRI	12 000	2002	
DOUBLE TUBE									
26	D (T-4)	G24Q-3	XG923	CF26DD/841/ECO	50	4100 K, 82 CRI	10 000	1710	
13	D (T-4)	G24Q-1	XG922	CF13DD/E/841/ECO	50	4100 K, 82 CRI	20 000	990	
TRIPLE TUBE									
26	T (T-4)	G24Q-3	XG924	CF26DT/E/IN/841/ECO	50	4100 K, 82 CRI	16 000	1745	
42	T (T-4)	G24Q-4	XG925	CF26DT/E/IN/841/ECO	50	3500 K, 82 CRI	16 000	3105	
42	T (T-4)	G24Q-4	XG926	CF42DT/E/IN/841/ECO	50	4100 K, 82 CRI	16 000	3105	
36	L (T-4)	2G11	XG953	FT36DL/841/ECO	10	4100 K, 82 CRI	12 000	2902	
40	L (T-4)	2G11	XG954	FT40DL/841/RS/ECO	10	4100 K, 82 CRI	15 000	3150	

**Zenith sorbents...
Work as hard
as you do!**



FLUORESCENT LAMPS



XB168

Nominal Watts	Lamp	Nominal length"	Base	Model No.	Mfg. No.	Qty /Case	Description	Light output approx. initial lumens	Price /Case
T5									
6	T5	9	Mini Bi-Pin	XD077	F6T5	10	Cool white	270	
14	T5	24	Mini Bi-Pin	YG943	FP14/835/ECO	40	3500 K, 85 CRI, Pentron® Ecologic	1200	
14	T5	24	Mini Bi-Pin	YG944	FP14/841/ECO	40	4100 K, 85 CRI, PPentron® Ecologic	1200	
24	T5	24	Mini Bi-Pin	YG945	FP24/841/HO/ECO	40	4100 K, 85 CRI, Pentron® Ecologic	1750	
28	T5	48	Mini Bi-Pin	YG946	FP28/835/ECO	40	3500 K, 85 CRI, Pentron® Ecologic	2600	
28	T5	48	Mini Bi-Pin	YG947	FP28/841/ECO	40	4100 K, 85 CRI, Pentron® Ecologic	2600	
54	T5	48	Mini Bi-Pin	YG948	FP54/830/HO/ECO	40	3000 K, 85 CRI, Pentron® Ecologic	4450	
54	T5	48	Mini Bi-Pin	YG949	FP54/835/HO/ECO	40	3500 K, 85 CRI, Pentron® Ecologic	4450	
54	T5	48	Mini Bi-Pin	YG950	FP54/841/HO/ECO	40	4100 K, 85 CRI, Pentron® Ecologic	4450	
54	T5	48	Mini Bi-Pin	YG951	FP54/850/HO/ECO	40	5000 K, 85 CRI, Pentron® Ecologic	4310	
54	T5	48	Mini Bi-Pin	YG952	FP54/865/HO/ECO	40	6500 K, 85 CRI, Pentron® Ecologic	4100	
T8									
15	T8	18	Medium Bi-Pin	XB160	F15T8/D	24	Daylight	750	
15	T8	18	Medium Bi-Pin	XA572	F15T8/CW	24	Cool white	825	
17	T8	24	Medium Bi-Pin	XB177	F017/841/XP/ECO	30	4100 K, 75 CRI, Octron® 700 XP, Eco.	1325	
17	T8	24	Medium Bi-Pin	YG933	F017/835/ECO	30	3500 K, 82 CRI, Octron® 800 Ecologic	1350	
25	T8	36	Medium Bi-Pin	XB178	F025/830/XP/ECO	30	3000 K, 75 CRI, Octron® 700 XP, Eco.	2050	
25	T8	36	Medium Bi-Pin	YG934	F025/841/XP/ECO3	30	4100 K, 85 CRI, Octron® 800 XP Ecologic	2175	
25	T8	48	Medium Bi-Pin	YG937	F032/25W/835/XV/SS/ECO	30	3500 K, 83 CRI, Octron® 800 XV Supersaver Ecologic	2400	
25	T8	48	Medium Bi-Pin	YG938	F032/25W/841/XP/SS/ECO3	30	4100 K, 85 CRI, Octron® 800 XP Supersaver Ecologic	2500	
28	T8	48	Medium Bi-Pin	YG936	F028/850XP/PL/SS/ECO3	30	5000 K, 81 CRI, Octron® XP Supersaver Ecologic	2600	
28	T8	48	Medium Bi-Pin	YG960	F028/841/XV/SS/ECO	30	4100 K, 83 CRI, Octron® 800 XV Supersaver Ecologic	2600	
28	T8	48	Medium Bi-Pin	YG968	F028/835/XV/SS/ECO	30	3500 K, 83 CRI, Octron® 800 XV Supersaver Ecologic	2600	
28	T8	48	Medium Bi-Pin	YG935	F028/841/XP/SS/ECO3	30	4100 K, 85 CRI, Octron® 800 XP Supersaver Ecologic	2725	
32	T8	48	Medium Bi-Pin	YG964	F032/V41/ECO	30	4100 K, 90 CRI, Octron® Vivid Value Ecologic	2450	
32	T8	48	Medium Bi-Pin	YG972	F032/865/ECO	30	6500 K, 80 CRI, Octron® 800 Ecologic	2875	
32	T8	48	Medium Bi-Pin	XE745	F032/V50/ECO	30	5000 K, 75 CRI, Octron® 700, Eco.	2250	
32	T8	48	Medium Bi-Pin	YG940	F032/865/XP/ECO	30	6500 K, 85 CRI, Octron® 800 XP Ecologic	2900	
32	T8	48	Medium Bi-Pin	XC526	F032/835/ECO	30	3500 K, 85 CRI, Octron® 800, Eco.	2950	
32	T8	48	Medium Bi-Pin	XB917	F032/841/ECO	30	4100 K, 75 CRI, Octron® 800, Eco.	2950	
32	T8	48	Medium Bi-Pin	YG961	F032/841/XP/XL/ECO3	30	4100 K, 85 CRI, Octron® XP XL Ecologic	2950	
32	T8	48	Medium Bi-Pin	YG973	F032/835/XP/ECO3	30	3500 K, 85 CRI, Octron® 800 XP Ecologic	3000	
32	T8	48	Medium Bi-Pin	YG969	F032/835/XPS/ECO3	30	3500 K, 85 CRI, Octron® 800 XPS Ecologic	3100	
32	T8	48	Medium Bi-Pin	YG965	F032/850/XP/ECO3	30	5000 K, 85 CRI, Octron® 800 XP Ecologic	3000	
32	T8	48	Medium Bi-Pin	YG939	F032/841/XP/ECO3	30	4100 K, 85 CRI, Octron® 800 XP Ecologic	3000	
40	T8	60	Medium Bi-Pin	YG941	F040/841/XP/ECO3	30	4100 K, 85 CRI, Octron® 800 XP Ecologic	3750	
59	T8	96	Medium Bi-Pin	YG942	F096/841/ECO	24	4100 K, 82 CRI, Octron® 800 XV Supersaver Ecologic	5900	
T12									
20	T12	24	Medium Bi-Pin	XB162	F20T12/D	30	Daylight	1075	
30	T12	36	Medium Bi-Pin	XB163	F30T12/CW/RS	30	Cool white rapid start	2200	
30	T12	36	Medium Bi-Pin	YG971	F30T12/WW/RS	30	3000 K, 52 CRI, Standard	2275	
34	T12	48	Medium Bi-Pin	XE688	F34/CWX/SS/2/30	30	Cool white Supersaver®	1925	
34	T12	48	Medium Bi-Pin	YG927	F34CWX/SS (F40CWX/SS)	30	4100 K, 87 CRI, Supersaver®	1925	
34	T12	48	Medium Bi-Pin	YG963	F34/CWX/SS/RP	30	4100 K, 87 CRI, Deluxe Supersaver®	1925	
40	T12	48	Medium Bi-Pin	XB165	F40DX	30	Daylight deluxe	2180	
60	T12	96	Single Pin	XE660	F96T2/CW/XS/SOPC	15	Cool white	3850	
75	T12	96	Single Pin	XB168	F96T12/DX	15	Daylight deluxe	4360	
75	T12	96	Single Pin	YG930	F96T12/CWX	15	4100 K, 87 CRI, Slimline	4400	
U-BENT									
31	T8	22.5	Medium Bi-Pin	YG991	FB031/841	15	4100 K, 82 CRI, Octron® 800 CURVALUME®	2725	
32	T8	22.5	Medium Bi-Pin	XB186	FB032/841/6/ECO	16	4100 K 82 CRI, Octron® 800	2850	
32	T8	22.5	Medium Bi-Pin	YG932	FB032/835/6/ECO	16	3500 K, 82 CRI, CURVALUME®	2850	
32	T8	22.5	Medium Bi-Pin	XB187	FB032/830/6/ECO	16	3000 K, 82 CRI, Octron® 800	2850	
40	T12	22.5	Medium Bi-Pin	YG931	FB40/CWX/6	12	4100 K, 87 CRI, CURVALUME® Rapid Start	2100	
HIGH OUTPUT									
60	T12	48	Recessed Double Contact	YG928	F48T12/CW/HO	30	4200 K, 60 CRI, High Output	4050	
85	T12	72	Recessed Double Contact	YG929	F72T12/CW/HO	15	4200 K, 60 CRI, High Output	6250	
110	T12	96	Recessed D.C.	XB188	F96T12/CW/HO/COLDTEMP	15	Coolhite intended for cold temperature applications only	8600	
110	T12	96	Recessed D.C.	XB190	F96T12/D/HO/COLDTEMP	15	Daylight intended for cold temperature applications only	7600	

LAMPS

BALLASTS

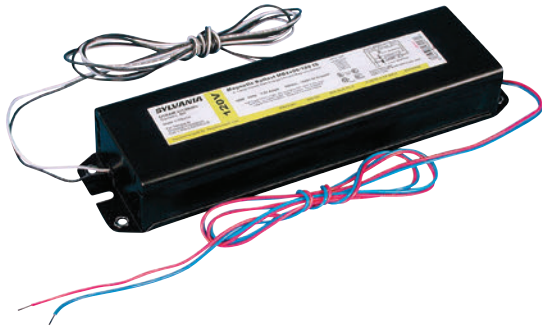

For use with
fluorescent
fixtures

Model No.	Mfg. No.	Start Type	Ballast Factor	Lamp Qty	Lamp Type	Input Voltage	Qty /Case	Price /Each
FLUORESCENT - ELECTRONIC								
XC217	QTP2X32T8/UNV/ISN/SC	Instant Start	Normal	2	F032/XP	120	10	
XB258	QTP3X32T8/UNV/ISN/SC	Instant Start	Normal	3	F032/XP	120	10	
XB260	QT4X32T8/UNV/ISN/SC	Instant Start	Normal	4	F032/XP	120	10	
XC214	QT4X32T8/ISN/SC/347V	Instant Start	Normal	4	F032/XP	347	10	
XG956	QHE 2X32T8/347 ISN-SC	Instant Start	Normal	2	F032/XP	347	10	
XG957	QHE 2X32T8/UNV ISN-SC	Instant Start	Normal	2	F032/XP	120-277	10	
XG959	QHE 4X32T8/UNV ISN-SC	Instant Start	Normal	4	F032/XP	120-277	10	
XG976	QHE 1X32T8/UNV ISN-SC	Instant Start	Normal	1	F032/XP	120-277	10	
XG978	QHE 1X32T8/347 ISN-SC	Instant Start	Normal	1	F032/XP	347	10	
XG987	QHE 3X32T8/UNV ISN-SC	Instant Start	Normal	3	F032/XP	120-277	10	
XG977	QHE 1x32T8/347 ISL-SC	Instant Start	Low	1	F032/XP	347	10	
XG962	QHE 4X32T8/347 ISL-SC	Instant Start	Low	4	F032/XP	347	10	
XG970	QHE 3X32T8/UNV ISL-SC	Instant Start	Low	3	F032/XP	120-277	10	
XG975	QHE 1X32T8/UNV ISL-SC	Instant Start	Low	1	F032/XP	120-277	10	
XC520	QHE 2X32T8/UNV/ISL/SC	Instant Start	Low	2	F032/XP	120	10	
XC523	QHE2X32T8/347/ISL/SC	Instant Start	Low	2	F032/XP	347	10	
XG988	QHE 3X32T8/347 ISL-SC	Instant Start	Low	3	F032/XP	347	10	
XG979	QHE 2x54T5HO-UNV	Rapid Start	Normal	1 or 2	FP54T5HO	120-277	10	
XG958	QHE 2x54T5HO/UNV PSN-HT	Rapid Start	Normal	1 or 2	FP54T5HO	120-277	10	
XG989	QHE 2X39-24T5HO/UNV PSN	Rapid Start	Normal	1 or 2	FP39T5HO	120-277	10	
XG967	QHE 2x54T5HO-UNV PSN (NL)	Rapid Start	Normal	1 or 2	FP54T5HO	120-277	20	

Afraid of Heights...

We've Got You Covered!

KLETON

Canada's Leading
Material Handling Supplier



CANADIAN WIRE CONNECTOR KITS

450 PIECES

- A variety of connectors to fit a large range of wire sizes
- Great for servicing technicians
- Convenient and durable carrying case
- Reusable packaging
- Made in Canada
- UL Listed and CSA Certified
- Kit Components:
 - 20 x WingTwist® Wire Connector - Blue 14-6 AWG (WT 54 - Rated 600V)
 - 20 x Canadian Wire Twist™ - Red 18-14 AWG (C6 - Rated 600V)
 - 85 x Can-Twist™ 22-8 AWG (007 - Rated 600V)
 - 50 x Canadian Wire Twist™ - Yellow 18-10 AWG (C4 - Rated 600V)
 - 50 x Can-Twist Extreme™ 22-12 AWG (007XT - Rated 600V)
 - 100 x WireTwist® Wire Connector - Blue 22-14 AWG (WT2 - Rated 300V)
 - 50 x WireTwist™ Wire Connector - Gray 22-14 AWG (WT1 - Rated 300V)
 - 75 x Canadian Wire Twist™ - Orange 18-14 AWG (C3 - Rated 600V)



Model No.	Mfg. No.	Connection Type	Wire Range (AWG)	Voltage	Colour	Price /Each
XE850	30-2088	Twist	26-6	Mixed	Mixed	

CAN-TWIST™ WIRE CONNECTORS

- Exceptional wire-range capacity - handles wire combinations from 22 to 8 AWG solid and/or stranded wires
- Easily removed for repeat usage
- Flexible walls show when wires are firmly connected
- Spring threads are heat-set, making them more reliable
- Extended skirt length provides over-strip protection
- Smaller size makes it easier to work in tight spaces
- Wide mouth and square springs deliver quicker pick-up
- Swept wings provide added gripping power
- Easier to twist: only a few turns are necessary to achieve torque
- Wire Combination Range: 600V #22 thru 8 AWG, Min.3 #22 Max.3 #10
- CSA 22.2#188 Certified



Model No.	Mfg. No.	Quantity /Pkg.	Price /Pkg.
XC085	30-107J	175	
XC086	30-307J	475	

CABLE TRACERS

- All components are fully fuse protected and intrinsically safe
- Model R2000 Receiver has two detectors in its tip which are tuned to pick up the electromagnetic signals or electrostatic signals
- LEDs and sensitivity settings indicate the relative signal strength
- Model S2600 Load Signal Generator, when connected to an energized line, will draw a rapidly fluctuating current pulse from the source, causing the power line to emit an electromagnetic signal
- Model T2200 Transmitter injects a signal into an unenergized conductor R2000
- Model A2201 Inductive Clamp when clamped around the energized line and plugged into the T2200 will induce a signal onto the downstream (load) side
- Includes: Receiver, load signal generator, transmitter, clamp-on transmitter accessory, cordsets and adapter



Model No.	Mfg. No.	Description	Price/Each
HD909	AT-2004	Cable Tracing System	

YELLOW 77® WIRE PULLING LUBRICANT

- Wax-based formula provides superior lubricity
- Safe to use with most cable types except low-density polyethylene and semi-conducting jackets
- Clings to cable through long pulls
- Environmentally safe - non-toxic, non-flammable, non-corrosive
- Dries to a thin, non-conductive film that won't clog conduit



Model No.	Description	Price /Each
AB488	1 qt. Squeeze Bottle	
AB489	1 gal. Tub	

VOLTALERT™ VOLTAGE DETECTOR

- Small, rugged and reliable, the VoltAlert™ is designed for ease of use – if the tip glows red and the unit beeps when touching a terminal strip, outlet, or cord, there is voltage
- IA156 continually tests its battery and its circuit integrity with a periodic double flash visual indication using Fluke Voltbeat™ technology
- Voltage detection of 90 to 1000 VAC, as well as a 24 to 90 VAC control circuit model
- Cat. IV – 1000 V overvoltage category rating for added user protection
- **Covered by a two-year warranty**



IA216



Model No.	Mfg. No.	Description	Price /Each
IA156	1-AC-A1-II	ACV Detector, 90-1000 V	
IA216	1LAC-A-II	Low Voltage Detector, 20-90 VAC	

ELECTRICAL DEVICES & ACCESSORIES

ELECTRICAL TAPE

- Vinyl plastic
- Excellent recovery, molds snugly to any surface
- Ideal for electrical splicing and insulation; protection against solvents and corrosion
- For use between -7°C and 80°C
- Thickness: 7 mils
- CSA approved



Priced per Roll

Model No.	Colour	Dimensions	Price /Each
XE890	Black	3/4" x 60' (18 mm x 18 m)	
XC545	Red	3/4" x 66' (18 mm x 20.1 m)	
XC546	Green	3/4" x 66' (18 mm x 20.1 m)	
XC547	Blue	3/4" x 66' (18 mm x 20.1 m)	
XC548	White	3/4" x 66' (18 mm x 20.1 m)	
XC549	Yellow	3/4" x 66' (18 mm x 20.1 m)	

TEMFLEX™ ELECTRICAL TAPE

- General purpose, flexible vinyl tape designed for indoor or short term use and bundling
- Temperature rating: 176°F/80°C
- Colour: Black
- Thickness: 7 mil
- UL and CSA approved



Priced per Roll

Model No.	Dimensions	Roll /Case	Price /Each
PC695	3/4" x 60' (19 mm x 18.3 m)	100	

SCOTCH® SUPER 88 VINYL TAPE

- All weather, premium grade vinyl tape for primary insulation up to 600 V or protective jacketing for low/medium voltage cable splices
- Aggressive adhesive and elastic backing ensures easy conformation irregular surfaces for moisture tight electrical and mechanical protection
- Will perform in a continuous temperature environment up to 220°F (105°C)
- Conformable for cold weather applications: 0°F (-18°C)
- Thickness: 7 mil
- Colour: Black
- UL and CSA approved



Priced per Roll

Model No.	Dimensions	Roll /Case	Price /Each
PC694	3/4" x 66' (19 mm x 20.1 m)	100	

SCOTCH® 130C LINERLESS RUBBER SPLICING TAPE

- Highly conformable, linerless self-bonding ethylene propylene rubber (EPR) tape for insulating all solid dielectric cables up to 69 kV
- Excellent thermal dissipation of splice heat
- Meets industry specifications, excellent physical and electrical properties
- Immediate moisture sealing and void-free buildups
- Rated up to 194°F (90°C) continuous operation and up to 266°F (130°C) short-term overload service
- Having no liner makes jobs easier and saves time
- Thickness: 30 mils



Priced per Roll

Model No.	Dimensions	Rolls/Case	Price
XC323	1" x 30'	24	

SCOTCH® SUPER 33+ VINYL TAPE

- All weather, premium grade vinyl tape for primary insulation up to 600 V or protective jacketing for low/medium voltage cable splices and repairs
- Aggressive adhesive and elastic backing ensures easy conformation to irregular surfaces for moisture tight electrical and mechanical protection
- Will perform in a continuous temperature environment up to 220°F (105°C)
- Conformable for cold weather applications: 0°F (-18°C)
- Thickness: 7 mil
- Colour: Black
- UL and CSA approved



Priced per Roll

Model No.	Dimensions	Roll /Case	Price /Each
PC693	3/4" x 66' (19 mm x 20.1 m)	100	

SCOTCH® 35 COLOUR CODING VINYL TAPE

- Premium grade vinyl electrical colour-coding tape for phase and job identification and safety
- Heavy-duty, premium grade
- Temperature rating: 220°F/105°C
- Thickness: 7 mil
- UL and CSA approved

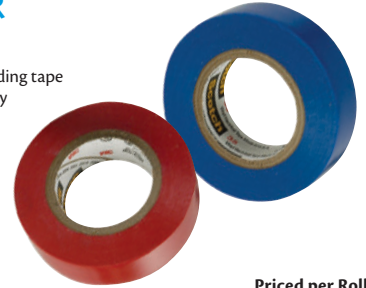

Priced per Roll

Model No.	Colour	Dimensions	Rolls /Case	Price /Each
PC696	Blue	1/2" x 20'	100	
PC720	Green	1/2" x 20'	100	
PC721	Red	1/2" x 20'	100	
PC722	White	1/2" x 20'	100	
PC723	Yellow	1/2" x 20'	100	
XC309	Orange	1/2" x 20'	100	
PE118	Blue	3/4" x 66'	100	
PE120	Green	3/4" x 66'	100	
XC312	Red	3/4" x 66'	100	
PE119	White	3/4" x 66'	100	
XC314	Yellow	3/4" x 66'	100	
XC315	Orange	3/4" x 66'	100	

SCOTCH® 27 GLASS CLOTH ELECTRICAL TAPE

- Ideal for electrical maintenance applications
- Woven glass cloth tape with a rubber thermosetting pressure-sensitive adhesive
- Edge-tear resistant, conformable, abrasion resistant
- For use as a coil cover, anchor, banding and core, layer and crossover insulation, and for heat-stable insulation for furnace and oven controls, motor leads, and switches
- Thickness: 7 mils
- UL recognized 130°C/266°F



Priced per Roll

Model No.	Dimensions	Rolls/Case	Price
XC322	3/4" x 66' (19 mm x 20.1 m)	50	

COLOURFLEX™ TAPE

- General purpose colour coding vinyl tape
- Thickness: 7 mils



Priced per Roll

Model No.	Colour	Dimensions	Roll /Case	Price /Each
XC316	Blue	3/4" x 60'	100	
XC317	Green	3/4" x 60'	100	
XC318	Red	3/4" x 60'	100	
XC319	White	3/4" x 60'	100	
XC320	Yellow	3/4" x 60'	100	
XC321	Orange	3/4" x 60'	100	



INDUSTRIAL SPECIFICATION GRADE LOCKING PLUGS & CONNECTORS

- Leviton combines the best materials available with superior production standards to produce a broad selection of Locking Devices of unmatched flexibility and dependability.
- Uncompromising industrial-grade quality for superior performance and long service life
 - All industrial locking devices feature heavy-duty, impact-resistant construction
 - Plugs and connectors accept wide range of conductors
 - Terminals clearly identified on all devices to speed and simplify wiring
 - Backed by a limited 10-year warranty
 - Certified for sale in Canada by an accredited certification body



15 A 125 V 2-POLE 3-WIRE GROUNDING

Model No.	Mfg. No.	Description	Cord Diameter"	Wire Gauge stranded	Price /Each
XA872	24W47	Wetguard Locking Plug, High Visibility Yellow EPTR Body	0.240 - 0.655	12-18	
XA873	25W47	Wetguard Locking Connector, High Visibility Yellow EPTR Body	0.240 - 0.655	12-18	

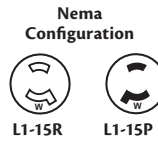

XA872



XA873

15 A 125 V 2-POLE 3-WIRE GROUNDING

Model No.	Mfg. No.	Description	Cord Diameter"	Wire Gauge stranded	Price /Each
XC172	4720-C	Black and White Locking Plug	0.245 - 0.700	10-18	
XC173	4729-C	Black and White Locking Connector	0.245 - 0.700	10-18	

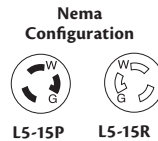

XC172



XC173

PVC GROUNDING PLUG

- Moisture and chemical resistant plastic body
- Ideal for indoor and outdoor use
- 15 A, 125 V



Model No.	Description	Nema Configuration	Colour	Cord Diameter"	Wire Gauge	Price /Each
XE672	PVC Grounding Plug	5-15P	Yellow	0.245 - 0.655	16/3 to 14/3 cords	
XE673	PVC Grounding Connector	5-15R	Yellow	0.245 - 0.655	16/3 to 14/3 cords	



XE672



XE673

COMMERCIAL GRADE STRAIGHT BLADE PLUGS

Commercial Specification Grade Straight Blade Plugs and Connectors are rugged performers. They are moisture, chemical and abuse-resistant. And they're ideal for indoor and outdoor use. All of these features and benefits are common to 15 A and 20 A Commercial Specification Grade Plugs and Connectors. TPE rubber-backed plugs and connectors stand up to rough use and protect against dirt and moisture. Deep-slotted, backed-out terminal screws draw backwire clamps securely over stripped leads for maximum conductivity.

15 A 125 V 2-POLE 3-WIRE GROUNDING

Model No.	Mfg. No.	Description	Colour	Cord Diameter"	Wire Gauge stranded	Price /Each
XA778	515PV	PVC Grounding Plug	Yellow	0.245 - 0.655	No. 18-3 thru 12-3 cords	
XA779	515CV	PVC Grounding Connector	Yellow	0.245 - 0.655	No. 18-3 thru 12-3 cords	

15 A 125 V STRAIGHT BLADE PLUGS & CONNECTORS, 2-POLE, 3-WIRE GROUNDING CONNECTORS

PLUGS				CONNECTORS		
Model No.	Mfg. No.	Description	Price /Each	Model No.	Mfg. No.	Price /Each
XA780	14W47	Wetguard, High Visibility		XA781	15W47	
XA775	5256-VY	Python, High Visibility		XA776	5259-VY	
XA777	5256-VA	Python Angle, High Visibility				

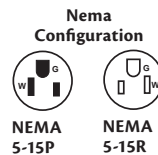

XA779



XA778

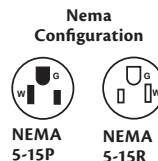

XA780



XA777



CORROSION RESISTANT DEVICES

Corrosion resistant devices are specifically designed for extremely damp and corrosive environments. They offer additional corrosive resistance because the metal parts (blades, contacts, terminals and screws) are nickel-plated. They have also passed the ASTM (B117.13) 500 hour Salt Spray (Fog) Test.

- Cord clamp seats flush with body for all cable sizes from 10-3 ST to 18-3 SVT (.245"-.700"), providing positive strain relief while preventing damage to cable jacket
- Captive, brass #8 terminal screws are colour coded for easy wiring identification: green (ground), brass (hot) and silver (neutral)

15 A 125 V 2-POLE 3-WIRE GROUNDING STRAIGHT BLADE

Model No.	Mfg. No.	Description	Nema Configuration	Price /Each
XA848	52CM-66C	Straight Blade Plug, Yellow Nylon Body and Cord Clamp	5-15P	
XA849	52CM-69C	Straight Blade Connector, Yellow Nylon Body and Cord Clamp	5-15R	

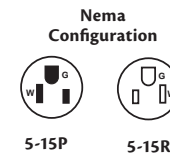

XA848

EMERGENCY LIGHTS

STELLA EXIT SIGNS

- C860 approved
- Features 120/347 VAC dual input (hardwire) and universal DC; 6 - 24 VDC or self powered
- Uses 2 W LED board
- Long life LED light source
- Knockout chevrons
- 20-gauge steel construction with baked powder coat white paint finish
- Pre-stamped universal mounting and keyhole slots on backplate

XB930



XB933



Model No.	Mfg. No.	Description	Dimensions				Price /Each
			W"	x	D"	x	
XB930	SLE-SP-L-R-U-M	Exit	12	x	2.25	x	7.5
XB933	SLS-L-R-U-M-UDC	Sortie	18.5	x	2.25	x	7.5

STELLA RUNNING MAN EXIT SIGNS

- Feature 120/347 VAC dual input (hardwire), universal DC; 6-24 VDC or self-powered
- Running Man sign uses a 2 watt LED source
- Long life LED light source
- Universal pictograms included showing left indicators, right indicators and no indicators
- 20-gauge steel construction with white baked powder coat paint finish
- Pre-stamped universal mounting and keyhole slots on backplate



XE661

Model No. XE661
Mfg. No. SL-RM-L-U-0LR-M (AC)
Price/Each \$

Model No. XE662
Mfg. No. SL-RM-SP-L-U-0LR-M (Self-powered)
Price/Each \$

Model No. XE663
Mfg. No. SL-RM-L-U-0LR-M-UDC (6-24 VDC)
Price/Each \$



TEMPESTA™ LED EMERGENCY LUMINAIRES

- Uses two LED modules that are wired in parallel
- Will only illuminate during a power failure
- LEDs are rated for 100 000 hours at L70
- Input Voltage: 120 - 347 V
- Wattage: 17 W
- High quality corrosion, flame and vandal resistant polycarbonate housing
- Comes standard with a Ni-MH battery pack that provides a minimum of 30 minutes of emergency lighting
- IP65 Rating



Model No.	Mfg. No.	Description	Dimensions				Price /Each
			L"	x	W"	x	
XE874	TA-LED-EM-120-347V-S	Surface Mounted	17	x	6 1/2	x	3 1/2
XE875	TA-LED-EM-120-347V-R	Recessed	19 1/4	x	9 1/2	x	3 1/2
XE876	TA-LED-EM-120-347V-TB	T-Bar Mount	23 3/4	x	7 1/2	x	4

STELLA COMBINATION SIGNS

- C860 approved
- LED EXIT and SORTIE models 120/347 VAC dual input (hard wire)
- Push button test switch
- Self-powered for minimum 30 minutes -6 VDC 36 W
- Solid state transfer charger
- Dual diagnostic LEDs indicate AC-ON and CHARGE
- Brownout and low voltage protection
- Two top mounted high impact thermoplastic PAR18 9 W tungsten heads
- Knockout chevrons
- 20-gauge steel construction with baked powder coat white paint finish



Model No.	Mfg. No.	Description	Price /Each
XB929	SLE-6-36-L-R-U-M-2SR/9W	Exit	
XB932	SLS-6-36-L-R-U-M-2SR/9W	Sortie	

REPLACEMENT BULB

XB338	LP104	9 W Tungsten
-------	-------	--------------

STELLA RUNNING MAN COMBO EXIT SIGNS

- Running Man models are supplied with 120/347 VAC dual input (hardwire)
- Push button test switch
- Self-powered for minimum 30 minutes - 6V DC 36W
- Solid state transfer charger
- Dual diagnostic LEDs indicate AC-ON and CHARGE
- Brownout and low voltage protection
- Two top mounted high impact thermoplastic PAR18 9-watt tungsten heads
- Universal pictograms included showing left indicators, right indicators and no indicators
- 20-gauge steel construction with white baked powder coat paint finish
- Certified for sale in Canada by an accredited certification body



Model No. XE664
Mfg. No. SL-RM-6-36-L-U-0LR-M-2SR/9W
Price/Each \$

ILLUMINA® BS100 SERIES IP66 VAPOR-TIGHT

- Lightweight, durable 100% corrosion, flame and vandal resistant polycarbonate construction
- Designed to be resilient, highly efficient and easy to install
- For ceiling, wall, suspension and pendant installations
- UV stabilized to reduce the yellowing index
- Liquid silicone memory retention gasket allows for installations in wet locations
- Incorporates a "dual concave" parabolic high-output, metallized reflector
- Also approved for through wiring application



Model No.	Mfg. No.	Volts	Price /Each
XC441	BS10048T8232AC120V	120	
XC442	BS10048T8232AC347V	347	

NOVA EMERGENCY LIGHTING UNITS

- 120/277/347 VAC input
- Push button test switch
- Dual diagnostic LEDs indicate AC-ON and CHARGE
- Solid state transfer charger
- Brownout and low voltage protection
- Two top mounted high impact thermoplastic PAR18 9 W tungsten heads
- 20-gauge steel construction with baked powder coat white paint finish
- Pre-stamped universal mounting and keyhole slots
- Output 6 VDC or 12 VDC at rated wattage for 30 minutes
- Batteries included



XA440



XA439



XA190



Model No.	Mfg. No.	Replacement Batteries	Voltage Output	Watts Output				Price /Each
				1/2 hr.	1 hr.	1 1/2 hr.	2 hr.	
XA190	NV-636/2SR	XA604	6	36	18	12	9	
XA438	NV-650/2SR	XB921	6	50	25	17	12	
XA439	NV-680/2SR	XA605	6	80	40	26	20	
XA440*	NV1272/2SR	XA604	12	72	36	24	18	
XA441*	NV12120/2SR	XA605	12	120	80	65	25	
XA442*	NV12150/2SR	XA605	12	150	80	65	40	
XA443*	NV12180/2SR	XB922	12	180	100	60	45	
XA444**	NV12250/2SR	XB922	12	250	125	83	62	
XA445	NV12360/2SR	XA606	12	360	180	120	90	
REPLACEMENT BULB			Description					
XB338	LP104			9 W Tungsten				

* Two batteries required

** Three batteries required

NEMA12 EMERGENCY LIGHTING UNITS

- NEMA12 rated – water and dust tight units
- 120/277/347 VAC input
- Push button test switch
- Dual diagnostic LEDs indicate AC-ON and CHARGE
- Solid state transfer charger
- Brownout and low voltage protection
- Two top mounted, high impact thermoplastic PAR36 9 W weatherproof heads
- 20-gauge steel housing in industrial grey fibreglass finish
- Pre-stamped mounting holes
- Output 6 V or 12 VDC at rated wattage for 30 minutes
- Batteries included



SEG853



Model No.	Mfg. No.	Replacement Batteries	Voltage	Watts Output			Price /Each
				1/2 hr.	1 hr.	1 1/2 hr. 2 hr.	
SEG853	LDT-636/2LR-9w	XA604	6 VDC	36	18	9	0
SEG854	LDT-680/2LR-9w	XA605	6 VDC	80	40	20	10
SEG855*	LDT-1272/2LR-9w	XA604	12 VDC	72	36	18	9
REPLACEMENT BULB			Description				
XB338	LP104			9 W Tungsten			

* Two batteries required

SEALED LEAD ACID BATTERIES



XB922



XA604

Model No.	Mfg. No.	Description	Price /Each
XA604	BA-6-5.0BB	6 V, 5 Ampere-Hour	
XA605	BA-6-12.0BB	6 V, 12 Ampere-Hour	
XA606	BA-12-32.0BB	12 V, 32 Ampere-Hour	
XB921	BA-6-7.2BB	6 V, 7.2 Ampere-Hour	
XB922	BA-12-7.2BB	12 V, 7.2 Ampere-Hour	

MATRIX INDUSTRIAL PRODUCTS

Maintain the ideal temperature in your workplace.

FLASHLIGHTS & BATTERIES

ENERGIZER® BATTERIES

ALKALINE



XB872



XB875



XB876



XC001

SILVER OXIDE



XB992



XB944

LITHIUM



XC015



XC012



XC007



XC008



XE736

GARAGE DOOR



XB995

NIMH RECHARGEABLE



XC017



XC016



XC019



XC018

Energizer

Model No.	Mfg. No.	Description	Qty /Pkg.	Price /Package
ALKALINE INDUSTRIAL				
XB873	EN92	AAA/1.5 V	24	
XB872	EN91	AA/1.5 V	24	
XB874	EN93	C/1.5 V	12	
XB875	EN95	D/1.5 V	12	
XB876	EN22	9 V	12	

Model No.	Mfg. No.	Description	Qty /Pkg.	Price /Package
ALKALINE				
XC001	E96BP2	AAAA/1.5 V/ E2	2	
XA430	529	Lantern, 6 V, Spring	1	
XH110	A76BPZ	1.5 V, Instruments	1	

Model No.	Mfg. No.	Description	Qty /Pkg.	Price /Package
SILVER OXIDE				
XB992	357BP	1.55 V, 11.6 mm x 5.4 mm	1	
XB993	377BP	1.5 V, 6.8 mm x 2.6 mm	1	
XB994	392BP2	1.5 V, 7.9 mm x 3.6 mm	1	
XB944	EPX76P2	1.55 V, 11.6 mm x 5.4 mm	1	

Model No.	Mfg. No.	Description	Qty /Pkg.	Price /Package
LITHIUM				
XC002	ECR2016BP	Coin Type, 3 V, CR2016	1	
XC003	ECR2025BP	Coin Type, 3 V, CR2025	1	
XC004	ECR2032BP	Coin Type, 3 V, CR2032	1	
XC005	ECR2450BP	Coin Type, 3 V, CR2450	1	
XC006	EL123APBP	Photo, 3 V, 123	1	
XC007	EL1CR2BP	Photo, 3 V, 1CR	1	
XC008	EL223APBP	Photo, 6 V, 223	1	
XC009	EL2CR5BP	Photo, 6 V, 2CR5	1	
XE736	LS22BP	9 V	1	
XC012	L91BP2	AA/1.5 V	2	
XC013	L91BP4	AA/1.5 V	4	
XC015	L92BP2	AAA/1.5 V	2	

Model No.	Mfg. No.	Description	Qty /Pkg.	Price /Package
NIMH RECHARGEABLE				
XC016	NH12BP2	AAA	2	
XC017	NH15BP4	AA	4	
XC018	NH22NBP	9 V	1	
XC019	NH35BP2	C	2	
XC020	NH50BP2	D	2	

Model No.	Mfg. No.	Description	Qty /Pkg.	Price /Package
GARAGE DOOR				
XB995	A23BP	12 V	1	

ULTRA PRO™ ALKALINE INDUSTRIAL BATTERIES

- Reclosable container helps organize and protect batteries from damage
- 10-year power guarantee in storage
- Voltage: 1.5 V



XC845



Model No.	Mfg. No.	Battery Type	Qty /Pkg.	Price /Package
XC845	ALAA-24PPJ	AA	24	
XC844	ALAA-18J	AAA	18	

BATTERY CHARGERS

XE457

- Charges: AA, AAA
- Comes with four AA NiMH batteries
- Ideal for travelling and digital cameras
- Auto shut off
- Energy Star



XE457

XD021

- Charges two or four AA or AAA NiMH rechargeable batteries
- Easy-to-read charge status indicators
- Fold-out plug for easy storage
- Includes two AA NiMH batteries



XD021

Energizer

Model No.	Mfg. No.	Description	Charge Time	Price /Each
XE457	CHPROWB4	Overnight, Compact Charger	2 or 4 AA - 3 hours 2 or 4 AAA - 3 hours	
XD021	CHVCWB2	Basic Charger	2 or 4 AA - 12 to 14 hours 2 or 4 AAA - 6 to 9 hours	

ANALOG BATTERY TESTER

- Compatible with the majority of standard household batteries
- Analog scale displays the capacity of the battery instantly (Replace, Low, Good)
- No batteries required to operate
- Battery Type(s): AAA, AA, C, D, 9V
- Voltage: 1.5 V

Model No. XF613
Price/Each \$



aurora tools®



MAGLITE® MINI

MINI MAGLITE® AA-CELL

- High-strength aluminum alloy case
- 1/2 turn, twist focus, spot-to-flood
- Candle mode for convenient hands free light
- Spare lamp safely secured in the tail cap
- O-ring sealed for water resistance
- Super-bright Xenon Lamp™
- Includes 2 AA alkaline batteries in all package types

MINI MAGLITE® AAA-CELL

- High-strength aluminum alloy case
- Twist focus, spot-to-flood
- Spare lamp safely secured in the tail cap
- O-ring sealed for water resistance
- **XD004**: 87 lumens LED, 116 m beam distance
- Includes: Pocket clip and 2 AAA alkaline batteries

SOLITAIRE® AAA-CELL

- High-strength aluminum alloy case
- Less than 1 oz. and about 3" in length
- Spare lamp safely secured in the tail cap
- **XD003**: 37 lumens LED, 55 m beam distance
- Includes: 1 AAA alkaline battery and key lead lanyard

XA387



XA389



XA679



Model No.	Description	Lumens	Price /Each
-----------	-------------	--------	-------------

MINI MAGLITE® AA-CELL

XA669	Blister Pack	14	
XA387	Presentation Box	14	
XA678	Holster Pack	14	
XA679	Combo Pack	14	

MINI MAGLITE® AAA-CELL & MINI MAGLITE® LED

XA680	Blister Pack	9	
XD004	LED Black, Blister Pack	87	
XA388	Presentation Box	9	

SOLITAIRE® & SOLITAIRE® LED

XA681	Black, Blister Pack	2	
XD003	LED Black, Blister Pack	37	
XA389	Black Presentation Box	2	
XA683	Blue Presentation Box	2	

REPLACEMENT BULBS

XA701	Solitaire® Replacement Bulb	-	
XA703	Replacement Bulb, fits AA and AAA	-	

BATTERIES

XB872	Replacement Batteries, AA, 24/pkg.	-	
XB873	Replacement Batteries, AAA, 24/pkg.	-	

MAGLITE® D-CELL

- Cam driven beam changes from flood to spot with a turn of the head
- Anodized aircraft aluminum with knurled grip enhances conductivity, increases durability, reduces oxidation and battery damage
- White Star krypton lamp provides 70% more light than a standard PR2 lamp
- Spare krypton lamp included in tail cap
- Rubber O-rings ensure resistance to water and shock
- Batteries not included

Model No.	Mfg. No.	Description	Lumens	Price /Each
XA384	S2D016	2 D-Cell Flashlight	27	
XA385	S3D016	3 D-Cell Flashlight	45	
XA386	S4D016	4 D-Cell Flashlight	98	

REPLACEMENT BULBS

XC955	LMXA201	Bi-Pin Xenon Bulb for 2 Cell	-	
XC956	LMXA301	Bi-Pin Xenon Bulb for 3 Cell	-	
XC940	LMXA401	Bi-Pin Xenon Bulb for 4 Cell	-	

BATTERIES

XB875	EN95	Replacement D-Cell Batteries, 12/Pkg.	-	
-------	------	---------------------------------------	---	--



MAGLITE® FLASHLIGHT ACCESSORIES



XC386



XB344



XB345



XC081



XC084



XC082



XC083



XB347



XC080



Model No.	Description	Price /Each
-----------	-------------	-------------

XB344	Belt Holster, Black Leather for 2 AA-Cell	
XB345	Belt Holster, Black Nylon for 2 AA-Cell	
XC386	Belt Holster, Camouflage Nylon for 2 AA-Cell	
XB347	Belt Holster for D-Cell	
XC080	Rubber Anti-Roll Device/Lens Holder; Red, Clear and Blue Lenses; 2 D-Cell Mounting Brackets for D-Cell	
XC081	Red, Blue and Clear Lenses; Anti-Roll Device/Lens Holder; Wrist Lanyard; Pocket Clip for 2 AA-Cell	

TRAFFIC WAND KITS W/REFLECTIVE TAPE

XC082	Red, for C-Cell and D-Cell only	
XC083	Yellow, for C-Cell and D-Cell only	
XC084	White, for C-Cell and D-Cell only	

FLASHLIGHTS & BATTERIES

MAGLITE® LED 2-CELL D FLASHLIGHTS

- Balanced Optics™ combines a highly refined reflector with a performance enhanced LED, for a brilliant adjustable beam
- Intelligent Energy Source Management balances high brightness with extended battery life
- Powerful projecting LED beam that focuses spot to flood simply by rotating the head
- Rugged, machined aluminium construction with knurled design
- Anodized inside and out for improved corrosion resistance
- Water and shock resistant
- Batteries not included
- Beam Distance: 412 m



XC240

MAGLITE® LED

Model No.	Mfg. No.	Description	Lumens	Run Time hrs.	Price /Each
XC239	ST2D016	2 D-Cell Flashlight	168	6.75	
XC240	ST3D016	3 D-Cell Flashlight	168	80	

BATTERIES

XB875	EN95	Replacement D-Cell Batteries, 12/Pkg.
-------	------	---------------------------------------

SEE PAGE 1488 FOR ENERGIZER® BATTERIES



MAGLITE® XL50™ LED FLASHLIGHTS

Delivers user-friendly, performance-oriented features in a sleek, tactical design and is driven by the next generation of Mag-LED™ technology.



FEATURES:

- 213 m powerful projecting LED beam
- 200 lumens
- "Spot-to-Flood" adjustable LED beam
- Push button tail-cap switch
- Compact, pocket size design
- Anodized for corrosion resistance and durability
- Rugged, machined aluminum body
- Intelligent Energy Source Management - continuously monitors the balance between high brightness and efficient power usage allowing for prolonged battery life

XC841



3 QUICK-CLICK SELECTABLE MODES:

- 1 Quick-click turns unit "ON" at high power
- 2 Quick clicks = Energy savings on at 25% power
- 3 Quick clicks = Emergency safety strobe
- Powered by three AAA alkaline batteries (included)

SPECIFICATIONS:

- Length: 4.8" (121.92 mm)
- Barrel diameter: 1" (25.4 mm)
- Head diameter: 1" (25.4 mm)
- Weight with batteries: 3.68 oz. (104 g)



XC843

BELT HOLSTERS FOR XL SERIES™ FLASHLIGHTS

- Rugged woven ballistic nylon
- Weather-resistant lock-stitched thread
- Click-adjustable rotating belt clip
- Accepts belts up to 1 5/8" wide
- Flashlight can be aimed while holstered
- Allows hands-free operation

MAGLITE® XL200™ LED FLASHLIGHTS

The XL200™ offers five basic, easy to use functions and advanced features and brightness of a next-generation LED.



The simple "Quick-Click" method let's the user select the desired function with motion-controlled variable power level and blink rate.

FEATURES:

- 138 m powerful projecting LED beam
- 172 lumens
- "Spot-to-Flood" adjustable LED beam
- Push button tail-cap switch
- Anodized for corrosion resistance and durability
- Rugged, machined aluminum body
- Sealed at both ends with high-grade rubber O-rings and lip seals

5 QUICK-CLICK SELECTABLE MODES:

- 1 Quick-click turns unit "ON" at high power
- 2 Quick-clicks = Emergency safety strobe
- 3 Quick-clicks = Nite Lite™ mode
- 4 Quick-clicks = Signal mode
- 5 Quick-clicks = SOS mode
- Powered by three AAA alkaline batteries (included)

SPECIFICATIONS:

- Length: 4.8" (121.92 mm)
- Barrel diameter: 1" (25.4 mm)
- Head diameter: 1" (25.4 mm)
- Weight with batteries: 3.68 oz. (104 g)



XC842

MAGLITE® LED

Model No.	Mfg. No.	Description	Lumens	Price /Each
XC841	XL50-S3016	3 Mode, AAA, LED	200	
XC842	XL200-S3016	5 Mode, AAA, LED	172	
XC843	XLXXX-A3046	Belt Holster	-	
XB873	EN92	Replacement Batteries, AAA, 24/Pkg.	-	/Pkg.

MINI MAGLITE® LED & PRO™

- Powerful projecting LED beam that focuses simply by rotating the head
- Balanced Optics™ combines a highly refined reflector with a performance enhanced LED yielding high output intensity
- Intelligent Energy Source Management allows the user choose the power level
- Multi-mode electronic switch: 100% power, 25% power, blink, SOS (XC238 only)
- Length: 6.6"
- Maglite® Pro™ offers latest generation LED
- Includes: 2 AA size alkaline batteries and belt holster



XC238



XC814

MAGLITE® LED

Model No.	Mfg. No.	Description	Lumens	Price /Each
XC238	SP2201H	Mini Maglite® LED Flashlight, 2 AA-Cell	97	
XC814	SP2P01H	Mini Maglite® LED Pro™ Flashlight, 2 AA-Cell	272	

BATTERIES

XB872	EN91	Replacement Batteries, AA, 24/Pkg.	-	/Pkg.
-------	------	------------------------------------	---	-------

MAG CHARGER® LED SYSTEM FLASHLIGHTS

- High-tech metallic reflector, combined with a tempered glass lens that delivers superior optical performance
- Durable sleek black finish, hard-anodizing inside and out for improved durability
- O-ring sealed throughout for resistance to weather and harsh environmental conditions
- Precision machined high-strength aluminum alloy case
- Individually serial numbered for identification
- NiMH rechargeable battery offers 434 m powerful projecting LED adjustable beam
- 643 lumens lasting 17 hours at low setting or 4 hours at high setting
- Quick access to your preferred functions: Full power, Power save (25%) Strobe (5/sec), SOS (Int'l Morse code), Momentary On/Off
- Length: 12 1/2"
- Weight: 2 lbs.

XD007 System (V4) Includes:
Mag Charger® flashlight, charging cradle, NiMH rechargeable battery pack, two mounting brackets, 120 V converter, mobile power adapter (12 V)



MAGLITE® LED

Use the **XD007** rechargeable system just as it is (see Function Set #1 Standard) or personalize it to meet your own needs by choosing one of the other function sets in the chart shown below.

	Function Set 1 (standard)	Function Set 2	Function Set 3	Function Set 4
1 Click	Full Power	Full Power	Momentary Full Power	Momentary Full Power
2 Clicks	Power Save	Power Save	Full Power	Full Power
3 Clicks	Strobe	SOS Signal	Power Save	Strobe

Model No.	Mfg. No.	Description	Lumens	Price /Each
XD007	RL1019	Rechargeable LED System	643	
XC849	ARXX235	Replacement NiMH Battery Pack	-	

MAG-TAC™ LED TACTICAL FLASHLIGHTS

- Three functions with tailcap switch "Quick Click" access
- Features three modes: Momentary, Full Power, Power Save
- Two power levels (Full Power for extreme brightness and Power Save for prolonged battery life)
- Momentary mode (in which the light stays on only while the switch button is being pressed)
- Detachable pocket clip
- 310 lumens
- 182-m projecting beam
- Plain bezel head
- Powered by two CR123 lithium batteries included
- Length: 5.195" (131.95 mm)

Barrel diameter:
1.050" (26.67 mm)

Head diameter:
1.050" (26.67 mm)

Weight with batteries:
4.8 oz. (136 g)



XD005

XD014

MAGLITE® LED

Model No.	Mfg. No.	Description	Lumens	Price /Each
XD005	SG2LRE6	Black, Mag-Tac™ LED	310	
XD014	SG2LRH6	Coyote Tan, Mag-Tac™ LED	310	
XD008	AG2L016	Nylon Belt Holster	-	

MAG-TAC™ LED CROWN BEZEL TACTICAL FLASHLIGHTS

- Three functions with tailcap switch "Quick Click" access
- Features three modes: Momentary, full power, strobe
- Momentary mode, light stays on only while the switch button is being pressed
- Full power mode, 320-lumen beam that can light up an object two football fields away
- Strobe mode, high-energy 12 Hz
- Detachable pocket clip
- 193-m projecting beam
- Crowned bezel head
- Powered by two CR123 lithium batteries included
- Length: 5.275" (131.95 mm)

Barrel diameter:
1.050" (26.67 mm)

Head diameter:
1.050" (26.67 mm)

Weight with batteries:
4.8 oz. (136 g)



XD006

XD015

MAGLITE® LED

Model No.	Mfg. No.	Description	Lumens	Price /Each
XD006	SG2LRA6	Black, Mag-Tac™ LED, Crown Bezel	320	
XD015	SG2LRD6	Coyote Tan, Mag-Tac™ LED, Crown Bezel	320	
XD008	AG2LR016	Nylon Belt Holster	-	

FLASHLIGHTS & BATTERIES

PROTAC® PROFESSIONAL TACTICAL LIGHTS

- 6000 Series machined aircraft aluminum with anodized finish
- Super bright C4® LED is impervious to shock and has a 50000 hour lifetime
- LED solid state power regulation provides maximum output throughout battery life
- IPX rated design; waterproof to 1 m for 30 minutes
- Ten-Tap™ programmable switch allows selection of one of three programs: High/Strobe/Low, High only or Low/High
- Includes batteries and holster



Model No.	Mfg. No.	Description	Lumens	Run Time hrs.	Battery	Price /Each
XC770	88030	ProTac® 1 L	180	2	One 3 V Lithium	
XC771	88031	ProTac® 2 L	260	3	Two 3 V Lithium	
XC773	88033	ProTac® 2 AA	155	2	2 AA Alkaline	

PROTAC® HL & HL3 TACTICAL FLASHLIGHTS

- Hand-held, lithium battery-powered programmable flashlight constructed of anodized machined aircraft aluminum
- IPX7; waterproof to 1 meter for 30 minutes
- Impact resistant to 1 meter
- Multi-function, push-button tail switch for one-handed operation
- Choice of three operating modes: 1) high/strobe/low (factory default), 2) high only, 3) low/high
- Lamp Type: C4 LED
- Model **XC954**: Includes two 3 V CR123A lithium batteries and nylon holster
- Model **XD783**: Includes three 3 V CR123A lithium batteries, removable pocket clip and nylon holster



Model No.	Mfg. No.	Description	Lumens		Run Time hrs.		Price /Each
			High	Low	High	Low	
XC954	88040	ProTac® HL	600	33	1.25	18	
XD783	88047	ProTac® HL3	1100	35	2	43	

STREAMLIGHT JR.® LED FLASHLIGHTS

- Super bright C4® LED is impervious to shock and provides up to 85 lumens
- Push-button tail switch - steady on and momentary on/off operation
- Impact-resistant/water-resistant
- **XC247** includes holster
- **XC248** includes extension cable that allows for 14" of reach, flexible cable protected by a durable PVC coating, packaged with magnetic clip holder for mounting and positioning
- **XC248**: Beam Distance: 77 m
- Includes 2 AA size alkaline batteries (also accepts 2 AA lithium batteries not included)



Model No.	Mfg. No.	Description	Lumens	Run Time hrs.	Price /Each
XC247	71500	Streamlight Jr.® LED w/Alkaline Batteries, Black	85	4	
XC248	71600	Streamlight Jr. Reach® LED Flashlight	140	4.5	
BATTERIES					
XB872	EN91	Replacement Batteries, AA Cell, 24/pkg.	-	-	/Pkg.

STYLUS® PENLIGHTS

- High intensity LED lasts 100000 hours
- Up to 24 hours of continuous run time
- **XB942** has a flexible cable making it possible to see anywhere
- Includes 3 AAAA alkaline batteries
- Black casing with pocket clip



Model No.	Mfg. No.	Description	Lumens	Price /Each
XB943	65118	Stylus® Penlight, 3.5 oz.	11	
XB942	65618	Stylus Reach® Penlight - 7" Cable, 3.5 oz.	11	

STYLUS PRO® & MICROSTREAM® PENLIGHTS

- Compact, high-powered LED penlights provide a super bright beam
- Constructed of corrosion proof, machined aircraft-grade aluminum alloy with Type II MIL-Spec anodized plating
- 30000 hour lifetime 0.5 watt LED never needs to be replaced
- Water resistant per code IPX4; in accordance with specification EN 60529:1992
- Tail switch features momentary blink and constant "on" modes
- Matte black finish



STYLUS PRO®

- Produces up to 90 lumens
- Run time: Up to 6.5 regulated hours
- Includes: 2 AAA alkaline batteries, nylon holster and pocket clip

Model No. **XC394**
Mfg. No. 66118
Price/Each \$

MICROSTREAM®

- Produces up to 45 lumens
- Run time: Up to 2.25 hours
- Includes: 1 AAA alkaline battery, pocket clip and lanyard

Model No. **XC395**
Mfg. No. 66318
Price/Each \$

TWIN-TASK® LED FLASHLIGHTS

- Super bright C4® LED is impervious to shock and has a 50000 hour lifetime
- Unbreakable polycarbonate lens
- IPX4 rated for water-resistant operation, all openings are O-ring sealed, 1 meter impact resistance tested and wrist lanyard included

TWIN-TASK® 3 AAA LASER LED

- Features: 2 hr 45 min on one LED, 5 hr 15 min on five LEDs
- Battery: 3 AAA size alkaline batteries, Output: One LED - 100 lumens, five LEDs - 68 lumens
- Pre-focused visible red laser cartridge, laser output: Useable range of over 100 yards when using laser pointer only; over 100' when in laser/C4® LED combo position

TWIN-TASK® 3 C LED

- Features: Runtime 26 hrs on one LED, 72 hrs on three LEDs and 48 hrs on six LEDs
- Battery: 3 C size alkaline batteries, Output: One LED - 180 lumens, three LEDs - 50 lumens, six LEDs - 80 lumens



Model No.	Mfg. No.	Description	Lumens	Price /Each
XC762	51043	Twin-Task® 3 AAA LED	100	
XC763	51039	Twin-Task® 3 C LED	180	

STINGER®, STINGER® LEDS, POLYSTINGER® & POLYSTINGER® LEDS

- Compact, rechargeable flashlights that are not only durable, but super bright
- Charge time: 10 hours to fully charge; 2.5 hour fast charger model available
- Push button switches on the head for momentary or constant "on-off" switching
- Includes a nickel cadmium battery that is rechargeable up to 1000 times
- Optional accessories: safety wands, 5-unit bank charger, ring holder, holster, PiggyBack® charger, coloured flip lens covers

STINGER®/POLYSTINGER®

- Feature a xenon bulb with an adjustable focus beam that provides 1.25 hour of continuous run time
- Includes a spare bulb in the tail cap
- Stinger® is constructed of aircraft machined aluminum with polycarbonate lens
- PolyStinger® is constructed of nylon polymer with non-slip rubber grip

STINGER® LED/POLYSTINGER® LED

- 4 modes of lighting: High, Medium, Low or Strobe
- Features a C4® LED that is impervious to shock and has a 50000 hour lifetime - never needs to be replaced
- Run times: **High beam** - Up to 2 continuous hours;
Medium - Up to 3.75 continuous hours;
Low - 7.25 continuous hours;
Strobe - Up to 5.5 continuous hours
- Stinger® LED constructed of aircraft machined aluminum with polycarbonate lens
- PolyStinger® LED is constructed of super-tough non-conductive nylon polymer with a non-slip rubber grip



Model No.	Mfg. No.	Description	Lumens	Approvals	Price /Each
XC396	76014	PolyStinger®	90	UL Class I, II, Div. 2	
XC397	75713	Stinger® LED	350	-	
XC480	76163	PolyStinger® LED	385	-	
XC398	75914	Bulb, Stinger®/PolyStinger®	-	-	



4AA PROPOLYMAX® HIGH-OUTPUT FLASHLIGHTS

- C4® LED technology for extreme brightness
- Impact and chemical resistant engineering polymer resin
- Unbreakable polycarbonate lens with scratch resistant coating
- Smooth parabolic reflector produces a tight beam with optimum peripheral illumination
- TEN-TAP® programmable switch allows user selection of one of three different programs
- Lamp Type: LED
- Lumens (High): 300
- Lumens (Low): 50
- Run Time Hrs. (High): 2.75
- Run Time Hrs. (Low): 24
- Beam Distance: 261 m
- 4 AA batteries included

Model No. XD492
Mfg. No. 68820
Price/Each \$



PROPOLYMER® FLASHLIGHTS

- Waterproof, non-conductive polymer casings
- Easy to use push button momentary or constant "on-off" switching
- XC051 and XC054 feature super bright, 100000 hour lifetime LEDs
- XC056 and XC477 contain a super high flux LED with a 10000 hour lifetime
- XC054, XC056 and XC477 include batteries
- XC051 has a spring loaded clip
- XC051 and XC054 are CUL Listed Class I, II, Div. 2, Class III and MSHA approved
- XC477 and XD467 are CUL Listed for Class I, II, Div. 1, Class III and MSHA approved
- XC053 and XC056 are CUL Listed for Class I, II, Div. 2, Class III
- XD304 and XD487: ANSI/UL 913 CAN/CSA C22.2 No. 157-92 intrinsically safe equipment for use in hazardous locations
- XD436: Intrinsic Safety for Haz. Loc. Class I, II, Div. 1, Groups A,B,C,D,E,F,G; Class III, T4A

STINGER LED HL® RECHARGEABLE FLASHLIGHTS

- C4® LED technology for extreme brightness
- Deep-dish parabolic reflector produces a concentrated beam with optimum peripheral illumination
- 1 metre impact resistance tested
- 120 V AC /12 V DC
- IPX4 water-resistant
- Lumens (High): 640
- Lumens (Low): 170
- Run Time Hrs. (High): 1.25
- Run Time Hrs. (Low): 4
- Beam Distance: 297 m
- Comes with 2 holders
- 1 rechargeable battery included



Model No.	Mfg. No.	Description	Price /Each
XD617	75430	Stinger LED HL® Rechargeable Flashlights	



Model No.	Mfg. No.	Description	Lumens	Price /Each
XC051	33202	3 C LED, 336 Hours of Continuous Run Time	85	
XC054*	68202	4 AA LED, 155 Hours of Continuous Run Time	85	
XC056*	68244	4 AA Lux LED, Div. 2, 4 Hours with 2 Additional Hours of Declining Usable Light	34	
XD436	62202	3 "N" Size Alkaline, LED, 120 Hours of Continuous Run Time	30	
XD467*	67101	2 AA LED, HAZ-LO®, 24 Hours of Continuous Run Time	65	
XD487	68720	3 AA LED, HAZ-LO®, 6.5 Hours of Continuous Run Time	120	
XD304	33820	3 C LED, HAZ-LO®, 18 Hours of Continuous Run Time	150	

* Batteries included

FLASHLIGHTS & BATTERIES

MITYLITE™ 1900

- Made of unbreakable space age hi-impact polycarbonate resin
- 4.09" in length
- Xenon lamp module provides 7.0 lumens of power
- Equipped with a shirt clip, making it easy to fit into pockets, purses, tool kits, camera bags or glove compartments
- Submersible with a twist on shroud
- Includes 2 AAA alkaline batteries



APPROVALS

CSA: Class I, Div. 2, Groups ABCD, T3C
Class II, Div. 2, Group G
IEC EX: Ex ib e IIC T4 IP67 IEC Ex TSA 06.0021X



Model No.	Mfg. No.	Description	Lumens	Price /Each
XA027	1900-015-245	Mitylite™ 1900	7	
XA018	1900-350-000	Replacement Bulb	-	

MITYLITE™ 2340

- 6 1/4" in length and equipped with a handy tail button switch
- Made of an unbreakable chemical resistant resin with a polycarbonate lens and thermoplastic rubber shroud
- Includes a pre-focused xenon lamp module, shirt clip and 2 AA-cell Energizer® alkaline batteries
- Non-submersible



APPROVALS

CSA: Class I, Div. 2, Groups ABCD, T3C
Class II, Div. 2, Group G
FM: Class I, Div. 2, Groups ABCD, T3A
MSHA: 10C-637-0
IEC EX: Ex ib e IIC T4 IP67 IEC EX TSA 06.0021x



Model No.	Mfg. No.	Description	Lumens	Price /Each
XB349	2340-010-110	Black	10	
XB350	2340-010-245	Yellow	10	
XB351	2300-350-000	Replacement Bulb	-	

BATTERIES

XB872	EN91	Replacement Batteries, AA-Cell, 24/Pkg.	-	/Pkg.
-------	------	---	---	-------

VB3™ 2220 LED FLASHLIGHTS

- Dual super bright white LEDs
- Lumens: 9
- Run Time Hrs.: 34
- Beam Distance: 12 m
- Light turns on when the head is flipped up
- Pivots to a full 180°
- Built-in clip attaches to surfaces up to 1/2" thick
- 2 CR2032 3 V Lithium coin cells included
- IPX4 Water resistant

XC805



Model No.	Mfg. No.	Colour	Price /Each
XC805	2220-010-110	Black	
XE300	2220-010-245	Yellow	

1930 L1™ LED LIGHTS

- Water resistant light provides a concentrated close quarter beam
- Provides up to 50000 hours of usage
- Four replaceable LR 44 alkaline coin cells (included)
- Offers up to 130 hours of battery life
- Lumens: 12
- Equipped with a neck lanyard and a handy push button on/off switch
- Colour: Black



APPROVALS

UL: Class I, Div. 1, Groups ABCD
IECEX: Ex ia IIC T4 IP65

Model No. XB352
Mfg. No. 1930-010-110
Price/Each \$



3315 COMPACT LED FLASHLIGHTS

- Compact, rugged and lightweight
- Constructed of high impact ABS
- 113 lumens, 9 h 45 m runtime
- Powered by three AA alkaline batteries (included)
- Water resistant IPX4
- Class I II III, Div. 1, GP. ABCDEFG T4 Exia



Model No.	Mfg. No.	Description	Lumens	Price /Each
XD018	033150-0150-110	Black, 3315 Compact LED Flashlight	113	
XD019	033150-0150-245	Yellow, 3315 Compact LED Flashlight	113	
XB872	EN91	Replacement Batteries, AA-Cell, 24/Pkg	-	/Pkg.

RIGHT ANGLE 3715 LED FLASHLIGHTS

- Compact, rugged and lightweight
- Featuring downcast LEDs for illuminating your path
- 4-mode unit:
 - High** - 174 lumens, 4 h 45 m runtime
 - Low** - 95 lumens, 8 h 30 m runtime
 - Signaling mode** - 142 lumens, 31-hour runtime
 - Downcast** - 32 lumens, 10-hour runtime
- Built-in battery life indicator
- Powered by four AA alkaline batteries (not included)
- Water-resistant IPX4
- Class I, Div. 1 Groups ABCD
Operating Temp. Class T4



Model No.	Mfg. No.	Description	Lumens	Price /Each
XD016	3715-000-110	Black, Right Angle 3715 LED Flashlight	174	
XD017	3715-000-245	Yellow, Right Angle 3715 LED Flashlight	174	
XB872	EN91	Replacement Batteries, AA-Cell, 24/Pkg.	-	/Pkg.

COAST® G20 PENLIGHT

- Impact and weather resistant
- Tested and rated to ANSI/FL1 standards
- Pocket clip included
- Lamp Type: LED
- Run Time Hrs. (High): 10
- Material: Aluminum
- Battery Type: AAA
- Beam Distance (High): 22 m
- Batteries Included
- Beam Optic: Inspection Beam



COAST®

Model No.	Mfg. No.	Colour	Price /Each
XE980	20254	Black	
XE984	21508	Orange	
XE983	21507	Green	
XE982	21506	Blue	
XE981	21505	Red	

COAST® HP7 FLASHLIGHT

- Anti-roll feature allows the flashlight to be on an uneven surfaces without running the risk of it rolling off
- Tested and rated to ANSI/FL1 standards
- Lamp Type: LED
- Lumens (High): 410
- Run Time Hrs. (High): 2
- Body Material: Aluminum
- Battery Type: AAA
- Beam Distance (High): 229 m
- Batteries Included
- Modes: High, medium, and low

Model No. XE965
Mfg. No. 20406
Price/Each \$



COAST® FL60 HEADLAMP

- Hinged beam allows for quick and easy light beam adjustment
- Hardhat compatible
- Reflective strap provides additional visibility on low lighting
- Tested and rated to ANSI/FL1 standards
- Lamp Type: LED
- Lumens (High): 400
- Run Time Hrs. (High): 2.75
- Battery Type: AAA
- Beam Distance (High): 32 m
- Batteries Included
- Modes: High, medium and low

Model No. XF001
Mfg. No. 20688
Price/Each \$



PELICAN™ 2750 HEADLAMP

- Bright and compact headlamp that features a night vision friendly red LED
- Designed with weather resistant casing which allows for fast and easy battery change
- Can be operated in high, low, or flashing mode
- Lamp Type: LED
- Lumens (High): 193
- Run Time Hrs. (High): 3
- Beam Distance (High): 98 m
- Batteries Included
- Number of Batteries Required: 3 AAA
- Water Resistance: IPX4



Model No.	Mfg. No.	Colour	Price /Each
XE232	027500-0102-110	Black	
XE900	027500-0102-247	Photoluminescent	

COAST® FL60 HEADLAMP

- Features gesture activation control
- Can be operated in high, signaling, or night vision red LED mode
- Rubber head strap included
- Optical 4x magnification allows for a wide or penetrating beam
- Lamp Type: LED
- Lumens (High): 200
- Run Time Hrs. (High): 3
- Beam Distance (High): 82 m
- Batteries Included
- Number of Batteries Required: 3 AAA
- Water Resistance: IPX4

Model No. XE236
Mfg. No. 027200-0101-110
Price/Each \$



PELICAN™ 2765 HEADLAMP

- Safety approved headlamp designed for use in hazardous environments
- Ultra compact and lightweight
- Class I - Division 1 approved
- Can be operated in high, low, downcast, or flashing mode
- Lamp Type: LED
- Lumens (High): 105
- Run Time Hrs. (High): 4.25
- Beam Distance (High): 107 m
- Batteries Included
- Number of Batteries Required: 3 AAA
- Water Resistance: IPX4



Model No.	Mfg. No.	Colour	Price /Each
XE905	027650-0100-110	Black	
XE906	027650-0100-245	Yellow	



Safety Products for Industry



FLASHLIGHTS & BATTERIES

KNUCKLEHEAD® SPOT LED FLASHLIGHTS

- Shockproof C4® premium LED technology
- Deep dish parabolic reflector produces a focused beam for longer distances: 210 m on high beam
- Durable spring-loaded clip for easy attachment to turnout gear and uneven surfaces
- Features a 210° articulating head that rotates a full 360°
- Four modes:

High: 11,000-candela peak beam intensity, 180 lumens, 3.5-hour runtime

Low: 3300-candela peak beam intensity, 55 lumens, 16-hour runtime

Moonlight: 20-day runtime

Flash: 8-hour runtime

- Dual power source: accepts rechargeable NiCad battery pack or four AA alkaline batteries
- Rubber dome push-button actuator is easy to operate even when wearing heavy gloves
- Removable magnet with 135-lb. pull strength features a replaceable rubber boot
- Optimized electronics provide regulated intensity
- High-impact, super-tough nylon polymer construction for exceptional durability
- 2-m impact-resistance tested
- IPX4-rated for water-resistance



Model No.	Mfg No.	Description	Lumens	Price /Each
XD010	90757	Knucklehead® Spot 120 V AC/12 V DC, Orange	180	
XD011	90761	Knucklehead® Spot 120 V Fast Charge, Orange	180	
XD012	90770	Knucklehead® Spot 12 V Fast Charge, Orange	180	
XD013	90011	AC Fast Charger (Includes Holder)	-	
XC404	90338	NiCad Battery Pack, (Rechargeable), Div. 2	-	
XC405	90542	Alkaline Battery Pack (Batteries Not Included)	-	
XB872	EN91	Replacement Alkaline Batteries, AA, 24/Pkg.	-	/Pkg.

KNUCKLEHEAD® FLOOD LED FLASHLIGHTS

- High-impact super-tough nylon offering exceptional durability
- Super-bright C4® LED is impervious to shock and has a 50 000 hour lifetime
- IPX4-rated for water resistant operations
- All openings O-ring sealed
- Full 360° rotation head with 210° of articulation
- Removable magnet with 135-lb. pull strength and integrated hook
- Lens is an unbreakable polycarbonate with silicone anti-scratch coating and is assembled in a heavy-duty bezel
- **XD862:** AC/DC - Class I, Div. 1 approved for hazardous locations
- **XD863:** Class I, Div. 1 approved for hazardous locations
- **XD863** includes 4 AA alkaline batteries
- Charger meets requirements of NFPA 1901-14.1.11.2 (2003) mounted in any position



Model No.	Mfg. No.	Battery	Lumens	Price /Each
XC766	90627	Industrial Rechargeable Nickel-Cadmium 4.8 V Can be Charged Up to 1000 Times	200	
XC767	90642	4 AA Alkaline Non-Rechargeable Battery Pack	200	
XD862	91627	HAZ-LO® Rechargeable Worklight	163	
XD863	91642	HAZ-LO® Worklight	163	
ACCESSORIES				
XC823	90400	Bank of 5 Chargers 120 V AC for XC766 & XD862	-	

SURVIVOR®

- Brightest right-angle LED flashlight available
 - Features a C4® LED with a 405 m. range and optimal peripheral illumination
 - LED produces up to 175 lumens and has a 50 000 hour lifetime
 - Raised push button switch features: High, Low, Flash and moonlight
 - Run time (rechargeable):
- High** 3.5 hours; **Low** 13 hours; **Flash** 5 hours; **Moonlight** 20 days
- Run time (alkaline): **High** 4 hours; **Low** 15 hours; **Flash** 8 hours; **Moonlight** 20 days
 - Constructed of high-impact, super-tough nylon for durability and O-ring sealed for water-resistance
 - Unbreakable polycarbonate lens with silicone anti-scratch coating
 - Rechargeable models also include alkaline battery pack (alkaline batteries not included)
 - Operates on 4 AA alkaline or rechargeable NiCad battery pack
 - Serialized for easy identification
 - UL Approved for Class I, Div. 1, Groups C, D; Class I, Div. 2, Groups A, B, C, D; Class II Div. 11, Groups F, G, Class III, T4, MSHA alkaline only



XC401

XC403



Model No.	Mfg. No.	Description	Lumens		Colour	Price /Each
			High	Low		
XC400	90513	Survivor® Rechargeable	175	60	Yellow	
XC401	90503	Survivor® Rechargeable	175	60	Orange	
XC402	90540	Survivor® Alkaline	175	60	Orange	
XC403	90541	Survivor® Alkaline	175	60	Yellow	
XC404	90338	NiCad Battery Pack (Rechargeable), Div 2	-	-	-	
XC405	90542	Alkaline Battery Pack (Batteries Not Included)	-	-	-	

POLYTAC 90® COMPACT LIGHTS

- High-impact, super tough nylon offering exceptional durability
- Super-bright C4® LED is impervious to shock and has a 50 000 hour lifetime
- IPX7 rated design; waterproof to 1 m for 30 minutes
- Lens is glass and gasket sealed
- 90° head, integrated carabineer style D-ring for a variety of attachment methods fully rotatable/reversible/removable clip to allow for a variety of mounting positions
- Head-mounted, push-button switch provides one-handed momentary or constant on operation
- Gear keeper tool lanyard tether features spectra nylon line with 36" extension 6 oz. retraction force
- Includes two 3 V CR123A lithium batteries



XC774

XC775



Model No.	Mfg. No.	Description	Lumens	Colour	Price /Each
XC775	88831	PolyTac 90® Compact Light	170	Yellow	
XC774	88832	PolyTac 90® Light w/ Gear Keeper	170	Orange	
XC776	88833	Gear Keeper Tool Lanyard	-	Black	
XC006	EL123APBP	Replacement 3 V Lithium Batteries	-	-	

E-FLOOD® LITEBOX® RECHARGEABLE LANTERNS

- Produces up to 4000 candelas and has 615 lumens on high power
- IPX4-rated design for weather resistant operation
- Fits existing Streamlight LiteBox® racks
- Six LEDs produce a smooth flood pattern
- Battery is a zero maintenance 6 V, 12 Ah sealed lead acid and is rechargeable up to 500 times
- Red and green LEDs provide charge status
- Charge rack meets requirements of NFPA standard 1901-14.1.11.2 (2003) mounted in any position



Model No.	Mfg. No.	Colour	Lumens	Price /Each
XC757	45801	Orange	615	
XC758	45821	Yellow	615	
XD384	45817	Beige	615	

WAYPOINT® PISTOL GRIP SPOTLIGHTS

- C4® LED technology, with a 50 000 hour lifetime
- Three modes of lighting: High, low and emergency signal
- IPX4 rated design for water resistant operation
- Integrated stand for hands-free scene lighting
- Unbreakable polycarbonate lens
- **XC764** and **XC765**: Powered by 4 "C" batteries (not included) or 12 V DC power cord (included)
- Run time (**XC764** and **XC765**): High 10 hrs.; 12 V DC power cord: Unlimited
- Run time (**XD331** and **XD332**): High 3 hrs.



Model No.	Mfg. No.	Lumens	Description	Colour	Price /Each
XC764	44900	550	Spotlight, Alkaline Batteries	Yellow	
XC765	44902	550	Spotlight, Alkaline Batteries	Black	
XB874	EN93	-	Replacement batteries, C-cell, 12/pkg.	-	/pkg
XD331	44910	1000	Spotlight, Rechargeable	Yellow	
XD332	44911	1000	Spotlight, Rechargeable	Black	

FIRE VULCAN® LED

- Lightweight, waterproof lantern features super bright C4® LED technology and two blue taillight LEDs that provide illumination both in front of and behind the lantern
- C4® LED produces up to 80 000 Candela (Peak Beam Intensity), is impervious to shock and has a 50 000 hour lifetime
- The 2 ultra-bright blue taillight LEDs can be seen through thick smoke
- Run times: Steady LED and taillights - Up to 3 hours to the 10% output level (High) and up to 7 hours (Low)
- High power 145 lumens; low power 70 lumens
- 8 total programmable functions - 4 functions when toggle switch in "left" position and 4 functions when toggle switch is in "right" position
- IPX7 rated design - waterproof to 1 meter for 30 minutes; lantern floats
- Raised handle and toggle "on-off" switch ensure ease of use with a gloved hand
- Super lightweight lithium ion battery recharges in 5 hours
- Includes shoulder strap, AC/DC charge cords and charging rack
- Class I, Div. 2, Groups A, B, C, D; Class II, Div. 2, Groups F, G; Class III T-Code: T4
- Rack meets requirements of NFPA standard 1901-14.1.11.2 (2003) mounted in any position



Model No. XC406 Mfg No. 44450
Price/Each \$

E-SPOT® LITEBOX® RECHARGEABLE LANTERNS

- Uses three LEDs and deep-dish parabolic reflectors to produce a large spot pattern
- Run time: High - up to 7 continuous hours; Low - up to 15 continuous hours
- Produces up to 55 000 candelas and has 540 lumens on high power
- IPX4 rated design for weather resistant operation
- Fits existing Streamlight LiteBox® racks
- Includes 6 V, 12 Ah sealed lead acid rechargeable battery; rechargeable up to 500 times
- Rack meets requirements of NFPA standard 1901-14.1.11.2 (2003) mounted in any position



Model No.	Mfg. No.	Lumens	Colour	Price /Each
XC759	45851	540	Orange	
XC760	45871	540	Yellow	

SABRELITE® 2000

- Watertight to 500'
- Made out of unbreakable ABS material with a hi-impact polycarbonate lens
- Has an exclusive state-of-the-art xenon lamp module that produces a tightly focused collimated white light beam with 33 lumens of power
- Safe to be used in gaseous or electrical hazardous environments
- Requires 3 C-cell (batteries not included)
- Length: 7.79"
- Includes: Belt spring clip, stainless steel split ring and black lanyard



APPROVALS

FM: Class I, II, Div. 2, Groups ABCD/G, T3C
MSHA: 10C-629-2
CSA: Class I, Div. 2, Groups ABCD, T3C
Class II, Div. 2, Group G
IEC EX: Ex e IIC T4 IP67
UL: Class I, Div. 1, Groups CD,
Class I, Zone I, Groups IIA, IIB, T3C



Model No.	Mfg. No.	Description	Lumens	Price /Each
XA129	2000-010-245	Yellow	33	
XA130	2000-010-110	Black	33	
XA012	2000-351-000	Replacement Bulb	-	

STEALTHLITE™ 2400

- This 4 AA-cell flashlight is water resistant with an unbreakable corrosion proof ABS body and hi-impact polycarbonate lens
- Xenon lamp module gives an unsurpassed white collimated beam
- Has a one handed on/off locking switch plus a heavy-duty lanyard
- Safe to be used in gaseous or electrical hazardous environments
- Colour: Orange



APPROVALS

FM: Class I, Div. 2, Groups ABCD, T3A
MSHA: 10C-633-0
CSA: Class I, Div. 2, Groups ABCD, T3C
Class II, Div. 2, Group G
UL: Class I, Div. 1, Group D, Zone 1, IIA, T3
Ex (CE): II 3 GD EEx n IIC T5 sni 135°C



Model No.	Mfg. No.	Description	Lumens	Price /Each
XA026	2400-010-150	StealthLite™ 2400	45	
XA019	2400-351-000	Replacement Bulb	-	
BATTERIES				
XB872	EN91	Replacement Batteries, AA-Cell, 24/Pkg.	-	/Pkg.

FLASHLIGHTS & BATTERIES

AFL100 LED FLASHLIGHTS

- Super bright LED bulb
- Polypropylene body resists grease and chemicals
- Shatterproof lens
- Ribbed non-slip barrel
- Hi-Viz yellow colour for easy visibility
- Batteries not included



aurora tools®

Model No.	Mfg. No.	Description	Lumens	Price /Each
XC977	LA765A	Flashlight, 2 AA-Cells	28	/Pkg.
XB872	EN91	Replacement Batteries AA-Cell, 24/Pkg.	-	
XC978	LA765C	Flashlight, 2 D-Cells	35	/Pkg.
XB875	EN95	Replacement D-Cell Batteries, 12/Pkg.	-	

AFL300 LED FLASHLIGHTS

- High strength aluminum casing
- Shatterproof lens
- Run Time Hrs. (High): 2
- Batteries included
- Battery Type: AAA
- Colour: Black
- Beam Distance (High): 35 m
- Lumens (High): 98



XE888



XE889

aurora tools®

Model No.	Description	Price /Each
XE888	28 LED Bulb	
XE889	45 LED Bulb	

ENERGIZER® 2-AA VISION HD FLASHLIGHT

- Can be used on high, power-saver and emergency strobe modes
- Includes two Energizer® AA batteries
- Survives drops up to 1 metre
- Lamp Type: LED
- Run Time Hrs. (High): 4
- Body Material: Aluminum
- Battery Type: AA
- Beam Distance (High): 115 m
- Water Resistance Rating: IPX4



Energizer

Model No.	Description	Lumens (High)	Price /Each
XG796	HD Flashlight	400	

LED RUBBER FLASHLIGHTS

- Two bright Nichia LED's
- 22 lumens, 16-hour runtime
- Focusing lens projects a precise spot
- Push button switch
- Built-in stand
- Non-roll foot
- Includes two AA Energizer® batteries



Energizer

Model No.	Mfg. No.	Description	Lumens	Price /Each
XC958	ENRUB21E	Black, 3315 Compact LED Flashlight	22	/Pkg.
XB872	EN91	Replacement Batteries AA-Cell, 24/Pkg.	-	

AFL200 MINI LED FLASHLIGHTS

- Nine ultra bright LED lights
- High-strength aluminum casing
- On/Off switch
- Lightweight design
- Rugged impact resistant housing
- Includes wrist strap and three AAA alkaline batteries



aurora tools®

Model No.	Mfg. No.	Description	Lumens	Price /Each
XD079	LA671	Mini LED Flashlight	25	

LED HEADLAMP

- Head angle is adjustable
- Adjustable in/out zoom
- Water resistant
- 3 settings: High, Low and Strobe
- Batteries Required: 3 AAA
- Run Time Hrs. (High): 6
- Beam Distance (High): 120 m
- Batteries not included



aurora tools®

Model No.	Description	Lumens (High)	Price /Each
XE887	LED Headlamp	120	

INDUSTRIAL LED FLASHLIGHT

- Run Time Hrs. (High): 113
- Battery Type: D
- Colour: Yellow
- Batteries Required: 2 x D



EVEREADY

Model No.	Mfg. No.	Description	Lumens (High)	Price /Each
XD071	1251L	Industrial LED Flashlight	35	

CONTRACTOR® SERIES INTRINSICALLY SAFE LIGHTS

- Designed to meet the needs of hazardous work environments by combining the major performance advantages of LED without sacrificing brightness
- Chemical-resistant, anti-static polyethylene construction
- Carabiner belt hook on tall cap
- Survives 7' drop test
- CUL 913 Certified Intrinsically Safe for Class I, Groups A, B, C and D; Class II, Groups E, F and G; Class III
- CAN/CSA C22.2 No. 157-92
- IEC 60529 waterproof and dustproof
- AA batteries not included



Energizer

Model No.	Mfg. No.	Description	Avg life	Lumens	Price /Each
XC324	MS2AALED	Three White Nichia CS	20 hrs	40	/Pkg.
XB872	EN91	Replacement Batteries AA-Cell, 24/Pkg.	-	-	

LED FLASHLIGHTS

- Cutting edge Recoil™ LED Technology™, up to 33 times brighter than regular LED lights
- Focuses the light by firing backwards; 100% of the light is captured and reflected forward



SABRELITE™ 2010 LED

- Rugged, lightweight Xenon® body
- White collimated beam as bright as an incandescent light
- 161 lumens
- Submersible
- Powered by three C-cell alkaline batteries, not included



XC062

APPROVALS

Class I Div. 1
Class II Div. 1
Class III Div. 1
IECEX ia

STEALTHLITE™ 2410 LED

- ABS body with polycarbonate lens
- One-handed safety switch operation
- 126 lumens
- Submersible to 500'
- Powered by four AA-cell alkaline batteries, included



XC066

APPROVALS

FM: Class I, Div. 2, Groups ABCD, T4A
Class II, Div. 2, Groups FG

Model No.	Mfg. No.	Description	Lumens	Price /Each
SABRELITE™ 2010 LED				
XC061	2010-016-110	Black	161	
XC062	2010-016-245	Yellow	161	
XB874	EN93	Replacement C-Cell Batteries, 12/pkg.	-	/Pkg.
STEALTHLITE™ 2410 LED				
XC066	2410-016-110	Black	126	
XC067	2410-016-245	Yellow	126	
XB872	EN91	Replacement AA-Cell Batteries, 24/pkg.	-	/Pkg.

PORTABLE RECHARGEABLE LED SCENE LIGHTS

- Six C4® LEDs and wide pattern parabolic reflectors produce a smooth flood pattern
- Indefinite run time with 12 V power cord
- 3 levels of lighting
- Wattage: 36 W
- Stabilization legs provide balance on uneven surfaces
- 90° swivel neck allows you to aim the beam where you need it for task lighting
- Packs to a compact size for easy storage
- Pole extends to 72"
- Weatherproof construction



Model No.	Mfg. No.	Description	Lumens	Price /Each
XE753	45670	Portable Rechargeable LED Scene Light	3600	

ENDURO® LED HEADLAMPS

- Solid State Power Regulator provides maximum light output throughout battery life
- Waterproof to 1 metre for 1 hour
- Includes rubber/elastic combo head strap
- Lumens (High): 14.5
- Run Time Hrs. (High): 6
- Battery Type: AAA
- Lamp Colour: Black
- Beam Distance (High): 17.8 m
- Number Of Batteries Required: 2



Model No. XD434

Mfg. No. 61400

Price/Each \$

3AA PROPOLYMER® DUALIE® FLASHLIGHTS

- C4® LED technology for extreme brightness
- Simultaneous spot and flood modes for a total of 245 lumens
- IPX7 waterproof to 1m for 30 minutes
- 2 metre impact resistance tested
- Durable, non-conductive, corrosion-proof polymer resin body
- Lamp Type: LED
- Lumens (High): 140
- Run Time Hrs. (High): 18
- Battery Type: AA
- Beam Distance (High): 171 m
- Batteries Included/Not Included: Included



XE760



Model No.	Mfg. No.	Colour	Price /Each
XE760	68750	Yellow	
XE761	68752	Black	

SIEGE® COMPACT LANTERNS

- C4 LED technology for extreme brightness
- A rugged, compact lantern
- 360° soft even lighting that illuminates a large area
- Multiple modes
- Stand it upright or to use as an overhead light hang it with the D-ring on base of lantern
- IPX7 waterproof to 1 m submersion
- 2 m impact resistance tested
- Floats so you can retrieve it if you drop it in the water
- Colour: Black/Green
- RoHS compliant
- Batteries not included



XD340



Model No.	Mfg. No.	Description	Beam Distance	Lumens High	Lumens Low	Run Time Hrs. High	Run Time Hrs. Low	Price /Each
XD340	44931	Lantern, 3 D-Cell Batteries	200 m	340	33	30	295	
XB875	EN95	Replacement D-Cell Batteries, 12/Pkg.						/Pkg.
XE647	44941	Lantern, 3 AA-Cell Batteries	100 m	200	50	7	37	
XB872	EN91	Replacement AA-Cell Batteries, 24/pkg.						/Pkg.

LED FLEX-NECK FLASHLIGHTS

- Work hands free in bright LED light; magnetic base attaches to any metal surface
- 15" flexible neck directs 65 lumens of bright LED light
- Aerospace grade aluminum no-slip body is hard anodized for extreme durability
- Push button on/off tail switch allows for easy operation
- 15 hours of burn time on 2 AA batteries (not included)



Model No.	Mfg. No.	Description	Lumens	Price /Each
XC517	2365-010-110	LED Flex-Neck Flashlight	65	
XB872	EN91	Replacement AA-Cell Batteries, 24/pkg.	-	/Pkg.

FLASHLIGHTS & BATTERIES

HARD CASE® PROFESSIONAL SPOT LIGHTS

- LEDs produce a tight white spot light
- Intense focused beam
- High and Low modes for brightness and run time control
- Ideal for long distance applications and searching
- Shatterproof lens
- Water resistant
- Rugged construction
- Durable light survives drops up to 7 meters
- High: 500 lumens; Low: 150 lumens
- Run time: High 4 hrs., Low 20 hrs.
- Beam Distance: 425 m
- Material: Hard Plastic
- Colour: Black/Grey
- Includes 6 AA batteries

Model No. XE475
Mfg. No. HCSP61E
Price/Each \$



REPLACEMENT BATTERY

Model No. XB872 - 24/pkg.
Price/Pkg. \$

Energizer

HARD CASE PROFESSIONAL™ 2 AA LED FLASHLIGHTS

- 300 lumens
- Water resistant IPX4
- Shatterproof lens
- Impact resistant steel plate bolted sides
- Run time: High 6 hrs. 30 min., Low 50 hrs.
- Includes 2 long lasting AA Energizer® alkaline batteries
- Beam distance: 115 meters

Model No. XC234
Mfg. No. TUF2AAPE
Price/Each \$



REPLACEMENT BATTERY

Model No. XB872 - 24/pkg.
Price/Pkg. \$

Energizer

ENERGIZER® HD VISION INDUSTRIAL HEADLAMP

- Dimmable to control brightness and runtime
- Pivots to direct light where you need it
- Includes 3 AAA Energizer® MAX® batteries
- Lamp Type: LED
- Lumens (High): 180
- Run Time Hrs. (High): 8
- Lamp Material: Plastic
- Battery Type: AAA
- Beam Distance (High): 40 m
- Batteries Included
- Three light modes: White spot light, White flood light and Spot and flood together

Model No. SDM001
Mfg. No. HDBIN32E
Price/Each \$



Energizer

ENERGIZER® 4AA PROJECTPRO FLASHLIGHTS

- Smart dimming technology for full control of brightness and run time
- Includes four Energizer® MAX® AA batteries
- Survives drops up to 7 meters and features a shatterproof lens
- Lamp Type: LED
- Lumens (High): 400
- Run Time Hrs. (High): 11
- Battery Type: AA
- Beam Distance (High): 125 m
- Water Resistance Rating: IPX4

Model No. XE885
Mfg. No. HCHH41E
Price/Each \$



Energizer

ENERGIZER® 2AA PIVOTPRO FLASHLIGHTS

- Head pivots 175° to aim light where it's needed
- Versatile design features a magnetic base & compact body
- Survives drops up to 7 meters and features a shatterproof lens
- Includes two Energizer® MAX® AA batteries
- Lamp Type: LED
- Lumens (High): 300
- Run Time Hrs. (High): 5.5
- Battery Type: AA
- Beam Distance (High): 30 m

Model No. XE886
Mfg. No. HCSW21E
Price/Each \$



Energizer

ENERGIZER® HARDCASE RUGGED LED HEADLAMP

- Rugged LED headlamp with rear-mounted battery pack
- Multiple lighting modes (spot/flood, high/low)
- Includes 3 AA Energizer® MAX® batteries
- Lamp Type: LED
- Lumens (High): 250
- Run Time Hrs. (High): 4.75
- Battery Type: AA
- Lamp Colour: Black
- Beam Distance (High): 125 m
- Water Resistance: IPX4

Model No. XC679
Price/Each \$



Energizer

SUNNEX TASK LIGHTS

- Provide the concentrated light most needed for operations performed in today's workstations
- Ergonomically designed for ease-of-use and engineered to withstand years of operation

- Flexible gooseneck resists heavy vibration
- Scratch resistant PUR sleeving protects the flexible gooseneck arms from dust, oils, and moisture

Note: After selecting the desired lamp, select the desired base style from the mounting bases and accessories table at the bottom of the page.

20-WATT HALOGEN SERIES

- Compact head design allows positioning to provide the best lighting with minimal view obstruction

Standard features include: 12 V, 20 W halogen bulb, clear lens, spot reflector, black PUR gooseneck sleeving, 120 V power supply, On/Off switch , 7' SJT-18 polarized cord set

APPLICATIONS:

- Industrial manufacturing
- Assembly
- Inspection
- Medical and office

Model No.	Mfg. No.	Description	Price /Each
BW222	HS-700-20	20" Flexible Gooseneck, w/ built-in 120 V/12 V Transformer	
BW223	HS-700-27	27" Flexible Gooseneck, w/ built-in 120 V/12 V Transformer	
BW224*	HS-741-20	20" Flexible Gooseneck, 12 V, No Transformer	
BW225*	HS-741-27	27" Flexible Gooseneck, 12 V, No Transformer	
BW226	28610	120 V/12 V Protective Transformer	

* These units can be wired directly into machinery power supply.



50-WATT MOISTURE RESISTANT HALOGEN TASK LIGHTS

Moisture proof lamp head, lens, and reflector, make the light fixture suitable to any environment, without risking electrical damage to the lamp, or injury to the operator

Standard features include: 12 V, 50 W halogen bulb, clear lens, flood reflector, black PUR gooseneck sleeving, 110 V power supply, On/Off switch located on transformer base, 7' SJT-18 polarized cord set.

APPLICATIONS:

- Industrial machinery (CNC lathes, drill presses, grinding, milling and other high vibration shop machinery)
- Assembly workstations
- Workbenches

Model No.	Mfg. No.	Description	Price /Each
BW227	HF2000-27	27" Flexible Gooseneck, w/ built-in 120 V/12 V Transformer	
BW226	28610	120 V/12 V Protective Transformer	

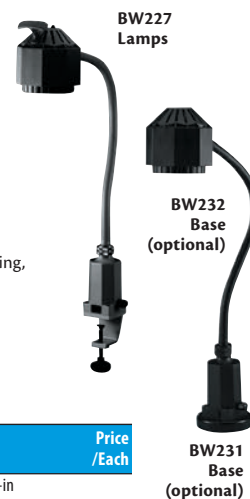

MOUNTING BASES & ACCESSORIES



Model No.	Description	Price /Each
BASES		
BW231	Magnetic Base	
BW232	C-Clamp Bracket, 1 3/4" Opening	
BW233	8" Round Table Base	

Model No.	Description	Price /Each
REPLACEMENT BULBS		
BW234	12 V-20 W Replacement Halogen Bulb	
BW235	12 V-35 W Replacement Halogen Bulb, Medium Flood	
BW236	12 V-50 W Replacement Halogen Bulb	
BW237	24 V-20 W Replacement Halogen Bulb	
BW239	24 V-50 W Replacement Halogen Bulb	
XC854	3.2 W LED Replacement Bulb	

700 SERIES LED LIGHTING

The LED element offers a significant increase in luminous intensity of a standard 20-watt halogen bulb, while providing close to 70% less energy consumption, cool-touch heat management and a projected 25 000 hours of high-output lighting.

FEATURES INCLUDE:

- Compact 3.2 W LED lamp head with 340° rotation 90° bend
- Flexible gooseneck
- Exceptionally long element life (35 000 hours)
- Cool operating temperature
- Push button On/Off switch in head

APPLICATIONS

- Medical
- Assembly
- Visual Inspection
- OEM Applications
- Fine Assembly
- Industrial Manufacturing
- Office
- Bench Work
- Electronics
- Packaging

Model No.	Mfg. No.	Description	Price /Each
XC850	LS710-20	20" Flexible Gooseneck, Tall Base, Built in 120 V Transformer	
XC851	LS710-27	27" Flexible Gooseneck, Tall Base, Built in 120 V Transformer	
XC852	LS751-20	20" Flexible Gooseneck, Square Base, 12 V	
XC853	LS751-27	27" Flexible Gooseneck, Square Base, 12 V	



TASK LIGHTS & MAGNIFIERS

FLUORESCENT INDUSTRIAL-DUTY MAGNIFIERS

KFM SERIES

- Patented internal 45" spring arm offers perfect balance and full adjustability
- 5" diameter, distortion-free lens
- Reflector optimizes light output and distributes illumination evenly across the work area
- Electronic ballast increases light output by 15%
- Secondary lens allows for a wide variety of magnification tasks
- 22 W circline fluorescent bulb (included) is protected by a non-yellowing acrylic, splash guard/diffuser
- Colour: Light grey
- 5-year limited warranty

Model No. XB951 3-diopter (1.75x)
Price/Each \$



LUXO

MAGNIFIERS

IFM SERIES

- Ideal light-duty illuminated magnifier
- 5" diameter distortion-free lens in either 3-diopter (1.75x) or 5-diopter (2.25x) models
- 45" arm length
- Clamp or base mounts
- 22 W fluorescent tube which provides shadow-free illumination
- Built-in starter, the switch does not have to be held down for several seconds to illuminate the tube
- 115 V AC
- Colour: Light grey
- Includes: Lamp diffuser cover, 3-wire cord, 22-watt fluorescent tube
- Certified for sale in Canada by an accredited certification body



LUXO



XB947



XC227

Model No.	Mfg. No.	Arm Length"	Diopter	Mount type	Price /Each
XB947	16345LG	45	3D	Edge	
XC225	16346LG	45	5D	Edge	
XC227	16351LG	30	3D	Base	

18 W ENERGY EFFICIENT FLEXIBLE DESK LAMP

- Gives equivalent light output to a 100 W incandescent
- Arm and head are uniquely flexible to allow for precise light placement
- Height 18"
- Base 6" x 9"
- Bulb: Max. 18 W mini fluorescent (DS 18 W – included)

Model No. XC792
Mfg. No. ULT118-BK
Price/Each \$



RHINOMAG ILLUMINATED FLUORESCENT MAGNIFIERS

- 5" diameter, 3-diopter lens which magnifies 1.75x (for increased magnification, see auxiliary lenses below)
- Heavy-duty spring balanced arms extend 42" (107 cm)
- Instant on/off switch
- Bulb cover for safety
- Comes with 22 W circline fluorescent bulb, spring covers and an industrial duty clamp-on bracket "A"

Model No. XC510 White
Price/Each \$

Model No. OM135 Black
Price/Each \$



AUXILIARY LENSES

Model No.	Description	Price /Each
XC512	5 diopter lenses, replaces supplied 3D lens	
XC995	Replacement fluorescent bulb	

CLIP-ON GOOSENECK LAMP

- Flexible, gooseneck arm
- Adjustable height
- Line switch on/off
- Overall Dimensions: 19" H x 3" D
- Mounting Type: Clamp
- Bulb Type: Halogen
- Lamp Wattage: 50 W
- Bulb not included



Model No.	Mfg. No.	Colour	Price /Each
XE733	DGU16-0BB	Brushed Bronze	
XE734	DGU16-SC	Satin Chrome	
50 W HALOGEN GU10			
XC568	B7462	-	

SWING ARM CLAMP-ON DESK LAMPS

- Spring arm adjusts to many positions
- 36" reach
- Clamp to any surface
- Durable baked enamel finish
- Uses CFL bulbs (not included)
- Certified for sale in Canada by an accredited certification body



Model No.	Frame Colour	Light	Type	Price /Each
XA982	Black	23 W	CFL	
XA983	White	23 W	CFL	

REPLACEMENT BULBS

Model No.	Light	Price /Each
XC552	23 W	

INDUSTRIAL TROUBLE LIGHTS

- 75 watts
- Lightweight design
- Rugged impact resistant housing
- Grounded 25' cord
- On/Off switch handle
- **Includes:** Hanging hook and electric outlet
- Certified for sale in Canada by an accredited certification body

Model No. XC660
Price/Each \$



aurora tools

INDUSTRIAL FLUORESCENT WORK LIGHTS

- Cool running fluorescent bulb included
- Shatter resistant polycarbonate lamp shield
- Includes: full length reflector, switch and hook
- Models **XB906**, **XB907** and **XB967** also have a magnet mount and outlet
- Certified for sale in Canada by an accredited certification body



LIND EQUIPMENT

Model No.	Description	Length"	Price /Each
COMPACT TWIN-TUBE			
XB906	13 W, 25' Cord, 16/3 SJT	13	
XB907	13 W, 50' Cord, 16/3 SJT	13	
XB967	26 W, 25' Cord, 16/3 SJT, Dual Twin-Tube	15	
XA251	Replacement Bulb, Rough Service (for XB906 and XB907)	-	
XC409	Replacement Bulb (for XB967)	-	
LINEAR FLUORESCENT			
XB968	15 W, 25' cord, 18/2 SJT	26	
XA572	Replacement Bulb, 24/case	-	

RECHARGEABLE FLUORESCENT WORK LIGHTS

- Utilises a long lasting fluorescent bulb which delivers excellent light in a highly portable package
- 13 W cool operating • 900 lumens
- Rechargeable 7.2 V NiMH battery pack
- 90-minute run time with full charge
- Convenient rotating hanging hook
- Stands upright on its base
- Extra battery pack allows continuous use of the light while the other is charging (Model No. **XC419**)
- **Includes:** Battery pack, 120 V charging cradle and 12 V auto adaptor cord
- Certified for sale in Canada by an accredited certification body



LIND EQUIPMENT

Model No.	Description	Price /Each
XC418	13 W Rechargeable Fluorescent Work Light	
XC419	Spare Battery Pack for XC418	
XC470	Replacement Bulb for XC418	

INDUSTRIAL WORK LIGHTS

INCANDESCENT WORK LIGHTS

- Grounded convenience outlet
- On/Off switch handle
- Models **XA175**, **XA918**, **XB987** and **XB988** feature a circuit breaker
- Models **XB987** and **XB988** feature a cord that stays flexible in cold temperature
- Certified for sale in Canada by an accredited certification body
- Accepts up to 100-watt incandescent or CFL bulb



LIND EQUIPMENT

Model No.	Description	Price /Each
XA175	25' Cord, 14/3 SJTW, 15 A	
XA918	50' Cord, 14/3 SJTW, 15 A	
XB987	25' Cord, 16/3 SJTWO, All Temperature, 13 A	
XB988	50' Cord, 16/3 SJTWO, All Temperature, 13 A	
XB990	50' Cord, 16/3 SJT, 13 A	
XB123	Replacement Bulbs, Pack of 2	

VAPOUR-PROOF INCANDESCENT WORK LIGHTS

- Suitable for areas where water vapour is present
- Rated for a 100 W incandescent or CFL bulb
- Impact resistant glass globe and metal guard
- Oil resistant yellow rubber handle
- 16/3 SOOW cord
- Certified for sale in Canada by an accredited certification body

Note: Not submersible

Model No. **XA270** 25' cord Price/Each \$

Model No. **XA267** 50' cord Price/Each \$

Model No. **XB123** Replacement bulbs, Pack of 2 Price/Each \$



LIND EQUIPMENT

HEAVY-DUTY FLUORESCENT WORK LIGHTS

- Cool running and protected by a rugged, shatter-proof polycarbonate tube
- Includes an enclosed starter switch, rubber end caps, full-length reflector and hanging hook
- Moisture and dust resistant
- Yellow 18/2 SJTOW cord
- Vapour-proof work lights suitable for areas where water vapour is present
- Certified for sale in Canada by an accredited certification body



LIND EQUIPMENT

Model No.	Description	Cord Length'	Price /Each
TWIN-TUBE, COMPACT			
XA146	13 W, 900 Lumens	25	
XB971	13 W, 900 Lumens	50	
XA251	Replacement Bulb, Rough Service	-	
LINEAR TUBE			
XA149	15 W, 920 Lumens	25	
XB972	15 W, 920 Lumens	50	
XB973	25 W, 2200 Lumens	25	
XB974	25 W, 2200 Lumens	50	
VAPOUR-PROOF			
XC330	13 W, 900 Lumens	25	
XC331	13 W, 900 Lumens	50	
XA251	Replacement Bulb, Rough Service	-	

WORK LIGHTS & CORD REELS

LED WORK LIGHTS

- Latest in LED technology brings bright, long-lasting and energy-efficient lighting to your toughest tasks
- Cool running, cold-temperature operable and highly energy efficient
- Bright white LED's provide extremely long lamp life (50 000 hours average)
- 50 LED, 15' 16/3 SJT cord, 13 A grounded outlet, removable magnet mount and dual hooks
- **Includes:** On/off switch, hanging hook and focused reflector
- Certified for sale in Canada by an accredited certification body



Model No. XC413
Price/Each \$

LIND EQUIPMENT

RECHARGEABLE LED WORK LIGHTS

- Cool running, cold-temperature operable, and highly energy efficient
- Bright white LED's provide extremely long lamp life (50 000 hours average)
- Dual-stage switch provides two brightness levels
- NiMH battery operates 3-4 hours on high, and 7-8 hours on low setting
- **Includes:** Low-battery indicator, carrying case and charging cradle with battery monitor
- Certified for sale in Canada by an accredited certification body



LIND EQUIPMENT

Model No.	Description	Price/Each
XC417	48 LED Rechargeable Light with Carrying Case	

HAZARDOUS LOCATION WORK LIGHTS

INCANDESCENT HAND LAMPS

- 100-W explosion proof light provides 1600 lumens of light output
- 16/3 SOOW cord with a non-explosion proof plug (explosion proof plug is also available)
- Approved for Class I Division I Group C and D hazardous locations
- Certified for sale in Canada by an accredited certification body

25' CORD

Model No. XA269
Price/Each \$

50' CORD

Model No. XA103
Price/Each \$

100' CORD

Model No. XD059
Price/Each \$

REPLACEMENT BULB

Model No. XB123
Price/Each \$



COMPACT FLUORESCENT HAND LAMPS

- 26-W quad tube (1800 lumens)
- Minimal heat generation makes them ideal for use in confined, potentially explosive areas
- DuPont Zytel® outer construction is extremely rugged and leaves no exposed metal parts
- 16/3 SOOW cord with a non-explosion proof plug (explosion proof plug is also available)
- Approved for Class I Division 1 Group C and D and Class II Division 1 Group F and G hazardous locations
- Certified for sale in Canada by an accredited certification body



Model No.	Description	Price/Each
XA137	26 W, 25' Cord	
XA136	26 W, 50' Cord	
XD060	26 W, 100' Cord	
XD061	Replacement Bulb 26 W Quad Tube	

LED HAZARDOUS LOCATION FLOODLIGHTS

- Ultra bright 39 W LED array
- Equivalent usable light output as a 70 W metal halide hazardous location floodlight while using 56% less energy
- Aluminum housing can stand up to rough service and is suitable for wet locations (NEMA 4)
- Includes 50' 16/3 SOOW cable and standard plug (explosion-proof plug is also available)
- Approved for use in Class I, Division 1, Groups C&D, Class II, Division 1&2, Groups F&G and Class I, Division 2, Groups A, B,C&D hazardous locations
- Certified for sale in Canada by an accredited certification body

Model No. XD051
Price Each \$



LIND EQUIPMENT

PORTABLE LED WORK LIGHT

- Adjustable tilting head
- LED bulb included
- Certified for sale in Canada by an accredited certification body
- Lumens: 2500
- Wattage: 20
- Housing Material: Aluminum

aurora tools®

Model No.	Price/Each
XG816	

XC661



LINEAR FLUORESCENT LED STRINGLIGHTS

- 50 W fluorescent lamp is rated for 14 000 hours, equivalent light output as a 300 W incandescent lamp
- Hangs 14" high with hooks
- 16/3 SJTOW cord
- Thick-walled polycarbonate outer tube is virtually indestructible
- Oversized end caps provide additional impact protection
- Feed-through receptacle allows lights to be strung together to light larger areas (up to 24 units)
- Moisture and dust resistant
- Certified for sale in Canada by an accredited certification body



LIND EQUIPMENT



TWIN-HEAD LED WORK LIGHT

- Adjustable tripod for desired height
- Extendable tripod legs provide greater stability
- LED bulbs included
- Fixtures can adjust 120°
- Certified for sale in Canada by an accredited certification body
- Lumens: 4800
- Wattage: 40
- Housing Material: Aluminum

aurora tools®

Model No.	Price/Each
XG817	

XG817



Model No.	Description	Price/Each
XD063	35", 50 W Linear Fluorescent	
XD064	35", 50 W Linear Fluorescent/Vapour Proof	
XE854	35" LED Stringlights	

HAND-HELD & PORTABLE FLOOD LIGHTS

- 500-watt weatherproof fixture
- 8', 16-gauge heavy-duty cord
- Comfortable foam grip (XA143 and XA145)
- Screw-type clamp mounts light anywhere you need it, including ladders or scaffolding (XA143)
- Lights up to 5000 sq. ft.
- **Model XA145:** Powerful 40 lbs. pull strength magnet quickly attaches to metal surfaces
- **Model XA638:** PVC coated solid steel base
- Certified for sale in Canada by an accredited certification body



Model No.	Description	Price /Each
XA143	Hand-Held Flood Lights with Clamp	
XA145	Hand-Held FloodLights with Magnet	
XA638	Industrial Portable Flood Lights	

BEACON 360° WIDE AREA LED LIGHT

- Light temperature: 4500K (bright white light - no blue tint)
- 13000 lumens equivalent usable light of a 400 W metal halide
- Environmental rating: IP64 (weatherproof)
- Construction: Cast aluminum housing, polycarbonate lenses
- Switch: On/Off rocker switch
- Weight: 10 lbs. (light head only)
- Height: 14" (light head)
- Diameter: 6" (light head)
- 120 W
- Lighting range: 50'
- Approvals: cETLus portable work light



Model No.	Description	Price /Each
XE636	w/Magnet Mount	
XE637	w/Clamp	
XE638	w/Tripod	

BEACON LED FLOODLIGHTS

- 50 W as bright as a 500 W quartz-halogen floodlight
- 30 W as bright as a 300 W quartz-halogen floodlight
- Low operating temperature, resulting in a safer working environment
- Low energy usage and no bulb replacement, resulting in large total cost of ownership savings
- High quality LEDs are rated for over 50000 hours
- Durable aluminum housing and tempered glass lens
- IP65 environmental rating and starts instantly in cold weather
- 15' 18/3 SJOW cord
- Certified for sale in Canada by an accredited certification body



Model No.	Description	Price /Each
FLOODLIGHTS		
XE855	50 W LED Floodlight Base Model	
XC942	50 W LED Floodlight with Floor Stand	
XC941	50 W LED Floodlight with Tripod	
XD044	50 W LED Dual Head Floodlight with Tripod	
XD045	50 W LED Floodlight with Magnet Mount	
XD046	50 W LED Floodlight with Clamp Mount	
RECHARGEABLE FLOODLIGHTS		
XE862	30 W LED Rechargeable Floodlight Base Model	
XE863	30 W LED Rechargeable Floodlight with Floor Stand	
XE864	30 W LED Rechargeable Floodlight with Tripod	
XE865	30 W LED Rechargeable Dual Head Floodlight with Tripod	
XE866	30 W LED Rechargeable Floodlight with Magnet Mount	
XE867	30 W LED Rechargeable Floodlight with Clamp Mount	



WORK LIGHTS & CORD REELS

TWIN HEAD HALOGEN WORK LIGHTS

- Twin 500-watt halogen lights
- Heat resistant tempered glass face
- Adjustable tripod for desired height
- Extendable tripod legs provide greater stability
- Colour: Black and yellow
- Halogen bulbs included
- Certified for sale in Canada by an accredited certification body



Model No. XC950
Price/Each \$

REPLACEMENT BULB
Model No. XC951
Price/Each \$

aurora tools

PORTABLE HALOGEN WORK LIGHTS

- 500-watt halogen work light
- Heat resistant tempered glass face
- Adjustable tilting head
- Colour: Black and yellow
- Halogen bulb included
- Certified for sale in Canada by an accredited certification body



Model No. XC949
Price/Each \$

REPLACEMENT BULB
Model No. XC951
Price/Each \$

aurora tools

HEAVY-DUTY WORKLIGHTS

- 500-watt weatherproof fixture
- Tempered glass lens
- Chrome-plated, solid steel guard
- Shock-resistant double insulated wiring
- 500 W colour-corrected quartz halogen bulb included
- Powder-coated steel construction
- Rubber leg tips protect floors and surfaces
- Certified for sale in Canada by an accredited certification body

LIND EQUIPMENT



1' TO 3' TELESCOPIC

- 8', 16-gauge heavy-duty chemical and abrasion resistant cord
- Collapsible steel base
- Lights up to 6000 sq. ft.

Model No. XA150
Price/Each \$

4' TO 8' TELESCOPIC

- Double-reinforced sandbaggage steel base expands to 48"
- 15', 16-gauge heavy-duty chemical and abrasion resistant outdoor cord
- Lights up to 7000 sq. ft.

Model No. XA140
Price/Each \$

4' TO 8' TELESCOPIC TWIN

- Twin 500-watt heads
- Fixtures independently adjustable 360°
- Two 10 A switches
- Double-reinforced sandbaggage steel base expands to 48"
- 15', 16-gauge heavy-duty chemical and abrasion resistant cord
- Lights up to 14 000 sq. ft.

Model No. XA141
Price/Each \$

ENERGY EFFICIENT FLUORESCENT FLOODLIGHTS

- 65 W cool-running, energy efficient fluorescent floodlight
- Light output equivalent to 300 W incandescent but with much less energy use
- Aluminum frame, tempered glass lens
- Energy Star® certified

Model No. XC469
Price/Each \$



LIND EQUIPMENT



LED WORK LIGHTS

- LED bulbs last longer than Halogen, consumes less energy
- Stays cool to the touch even after hours of usage
- Impact resistant glass and durable aluminum housing
- Weather-protected sealed switch
- Non-slip soft grip carry handle
- For indoor and outdoor use in dry locations
- XE665: Twin LED lights easily detach from tripod
- XE665: Unit includes tripod stand and (2) 2400 lumen LED lights



Model No.	Lumens	Wattage	Lighting Range	Price /Each
XE666	2400	20 W	70'	
XE665	4800	40 W	140'	

HEAVY-DUTY MOLDED LED STRINGLIGHTS

- Rugged 12/3 or 12/2 STW cable is high visibility yellow
- Can be linked together for longer runs
- Sockets are rated for a max. 120 V, 150 W A23 bulbs
- Certified for sale in Canada by an accredited certification body



LIND EQUIPMENT

Model No.	Length'	Wire Type	No. of sockets	Guard Style	Price /Each
XB979	50	12/3	5	Plastic Cage	
XB980	50	12/3	5	Metal Cage	
XE852	50	12/3	5	Polycarbonate LED Lamp Array	
XB981	100	12/3	10	Plastic Cage	
XB982	100	12/3	10	Metal Cage	
XD062	100	12/2	10	Plastic Cage	
XE853	100	12/3	10	Polycarbonate LED Lamp Array	

ACCESSORIES

Model No.	Description	Price/Each
XB119	Standard Coat Replacement Bulb	
SA0746	Replacement Plastic Head	
SA0747	Replacement Metal Head	

DUAL-HEAD LED TRIPOD WORK LIGHTS

- Stays cool to the touch even after hours of usage
- Impact resistant glass and durable aluminum housing
- Weather-protected sealed switch
- Non-slip soft grip carry handle
- Twin LED lights easily detach from tripod
- Lumens: 7200
- Wattage: 60 W
- Housing Material: Aluminum
- Lamp Life: 30,000 hrs.
- Cord Length: 8'
- Lighting Range: 210'

Model No. XE750
Price/Each \$



WOBBLELIGHT® SELF-RIGHTING WORK LIGHTS

Bright and dependable, the self righting Wobblelight® delivers maximum light output in a highly durable and portable package with no hot surfaces.

- Ideal anywhere temporary high-output lighting is needed, such as indoor and outdoor construction sites, manufacturing, plant maintenance, fire & rescue
- Floating shock system protects bulb from impact
- Counter-weighted self righting design
- 360° lighting out put adjustable to 180° with optional reflector
- Optional nylon reflector shield allows you to maintain 100% light source and focus it
- Internal ventilation system keeps light cool to the touch
- No set up – plugs into 120 VAC supply
- Available in 27" and 36" Heights
- Model **XC332**, **XC334** & **XE603** include receptacle for connecting units in a series
- Certified for sale in Canada by an accredited certification body



XC746



XC332

Model No.	Mfg. No.	Description	Light Output Lumens	Lighting Area	Price /Each
XC746	WL85F	85 W Fluorescent, 27" High	5000	20'	
XC332	WL175MH	175 W Metal Halide, 36" High	15 000	30-42'	
XC334	WL400MH	400 W Metal Halide, 36" High	40 000	78-110'	
XE603	11136LED	65 W LED, 36" High	5500	30'	

ACCESSORIES

Model No.	Mfg. No.	Description	Price/Each
XC747	WL62230	180° Arc Reflector Shield for XC746	
XC335	WL52230	180° Arc Reflector Shield for XC332, XC334 & XE603	
XC749	111810	Replacement Transparent Dome w/Cap for XC746	
XC453	111801	Replacement Transparent Dome w/Cap for XC332, XC334 & XE603	

REPLACEMENT BULBS

XC748	WL62260	Replacement Bulb for XC746
XE706	64030	Replacement Bulb for XC332
XC454	M400/U/ET18	Replacement Bulb for XC334
XE532	111965	Replacement Bulb for XE603



XC335

Arc Reflector Shield

DEFENDER® ECO UPLIGHTS

- Tripod base
- Available in a two foot or four foot versions
- Integrated and collapsible legs opening up to 30" diameter for exceptional stability
- Tripod base is collapsible and locking
- IP44 design for dust and water resistance
- 15-ft. power cord
- Adjustable nylon carrying strap
- Removable threaded hooks for hanging
- Low energy consumption
- Lamp life of 20 000 hours
- Removable reflector for 360° lighting
- Certified for sale in Canada by an accredited certification body

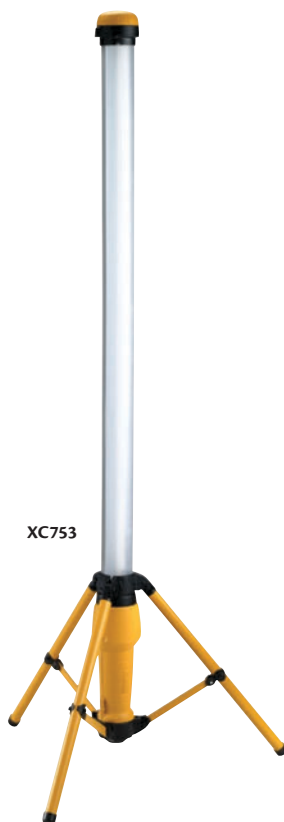

XC753



Model No.	Mfg No.	Description	Light Output Lumens	Lighting Area	Price /Each
XC753	E712600	Tripod Base, 36 W Fluorescent, 4' High	3250	10-15'	

MINI MOBI LED INSPECTION LIGHTS

- 20 LEDs deliver 55 lumens
- Wide spread beam of clean white light
- Tough ABS body, rubber over-mold and shatterproof lens
- Integrated floor stand, hanging hook and magnet offer multiple working positions
- Run time: 3 hours (high) – 8 hours (70% power)
- Includes 3 AA batteries
- Ideal for: Construction, industrial, maintenance industries

Model No. XD067
Mfg. No. E712848
Price Each \$

REPLACEMENT BATTERIES

- AA, alkaline batteries, 24/pkg.
- Model No. XB872
Price/Each \$



HANG-A-LIGHT® WORK LIGHTS

The Hang-A-Light® is a high-output temporary lighting fixture that gives 360° light with low-cost operation.



HANG-A-LIGHT® FLUORESCENT

- Energy efficient 105 watt fluorescent bulb
- Self-ballasted CFL bulb, lightweight and flicker-free
- Lumens: 6900
- Lighting area: 20-30'
- Electrical receptacle, interconnect up to 8 units on a 120 V/15 A service
- 5' integrated power cord
- Certified for sale in Canada by an accredited certification body

HANG-A-LIGHT®

- Modifiable for 120/208/240/277 V
- Heavy-gauge steel construction
- Lumens: 42 000
- Lighting area: 50-100'
- Spring-loaded steel safety hook for fast installation
- Welded wire safety cage with bottom guard
- Lights 60' radius when mounted 15' above work area
- NEC/OSHA compliant
- Suitable for damp location use
- 6' integrated power cord
- Certified for sale in Canada by an accredited certification body

HANG-A-LIGHT® TEMPORARY AREA LED LIGHT

- Portable LED lamp that is ideal for use in many different work environments
- Can be interlinked with other units
- Spring loaded clamp makes hanging the unit easy
- Has a 5' integrated power cord
- No hot surfaces
- Lumens: 5500
- Lighting Range: 30'
- Lamp Life: 30 000 hrs.
- Certified for sale in Canada by an accredited certification body



ProBult Professional Lighting, LLC

WOBBLIGHT

Model No.	Mfg. No.	Description	Price /Each
XC754	111105F	Hang-A-Light®, 105 W Fluorescent	
XD065	111400PS	Hang-A-Light®, 400 W Pulse Start Metal Halide	
XE602	111065LED	Hang-A-Light®, 65 W Portable LED lamp	
XC755	111915	Replacement Bulb for XC754	
XD066	111903PS	Replacement Bulb for XD065	
XE532	111965	Replacement Bulb for XE602	

9430 REMOTE AREA LIGHTING SYSTEMS

- Up to 15 hours of burn time
- High flux LED, 50 000 hour life
- 1500 lumens at low setting
- 3000 lumens at high setting
- Maintenance-free LED array with life expectancy of 50 000 hours
- Fully extendable mast with 360° rotating head
- 12 V rechargeable, sealed battery
- Battery run time: 15 hours at low setting, 8 hours at high setting
- Battery charge time: 5 hours from full discharge
- Low battery warning system
- Waterproof rubber activation switch
- Mast extension lock
- Certified for sale in Canada by an accredited certification body

Model No. XC817
Price/Each \$



9460RS REMOTE AREA LIGHTING SYSTEMS

WIRELESS ACTIVATION

- High flux LED, 50 000 hour life
- 500 lumens at low setting
- 6000 lumens at high setting
- Two lamp heads with six LEDs per head
- 120° beam spread
- 12 V rechargeable, sealed battery
- Battery run time: 40 hours at low setting, 7 hours at high setting
- Battery charge time: 6 hours from full discharge
- Features two remote control activation devices, multi-terrain trolley, a 12 V power supply port
- Remote control devices can be used 60' away
- Certified for sale in Canada by an accredited certification body

Model No. XC818
Price/Each \$



9480 REMOTE AREA LIGHTING SYSTEMS

- Lighting system with 3 preset output levels (1000, 3000 or 4000 lumens)
- Includes a mast with an extended height of 23.75" and 340° rotation
- Very versatile system with multiple deployment positions
- Maintenance free LED array with 50 000 hour life expectancy
- Includes a convenient shoulder strap
- Uses a 12 V rechargeable Sealed Lead Acid (SLA) battery
- Battery lasts between 6 and 28 hours depending on which output level is used
- Lighting range is highly variable and depends on the system's set-up
- Lamp Type: High Flux LED
- Wattage: 41.1 W
- Lamp Life: 50 000 hrs.
- Housing Material: Polypropylene
- Certified for sale in Canada by an accredited certification body

Model No. XE696
Price/Each \$



WORK LIGHTS & CORD REELS

HAND-WIND ELECTRIC CABLE REELS

- Provides a portable power centre for tools and equipment
- Frame is made from heavy-duty steel tubing, and features a contoured comfort grip
- Side discs are rolled to provide increased rigidity and strength
- Powder painted for a long-lasting, tough finish
- Equipped with four 120 V 15/20 A T-slot receptacles and 120 V 15 A plug
- LED illuminates to indicate that the reel is connected to power
- Resettable circuit breaker protects against overloads
- Receptacles are recessed for protection against impact and inadvertent contact
- Enclosed terminals at the centre of the reel hub prevent users from contacting live connections
- Dimensions: 17 1/2" L x 11 1/2" W x 18" H
- Certified for sale in Canada by an accredited certification body



LIND EQUIPMENT

Model No.	Description	Price /Each
XC410	10" Pigtail, Ready for Winding Your Existing Extension Cord	
XC411	Reel w/ 100' 12/3 SOW Cord w/ Plug	
XC412	Reel w/ 50' 12/3 SOW Cord w/ Plug	

LE9000 SERIES HEAVY-DUTY CORD REELS

- Durable all-steel weatherproof construction, NEMA4 weatherproof rating
- Adjustable cable guide arm (12 positions)
- Strong ratchet can be disengaged for constant tension
- Adjustable ball stop
- 6' feeder cord
- Standard SJOW or SOW cable
- Approvals: CSA, UL



LIND EQUIPMENT

Model No.	Cord Length'	Description	Rating	Price /Each
XC736	30	14/3 SJOW Incandescent Light	15 A	
XC737	30	14/3 SJOW Single Outlet (5-15R)	15 A	
XC739	30	14/3 SJOW Quad-Box (5-15R)	15 A	
XC741	50	14/3 SJOW Incandescent Light	15 A	
XC742	50	14/3 SJOW Single Outlet (5-15R)	15 A	
XC743	50	12/3 SJOW Single Outlet (5-20R)	20 A	
XC744	50	14/3 SJOW Quad-Box (5-15R)	15 A	
XC745	50	12/3 SJOW Quad-Box (5-20R)	20 A	

LED WORK LIGHT REELS

- Reach your light to where you need it most, with 30 or 50 feet of cable
- Bright white LED's on lights last for an average of 50000 hours
- Tough metal reel housing stands up to abuse
- Certified for sale in Canada by an accredited certification body



LIND EQUIPMENT

Model No.	Description	Price /Each
XC414	30' of 16/3 SJTW Cord, 50-LED Work Light w/10 A Outlet	

DATA CORD REELS

LE2300 SERIES RETRACTABLE DATA REELS

- Robust spring technology
- Compact and lightweight design
- Ideal in conference rooms or other areas where instant data connections are required without the mess of stray wires
- Certified for sale in Canada by an accredited certification body



LIND EQUIPMENT

Model No.	Cable Length'	Description	Price /Each
XD056	20	CAT6 Cable, Retractable Data Reel	
XD057	20	USB Cable, Retractable Data Reel	

HEAVY-DUTY LED WORK LIGHTS & CORD REELS

- Virtually indestructible with a polycarbonate lens and rubber handle
- 50000 hour LED technology means never having to change a bulb again
- XD047 has the same usable light output as a 13 W fluorescent work light
- XD047 also operates as a flashlight with a 1 W LED light on the end
- Standard with 25' of 18/2 SJTOW cord
- Also available on a 40' cord reel
- Certified for sale in Canada by an accredited certification body



LIND EQUIPMENT

Model No.	Description	Price /Each
XD047	8 W LED Work Light	
XD049	40' Cord Reel w/8 W LED Work Light	

WORK LIGHTS & CORD REELS



Positive latching mechanism allows the cord to be extended to any length required and automatically held in place. An adjustable ball stop provides easy height adjustment. Hardware included for either ceiling or wall mount.

INDUSTRIAL CORD REELS

- Provide secure wall or ceiling mounting
- A release tab on the mounting bracket quickly and easily converts the reel from stationary to portable use
- Large, comfortable carrying handle
- The non-metallic composite housing ensures a prolonged, corrosion-free service life
- Certified for sale in Canada by an accredited certification body

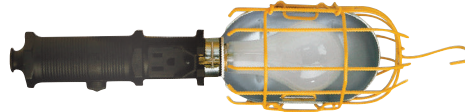

Incandescent Work Light



DB978



Fluorescent Work Light

Model No.	Cable Length'	Cable Type	Termination	Outlet Rating	Price /Each
DB978	40	12/3 SJTW	Triple Outlet	15 A, Breaker Protected	
DB979	50	14/3 SJTW	Triple Outlet	13 A, Breaker Protected	
DB980	50	14/3 SJTW	Incandescent Light	13 A, Breaker Protected	
DB981	50	16/3 SJTW	26 W Fluorescent Light	7 A	

INCANDESCENT WORK LIGHT REELS

- Incandescent work light is rated for a 75 W bulb
- Includes switch and circuit breaker protected outlet
- Grounded metal guard with reflector protects the bulb
- Certified for sale in Canada by an accredited certification body



XA155

Model No.	Cable Length'	Outlet Description	Rating	Price /Each
XA155	30	16/3 SJT Cord	10 A	
XA921	50	18/3 SVT Cord	7 A	
XB122		Replacement Bulb		

INDUSTRIAL 15 A CORD REELS

- Four 5-20R grounded outlets providing a full 15 A of power
- Power "ON" light indicator
- 20' of 12/3 SJTOW oil resistant and cold weather flexible cable
- Strong steel housing and epoxy finish enable the reel to be used in most industrial environments
- 15 A Circuit breaker protection against power overloads, which have the potential to cause electrical fires
- Hardware for ceiling or wall mounting included
- Certified for sale in Canada by an accredited certification body



Model No. XD052
Price /Each \$

EXTENSION REELS

- Triple outlet extension reel accommodates three tools
- Circuit breaker protects against power overloads, which can cause electrical fires
- Certified for sale in Canada by an accredited certification body



XA154

Model No.	Cable Length'	Outlet Description	Rating	Price /Each
XA154	30	16/3 SJT Cord	10 A	
XB281	30	14/3 SJT Cord	13 A	

FLUORESCENT WORK LIGHT REELS

- 13 W compact fluorescent work light is cool running
- Includes switch, hanging hook and full-length reflector
- Shatter-proof polycarbonate shield allows tool-free lamp replacement
- Light output is 900 lumens
- Certified for sale in Canada by an accredited certification body



XA289

Model No.	Cable Length'	Description	Price /Each
XA289	40	18/2 SJT Cord	
XA412	30	16/3 SJT Cord, 9 A Outlet in Light	

CORD REELS

Spring retractable cord reels are available in 3 styles. Standard female receptacle, LED and fluorescent lamp. Engineered for industrial use, these units are also compact, can be installed on walls, ceilings or under a tool bench.

Dimensions: 12 5/8" L x 9 3/8" W x 13 1/4" H.

All units feature 125 V SJTOW cord.

Certified for sale in Canada by an accredited certification body



XA172



TNB516



Model No.	Max. Amps	Cable Length'	Gauge	Wt. lbs.	Price /Each
LED					
TNB516	13	50	16/3	27	
FLUORESCENT					
XA174	0.3	50	16/2	26	
SINGLE OUTLET					
XA172	13	50	16/3	26	

OUTDOOR VINYL EXTENSION CORDS

- Designed for industrial and contractor use
- Vinyl jacket protects against rough use, chemicals, and moisture and provides added flexibility
- Molded-on and bonded plugs and connectors resist breaking

3-CONDUCTOR SJTW, 300 V GROUNDING

Model No.	Length'	AWG	Amps	Watts	Colour	Price /Each
HEAVY-DUTY						
XC482	25	14/3	15	1875	Orange	
XC483	50	14/3	15	1875	Orange	
XC484	100	14/3	13	1625	Orange	
EXTRA HEAVY-DUTY						
XC485	25	12/3	15	1875	Yellow	
XC486	50	12/3	15	1875	Yellow	
XC487	100	12/3	15	1875	Yellow	



XC485

OUTDOOR VINYL TRIPLE TAP EXTENSION CORDS

- Designed for industrial and contractor use
- Vinyl jacket protects against rough use, chemicals, and moisture
- Vinyl jacket provides added flexibility
- Molded-on and bonded plugs and connectors resist breaking

3-CONDUCTOR SJTW, 300 V GROUNDING

Model No.	Length'	AWG	Amps	Watts	Colour	Price /Each
HEAVY-DUTY						
XC488	25	14/3	15	1875	Red	
XC489	50	14/3	15	1875	Red	
XC490	100	14/3	13	1625	Red	
EXTRA HEAVY-DUTY						
XC491	25	12/3	15	1875	Red	
XC492	50	12/3	15	1625	Red	
XC493	100	12/3	15	1625	Red	



XC491

OUTDOOR VINYL TRIPLE TAP EXTENSION CORDS

- Designed for use by contractors and industrial personnel
- Jacket protects against rough use, chemicals, moisture, ozone and gives added flexibility at below freezing temperatures
- Molded-on and bonded vinyl plugs and connectors resist breaking or pulling off cord
- Nickel-coated brass blades resist corrosion
- XA719, XA720, XA721 are No Overload® circuit breaker extension cords

3-CONDUCTOR SJTW, 300 V GROUNDING

Model No.	Length'	AWG	Amps	Watts	Colour	Price /Each
HEAVY-DUTY						
XA719	25	14/3	15	1875	Red	
XA720	50	14/3	15	1875	Red	
XA721	100	14/3	13	1625	Red	
EXTRA HEAVY-DUTY						
XA722	25	12/3	15	1875	Yellow	
XA723	50	12/3	15	1875	Yellow	
XA724	100	12/3	15	1875	Yellow	



NEMA 5-15P

XA719



NEMA 5-15R

GLACIER FLEX™ 3-OUTLET ENGINE BLOCK HEATER CORDS

- 3 conductors, SJTW -50°C, 300 V grounding
- Water-resistant
- Flame retardant
- Ultra flexible
- Nickel-coated brass blades resist corrosion
- Temperature range from -50°F to +140°F (-50°C up to +60°C)
- Primelight® indicator light flashes blue and red when power is on



XC730

Model No.	Length'	AWG	Amps	Watts	Price /Each
XC730	15	16/3	13	1625	

EXTENSION CORDS & OUTLETS

ALL WEATHER TPE-RUBBER EXTENSION CORDS WITH LIGHT INDICATOR

- Designed for industrial and contractor use
- All-weather jacket provides ultra flexibility and superior performance in extreme climate conditions at temperatures from -50°C to 105°C
- Provides outstanding resistance against rough use, sunlight, chemicals and moisture
- Water-resistant and flame retardant
- Lighted connectors allow you to see when the power is in use
- Molded-on and bonded plugs and connectors resist breaking



aurora tools

3-CONDUCTOR SJEOW, 300 V GROUNDING

Model No.	Length'	AWG	Amps	Watts	Colour	Price /Each
HEAVY-DUTY						
XC500	25	14/3	15	1875	Blue/Orange	
XC501	50	14/3	15	1875	Blue/Orange	
XC502	100	14/3	15	1625	Blue/Orange	
EXTRA HEAVY-DUTY						
XC503	25	12/3	15	1875	Blue/Orange	
XC504	50	12/3	15	1875	Blue/Orange	
XC505	100	12/3	15	1875	Blue/Orange	



XC500

ARCTIC BLUE™ ALL-WEATHER TPE-RUBBER LIGHTED END EXTENSION CORDS W/PRIMELOK® & PRIMELIGHT®

- Arctic Blue™ cords are designed for use by contractors and industrial personnel, providing an all weather cordset made for outstanding performance in extreme climate conditions at temperatures from -58°F to 221°F (-50°C to 105°C)
- One-third lighter than standard rubber cords
- Provides superior resistance to sunlight, ozone, cracking, oils and chemicals and are outstanding in resistance to abuse, rough handling and wear
- Flame retardant and water resistant
- Distinctive orange stripe extruded into the cord
- Primelok® keeps power tool connections from coming loose
- Primelight® indicator light allows you to see there is power to the cord



3-CONDUCTOR SJEOW, 300 V GROUNDING

Model No.	Length'	AWG	Amps	Watts	Colour	Price /Each
HEAVY-DUTY						
XB894	25	14/3	15	1875	Blue/Orange	
XB895	50	14/3	15	1875	Blue/Orange	
XB896	100	14/3	13	1625	Blue/Orange	
EXTRA HEAVY-DUTY						
XB897	25	12/3	15	1875	Blue/Orange	
XB898	50	12/3	15	1875	Blue/Orange	
XB899	100	12/3	15	1875	Blue/Orange	



XB895



NEMA 5-15P



NEMA 5-15R

ARCTIC BLUE™ ALL-WEATHER TRIPLE TAP TPE-RUBBER LIGHTED END EXTENSION CORDS W/PRIMELIGHT®

- Arctic Blue™ cords are designed for use by contractors and industrial personnel
- All weather cordset made for outstanding performance in extreme climate conditions at temperatures from -58°F to 221°F (-50°C to 105°C)
- Superior resistance to ozone, oils, chemicals and rough handling
- Flame retardant and water resistant
- Primelight® indicator light allows you to see there is power to the cord



3-CONDUCTOR SJEOW, 300 V GROUNDING

Model No.	Length'	AWG	AMPS	Watts	Colour	Price /Each
EXTRA HEAVY-DUTY						
XB902	25	12/3	15	1875	Blue/Orange	
XB903	50	12/3	15	1875	Blue/Orange	
XB904	100	12/3	15	1875	Blue/Orange	



XB904



NEMA 5-15R



NEMA 5-15P

EXTENSION CORDS & OUTLETS

OUTDOOR VINYL EXTENSION CORDS WITH LIGHT INDICATOR

- Designed for industrial and contractor use
- Vinyl jacket protects against rough use, chemicals, and moisture
- Ultra flexible cord
- Lighted connectors allow you to see when the power is in use
- Molded-on and bonded plugs and connectors resist breaking
- Water-resistant and flame retardant



aurora tools®

3-CONDUCTOR SJTOW, 300 V GROUNDING, OIL RESISTANT

Model No.	Length'	AWG	Amps	Watts	Colour	Price /Each
EXTRA HEAVY-DUTY						
XC494	25	12/3	15	1875	Yellow	
XC495	50	12/3	15	1875	Yellow	
XC496	100	12/3	15	1875	Yellow	



XC494

OUTDOOR TRIPLE TAP VINYL EXTENSION CORDS WITH LIGHT INDICATOR

- Same great features as outdoor single tap vinyl extension cords but with a lighted triple tap connector



aurora tools®

3-CONDUCTOR SJTOW, 300 V GROUNDING, OIL RESISTANT

Model No.	Length'	AWG	Amps	Watts	Colour	Price /Each
EXTRA HEAVY-DUTY						
XC497	25	12/3	15	1875	Yellow	
XC498	50	12/3	15	1875	Yellow	
XC499	100	12/3	15	1875	Yellow	



XC497

INDOOR/OUTDOOR STANDARD-DUTY EXTENSION CORDS

- Designed for light industrial, contractor, and home use
- Durable SJTW jacket protects against ultraviolet rays, chemicals and moisture
- Extremely flexible jacket
- Molded-on and bonded plugs and connectors resist breaking



aurora tools®

3-CONDUCTOR SJTOW, 125 V GROUNDING

Model No.	Length'	AWG	Amps	Watts	Colour	Price /Each
XC630	10	16/3	13	1625	Orange	
XC631	15	16/3	13	1625	Orange	
XC632	25	16/3	13	1625	Orange	
XC633	50	16/3	13	1625	Orange	



XC630

WIND-UP EXTENSION CORD

- 4 Grounded outlets
 - Built-in resettable circuit breaker
 - Length: 25'
 - Gauge (AWG): 16/3
 - Amperage: 10 A
 - Wattage: 1250 W
- Model No. XE671**
Price/Each \$



aurora tools®

EXTENSION REELS

- Triple outlet extension reel accommodates three tools
- Circuit breaker protects against power overloads, which can cause electrical fires
- Certified for sale in Canada by an accredited certification body



XA154

LIND EQUIPMENT

Model No.	Cable Length'	Outlet Description	Rating	Price /Each
XA154	30	16/3 SJT Cord	10 A	
XB281	30	14/3 SJT Cord	13 A	

EXTENSION CORDS & OUTLETS

NEON FLEX® HIGH VISIBILITY NEON COLOUR OUTDOOR EXTENSION CORDS W/PRIMELIGHT®

- Combine all the features of a standard vinyl outdoor extension cord with ultra-high-visibility neon colours
- Brighter than other coloured cords and also extremely shiny
- Flame retardant and water-resistant
- Nickel coated brass blades resist corrosion
- Primelight® connector allows you to see when the power is on
- Ultra flexible, contractor tough
- Provides same performance in extreme climate conditions at temperature from -58°F to 140°F (-50°C to 60°C)



XB891



NEMA 5-15P



NEMA 5-15R

3-CONDUCTOR SJTW, 300 V GROUNDING

Model No.	Length'	AWG	Amps	Watts	Colour	Price /Each
EXTRA HEAVY-DUTY						
XB890	50	12/3	15	1875	Neon Green	
XB891	100	12/3	15	1875	Neon Green	
XB892	50	12/3	15	1875	Neon Pink	
XB893	100	12/3	15	1875	Neon Pink	

THE PRO-TEC-TOR™ CIRCUIT BREAKER EXTENSION CORD

- The only extension cord with a circuit breaker that can be reset right at the outlet end
- Protects cordset from equipment overload, which can cause electrical fires
- Safety yellow SJTW cord
- Certified for sale in Canada by an accredited certification body



XA055

Model No.	Description	Wire Ga./Cond.	Voltage	Cord Length'	Rating Amps	Price /Each
14-GAUGE EXTENSION CORDS						
XB983	Triple Outlet	14/3	125	6	15	
XA054	Triple Outlet	14/3	125	25	15	
XA059	Triple Outlet	14/3	125	50	15	
12-GAUGE EXTENSION CORDS						
XC057	Triple Outlet	12/3	125	25	15	
XA055	Triple Outlet	12/3	125	50	15	
XA056	Triple Outlet	12/3	125	100	15	

HEAVY-DUTY NEOPRENE EXTENSION CORDS

- Designed to provide longer life in the most demanding environments, such as industrial, mining, and construction sites
- Made of heavy-duty rubber suitable for indoor and outdoor applications requiring flexibility and mechanical toughness
- Exceptional resistance to oil, moisture, ozone, sunlight, chemicals, cuts, cracking, and abrasions
- Stays flexible, even at -40°F (-40°C) and resists heated objects and oils up to 194°F (90°C)
- 600 V SOOW cable has oil-resistant double-thick outer jacket and oil-resistant inner insulation
- Includes rugged nylon plug and connector rated for 125 V 15 A (NEMA 5-15)
- Certified for sale in Canada by an accredited certification body



XA254

Model No.	Length'	Gauge	Cord Rating	Price /Each
XA071	25	16/3	13 A	
XA260	50	16/3	13 A	
XA255	100	16/3	10 A	
XA253	25	14/3	15 A	
XA254	50	14/3	15 A	
XA252	100	14/3	15 A	
XC996	25	12/3	15 A	
XC997	50	12/3	15 A	
XC998	100	12/3	15 A	

GFCI's are complex devices that save lives and protect equipment every day in tough work environments.

Whether it is due to water or damaged equipment and cords, ground faults can occur quickly and, if not resolved immediately, can result in severe injury or electrocution.

A GFCI, by standards definition, must trip the circuit if a ground fault occurs with a maximum of 6 mA of current loss to ground.

If a ground fault is sensed, a Class A GFCI will trip in less than 25 ms, protecting you and your workers.

Rule 76-016 of the Canadian Electrical Code (2006 and 2009) states that, on demolition and construction projects, all 15 A and 20 A temporary receptacles (e.g. extension cords) MUST be protected with a Class A type GFCI.

Many provinces also require that ALL receptacles used to power portable tools and equipment MUST be protected with a Class A GFCI.

GFCI PROTECTED TRI-CORDS

- Features three NEMA 5-15R receptacles at the end of a heavy-duty molded T-head
- Perfect for outdoor, rugged, construction type environments
- 2' 12/3 SJTW cord
- 120 V/15 A
- Available with right angle plug (XA468) or with in-line plug (XC519)
- Certified for sale in Canada by an accredited certification body

Model No. XA468

Price/Each \$

Model No. XC519

Price/Each \$



PLUG & CORD SETS

- Ideal for use with any equipment used in or around wet areas
- Rainproof rated with booted test and reset buttons
- 9" 14/3 SJTW cord
- NEMA 5-15 P & R, 120 V/15 A
- Certified for sale in Canada by an accredited certification body

Model No. XA463

Price/Each \$



GFCI QUAD OUTLET BOXES

- Four GFCI protected NEMA 5-15R outlets enclosed in an impact resistant polymer case with spring-loaded covers
- 15 A "fast breaker" is built into the box for convenient reset should an overload condition occur
- 6' 12/3 SJTW cord
- 120 V/15 A
- Certified for sale in Canada by an accredited certification body

Model No. XA467

Price/Each \$



IN-LINE GFCI CORD SETS

- Excellent for use with high pressure washers, power drain snakes, submersible pumps and any equipment used in or around wet areas
- Rainproof rated with booted test and reset buttons
- Standard 14" length (other lengths available upon request)
- Certified for sale in Canada by an accredited certification body

NOTE: XA466 includes 120 V/20 A straight blade ends



Model No.	Cord Type	NEMA P & R	Volts /Amps	Price /Each
XE722	12/3 SJTW	5-15	120 V/15 A	
XA466	12/3 SJTW	5-20	120 V/20 A	

SHOCKSAFE® INLINE GFCI TRIPLE-TAP ADAPTER

- Triple lighted tap
- 3' 12/3 SJTW cord
- 125 V/15A

Model No. XC614

Price/Each \$



GFCI & CIRCUIT TESTER

- Increasing the test impulse setting until the GFI trips, will determine the leakage-current trip point for the GFCI under test
- Meter produces adjustable mA test impulses at 4-second intervals
- Tests and indicates condition of GFCI's and circuits
- Easy-to-read indicator lights display wiring errors
- Adjustable test impulses:
 - 0 mA and 3 mA trip - unit too sensitive
 - 5 mA and 7 mA trip - unit acceptable
 - 10 mA and 30 mA trip - unit not safe

Model No. HC704

Price/Each \$



EXTENSION CORDS & OUTLETS

GFCI OUTLET ADAPTORS W/SURGE PROTECTION

- Small size (less than 2" W x 3" H) makes them ideal for the toolbox
- **XB069** includes booted test and reset buttons
- NEMA 5-15 P & R, 120 V/15 A
- Certified for sale in Canada by an accredited certification body

Model No. XB069 Yellow
Price/Each \$



USER ATTACHABLE GFCI PLUGS

- Replaces any standard NEMA 5-15 P plug on cords between 12-18 AWG (SJT)
- For use where the GFCI is needed as a permanent part of the tool or appliance
- Rainproof rated with booted test and reset buttons
- NEMA 5-15 P, 120 V/15 A
- Certified for sale in Canada by an accredited certification body

Model No. XA462
Price/Each \$



USER ATTACHABLE INLINE GFCI

- Easily wires onto cord between 12-18 AWG (SJT)
- Can be placed at any location on the cord set
- Rated for up to 20 amps to allow for use on equipment that operates on either a 15 A or 20 A circuit
- For use where the GFCI is needed as a permanent part of the tool or appliance
- Rainproof rated with booted test and reset buttons
- 120 V/20 A
- Certified for sale in Canada by an accredited certification body

Model No. XB070
Price/Each \$



AC VOLTAGE DETECTORS

- Detects for the presence of AC voltage without contact
- Signals the presence of voltage with an LED light and audible buzzer
- Built-in flashlight
- Doubly-insulated housing for increased safety
- UL approved
- Cat. III 1000V, Cat. IV 600V safety ratings
- AC Voltage Range: 90 to 1000V
- Max. Working Current: 32mA
- Includes: 2 "AAA" alkaline batteries



REED

Model No.	Mfg. No.	Description	Price /Each
IA976	R5100	AC Voltage Detector	

FLOORTRAKS®

- Ideal for cables that run over the floor where portable cords and cables cannot be concealed
- Flexible, non metallic cover
- Protects, organizes and reduces trip hazards
- Available in three different sizes
- Handles cables up to 1.25" (31.8 mm) in diameter

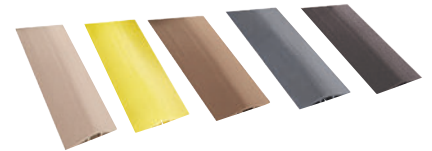

DIMENSIONS OF FLOORTRAKS®

FloorTrak®	2	3	4
Width	2.75"	3.00"	3.25"
Height	0.53"	0.75"	1.10"
Ctr. Hole	0.60" x 0.31"	0.75" x 0.50"	1.21" x 0.75"



Model No.					Description	Length'	Price /Each
Black	Brown	Beige	Grey	Yellow			
XA042	XA038	XA005	XA001	XA039	FloorTrak® 2	10	
XA009	XA041	XA040	XA006	XA245	FloorTrak® 3	5	
XA043	-	-	-	XA046	FloorTrak® 4	5	

SURGE PROTECTOR

- Provides extra power for home electronics
- Clear Power® auto shut-off safeguard
- \$100,000 connected equipment warranty
- No. of Outlets: 6
- Cord Length: 4'
- Rated Joules: 1000 J
- Voltage: 12 V

Model No. XC300
Mfg.No PB802225
Price/Each \$

PRIME®



1150 JOULES SURGE PROTECTORS

- Provide extra power outlets for home electronics in the workshop, the kitchen, or the office
- Features high energy absorbing joule ratings and EMI/RFI filters
- Clear Power® auto shutoff safety device shuts power off after absorbing a major spike
- Lighted On/Off circuit breaker switch
- 6 outlet black metal housing prevents damage to the casing
- 14/3 SJT snug plug low profile power cord
- 15 A, 1875 W
- \$200,000 connected equipment warranty
- Length: 15'

Model No. XC042
Mfg.No PB802135
Price/Each \$

PRIME®



EXTENSION CORDS & OUTLETS

750 JOULES 6-OUTLET SURGE PROTECTORS

- Provides extra power for home electronics
- Features high energy joule rating
- Clear Power® auto shut-off safeguard shuts power off after absorbing a major spike
- \$100 000 connected equipment warranty

Model No. XC299
Price/Each \$



400 JOULES 6-OUTLET SURGE PROTECTOR

- 125 V / 15 A, 1875 W
- Clear Power® auto shut-off safeguard shuts power off after a major spike
- \$100 000 connected equipment warranty

Model No. XC616
Price/Each \$



ROTATING SURGE TAPS

- 6 protected grounded rotating outlets
- 2160 Joules, 15 A / 125 V
- Clear Power® auto shut-off safeguard shuts power off after a major spike
- \$300 000 connected equipment warranty

Model No. XC621
Price/Each \$



SURGE SUPPRESSOR

- Ideal for multiple electronic devices
- Lighted on/off switch with built-in circuit breaker
- Protects against damage caused by power spikes
- No. of Outlets: 6
- Cord Length: 3'
- Rated Jules: 200
- Max. Amps: 15 A
- Wattage: 1875 W

Model No. XE670
Price/Each \$



4', 12-OUTLET POWER BARS

- Provides extra power for home electronics
- 6', 14/3 extension cord
- Lighted on/off circuit breaker
- Mounting hardware included
- 5-year warranty

Model No. XC291
Price/Each \$



AIR CONDITIONER & MAJOR APPLIANCES EXTENSION CORDS

- Molded-on bonded vinyl plugs and connectors will not break off or pull
- Cord resists cracking and breaking
- 3-conductor SPT-3
- 15 A, 1875 W
- 14/3 SPT cable



Model No.	Length'	Price /Each
XC156	3	
XC157	6	

For air conditioners, please see pages 1469-1470



WORKSHOP STRIPS

- Additional grounding outlets from a single outlet source
- 8 outlets: 5 standard, 3 wide space
- 6', 14/3 cord
- 15 A, 1875 W
- Metal housing prevents damage to the casing
- Lighted on/off circuit breaker switch for overload protection
- Indoor use only
- 5-year warranty



Model No.	Description	Price /Each
XC040	8 outlet metal shop box	



GENERATOR "Y" CORDS

- 20 A T-blade plug to 20 A T-slot connectors
- Enables user to draw full 20 A load (5 more amps than a standard U-Ground connector)
- 25' 12/3 STOW wire
- 20 A / 125 V / 2500 W
- Primelight® power indicator light indicates when power is ON
- Double-jacketed, super abrasion resistant
- Oil and water resistant
- Flame retardant
- Ultra-flexible in extreme temperatures from -58°F up to +221°F (-50°C up to +105°C)
- For use with virtually all generators
- Used for lighting, small air conditioners, air compressors, water pumps, power tools and equipment with 1 HP rating

Model No. XD001
Price/Each \$



EXTENSION CORDS & OUTLETS

USB CHARGING SURGE PROTECTORS

- Housing Material: ABS Plastic
- Plug Type: Right Angle
- 2.1 Amp USB charging ports
- Protected and grounded indicator lights
- Lighted ON/OFF switch
- Amps: 15 Amps
- Wattage: 1875 W
- Voltage: 125 V



PRIME



XG813



XG811



XG809

Model No.	Total No. of Outlets	Cord Length"	Rated Joules	No. of USB Ports	Colour	Transformer Outlet	Price /Each
XG809	4	4	1200	2	White	1 Convenient Transformer-Spaced Outlet	
XG811	6	4	1800	2	White	1 Convenient Transformer-Spaced Outlet	
XG810	8	8	4200	2	White	3 Convenient Transformer-Spaced Outlet	
XG812	8	6	3600	2	Black	3 Convenient Transformer-Spaced Outlet	
XG813	12	6	4200	2	Black	6 Convenient Transformer-Spaced Outlet	

PRIME® USB CHARGERS

- Includes LED charging light
- Space-saving design

XG785



XG781



Model No.	Mfg. No.	No. of USB Charging Ports	No. of Outlets	Joule Rating	Price /Each
XG785	PBUSB340	2 (3.4A)	0	-	
XG784	PBUSB241S	1 (2.4A)	1	150	
XG780	PBUSB242	2 (2.4A)	2	-	
XG783	PBUSB342S	2 (3.4A)	2	450	
XG782	PBUSB343S	2 (2.1A)	3	950	
XG781	PBUSB346S	2 (2.1A)	6	1200	

aurora tools

Tools for industry...
made to last.

EXTENSION CORDS & OUTLETS

ISOBAR® PREMIUM SURGE SUPPRESSORS

- Virtually indestructible all-metal housing for added protection and longer life
- Isolated filter banks eliminate cross interference
- "Cascade Circuitry" provides increasing levels of noise rejection
- 3 Diagnostic LEDs to provide advance warning of potential power problems
- Meets stringent UL1449 (2nd edition), UL 1283, UL 1363 and cUL standards with UL's highest performance 330 V
- Instantaneous (0 nanoseconds) surge response time
- Ultimate Lifetime Insurance covers the Isobar® and connected equipment against surge damage for life



Model No.	AC Receptacles	Cord Length'	Isolated Filter Banks	Energy Surge Rating Joules	Surge Current Rating Amps	Price /Each
OD751	4	6	2	3330	85 000	
OD752	6	6	3	2850	92 000	
OD753	8	12	4	3840	92 000	

PROTECT-IT SURGE SUPPRESSORS

- Multi-Stage suppression circuitry safeguards equipment against lightning and surge damage
- EMI/RFI Noise rejection reduces computer lock-ups, data errors, audio, static and video interference
- Protected LED indicator
- Meets stringent UL1449 (2nd edition) and cUL standards with UL's highest performance (330 V)
- Ultimate Lifetime Insurance covers connected equipment against surge damage for life
- Colour: Computer Grey
- Lifetime Warranty

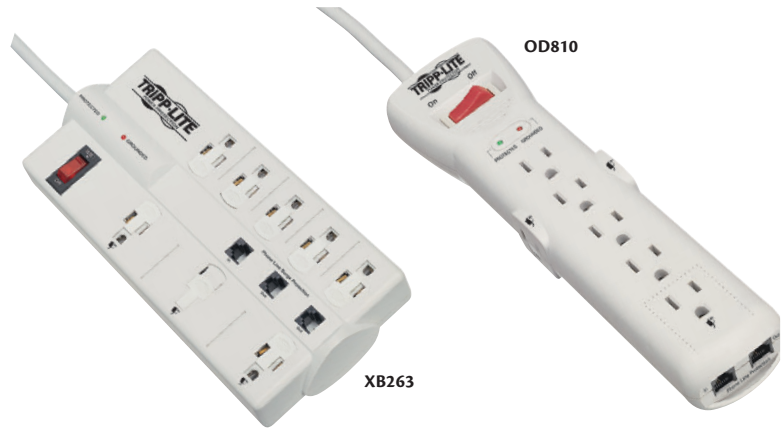

Model No.	Outlets	Cord Length'	Fax/Modem/Phone (RJ11)	Joule Rating	Grounded LED Indicator	Multiple Transformer Outlets	Ultimate Lifetime Insurance	Price /Each
XB262	6	4	1 in/1 out	720	No	No	\$20 000	
OD809	7	6	1 in/1 out	1080	No	Yes	\$50 000	
OD755	7	7	No	2160	Yes	Yes	\$75 000	
OD810	7	7	1 in/1 out	2470	Yes	Yes	\$75 000	
XB263	8	8	1 in/2 out	2160	Yes	Yes	\$150 000	

STANDBY UPS SYSTEMS

These systems provide complete protection against all types of power problems (brownouts, blackouts, surges and line noise). Up to 450 VA of battery backup gives you time to save your open files and safely shut down your computer in the event of a prolonged brownout or a blackout. In addition, BC Personal® UPS stops damaging lightning and surges. \$25 000 Ultimate Lifetime Insurance coverage guarantees your equipment will stay safe from surge damage for life!



Model No.	Description	Price /Each
OD757	Personal® 350 VA UPS, 6 outlets	
OD758	Personal® 550 VA UPS, low battery light, self-test, 8 outlets	
OD759	Internet Office, 900 VA UPS, 2-line fax/phone protection, 8 outlets	



BOOSTER CABLES

- Clamp design fits on both top-post and side-post batteries
- Surge suppressor on 2, 4, and 6 gauge cables protect a vehicles computer system from power surges during boosting
- Cable remains flexible in temperatures as low as -40°C
- Tangle-free



aurora tools®

Model No.	Wire Gauge	Amps	Length'	Price /Each
XE494	8	150	10	
XE495	6	400	16	
XE496	4	400	20	
XE497	2	400	20	



EYEWEAR
SPILL CONTROL

SAFETY

TRAFFIC CONTROL
GLOVES

ZENITH[®]

Safety Products

Contact us today!

MULTIMETERS & VOLTAGE TESTERS

AC VOLTAGE DETECTORS

- Detects for the presence of AC voltage without contact
- Signals the presence of voltage with an LED light and audible buzzer
- Built-in flashlight
- Doubly-insulated housing for increased safety
- UL approved
- Cat. III 1000V, Cat. IV 600V safety ratings
- Includes batteries
- AC Voltage Range: 90 to 1000V
- Max. Working Current: 32mA
- Power Supply: 2 "AAA" alkaline batteries



REED

Model No.	Mfg. No.	Description	Price/Each
IA976	R5100	AC Voltage Detector	

REED R5200 OUTLET CIRCUIT TESTERS

- Tests whether the outlet is properly wired
- Can perform the entire array of tests by simply plugging the device into the outlet
- One light shows a voltage difference between hot and neutral slots, another shows a voltage difference between the hot slot and the ground hole, and a third shows a voltage difference between the neutral slot and the ground hole
- Easy to read light pattern chart
- Meets LVD:EN 61010-1:2010, EMC:EN61326-1:2006, EN61000-3-2:2006+ A2:2009, EN61000-3-3:2008
- Voltage range: 110-125 VAC



REED

Model No.	Mfg. No.	Description	Price/Each
IB741	R5200	Outlet Circuit Testers	

STUD, METAL AND VOLTAGE DETECTORS

- Find studs, metal and detect the presence of AC voltage with this 3-in-1 multi-scanner
- Features an LCD display with bar graph allowing for quick and accurate detection
- Ergonomically designed for comfort and grip
- Auto power-off after 20 seconds
- Stud Detection Depth: Up to 0.98" (25mm)
- Metal Detection Depth: Up to 2.56" (65mm)
- Voltage Detection Depth: Up to 1.96" (50mm)
- Low Battery Indicator: Yes
- Power Supply: 9V Battery
- Operating Temperature: 19.4 to 104°F (-7 to 40°C)
- Storage Temperature: -4 to 122°F (-20 to 50°C)
- Max. Depth Scanned: 2-4/7"
- Alert Type: Display



REED

Model No.	Mfg. No.	Description	Price/Each
IB898	R9090	Stud, Metal and Voltage Detector	

MULTIMETERS

- Non-contact voltage detector
- Diode check and continuity test
- Flashlight
- Auto power off
- Double molded housing and test leads
- EN61010-1 Cat. III, 1000 V safety rating
- 0.2 A/500 V resettable fuse protection
- 2000-count LCD
- AC voltage range: 100 to 600 V
- Auto-ranging multimeter
- AC/DC voltage range: 600 V
- AC/DC current range: 200 mA
- Resistance range: 20 MΩ



Model No.	Mfg. No.	Description	Price/Each
IA050	SI-118	Voltage Detector/Multimeter	

REED R5006 DIGITAL MULTIMETERS

- Pocket-sized, auto-ranging digital multimeter
- Measures AC/DC voltage and current, resistance, frequency, capacitance and duty cycle
- Diode test and continuity check functions
- Data hold and relative mode
- 4000-count LCD display
- Low battery indicator and auto power-off
- Conforms with IEC61010 Cat. II 600V
- Includes test leads, battery and carrying case



REED

SPECIFICATIONS:

AC Range:	4, 40, 400, 600 V
DC Range:	400 mV, 4, 40, 400, 600V
AC Resolution:	1, 10, 100 mV, 1 V
DC Resolution:	0.1, 1, 10, 100 mV, 1 V
AC/DC Current Range:	400, 4000 μA, 40, 400 mA
AC/DC Current Resolution:	0.1, 1, 10, 100 μA
AC/DC Accuracy:	±(2% rdg. + 5 dgt.), ±(0.8% rdg. + 1 dgt.)
Capacitance Range:	4,000, 40,000, 400.0 nF, 4,000, 40,000, 100 μF
Resistance Range:	400 Ω, 4, 40, 400 kΩ, 4, 40 MΩ
Frequency Range:	99.9 Hz, 0.999, 9.99, 99.9 kHz

Model No.	Mfg. No.	Description	Price/Each
IB740	R5006	Digital Multimeter	

ELECTRICAL TEST KIT

- Kit includes the tools to troubleshoot common electrical problems (digital multimeter, AC voltage detector, receptacle tester and soft carrying case)



REED

Model No.	Mfg. No.	Description	Price/Each
IB867	R5006-KIT	Test Kit	

DIGITALS MULTIMETERS

- 0.5% basic DC accuracy
- 4000-count resolution
- Diode check and continuity test
- Data hold function
- Auto ranging and auto power off
- Double molded plastic housing
- EN61010-1 Cat. III 600 V safety rating
- Includes Type K temperature probe, test leads and 9 V battery

Model No. IA406
Mfg. No. R5008
Price/Each \$

FUSED TEST LEAD SETS

Model No. IA707
Mfg. No. FC-300
Price/Each \$

REED

CARRYING CASE

Model No. HN413
Mfg. No. CA-52A
Price/Each \$

AC CURRENT CLAMP-ON ADAPTERS

Model No. IA184
Mfg. No. CP-09
Price/Each \$

SPECIFICATIONS:

AC/DC Voltage Range:	600 V
Accuracy:	AC: ± 1.2%; DC: ± 0.5%
AC/DC Current Range:	10 A
Accuracy:	AC: ± 3.0%; DC: ± 2.5%
Resistance Range:	40 MΩ
Accuracy:	± 0.8%
Frequency Range:	10 MHz
Accuracy:	± 1.5%
Capacitance Range:	200 μF
Accuracy:	± 3.0%
Duty Cycle Range:	99.9%
Accuracy:	± 1.2%
Temperature Range:	760°C (1400°F)
Accuracy:	± 3.0%
Dimensions:	150 x 70 x 48 mm
Weight:	255 g



MULTIMETERS & VOLTAGE TESTERS

TRUE RMS MULTIMETER

- AC and DC voltage and current, resistance, capacitance, frequency and duty cycle measurements
- 10MHz frequency counter
- Temperature measurement capability
- True RMS AC voltage and current measurements
- Min/Max/Avg and Peak hold (>1ms) functions
- Store up to 10 000 recorded events
- Real time clock for automatic time stamping of readings
- Log multiple sessions or log data continuously for over 200 hours
- 50 000-count graphical LCD with backlight displays multiple sets of measurement data simultaneously
- Bluetooth interface
- IP67 rated waterproof

IA981



SPECIFICATIONS:

AC/DC Voltage Range:	50, 500 mV, 5, 50, 500, 1000 V
Resolution:	0.001, 0.01 mV, 0.0001, 0.001, 0.01, 0.1 V
Accuracy:	AC: $\pm(0.3\% \text{ rdg.} + 25 \text{ dgt.})$ (50/60 Hz); DC: $\pm(0.025\% \text{ rdg.} + 5 \text{ dgt.})$
AC/DC Current Range:	500, 5000 μA , 50, 500 mA, 10 A
Resolution:	0.01, 0.1 μA , 0.001, 0.01 mA, 0.001 A
Accuracy:	AC: $\pm(0.6\% \text{ rdg.} + 25 \text{ dgt.})$ (50/60 Hz); DC: $\pm(0.15\% \text{ rdg.} + 20 \text{ dgt.})$
Resistance Range:	50, 500 Ω , 5, 50, 500 k Ω , 5, 50 M Ω
Resolution:	0.001, 0.01 Ω , 0.0001, 0.001, 0.01 k Ω , 0.01, 0.001 M Ω
Accuracy:	$\pm(0.05\% \text{ rdg.} + 10 \text{ dgt.})$
Capacitance Range:	5, 50, 500 nF, 5, 50, 500 μF , 10 mF
Resolution:	0.001, 0.01, 0.1 nF, 0.001, 0.01, 0.1 μF , 0.01 mF
Accuracy:	$\pm(2\% \text{ rdg.} + 40 \text{ dgt.})$
Frequency Range:	50, 500 Hz, 5, 50, 500 kHz, 5, 10 MHz
Resolution:	0.001, 0.01 Hz, 0.0001, 0.001, 0.01 kHz, 0.0001, 0.001 MHz
Accuracy:	$\pm(0.01\% \text{ rdg.} + 10 \text{ dgt.})$
Temperature Range:	-50 to 1000°C (-58 to 1832°F)
Resolution:	0.1°C (0.1°F)
Accuracy:	$\pm(1.0\% \text{ rdg.} + 2.5^\circ\text{C} (4.5^\circ\text{F}))$

DIGITAL MULTIMETERS

- True RMS AC/DC voltage and current measurements
- 0.05 % basic DC accuracy
- 40 000-count resolution
- Measures frequency, capacitance and temperature
- Diode check and continuity test
- Backlit LCD readout with analog bar graph
- 1000 V input protection on all ranges
- 4-20 mA process loop measurements with % readout
- Data hold, Max/Min recording mode
- Peak capture mode
- IP67 dust and waterproof
- EN61010-1 Cat. IV 600 V, Cat. III 1000 V safety rating
- Includes test leads and 9 V battery

XC308



SPECIFICATIONS:

AC/DC Voltage Range:	1000 V
Accuracy:	AC: $\pm 1.0\%$; DC: $\pm 0.05\%$
AC/DC Current Range:	10 A
Accuracy:	AC: $\pm 1.5\%$; DC: $\pm 1.0\%$
Resistance Range:	40 M Ω
Accuracy:	$\pm 0.3\%$
Frequency Range:	10 MHz
Accuracy:	$\pm 0.1\%$
Capacitance Range:	40 mF
Accuracy:	$\pm 3.5\%$
Duty Cycle Range:	99.9%
Accuracy:	$\pm 1.2\%$
Temperature Range:	760°C (1400°F)
Accuracy:	$\pm 1.0\%$
Dimensions:	182 x 82 x 55 mm
Weight:	360 g

REED

Model No.	Mfg. No.	Description	Price/Each
IA981	R5005	True RMS Multimeter	
IA184	CP-09	AC Current Adapter	
IA182	FC-A15	Safety Alligator Clips	

REED

Model No.	Mfg. No.	Description	Price/Each
XC308	R5010	Digital Multimeter	
IA707	FC-300	Fused Test Lead Sets	
IA184	CP-09	AC Current Clamp-On Adapters	
HN413	CA-52A	Carrying Case	

AC/DC CLAMP-ON ADAPTERS

- Range: 0 to 200 A AC/DC, 0 to 2000 A AC/DC
- Accuracy: $\pm 2\%$ up to 200 A, $\pm 3\%$ up to 1500 A w/ push button zero
- Output: 1 mV per 1 A
- Jaw Opening: 2 1/2" (64 mm)

Model No. IA437
Mfg. No. CA-203
Price/Each \$



REED

AC CURRENT CLAMP-ON ADAPTERS

- Ideal tool to extend the current range for all multimeters
- AC current range: 200 A
- Voltage output of 1 mV/A via standard banana inputs

Model No. IA184
Mfg. No. CP-09
Price/Each \$



REED

MULTIMETER ACCESSORIES

MODEL HX357

- Enables clamp meter user to measure AC current on a 2-wire or 3-wire power cord to 15 A
- Provides easy and safe measurements of current without the need to cut off the plug and separate the conductors
- Plugging the power connector into the line splitter separates the hot/live conductor from the neutral and ground

MODEL HX358

- Adapts mini-connector inputs to banana plug inputs
- Can be used with many of the thermocouple probes



HX358

HX357



REED

Model No.	Mfg. No.	Description	Price/Each
HX357	R5400	AC Line Splitter	
HX358	AD-1	Input Adapter	

MULTIMETER COMBO KIT

- **IA406** autoranging digital multimeter with temperature function
- **HX394** AC/DC current clamp meter with temperature function
- **IA976** non-contact voltage detector with built-in flashlight
- **HX358** temperature input adapter with **HK953** type K thermocouple wire probe
- **HX357** AC line splitter
- **IA181** safety test leads
- **IA707** fused test leads set
- **IA434** carrying case

Model No. **IA658**
Mfg. No. ST-MULTIKIT
Price/Each \$

REED



INDUSTRIAL COMBO KIT

- Includes: **XC308** True RMS waterproof digital multimeter, **IA982** AC clamp meter, **IB537** compact infrared thermometer, **IA976** non-contact AC voltage detector with flashlight, **HX358** thermocouple adapter, **HK953** beaded thermocouple wire probe, **IA181** safety test lead and **IB872** deluxe hard carrying case

Model No. **IB870**
Mfg. No. RINDUST-KIT
Price/Each \$

REED



ELECTRICIAN'S COMBO KIT

- **XC308** AC/DC TRMS multimeter
- **HX358** temperature input adapter with **HK953** type K thermocouple wire probe
- **IA181** safety test leads
- **IA707** fused test leads set
- **IA184** AC current adapter
- **HX357** AC line splitter
- **IA434** carrying case

Model No. **IA859**
Mfg. No. ST-ELECTRICKIT2
Price/Each \$

REED



HVAC COMBO KITS

- True RMS multimeter and clamp meter combo kit
- **XC308** True RMS AC/DC multimeter with temperature function
- **IB065** True RMS AC/DC clamp meter with temperature function
- **IA045** non-contact voltage detector with built-in flashlight
- **HX358** temperature input adapter with **HK953** thermocouple wire probe
- **IA181** safety test leads

Model No. **IA537**
Mfg. No. ST-HVACKIT
Price/Each \$

REED



TEMPERATURE COMBINATION KIT

- Includes: **IA406** compact digital multimeter with temperature, **IB337** compact infrared thermometer, **IA976** non-contact AC voltage detector with flashlight, **HX358** thermocouple adapter, **HK953** beaded thermocouple wire probe, **IA181** safety test lead set and **IB742** deluxe hard carrying case

Model No. **IB871**
Mfg. No. RTEMP-KIT
Price/Each \$

REED



ELECTRICAL TROUBLESHOOTING KIT

- Plug the transmitter into a receptacle and scan breaker box to identify the circuit
- Detects 5 3-wire receptacle wiring faults
- Built-in GFCI receptacle check function
- Adjustable sensitivity wheel quickly identifies breaker
- Audible (buzzer) and visual (LED) indicators assist in identification
- Display Type: Indicator Light
- Voltage Range: 90 to 120V AC
- Bandwidth: 47 to 63Hz
- Power Supply: 9V Battery
- Operating Temperature: 32 to 104°F (0 to 40°C)
- Storage Temperature: 4 to 140°F (-20 to 60°C)

Model No. **IB869**
Mfg. No. R5500-KIT
Price/Each \$

REED



LEADS, CLIPS & TEST PROBES

MODEL IA171

- ø4 mm safety test leads
- Silicone-insulated
- 100 cm long
- Right angle sheathed banana plug to straight sheathed banana plug
- Set of two, one black and one red
- **IA171** to be used in conjunction with items listed below

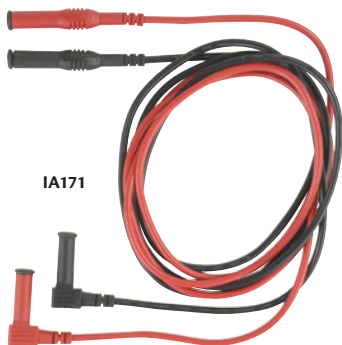

IA171

MODEL IA172

- Safety alligator clips



IA172

MODEL IA173

- Push-on safety test clips with strong jaws
- Insulated, nickel-plated jaws grip objects up to 3/8"
- Blunt grip grabs round screw heads



IA173

MODEL IA174

- Tips include banana-style spring contacts with nickel-plated brass ends
- Ideal for probing banana plug receptacles



IA174

MODEL IA175

- Push-on safety test probes with stainless steel tips
- Rigid with protective caps



IA175

MODEL IA176

- Industrial test probes with stainless steel tips



IA176

MODEL IA177

- Safety jaw clips

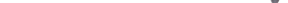

MODEL IA178

- Electronic test probes
- Tapered tips for probing electronic components or boards
- Removable guard for IC probing



IA178



IA175



IA177



Model No.	Mfg. No.	Description	Price/Each
IA171	FC-108	Safety Test Leads	
IA172	FC-A23	Safety Alligator Clips	
IA173	CF-734760	Safety Test Clips	
IA174	FC-105	Safety Test Probes	
IA175	FC-105 A	Safety Test Probes	
IA176	FC-170 A	Industrial Test Probes	
IA177	FC-178 A	Safety Jaw Clips	
IA178	FC-A18	Electronic Test Probes	

BASIC TEST LEADS

MODEL IA181

- Set of two 48" long leads, one black and one red
- Flexible silicone-insulated safety test leads are heat and cold resistant
- Distinctive comfort grip test probes with stainless steel tips



IA181

MODEL IA182

- Slide-on style for test probes
- Jaws open to 8 mm

MODEL IA183

- Same as **IA181** with **IA182** alligator clips



IA182

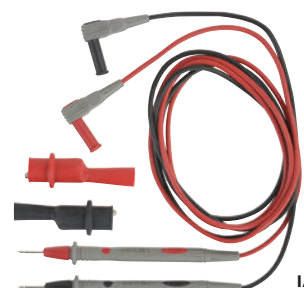

IA183



Model No.	Mfg. No.	Description	Price/Each
IA181	TL-88-1	Safety Test Leads	
IA182	FC-A15	Safety Alligator Clips	
IA183	TL-88-A15	Safety Test Lead and Alligator Clips	

FUSED TEST LEAD SETS

- Lead length: 1.4 meters
- Compatible with all instruments that accept standard 4 mm shrouded banana connectors



Model No.	Mfg. No.	Description	Price/Each
IA707	FC-300	Fused Test Lead Set	

TEST LEAD KITS

MODEL IA179

- Safety test lead kit (electrical) includes:
 - IA171 safety test leads
 - IA172 alligator clips
 - IA175 test probes
 - HX360 carrying case



IA179

MODEL IA180

- Deluxe safety test lead kit (electrical) includes:
 - IA181 safety test leads
 - IA171 safety test leads
 - IA182 alligator clips
 - IA172 alligator clips
 - IA178 electronic test probes
 - IA174 test probes
 - IA175 test probes
 - IA176 industrial test probes
 - IA177 safety jaw clips
 - IA173 test clips
 - HX360 carrying case



IA180



Model No.	Mfg. No.	Description	Price/Each
IA179	FC-108G	Safety Test Lead Kit	
IA180	FC-A23G	Deluxe Safety Test Lead Kit	

PELICAN PROTECTOR EQUIPMENT CASES

Light, strong, watertight and airtight for the ultimate protection. Constructed of copolymer and polypropylene. Features a 1/4" neoprene O-ring seal and a purge valve. Supplied complete with pre-scored pick & pluck foam or padded dividers (no cutting required). Custom foam insert fabricated on special order. Also includes ABS locking flanges, massive multiple latches and a comfortable molded grip handle.

Note: Models **HA597** and **HA603** supplied with solid foam only.

- Other colours available for Mfg. No. 1700 to 1750 are desert tan and green
- Other colours available for Mfg. No. 1200 to 1600 are silver, desert tan and green



FEATURES:



O-Ring Seal: Exclusive 1/4" neoprene O-ring guarantees a perfect seal. Neither dust nor water can penetrate this barrier to damage your equipment. These rings are easily replaced if damaged.



Purge Valve: All cases are absolutely airtight. Exclusive built-in O-ring sealed pressure purge valve allows for quick equalization after changes in temperature or altitude.

MODEL NO. HA292

Outside Dimensions:
10 5/8" L x 9 11/16" W x 4 7/8" D
Inside Dimensions:
9 1/4" L x 7 1/8" W x 4 1/8" D
Fold-down handle.
Weight: 2.87 lbs.

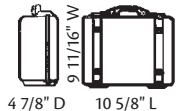

MODEL NO. HA419

Outside Dimensions:
10 5/8" L x 9 11/16" W x 6 7/8" D
Inside Dimensions:
9 1/8" L x 7" W x 6 1/8" D
Fold-down handle.
Weight: 3.53 lbs.

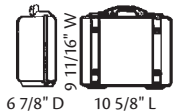

MODEL NO. HA450

Outside Dimensions:
13 3/8" L x 11 5/8" W x 6" D
Inside Dimensions:
11 13/16" L x 8 7/8" W x 5 3/16" D
Fold-down handle.
Integral personalised nameplate.
Weight: 4.41 lbs.

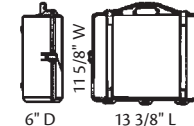

MODEL NO. HA501

Outside Dimensions:
18 1/2" L x 14 1/16" W x 6 15/16" D
Inside Dimensions:
16 3/4" L x 11 3/16" W x 6 1/8" D
Fold-down handle.
Integral personalised nameplate.
Weight: 7.05 lbs.

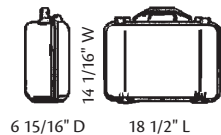

MODEL NO. HM576

Outside Dimensions:
19.78" L x 15.77" W x 7.41" D
Inside Dimensions:
18.06" L x 12.89" W x 6.72" D
Fold-down handle.
Weight: 9.35 lbs.

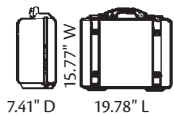

MODEL NO. HA510

Outside Dimensions:
20 5/8" L x 16 7/8" W x 8 1/8" D
Inside Dimensions:
18 7/16" L x 14" W x 7 5/8" D
Fold-down handle.
Integral personalised nameplate.
Weight: 11.9 lbs.

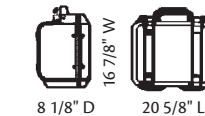

MODEL NO. HA536

Outside Dimensions:
24 1/4" L x 19 7/16" W x 8 11/16" D
Inside Dimensions:
21 7/16" L x 16 1/2" W x 7 7/8" D
Fold-down handle.
Integral personalised nameplate.
Weight: 14.11 lbs.

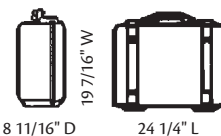

MODEL NO. HA597

Outside Dimensions:
38 1/8" L x 16" W x 6 1/8" D
Inside Dimensions:
35 3/4" L x 13 1/2" W x 5 1/4" D
Fold-down handle.
Weight: 16.98 lbs.

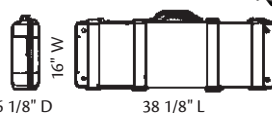

MODEL NO. HA603

Outside Dimensions: 53" L x 16" W x 6 1/8" D
Inside Dimensions: 50 1/2" L x 13 1/2" W x 5 1/4" D
Fold-down handle.
Weight: 25.57 lbs.

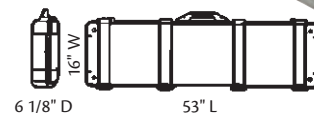

PROTECTIVE CASES

Black Model No.	Orange Model No.	Mfg. No.	Description	Price /Each
HA292	HA293	1200	1200 Case	
HA419	HA420	1300	1300 Case	
HA450	HA451	1400	1400 Case	
HA501	HA502	1500	1500 Case	
HM576	-	1520	1520 Case	
HA510	HA511	1550	1550 Case	
HA536	HA537	1600	1600 Case	
HA597	-	1700	1700 Case	
HA603	-	1750	1750 Case	

FOAM INSERTS

Model No.	Mfg. No.	Description	Price/Each
HA296	1201	3 pc. foam insert for HA292, HA293	
HA423	1301	3 pc. foam insert for HA419, HA420	
HA460	1401	3 pc. foam insert for HA450, HA451	
HA503	1501/A	3 pc. foam insert for HA501, HA502	
HA512	1551	4 pc. foam insert for HA510, HA511	
HA538	1601	4 pc. foam insert for HA536, HA537	
HA599	1701	3 pc. foam insert for HA597, HA598	
HA605	1751	4 pc. foam insert for HA603	



CLAMP METERS

AC/DC CLAMP METERS

- True RMS measurements
- 3-3/4 digit LCD with high-speed, 42-segment bar graph
- Max/Min and Data Hold functions
- Peak Hold function
- Frequency measurement
- Diode and continuity test with beeper
- Polarity and overload indications
- Auto or manual ranging
- Auto power-off
- Low battery indication
- Conforms to EN61010 1000V Cat. II, 600V Cat. III
- Includes IA181 test leads, 6AM6X battery and HN416 carrying case
- Accredited calibration available

HX161



SPECIFICATIONS:

Current Range:	40A, 400 A, 1000 A AC/DC
Resolution:	0.01 A, 0.1 A, 1 A AC/DC
Accuracy:	AC: $\pm(1.9\% \text{ rdg.} + 5 \text{ dgt.})$; DC: $\pm(2.5\% \text{ rdg.} + 10 \text{ dgt.})$
Voltage Range:	AC: 400 V, 750 V; DC: 400 V, 1000 V
Resolution:	0.1, 1 V AC/DC
Accuracy:	AC: $\pm(1.5\% \text{ rdg.} + 5 \text{ dgt.})$; DC: $\pm(1\% \text{ rdg.} + 2 \text{ dgt.})$
Resistance Range:	400 Ω , 4000 Ω
Resolution:	0.1 Ω , 1 Ω
Accuracy:	$\pm(1\% \text{ rdg.} + 3 \text{ dgt.})$
Frequency Range:	A & V: 4 kHz, 10 kHz
Resolution:	1 Hz, 10 Hz
Accuracy:	A-Hz: $\pm(0.1\% \text{ rdg.} + 1 \text{ dgt.})$ (20 Hz-10k Hz); V-Hz: $\pm(0.1\% \text{ rdg.} + 1 \text{ dgt.})$ (10 Hz-10 kHz)
Continuity Range:	< 100 Ω
Test Current Range:	1.7 mA max.
Power Supply:	Single 9 V battery
Battery Life:	Approx. 100 hours
Jaw Opening:	40 mm
Dimensions:	242 x 66 x 36 mm
Weight:	400 g



Model No.	Mfg. No.	Description	Price/Each
HX161	R5050	True RMS AC/DC Clamp Meter	
HX357	AC-006	AC Line Splitter	
IA707	FC-300	Fused Test Lead Sets	

AC/DC CLAMP METER

- Measures AC and DC voltage and current, resistance, capacitance and frequency as well as temperature with the included type K thermocouple probe
- True RMS AC measurements
- Diode and continuity test with beeper
- 50000-count digital display with 61-segment analog
- Auto or manual ranging
- Double molded plastic housing
- Conforms to EN61010 600V Cat. III
- Includes test leads, temperature probe, 9 V battery and case
- AC/DC range: 500/1000 A



Model No.	Mfg. No.	Description	Price/Each
IB065	R5040	AC/DC Clamp Meter	
IA707	FC-300	Fused Test Lead Sets	

AC/DC CLAMP METER

- Measures AC current, AC and DC voltage, resistance, capacitance, as well as temperature with the included Type K thermocouple probe
- Diode test and continuity check
- 4000-count LCD displays low battery and overrange indications
- UL approved
- Cat. III 600V safety rating
- Includes one set of test leads, one temperature probe, batteries, and a soft carrying case



SPECIFICATIONS:

AC Current Range:	40.00, 400.0 A
Accuracy:	$\pm(2.5\% \text{ rdg.} + 8 \text{ dgt.})$
DC Voltage Range:	400.0 mV, 4.000, 40.00, 400.0, 600.0 V
Accuracy:	$\pm(1.5\% \text{ rdg.} + 2 \text{ dgt.})$
AC Voltage Range:	4.000, 40.00, 400.0, 600.0 V
Accuracy:	$\pm(1.8\% \text{ rdg.} + 8 \text{ dgt.})$
Resistance Range:	400.0 Ω , 4.000, 40.00, 400.0 M Ω
Accuracy:	$\pm(1.5\% \text{ rdg.} + 2 \text{ dgt.})$
Capacitance Range:	40.00, 400.0 nF, 4.000, 40.00, 100.0 μF
Accuracy:	$\pm(3\% \text{ rdg.} + 5 \text{ dgt.})$
Temperature Range:	-20.0 to 760.0°C (-4.0 to 1400.0°F)
Accuracy:	$\pm(3\% \text{ rdg.} + 5^\circ\text{C}/9^\circ\text{F})$
Jaw Opening:	1.2" (30 mm) maximum
Power Supply:	2 x 1.5V "AAA" batteries
Dimensions:	200 x 66 x 37 mm
Weight:	205 g



Model No.	Mfg. No.	Description	Price/Each
IA982	R5020	AC/DC Clamp Meter	
IA707	FC-300	Fused Test Lead Sets	

TRUE RMS AC/DC CLAMP METER

- Measures AC/DC current, AC/DC voltage, resistance, capacitance, frequency, duty cycle, and temperature with a type K thermocouple probe
- True RMS AC measurements
- Non-contact AC voltage detector in clamp tip
- Low battery indication and auto power-off
- 50000 count LCD with backlight
- Conforms to EN61010 Cat. III 600 V
- Jaw opening: 1.2" (30 mm)
- Includes set of test leads, temperature probe, batteries, and soft carrying case



SPECIFICATIONS:

AC/DC Current Range:	50.00, 500.0 A
Accuracy:	AC: $\pm(2.8\% \text{ rdg.} + 30 \text{ dgt.})$; DC: $\pm(2.5\% \text{ rdg.} + 30 \text{ dgt.})$
AC Voltage Range:	500.00 mV, 5.0000, 50.000, 500.00, 750.0 V
Accuracy:	$\pm(1.0\% \text{ rdg.} + 30 \text{ dgt.})$
DC Voltage Range:	500.00 mV, 5.0000, 50.000, 500.00, 1000.0 V
Accuracy:	$\pm(0.1\% \text{ rdg.} + 4 \text{ dgt.})$
Resistance Range:	500.00 Ω , 5.000, 50.000, 500.00 k Ω , 5.0000, 50.000 M Ω
Accuracy:	$\pm(1.0\% \text{ rdg.} + 4 \text{ dgt.})$
Frequency Range:	10.000 kHz
Accuracy:	$\pm(0.5\% \text{ rdg.} + 10 \text{ dgt.})$
Capacitance Range:	500.00, 5000.0 nF, 50.00, 500.0 μF , 5.000 M μF
Accuracy:	$\pm(3.5\% \text{ rdg.} + 10 \text{ dgt.})$
Temperature Range:	-100.0 to 1000.0°C/-148.0 to 1832.0°F

Model No.	Mfg. No.	Description	Price/Each
IB685	R5030	True RMS AC/DC Clamp Meter	
IA707	FC-300	Fused Test Lead Sets	

INSULATION TESTERS

- Test voltage combinations: 250 V, 500 V or 1000 V
- 1 mA test current for MΩ range at rated voltage
- 200 mA test current for continuity range
- Continuity test with beeper
- Large, easy-to-read dual display with backlight
- Data hold switch
- Test button may be locked on for hands-free operation
- Double moulded plastic housing
- Supplied with test leads, batteries and plastic carrying case
- Meets IEC61010-1 Cat. III 1000 V

SPECIFICATIONS:

Insulation resistance tests

Test Voltage: 250 V, 500 V, 1000 V
Measurement Range: 200 MΩ, 2000 MΩ
Accuracy: ± 3.5 % rdg. ± 5 dgt.

Resistance tests

Measurement Range: 200 Ω, 2000 Ω
Accuracy: ± 1 % rdg. ± 2 dgt.

Voltage tests

Measurement Range: 750 VAC; 1000 VDC
Accuracy: AC: ± 1.2 % rdg. ± 10 dgt.
 DC: ± 0.8 % rdg. ± 3 dgt.

Continuity tests

Measurement Range: Beeps ≤ 40 Ω
Test Current: ≤ 200 mA

General

Power Supply: 6 x 1.5 V AA batteries
Dimensions: 200 x 92 x 50 mm
Weight: 700 g



INSULATION TESTERS

- Measurements from 500 V to 5000 V and up to 60 GΩ
- Sources up to 1.2 mA current during tests to offset capacitance load
- Dielectric absorption ratio measurements (DAR)
- Polarization index measurement (PI)
- Time set measurement function
- Auto-discharge function and voltage output warning function
- Live circuit warning symbols plus audible warning
- Live circuit detection prevents insulation test if >30 V is detected
- Max/Min, Peak, Relative value and Data Hold functions
- 6000-count digital display with bargraph and backlight
- Meets IEC61010-1 Cat. IV 600 V safety standards
- Includes test leads, batteries and carrying case
- Accredited calibration available



SPECIFICATIONS:

Insulation Resistance

Test Voltages:

Insulation Resistance Range:

Resistance Test Range:

Voltage Range:

500 V, 1000 V, 2500 V, 5000 V DC
 0 to 60.0 GΩ
 0.1 to 6000 Ω
 0.5 to 600.0 V AC/DC

REED

Model No.	Mfg. No.	Description	Price/Each
IA194	R5600	Insulation Tester	

REED

Model No.	Mfg. No.	Description	Price/Each
IA855	R5002	Insulation Tester	

CARRYING CASES

PROTECT & STORE YOUR MULTIMETER & ACCESSORIES IN A CARRYING CASE

HX360



HN416



HN413



IA434



IB872



REED

Model No	Mfg. No.	Outside Dimensions			Price /Each
		L"	W"	D"	
IA434	C-833R	11	9	2	
HX360	C-820	8	5	2	
HN416	CA-05 A	9	4	2	
HN413	CA-52 A	7	3	2	
IB742	R8888	13	12	5.8	
IB872	R8890	15.7	12.6	6.7	
IB743	R9999	15.8	7.8	11.8	



IB742



IB743

CAPACITANCE, PHASE & EARTH GROUND TESTERS

PHASE ROTATION INDICATORS

WITH OPEN PHASE CHECKER

- Designed to check the presence of an open phase and also the phase sequence with rotating disks and lamps
- Verifies a wide range of 3-phase power sources from 110 V to 600 V
- Colour-coded integrated test leads eliminate the risk of misconnection and meter damage



KYORITSU

Model No.	Mfg. No.	Description	Price/Each
IA185	KEW8031	Phase Rotation Indicator	

CABLE TRACERS

- All components are fully fuse protected and intrinsically safe; and fit into a foam-lined carrying case
- Model R2000 Receiver has two detectors in its tip which are tuned to pick up the electromagnetic signals ('short' mode) or electrostatic signals ('open' mode) generated by other components
- LEDs and sensitivity settings indicate the relative signal strength to allow easy detection of the signal source
- Model S2600 Load Signal Generator, when connected to an energized line, will draw a rapidly fluctuating current pulse from the source, causing the power line to emit an electromagnetic signal which is detected by the R2000 in the 'short' mode
- Model T2200 Transmitter injects a signal into an unenergized conductor. If the conductor is broken (open), no current will flow, so the signal is present as a voltage pulse, which is detected along the conductor's length by the R2000's electrostatic detector ('open' mode)
- Model A2201 Inductive Clamp when clamped around the energized line and plugged into the T2200 will induce a signal onto the downstream (load) side to enable identification of equipment on that circuit
- Includes: Receiver, load signal generator, transmitter, clamp-on transmitter accessory, cordsets and adapter



Model No.	Mfg. No.	Description	Price/Each
HD909	AT-2004	Cable Tracing System	



aurora tools

**Canada's Best Value
in Industrial Tools!**

LCR/CAPACITANCE METERS

- Measure inductance/capacitance/resistance with secondary parameters including dissipation factor (D), quality factor (Q), phase angle (ϕ), equivalent series/parallel resistance (ESR or Rp)
- Autoranging operation for AC impedance and DE resistance measurement
- Auto LCR smart check and measurement
- Series/Parallel modes
- Ls/Lp/Cp with D/Q/ ϕ /ESR parameters
- Support DCR mode 200 to 200M Ω
- High accuracy with 4 or 5 terminal Kelvin measurement
- Testing frequency is up to 10kHz and output frequency is up to 100kHz
- Includes test leads and batteries
- Accredited calibration available



SPECIFICATIONS:

Inductance Range: 2000.0 μ H/20.000/200.0/2000.0 mH/20.000/200.00/2000.0 H

Capacitance Range: 2000.0 pF/20.000/200.00/2000.0 nF/20.00/200.00/2000 μ F

Resistance Range: 20.000/200.00 Ω /2.0000/20.000/200.00 k Ω /2.0000/20.000/200.0 M Ω

Test Frequencies: 100/120/1k/10k/100k Hz



Model No.	Mfg. No.	Description	Price/Each
IA854	R5001	LCR/Capacitance Meter	

VOLTAGE/CURRENT DATA LOGGERS

- Simultaneously measure 2 True RMS AC voltage inputs OR 2 AC current inputs OR 1 AC voltage and 1 AC current input
- User programmable sample rates from 1 second to 24 hours
- Stores up to 256,000 measurements
- User programmable high/low alarms
- LCD indicates time/date, current readings, Max/Min, Peak hold and whether alarm settings have been exceeded
- Download collected data through USB interface
- Auto power off and battery check
- Includes AC current clamp sensor and voltage sensor, USB cable, software, and battery
- Accredited calibration available



SPECIFICATIONS:

AC Current Range: 10 to 200A

AC Voltage Range: 10 to 600V



Model No.	Mfg. No.	Description	Price/Each
IA856	R5003	AC Voltage/Current Data Logger	

PHASE SEQUENCE TESTERS

- Tests phase orientation of 3-phase power sources
- Indicates phase orientation (clockwise or counter-clockwise) and whether each of the three phases is live
- Also indicates direction of motor rotation
- Determines motor rotation without contact
- Easy to open alligator clips with wide jaws
- Double molded housing
- Cat. III 600V safety rating
- Input Voltage: 40 to 600 VAC
- Operating Frequency: 2 to 400 Hz
- Complete with cables with 3 colour-coded alligator clips, 9V battery and carrying case
- Accredited calibration available



Model No.	Mfg. No.	Description	Price/Each
IA857	R5004	Phase Sequence/Motor Rotation Tester	

INFRARED THERMOMETERS

FOOD SERVICE INFRARED THERMOMETERS

- Contact and non-contact food service thermometer
- Optical Resolution: 12:1 (Distance: Spot size)
- Infrared thermometer features laser sighting
- Accepts any Type K thermocouple probe with mini-connector
- Choice of five different colour faceplates - choose a different colour faceplate for each department or food category
- Large backlit LCD readout
- Max, Min, Diff and Avg. displays
- Programmable Hi/Lo alarms
- Lock feature for continuous monitoring
- Includes holster/case



IA432

SPECIFICATIONS:

Range:	-76° to 932°F (-60° to 500°C)
Resolution:	±0.1°F (±0.1°C)
Accuracy:	±2% rdg. or ±2°C, whichever is greater
Response Time:	1 second
Spectral Response:	8 to 14 µm
Emissivity:	Preset at 0.97
Optical Resolution:	12:1 (Distance: Spot size)
Type K Thermocouple Probe Range:	-83° to 1999°F (-64° to 1400°C)
Accuracy:	±1% rdg. or ±1°C, whichever is greater
General Power Supply:	2 x AAA alkaline batteries
Dimensions:	175 x 39 x 72 mm (6.9 x 1.5 x 2.8")
Weight:	179 g



Model No.	Mfg. No.	Description	Price/Each
IA432	PS200	Food Service Infrared Thermometer	

INFRARED THERMOMETERS

- Precise non-contact temperature measurements
- Temperature Range: -58° to 1832°F (-50° to 1000°C)
- Fahrenheit/Celsius selectable
- Digitally adjustable emissivity from 0.10 to 1.0
- High and low alarm setpoints
- Max, Min and Dif. Avg. temperature displays
- Built-in laser pointer
- Large LCD with backlight and display hold
- Includes: battery and carrying case
- 50:1 distance to spot size ratio
- Accredited calibration available



IA084

REED

Model No.	Mfg. No.	Description	Price/Each
IA084	R2007	Infrared Thermometer	

INFRARED THERMOMETERS

- Pocket-sized and easy-to-use - just point, shoot and read
- Unique flat surface and modern housing design
- User selectable °F or °C
- Built in laser pointer identifies target area
- Backlighting illuminates display for taking measurements at night or in areas with low background light levels
- Overrange indicator, auto data hold (when trigger released) and auto shut off
- Fixed 0.95 emissivity covers 90% of surface applications
- 8:1 Distance to Spot size ratio
- Includes: battery and carrying case
- Temperature range: -58° to 932°F (-50° to 500°C)
- Accredited calibration available



IB537

REED

Model No.	Mfg. No.	Description	Price/Each
IB537	R2002	Infrared Thermometer	

INFRARED THERMOMETERS

- Fast and safe way to measure surface temperatures, without contact
- Easy to use - just point, shoot and read
- Temperature Range: 0° to 750°F or -18° to 400°C
- Fahrenheit/Celsius selectable
- Fixed emissivity of 0.95
- 8:1 Distance to Spot Size ratio
- Large LCD with backlight and display hold
- Features laser sighting
- Carrying case extra



HN235



Model No.	Mfg. No.	Description	Price/Each
HN235	RAYMT4U	Infrared Thermometer w/ Laser Sighting	
HX034	RAYMTAPK	Soft Pouch w/ Wrist Strap	

INFRARED THERMOMETERS

- Measures surface temperatures of hot, hazardous or hard-to-reach objects without contact
- User selectable °F or °C
- Built-in laser pointer
- Pre-set emissivity of 0.95
- 8:1 Distance to Spot size ratio
- Large LCD with backlight and display hold
- Compact, measures just 3.7" x 2.1" x 1" (94 x 56 x 28mm)
- Temperature Range: -58 to 536°F (-50 to 280°C)
- Accredited calibration available



IA853

REED

Model No.	Mfg. No.	Description	Price/Each
IA853	R2001	Infrared Thermometer	

INFRARED THERMOMETERS

- Two-in-one thermometer combines infrared and K-thermocouple probe temperature measurement
- Infrared thermometer with integral type K thermocouple input
- IR Temperature Range: -58 to 1922°F (-50 to 1050°C)
- T/C Temperature Range: -58 to 2498°F (-50 to 1370°C)
- Built-in laser pointer identifies target area
- Digitally adjustable emissivity from 0.10 to 1.0
- 30:1 distance to spot size ratio
- Automatic emissivity capture
- High and low alarms
- Max, Min, Avg, Diff record
- 20 data points of memory
- Display backlighting
- Auto data hold and auto shut off
- Trigger lock
- Includes: type K thermocouple probe, battery, and carrying case
- Accredited calibration available



IA496

REED

Model No.	Mfg. No.	Description	Price/Each
IA496	R2005	Infrared Thermometer w/ Type K T/C	

INFRARED THERMOMETERS

THERMAL IMAGERS 19 200 PIXELS

- 3.5" colour TFT LCD capacitive touch screen
- High thermal sensitivity (NETD) of <math>< 80\text{mK}</math>
- Built-in laser and white LED flashlight
- Built-in visible light digital camera
- 20x continuous zoom
- Includes thermal imager, 7.5 mm lens, lens cap, micro SD memory card, video output cable, headset, USB cable, hood, tripod stand, shoulder strap, battery, charger, DC power supply, user manual, software CD and hard carrying case
- Accredited calibration available

SPECIFICATIONS:

IR Resolution:	160 x 120 pixels
Field of View:	29.8 x 22.6°
Detector Type:	Uncooled microbolometer
Thermal Sensitivity (NETD):	<math>< 0.08^\circ\text{C}</math> (80mK)
Image Capture Frequency:	50Hz
Focus:	Manual
Temperature Range:	-4 to 752°F (-20 to 400°C)
Accuracy:	$\pm 3.6^\circ\text{F}$ ($\pm 2^\circ\text{C}$) or $\pm 2\%$ of reading
Storage Medium:	4GB micro SD card
Interface:	USB-mini, audio, composite video (PAL and NTSC), Micro SD slot
Drop Test:	2m
Encapsulation:	IP65
Power Supply:	7.4V lithium polymer battery
Battery Life:	4 hours
Dimensions:	9.56" x 4.06" x 0.525" (243 x 103 x 160 mm)
Weight:	920 g (32.45 oz)



IA978

REED

Model No.	Mfg. No.	Description	Price/Each
IA978	R2100	Thermal Imager	
IA983	RL-11	11 mm Replacement Lens	
IA984	RL-22	22 mm Replacement Lens	
IA985	RL-33	33 mm Replacement Lens	
IA996	R2100-7.4V	Spare Battery	

INFRARED VIDEO THERMOMETER

- Dual lasers identify exact measuring spot where they converge
- Optical Resolution: 50:1 (Distance: Spot size)
- Fast 150ms response time
- 2.2" TFT colour LCD and built-in 640 x 480 pixels camera
- Supports image (JPEG) and video (AVI) capture alerts
- Transmit images and videos via USB interface
- 72MB internal memory with MicroSD memory card extension
- Datalogging capabilities with date and time
- Includes type K thermocouple probe, AC adapter, USB adapter, mini-tripod, and hard carrying case

SPECIFICATIONS:

IR Temp. Range:	-58 to 3992°F (-50 to 2200°C)
Spectral Response:	8 to 14 μm
Type K Temp. Range:	-58 to 2498°F (-50 to 1370°C)
Air Temp. Range:	32 to 122°F (0 to 50°C)
Dew Point & Wet Bulb Temp. Range:	32 to 122°F (0 to 50°C)
Humidity Range:	0 to 100% RH



IA977

REED

Model No.	Mfg. No.	Description	Price/Each
IA977	R2020	Infrared Video Thermometer/Datalogger	
OM464	SD-MINI (8GB)	8GB Micro SD Memory Card	

REED R2050 THERMAL IMAGING CAMERA

- 2.8" colour 240 x 320 pixel LCD display
- High thermal sensitivity (NETD) of <math>< 0.1^\circ\text{C}</math> @ +30°C (+86°F) / 100mK
- Built-in laser and white LED flashlight
- Built-in visible light 5 Megapixel digital camera
- 32x continuous digital zoom
- Infrared and visual images, picture-in-picture, as well as visual image with infrared overlay
- Automatic hot/cold spot indicator
- Automatic level/span function
- Video recording with voice annotations
- Set-up Commands: Local adaptation of units, language, date and time formats, information of camera



SPECIFICATIONS:

IR Resolution:	80 x 80 (6400 pixels)
Thermal Sensitivity/NETD:	<math>< 0.1^\circ\text{C}</math> @ +30°C (+86°F) / 100 mK
Focus Distance:	17' x 17' / 0.5 m
Image Frequency:	50 Hz
Temperature Range:	-20°C to +150°C (-4°F to +302°F); 0°C to +350°C (+32°F to +662°F)
Humidity (Operating & Storage):	10% to 90%
Storage Media:	8GB Micro SD Card

REED

Model No.	Mfg. No.	Description	Price/Each
IB745	R2050	Thermal Imaging Camera	
IB746	R2050-3.7V	Replacement Battery	

INFRARED TEMPERATURE CALIBRATORS

- Temperature Range: Up To 500°C (932°F)
- This portable infrared temperature calibrator is as easy to use, just point and shoot;
- For calibrating non-contact infrared thermometers up to 500 °C (932 °F);
- Temperature controlled black-body target with a diameter of 2.25" (57 mm);
- Wide field of view to compensate for optical variations in individual infrared thermometers;
- Simply set the desired temperature in increments of 0.1 °, wait for the calibrator to attain equilibrium, point the infrared thermometer at the target and measure the radiated energy;
- Contact RTD reference well is located directly behind the blackbody target to assure even higher accuracies of $\pm 0.1^\circ\text{C}$
- Display: Digital
- No. of outputs: 2



REED

Model No.	Mfg. No.	Price/Each
IA548	BX-500	

TYPE K THERMOCOUPLE PROBES

MODEL IB878 – SURFACE THERMOCOUPLE PROBES

For general-purpose temperature applications.
Measuring Range: -58 to 932°F (-50 to 500°C).

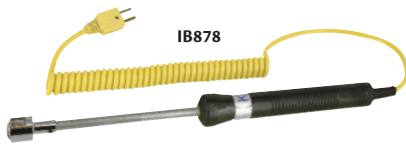

MODEL IB879 – RIGHT-ANGLE SURFACE PROBE

Unique right-angle surface probe design allows for temperature measurement of hard-to-reach areas. Measuring Range: -58 to 932°F (-50 to 500°C).

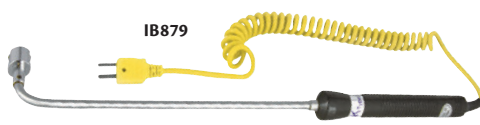

MODEL IB880 – AIR/GAS THERMOCOUPLE PROBE

Specially-designed to measure air or gases in heating and cooling units, ovens and engine exhausts. Perforated stainless steel shield permits fast response and element protection. Measuring Range: -58 to 1652°F (-50 to 800°C).



MODEL IB881 – IMMERSION THERMOCOUPLE PROBE

Recommended for checking the temperature of water, oils and non-corrosive fluids and gels. For immersion and general-purpose applications. Measuring Range: -58 to 1112°F (-50 to 600°C).



MODEL HN213 – NEEDLE TIP PROBES

Medium gauge hypodermic needle tip, used to measure softer food stuffs, rubbers and solids. Ideal for use in industrial, laboratory and chemical environments. Maximum Temperature: 800°C.



REED

Model No.	Mfg. No.	Description	Price/Each
IB878	R2920	Surface Thermocouple Probes	
IB879	R2930	Right-Angle Surface Probe	
IB880	R2940	Air/Gas Thermocouple Probe	
IB881	R2950	Immersion Thermocouple Probe	
HN213	R2960	Needle Tip Thermocouple Probe	

DIGITAL THERMOMETERS

- Temperature Range: -58 to 2000°F (-50 to 1300°C)
- User selectable °C or °F
- User selectable 0.1°F or 1°F (0.1°C or 1°C) resolution
- Accuracy to 0.5%
- Display maximum reading plus data hold
- Large LCD display with backlight
- Accept K-type thermocouples
- Includes: 9 V battery and holster

HX381



REED

Model No.	Mfg. No.	Description	Price/Each
HX381	R2400	Single Input Thermocouple Thermometer	

THERMOCOUPLE THERMOMETER KIT

- Type K thermocouple thermometer
- Large, easy-to-read backlit LCD display
- User selectable °C, °F or Kelvin
- Max and Data Hold functions
- Tripod mount for long-term monitoring
- Low battery indicator and auto shut off
- Type: Contact
- Display Type: Digital
- Temperature Range: -58-2000°F (-50-1300°C)
- Accuracy: -58°F to 32°F: ±4°F, 32°F to 2000°F: ±(0.5% rdg+2°F), -50°C - 0°C: ±2°C, 0°C to 1000°C: ±(0.5% rdg+1°C), 1000°C to 1300°C: ±(0.8% rdg+1°C), 223K to 273K: ±5K, 273K to 2000K: ±(1.0% rdg+2K)
- Resolution: 0.1 or 1°F/°C, 1K
- Type: Single Input, Thermocouple Type K
- Includes: HX381 thermocouple thermometer, IB878 surface probe, IB880 air/gas probe, IB881 immersion probe, HK953 beaded wire probe and IB872 deluxe hard carrying case



REED

Model No.	Mfg. No.	Description	Price/Each
IB877	R2400-KIT	Deluxe Thermometer Kit	

THERMOCOUPLE THERMOMETER

- Displays up to 4 separate measurements simultaneously
- Accepts Type K, J, R, S, E, T thermocouple and RTD probes
- Temperature differential (T1-T2), Max/Min and Data hold functions
- Real-time data logger with integral SD memory card
- User selectable sampling rate from 1 to 3600 seconds
- Large, easy-to-read backlit LCD display
- Optional PC software features live tracking via USB connection
- Tripod mount for long-term monitoring
- Type: 4-Channel, Thermocouple, 2-Channel RTD
- Selectable Sampling Rate: Yes
(1, 2, 5, 10, 30, 60, 120, 300, 600, 1800, 3600s)
- Power Supply: 6 x AA batteries or AC Adapter (optional)
- Software OS Compatibility: Windows XP / Vista / 7
- Product Certifications: CE
- Operating Temperature: 32 to 104°F (0 to 40°C)



REED

Model No.	Mfg. No.	Description	Price/Each
IA792	SD947	Thermocouple Thermometer	

RTD THERMOMETERS

- Platinum resistor temperature sensor requires less temperature compensation than thermocouple units
- Selectable sensor types: Pt-100, Pt-500, Pt-1000 (4 wires)
- 4-digit LCD readout with LED backlight
- °C/°F switchable
- Min/Max/Avg functions
- Relative mode and data hold
- Low battery indication with auto power off
- IP67 waterproof housing
- Includes piercing type temperature probe
- Accredited calibration available

Temperature Range: -148 to 572°F (-100 to 300°C)
Resolution: 0.1°F (0.1°C)
Accuracy: ±0.1% reading +0.8°F (+0.4)
Temp. Coefficient: <18°C & >28°C: 0.01% reading +0.03°C
Power Supply: 3 x 1.5 V AAA alkaline batteries
Battery Life: Approx. 100 hours
Dimensions: 150 x 66 x 31 mm
Weight: 175 g



REED

Model No.	Mfg. No.	Description	Price/Each
IA421	C-370	RTD Thermometer	
IA663	TP-R01	Pt-100 Temperature Probe	
HN416	CA-05A	Soft Carrying Case	

THERMOMETERS

VARIABLE ANGLE INDUSTRIAL THERMOMETERS

- V-shape case, molded of GE Valox® polyester, is 9" in length. Heavy glass protected front firmly secured against rattles by spring action
- For 3-1/2" stems only and ranges up to and including 300°F, the stem material is a precision die cast Zamac alloy
- Adjustable case locknut and angle adjusting screw work independently to provide a full 360° positioning of thermometer case and stem
- Adjustable joint completely encloses capillary to prevent tampering and foreign matter for entering instrument
- Tube and capillary are blue spirit filled-magnifying lens "blue reading" tube. Precision made to guarantee accuracy within 1% of scale range. Silicone shock mounted for lasting durability.
- Scale is locked in place and adjusted through top of scale

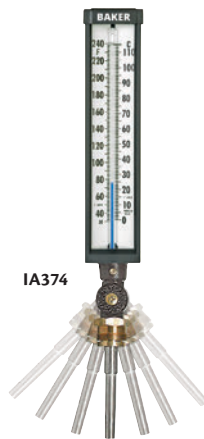

IA374

BAKER INSTRUMENTS

Model No.	Mfg. No.	Description	Price/Each
IA370	9VU35-115	Industrial Thermometer, -40 to 110 °F/-40 to 93 °C	
IA371	9VU35-125	Industrial Thermometer, 0 to 120 °F/-17 to 49 °C	
IA372	9VU35-165	Industrial Thermometer, 0 to 160 °F/-17 to 71 °C	
IA373	9VU35-185	Industrial Thermometer, 30 to 180 °F/-6 to 82 °C	
IA374	9VU35-245	Industrial Thermometer, -40 to 240 °F/0 to 114 °C	
IA375	9VU35-305	Industrial Thermometer, 30 to 300 °F/0 to 149 °C	

STEM THERMOMETERS

- Large, easy-to-read LCD
- Fahrenheit/Celsius switchable
- Range: -40° to 450°F (-40° to 230°C)
- Accuracy: 0° to 230°F: ± 1.0°F; < 0°F: ± 3.6°F; > 230°F: ± 3.6°F
- Resolution: 0.1°F/°C
- 5" stainless steel stem
- Includes one 1.5 V LR44 button battery and protective probe cover



IA728

REED

Model No.	Mfg. No.	Description	Price/Each
IA728	R2000	Digital Stem Thermometer	

STEM THERMOMETERS

- Easy-to-read LCD numerals
- Fahrenheit/Celsius switchable
- Range: -40° to 302°F (-40° to 150°C)
- Accuracy: ± 2°F or ± 1°C
- 5" stainless steel stem
- Immerse stem at least 1" for accurate readings
- Includes one 1.5 V LR44 button battery and protective probe cover



HX502

BIOS Professional

Model No.	Mfg. No.	Description	Price/Each
HX502	DT130	Digital Stem Thermometer	

SURFACE THERMOMETERS

- Specifically designed to be used on horizontal or ferrous non-horizontal surfaces
- Two alnico magnets that act as the thermometer's base and hold it in place on ferrous surfaces
- Bimetallic sensor is a specially processed alloy that is preconditioned and pretested for permanent calibration and maximum stability
- Sensor is located in a draft shield and is in virtual thermal contact with the surface to be measured
- Sensing equilibrium (stability) is reached within three minutes and is accurate to ± 2% of full scale



HB592

BAKER INSTRUMENTS

Model No.	Mfg. No.	Temperature Range	Divisions	Price/Each
HB592	312FC	0° to 250 °F/-20° to 120 °C	2 °F/1 °C	
HB598	314FC	50° to 750 °F/10° to 400 °C	10 °F/5 °C	

BI-METAL THERMOMETERS

- All welded stainless steel construction
- Easy external recalibration adjustment
- 3" diameter anti-parallax dial
- Hermetically sealed per ASME B40.3
- Accurate to 1% per ASME B40.3 Grade A
- Over-range protection is 50% up to 500°F
- 1/2" NPT straight connection



IA266

BAKER INSTRUMENTS

Model No.	Mfg. No.	Description	Price/Each
IA266	T30025-250	0 to 250 °F/-20 to 120 °C, 2-1/2" stem	
IA268	T3004-250	0 to 250 °F/-20 to 120 °C, 4" stem	
IA270	T3006-250	0 to 250 °F/-20 to 120 °C, 6" stem	
IA272	T3009-250	0 to 250 °F/-20 to 120 °C, 9" stem	
IA267	T30025-550	50 to 550 °F/0 to 260 °C, 2-1/2" stem	
IA269	T3004-550	50 to 550 °F/0 to 260 °C, 4" stem	
IA271	T3006-550	50 to 550 °F/0 to 260 °C, 6" stem	

WATERPROOF DIGITAL STEM THERMOMETER

- Temperature Range: -40° to 450°F (-40° to 230°C)
- Accuracy: ± 0.5°C (± 1°F)
- Fahrenheit/Celsius selectable via push button
- Compact pen-style design
- Stainless steel stem
- On-site calibration possible
- Waterproof construction and maximum temperature memory make this thermometer ideal for verifying dishwasher temperatures
- Includes protective case



IA542

BIOS Professional

Model No.	Mfg. No.	Description	Price/Each
IA542	DT131	Digital Stem Thermometer	

DIGITAL STEM THERMOMETER

- Stainless steel stem thermometer offers a quick response and laboratory accuracy
- Easy to read LCD display
- Fahrenheit/Celsius switchable
- Display updates every 2 seconds
- Max/Min memory records highest and lowest temperatures
- Data hold button lets you freeze a reading
- Auto power off
- Includes: R2222 Digital Stem Thermometer, 1.5 V LR44 Button Battery, Protective Probe Cover
- Resolution: 0.1°C / 0.1°F
- Accuracy: ± 1.5% of reading ± 2°
- Weight: 35g
- Temperature Range: -40-482°F (-40-250°C)



REED

Model No.	Mfg. No.	Description	Price/Each
IB747	R2222	Digital Stem Thermometer	

PRE-PROGRAMMED THERMOMETERS/TIMERS

- Pre-programmed cooking temperatures for different meats and tastes
- Select taste setting: Rare to well done
- Displays preset and internal cooking temperatures
- Stainless steel probe with 1 m heat resistant wire
- °C /°F switchable
- Temperature Range: -10° to 200 °C (14° to 392 °F)
- Weight: 6.4 oz



HX158

BIOS
Professional

Model No.	Mfg. No.	Description	Price/Each
HX158	DT100	Thermometer/Timer	

INDOOR/OUTDOOR THERMOMETERS W/CLOCK

- Registers both indoor and outdoor temperatures with Min/Max memory
- 12-hour clock
- Wide temperature range: -50° to 70 °C
- Full 1" high LCD digits
- 10' cable to remote temperature sensor
- Desk mount or wall mount by two sided tape or screws
- Operated by single "AAA" size battery (included)
- Dimensions: 4" x 4" x 3/4"



HA285

BIOS
Professional

Model No.	Mfg. No.	Description	Price/Each
HA285	119	Thermometer w/Clock	

INDOOR/OUTDOOR WIRED THERMOMETERS

- Indoor/outdoor temperature
- Min/max memory
- 3 m/9.8' wired sensor probe
- Time and date
- °C /°F switchable
- Large LCD display
- Temperature trend
- Time and alarm features
- Freeze alarm

IA808



BIOS
Weather

Model No.	Mfg. No.	Description	Price/Each
IA808	313BC	Indoor/Outdoor Wired Thermometer	

INDOOR/OUTDOOR WIRELESS HUMIDEX THERMOMETERS

- Displays humidex and heat index
- Humidex and heat index is a combination of temperature and humidity into one number to reflect perceived temperature
- Heat stress index scale
- Indoor and outdoor temperature
- Outdoor humidity
- Min/max memory
- °C and °F switchable
- Wireless transmission range: 45 m/150'

IA504



BIOS
Weather

Model No.	Mfg. No.	Description	Price/Each
IA504	260BC	Wireless Humidex Thermometer	

INDOOR/OUTDOOR WIRELESS THERMOMETERS

- Indoor and outdoor temperature
- Min/max memory
- °C and °F switchable
- Wireless transmission range: 30 m/100'

IA505



BIOS
Weather

Model No.	Mfg. No.	Description	Price/Each
IA505	261BC	Indoor/Outdoor Wireless Thermometer	

INDOOR THERMOMETERS FOR HUMIDITY & TEMPERATURE

- Indoor temperature and relative humidity
- Min/max memory
- °C and °F switchable

IA506



BIOS
Weather

Model No.	Mfg. No.	Description	Price/Each
IA506	263BC	Thermometer for Humidity & Temperature	

INDOOR HYGROMETERS WITH BIOS COMFORT SCALE

- BIOS comfort scale indicates ideal humidity range for home and personal health
- Indoor temperature
- Min/max memory
- °C and °F switchable

IA497

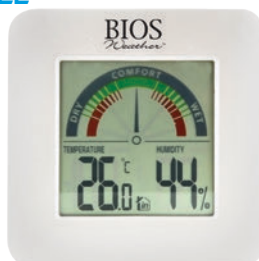

BIOS
Weather

Model No.	Mfg. No.	Description	Price/Each
IA497	258BC	Indoor Hygrometer	

INDOOR OUTDOOR THERMOMETERS W/CLOCK

- Displays indoor and outdoor temperatures and indoor relative humidity
- Multiple remote sensor capability
- Humidity range: 20 to 95% RH
- Indoor temperature range: 0 to 50°C (32 to 122°F)
- Outdoor temperature range: -35 to 60°C (-31 to 140°F)
- Includes indoor monitor and remote temperature sensor
- Power supply: 2 x 1.5 V AA batteries for both monitor and sensor

IA807



BIOS
Weather

Model No.	Mfg. No.	Description	Price/Each
IA807	312BC	Indoor Outdoor Thermometers w/Clock	

TEMPERATURE/HUMIDITY METERS

THERMO-HYGROMETERS

COMPACT THERMO-HYGROMETER WITH INTEGRAL PROBE FOR CONVENIENT ONE-HAND OPERATION

- Dual LCD readout shows ambient temperature and relative humidity
- User selectable °F/°C
- Min/Max memory for both functions
- Data hold and relative functions
- Auto power off
- Includes battery
- Humidity Range: 0 to 100% RH
- Temperature Range: -4 to 140°F (-20 to 60°C)



THERMO-HYGROMETERS

- Measures relative humidity as well as temperature with a type J/type K thermocouple thermometer
- Also measures dew point and wet bulb temperatures
- Data hold and Max/Min record
- Real time data logger with integral 4 GB SD memory card (optional)
- RS232 and USB interface
- Temperature is measured in °C or °F

SPECIFICATIONS:

- **Humidity Range:** 5% to 95% RH
- **Type J Temp. Range:** -100° to 1200 °C
- **Type K Temp. Range:** -100° to 1300 °C



REED

Model No.	Mfg. No.	Description	Price/Each
IA441	R6001	Thermo-Hygrometer	

REED

Model No.	Mfg. No.	Description	Price/Each
IA793	SD-3007	Thermometer/Hygrometer	
IB835	SD-4GB	Memory Card - 4 GB	

THERMO-HYGROMETERS

- Dual LCD display shows ambient temperature and relative humidity
- Humidity Range: 10% to 95% RH
- Temperature Range: 0° to 50°C/32° to 122°F
- User selectable °C/°F
- Data Hold and Min/Max function for humidity
- Compact and lightweight
- Battery included



REED

Model No.	Mfg. No.	Description	Price/Each
HX287	LM-81HT	Thermometer-Hygrometer	
HN413	CA-52A	Soft Carrying Case	

TEMP/RH DATA LOGGERS

MONITORS BOTH AMBIENT TEMPERATURE & RELATIVE HUMIDITY

- Stores up to 16 000 temperature and 16 000 humidity readings
- User selectable measurement rate from 2 seconds to 24 hours
- Alarm display if user-defined max/min values are exceeded
- Displays all status information through two LEDs
- Simply plug the logger into the USB port of your computer to begin downloading - no cables or wires are required
- Includes wall mount bracket and Windows® compatible software
- Temperature Range: -40 to 70°C (-40 to 158°F)
- Humidity Range: 0 to 100% RH



REED

Model No.	Mfg. No.	Description	Price/Each
IA449	R6020	Temperature/Humidity Data Logger	

GET CLEAN

Industrial handsoap with scrubbing particles for stubborn grease and grime

Model JG223
See page 331



TEMPERATURE/HUMIDITY METERS, LOGGERS & RECORDERS

HEAT STRESS METERS

- Wet Bulb Globe Temperature (WBGT) considers the effects of temperature, humidity and direct or radiant sunlight
- Heat Stress Index measures how hot it feels when humidity is combined with temperature, air movement and radiant heat
- Black Globe Temperature (TG) monitors the effects of direct solar radiation on an exposed surface
- In/Out function displays the WBGT value with or without direct sun exposure
- View individual temperatures or indices in either °F or °C
- User adjustable WBGT threshold with audible alarm if threshold is exceeded
- Built-in RS232 and USB interface
- Tripod mount design for long term monitoring

REED



SPECIFICATIONS:

Air Temp. Range: 0.0 to 50.0°C (32 to 122°F)
Black Globe Temp. Range: 0.0 to 80.0°C (32 to 176°F)
WBGT Temp. Range: 0.0 to 50.0°C (32 to 122°F)
Humidity Range: 0 to 100% RH

Model No.	Mfg. No.	Description	Price/Each
IA639	8778	Heat Stress Meter	
IB820	R1500	Tripod	
HX515	HR33	33% Humidity Calibration Standard	
HX514	HR75	75% Humidity Calibration Standard	

PSYCHROMETERS

- Simultaneous display with % RH, temperature and dew point or wet bulb or external probe temperature (requires IA108)
- Calculates T1-T2 (Air temp. - External probe temp.) (requires IA108)
- Triple display with backlighting
- Max/Min readings
- Sensor cap closes to protect probe during storage
- Retrieve Max/Min/Avg readings from stored data
- Real time clock

SPECIFICATIONS:

Humidity Range: 0 to 100% RH
Dew Point Range: -90° to 122°F (-68° to 50°C)
Wet Bulb Range: -5° to 122°F (-21° to 50°C)
Internal Temp. Range: -4° to 122°F (-20° to 50°C)
External Temp. Range: -4° to 158°F (-20° to 70°C)

REED

IA000



Model No.	Mfg. No.	Description	Price/Each
IA000	8706	Digital Psychrometer	
IA108	87P6	Temperature Probe	
HX515	HR33	33% Humidity Calibration Standard	
HX514	HR75	75% Humidity Calibration Standard	

HEAT STRESS METERS

- Measures indoor and outdoor WBGT (Wet Bulb Globe Temperature), Black Globe (TG) temperature, humidity, wet bulb, dew point and air temperatures
- Adjustable audible WBGT alarm setting
- Real time data logger with integral 4 GB SD memory card (optional)
- RS232 and USB interface
- Temperature is measured in °C or °F

SPECIFICATIONS:

Indoor WBGT Range: 0° to 59 °C
Outdoor WBGT Range: 0° to 56 °C
TG Temp. Range: 0° to 80 °C
Air Temp. Range: 0° to 50 °C
Humidity Range: 5 % to 95 % RH

REED

Model No.	Mfg. No.	Description	Price/Each
IA794	SD-2010	Heat Stress Meter	
IB835	SD-4GB	Memory Card - 4 GB	



TEMP/RH DATA LOGGERS

- Records up to 32 700 ambient temperature and relative humidity readings
- User selectable recording intervals from 1 s to 24 h
- Minimum/Maximum function with alarm
- Real-time clock stores data and time
- LCD readout displays current temperature (°F or °C) or humidity reading, min/max reading with date and time
- Download data directly to a PC via USB cable supplied
- Includes data logger, mounting bracket with screws, USB cable, software diskette, security lock and battery
- Temperature Range: -40 to 70°C (-40 to 158°F)
- Humidity Range: 0 to 100% RH

REED

Model No.	Mfg. No.	Description	Price/Each
IA680	R6030	Temperature/RH Data Logger	



**Afraid of Heights...
We've Got
You Covered!**



KLETON

Canada's Leading
Material Handling Supplier

HEAT STRESS STOP WATCHES

- Measures temperature and humidity, and calculates heat index as well as dew point
- Combines air temperature and relative humidity measurements in an attempt to determine the human-perceived equivalent temperature or "how hot it feels"
- Calendar mode displays day, date and time
- Stopwatch/chronograph mode with 1/100 second resolution
- Fastest/Slowest/Average Lap recall
- 99 lap counter with 30 lap/split memory
- 10 hour countdown timer with audible beeper warning for the last 5 seconds
- 12 or 24 hour clock operation
- Full LCD display with LED backlight
- Silent operation option
- Dual power: solar panel and battery
- 1 ATM water resistant (IPX4 rated)

SPECIFICATIONS:

Timing Capacity: 9 hrs, 59 mins, and 59 secs
Accuracy: ±3 seconds/day
Lap Memory: 30 laps
Heat Index Range: 70 to 122°F (22 to 50°C)
Temperature Range: 23 to 122°F (-5 to 50°C)
Humidity Range: 1 to 99% RH
Dimensions: 2.65 x 3.6 x 0.9" (67.5 x 92 x 23 mm)
Weight: 2.93 oz (83 g)

Model No.	Mfg. No.	Description	Price/Each
IA987	SW700	Heat Index Stop Watch	



REED

MOISTURE METERS

- Ideal for use on any construction site
- Measures the moisture content of sawn timber (also cardboard and paper) and hardened materials like plaster, concrete and mortar
- Measuring Range: Wood: 6 to 44%; Material: 0.2 to 2.0%
- Accuracy: Wood: $\pm 1\%$; Material: $\pm 0.05\%$
- Average adjustment for European wood based on a wood temperature of 20°C
- Impact-proof plastic housing
- Auto power-off
- 8 mm long integrated electrode is replaceable



REED

Model No.	Mfg. No.	Description	Price/Each
IA533	R6013	Moisture Meter	

MOISTURE DETECTORS

- Pocket-size electronic, non-destructive detector that provides moisture readings instantly and accurately
- Detects moisture beneath the surface being tested by measuring the resistance between two low frequency signals transmitted from conductive pads on the base of the instrument
- Soft conductive electrode pads on the base of the instrument run smoothly over the surface being tested and immediately identify moisture without scratching or penetrating the surface
- Three sensitivity scales:
 - Scale 1:** Timber and wood products
 - Scale 2:** Felt roofing
 - Scale 3:** Plaster and brick



TRAMEX

Model No.	Mfg. No.	Description	Price/Each
HM170	ME-1	Moisture Detector	

MOISTURE DETECTORS

- Detects moisture content in building materials of all kinds, as well as detects moisture distribution in walls, ceilings and floors
- Non-destructive - moisture sensor runs smoothly over the surface being tested without scratching or penetrating the surface
- Display Hold button
- Max/Min function with alarm indication
- LCD display with backlighting
- Low battery indication with auto power off
- Measuring Range: 0.0 to 100.0% Moisture Content
- Penetration Depth: 20 to 40 mm



REED

Model No.	Mfg. No.	Description	Price/Each
IA681	R6010	Moisture Detector	

DUAL MOISTURE METER

- Pin and pinless functions detect moisture in wood and building materials
- Displays icons to indicate low, medium or high levels of moisture and an audible alert that increases in frequency as detected moisture level rises
- Pinless measurement depth up to 1" (25mm)
- Built-in measurement verification and battery check
- Low battery indicator and auto shut-off
- Replaceable pins
- Pin Mode Measuring Ranges: 5-50% (wood); 1.5-33% (building materials)
- Pinless Mode Measuring Ranges: 0 to 99.9% (wood and building materials)
- Pin Mode Depth Detection: 0.3" (8mm)
- Pinless Mode Depth Detection: Up to 1" (25mm)
- Pin Mode Accuracy: $\pm(3\% + 5 \text{ dgt.})$
- Power Supply: 9V battery
- Display: LCD
- Temperature Range: 41° - 113° F (5° - 45° C)
- Moisture Range: 0 - 80%
- Includes: Dual moisture meter, pins, protective caps and battery



REED

Model No.	Mfg. No.	Description	Price/Each
IB873	R6018	Dual Moisture Meter	

WATER DAMAGE & RESTORATION KIT

- Pin and Pinless functions detect moisture in wood and building materials (sheet rock, cardboard, plaster, concrete and mortar)
- Displays icons to indicate low, medium or high levels of moisture and an audible alert that increases in frequency as detected moisture level rises
- Pinless measurement depth up to 1" (25mm)
- Built-in measurement verification and battery check
- Low battery indicator and auto shut-off
- Replaceable pins
- Pin Mode Measuring Ranges: 5-50% (wood); 1.5-33% (building materials)
- Pinless Mode Measuring Ranges: 0 to 99.9% (wood and building materials)
- Pin Mode Depth Detection: 0.3" (8mm)
- Pinless Mode Depth Detection: Up to 1" (25mm)
- Pin Mode Accuracy: $\pm(3\% + 5 \text{ dgt.})$
- Power Supply: 9V battery
- Display: LCD
- Operating Humidity Range: 0 to 80%
- Includes: Dual moisture meter, digital psychrometer and soft carrying case



REED

Model No.	Mfg. No.	Description	Price/Each
IB874	R6018-KIT	Water Damage & Restoration Kit	

WOOD MOISTURE METERS

- Memory contains eight wood groups with calibrations for approximately 170 species of wood
- Built-in 2-point calibration check
- User settable auto power off with override
- Low battery indication
- Integral contact pins are replaceable, remote moisture electrode pins are not replaceable
- Complete with remote hand-press moisture electrode, temperature probe, protective cap, replacement pins, two AAA batteries, and soft carrying case

SPECIFICATIONS:

Measuring Principle: Electrical resistance

Measuring Range: 6 to 99.9% MC

Accuracy: $\pm 1\%$ MC

Temp. Compensation: -31 to 176°F (-35 to 80°C)

Power Supply: Two AAA batteries

Dimensions: 7 x 1.9 x 2" (180 x 50 x 31 mm)

Weight: 6.1 oz (175 g)



REED

Model No.	Mfg. No.	Description	Price/Each
IA734	R6015	Wood Moisture Meter	

THICKNESS, COATING & HARDNESS METERS

COATING THICKNESS GAUGES

- Fast, repeatable measurements
- No calibration required for most applications
- Zero feature for rough or curved surfaces
- Reset feature when no reference is available
- Audible and visible measurement indication
- V-groove in probe for positioning on cylindrical parts
- Strong, wear-resistant ruby-tipped probe
- Mils/microns switchable
- Model **THZ328** measures non-magnetic coatings on steel
- Model **THZ327** measures both non-magnetic coatings on steel and non-conductive coatings on aluminum, brass, etc. automatically recognizes the substrate
- Gauge comes complete with built-in probe, plastic shims, hard shell storage case, "AAA" battery and instructions
- Measuring Range: 0 to 40 mils; 0 to 1000 µm

THZ328



DeFelsko

Model No.	Mfg. No.	Description	Price/Each
THZ328	DFTFERROUS	Coating Thickness Gauge	
THZ327	DFTCOMBO	Coating Thickness Gauge	

COATING THICKNESS GAUGES

BASIC MODELS

- Larger, easy-to-read LCD with menu-driven user interface
- Flip display with backlight
- Instant automatic gauge set-up
- Average zero and automatic reset features
- Integral constant pressure probe (separate probe models available)
- Mils/microns/mm switchable
- Measuring Range: 0 to 60 mils; 0 to 1500 µm

MEMORY MODELS, ADD

- Storage of 10 000 readings in up to 200 groups
- SSPC PA-2 capability



HC779

DeFelsko

Model No.	Mfg. No.	Description	Price/Each
HC779	F1	Basic Coating Thickness Gauge, Non-magnetic on Ferrous	
HC781	F3	Memory Coating Thickness Gauge, Non-magnetic on Ferrous	
HC786	N1	Basic Coating Thickness Gauge, Non-conductive on Non-ferrous	
HC788	N3	Memory Coating Thickness Gauge, Non-conductive on Non-ferrous	

COATING THICKNESS GAUGES

- Dual technology provides automatic recognition for ferrous (F) and non-ferrous (NF) metal substrates
- Magnetic induction for ferrous metal substrates
- Eddy current measurement for non-ferrous metal substrates
- One or two point calibration
- User-settable high/low alarms
- Min/Max/Average
- Memory stores 400 readings
- Measuring range: 0 to 1250 µm, 0 to 49.21 mils
- Min. curvature radius: F: 1.5 mm; NF: 3 mm
- Min. area Diameter: F: 7 mm; NF: 5 mm
- Min. substrate thickness: F: 0.5 mm; NF: 0.3 mm
- Includes: Two AAA batteries, USB cable, software, calibration iron, calibration aluminum, precision standards and carrying case
- Accredited calibration available

REED



Model No.	Mfg. No.	Description	Price/Each
IA858	ST-156	Coating Thickness Gauge	

COATING THICKNESS CALIBRATION KIT

- For use with coating thickness gauges

REED

Model No.	Mfg. No.	Price/Each
IB875	R9050	



COATING THICKNESS GAUGES

- Fast measurement of total coating thickness
- No adjustment required to measure most coatings
- Proven non-destructive ultrasonic technique
- Mils/microns switchable
- Internal memory stores up to 1000 readings
- Easy-to-read, scratch resistant LCD
- Flip display enables right-side-up viewing whether gauge is in your hand or on a table
- Sturdy compact design is solvent, acid, oil, water and dust resistant
- Constant pressure, plastic-tipped probe will not scratch surface
- Comfortable, ergonomic finger grip reduces operator fatigue
- Infrared and RS232 ports
- Gauge comes complete with probe, precision plastic shims, couplant, 2 "AA" batteries, carrying case and instructions
- Measuring Range: 1 to 40 mils; 25 to 1000 µm



THZ326

DeFelsko

Model No.	Mfg. No.	Description	Price/Each
THZ326	200	Coating Thickness Gauge	

COATING THICKNESS GAUGES

- Permanently calibrated
- Positive visual and audible indicators to designate thickness reading is established
- "V" grooves in probe housing and gauge base to allow correct positioning on cylindrical objects
- GO/NO-GO button can be preset for rapid measurement
- Probe contact and dial rotation all in a one finger operation
- Compact, lightweight, independent of gravity - can be used in any position
- Stable overall design, positive positioning, no pivoting tendencies during measurements
- Can be fully supported or with only front probe area contacting surface
- Functions on a permanent rare-earth cobalt magnet, no battery
- Rugged housing, not affected by mechanical shock, water, acid or solvents
- Highly wear resistant carbide measuring probe

MODEL HF678

- Measuring range: 0 to 80 mils



HF678

DeFelsko

MODEL HF721

- Measuring range: 0 to 8 mils

Model No.	Mfg. No.	Description	Price/Each
HF678	FM	Coating Thickness Gauge	
HF721	GM	Coating Thickness Gauge	

COATING THICKNESS GAUGE

- Measures the thickness of non-magnetic coatings on magnetic or non-magnetic metal substrates
- Automatic probe recognition
- Automatic calibration
- Large, easy-to-read LCD provides exact readings without guessing or errors
- µm/mil conversion switch
- Includes hard carrying case and batteries
- Probes sold separately
- Measuring Range: 0 to 1000 µm (0 to 40 mil)
- Resolution: 0.1 µm
- Accuracy: ±1 to 3% or 2 µm, whichever is greater
- Sampling time: 1 second
- Power supply: 4 x 1.5V "AA" batteries



IA673

IA702

IA703

REED

Model No.	Mfg. No.	Description	Price/Each
IA673	CM-8822	Coating Thickness Gauge	
IA702	CM-8822FPROBE	Ferrous Probe	
IA703	CM-8822NFPROBE	Non-Ferrous Probe	

ULTRASONIC THICKNESS GAUGE

- Able to gauge thickness measurement without requiring access to both sides of the test piece
- Determines sample thickness by measuring the amount of time it takes for sound to traverse from the transducer through the material to the back end of a part and back
- Calculates the data based on the speed of the sound through the tested sample
- Capable of performing measurements on a wide range of material including metals, plastic, ceramics, composites, epoxies, glass, and other ultrasonic conductive materials
- Zero function and sound velocity calibration
- Two-point calibration • Display: Digital
- Coupling status indicator • Measuring Mode: Ultrasound
- Can be easily deployed, does not require laboratory conditions
- Thickness Range: 0.03" - 15.7" (0.65 mm - 400.0 mm)
- Sound Velocity Range: 1000 to 9999 m/s (0.039 to 0.394 in/ μ s)
- Measurement Speed: 4 per second for a single point measurement
- Memory: 5 files, up to 100 values for each file (total of 500 logs)
- Power Supply: 2 x 1.5V AA batteries • Frequency: 5MHz
- Measurement Range: 1.2 to 300.0mm (steel)
- Includes ultrasonic couplant gel, probe, hard carrying case and batteries

REED



IB827

Model No.	Mfg. No.	Description	Price/Each
IB827	R7900	Ultrasonic Thickness Gauge	
IB887	R7900-Probe	Replacement Probe	

R9030 HARDNESS TESTERS

- Rebound hardness testing is particularly useful for large, coarse grained materials, forged parts and all types of cast materials
- Measures the velocity of a propelled impact body directly before and after the impact onto the test material's surface
- Capable of automatically converting and displaying measurements into Rockwell (HRC, HRB, HRA), Brinell (HB), Leeb (HL), Vickers (HV) and Shore (HS) hardness values
- Materials that can typically be tested include cast steel, alloy tool steel, stainless steel, aluminum, bronze, copper, cast irons, etc.
- Conversion of measurements to tensile strength (U.T.S.)
- Large capacity memory can store up to 350 groups of information (depending upon impact times) including measurement value, mean value, testing date, impact direction, impact times, material and hardness scale
- Mini USB data interface
- Operates on a rechargeable lithium battery
- 128 x 32 dot matrix LCD with battery life display
- Includes: R9030 Hardness Tester, D Impact Device, Small Supporting Ring, Leeb Test Block, Nylon Brush, Battery Charger, Data Processing Software, Communication Cable
- Hardness Scale: HL, HRC, HRB, HRA, HV, HB, HS
- Measuring Range: HLD: 170 to 96, HRA: 59 to 85m, HRB: 13 to 100, HRC: 20 to 68, HB: 19 to 651, HV: 80 to 967, HS: 30 to 100



REED

Model No.	Mfg. No.	Description	Price/Each
IB748	R9030	Hardness Tester	

THICKNESS GAUGES

- Exclusive micro-computer LSI circuit and crystal time base offer high accuracy
- Digital display provides exact readings without guessing or errors
- Broad band receiving sensitivity means the meter can read probes of different frequencies
- Auto calibration
- Automatic material calibration
- Selectable metric or imperial
- Measures the thickness of steel, cast iron, aluminum, red copper, zinc, quartz glass, polyethylene, PVC, gray cast iron and nodular cast iron
- Display sound velocity at the touch of a button
- Measuring range: 1.5 to 200 mm in #45 steel
- Velocity range: 500 to 9000 m/s

REED



Model No.	Mfg. No.	Description	Price/Each
HX399	TM-8811	Ultrasonic Thickness Gauge	
IA746	TM-8811probe	Replacement Probe	

DUROMETERS

- Digital durometer for Shore A hardness testing
- Designed to measure the penetration hardness of rubber, elastomer and other rubber like substances such as neoprene, silicone and vinyl
- Pocket-sized model with integrated probe
- Measures maximum value
- Calculates average value
- Push button zero calibration
- Bright, clear, 4-digit, 10 mm high LCD readout
- Meets DIN 53505, ASTM D2240, ISO 7619 and JISK 7215



SPECIFICATIONS:

- **Measuring range:** 0 to 90 HA
- **Resolution:** 0.1 HA
- **Deviation:** ± 1 HA

REED

Model No.	Mfg. No.	Description	Price/Each
IA632	HT-6510A	"A" Scale Durometer	

DUROMETERS

- Models feature a heat-treated, high carbon steel mainspring that is calibrated to meet or exceed ASTM Specification D2240-81
- Special cam permits a scale deflection of 100 points when the indenter is displaced exactly 0.100 inch
- Dial scale is extended over 240 circular degrees, accurate to within ± 1 division
- Threaded mounting knob at the top of each durometer permits permanent test stand emplacement
- Resettable ancillary pointer will register the peak durometer reading against all vibrations met in normal use

HB548



MODEL HB548

- "A" Scale durometer measures the indentation hardness of rubber, elastomers, and other rubber-like substances such as neoprene, silicone, vinyl and butyl. It can also be used for soft plastics, felt leather and similar materials

MODEL HB549

- "D" Scale durometer is designed for hard plastics - polystyrenes, vinyls, Formica, Plexiglas - hard rubbers and phenolic moulded materials

MODEL HB538

- Foam and sponge rubber durometer measures the hardness of soft materials such as foam rubber, sponge rubber, jells and doughs
- Classifies cellular rubbers of the sponge and foam type as "x-soft", "soft", "medium" and "firm", and then divides these ranges into smaller increments

HB538



PTC
INSTRUMENTS

Model No.	Mfg. No.	Description	Price/Each
HB548	306L	"A" Scale Durometer	
HB549	307L	"D" Scale Durometer	
HB538	302SL	Sponge Rubber Durometer	

STEEL HARDNESS TESTERS

- Designed for accurate, rapid in place measurement of the hardness of steel and steel alloys in the range from 20 to 65 on the equivalent Rockwell C Scale
- Unit consists of two major components: calibrated indenter and direct reading microscope
- Hand-held impact indenter drives a 1/16" diameter tungsten carbide ball into the sample being tested
- Resulting indentation diameter is measured with 60X microscope
- Calibrated reticle in the microscope reads C Scale directly with an accuracy of ± 1.5 points
- Illumination system features a MagLite® flashlight with a fiber optic pipe that directs the light to the focus of the microscope
- Flat or curved surfaces of virtually any configuration may be measured
- Particularly useful where the test piece is too large or too heavy to test on bench-type tester



PTC
INSTRUMENTS

Model No.	Mfg. No.	Description	Price/Each
HB605	316	Steel Hardness Tester	

SOUND DETECTORS

- Compact, lightweight and user friendly
- LED Alert screen provides a quick visual reference of sound levels
- Provides average sound pressure level and delivers a steadier reading in environments such as manufacturing facilities or machine shops where noise levels are often highly variable

Temperature ranges:

- Operating temperature: 32 °F to 104 °F (0 °C to 40 °C)
- Relative humidity: 0%- 90%, non-condensing

Specifications:

- Size: 6.5" x 2.4" x 0.9" / 16.5 cm x 6.1 cm x 2.3 cm
- Weight: 4.4 oz (125 g) approx.
- Battery: Lithium polymer (1000 mAh), rechargeable
- Run-time: 50+ hours without LEDs activated
- Low battery indicator

Measurements:

- Sound Pressure Level (SPL), Average value (LEQ /LAVG), LED Alert (with Hearing Protection icon), Maximum value (MAX), Minimum value (MIN), Run-Time, Overload (OL), and Under-Range (UR)
- Linearity range: 45 to 130 dB (Dynamic Range)
- Weighting: A or C
- Exchange Rate (ER): 3 dB or 5 dB
- LED Alert Levels:
Green LED Flashes when noise measurements are between 80 to 85 dB
Yellow LED Flashes when noise measurements are between 85 to 105 dB
Red LED Flashes when noise measurements are above 105 dB



Model No.	Mfg. No.	Description	Price/Each
IA848	SD-200	Sound Detector	

NOISE INDICATOR BADGES

- Designed to alert users when noises in an area reach potentially hazardous levels
- Small size and lightweight design make it ideal for workers in a variety of industries
- Clips to clothing using LED light to offer real-time noise detection
- **Red flashing LED:** Indicates noise levels are above 85 dBA and hearing protection may be required
- **Green flashing LED:** Indicates noise levels are below 85 dBA and hearing protection may not be necessary
- Rechargeable lithium polymer battery operates up to 200 hours between charges
- Charging cable not included



Model No.	Mfg. No.	Description	Price/Each
IA849	NI-100	Noise Indicator Badge	

SOUND LEVEL METERS/DATA LOGGERS

- Measuring Range: Low: 30 to 90 dB; Med: 50 to 110 dB; High: 70 to 130 dB Auto: 30 to 130 dB
- Dynamic Range: 60 dB • Accuracy: ±1.4 dB
- Resolution: 0.1 dB
- Sample Rate: Digital: 0.5 sec. Analog: 50 mS
- Frequency Range: 20 Hz to 8 kHz
- Frequency Weighting: A and C
- Microphone: 1/2" electret condenser
- Power Supply: 4 x AAA batteries
- Meets IEC 61672-1 Class 2 requirements
- Records up to 64000 datapoints (1 MB)
- 60 dB dynamic space in each range
- Real time clock and calendar
- Fast/slow time weighting
- Min/Max function • USB Interface
- Analog digital bar graph • Backlit LCD display
- Tripod mount design for long-term monitoring
- Includes windscreen, USB cable, Windows software, batteries and hard carrying case



Model No.	Mfg. No.	Description	Price/Each
IB749	R8080	Sound Level Meter/Data Logger	

SOUND LEVEL METERS

- Measuring Range: 30 - 90 dB/50 - 110 dB/70 - 130 dB
- Data Logging / Not Data Logging: Not Data Logging



Model No.	Mfg. No.	Description	Price/Each
HN404	R8060	Sound Level Meter	

SOUND LEVEL METERS

- Measures sound levels in accordance with IEC61672 Class 2 Specifications:
- A/C frequency weighting
- Fast/slow time weighting
- Peak hold, data hold and max./min. record
- Real time data logger with integral 4 GB SD memory card (optional)
- RS232 and USB interface
- Measuring Range: 30 to 80 dB, 50 to 100 dB, 80 to 130 dB



Model No.	Mfg. No.	Description	Price/Each
IA799	SD-4023	Sound Level Meter	
IB835	SD-4GB	Memory Card - 4 GB	

WIND SHIELD BALLS

- Wind shield ball for sound level microphones
- Compatible with all Reed sound level meters
- Size: 65 mm dia.

Model No. HN408
Mfg. No. SB-01
Price/Each \$



SOUND CALIBRATORS

- Two outputs levels 94 dB and 114 dB (at 1 kHz)
- Diecasting aluminum alloy housing case
- Two 9 V batteries
- Size: 50 mm dia. x 82 mm

Model No. IA661
Mfg. No. SC-05
Price/Each \$



SOUND LEVEL METERS

- Dual range measurement (Hi/Lo)
- A and C frequency weighting
- Large, easy-to-read LCD display
- Electret condenser microphone for high accuracy and longterm stability
- AC/DC output signal for use with dataloggers
- Data Hold, Max Hold functions and low battery indication
- Meets IEC651 Type 2 requirements
- Measuring range: Low: 35 to 100 dB; High: 65 to 135 dB (A and C)
- Model **HX387** includes: Carrying case and batteries
- Model **IB831** includes: Carrying case, Batteries and sound calibrator



REED

Model No.	Mfg. No.	Description	Price/Each
HX387	R8050	Sound Level Meter	
IB831	R8050-KIT	Sound Level Meter & Calibrator Kit	

LIGHT METERS

- Designed for one-hand operation and to fit easily into a tool belt or pocket
- Autoranging
- Data Hold and Min/Max functions
- Auto shut-off and zero adjust button
- Over range and low battery indications
- Ranges: 0 to 20 000 lux; 0 to 2000 ftc
- User selectable Lux/Ftc
- Includes battery



REED

Model No.	Mfg. No.	Description	Price/Each
HX288	LM-81LX	Light Meter	

LIGHT METERS

- User selectable Lux/Foot-candles
- Max and data hold function
- 3-1/2" digit LCD display
- Over range and low battery indication
- Auto shut off
- Compact and lightweight
- Data logging
- Includes: Light Meter, Battery, Carrying Case
- Measuring range: 0-5000 Fc; 0-50 000 lux
- Resolution: 0.1 lux/Fc
- Sampling time: 1.5 times/second



REED

Model No.	Mfg. No.	Description	Price/Each
HX366	R8150	Light Meter	

LIGHT METERS

- Measures ambient light levels as well as temperature with a type J/type K thermocouple thermometer
- Sensor features two filters and meets C.I.E. spectrum Specifications:
- Real time data logger with integral 4 GB SD memory card (optional)
- RS232 and USB interface
- Light levels are measured in ftc or lux
- Temperature is measured in °C or °F
- Light range: 2000, 20 000, 100 000 lux
- Temp. range: J: -100° to 1200 °C; K: -100° to 1300 °C



REED

Model No.	Mfg. No.	Description	Price/Each
IA798	SD-1128	Light Meters	
IB835	SD-4GB	Memory Card - 4 GB	

LIGHT METERS

- Digital dual filter light meter designed to measure a wide range of lighting types
- Large, 3-digit, 0.5" high, LCD display provides clear readouts even in high ambient light levels
- Zero adjustment screw
- Data logging
- Over range and low battery indication
- Measuring range: 0-20 000 lux
- Resolution: 1, 10 lux
- Accuracy: ±5% of reading
- Sampling time: 2 times/second



REED

Model No.	Mfg. No.	Description	Price/Each
HX319	R8120	Light Meter	

ENVIRONMENTAL METERS

- Measures relative humidity, air velocity, light levels, and temperature with a type J/type K thermocouple thermometer
- Real time data logger with integral 4 GB SD memory card (optional)
- RS232 and USB interface
- Air velocity is measured in m/s, ft/min, km/h, mph or knots
- Light levels are measured in ftc or lux
- Light range: 0 to 20 000 lux
- Humidity range: 5 % to 95 % RH
- Air velocity range: 0.4 to 25.0 m/s
- Temp. range: J: -50° to 1200 °C; K: -50° to 1300 °C



REED

Model No.	Mfg. No.	Description	Price/Each
IA795	SD-9300	Environmental Meter	

SPEED, DISTANCE & LENGTH MEASURERS

TACHOMETERS

- Dual function unit with both contact and non-contact capabilities
- Supplied with adapters for fpm, rpm and surface speed measurements
- Non-contact function utilizes laser light beam for improved accuracy
- Recalls Max/Min and last values
- Large, easy-to-read display
- Autoranging with 0.05% accuracy
- Includes battery and carrying case
- Measuring Range: Photo: 5 to 99,999 rpm; Contact: 5 to 19,999 rpm; Surface Speed: 0.05 to 1999 mpm



HX386

TACHOMETERS

- Patented design incorporates both a photo and a contact tachometer into one precision instrument
- Ranges: from 0.5 to 20 000 rpm in contact mode; from 5 to 99 999 rpm in photo mode; surface speed from 0.05 to 1999.9 mpm (0.2 to 6560 fpm)
- Linear surface speed measurements are 0.2 to 6560 fpm or 0.05 to 1999.9 mpm
- Automatically holds last reading for five minutes and recalls min. and max. readings
- Characters on the large 5-digit display reverse direction depending on which measurement mode you are in
- Provides accuracy to 0.05% and permits readings to a resolution of 0.1 rpm in either photo or contact mode



HF964

REED

Model No.	Mfg. No.	Description	Price/Each
HX386	R7100	Photo/Contact Tachometer	
IA046	ST-CONE	Replacement Contact Adapter	
IA047	ST-WHEEL	Replacement Surface Speed Wheel	
IA740	ST-FUNNEL	Replacement Funnel Tip	
IA741	ST-SHAFT	Replacement Extension Shaft	

REED

Model No.	Mfg. No.	Description	Price/Each
HF964	R7140	Photo/Contact Tachometer	
IA046	ST-CONE	Replacement Contact Adapter	

COMPACT PHOTO TACHOMETER

- Provides fast and accurate RPM measurements of rotating objects without contact and revolution count of moving objects
- Built-in laser pointer identifies target area
- Durable double molded plastic housing and large backlit LCD display
- Internal memory recalls maximum, minimum values as well as last value stored
- Low battery indicator and auto shut-off
- Visible Indicator: Yes (Laser)
- Target Distance: 1.6ft (500mm)
- Display Size/Type: 5 Digit LCD Display
- Auto shut-off: Yes (after 10 secs)
- Power Supply: 9V battery
- Product Certifications: CE
- Dimensions: 6-5/16" x 2-5/16" x 1-1/2"



IA419

R8002 LASER DISTANCE METERS

- Easily measure hard-to-access areas, like high ceilings, with laser targeting
- Instant measurement with one-button operation
- Quick calculation of area (square footage) and volume
- Easy addition and subtraction of measurements
- Pythagoras calculation for determining distance indirectly from two or three other measurements
- Reference point setting function
- Metric or Imperial units of measure
- Display backlight
- Storage of last 10 measurement results
- Measuring Range: -0.16' - 147.6' (-0.05 m - 45 m)
- Accuracy: ≤ 10 m: ± 2.00 mm; > 10 m: ± 2 mm ± 0.05 (x distance in metres -10)
- Laser type: Class II, < 1 mW, 620 to 690 nm
- Power supply: 2 x AAA 1.5 V batteries



IB750

REED

Model No.	Mfg. No.	Description	Price/Each
IA419	R7050	Photo Tachometer	

REED

Model No.	Mfg. No.	Description	Price/Each
IB750	R8002	Laser Distance Meter	

Can't find what you're looking for?
Call us today!



TALLY COUNTERS

MODEL HD317 HAND TALLY COUNTERS

- Sturdy 4-figure hand-operated reset counter
- Push button actuator and handy thumb ring for easy operation
- Chrome plated steel case resists damage from perspiration
- Recommended for applications where operator must be mobile, such as checking meeting attendance, taking warehouse inventories, etc.



MODEL HD339 STAND TALLY COUNTERS

- Sturdy 4-figure hand-operated reset counter
- Special mounting base designed for desk, bench or clipboard mounting
- Heavy gauge steel case and base are chrome plated to resist corrosion
- Recommended for fixed applications such as assembly line parts counting, traffic surveys, etc.



BAKER INSTRUMENTS

Model No.	Mfg. No.	Description	Price/Each
HD317	7655	Hand Tally Counter	
HD339	8-005-1	Stand Tally Counter	

PLASTIC RATCHET COUNTERS

- Reliable, low cost, plastic counters for all purposes
- Operated by stroke (ratchet) drive
- Counts with one 45° adjustable lever movement (spindle on right side)
- 5-figure register with knob reset
- Supplied with connecting spring
- 5-figure reset counter counts machine revolution
- Adds when lever is revolved counter clockwise (spindle on right side)



TRUMETER

Model No.	Mfg. No.	Description	Price/Each
HA931	2012-5	Right Ratchet Counter, Plastic	

STOP WATCHES

MODEL IA078

- High contrast digital display with backlight
- Clock, date and alarm functions
- Records real time and split times
- Remembers first 30 laps and their split times (max. 99 laps displayed)
- 1/100th second resolution up to 100 hours
- Shock and water-resistant case



MODEL IA006

- Large LCD that displays real time and records split times for accurate result
- Clock, date and alarm function
- Water-resistant
- Includes: Batteries and a 48" nylon lanyard which allows you to comfortably hang the stopwatch around your neck



BIOS Fitness

Model No.	Mfg. No.	Description	Price/Each
IA078	FP603	Digital Stop Watch, w/neck lanyard and battery	
IA006	FP600	Digital Stop Watch, w/neck lanyard and battery	

K4030 STROBOSCOPES

- Freeze the motion and measure the speed of a rotating object, without contact
- Push button that doubles and one that divides in half the flashing and display rate with just one activation
- Coarse and fine adjustment buttons to synchronize flash to exactly the right rate
- Duty cycles from 10 minutes to 2 hours depending on rpm range
- Exclusive one-chip micro-computer LSI circuit and crystal control time-base
- External trigger input
- RS232 serial interface

SPECIFICATIONS:

Flash tube type: Xenon white lamp, 6500°K

Flash duration: Approx. 60 to 1000 μs

Measuring range: 10 to 10500 rpm

Resolution: 0:1 rpm; 5 to 999.9 rpm; 1 rpm: 1000 to 9999 rpm; 10 rpm: = 10000 rpm

Accuracy: ±(0.15% rdg. +0.2 rpm) < 1000 rpm; ±(0.5% rdg. +1 rpm): 1000 to 3300 rpm; ±1% f.s.: 3301 to 10500 rpm



REED

Model No.	Mfg. No.	Description	Price/Each
HX282	K4030	Stroboscope	

MINI TIMERS

- Easy to use
- Slim design
- Counts up or down to a maximum of 99 minutes, 59 seconds
- Magnetic back
- Pocket size
- Rubberized finish



BIOS Professional

Model No.	Mfg. No.	Description	Price/Each
IA809	138HC	Mini Timer	

JUMBO DIGITAL TIMERS

- Jumbo LCD display
- Minutes and seconds
- Count down timer
- 30-second beeper alarm
- Magnetic back, built-in clip, retractable stand



BIOS Professional

Model No.	Mfg. No.	Description	Price/Each
HX500	DT122	Digital Timer	

DISTANCE MEASURING WHEELS

- Ideal for road distance measuring applications
- Fitted with a 1 m circumference wheel
- Two measuring modes: Trip and Total
- Accuracy: ± 1%
- Adds forward, subtracts in reverse
- Metric and imperial measurement
- Measure in meters, yards or feet and inches at the push of a button
- Large LCD display is crystal clear in direct sunlight
- Backlight for low light conditions
- Waterproof for all weather conditions
- Push button reset
- Electronic brake
- Telescopic handle
- Mud scraper
- Minimum 5-year battery life



TRUMETER

Model No.	Mfg. No.	Description	Price/Each
HC438	5505E	Distance Measuring Wheel	

VIBRATION & FORCE GAUGES

ELECTROMAGNETIC FIELD METERS

- AC & DC magnetic field measurement
- Measurements Range: ± 3000 milliGauss
- Measurements in milliGauss or μT (microTesla)
- Detects magnetic fields as small as 0.1 milliGauss
- N pole/S pole indicator
- Zero adjustment button for relative measurement
- Data hold and max./min. record
- Easy to read LCD with backlight
- Auto or manual power off
- RS232 and USB interface

Model No. IA806
Mfg. No. GU-3001
Price/Each \$

REED



VIBRATION METERS

- Measures vibration levels in machinery
- Unique vibration sensor with magnetic base
- Peak hold, data hold and max./min. record
- Real time data logger with integral 4 GB SD memory card (optional)
- RS232 and USB interface
- Metric or Imperial measurement units
- Acceleration Range: 0.5 to 199.9 m/s^2
- Velocity Range: 0.5 to 199.9 mm/s

REED

Model No.	Mfg. No.	Description	Price/Each
IA803	SD-8205	Vibration Meter	
IB835	SD-4GB	Memory Card - 4 GB	



DIGITAL FORCE GAUGES

- Provides readings of tension (push) or compression (pull) in kg, lb, oz. and Newton units
- Instantly recalls "Peak Load" (max. load) and average readings
- Microprocessor assures $\pm 0.2\%$ accuracy and fast 0.8 second update time
- 100% Zero/Tare control enables maximum pre-load to be stored in the memory
- Zero Adjust push-button and Peak Hold switch
- Selectable fast/slow response
- Large 5-digit LCD display is reversible to match viewing angle
- Holes on the back of the meter case facilitate test stand mounting
- Battery or AC-line operated (uses 6 x 1.5 V "AA" batteries)
- Auto Power Off minimises power consumption and saves battery life
- Includes separate load cell sensor with 2 hooks and cable and carrying case
- Model IA804: Includes flat head, cone head, chisel head and hook adapters, 120mm extension rod and carrying case, capacity: 20 kg, 44 lbs., 196 N
- Model IA805: Includes separate load cell sensor with 2 hooks and cable and carrying case, capacity: 100 kg, 220 lbs., 980 N



IA804



IA805



HX279

REED

Model No.	Mfg. No.	Description	Price/Each
IA804	SD-6020	20-kg Capacity	
IA805	SD-6100	100-kg Capacity	
HX279	FS-1001	Test Stand	

MEASURING COUNTERS

- Ideal for a wide range of applications on machines where an accurate record of lengths is required
- All units utilize the senior series MKII counters with reset, either totalizing or predetermining models
- SR3 has a hinge arrangement, enabling the unit to be mounted in virtually any position
- SR4 comprises one stand, one stay rod 8" in length and one measuring wheel
- SR7 is supplied with 1 stand and 18" long stay rod and two measuring wheels
- Counter can be tilted over to be out of the way when not in use
- Standard measuring wheels are 5/8" wide rubber covered
- 12" circumference wheels are supplied for imperial measurement and 1/3 meter circumference wheels for metric measurement

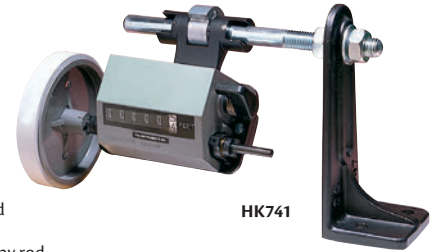

HK741

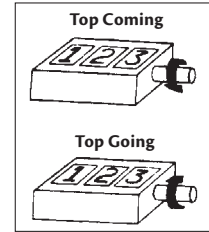

TRUMETER

TOP COMING

TOP GOING

Model No.	Mfg. No.	Model No.	Mfg. No.	Description	Price/Each
HK741	SR3MOTC	HK742	SR3MOTG	Counter, Metres Only	
HK739	SR3MDTC	HK740	SR3MDTG	Counter, Metres and Decimetres	
HK737	SR3FOTC	HK738	SR3FOTG	Counter, Feet Only	
HK735	SR3FITC	HK736	SR3FITG	Counter, Feet and Inches	
HK749	SR4MOTC	HK750	SR4MOTG	Counter, Metres Only	
HK747	SR4MDTC	HK748	SR4MDTG	Counter, Metres and Decimetres	
HK745	SR4FOTC	HK746	SR4FOTG	Counter, Feet Only	
HK743	SR4FITC	HK744	SR4FITG	Counter, Feet and Inches	
HK757	SR7MOTC	HK758	SR7MOTG	Counter, Metres Only	
HK755	SR7MDTC	HK756	SR7MDTG	Counter, Metres and Decimetres	
HK753	SR7FOTC	HK754	SR7FOTG	Counter, Feet Only	
HK751	SR7FITC	HK752	SR7FITG	Counter, Feet and Inches	
HB237	25-C7571/1	-	-	Imperial Wheel	
HB238	25-C7905/1	-	-	Metric Wheel	

WIRE MEASURERS

- Accommodates a wide variety of flexible materials, from 1/64" to 7/8" (.4 to 24 mm) diameter
- Measures wire rope and similar stiff materials to 1/2" (13 mm) diameter
- Quickly interchangeable guide tubes with I.D.s of 1/4" (6.3 mm) and 1" (25 mm) afford accurate guiding of many hard to measure material
- Low friction, positive control guiding components assure straight-line contact with the measuring wheel so important to measure accuracy
- Stainless and heat-treated steel used for all shafts and surfaces subject to wear by material's passage
- Convenient release handles for quick and easy loading
- Mechanical counters rated at 1000 ft./min. (300 m/min.) are housed in sturdy, dust-tight cases
- Counters add or subtract and reset to zero with one turn of the knob

Model HD571: Reel forms a round coil which can be tied before collapsing. The coil off-loads to front.

Model HA917: Mounts on all 1400 Series measurers at the correct height in relation to payout and takeup reels (14" high).

Model HF242: Mounts at exit edge of measurer. Slicing action of blade cuts cleanly. Easily resharpened. Not intended for steel wire, armored cable or very fine wire.



HA481



Model No.	Mfg. No.	Description	Price/Each
HA481	1410/B	Wire Measurer, Feet and Inches up to 9999'11"	
HA486	1420/B	Wire Measurer, Meters and Decimeters up to 999.9m	
HD571	99	Collapsible Reel and Stand	
HA917	201	Stand	
HF242	CUTTER-8	Wire Cutter	

SEESNAKE® MICRO™ INSPECTION CAMERAS

The CA-100 inspection camera allows you to perform more detailed visual inspections in even harder-to-reach areas. The micro™ CA-100 comes standard with a rugged 3/4" (17 mm) anodized aluminum camera head with four super bright LEDs. Easily rotate the active image counter-clockwise to see in any situation.

SPECIFICATIONS:

Display: 3.5" colour LCD (320 x 240 resolution)
Camera head: Aluminum 17 mm
Lighting: 4 adjustable LEDs
Cable reach: 3' (Expandable to 30' w/ optional extensions)
Video output: 3' RCA cable (included)
Waterproof: Camera head and cable to 10' (when properly assembled)
Power source: 4 AA batteries
Attachments: Mirror, hook and magnet



Model No.	Mfg. No.	Description	Price /Each
IA840	36738	micro™ CA-100 Inspection Camera	
IA841	37103	17 mm Replacement Imager	
IA842	37108	3' Cable Universal Extension	
IA843	37113	6' Cable Universal Extension	

MICRO™ CA-350 INSPECTION CAMERAS

Documentation made easy with the new Ridgid® micro™ CA-300 inspection camera. Easily record still images and videos of problems. Comfortable pistol-grip design, large screen, and rugged anodized aluminum camera head with four bright LEDs. Features image rotation and digital zoom.

SPECIFICATIONS:

Display: 3.5" (90 mm) colour TFT
Camera diameter: 0.66" (17 mm) LCD (320 x 240 resolution)
Lighting: 4 adjustable LEDs
Cable reach: 3' (0.9 m) (Expandable to 30' with optional extension also compatible with microDrain™, microReel™ and nanoReel™)
Images: JPG - Good (640 x 480), Better (1024 x 768), Best (1600 x 1200)
Video: AVI - Good (320 x 240), Best (640 x 480)
External memory: SD card up to 32 GB (4 GB SD card included)
Power source: Rechargeable 3.7 V Li-Ion battery
Included: micro™ CA-300 with 17 mm imager, battery, charger, USB card, hook, magnet and mirror accessories, RCA cable, AC adapter, headset with microphone, 4 GB SD card, 1-year RidgidConnect™ basic subscription



Model No.	Mfg. No.	Description	Price /Each
IA844	55898	micro™ CA-350 Inspection Camera	
IA841	37103	17 mm Replacement Imager	
IA842	37108	3' Cable Universal Extension	
IA843	37113	6' Cable Universal Extension	
IA845	37083	3.7 V Li-Ion Battery	
IA846	37098	3' (6 m) Imager Head	

RECORDABLE BORESCOPE INSPECTION CAMERA

- Camera and video functions save high resolution images and video
- Comfortable pistol grip design
- High-resolution, 2.5", color, LCD monitor
- Waterproof (IP67) camera head
- 39" (m) gooseneck cable retains configured shape
- Expandable cable up to 30 ft. (9m) with extensions (optional)
- Four high-visibility LED lights
- 180° mirror rotation function
- Low battery indicator and auto shut off after 10 minutes
- Expandable memory up to 32Gb (SD card sold separately)
- Includes: Video BoreScope Inspection Camera, Recordable, 9mm Camera Head, Camera Probe, BoreScope, Magnet, Hook and Mirror Attachments, Batteries, USB Cable, and Hard Carrying Case
- Display Size: 2.5"
- Resolution: 640 x 480 pixels
- Camera Head: 9 mm (0.35")
- Frames Per Second (FPS): 30
- Playback: Photo (JPEG) and Video (AVI)
- Digital Zoom: 4x
- Time and Date Stamp: Yes
- Data Output: USB/SD Card
- Power Supply: 4 AA Batteries
- Operating Temperature: 14 to 122°F (-10 to 50°C)



Model No.	Mfg. No.	Description	Price /Each
IB888	R8500	Recordable BoreScope Inspection Camera	
IB889	R8500-3MEXT	9.84' (3 m) Cable Extension	
IB894	R8500-3.9MM	3.9 mm Camera Head	
IB892	R8500-ART	5.5 mm Articulating Camera	
IB893	R8500-RCH	Replacement 9 mm Camera Head on 39" (1 m) Cable	
IB890	R8500-5M9MM	Replacement 9 mm Camera Head on 16.4' (5 m) Cable	
IB891	R8500-20M	Replacement 9.8 mm Camera Head on 65.6' (20 m) Cable	

R9000 PIPE VIDEO INSPECTION SYSTEM

- Cost effective portable inspection camera
- Designed to deliver quality video inspection in a wide range of applications including: sewers, building ducts/piping, wells, and power plants
- System includes camera head, cable reel, battery pack and DVR
- Camera head contains 12 white LED lights, a flexible spring coiled joint to navigate corners, a scratch-resistant sapphire lens cover and a stainless steel housing that allows the camera to withstand various hits
- High resolution CCD chip is designed to capture bright, crisp, colour video of the inspection area
- Cable reel is mounted and rotatable in the case, therefore the cable can be extended without the need to hold the reel
- Sun visor is included to act as a sun shield for outdoor inspections
- DVR Resolution: 800 x 480 RGB
- DVR Output: TV and Audio
- External Memory: Supports SD memory card up to 32GB
- Viewing Angle: 140°
- Display Size: 7"
- Camera Head: 0.9" (23 mm)



Model No.	Mfg. No.	Description	Price /Each
IB751	R9000	Pipe Video Inspection System	
IB895	R9000-40M	131.2' (40 m) Cable Extension	
IB896	R9000-CAMT	Camera Head with Transmitter	
IB897	R9000-RCV	Portable Inspection Camera Receiver	

AIR VELOCITY METERS

ANEMOMETERS

- Data hold, Record (Max/Min)
- Integral vane design for one hand operation
- Push button operation
- Pocket-sized
- Includes battery
- Air Velocity Range:
80 to 5910 fpm; 0.4 to 30 m/s;
0.9 to 67 mph; 1.4 to 108 km/h;
0.8 to 58.3 knots



REED

Model No.	Mfg. No.	Description	Price/Each
HX286	LM-81 AM	Thermo-Anemometer	

THERMO-ANEMOMETERS

- All-in-one meter with integral rotary vane sensor
- Simultaneous display of air velocity and temperature
- Selectable wind speed units: Knots, mph, km/h
- Calculate air volume by keying in area dimension
- Continuous moving air velocity averaging of measurements for up to 2 hours
- Displays Min/Max/Avg velocity with temperature values
- Multi-point averaging up to 8 points
- Calculate average velocity values in seconds
- High-contrast, 4-digit LCD readout
- RS-232 interface
- Data hold and auto power off
- Air Velocity Range: 80 to 5900 fpm; 0.4 to 30 m/s;
0.9 to 68 mph; 1.4 to 108 km/h; 0.8 to 58 knots
- Temperature Range: -10° to 50°C; 14° to 122°F



REED

Model No.	Mfg. No.	Description	Price/Each
IA040	8906	Thermo-Anemometer	

THERMO-ANEMOMETERS

- 4-in-1 multi-function meter: anemometer, humidity meter, light meter and type-K digital thermometer
- Data hold, Record (Max/Min)
- Integral vane design for one hand operation
- Push button operation
- Pocket-sized
- Includes battery
- Air Velocity Range:
80° to 5910 fpm; 0.4 to 30 m/s;
0.9 to 67 mph; 1.4 to 108 km/h;
0.8 to 58.3 knots
- Temperature Range:
Air: 0° to 50°C; 32° to 122°F;
Input: -100° to 1300°C; -148° to 2372°F
- Humidity Range: 10 to 95% RH
- Light Range: 0 to 20,000 lux; 0 to 2,000 Ft-c



REED

Model No.	Mfg. No.	Description	Price/Each
HX285	LM-8000	Multi-Function Meter	

THERMO-ANEMOMETERS

- Measures air velocity as well as temperature with a type J/type K thermocouple thermometer
- Low friction ball-bearing, rotating vane probe
- RS232 and USB interface
- Real time data logger with integral 4 GB SD memory card (optional)
- Air velocity is measured in m/s, ft/min, km/h, mph or knots
- Temperature is measured in °C or °F
- Air Velocity Range: 0.5 to 30.0 m/s
- Type J Temp. Range: -50 to 1200°C
- Type K Temp. Range: -50 to 1300°C



REED

Model No.	Mfg. No.	Description	Price/Each
IA796	SD-4207	Anemometer	

THERMO-ANEMOMETERS

MEASURES AIR VELOCITY, AIR VOLUME & AIRSTREAM TEMPERATURE

- Newly developed reversible head for measuring air velocity at exhaust and inlet grilles with one instrument
- Sweep mode measures average air velocity or air volume over an area or period of time
- Displays measurements in metric or imperial units
- Ergonomically designed for high performance, unrivalled accuracy and ease of use
- Air Velocity Range: 0.25 to 30 m/s (50 to 6000 fpm)
- Temperature Range: 0 to 60°C (32 to 140°F)
- Volumetric Flow Rate: 1 to 999 999 l/s (1 to 9999 000 cfm)
1 to 999 999 m³/h, 0.1 to 3000 m³/s
- Optional AirCones quickly convert the model **HK666** into an air volume flow balancing tool
- Aerodynamic design for minimal resistance
- Two sizes suit most supply and extract grilles
- Self sealing for leak tight readings
- Constructed of hard wearing ABS
- Volume flow curves in m³/sec and cfm
- Air Volume Range:
0 to 0.1 m³/s (0 to 210 cfm)



ALNOR
A TSI Company

Model No.	Mfg. No.	Description	Price/Each
HK666	RVA801	Rotating Vane Thermo-Anemometer	
IA116	801750	Volumetric Flow Hoods	

THERMO-ANEMOMETERS

- Measures air velocity as well as temperature with a type J/type K thermocouple thermometer
- Hot wire probe
- Real time data logger with integral 4 GB SD memory card (optional)
- RS232 and USB interface
- Air velocity is measured in m/s, ft/min, km/h, mph or knots
- Temperature is measured in °C or °F
- Air Velocity Range: 0.2 to 25.0 m/s
- Type J Temp. Range: -50 to 1200°C
- Type K Temp. Range: -50 to 1300°C



REED

Model No.	Mfg. No.	Description	Price/Each
IA797	SD-4214	Thermo-Anemometer	
IB835	SD-4GB	Memory Card - 4 GB	

MANOMETERS

- Measures gauge and differential pressure from 0 to 5 psi
- 11 selectable units of measure: psi, inH₂O, bar, mbar, kPa, inHg, mmHg, ozin², ftH₂O, cmH₂O, kgcm²
- Dual LCDs with backlighting
- Max/Min/Avg record with time stamp
- Data Hold freezes the displayed reading
- Low battery indication with auto power off
- Push button zero adjust and offset readings
- USB output
- Includes USB cable, tubing, hard carrying case and battery
- Accredited calibration available

SPECIFICATIONS:

Pressure Range:	5.000 psi; 138.3 inH ₂ O; 344.7 mbar; 34.47 kPa; 1.018 inHg; 258.5 mmHg; 80.00 ozin ² ; 11.53 ftH ₂ O; 351.5 cmH ₂ O; 0.351 kgcm ² ; 0.344 bar
Resolution:	0.001 psi; 0.1 inH ₂ O; 0.1 mbar; 0.01 kPa; 0.001 inHg; 0.1 mmHg; 0.01 ozin ² ; 0.01 ftH ₂ O; 0.1 cmH ₂ O; 0.001 kgcm ² ; 0.001 bar
Accuracy:	±0.3% f.s.
Repeatability:	±0.2% f.s.
Hysteresis:	±0.29% f.s.
Maximum Pressure:	20 psi
Response Time:	0.5 second
Power Supply:	Single 9V alkaline battery



ANEMOMETER/MANOMETERS

- Measure and display air velocity, air flow volume, pressure and ambient temperature with a single, compact unit
- Air velocity displayed in m/s, fpm, km/h, mph or knots
- Air flow displayed in cfm or cmm
- Pressure displayed in psi, mbar, inH₂O, mmH₂O or Pa
- Temperature displayed in °C or °F
- Max., Min. and Avg. readings
- Real time clock provides for time-stamped measurements
- Push button calculation of rectangular or circular duct areas
- Large LCD display with backlight
- Auto power off and low battery indication
- USB interface
- Includes black and white silica tubes, Pitot tube, power adapter, USB cable, 9V battery, CD software and carrying case



SPECIFICATIONS:

Pressure Range:	±5000 Pa; 0.752 psi; 50.00mbar; 20.07 inH ₂ O; 509.8 mmH ₂ O; 1 Pa; 0.0001 psi; 0.01 mbar; 0.01 inH ₂ O; 0.1 mmH ₂ O
Resolution:	±0.3% FSO
Accuracy:	±0.2% FSO
Repeatability:	±0.29% FSO
Linearity/Hysteresis:	±0.29% FSO
Air Velocity Range:	1.00 to 80.00 m/s; 200 to 15,733 fpm; 3.6 to 288.0 km/h; 2.24 to 178.66 mph; 2.0 to 154.6 knots
Resolution:	0.01 m/s; 1 fpm; 0.1 km/h; 0.01 mph; 0.1 knots
Accuracy:	±2.5% rdg.
Air Flow Range:	0 to 99,999 ft ³ /min; 0 to 99,999 m ³ /min
Resolution:	0.001 ft ³ /min; 0.001 m ³ /min
Accuracy:	Function of air velocity and duct size
Temperature Range:	0 to 50.0°C; 32.0 to 122.0°F
Resolution:	0.1°C; 0.1°F
Accuracy:	±1.0°C; ±2°F
Power Supply:	Single 9V battery

REED

Model No.	Mfg. No.	Description	Price/Each
IA980	R3002	Digital Manometer	

REED

Model No.	Mfg. No.	Description	Price/Each
IA979	R3001	Anemometer/Manometer	

KLETON

Canada's Leading Material Handling Supplier

MANOMETERS & PRESSURE GAUGES

BALOMETERS

- Detachable manometer can be used with optional probes
- Reads in. H₂O, ft H₂O, PSI, in. Hg, mm Hg, m H₂O, kPa, mm Hg, bar
- Displays Min, Max and Average of up to 1000 readings
- Stores up to 1000 readings with time and date stamp
- Battery operated
- Includes CompuDat® software to download data to PC
- Shipped complete with manometer, 2' x 2' air capture hood/frame/base, 4 "AA" size rechargeable NiMH batteries, external battery charger, 18" pitot probe, 2 static pressure probes, 16 ft. neoprene tubing, wheeled carrying case, software and manual
- Diff. Pressure Range: ± 15 in. H₂O (3735 Pa)
- Absolute Pressure Range: 15 to 40 in Hg (356 to 1016 Hg)
- Air Velocity Range:
 - 25 to 8000 fpm (0.125 to 40 m/s) pitot tube; 25 to 5000 fpm (0.125 to 25 m/s) air flow probe; 25 to 2500 fpm (0.125 to 12.5 m/s) velocity matrix
- Air Volume Range: 25 to 2500 ft³/m (42 to 4250 m³/h)
- Humidity Range: 0 to 95% RH (optional probe)
- Temperature Range: -40° to 250°F (-40° to 121°C) probe dependent



IA120



Model No.	Mfg. No.	Description	Price/Each
IA120	EBT721	Balometer, Electronic Kit	
IA575	800187	Air Foil Probe	
IA576	800188	Probe, Temperature	
IA577	800189	Probe, Temp/RH	
IA578	801090	16-Point Velocity Matrix w/Telescopic Handle	
IA579	801206	Hood Expansion Kit, 2 hoods, 1' x 4' and 2' x 4'	
IA580	801207	Hood Expansion Kit, 2 hoods, 1' x 5' and 3' x 3'	

MANOMETERS

- Digital display of gauge or differential
- Select from one of 11 different pressure units
- Data hold
- Max/Min Record
- Display backlight
- Auto power off
- Low battery indicator
- Simple fittings for hose connection
- Optional RS-232 interface
- Includes hard carrying case, 9 V battery, connection hose and manual
- Pressure Range: **IA138:** 0 to 30 PSI; **IA139:** 0 to 100 PSI



IA138



Model No.	Mfg. No.	Description	Price/Each
IA138	R3030	Digital Manometer	
IA139	R3100	Digital Manometer	

MANOMETERS

- Positive or negative pressure measurements
- Auto power off to conserve battery life
- Electronic zeroing function for offset measurements
- Large, easy-to-read display
- Extruded aluminum case
- Pressure Range: -20 to 20" w.c. (-50 to 50 mbar)



IA135



Model No.	Mfg. No.	Description	Price/Each
IA135	476A-0	Digital Manometer	

MANOMETERS

- Instant selection from up to nine English/metric units: PSID, in H₂O, mm H₂O, in Hg, mm Hg, Pa, kPa, bar, Mbar
- Stores 20 readings in memory for later reference
- Measure positive, negative or differential pressures
- Audible and visual overpressure alarms
- Large, easy-to-read 0.4" LCD readout includes switchable backlight
- Electronic zeroing lets you null out any minor differences
- Display hold key freezes current pressure reading
- Operates up to 100 hours on a single 9 Volt battery
- Auto shut-off to minimize battery drain
- FM approved as intrinsically safe for hazardous locations Class 1, Div. 1, Group A, B, C, D, T4.



HM543



Model No.	Mfg. No.	Range	Price/Each
HM543	477-1-FM	0-20 in. w.c./0-5 kPa	
HM544	477-2-FM	0-40 in. w.c./0-10 kPa	
HM545	477-3-FM	0-200 in. w.c./0-50 kPa	
HM546	477-4-FM	0-10 PSID/0-70 kPa	
HM547	477-5-FM	0-30 PSID/0-200 kPa	
IA136	477-6-FM	0-100 PSID/0-700 kPa	
IA137	477-7-FM	0-150 PSID/0-1000 kPa	

Zenith sorbents...
Work as hard as you do!

ZENITH
 Safety Products

MANOMETERS & PRESSURE GAUGES

MANOMETERS

- Measures positive, negative or differential pressures of air and other gases
- New FM approved option is intrinsically safe for hazardous locations, Class I, Div.1, Group A, B, C, D, T4
- When used with a pitot tube, can also be used as an air velocity gauge
- Dual push pads on the front panel control on-off operation and English or metric pressure unit selection - all with no set-up or levelling
- Zero adjust knob is conveniently located on top
- Large 1/2" LCD display is easy to read in even the poorest lighting conditions, includes a "low battery" indicator
- Standard connections are dual sized for 1/8" or 3/16" I.D. vinyl or rubber tubing



IA127



Model No.	Mfg. No.	Range	Price/Each
IA124	475-000-FM	0-1.00 in. w.c./0-.249 kPa	
IA125	475-00-FM	0-4.00 in. w.c./0-.995 kPa	
IA126	475-0-FM	0-10.00 in. w.c./0-2.49 kPa	
IA127	475-1-FM	0-19.99 in. w.c./0-4.97 kPa	
IA128	475-2-FM	0-40.0 in. w.c./0-9.95 kPa	
IA129	475-3-FM	0-199.9 in. w.c./0-49.7 kPa	
IA130	475-4-FM	0-10.00 PSID/0-.689 bar	
IA131	475-5-FM	0-19.99 PSID/0-1.378 bar	
IA132	475-6-FM	0-30.0 PSID/0-2.07 bar	
IA133	475-7-FM	0-100 PSID/0-6.89 bar	
IA134	475-8-FM	0-150 PSID/0-10.34 bar	

DUAL RANGE INCLINED U-TUBE MANOMETERS

- As a regular U-tube manometer it indicates high range pressure from 0 to 16 inches of water (with .2" minor divisions) on the right leg; as an inclined manometer it reads low range pressure from -.20 to 0 to 2.6 inches of water (with .02" minor divisions) on the left leg
- Easy to use; simply incline unit until fluid level reads zero
- Magnetic clips hold the gauge in position on steel duct surface
- Unit comes complete with:** Two magnetic clips to hold the instrument to metal surfaces; two plastic carrying plugs with retainers for use when the manometer is not in service; flexible vinyl plastic tubing connectors; 4 1/2' length of plastic tubing; brass terminal tube, 1/4" dia. x 8" long; 1/8" NPT brass adapter; 3/4 oz. bottle red gauge fluid; and vinyl carrying case.



HA382

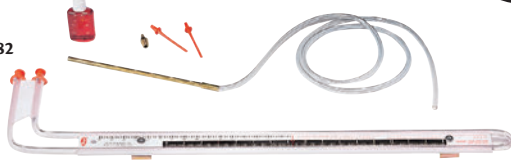

Model No.	Mfg. No.	Description	Price/Each
HA382	1227	Inclined U-Tube Manometer	

INCLINED/VERTICAL MANOMETERS

- Inclined section for high accuracy and vertical section for extended range
- Velocity marked in red; air pressure marked in black
- Screw leveling adjustment and ground glass bubble level

KIT INCLUDES NO. 400 AIR METER & ALL ACCESSORIES:

- Stainless steel calibrated pitot tube (18") - Graduated both sides in inches to show insertion depth for easy, accurate duct traverse
- Rubber tubing with connectors - 2 coils of 3/8" with metal terminal tubes
- Magneclip side mountings - Attaches meter instantly to steel duct or surface
- Air velocity calculator - Slide rule eliminates tedious calculations
- Red gauge oil - Spare bottle for occasional refilling
- Instruction card
- Steel carrying case



HB911



Model No.	Mfg. No.	Pressure	Velocity	Inclined Range	Vertical Range	Price/Each
HB911	400-5L	0-5" H ₂ O	400-9000 FPM	0-1" w.c.	1-5" w.c.	
HB909	400-10	0-10" H ₂ O	400-12,600 FPM	0-1" w.c.	1-10" w.c.	
HB910	400-23	0-23" H ₂ O	600-19,200 FPM	0-2.3" w.c.	2.3-23" w.c.	

SLACK TUBE MANOMETERS

- All models have flexible vinyl-plastic columns and flexible spring steel scale calibrated in inches of water using water, and inches of mercury using mercury
- Scale is centre-mounted between columns to eliminate parallax error and has a full 2-inch sliding zero adjustment
- All models feature exclusive moulded nylon tubing connector assemblies with rapid shutoff design and an acrylic plastic top
- Moulded all-nylon construction makes this assembly corrosion-proof, leakproof and practically unbreakable
- Tubing connectors extend horizontally allowing 360° freedom
- All models have over pressure safety traps in the top of both columns to prevent loss of fluid due to over range pressures or surges in pressure



HA314



Model No.	Mfg. No.	Description	Price/Each
HA314	1211-8	Slack Tube Manometer, 4-0-4 in	
HA303	1211-12	Slack Tube Manometer, 6-0-6 in	
HA305	1211-16	Slack Tube Manometer, 8-0-8 in	
HA307	1211-24	Slack Tube Manometer, 12-0-12 in	
HA308	1211-30	Slack Tube Manometer, 15-0-15 in	
HA309	1211-36	Slack Tube Manometer, 18-0-18 in	
HA310	1211-48	Slack Tube Manometer, 24-0-24 in	
HA312	1211-60	Slack Tube Manometer, 30-0-30 in	
HA313	1211-72	Slack Tube Manometer, 36-0-36 in	
HA304	1211-120	Slack Tube Manometer, 60-0-60 in	
HA311	1211-50	Slack Tube Manometer, 25-0-25 cm	
HA302	1211-100	Slack Tube Manometer, 50-0-50 cm	
HA306	1211-200	Slack Tube Manometer, 100-0-100 cm	

AIR FILTER GAUGES

- Compact inclined-vertical air filter gauge measures pressures both above and below atmospheric, as well as pressure differentials
- Logarithmic curve-shaped tube provides high range capacity with large, more easily read increments at low readings
- Operating range is 0 to 3 inches water, with divisions of 0.01 inch water at the low end scale, and 0.120 inch water at the high end
- Accurate to ± 3% of full scale
- Constructed of moulded acrylic plastic



HB239



Model No.	Mfg. No.	Description	Price/Each
HB239	25	Air Filter Gauge	

PITOT TUBES

- Hemispherical tip design means low sensitivity to misalignment
- Precisely located, burr-free static pressure holes
- 304 stainless steel construction
- 5/16" models rated to 1500°F, 1/8" models to 800°F
- Use 1/8" models in ducts as small as 4", 5/16" models in ducts 10" or larger
- Silver soldered connections for leak-proof operation
- Inch graduations on sides quickly determine exact insertion depth

HA584



Model No.	Mfg. No.	Description	Price/Each
HA532	160-8	Standard 5/16" Pitot Tube, 8" Insertion Length	
HA522	160-12	Standard 5/16" Pitot Tube, 12" Insertion Length	
HA525	160-18	Standard 5/16" Pitot Tube, 18" Insertion Length	
HA527	160-24	Standard 5/16" Pitot Tube, 24" Insertion Length	
HA528	160-36	Standard 5/16" Pitot Tube, 36" Insertion Length	
HA529	160-48	Standard 5/16" Pitot Tube, 48" Insertion Length	
HA530	160-60	Standard 5/16" Pitot Tube, 60" Insertion Length	
HA585	166-6	Pocket 1/8" Diameter Pitot Tube, 6" Insertion Length	
HA584	166-12	Pocket 1/8" Diameter Pitot Tube, 12" Insertion Length	
HA587	167-6	Pocket 1/8" Diameter Short Tip Pitot Tube, 6" Insertion Length	
HA586	167-12	Pocket 1/8" Diameter Short Tip Pitot Tube, 12" Insertion Length	

MANOMETERS & PRESSURE GAUGES

PROCESS GAUGES

- Stamped aluminum 4 1/2" (115 mm) diameter dial
- Black, impact resistant phenolic case
- 316 stainless steel bourdon tube and socket
- Silicone fluid filled and rated for -50° to 170°F
- 1/2% of full scale accuracy
- Transient over-pressure limit: 30%
- Restrictor screw
- Shatterproof glass lens
- Integral back flange
- Safety blowout backplate
- Micrometer adjustable pointer
- 1/4" or 1/2" NPT male connection bottom



IA361

BAKER
INSTRUMENTS

1/4" NPT		1/2" NPT		Dial Ranges	Price /Each
Model No.	Mfg. No.	Model No.	Mfg. No.		
IA399	LF45-15-1/4	IA351	LF45-15-1/2	30"-0-15 PSI	
IA335	LF45-30-1/4	IA352	LF45-30-1/2	30"-0-30 PSI	
IA336	LF45-60-1/4	IA353	LF45-60-1/2	30"-0-60 PSI	
IA337	LF45-30HG-1/4	IA354	LF45-30HG-1/2	30"-0 Hg Vac.	

1/4" NPT		1/2" NPT		Compound Scale Dial Ranges	Price /Each
Model No.	Mfg. No.	Model No.	Mfg. No.		
IA338	LF45-15P-1/4	IA355	LF45-15P-1/2	0-15 PSI/0-100 kPa	
IA339	LF45-30P-1/4	IA356	LF45-30P-1/2	0-30 PSI/0-200 kPa	
IA340	LF45-60P-1/4	IA357	LF45-60P-1/2	0-60 PSI/0-400 kPa	
IA341	LF45-100P-1/4	IA358	LF45-100P-1/2	0-100 PSI/0-700 kPa	
IA342	LF45-160P-1/4	IA359	LF45-160P-1/2	0-160 PSI/0-1100 kPa	
IA343	LF45-200P-1/4	IA360	LF45-200P-1/2	0-200 PSI/0-1400 kPa	
IA344	LF45-300P-1/4	IA361	LF45-300P-1/2	0-300 PSI/0-2100 kPa	
IA401	LF45-400P-1/4	IA362	LF45-400P-1/2	0-400 PSI/0-2800 kPa	
IA345	LF45-600P-1/4	IA363	LF45-600P-1/2	0-600 PSI/0-4200 kPa	
IA400	LF45-1500P-1/4	IA365	LF45-1500P-1/2	0-1500 PSI/0-10,500 kPa	
IA347	LF45-2000P-1/4	IA366	LF45-2000P-1/2	0-2000 PSI/0-14,000 kPa	
IA348	LF45-3000P-1/4	IA367	LF45-3000P-1/2	0-3000 PSI/0-21,000 kPa	
IA350	LF45-10000P-1/4	IA369	LF45-10000P-1/2	0-10,000 PSI/0-70,000 kPa	

PRESSURE GAUGES

- 4.5" diameter dial has dual English/metric scales
- Balanced adjustable black pointer
- Corrosion resistant stainless steel case and ring, plastic lens
- Soft soldered phosphor bronze tube with brass socket recommended for average general use
- Suitable for steam, water, air, oil, gas or any medium not corrosive to copper alloys
- 1/4" NPT bottom connection only
- 1% accuracy



IA328

BAKER
INSTRUMENTS

Model No.	Mfg. No.	Dial Range	Figure Intervals	Smallest Graduation	Price /Each
IA326	421 AVND-30	0-30 PSI/0-200 kPa	5 PSI	0.5 PSI	
IA327	421 AVND-60	0-60 PSI/0-400 kPa	10 PSI	1 PSI	
IA328	421 AVND-100	0-100 PSI/0-700 kPa	20 PSI	2 PSI	
IA329	421 AVND-160	0-160 PSI/0-1100 kPa	20 PSI	2 PSI	
IA330	421 AVND-200	0-200 PSI/0-1400 kPa	20 PSI	2 PSI	
IA331	421 AVND-300	0-300 PSI/0-2100 kPa	50 PSI	5 PSI	
IA332	421 AVND-500	0-500 PSI/0-3500 kPa	50 PSI	5 PSI	
IA333	421 AVND-30 VAC	30" - 0 Hg Vac	5"	0.5"	

PRESSURE GAUGES

- Stamped aluminum 2.5" diameter dial
- Polished stainless steel case
- Glass lens, pressed bezel
- Bronze tube and brass socket with brass movement
- 1/4" male NPT connection, bottom or back
- 1.6% accuracy
- Glycerine fill provides a dampening effect which minimizes pulsations; continuously lubricates gauge movement; and makes this gauge ideally suited for adverse environments



IA297

BAKER
INSTRUMENTS

Bottom Conn.		Price /Each	Back Conn.		Price /Each	Compound Scale Dial Ranges
Model No.	Mfg. No.		Model No.	Mfg. No.		
IA292	AVNC-30HG		IA309	AHNC-30HG		30" Hg-0" Vac.
IA293	AVNC-30		IA310	AHNC-30		30" Hg-0-30 PSI
IA294	AVNC-15P		HX508	AHNC-15P		0-15 PSI/0-100 kPa
IA295	AVNC-30P		IA312	AHNC-30P		0-30 PSI/0-200 kPa
IA296	AVNC-60P		IA313	AHNC-60P		0-60 PSI/0-400 kPa
IA297	AVNC-100P		IA314	AHNC-100P		0-100 PSI/0-700 kPa
IA298	AVNC-160P		IA315	AHNC-160P		0-160 PSI/0-1100 kPa
IA299	AVNC-200P		IA316	AHNC-200P		0-200 PSI/0-1400 kPa
IA300	AVNC-300P		IA317	AHNC-300P		0-300 PSI/0-2100 kPa
IA301	AVNC-400P		IA318	AHNC-400P		0-400 PSI/0-2800 kPa
IA302	AVNC-600P		IA319	AHNC-600P		0-600 PSI/0-4200 kPa
IA303	AVNC-1000P		IA320	AHNC-1000P		0-1000 PSI/0-7000 kPa
IA304	AVNC-1500P		IA321	AHNC-1500P		0-1500 PSI/0-10,500 kPa
IA305	AVNC-2000P		IA322	AHNC-2000P		0-2000 PSI/0-14,000 kPa
IA306	AVNC-3000P		IA323	AHNC-3000P		0-3000 PSI/0-21,000 kPa
IA307	AVNC-5000P		IA324	AHNC-5000P		0-5000 PSI/0-35,000 kPa
IA308	AVNC-6000P		IA325	AHNC-6000P		0-6000 PSI/0-42,000 kPa

PRESSURE GAUGES

- 2.5" diameter dial has dual English/metric scales
- ASME Grade B accuracy: ± 3% first 3rd of scale, ± 2% middle 3rd of scale, and ± 3% last 3rd of scale
- Corrosion resistant stainless steel case and ring, acrylic lens
- Brass internal materials
- 1/4" NPT bottom connection only
- Rated for -20 to 60°C and pressure steady at 75% f.s.



IA285

BAKER
INSTRUMENTS

Model No.	Mfg. No.	Dial Ranges	Price/Each
IA280	LVBNA-30HG	0-30" Hg Vac.	
IA281	LVBNA-30	30" Hg Vac to 30 PSI	
IA282	LVBNA-15P	0 to 15 PSI/0 to 105 kPa	
IA283	LVBNA-30P	0 to 30 PSI/0 to 210 kPa	
IA284	LVBNA-60P	0 to 60 PSI/0 to 420 kPa	
IA285	LVBNA-100P	0 to 100 PSI/0 to 700 kPa	
IA286	LVBNA-160P	0 to 160 PSI/0 to 1120 kPa	
IA287	LVBNA-200P	0 to 200 PSI/0 to 1400 kPa	
IA288	LVBNA-300P	0 to 300 PSI/0 to 2100 kPa	
IA289	LVBNA-400P	0 to 400 PSI/0 to 2800 kPa	
IA290	LVBNA-600P	0 to 600 PSI/0 to 4200 kPa	
IA291	LVBNA-1000P	0 to 1000 PSI/0 to 7000 kPa	

MANOMETERS & PRESSURE GAUGES

DIGITAL PRESSURE GAUGES

- ±0.5% full scale accuracy
- 4-digit digital display eliminates parallax errors
- Battery powered with auto-shut off
- 2000-hour battery life
- 4-button key pad allows easy access to features
- Peak and Valley function
- Tare or auto zero
- Selectable engineering units
- Display backlight

SPECIFICATIONS:

Service: Liquids and compatible gases
Wetted Materials: 316L SS
Accuracy: 0.50% f.s. ±1 LSD @ 32 to 130°F; ±2% f.s. @ 10°F; ±5% f.s. @ 0°F
Pressure Limits: 2000 PSI (IA431); 7500 PSI (IA383)
Temp. Limits: 0 to 130°F (-18 to 55°C)
Thermal Effect: 70-130°F: 0.016%/°F; 32-70°F: 0.026%/°F; 10-32°F: 0.09%/°F; 0-10°F: 0.50%/°F
Power Supply: (2) "AAA" batteries
Process Connection: 1/4" male NPT
Dimensions: 3.00" O.D. x 1.90" deep
Weight: 8.8 oz (275 g)



IA383



Model No.	Mfg. No.	Description	Price/Each
IA431	DPG-009	Digital Pressure Gauge, 1000 PSI	
IA383	DPG-011	Digital Pressure Gauge, 5000 PSI	

DIGITAL PRESSURE GAUGES

- Economical, digital pressure gauge for compatible liquids
- Selectable engineering units
- 1% accuracy

SPECIFICATIONS:

Service: Compatible liquids and gases
Accuracy: ±1.0% f.s. (includes linearity, hysteresis, repeatability)
Temperature Limits: 30 to 120°F (-1 to 49°C)
Thermal Effect: 0.05% f.s./°F
Pressure Limits: 2X pressure range. Vacuum range max. pressure is 30 PSIG
Process Connection: 1/4" male NPT
Housing Materials: ABS plastic
Wetted Materials: 316 SS
Display: 4-digit LCD
Power Supply: 9 V alkaline battery (included)
Dimensions: 2.62" O.D. x 1.52" deep
Weight: 5.6 oz (160 g)



IA430



Model No.	Mfg. No.	Description	Price/Each
IA430	DPGW-08	Digital Pressure Gauge, 100 PSI	
IA428	DPGW-09	Digital Pressure Gauge, 200 PSI	
IA429	DPGW-11	Digital Pressure Gauge, 500 PSI	

DIGITAL PRESSURE GAUGES

- Economical, digital pressure gauge for air and compatible gases
- Selectable engineering units
- 1% accuracy

SPECIFICATIONS:

Service: Air and compatible gases
Accuracy: ±1.0% f.s. (includes linearity, hysteresis, repeatability)
Temperature Limits: 30 to 120°F (-1 to 49°C)
Thermal Effect: 0.05% f.s./°F
Pressure Limits: 2X pressure range; vacuum range max. pressure is 30 PSIG
Process Connection: 1/4" male NPT
Housing Materials: ABS plastic
Wetted Materials: 316 SS, silicone sensor
Display: 4-digit LCD
Power Supply: 9 V alkaline battery (included)
Dimensions: 2.62" O.D. x 1.52" deep
Weight: 5.6 oz (160 g)



IA425



Model No.	Mfg. No.	Description	Price/Each
IA425	DPGA-00	Digital Pressure Gauge, 30" Hg VAC	
IA426	DPGA-06	Digital Pressure Gauge, 30 PSI	
IA378	DPGA-08	Digital Pressure Gauge, 100 PSI	
IA427	DPGA-10	Digital Pressure Gauge, 300 PSI	

DIGITAL PRESSURE GAUGES

- High ±0.25% full scale accuracy
- 4-digit digital display eliminates parallax errors
- Battery powered with auto-shut off
- 2000-hour battery life
- 4-button key pad allows easy access to features
- Peak and valley function
- Tare or auto zero
- Selectable engineering units
- Display backlight
- Liquids and non-combustible compatible gases
- Wetted materials constructed of 316SS
- 1/4" male NPT process connection
- CE, FM approved to be intrinsically safe for Class I, Div. I, Groups A, B, C and D, for ranges up to 3000 PSI



THZ291



Model No.	Mfg. No.	Description	Price/Each
THZ291	DPG-102	Digital Pressure Gauge, 15 PSI	
THZ292	DPG-103	Digital Pressure Gauge, 30 PSI	
THZ293	DPG-104	Digital Pressure Gauge, 50 PSI	
THZ294	DPG-105	Digital Pressure Gauge, 100 PSI	
THZ295	DPG-106	Digital Pressure Gauge, 200 PSI	
THZ296	DPG-107	Digital Pressure Gauge, 300 PSI	
THZ297	DPG-108	Digital Pressure Gauge, 500 PSI	
THZ298	DPG-109	Digital Pressure Gauge, 1000 PSI	
THZ299	DPG-110	Digital Pressure Gauge, 3000 PSI	
THZ300	DPG-111	Digital Pressure Gauge, 5000 PSI	

ZENITH
Safety Products

Safety Products for Industry

AIR/LIQUID FLOW METERS & SWITCHES

IN-LINE FLOW METERS

- Polysulfone meter body and adapters, stainless steel float guide, Viton O-ring seals, and floats of #316 stainless steel, PVC or Teflon®/Noryl (depending on calibration)
- Both flowmeters may be ordered with brass sweat or brass threaded adapters
- Both units are also available Specially Equipped with Hastelloy C float guides and floats of either Hastelloy C, Teflon® or PVC (depending on calibration)

BLUE-WHITE
INDUSTRIES

Model No.	Mfg. No.	Adapter Size	Range GPM	Range LPM	Float Material	Price /Each
HN181	F-44250LH-8	1/2" MPT	0.025-0.250	0.1-1.0	PVC	
HN182	F-44375LH-8	1/2" MPT	0.1-1.0	0.4-4.0	316SS	
HN183	F-44376LH-8	1/2" MPT	0.2-2.0	0.75-7.5	316SS	
HN184	F-44500LH-8	1/2" MPT	0.5-5.0	1.8-18	316SS	
HN185	F-44750LH-12	3/4" MPT	1.0-10	5.0-37.5	316SS	
HN186	F-45375LHN-6	3/8" MPT	0.1-1.0	0.4-4.0	Noryl/Teflon®	
HN187	F-45375LHN-8	1/2" MPT	0.1-1.0	0.4-4.0	Noryl/Teflon®	
HN188	F-45736LHN-6	3/8" MPT	0.2-2.0	0.75-7.5	316SS	
HN189	F-45736LHN-8	1/2" MPT	0.2-2.0	0.75-7.5	316SS	
HN190	F-45500LHN-6	3/8" MPT	0.5-5.0	1.8-18	316SS	
HN191	F-45500LHN-8	1/2" MPT	0.5-5.0	1.8-18	316SS	
HN192	F-45500LHN-12	3/4" MPT	0.5-5.0	1.8-18	316SS	
HN193	F-45750LHN-12	3/4" MPT	1.0-10	0.4-4.0	316SS	

HN181



IN-LINE FLOW METERS

- Cut and precision machined from solid, clear acrylic plastic bodies that permit complete visual inspection. Tapered bore is precision machined to a smooth surface that also provides perfect visibility of the indicating float
- VFA and VFB models are available with either brass or stainless steel inlet and outlet connections and are tapped for 1/8" NPT thread
- VFC models are provided with PVC connections tapped for 1" NPT thread
- All models have Buna-N O-ring seals for leak proof connections for maximum installation versatility
- All VFA and VFB models are supplied with a standard brass metering valve, stainless steel valves are available upon request
- VFC models, intended for use with external metering valves, are equipped with a large diameter stainless steel guide rod and a specially designed stainless steel float to provide excellent float stability at the high flow ranges
- 100 PSI maximum pressure rating
- VFA and VFB models have a maximum temperature rating of 150°F
- VFC models have a maximum temperature rating of 120°F

HL138



IN-LINE FLOW METERS

- Equipped with half union adapter connections which greatly facilitate both installation and maintenance
- One-piece meter body of heat and chemical resistant polysulfone
- Precision textured light admitting surface on the rear of the meter body diffuses ambient light and creates a softly illuminated background which enhances meter readability
- Stainless steel float guide and float, 1" FPT polysulfone adapters, and Viton O-ring seals

BLUE-WHITE
INDUSTRIES

Model No.	Mfg. No.	Adapter Size	Range GPM	Range LPM	Float Material	Price /Each
HN194	F-451006LHN	1" FPT	0.5-6.0	-	Teflon®	
HN195	F-451001LHN	1" FPT	0.1-10	3.0-38	316SS	
HN196	F-451002LHN	1" FPT	2.0-20	7.5-75	316SS	
HN197	F-451003LHN	1" FPT	3.0-30	12-115	316SS	
HN198	F-451004LHN	1" FPT	4.0-40	15-155	316SS	
HN199	F-451002GHN	1" FPT	8-80 SCFM	-	316SS	
HN200	F-451006LHKN	1" FPT	0.5-6.0	-	Teflon®	
HN201	F-451001LHKN	1" FPT	1.0-10	3.0-38	Hastelloy	
HN202	F-451002LHKN	1" FPT	2.0-20	7.5-75	Hastelloy	
HN203	F-451003LHKN	1" FPT	3.0-30	12-115	Hastelloy	
HN204	F-451004LHKN	1" FPT	4.0-40	15-155	Hastelloy	

HN199



Model No.	Mfg. No.	Range	Price /Each
-----------	----------	-------	-------------

MODEL VFA - 2" SCALE

HL138	VFA-1-BV	0.1-1 scfh Air	
HL150	VFA-2-BV	0.2-2 scfh Air	
HL246	VFA-3-BV	0.6-3 scfh Air	
HL294	VFA-4-BV	1-10 scfh Air	
HL354	VFA-5-BV	2-20 scfh Air	
HL366	VFA-6-BV	4-30 scfh Air	
HL378	VFA-7-BV	5-50 scfh Air	
HL390	VFA-8-BV	10-100 scfh Air	
HL402	VFA-9-BV	20-200 scfh Air	
HL162	VFA-21-BV	0.06-0.5 lpm Air	
HL174	VFA-22-BV	0.15-1 lpm Air	
HL186	VFA-23-BV	0.6-5 lpm Air	
HL198	VFA-24-BV	1-10 lpm Air	
HL210	VFA-25-BV	3-25 lpm Air	
HL222	VFA-26-BV	6-50 lpm Air	
HL234	VFA-27-BV	10-100 lpm Air	
HL258	VFA-32-BV	6-50 cc/min H ₂ O	
HL270	VFA-33-BV	10-100 cc/min H ₂ O	
HL282	VFA-34-BV	20-200 cc/min H ₂ O	
HL306	VFA-41-BV	0.6-5 gph H ₂ O	
HL318	VFA-42-BV	2-10 gph H ₂ O	
HL330	VFA-43-BV	3-20 gph H ₂ O	
HL342	VFA-44-BV	8-40 gph H ₂ O	

MODEL VFC - 2" SCALE (NO VALVE)

HL679	VFC-121	2.5-25 scfm Air	
HL681	VFC-122	5-50 scfm Air	
HL683	VFC-123	10-100 scfm Air	
HL685	VFC-131	60-700 lpm Air	
HL687	VFC-132	200-1400 lpm Air	
HL689	VFC-133	300-2800 lpm Air	

Model No.	Mfg. No.	Range	Price /Each
-----------	----------	-------	-------------

MODEL VFB - 4" SCALE

HL415	VFB-50-BV	0.3-3 scfh Air	
HL668	VFB-91-BV	1-10 scfh Air	
HL427	VFB-51-BV	2-20 scfh Air	
HL439	VFB-52-BV	4-40 scfh Air	
HL451	VFB-53-BV	10-100 scfh Air	
HL463	VFB-54-BV	15-150 scfh Air	
HL475	VFB-55-BV	20-200 scfh Air	
HL656	VFB-90-BV	0.3-3 scfm Air	
HL487	VFB-60-BV	100-1000 cc/min Air	
HL499	VFB-65-BV	0.2-4 lpm Air	
HL511	VFB-66-BV	1-10 lpm Air	
HL523	VFB-67-BV	2-20 lpm Air	
HL535	VFB-68-BV	3-30 lpm Air	
HL547	VFB-69-BV	4-40 lpm Air	
HL583	VFB-82-BV	2-30 cc/min H ₂ O	
HL559	VFB-80-BV	0.5-12 gph H ₂ O	
HL595	VFB-83-BV	1-20 gph H ₂ O	
HL571	VFB-81-BV	6-60 gph H ₂ O	

MODEL VFC - 5" SCALE (NO VALVE)

HL691	VFC-141	0.5-5 gpm H ₂ O	
HL693	VFC-142	1-10 gpm H ₂ O	
HL695	VFC-143	2-20 gpm H ₂ O	
HL699	VFC-152	4-40 lpm H ₂ O	
HL701	VFC-153	10-75 lpm H ₂ O	



aurora tools
Tools for industry...
made to last.

IN-LINE FLOW METERS

- Features a unique variable-area metering design, with a spring-retained moveable piston
- Can be installed quickly in any position form vertical to horizontal, without costly flow straighteners or other special plumbing requirements
- Constructed of polysulfone and stainless steel for greater tolerance to pressure and temperature as well as chemical compatibility
- Calibrated in gpm and lpm
- 1" NPT threaded port



Model No.	Mfg. No.	Flow Range	Medium	Price/Each
HC969	621-004	0.5 - 4 gpm	Water	
HC970	621-010	1 - 10 gpm	Water	
HC971	621-016	1 - 16 gpm	Water	
HC972	621-028	4 - 28 gpm	Water	
HC973	621-104	0.5 - 4 gpm	Oil	
HC974	621-110	1 - 10 gpm	Oil	
HC975	621-116	1 - 16 gpm	Oil	
HC976	621-128	4 - 28 gpm	Oil	

HC974



FLOW TOTALISERS

- All meters are self-contained and carry the FM Approval Class I, Division 1 for all group environments
- Aluminum housings are rated to 300 PSIG and are well suited for most petroleum products
- Nylon housings are rated to 150 PSIG and are used with non-aggressive chemicals and water
- All factory calibration is accurate to $\pm 1.5\%$ for non-viscous fluids
- 0.3 to 3 gpm and 3.0 to 50 gpm ranges use 1" NPTF
- 30 to 300 gpm range uses 2" NPTF



HM476



Model No.	Mfg. No.	Description	Price/Each
HM479	A109GMNO25NA1	Nylon Flow Meter, 0.3 to 3 gpm	
HM480	A109GMN100NA1	Nylon Flow Meter, 3 to 50 gpm	
HM476	A109GMA025NA1	Aluminum Flow Meter, 0.3 to 3 gpm	

CABLE FLOAT SWITCHES

- Control the level of liquids in filling or draining reservoirs and tanks
- Mercury-free switch is designed with an inverter microswitch housed in a polypropylene cover
- Unit includes a counterweight to adjust the stop and start levels of pump up/pump down application
- SPST switch, 10 A at 250 VAC resistive
- NEMA4 (IP68) enclosure rating
- Mounts vertically



THZ266



Model No.	Mfg. No.	Description	Price/Each
THZ266	CFS2-DNBPN-20	Cable Float Switch, 6 m (20') cable	
THZ265	CFS2-DNBPN-40	Cable Float Switch, 12 m (40') cable	

LEVEL SWITCHES

- Hermetically sealed reed switch contacts are actuated by magnets bonded inside the float
- Change from normally open (N.O.) to normally closed (N.C.) contacts in 10 seconds or less by reversing the orientation of the float on the stem
- Switch contact ratings are suitable for direct connection to most solid state control systems and alarm/monitoring devices
- Simple relay interfaces can be employed for higher current control applications
- Switch mounts easily at the top, bottom or intermediate levels in tanks and vessels
- Mounts directly in a 1/8" NPT fitting for interior mounting
- Where exterior mounting or access is required, special adapters are available as option
- To mount at intermediate levels, combine fittings shown with any length of pipe
- Vertical mounting is recommended (not to exceed 30° from vertical)
- Electrical Ratings:
Model **HF660** and **HF661**: AC - 25 VA, 1.0 A, 200 V; DC - 10W, 1.0 A, 200 V;
Model **HF659** and **HF658**: AC - 30W, 0.14 A, 220 V; DC - 0.28 A, 24 V, 0.07 A, 120 V

Model No.	Mfg. No.	Float Material	Stem Material	Max. Temp.	Max. Pressure	Min. Sp. Gr.	Deadband	Price /Each
HF660	F7-SB	Buna-N and epoxy	316SS	220 °F (105 °C)	150 PSIG (10 bar)	0.60	1/16" (2 mm)	
HF661	F7-SS2	316SS	316SS	300 °F (149 °C)	450 PSIG (31 bar)	0.75	1/16" (2 mm)	
HF659	F7-PP	Polypropylene and epoxy	Polypropylene	220 °F (105 °C)	100 PSIG (6.9 bar)	0.60	1/8" (4 mm)	
HF658	F7-BT	Buna-N and epoxy	Polybutylene Terephthalate	220 °F (105 °C)	150 PSIG (10 bar)	0.45	1/8" (4 mm)	



HF658

FLOW TOTALISERS

- Small, powerful microprocessor-based totalisers powered by "AAA" batteries
- Large 4-digit displays mount at the nozzle
- Suited for flow ranges from 3 to 30 gpm
- Accuracy is ± 5
- Nylon models, rated to 150 PSIG, are factory calibrated for water
- Aluminum models, rated to 300 PSIG, are factory calibrated for fuels
- All mount with 1" female NPT fittings



OC356



Model No.	Mfg. No.	Description	Price/Each
OC353	113255-4	Water Meter, gallons, NPT	
OC354	113255-5	Water Meter, liters, NPT	
OC355	113255-6	Water Meter, liters, ISO	
OC356	113255-1	Fuel Meter, gallons, NPT	
OC357	113255-2	Fuel Meter, liters, NPT	
OC358	113255-3	Fuel Meter, liters, ISO	

LEVEL SWITCHES

- Dual level switch designed for filling and draining tanks, wells, and reservoirs
- Shape and interior balance weight ensure impurities and dirt will not adhere to the surface, making it ideal for sewage and waste water applications
- Mercury-free switch is designed with an inverter microswitch housed in a polypropylene cover
- SPST switch, 10 A at 250 VAC resistive
- NEMA4 (IP68) enclosure rating
- Mounts vertically



THZ271



Model No.	Mfg. No.	Description	Price/Each
THZ271	FSW-6	Free-Floating Level Switch, 6 m (19.5') cable	
THZ269	FSW-15	Free-Floating Level Switch, 15 m (49') cable	



REFRACTOMETERS

BRIX REFRACTOMETERS

The Brix refractometer shows the concentration percentage of the soluble solids content (Total solids) of a sample (water solution). The soluble solids content is the total of all the solids dissolved in the water - beginning with sugar, salts, protein, acids, etc. and the measurement reading value is the value of the sum total of those. Essentially Brix% is calibrated to the number of grams of cane sugar contained in 100 g of cane sugar solution. So, when measuring a sugar solution, the Brix% should perfectly match the actual concentration.



HX107

REED

Model No.	Mfg. No.	BRIX Range	Min. Div.	Accuracy	Price/Each
HX107	R9500	0 - 32%	0.2%	±0.2%	

SALINITY REFRACTOMETERS

Salinity refractometers are useful for measuring the concentration of natural or artificial seawater in aquariums, holding tanks, and breeding ponds. They can also be used for controlling the salt water concentration when preparing pickles, measuring the concentration of salt water used in rinsing and cooking sea products.



HK668

REED

Model No.	Mfg. No.	Range	Min. Div.	Accuracy	Price/Each
HK668	R9600	0 - 28%	0.2%	±0.2%	

BATTERY COOLANT CHECKERS

It is essential to know the concentration and freezing point of anti-freeze coolants for vehicular safety. Keeping a suitable concentration of coolant prevents engine trouble and possible radiator corrosion. This tester monitors the freezing point of both ethylene glycol and propylene glycol; in addition, it indicates battery recharge level. This tester is simple to use; requiring only a few drops to provide accurate readings within seconds. It is virtually indispensable for gas stations, service shops, cab companies, etc.



HX093

REED

Model No.	Mfg. No.	Coolant	Range	Min. Div.	Price/Each
HX093	R9700	Propylene Glycol	-50 to 32 °F	10 °F	
		Ethylene Glycol	-50 to 32 °F	10 °F	

PH METER

- Dual displays of temperature and pH
- °F or °C temperature measurement
- Automatic temperature compensation assures that readings are corrected for temperature offsets
- One touch calibration for up to 3 points
- Calibration values are adjustable
- Includes batteries
- pH Range: 0.00 to 14.00 pH
- Temperature Range: 0 to 60.0°C
- Accredited calibration available



REED

Model No.	Mfg. No.	Description	Price/Each
IA693	8689	Digital pH Pen	
IA694	86P8	Replacement pH Electrode	
HX298	PH-04	4.0 pH Buffer Solution	
HX299	PH-07	7.0 pH Buffer Solution	

PH/ORP METERS

- Measures pH and ORP levels in water
- Manual or automatic temperature compensation
- Auto calibration for pH 4.0, pH 7.0 and pH 10.0
- Data hold and max./min. record
- Real time data logger with integral 4 GB SD memory card (optional)
- RS232 and USB interface
- pH Range: 0 to 14.00 pH
- ORP Range: -1999 to 1999 mV



IA801

REED

Model No.	Mfg. No.	Description	Price/Each
IA801	SD-230	pH/ORP Meters	
IB835	SD-4GB	Memory Card - 4 GB	

Model No.	Mfg. No.	Description	Range	Size	Price/Each
HX295	PE-01	Epoxy pH Electrode	0-14 pH	9.5 mm dia. x 130 mm	
HX296	PE-03	Epoxy pH Electrode	0-13 pH	12.3 mm dia. x 160 mm	
HX297	PE-11	Epoxy pH Electrode	0-13 pH	10.0 mm dia. x 130 mm	
HX293	ORP-14	ORP Electrode	0-13 pH	12.5 mm dia. x 130 mm	

CONDUCTIVITY METERS

- Measures conductivity, total dissolved solids (TDS) and salt levels in water
- Carbon rod electrode
- Auto temperature compensation
- Temperature coefficient of measurement solution is user selectable
- Data hold and Max/Min record
- Real time data logger with integral 4 GB SD memory card (optional)
- RS232 and USB interface
- Conductivity Range: 200 µS, 2 mS, 20 mS, 200 mS
- Soft Range: 0 to 12% salt (% weight)



IA802

REED

Model No.	Mfg. No.	Description	Price/Each
IA802	SD-4307	Conductivity Meter	
IB835	SD-4GB	Memory Card - 4 GB	

DIGITAL COUNTING SCALES

- Used for counting and quantity checking
- Primary counting function
- High accuracy load cell
- Large LCD display
- Rechargeable battery
- Full digital calibration
- Tare function
- Auto zero tracking
- Quantity set alarm (checking)
- Back light display
- Accumulation memory quantity
- 1-year warranty



HX133



NOT LEGAL FOR TRADE

Model No	Mfg. No.	Capacity lbs./kg	Graduation lbs./g	Counting Resolutions	Price /Each
HX133	KCS 301-30	66/30	0.002/1	1/30 000	
IA590	KCS 301-15	33/15	0.001/0.5	1/30 000	
IB732	KCS 301-3	6.6/3	0.0002/0.1	1/30 000	
IB733	KCS 301-6	13.2/6	0.0004/0.2	1/30 000	

ELECTRONIC DIGITAL WEIGHING SCALES

- Compact design 12 1/2" D x 11 3/4" W x 45/8" H (32 cm x 30 cm x 12 cm)
- Check-weighing function (HI/LO/Target) and a secondary counting function
- Four weighing modes (g, kg, lbs., oz.)
- Removable stainless steel platform 11 3/4" D x 8 3/4" W (30 cm x 22 cm)
- ABS enclosure
- Large LCD display with both front and rear indicators and level indicator for weighing accuracy
- Rechargeable battery with low battery indicator and AC adapter (included)



IA991



Model No.	Mfg. No.	Capacity kg/g/lbs./oz.	Graduation kg/g/lbs./oz.	Price /Each
NOT LEGAL FOR TRADE				
IA988	KWS-SW06	3/3000/6/96	0.001/1/0.002/0.05	
IA989	KWS-SW12	6/6000/12/192	0.002/2/0.005/0.1	
IA990	KWS-SW30	15/15 000/30/480	0.005/5/0.01/0.2	
IA991	KWS-SW60	30/30 000/60/960	0.01/10/0.02/0.5	
LEGAL FOR TRADE				
IA992	KWS-SW06	3/3000/6/96	0.001/1/0.002/0.05	
IA993	KWS-SW12	6/6000/12/192	0.002/2/0.005/0.1	
IA994	KWS-SW30	15/15 000/30/480	0.005/5/0.01/0.2	
IA995	KWS-SW60	30/30 000/60/960	0.01/10/0.02/0.5	

PORTION CONTROL SCALE

- Auto off (after 120 seconds of inactivity)
- Full tare capacity
- Bright-blue backlit LCD display
- Low battery and overload indications
- Stainless steel platform
- Transparent cover protects the scale when not in use
- 7 Weighing modes: kg, lbs., g, oz., lb-oz, lb-1/4oz, 1/4oz
- Power supply: 4 x AA rechargeable batteries and power adapter included
- Capacity: 33 lbs./15 kg
- Graduations: 2 g
- Platform Dimensions: 7" L x 7" W

Model No. IB735
Mfg. No. 601SC
Price/Each \$



NOT LEGAL FOR TRADE

BIOS
Professional

WEIGHING SCALES

- Ideal for high humidity and dusty work environment
- Large stainless steel platform is removable for easy cleaning
- Convenient displays on front and rear of the scale allow use from both sides of the worktable
- Meets IP66 (dust tight and protected against a strong water jet) standards

FEATURES:

- Large LCD type display with backlight
- ABS enclosure
- Water and dust resistant
- Secondary counting function
- Four direct keys: Zero, tare, units/counting, on/off
- Four weight modes: g, kg, oz., lb.
- Operates on A/C power or rechargeable battery(both included)
- Dimensions: 9" W x 9.5" D x 5.75" H



PE129



Model No	Mfg. No.	Capacity lbs./kg	Graduation lbs./kg	Price /Each
NOT LEGAL FOR TRADE				
PE126	KWD 500-5	5/2.5	0.002/0.001	
PE127	KWD 500-10	10/5	0.005/0.002	
PE128	KWD 500-20	20/10	0.01/0.005	
PE129	KWD 500-50	50/20	0.02/0.01	
LEGAL FOR TRADE				
IA591	KWD 500-5	5/2.5	0.002/0.001	
IA592	KWD 500-10	10/5	0.005/0.002	
IA593	KWD 500-20	20/10	0.01/0.005	
IA594	KWD 500-50	50/20	0.002/0.01	

RANGER® COUNT 3000 COMPACT BENCH COUNTING SCALES

A high-precision dedicated counting scale with advanced software for counting and packaging parts.

- Weighing Functions: lbs, oz, lbs:oz, kg or g
- Application Modes: Weighing, Parts Counting, Checkweighing, Checkcounting, Accumulation
- Display: 3-Window, 1 in./26 mm high LCD display with white backlight, 6-digit, 7-segment
- Checkweighing Indicators: 3 LED (yellow, green, red) with configurable operation and alert beeper
- Memory: 30 item library data storage function
- Zero Range: 2% or 10% of full scale capacity
- Tare Range: Full capacity by subtraction
- Stabilization: one second results, with 1 part in 1.5 million precision
- Power: 100-240 VAC/50-60 Hz internal universal power supply, internal rechargeable lead acid battery
- Interface Built-in RS232, optional 2nd platform, 2nd RS232, USB, Ethernet
- Platform Size: 11.8" W x 8.9" D

IA998



NOT LEGAL FOR TRADE

Model No.	Mfg. No.	Capacity kg/g/lbs./oz.	Graduation kg/g/lbs./oz.	Price /Each
IA998	RC1P1502	1.5/1500/3/48	0.00005/0.05/0.0001/0.002	
IA999	RC31P3	3/3000/6/96	0.0001/0.1/0.0002/0.005	
IB001	RC31P6	6/6000/15/240	0.0002/0.2/0.0005/0.01	
IB002	RC31P15	15/15 000/30/480	0.0005/0.5/0.001/0.02	
IB003	RC31P30	30/30 000/60/960	0.001/1/0.002/0.05	

SCALES

PORTABLE ELECTRONIC BALANCES

- Scout SPX is a portable balance designed to meet the most common weighing equipments
- Features a large LCD display
- Removable stainless steel pan
- Weight display in g, kg, oz., lbs., lb.oz.; and Troy ounce or pennyweight units for weighing precious materials
- Powered by four AA batteries (not included) or included AC adapter pack
- Dimensions: 6.0" W x 6.3" D x 2.2" H
- Weight: 1.8 lbs.
- 2-year warranty on parts and labour



HM315

MULTIPLE WEIGHING MODES:

- Parts counting
- % weighing
- Display hold for shipping applications



HX216

NOT LEGAL FOR TRADE

Model No.	Mfg. No.	Capacity	Graduation	Pan Size"	Price /Each
HX216*	SPX222	220 g	0.01 g	4.7 diameter	
HX217*	SPX422	420 g	0.01 g	4.7 diameter	
IA550*	SPX622	620 g	0.01 g	4.7 diameter	
HX218*	SPX421	420 g	0.1 g	4.7 diameter	
HM315*	SPX621	620 g	0.1 g	5.5 x 6.7	
IA551	SPX2201	2200 g	0.1 g	5.5 x 6.7	
IA553	SPX6201	6200 g	0.1 g	5.5 x 6.7	
IA554	SPX8200	8200 g	1 g	5.5 x 6.7	

* Span calibration mass included

LOW PROFILE BENCH SCALES

The ES Series design makes this low profile scale perfect for shipping, receiving and general bench applications. Easy 2-button operation and large display guarantees accurate and unmistakable results. The 3-way mounting bracket (included) allows you to mount the indicator to front of scale base, above the base, or to any vertical surface.

- Display weight in kg, lbs., oz. or combined lb.oz.
- Stainless steel weighing platform and epoxy painted steel frame
- AC or battery powered operation
- Includes: 3-way mounting bracket and AC adapter
- 1-year warranty on parts and labour

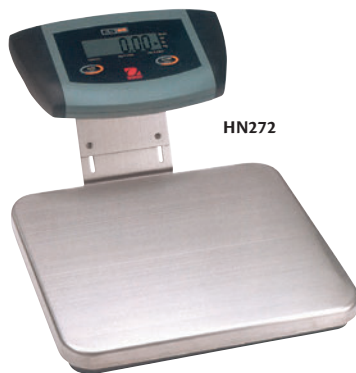

HN272



NOT LEGAL FOR TRADE

Model No.	Mfg. No.	Capacity lbs./kg/oz.	Readability lbs./g/oz.	Platform Dimensions L" x W" x H"	Price /Each
HN272	ES30R	66/30/1056	0.05/10/0.5	12.2 x 10.8 x 1.5	
HN273	ES50R	110/50/1760	0.05/20/1	12.2 x 10.8 x 1.5	
HN274	ES50L	110/50/1760	0.05/20/1	20.5 x 15.7 x 3	
HN275	ES100L	250/100/3520	0.1/50/2	20.5 x 15.7 x 3	
HN276*	ES200L	440/200/7040	0.2/100/5	20.5 x 15.7 x 3	

* lb.oz. display not available on model HN276

PORTION CONTROL SCALES

- Large LCD display - 5/8" high
- Removable stainless steel platform
- Tare weighing function
- 800-hours of battery life
- 2-mode function metric and imperial
- AC adaptor (included) or four AA batteries (not included)



TANITA

NOT LEGAL FOR TRADE

Model No.	Mfg. No.	Capacity	Graduation	Price/Each
HX081	KD-200-110	35 oz./1000 g	0.05 oz./1 g	
HX082	KD-200-210	70 oz./2000 g	0.1 oz./2 g	
IA557	KD-200-510	11 lbs./5000 g	0.2 oz./5 g	

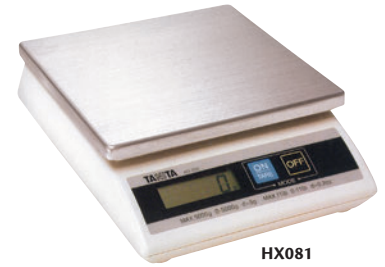

HX081

PORTION CONTROL SCALE

- Stainless steel easy wipe top
- Quick response
- Overload indicator
- 0.1 oz. increments
- Tare
- Auto power off
- Certification: CE and NSF approved
- Powered by 2 x AAA batteries
- Display: LCD 2.17" x 0.83"
- Accuracy: +/- 0.5%
- Capacity: 5000 g/9 lbs.
- Graduations: 1 g/0.1 oz.
- Platform dimensions: 8 1/4" L x 5 7/8" W

Model No. IB734
Mfg. No. 600SC
Price/Each \$



NOT LEGAL FOR TRADE

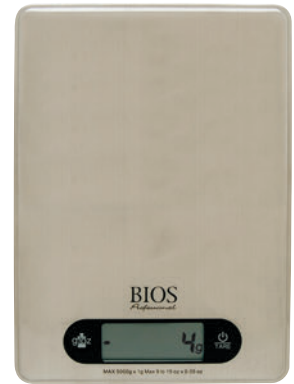

COMPACT ELECTRONIC SCALES

- Displays results in g or combined lb.oz.
- One-button operation
- Full capacity tare
- LCD display
- Operates on three AAA batteries (included) or with an optional AC adapter
- Dimensions: 5.3" W x 7.6" D x 1.5" H
- 1-year warranty on parts and labour
- Weight: 1 lb.



HN218



NOT LEGAL FOR TRADE

Model No.	Mfg. No.	Capacity	Graduation	Price/Each
HN218	CS200	0 lb:7.05 oz./200 g	0.01 oz./0.1 g	
HN219	CS2000	4 lb:6.55 oz./2000 g	0.05 oz./1.0 g	
HN220	CS5000	11 lb:0.4 oz./5000 g	0.1 oz./2.0 g	
IB538	46001724	Optional AC Power Adapter		

ECONOMY PRECISION SCALES

- Maximum efficiency at minimal cost
- Top loading scales have a removable stainless steel platter making them easy to keep clean
- Speed and precision at a low price
- Ideal for small lab and educational environments

FEATURES:

- External calibration, brushed stainless steel platter and adapter
- Weights in g, oz., lbs., dwt, oz. t., cnt
- Counting features
- Operating temperature: 10°C to 35°C
- Dimensions: 7" W x 9 3/4" D x 2 1/2" H
- 1-year warranty



PE130



PE131



NOT LEGAL FOR TRADE

Model No.	Mfg. No.	Capacity	Graduation	Platter Dimension	Price/Each
PE130	KLE-200	200 g	0.1 g	4.6" diameter	
PE131	KLE-2000	2000 g	1 g	5" x 6.5"	

PRECISION SCALES

- Fast microprocessing speed and digital filtration are the key to peak performance and stability
- Single direction RS-232 allows you to connect to peripheral devices
- Leveling bubble is included and all four feet are adjustable
- Features external calibration
- Brushed stainless steel platter and adapter
- Weights in g, oz., lbs., dwt, oz. t., cnt and KHA 0.01 g also weights in CT
- Counting features
- Operating temperature: 10°C to 35°C
- 1-year warranty

PE136



PE137



NOT LEGAL FOR TRADE

Model No.	Mfg. No.	Capacity	Graduation	Platter Dimensions W" x D"	Price /Each
IA780	KHA-230R	200 g	0.001 g	4.75 x 4.75	
PE136	KHA-1000R	1000 g	0.01 g	4.75 x 4.75	
PE137	KHA-1201R	1200 g	0.1 g	6.94 x 6.94	
IA781	KHA-5001R	5000 g	0.1 g	6.94 x 6.94	

PESOLA® MICRO SPRING SCALES

- Rotatable bow allows for ideal position of scale reading
- Screw for tare and for adjusting the zero position (range of tare = 20%)
- Innovative adjustment and suspension of spring
- Precise graduation, high resolution, abrasion-resistant and anodized colour
- Eye-clip with lower suspension rotates by 360°
- Eye-clip allows easy interchange of lower suspension with other accessories
- Vertical measuring position



Model No.	Mfg. No.	Capacity	Graduation	Price /Each
IB694	20010	10 g	0.1 g	
IB695	20030	30 g	0.25 g	
IB696	20060	60 g	0.5 g	
IB697	20100	100 g	1.0 g	

PESOLA® MEDIO SPRING SCALES

- Rotatable bow allows for ideal position of scale reading
- Screw for tare and for adjusting the zero position (range of tare = 20%)
- Innovative adjustment and suspension of spring
- Precise graduation, high resolution, abrasion-resistant and anodized colour
- Integrated recoil absorption (important for tensile tests with drag pointer 4.012 (IB721))
- Clear marker reading line on level of graduation
- Eye-clip allows easy interchange of lower suspension with other accessories



Model No.	Mfg. No.	Capacity	Graduation	Price /Each
IB698	40300	300 g	2 g	
IB699	40600	600 g	5 g	
IB700	41000	1000 g	10 g	
IB701	41002	1000 g	10 g	
IB702*	42500/A	2500 g	20 g	
IB703*	43000	3000 g	30 g	

* Supplied with J hook

PESOLA® MACRO SPRING SCALES

- Rotatable bow allows for ideal position of scale reading
- Screw for tare and for adjusting the zero position (range of tare = 20%)
- Innovative adjustment and suspension of spring
- Precise graduation, high resolution, abrasion-resistant and anodized colour
- Integrated recoil absorption for tensile tests with drag pointer (drag pointer supplied)
- Clear marker reading line on level of graduation
- Swivel hook, rotatable and replaceable by different accessories



Model No.	Mfg. No.	Capacity	Graduation	Price /Each
IB705	80005	5 kg	50 g	
IB707	80015	10 lbs./5 kg	50 g/2 oz.	
IB706	80010	10 kg	100 g	
IB712	80210	20 lbs./10 kg	100 g/4 oz.	
IB708	80020	20 kg	200 g	
IB713	80420	40 lbs./20 kg	200 g/8 oz.	
IB709	80035	35 kg	500 g	
IB710	80050	50 kg	500 g	
IB711	80150	100 lbs./50 kg	500 g/1 lbs.	

SCALES

TOP LOADING SCALES

- Brushed stainless steel body and stainless platform
- Portable rugged and reliable
- Bold large numbers for easy readability
- Rotating dial
- Tare function

BIOS
Professional



Model No.	Mfg. No.	Capacity	Graduation	Platform Dim. L" x W"	Price /Each
NOT LEGAL FOR TRADE					
IB736	620SC	2.2 lbs./1 kg	5 g/0.25 oz.	6 x 6	
IB737	621SC	5 lbs./2.2 kg	5 g/0.5 oz.	6 x 6	
IB738	622SC	25 lbs./12 kg	50 g/0.125 lbs.	8 x 8	

TOP LOADING SCALES

- Large stainless steel and enamel platforms to accommodate a variety of package sizes
- Bold graphics improves reading accuracy and ease
- Portable, rugged and reliable



KILOTECH
www.kilotech.com

Model No.	Mfg. No.	Capacity	Case Finish	Platform Dim. W" x D"	Price /Each
PE446	KAM1101PL	11 lbs./5 kg	Enamel	7 1/2 x 7 1/2	
PE447	KAM2501SPL	26 lbs./12 kg	S. Steel	7 1/2 x 7 1/2	
PE449	KAM5002PL	50 lbs./22 kg	Enamel	10 3/4 x 9 1/2	

DIGITAL LUGGAGE SCALE

- Blue back light LCD display
- Compact modern design
- Nylon strap
- Dual display (lbs. and kg at the same time)
- Auto-calibration
- Auto zero & auto off
- Hold function - Screen turns red when finished weighing
- Long life lithium batteries included
- Capacity: 110 lbs./50 kg
- Graduations: 0.5 lbs.

Model No. IB739
Mfg. No. SC419
Price/Each \$

BIOS
Professional



BRIEFCASE/UTILITY MECHANICAL RECEIVING SCALES

This general purpose, portable weighing scale can be used in shipping and receiving areas. The large dual dial is easy to read from either the top or side position. The memory lock lever will hold the reading when dial is obscured by an oversized package.

Rubbermaid
Commercial Products



Model No.	Mfg. No.	Capacity	Graduation	Dimensions L" x W" x H"	Price /Each
HL933	FPG250S	250 lbs.	1 lb.	13 1/4 x 10 1/2 x 3 7/8	

RECEIVING SCALES

These scales are heavy-duty, general purpose and are suitable for light industrial or shipping applications.

FEATURES:

- Kg/lbs. modes
- Programmable Auto-Off function
- Removable stainless steel platform (HX632, HX633, IA558, IA782, and IA783)
- Fixed mild steel checkered platform (IA564 and IA453)
- 4 1/2" x 1 1/2" LCD display (HX632, HX633 and IA558)
- 3" x 1 1/4" LCD display (IA564 and IA453)
- Platform size: 11.75" x 12.25" (HX632, HX633, IA558, IA564 and IA453)
- 14" x 16" (IA782 and IA783)
- Zero, tare and kg/lbs. (toggle) keys
- Heavy-duty 8' coiled cord
- Power supply: Six AA alkaline batteries (not included) or 120 V AC adapter (included)
- 1-year warranty

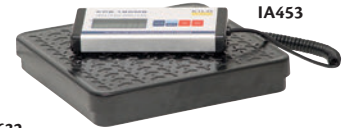

KILOTECH
www.kilotech.com

NOT LEGAL FOR TRADE

Model No.	Mfg. No.	Capacity	Graduation	Price/Each
HX632	KPS-50-2	110 lbs./50 kg	0.05 lbs./20 g	
HX633	KPS-100-2	220 lbs./100 kg	0.1 lbs./50 g	
IA558	KPS-150-2	330 lbs./150 kg	0.2 lbs./100 g	
IA564	KPS-68MS	150 lbs./68 kg	0.2 lbs./100 g	
IA782	KPS-60SS	130 lbs./60 kg	0.05 lbs./20 g	
IA783	KPS-150SS	330 lbs./150 kg	0.1 lbs./50 g	
IA453	KPS-180MS	400 lbs./180 kg	0.5 lbs./200 g	

INTEGRATOR C15 PRICE COMPUTING SCALE

- Price computing simplified- Easy to use, easy to learn, and easy to program
- Visible in all lighting conditions
- Portable -No need to plug in the scale, 12 hour rechargeable battery included
- Multi-interval device-Two scales in one- Finer precision or larger capacity as per your requirements
- 265 PLU- memorizes item name, item code, life, ingredients, Tare & unit price
- Large stainless steel platter
- Dual reading displays (front and rear)
- Printer available as an option
- Platform Dimensions: 8-9/10" L x 13-1/5" W



Model No.	Mfg. No.	Capacity	Graduation	Price/Each
NOT LEGAL FOR TRADE				
IB772	851509	30 lbs./15kg	0.005 lbs./0.002 kg	
IB774	851510	60 lbs./30kg	0.02 lbs./0.005 kg	
LEGAL FOR TRADE				
IB773	881509	30 lbs./15kg	0.005 lbs./0.002 kg	
IB775	881510	60 lbs./30kg	0.02 lbs./0.005 kg	

ARGOX THERMAL LABEL PRINTER

- Thermal barcode printer
- Built in tear off bar
- Label separator
- Works with labels (IB783) 58 x 40 mm, (IB784) 58 x 60 mm

Model No. IB782
Mfg. No. 835501
Price/Each \$

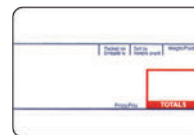

IB783



KILOTECH
www.kilotech.com

KILOTECH LABELS

Model No.	Mfg. No.	Label Size	Labels /Roll	Rolls /Case	Price /Case
IB783	862049	58 mm x 40 mm	700	30	
IB784	862050	58 mm x 60 mm	500	30	

DEFENDER™ 3000 PLATFORM SCALES

- Ideal for general weighing and simple counting applications in production, packaging, warehouse, inventory, shipping and receiving areas
- Ideal for bench and floor scale applications
- Indicator features a high-impact durable ABS housing with reversible rear cover for either wall, column or table-top mounting
- Large, backlit LCD display quickly displays results in a choice of multiple weighing units (lb., oz, combined lb:oz, kg or g)
- Parts counting mode with a minimum average piece weight of 1d, selectable sample sizes, and automatic retention of last sample size used and average piece weight data
- Built-in bidirectional RS232C for printing or connection to PC
- Includes an AC adapter and an internal rechargeable lead acid battery that lasts 100-hours between recharges
- Platform dimensions: 19.7" x 25.6"/500 mm x 650 mm



NOT LEGAL FOR TRADE

Model No.	Mfg. No.	Capacity	Graduation	Price /Each
IA555	D31P150BX	300 lbs./150 kg	0.05 lbs./0.02 kg	
IA556	D31P300BX	600 lbs./300 kg	0.1 lbs./0.05 kg	

CYCLONE BENCH AND PLATFORM SCALE

- Durable thick stainless steel platter allows for heavy loads without bending
- 2 scales in one - Dual range- always the right sensitivity no matter how light or heavy the load
- Back support - Ideal for weighing products in bags or that which require extra support.
- Post mounted indicator - Makes it easy to see the screen
- Three weighing modes: lb., kg, pcs
- Ideal for shipping, receiving, check weighing or counting
- Battery or adapter operated



NOT LEGAL FOR TRADE

Model No.	Capacity Range 1	Graduation Range 1	Capacity Range 2	Graduation Range 2	Price /Each
15-3/4" L X 19-7/10" W					
IB770	0-60 kg/0-150 lbs.	20 g/0.05 lbs.	60-150 kg/150-300 lbs.	50 g/0.1 lbs.	
17-3/4" L X 23-3/5" W					
IB771	0-150 kg/0-300 lbs.	50 g/0.1 lbs.	150-300 kg/300-600 lbs.	100 g/0.2 lbs.	

DEFENDER™ 7000 SQUARE BENCH SCALES

- ABS plastic indicator with square painted steel base
- Advanced parts counting, dynamic animal weighing, percent weighing, display hold for large containers, check weighing, accumulation, lb., oz, lb:oz, g, kg, user-defined custom unit
- Full alphanumeric keypad, dual-line backlit LCD display and check weighing LEDs
- Includes second scale analog input for dual base operation
- Pressed square steel welded base design for rugged durability with painted column
- Includes: RS232 interface with GMP/GLP data output including date and time, and external analog base input
- Internal poser supply with universal line cord or six C batteries (80-hour battery life)



NOT LEGAL FOR TRADE

Model No.	Mfg. No.	Capacity	Graduation	Platform Dimensions L" x W" x H"	Price /Each
IA640	D71P10QR1	25 lbs./10 kg	0.002 lbs./0.001 kg	12 x 12 x 3.8	
IA641	D71P25QR1	50 lbs./25 kg	0.005 lbs./0.002 kg	12 x 12 x 3.8	
IA642	D71P50QL2	100 lbs./50 kg	0.01 lbs./0.005 kg	12 x 12 x 3.8	
IA643	D71P100QL2	250 lbs./100 kg	0.02 lbs./0.01 kg	12 x 12 x 3.8	
IA644	D71P250QX2	500 lbs./250 kg	0.05 lbs./0.02 kg	24 x 24 x 5	

TOP GUN ELECTRONIC PLATFORM SCALES

- For use in dry environments and areas with low humidity
- Counting function (secondary)
- Hi/Target/Lo (check weighing)
- Accumulation function
- Removable stainless steel platter (1.2 mm gauge) 12" W x 18" D (30.5 x 45.7 cm)
- Built-in level
- Adjustable lockable anti-slip leveling feet
- Predefined capacity settings eliminate installation errors
- Mobile installation
- Choice of ABS or stainless steel indicators



Model No.	Mfg. No.	Indicator*	Frame**	Capacity	Graduation	Price/Each
NOT LEGAL FOR TRADE						
IB011	KPLMS 1218-60	KIN 1000 (ABS)	MS	60 kg/150 lbs.	0.02 kg/0.05 lbs	
IB012	KPLMS 1218-60	KIN 2000 (WR)	MS	60 kg/150 lbs.	0.02 kg/0.05 lbs	
IB013	KPLMS 1218-150	KIN 1000 (ABS)	MS	150 kg/300 lbs.	0.05 kg/0.1 lbs	
IB014	KPLMS 1218-150	KIN 2000 (WR)	MS	150 kg/300 lbs.	0.05 kg/0.1 lbs	
LEGAL FOR TRADE						
IB015	KPLMS 1218-60	KIN 1000 (ABS)	MS	60 kg/150 lbs.	0.02 kg/0.05 lbs	
IB016	KPLMS 1218-60	KIN 2000 (WR)	MS	60 kg/150 lbs.	0.02 kg/0.05 lbs	
IB017	KPLMS 1218-150	KIN 1000 (ABS)	MS	150 kg/300 lbs.	0.05 kg/0.1 lbs	
IB018	KPLMS 1218-150	KIN 2000 (WR)	MS	150 kg/300 lbs.	0.05 kg/0.1 lbs	

*Indicator
ABS = ABS Plastic
WR = Stainless Steel
** Frame
MS = Mild Steel

SCALES

INDUSTRIAL HANGING SCALES

- Cast aluminum scratch resistant body
- Clear shatter resistant face plate
- 7 1/2" Dia., kg and lbs. dial
- Heavy-duty welded steel shackle ring
- Large pointed J-hook
- 1-year warranty



IA545

KILOTECH
www.kilotech.com

NOT LEGAL FOR TRADE

Model No.	Mfg. No.	Capacity	Graduation	Price/Each
IA543	KHS-C360	125 lbs./60 kg	0.5 lbs./200 g	
IA544	KHS-C3120	250 lbs./120 kg	1 lbs./500 g	
IA545	KHS-C3250	540 lbs./250 kg	2 lbs./1000 g	

MINI DIGITAL CRANE SCALES

Ideal for light industry, hunters, luggage, parcels etc.

This mini digital crane scale is versatile, reliable, accurate and easy to operate. A quality stainless steel load receptor and cast aluminum housing protect the scale. The combination of circuit and dedicated weighing load cells ensure a stable reading.

- Stainless steel load receptor
- Cast aluminum housing
- LCD screen viewable from 22'
- Tare, Hold, Unit (between kg and lb.), Zero
- Programmable auto-off, auto-zero, manual zero, backlight
- Removable hook for easy cleaning
- For use in a dry environment and areas of low humidity
- 1-year warranty



IA787

KILOTECH
www.kilotech.com

NOT LEGAL FOR TRADE

Model No.	Mfg. No.	Capacity	Graduation	Price/Each
IA784	KHS 200-30	60 lbs./30 kg	0.02 lbs./0.01 kg	
IA785	KHS 200-60	120 lbs./60 kg	0.05 lbs./0.02 kg	
IA786	KHS 200-150	300 lbs./150kg	0.1 lbs./0.05 kg	
IA787	KHS 200-300	600 lbs./300 kg	0.2 lbs./0.1 kg	

VN SERIES ECONOMICAL FLOOR SCALES

The Ohaus VN Series of floor platforms and scales are the value solution to your dry weighing needs in industrial and commercial applications. Its high-quality construction is designed to minimize distortion under heavy loads, and ensures years of dependable performance. NTEP certification ensures consistent weighing results.

Standard features of the VN Series include:

- 5 mm/0.196" painted carbon steel weighing platform top plate with raised cross-hatch surface for added slip resistance
- Four NTEP-certified shear beam load cells protected to IP67
- Side-access NEMA 4X/IP65 dust and water protected stainless steel junction box with 16 1/2" indicator cable
- Carbon steel eyebolts attached to side of platform for easy lifting and positioning
- T31P indicator includes: Backlit LCD display with 1" high digits, lbs. and kg weighing units, counting mode for inventory applications, 16 1/2" indicator cable, wall bracket for easy mounting, 80-hour internal rechargeable battery and AC adapter

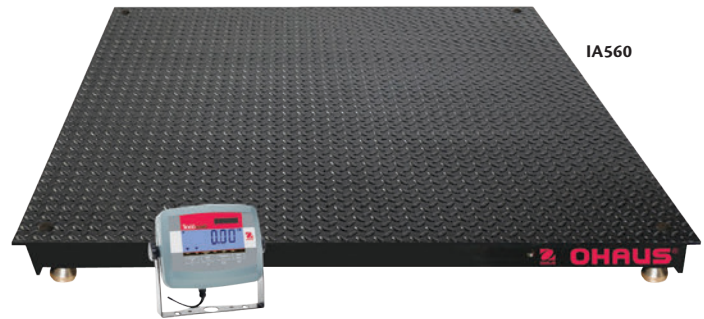

IA560

NOT LEGAL FOR TRADE

Model No.	Mfg. No.	Capacity	Graduation	Platform Size L" x W" x H"	Price /Each
IA560	VN31P5000L	5000 lbs./2500 kg	1 lbs./0.5 kg	48 x 48 x 3 1/2	
IA561	VN31P5000X	5000 lbs./2500 kg	1 lbs./0.5 kg	60 x 60 x 3 1/2	
IA562	80252565	-	Floor Ramp, 4 feet wide	-	
IA563	80252566	-	Floor Ramp, 5 feet wide	-	



KWS CY-300 PLATFORM SCALE

- No lifting required, roll your dolly directly onto the ramp
- Mobile Wheels and handle allow for effortless movement
- Rugged mild steel checkered platform
- Ideal for small barrels, drums, kegs, tanks, pails and cylinders (non-flammable and non explosive substances)
- Accurate, efficient and profitable - HI/LO/Target, parts counting, %, TARE & data comparison features
- 2 preprogrammed weighing modes kg/lb.
- 3 programmable modes: lbroz, PCS, %
- Tare, hold, print, zero tracking & digital calibration
- Auto-power off and backlight
- Programmable serial output
- Printing simplified - USB and RS232 interfaces
- Graduations: 0.2 lbs./0.1 kg
- Legal/Not Legal for Trade: Not Legal for Trade



KILOTECH
www.kilotech.com

Model No.	Mfg. No.	Capacity	Platform Dimensions	Price /Each
IB778	851315	660 lbs./300 kg	18" x 18"	

CUSTOMIZE . . .

- Strip Curtain Doors
- Platform Trucks
- Safety Guards
- Bollards
- Gas Cylinder Cabinets
- Workbenches
- Shelf Trucks
- And more...

Kleton builds quality and dependability into all of their products!

Look throughout the catalogue for the Kleton Custom Symbol indicating which products can be custom built to meet your specifications.



**Customize
KLETON products
to your specs!**



BUILT

KLETON 

TOUGH

**Call us with your
specs today!**