

Lloyd and Meredith



www.lloydandmeredith.com



Your Sprayer Headquarters

2025



202 Chestnut St.
Atlantic, IA 50022

712-243-5520



Lloyd and Meredith, Inc.

202 Chestnut Street • Atlantic, Iowa 50022

712-243-5520

Welcome to Lloyd and Meredith's 2025 Sprayer Catalog. Lloyd and Meredith is located in Atlantic, Iowa, where the business was founded 143 years ago. Lloyd and Meredith is a small company offering personalized, prompt service. We strive to ship orders same day.

Table of Contents

ACE Pump Parts	8, 9
ATV Sprayers	2
Boom Wheel.....	24
Calibration Pitcher	24
Centrifugal Pumps	
ACE • PTO Driven.....	6
ACE Hydraulic/Hypro ..	7
Delavan Roller Pump	10
Fittings	15, 16, 18
Foam Markers	4
Gauges	13
Gloves	12
Hand Guns.....	22
Hose and Clamps.....	17
Inductors	24
Venturi Kit	24
Nozzle Bodies.....	18-19
Nozzles	21
Quick Couplers	13
Spot Sprayers.....	3
Spray Tips.....	21
Sprayer Controls	11
Strainers	14
12-Volt Pumps	5
Tanks	23
Thomas Compressors	5
Thread Sealants	23
Transfer Pumps	5
Utility Sprayer	1
Valves	
Bolted Ball.....	14
Electric Ball	10,12
Solenoid.....	11

To Order: Call 712-243-5520 or email us at: lloyd@metc.net Lloyd and Meredith customer service hours are 8:00 a.m. to 5:00 p.m. C.S.T. Monday through Friday.

Prices: Prices listed in this catalog are Lloyd and Meredith selling prices. **Prices are subject to change without notice.**

Payment: Methods of payment are-- Check, Master Card, VISA, Discover

Freight Damage: All damaged freight must be reported at the time of delivery to the carrier.

Returns: No merchandise is to be returned to Lloyd and Meredith for credit, unless authorization is first given by Lloyd and Meredith.

Warranty: Defective merchandise and warranty items will be handled in accordance with the manufacturer's warranty program.

Non-warrantable merchandise will be handled at customer's discretion. All freight charges incurred are customer's responsibility.

Catalog Errors and Changes: Product specifications and pricing presented in this catalog are believed to be accurate at the time of publication. Lloyd and Meredith does, however, reserve the right to override information deemed to be in error.

Find us on the web!

www.lloydandmeredith.com

Utility Sprayer



- 40- or 60-gallon Tank
- 5.0 gpm 12-volt pump
- Spot Spray Gun with Adjustable Tip
- Boomless Nozzle Kit with 22' Spray Width

\$640⁰⁰

60-gallon Sprayer w/ 22' Boomless Kit

Boomless Kit Only --- \$175⁰⁰

Sprayer less the
22' Boomless Kit

40-gallon ..\$460⁰⁰

60-gallon \$475⁰⁰



ATV Sprayers

- 25-gallon with 150" boom
- Tank with drain
- 3.5 gpm, 12 Volt Pump
- Pressure Gauge
- Bypass Valve for pressure control
- TeeJet Handgun with 10' of 3/8" hose
- 150" Coverage Folding Boom



\$635



- 25-gallon with 22' coverage Boomless Tips
- Tank with drain
- 5.0 gpm, 12 Volt Pump
- Pressure Gauge
- Bypass Valve for pressure control
- TeeJet Handgun with 10' of 3/8" hose
- Two-directional TeeJet tips for 22' coverage

\$580



Shut off one tip and spray 11' one direction for fence rows and road-side applications.

Boomless Kit Only --- \$145⁰⁰



SPOT SPRAYERS

15 gallon w/ 1.8 gpm pump \$200⁰⁰ w/ 100# pressure ... \$235⁰⁰

25 gallon w/ 1.8 gpm pump \$215⁰⁰ w/ 100# pressure ... \$250⁰⁰

25 gallon Deluxe \$395⁰⁰
includes 3.5 gpm pump, pressure gauge, by-pass valve,
and 1/4 turn ball valve for boom supply

25 gallon Deluxe with 5.0 gpm pump..... \$445⁰⁰

STANDARD EQUIPMENT

- ShurFlo 12-Volt Pump.
- Spraying Systems Poly Trigger Gun with adjustable nozzle.
- Non-corrosive poly tank with 5" screw-on lid.
- Tank Drain for easy clean-out.

AVAILABLE OPTIONS

Deluxe Trigger Spray Gun w/ Poly Adj. Tip add \$39⁰⁰

150" Coverage Folding Spray Boom..... \$195⁰⁰



FOAM MARKERS

High Capacity

- 25 Gallon Poly Tank
- Right-Left Switching
- Needle Valve Adjustment
- Thick Consistent Foam
- 4" Foam Collectors
- 12-Volt Compressor and Pump
- Quick Disconnect Wiring Harness
- Simple Operation
- Easy Installation

\$1,390⁰⁰



The LM 25-gallon foam marker can be mounted on any type of spray applicator. The liquid and air are mixed at the end of the boom producing a high quality foam. Hose is supplied for a 60' boom, with additional available upon request. The main unit is preassembled with only the mounting of the drop tubes and hose connections required.

Switch

\$16⁸⁰



Foam Drop

\$28⁸⁰



Solenoid Valve

\$94⁰⁰



Mix Chamber

\$26⁰⁰



Foam Dye also available.
Please call for current pricing.

FOAM MARKER	Specifications
Foam Output	8.4 gpm
Max. Solution Usage	11.4 gph
Ave. Drop Interval	2.8 seconds

StayFoam 120 Concentrate

1 gallon.. \$88⁰⁰

STF120 produces a thick, bright white foam featuring high visibility that performs well under adverse conditions. Stayfoam 120 is reliable when applied in hot weather, to extremely dry soil and intense sunlight. The features provided in STF 120 enable the applicator to properly align the spraying equipment, resulting in accuracy during the application process.



Mixing rates:
1 oz to 1 gallon water

SHUR-FLO 12 VOLT PUMPS

Model	GPM	Pump Type	Use	Price
8000-543-236	1.8	Demand	Spot Sprayer	\$132.00
2088-443-145	3.5	Demand	Spot Sprayer	\$148.00
8000-543-250	1.8	Bypass	Foam Marker.....	\$154.00
Delavan	5.0	Demand	Spot Sprayer	\$198.00
8000-543-238	1.8	Demand	100# Spot Sprayer ..	\$165.00



Model: 8000-543-238



THOMAS COMPRESSORS

(for Foam Markers)

High Capacity: \$490⁰⁰



Gas Engine
Polypropylene
Transfer Pumps

\$425⁰⁰



Pump Performance Model 1542P-65SP

2" x 2" NPT self-priming centrifugal pump powered by a 6.5 HP PowerPro engine.

Max Flow Rate: 200 gpm
Max Pressure: 58 psi

\$1,335⁰⁰



Pump Performance Model 1543P-130ESP

3" Poly Pump powered by 13 hp PowerPro Engine w/ electric start.

Max Flow Rate: 440 gpm
Max Pressure: 54 psi

Highest efficiency and horsepower on the market!

Other applications include:

- Polypropylene housing is suitable for corrosive environments
- PowerPro engine with overhead valve
- Easily handles high capacity liquid transfer jobs

\$730⁰⁰



**Pacer 2" Pump w/ Honda
6 hp GX200 Engine**



PTOC-600-65SPQC



FMC-150-MIA

**PTO DRIVEN
CENTRIFUGAL
PUMPS**

PTOC-600-Q

1 1/4" Suction x 1" Discharge

Model	Description	Wt.	Price
PTOC-600-QC	Cast iron straight centrifugal with pulleys and 10 groove belt arranged for direct mounting on 1-2/8" 600 rpm PTO shaft. 0-70 psi. Equipped with 6 spline quick coupler PTO drive shaft. Viton mechanical seal. Fully guarded for operator safety.	46	\$1,118.00
PTOC-600-B	Cast iron straight centrifugal with pulleys and 10 groove belt. One-inch diameter stub shaft and integral mounting base. 600 rpm Tumblerod drive shaft. 0-70 psi. Equipped with Viton mechanical seal. Fully guarded for operator safety.	42	\$1,118.00
PTOC-1000-21SP	Cast iron straight centrifugal with pulleys and 10 groove belt arranged for direct mounting on 1-3/8" 1000 rpm PTO shaft. 0-70 psi. Equipped with 21 spline split PTO drive shaft and split ring locking collar. Viton mechanical seal. Fully guarded for operator safety.	43	\$1,122.00
PTOC-1000-20SP	Cast iron straight centrifugal with pulleys and 10 groove belt arranged for mounting on 1-3/4" 1000 rpm PTO shaft. 0-70 psi. Equipped with 20 spline split PTO drive shaft and split ring locking collar. Viton mechanical seal. Fully guarded for operator safety.	45	\$1,158.00
PTOC-1000-B	Cast iron straight centrifugal with pulleys and 10 groove belt. 0-70 psi. One-inch diameter stub shaft and integral mounting base for 1000 rpm Tumblerod drive shaft. Viton mechanical seal. Fully guarded for operator safety.	40	\$1,118.00
FMC-MIA	Cast Iron Centrifugal Pump ONLY for PTOC models. Suction 1-1/4" Female Pipe Thread. Discharge 1" Female Pipe Thread		\$460.00

1 1/2" Suction x 1 1/4" Discharge

**150 SERIES
HIGH PERFORMANCE**

Model	Description	Wt.	Price
PTOC-150-600-6SPQC	0-100 psi, cast iron straight centrifugal with pulleys and 10 groove belt assembled for direct mounting on 1-3/8", 600 rpm PTO shaft, equipped with Quick Coupler. Viton mechanical seal. Fully guarded for operator safety.	51	\$1,260.00
PTOC-150-600-B	0-100 psi, cast iron straight centrifugal with pulleys and 10 groove belt. One-inch diameter stub shaft and integral mounting base for 600 rpm Tumblerod drive shaft. Viton mechanical seal. Fully guarded for operator safety.	52	\$1,260.00
PTOC-150-1000-21SP	0-100 psi, cast iron straight centrifugal with pulleys and 10 groove belt arranged for direct mounting on 1-3/8" 1000 rpm PTO shaft. Equipped with 21 spline PTO shaft and locking collar. Viton mechanical seal. Fully guarded for operator safety.	48	\$1,270.00
PTOC-150-1000-20SP	0-100 psi, cast iron straight centrifugal with pulleys and 10 groove belt arranged for direct mounting on 1-3/4" 1000 rpm PTO shaft. Equipped with 20 spline PTO shaft and locking collar. Viton mechanical seal. Fully guarded for operator safety.	50	\$1,306.00
PTOC-150-1000-B	0-100 psi, cast iron straight centrifugal with pulleys and 10 groove belt. One-inch diameter stub shaft and integral mounting base for 1000 rpm Tumblerod drive shaft. Viton mechanical seal. Fully guarded for operator safety.	45	\$1,270.00
FMC-150-MIA	Replacement Pump for PTOC-150 Models	23	\$485.00

FMC-150-HYD-206

1½" x 1¼"

Suction Discharge



150 SERIES

HIGH PERFORMANCE

\$947⁰⁰

#LS206N

Flow Limiter* \$89⁰⁰

*Required on Load Sensing Closed Center Hydraulic Systems

**CENTRIFUGAL PUMP--TRACTOR
HYDRAULIC SYSTEM DRIVEN**

- > The High Performance Pump: 88 gpm at 100 psi.
- > Provides higher pressure and greater volume for applications with large tanks and longer spray booms.
- > The 206 motor requires 7 gpm hydraulic fluid input and fits virtually all tractor hydraulic systems.

Recommended for:

- » Pressure Compensating Closed Center Systems
- » Load Sensing Closed Center Systems
- » Open Center Systems up to 16 gpm using internal needle valve bypass.



HYPRO HYDRAULIC PUMPS

Model No.	Max. GPM	Max PSI	Max Hydraulic Motor gpm	Description	Price
9303C-HM1C	114	130	13 gpm	1-1/2" FPT inlet, 1-1/4" FPT outlet	\$1,080
9306C-HM1C	207	127	13 gpm	2" FPT inlet x 1½" FPT Outlet	\$1,240
9306C-HM1C-U	207	127	13 gpm	220 x 220 Flange	\$1,285
9306C-HM5C-U	212	140	17 gpm	220 x 220 Flange	\$1,285



REF. #	PART #	DESCRIPTION	PRICE
1	BAC-10-S	Shaft, 1" Tumblerod stub	\$338.25
2	BAC-10-175-20SP	Shaft, 1-3/4" 20 Tooth PTO spline, includes BAC-11-175	\$455.90
3	BAC-10-21SP	Shaft, 1 3/8" 21 Tooth PTO spline, includes BAC-11	\$432.40
4	40960	Nut, 3/8" NC, jam	85c
5	BAC-40	Set screw, 3/8" NC slotted	\$1.25
6	BAC-11-175	Locking collar, split ring (for BAC-10-175-20SP shaft)	\$163.80
7	BAC-11	Locking collar, split ring (for BAC-10-21SP shaft)	\$120.60
8	BAC-11-1	Set screw (for BAC-11 and BAC-11-175 locking collar)	\$1.25
9	BAC-10-6SP-QC	Shaft, 1-3/8" 6 Tooth PTO spline, for quick coupler	\$363.10
10	BAC-83-QC	Ball for quick coupler	\$1.75
11	BAC-82-QC	Spring for quick coupler	\$14.25
12	BAC-81-QC	Ball retainer sleeve for quick coupler	\$39.85
13	41250	Cap screw, 5/16" NC x 3-1/4", hex head	\$2.25
14	41300	Set screw, 3/8" NC x 5/8", allen head	\$1.05
15	BAC-30-10-M	Pulley, 6.375" P.D. x 2" Bore, Poly-V (for PTOC-1000-21SP & -B)	\$267.80
15	BAC-30-175	Pulley, 6.375" P.D x 2-3/8" Bore, Poly-V (for PTOC-1000-20SP)	\$288.70
16	BAC-63	Nut, 5/16" NC, self locking, for tumblerod drive	\$1.25
17	BAC-34	Snap ring, internal, BAC-15 bearing housing	\$6.00
18	BAC-27	Name plate	\$10.90
19	BAC-35	Snap ring, external, BAC-10 drive shaft	\$1.50
20	BAC-31-1	Bearing, sealed, BAC-10 drive shaft	\$50.90
21	BAC-38-1	Spacer, bearing, BAC-10 shaft	\$38.20
22	BAC-44	Washer, 3/8" locking	75c
23	BAC-45	Nut, hex, 3/8" NC	\$1.00
24	BAC-15	Housing, PTO drive shaft bearing housing	\$215.30
24	BAC-15-B	Housing, tumblerod drive shaft bearing housing with mounting base	\$308.60
25	BAC-10-6SP	Shaft, 1-3/8" 6 Tooth PTO spline drive	\$357.90
26	BAC-51	Shaft, 3/8" x 1/2" x 1-1/2" key, PTO drive shaft	\$5.80
27	40960	Nut, jam, 3/8" NC	85c
28	BAC-40	Set screw, 3/8" NC, slotted	\$1.25
29	BAC-30-10	Pulley, 10.6" P.D. x 2" bore Poly-V pulley, 10 groove (for PTOC-600)	\$278.20
30	41300	Set screw, 3/8" NC x 5/8", allen hd	\$1.05
31	BAC-28-10	Belt, Poly-V, 10 groove (for PTOC-600)	\$58.50
31	BAC-28-10-M	Belt, Poly-V, 10 groove (for PTOC-1000)	\$59.30
32	BAC-53	Pipe plug, 1/8" NPT	\$1.00
32	41120	Pipe plug, 1/8" NPT, stainless steel (optional)	\$6.00
33	BAC-12	Volute 1-1/4" x 1", cast iron	\$262.20
34	BAC-26-CI	Impeller, cast Iron, left hand thread (optional)	\$212.80
34	BAC-26-VALOX	Impeller, Valox, left hand thread	\$92.30
35	BAC-4A	O-Ring	\$9.25
36	BAC-7SC	Seal, silicon carbide mechanical (includes 40160) (optional)	\$172.00
36	BAC-7V	Seal, Viton, mechanical (includes 40160 O-ring)	\$49.80
36A	40160	O-ring for mechanical seal	\$1.25

REF. #	PART #	DESCRIPTION	PRICE
37	BAC-42	Cap screw, 3/8" NC x 2" hex head	\$1.75
38	BAC-43	Washer, 3/8" flat	70c
39	BAC-14-MIA	Mounting frame, machined for idler arm	\$288.70
40	BAC-15-PIN	Alignment pin	\$1.40
41	40950	Cap screw, 3/8" NC x 3/4" hex head	\$1.00
41	40930	Cap screw, 3/8" NC x 3/4" hex head, stainless steel (optional)	\$2.75
42	BAC-54	Slinger	\$2.25
43	BAC-33	Snap ring, internal, for mounting frame	\$2.25
44	BAC-37	Bearing, sealed, for pump shaft	\$19.90
45	BAC-32	Snap ring, external, for driven pump	\$1.05
46	BAC-32-S	Spacer for pump shaft	\$6.00
47	BAC-6-SS	Shaft, 5/8", left hand course thread, stainless steel	\$136.60
48	BAC-50	Key, 3/16" x 3/16" x 1-1/4"	\$1.75
49	BAC-57	Cap screw, 5/16" NC x 5/16" allen head,	\$1.05
50	BAC-29-10-1.50	Pulley, 1.5" P.D. x 5/8" bore, Poly-V, 10 groove	\$84.70
51	BAC-5	Spring, idler mounted torsion	\$22.80
52	BAC-13	Idler arm	\$92.30
53	BAC-36	Snap ring, external, BAC-13 idler arm	\$2.25
54	BAC-46	Spacer, 5/8"	\$30.20
55	41070	Retainer ring	\$1.25
56	BAC-55	Idler bearing and outer roller assembly	\$67.10
57	BAC-47	Cap screw, 5/8" NC x 2 1/8" hex head idl	\$8.20
#	BAC-52	Chain, 1/4" cold shut, torque anchor	\$5.00
#	BAC-58	Zerk fitting, 1/4" NPT, for idler arm	\$3.75
#	BAC-55-A	Idler arm assembly (includes 52 through 57 and BAC-58)	\$198.50

Parts List for ACE Centrifugal Pumps

Exploded view drawing, PTOC series

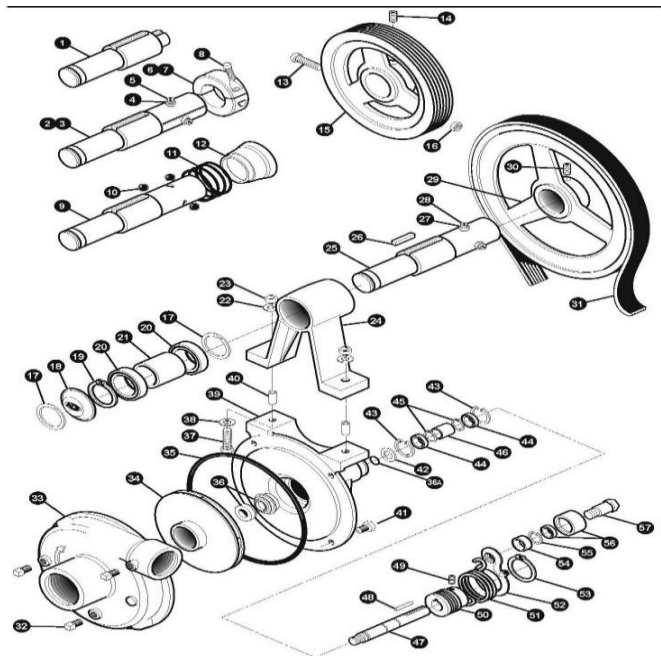

ACE PUMPS PARTS -- 150 SERIES BELT DRIVE

Ref. #	Part No.	Description	Price
1	*BAC-4-150	"O" Ring, Volute Seal - - - - -	\$7.80
2	BAC-5-150	Idler mounted torsion spring - -	-\$26.10
3	BAC-6-150/200-SS	3/8" Driven Shaft with Keyway, S.S. -	\$134.30
4	*BAC-7V	Viton Mechanical Seal - - - - -	-\$49.80
#	*40160	"O" Ring for Shaft - - - - -	\$1.25
6	BAC-10-6SP-QC	1-3/8" 6 Tooth PTO shaft, Q/C - -	-\$363.10
7	BAC-10-175-20SP	1-3/4" 20 Tooth PTO shaft - -	-\$455.90
8	BAC-10-21SP	1-3/8" 21 Tooth PTO shaft - -	-\$432.40
9	BAC-10-S	1" Tumblerod stub drive shaft	\$338.25
10	BAC-11	Split ring, locking collar - - -	-\$120.60
11	BAC-11-175	Split ring, locking collar - - -	-\$163.80
12	BAC-11-1	Set screw - - - - -	\$1.25
13	BAC-12-150	Volute, 1 1/2" x 1 1/4" - - - - -	-\$325.40
14	BAC-13	Idler Arm - - - - -	-\$92.30
15	BAC-14-150-MIA	Mounting frame, M.I.A. - - -	-\$342.20
16	BAC-15	PTO Drive shaft bearing housing - -	-\$215.30
#	BAC-15-B	Tumblerod housing w/ Mounting -	\$308.60
17	BAC-26-150-P	Impeller, poly - - - - -	-\$92.30
17	BAC-26-150-CI	Impeller, Cast Iron with Keyway -	\$231.90
18	BAC-27-150-M	Name Plate (21SP) - - - - -	-\$10.90
18	BAC-27-150-175-M	Name Plate (20SP) - - - - -	-\$10.90
18	BAC-27-150-600	Name Plate (600) - - - - -	-\$10.90
19	*BAC-28-10-150	Poly-V Belt, 10 groove (600) - -	-\$64.00
#	*BAC-28-10M-150	Poly-V Belt, 10 groove (1000)- -	-\$65.00
20	BAC-29-10-1.35	1.35" P.D.x 5/8" V pulley - - -	-\$84.70
#	BAC-29-10-1.70	1.7" P.D. x 5/8" V pulley- - -	-\$84.70
21A	BAC-30-10-150	11.6" P.D. x 2" V pulley - - -	-\$299.90
21B	BAC-30-175-150	7.9" P.D. x 2-3/8" V pulley - -	-\$314.90
21B	BAC-30-10M-150	7.9" P.D. x 2" V pulley - - -	-\$288.70
22	BAC-31-1	Sealed ball bearing - - - - -	-\$50.90
23	BAC-32	External snap ring - - - - -	\$1.05
24	BAC-32-S	Spacer for pump shaft - - - - -	\$6.00
25	BAC-33	Internal snap ring - - - - -	\$2.25
26	BAC-34	Internal snap ring - - - - -	\$6.00
27	BAC-35	External snap ring - - - - -	\$1.50
28	BAC-36	External snap ring - - - - -	\$2.25
29	BAC-37	Sealed Ball Bearing - - - - -	-\$19.90
30	BAC-38-1	Bearing spacer - - - - -	-\$38.20
31	40930	Hex head cap screw S.S. - - - -	\$2.75
31	40950	Hex head cap screw- - - - -	\$1.00
32	BAC-40	3/8" NC Slotted Set Screw - - -	\$1.25
33	40960	3/8" NC Jam Nut - - - - -	85¢
34	BAC-42	3/8" NC x 1-3/4" cap screw- - -	\$1.75

Ref. #	Part No.	Description	Price
35	BAC-43	3/8" Flat Washer	70¢
36	BAC-44	3/8" Lock Washer	75¢
37	BAC-45	3/8" NC Hex Nut	\$1.00
38	BAC-46	5/8" Spacer	\$30.20
39	BAC-47	Idler Cap Screw	\$8.20
40	BAC-49	Retainer Ring	75¢
41	BAC-50	3/16" x 3/16" x 1 1/4" Key	\$1.75
42	BAC-51	3/8" x 1/2" x 1 1/2" Key	\$5.80
43	BAC-52	1/4" Cold Shut Chain Anchor	\$5.00
44	BAC-53	1/8" NPT Pipe Plug	\$1.00
45	BAC-54	Slinger	\$2.25
46	BAC-55	Idler bearing and outer assembly	\$67.10
47	BAC-57	Allen head set screw	\$1.05
48	41250	Allen head cap screw	\$2.25
49	BAC-63	5/16" NC self-locking nut	\$1.25
50	41300	Allen head set screw	\$1.05
52	BAC-81-QC	Ball Retainer Sleeve	\$39.25
53	BAC-82-QC	Spring for Quick Coupler	\$14.25
54	BAC-83-QC	Ball for Quick Coupler	\$1.75
55	BAC-23-A-SS	3/8" NF Hex Nut, S.S.	\$10.25
56	BAC-24-HYD-SS	3/8" Washer, S.S.	\$2.00
57	BACH-25	1/8" x 1/8" x 1/2" Key	\$1.25

EXPLODED VIEW DRAWING

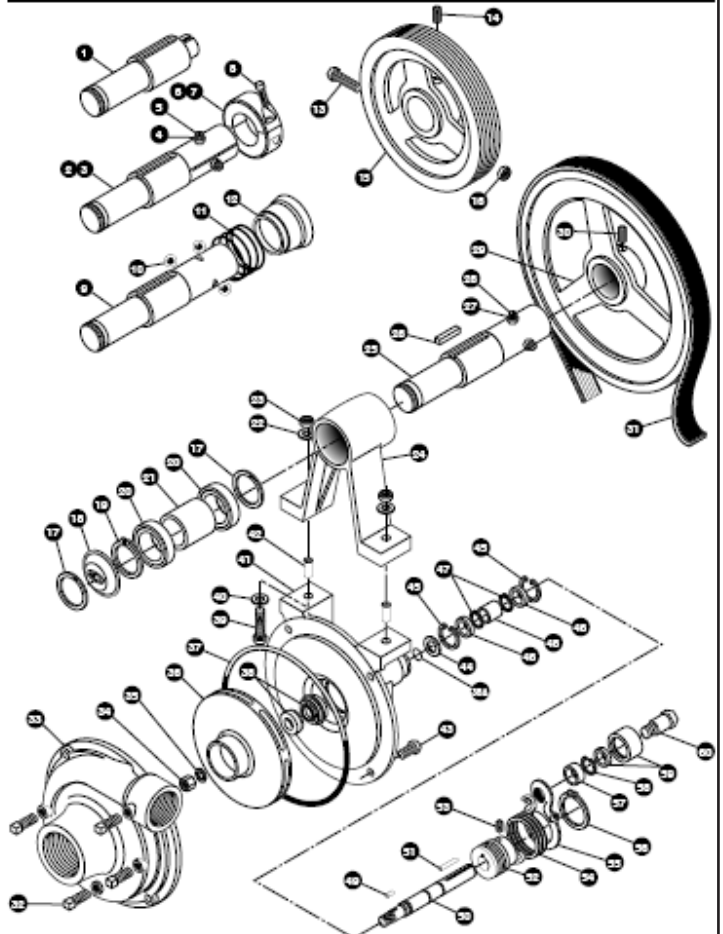

Delavan Roller Pumps



Model 6900C

Model No.	Max GPM	Max PSI	Description	Price
6900C	20.0	300	Cast iron 6 roller pump, 11/16" rollers	\$185.00
8900C	24.0	300	Cast iron, 8 roller pump, 11/16" rollers	\$225.00
PTO Pump Coupler . . . \$39.00				

Model 6900C
1200 rpm
5/8" solid steel shaft
3/4" NPT port

Model 8900C
1000 rpm
15/16" solid steel shaft
1" NPT port

All pumps contain Ultra Rollers for better performance, wear life, and smooth operation. Viton seals and stainless steel shafts are standard.

DirectoValve

\$287⁰⁰

Nylon Ball Valves
for Pressures up
to 300 PSI

- Works with a simple single pole off/on switch.



344BEC-24-C Remote Control Electric Ball Valves Compatible with All Sprayer Controls

The Astro Series of GPS-Based Speed Sensors

Note: It is necessary to know the make and model of the controller you will be hooking it up to.

\$415⁰⁰



The Astro II

- Great Price!
- Compact
- Accurate
- Durable
- Easy transfer from one vehicle to another

Electric Sprayer Controls

All Sprayer Control Kits include:

- Control Panel,
- Pressure Regulator
- Gauge Tee
- 16-Foot Wiring Cables
- Gauge Tube.

Kits may be ordered with or without directo valves.



AAK-744A-100L-33S
3 Section Control Kit

SPRAYER CONTROL KITS

Kit No.	Description	744-3 Triple Control	AA244-3 Regulator	Directo Valve	Price
AAK-744A-100L-30S	Triple Control	1	1	--	\$520.00
AAK-744A-100L-33S	90-50163 Triple Control	1	1	AA144A-3	\$790.00
AA244-3/4	Regulator Only, 3/4" FNPT				\$180.00

The 744A Sprayer Controls used in these kits can be used for operating pressures to 100 psi. Higher pressures are available on a special order basis

DIRECTOVALVE Electronically Operated Valve

Mfg.'s Part No.	Description	List Price
AA144A-1	1 Unit Valve ..	\$139.00
AA144A-2	2 Unit Valve ..	\$281.00
AA144A-3	3 Unit Valve ..	\$422.00

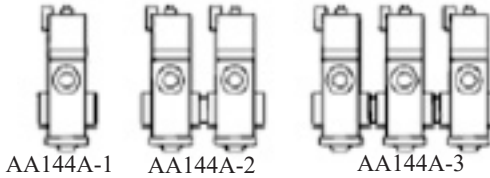

Designed for remote "on-off" control of spray booms and nozzles from operator's location. Operates on a 12-volt DC system (2 Amp Current Draw). For pressures to 100 psi.

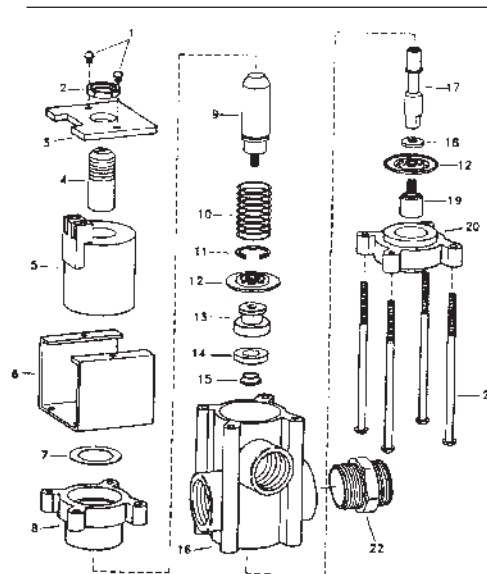

Ref.	Part No.	Description	Price
1	CP-14933-SS	Screw, (2 req'd)	\$2.37
2	CP15168-IENP	Jam Nut	\$7.84
4	CP15161-IENP	Armature Stop	\$16.72
5	CP15163-NYB	Coil Assembly	\$77.12
7	CP15169-SS	Washer	\$3.05
8	CP15164-NYB	Upper Diaphragm Housing	\$8.19
9	CP15170-IENP	Armature	\$30.80
10	Available in Kit Only		
11	CP14813-IENP	Retaining Ring	\$3.05
12	Available in Kit Only		
13	CP14807-SS	Seat Washer	\$24.92
14	Available in Kit Only		
15	CP14811-SS	Spacer	\$7.20
16	CP14801-PP	Body, Polypropylene	\$22.14
17	CP14812-SS	Stem, Stainless Steel	\$28.20
18	CP14806-SS	Washer, Stainless Steel	\$8.25
19	CP15162-SS	Lower Diaphragm Piston	\$15.70
20	CP15165-NYB	Lower Diaphragm Housing	\$30.37
21	CP14819-SS	Screw, Stainless Steel (4 req'd)	\$2.79
22	CP21737-NYB	Connecting Nipple	\$2.80
	PK-AB144A-1-KIT	Repair Kit	\$41.86



DirectoValve® 450 Manifold



453BEC Manifold

450BEC Features:

- Maximum pressure 150 psi (10 bar)
- Easy mounting with built-in brackets
- Nylon stem and polypropylene ball available as standard
- Flow rate 31 GPM @ 5 psi pressure drop (flow rates may vary based on number of valves and inlet size)
- No external fuses--incorporates an internal resettable fuse

~~disconnect power to valve for
20 seconds to reset~~

#451BEC1-Valve Manifold\$282⁰⁰

#452BEC2-Valve Manifold \$542⁰⁰

#453BEC3-Valve Manifold\$798⁰⁰

#454BEC 4-Valve Manifold... \$1,054⁰⁰

#455BEC 5-Valve Manifold... \$1,318⁰⁰

Replacement Motor only.... \$235⁰⁰

Chemical Gloves

100% Nitrile Gloves
13" color: Green

- Non-Slip Grip
- Puncture Resistant
- Comfortable
- USDA Accepted



\$29⁹⁰
per dozen

Chemical Isolator Kit

\$49⁵⁰



- Keeps chemicals from entering tractor or truck cab
- Protects and dampens gauge from corrosive chemicals
- Atlas diaphragm
- Comes with fittings for 1/8" and 1/4" diameter gauge tubing

Manual Pressure Relief/Regulating Valves

\$24²⁰



**Inlet, 3/4" MNPT
Outlet, 3/4" FNPT**

Bypasses excess liquid. Chemical-resistant diaphragm seals off operating parts from contact with chemicals and remains resilient for chatter-free, responsive pressure control.

A / Male Adapter Female Thread		
<i>Size</i>	<i>Part No.</i>	<i>Price</i>
¾" Female NPT	075-A	\$4.85
1" Female NPT	100-A	\$4.85
1½" Female NPT	150-A	\$5.40
2" Female NPT	200-A	\$6.40
3" Female NPT	300-A	\$14.60



D / Female Coupler Female Thread		
<i>Size</i>	<i>Part No.</i>	<i>Price</i>
¾" Female NPT	075-D	\$10.90
1" Female NPT	100-D	\$12.90
1½" Female NPT	150-D	\$15.90
2" Female NPT	200-D	\$18.60
3" Female NPT	300-D	\$29.90



B / Coupler X Male NPT		
<i>Size</i>	<i>Part No.</i>	<i>Price</i>
1½" Female Coupler, Male Thread	150-B	\$16.40
2" Female Coupler, Male Thread	200-B	\$19.60
3" Female Coupler, Male Thread	300-B	\$29.90



F / Male Adapter Male Thread		
<i>Size</i>	<i>Part No.</i>	<i>Price</i>
1½" M x M	150-F	\$6.80
2" M x M	200-F	\$7.90
3" M x M	300-F	\$17.90



PRESSURE GAUGES			
<i>Description</i>		<i>Part No.</i>	<i>Price</i>
1/4" Bottom Fitting, Brass Stem 2½" Face			
0-100 psi	100G		\$10.90
MPT - Brass Stem, 4" Face			
0-100 psi	100-G4		\$20.40
Liquid Filled			
0-100 psi, 2½" Face	100 LG		\$21.90
Liquid Filled, 4" Case			\$56.00
Ammonia, 0-60 psi, 2½" Face			\$21.80



CAP / CAP for Male Adapter		
<i>Size</i>	<i>Part No.</i>	<i>Price</i>
¾" Cap for Adapter	075-CAP	\$10.90
1" Cap for Adapter	100-125-CAP	\$12.90
1½" Cap for Adapter	150-CAP	\$15.80
2" Cap for Adapter	200-CAP	\$18.60
3" Cap for Adapter	300-CAP	\$29.90



PL / Plug for Female Coupler		
<i>Size</i>	<i>Part No.</i>	<i>Price</i>
¾" Plug for Coupler	075-PL	\$4.40
1" Plug for Coupler	100-125-PL	\$4.40
1½" Plug for Coupler	150-PL	\$4.90
2" Plug for Coupler	200-PL	\$6.90
3" Plug for Coupler	300-PL	\$14.90



WARNING!

Brass Stem Gauges are *NOT* to be used with Ammonia!



Poly Ball Valve

Size	Part No.	Price
3/4"	V-075	\$30.60
1"	V-100	\$30.60
1-1/4" Full Port	V-125-FP	\$37.70
1-1/2" Full Port	V-150-FP	\$37.70
2" Full Port-4 Bolt	V-204-FP	\$48.00
3" Full Port	V-300-FP	\$98.70

VALVES



Poly Nozzle (Ball) Valve

Size	Part No.
2" Full Port	VXA-204-FP
Price: \$68.20	



Union Ball Valve

Size	Part No.	Price
1/2"	050-SUBV	\$17.90
3/4"	075-SUBV	\$20.90
1"	100-SUBV	\$24.90
1 1/4"	125-SUBV	\$40.90
1-1/2"	150-SUBV	\$51.90
2"	200-SUBV	\$67.80
2"	3-Way Valve	\$69.90



Size	Part No.	Price
3/4"	TT12	\$6.80

Female National Pipe Thread Tee with 1/4" Gauge Port

Y FITTINGS

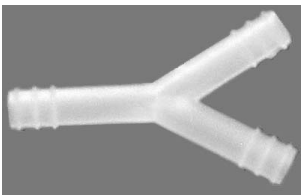

Y Barb Fitting
1/4" .. \$3⁸⁰
3/8" .. \$3⁸⁰

Plastic Ties

In packages of 100



7"----- 50#\$7.95
11" --- 50#\$10.95
14" --- 120#\$18.60

LINE STRAINERS



1 1/4" - 2" Polypropylene Line Strainer

1-1/4" Line Strainer w/ 50 Mesh Screen	LS-125-50	\$49.50
1-1/2" Line Strainer w/ 50 Mesh Screen	LS-150-50	\$84.90
2" Line Strainer w/ 50 Mesh Screen	LS-200-50	\$84.90
20 Mesh Screen only	LS-220	\$35.90
50 Mesh Screen only	LS-240	\$39.90
80 Mesh Screen only	LS-280	\$39.90
LS-200/G	Gasket	\$4.90

Nylon Line Strainer

3/4" and 1"

3/4" Nylon Strainer w/ 40 Mesh Screen	\$28.00
1" Nylon Strainer w/ 40 Mesh Screen	\$28.00
40 Mesh Screen	\$10.80
80 Mesh Screen only	\$10.80
Gasket	\$1.80









Polypropylene and Nylon Pipe Fittings

Please call if size needed isn't listed

 Pipe Nipples			 Reducing Pipe Nipples			 Female National Pipe Thread 90° Elbow		
Size	Part No.	Price	Size	Part No.	Price	Size	Part No.	Price
1/4" x Close	TN5044	60¢	3/4" x 1/2"	TRN60128	\$2.60	1/2"	EL88	\$4.60
3/8" x Close	TN5066	\$1.40	1" x 3/4"	TRN601612	\$3.95	3/4"	EL1212	\$4.80
1/2" x Close	TN5088	\$1.60	1 1/4" x 1"	TRN602016	\$3.95	1"	EL1616	\$5.60
3/4" x Close	TN51212	\$2.40	 Pipe Couplings FNPT X FNPT			 90° Street Elbow		
1" x Close	TN51616	\$2.90						
1 1/4" x Close	TN52020	\$3.20						
1 1/2" x Close	TN52424	\$3.90						
2" x Close	TN53232	\$5.40						
3" x Close	TN54848	\$12.80	 Hexagon Head Bushing MNPT X FNPT			 90° Street Elbow		
Size	Part No.	Price	Size	Part No.	Price	Size	Part No.	Price
1/2" x 3/8"	RB86	\$2.60	1/2"	CC88	\$4.60	1/4"	SE44	\$2.90
3/4" x 1/4"	RB124	\$2.60	3/4"	CC1212	\$4.80	1/2"	SE88	\$6.60
3/4" x 1/2"	RB128	\$2.60	1"	CC1616	\$5.30	3/4"	SE1212	\$6.80
1" x 3/4"	RB1612	\$2.80	1 1/4"	CC2020	\$7.80	1"	SE1616	\$7.80
1 1/4" x 3/4"	RB2012	\$3.80	1 1/2"	CC2424	\$9.90	1 1/4"	SE2020	\$9.80
1 1/4" x 1"	RB2016	\$3.80	2"	CC3232	\$12.60	1 1/2"	SE2424	\$12.40
1 1/2" x 3/4"	RB2412	\$4.60	 Female National Pipe Thread Tee			2"	SE3232	\$16.20
1 1/2" x 1 1/4"	RB2420	\$4.60				3"	SE4848	\$47.80
2" x 3/4"	RB3212	\$5.30				 Pipe Plug		
2" x 1 1/4"	RB3220	\$5.30						
2" x 1 1/2"	RB3224	\$5.30						
3" x 2"	RB4832	\$12.60						
			1/4"	TT4	\$4.80	Size	Part No.	Price
			3/8"	TT6	\$4.80	1/4"	TP4004	50¢
			1/2"	TT8	\$4.80	1/2"	TP4008	\$1.60
			3/4"	TT12	\$5.20	3/4"	TP4012	\$1.90
			1"	TT16	\$7.90	1"	TP4016	\$2.80
			1 1/4"	TT20	\$9.80	1 1/4"	TP4020	\$3.80
			1 1/2"	TT24	\$14.10	1 1/2"	TP4024	\$4.80
			2"	TT32	\$16.20	2"	TP4032	\$5.80
			3"	TT48	\$47.20	3"	TP4048	\$16.90

Polypropylene and Nylon Pipe Fittings

Please call if size needed isn't listed

 Male National Pipe			 Male National Pipe Thread x Hose Barb 90° Elbow			 Hose Barb x Hose Barb 90° Elbow		
Size	Part No.	Price	Size	Part No.	Price	Size	Part No.	Price
3" x 3"	TA104848	\$12.60	3" x 3"	TE104848	\$39.90	1/2" x 1/2"	TE2088T	\$1.10
2" x 2"	TA103232	\$7.60	2" x 2"	TE203232	\$7.80	3/4" x 3/4"	TE201212T	\$1.50
2" x 1 1/2"	TA103224	\$9.80	2" x 1 1/2"	TE203224	\$9.90	1" x 1"	TE201616T	\$1.90
1 1/2" x 2"	TA102432	\$9.80	1 1/2" x 1 1/2"	TE202424	\$5.50	1 1/4" x 1 1/4"	TE202020T	\$6.80
1 1/2" x 1 1/2"	TA102424	\$4.90	1 1/2" x 1 1/4"	TE202420	\$5.50	1 1/2" x 1 1/2"	TE202424T	\$7.20
1 1/2" x 1 1/4"	TA102420	\$3.00	1 1/4" x 1 1/2"	TE202024	\$3.90	2" x 2"	TE203232T	\$12.20
1 1/4" x 1 1/2"	TA102024	\$3.30	1 1/4" x 1 1/4"	TE202020	\$3.90	Swivel Nuts for Barbs Below 		
1 1/4" x 1 1/4"	TA102020	\$2.90	1 1/4" x 1"	TE202016	\$3.60			
1 1/4" x 1"	TA102016	\$2.60	1 1/4" x 3/4"	TE202012	\$3.60			
1 1/4" x 3/4"	TA102012	\$2.60	1" x 1"	TE201616	\$2.10			
1" x 1 1/4"	TA101620	\$2.20	1" x 3/4"	TE201612	\$2.10	Size	Part No.	Price
1" x 1"	TA101616	\$1.80	3/4" x 3/8"	TE20126	\$1.60	3/4" FGHT	GHN12	\$1.00
1" x 3/4"	TA101612	\$1.60	3/4" x 1/2"	TE20128	\$1.60	3/4" FNPT	RN12	\$1.20
3/4" x 1/4"	TA10124	90¢	3/4" x 5/8"	TE201210	\$1.60	Swivel Barbs for Nuts Above 		
3/4" x 3/8"	TA10126	90¢	3/4" x 3/4"	TE201212	\$1.70			
3/4" x 1/2"	TA10128	90¢	3/4" x 1"	TE201216	\$1.80			
3/4" x 5/8"	TA101210	90¢	1/2" x 1/4"	TE2084	\$1.20			
3/4" x 3/4"	TA101212	90¢	1/2" x 3/8"	TE2086	\$1.20	Size	Part No.	Price
3/4" x 1"	TA101216	\$1.30	1/2" x 1/2"	TE2088	\$1.20	1/4" Swivel	GHA4	80¢
1/2" x 1/4"	TA1084	70¢	1/2" x 5/8"	TE20810	\$1.50	3/8" Swivel	GHA6	80¢
1/2" x 3/8"	TA1086	70¢	1/2" x 3/4"	TE20812	\$1.50	1/2" Swivel	GHA8	80¢
1/2" x 1/2"	TA1088	70¢	3/8" x 3/8"	TE2066	\$1.20	5/8" Swivel	GHA10	80¢
1/2" x 5/8"	TA10810	70¢	3/8" x 1/2"	TE2068	\$1.20	3/4" Swivel	GHA12	80¢
1/2" x 3/4"	TA10812	70¢	1/4" x 1/4"	TE2044	\$1.10	Male Garden Hose Thread x Hose Barb 		
3/8" x 1/4"	TA1064	60¢	1/4" x 3/8"	TE2046	\$1.10			
3/8" x 3/8"	TA1066	60¢	1/4" x 1/2"	TE2048	\$1.10			
3/8" x 1/2"	TA1068	60¢	Female National Pipe Thread x Hose Barb 90° Elbow 					
1/4" x 1/4"	TA1044	60¢						
1/4" x 3/8"	TA1046	60¢						
1/4" x 1/2"	TA1048	60¢						
1/8" x 1/4"	TA1024	60¢	Size	Part No.	Price	3/4" x 3/8"	GA106	90¢
1/8" x 3/8"	TA1026	60¢	3/4" x 1/2"	TO234	\$3.40	3/4" x 1/2"	GA108	90¢
			3/4" x 3/4"	TO434	\$3.40	3/4" x 5/8"	GA1010	\$1.60
						3/4" x 3/4"	GA1012	\$1.60

Sprayer Hoses

EPDM Suction Hose w/ Poly Spiral Braid (Chemical)	
I.D. Size	Price/Foot
1"	\$2.70
1-1/4"	\$3.00
1-1/2"	\$3.80
2"	\$4.60
3"	\$8.60



EVA Ammonia and Chemical Hose	
3/8"	80¢
1/2"	95¢

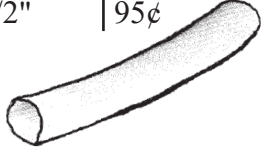

	I.D. Size	Price/Foot
EPDM Lasso Resistant Rubber Hose 	1/4"	75¢
	3/8"	92¢
	1/2"	\$1.27
	5/8"	\$1.58
	3/4"	\$1.97
	1"	\$2.60
	1-1/4"	\$5.59
	1-1/2"	\$6.70
	2"	\$9.90

10%
DISCOUNT
ON FULL
ROLLS

Clamps

T-Bolt Hose Clamps



- Stainless steel band
- 360° sealing surface

Hose:

1-1/2" \$5.90

2" \$6.80

3" \$8.60

Stainless Steel Worm Driven Hose Clamps		
Hose Size	Part No.	Price
3/8"	M6	\$1.00
1/2"	6	\$1.20
5/8"	12	\$1.30
3/4"	12	\$1.30
1"	16	\$1.40
1 1/4"	20	\$1.80
1 1/2"	28	\$2.10
2"	32	\$2.40





Hose
Clamp



Hose Barb Tee 		
Size	Part No.	Price
1/4" x 1/4" x 1/4"	TT9444	\$1.20
3/8" x 3/8" x 3/8"	TT9666	\$1.20
1/2" x 1/2" x 1/2"	TT9888	\$1.20
5/8" x 5/8" x 5/8"	TT9101010	\$1.40
3/4" x 3/4" x 3/4"	TT9121212	\$1.50
1" x 1" x 1"	TT9161616	\$1.90
1-1/4" x 1-1/4" x 1-1/4"	TT9202020	\$4.60
1-1/2" x 1-1/2" x 1-1/2"	TT9242424	\$5.80
2" x 2" x 2"	TT9323232	\$14.20

NOZZLE BODIES

Hose Barb Nozzle Body Tee			
		Part No.	Price
	3/8" Hose	TO1EL	\$1.80
	1/2" Hose	TO3EL	\$1.80

NOZZLE CAPS			
	Adapter Nozzle Cap Thread x 1/4" FNPT		
	Size	Part No.	Price
	Adapter	TO3AD	\$2.10
	Nozzle Cap (Swivel Nut)		
	Nozzle Cap	TO3CA	40¢
	Swivel Barb (fits Nozzle Cap)		
	3/8"	T3638	85¢
	1/2"	T3612	85¢

HOSE INSERTS		
Hose Menders 		
Size	Part No.	Price
1/4"	TC7044	60¢
3/8"	TC7066	60¢
1/2"	TC7088	70¢
5/8"	TC71010	75¢
3/4"	TC71212	90¢
1"	TC71616	\$1.50
1-1/4"	TC72020	\$2.90
1-1/2"	TC72424	\$3.40
2"	TC73232	\$9.80
3"	TC74848	\$18.60
Hose Barb Nozzle Body Straight 		
3/8" Hose Barb	TO1ST	\$1.40
1/2" Hose Barb	TO3ST	\$1.40
Hose Barb Nozzle Body Tee 		
3/8" Hose	TO1TE	\$1.90
1/2" Hose	TO3TE	\$1.90

Upper and Lower Clamp and Screw		
	Part No.	Price
	AA111-SQ-1	\$3.20
	AAA111-SQ-1-1/4	\$3.20
	Part No.	Price
	AAA111-3/4	\$3.20
	AAA111-1	\$3.20

QJ 360 Series\$17⁴⁴

w/ hose shank

- ~ Multiple nozzle body available in a 3-, 4-, or 5-nozzle body
- ~ Specify hose size and single- or double-shank

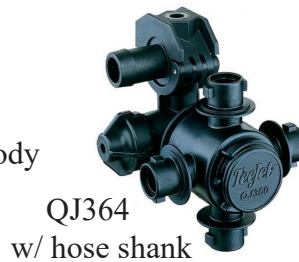

QJ364
w/ hose shank



QJ363
for wet boom

QJ 360 Series for Wet Booms....\$14²⁰

Available for 3/4" and 1" pipe

24230 Triple Nozzle Body.... \$19³⁰

Specify hose size and single- or double-shank



24230-2

193 Series.... \$9³⁰

The diaphragm check valve is located below the boom mount.

Specify hose size and single- or double-shank



19350

222 Series..... \$7⁷⁰

The diaphragm check valve is located on top of the boom mount.

Specify hose size and single- or double-shank



22252

186 Series.....\$3⁸⁰

QuickJet Nozzle Body

Specify hose size and single- or double-shank



18636

QJ Vari-Spacing Clamps....\$2⁵⁰

QJ111 Round Clamps available in 1/2, 3/4, 1, 1-1/4

QJ111SQ Square Clamps available in 3/4, 1, 1-1/4, 1-1/2

**Be sure to specify round or square, and size



QJ111



QJ111SQ



Diaphragms

CP21953-EPR	Diaphragm	EPDM Rubber	60¢
CP21953-VI	Diaphragm	Viton	\$1.50

CAPS / QuickJet Boom Component / CAPS

(color charts adapted from teejet.com)



QUICK TEEJET CAPS	PART NUMBER		FOR USE WITH FLAT SPRAY TIPS 300 PSI (30 BAR) MAXIMUM OPERATING PRESSURE	PRICE
	QUICK TEEJET CAP ONLY	QUICK TEEJET CAP & SEAT GASKET SET		
	CP25611-1-NY CP25611-9-PP11	25612-1-NYR 25612-9-PP11	TeelJet Flat Spray Tips (Smaller Capacities) TJ Standard -0.067 Thru -0.08, X8 -0.1 Thru -0.08, DG TeelJet®, TT, Turbo TwinJet®, A/R TeelJet®, DC TeelJet® -0.1 Thru -0.08	\$1.05
	CP25609-1-NY	25610-1-NYR	TeelJet Flat Spray Tips (Larger Capacities) TJ Standard -10 Thru -20, X8 -10 Thru -15	\$1.05
	CP25597-1-NY	25598-1-NYR	TJ TwinJet®, A/R TeelJet®, BA/RB TeelJet®, SJ-2 StreamJet®, DG TwinJet®, Turbo TeelJet In-ductron®	\$1.05
	CP25595-1-NY	25596-1-NYR	TeelJet Flat Spray Tips (Smaller Capacities) Tips can be positioned in choice of two spray plane directions—parallel or perpendicular to wings of QuickTeelJet cap.	\$1.05
	CP25599-1-NY	25600-1-NYR	Turbo FloodJet® VisiFlo® Spray Tip, TK-VS FloodJet® VisiFlo Spray Tip, Locating Rib	\$1.05
	CP25607-1-NY CP25607-9-PP11	25608-1-NYR 25608-9-PP11	TK FloodJet®, FL FullJet®, TX ConeJet®, TG Full Cone, Hose Shank	\$1.05
	CP25607-1-NY	—	O-Ring, Seal, Core, CP19399-EPR (EPDM standard), CP18999-VI (Nylon optional), Used with DC-Core Insectband CP4016 Flow Regulators (Insert Core into Seal)	\$1.05

*Specify color code (see chart). Unless otherwise specified, a yellow (9) cap will be supplied. White (10) only available in CP25611 and CP25597 Nylon caps.
 †These QuickTeelJet caps available only in black.
 ††Polypropylene QuickTeelJet caps available only in grey.

Quick TeelJet Cap



CP19399-EPR (EPDM Standard)
 CP18999-VI (Nylon Optional)

The QuickTeelJet caps are designed with grooves that fit locating lugs on the nozzle body. Caps are made of Nylon and are available for use with all TeelJet® spray tips. Maximum operating pressure of 300 PSI (20 bar).

How to order:

For cap and seat gasket set, specify set number and color code.
 Example: 25612-3-NYR
 For cap only, specify part number and color code.
 Example: CP25597-4-NY
 For seat gasket, specify part number.
 Example: CP19438-EPR

Adapter Cap



Quick TeeJet Outlet Adapter with EPDM Seat Gasket, Black

Part No.
 QJ4676-1/4-NYR
\$2.30

Shut-Off Cap



Quick TeeJet Shut-Off Cap and Seal Gasket Set

Part No.
 114447A-1-CELR
\$2.15

Cap Gaskets
45¢

Typical Applications:

- Boomless field spray applications
- Roadside and right-of-way applications
- End row spraying

Features:

- Unique orifice geometry produces wide spray pattern while maintaining superior distribution across entire width
- Pre-orifice design minimizes drift
- Extra wide spray pattern--up to 18.5 feet--using a single nozzle

Boomless Tips





Tip sprays one direction. Use an L and an R tip to spray each direction and double width.

TIPO	PSI	ORIFICE SIZE	CAPACITY ONE NOZZLE @ 15 GPM	SPRAY WIDTH "W" (FEET)		HEIGHT "H" - 10'										HEIGHT "H" - 20'									
				30'	36'	GPM FOR ONE NOZZLE					GALLONS PER 1000 SQ. FT.					GPM FOR ONE NOZZLE					GALLONS PER 1000 SQ. FT.				
						4	6	8	10	15	20	2	3	4	5	4	6	8	10	15	20	2	3	4	5
W/TEEP180	30	DC	0.71	8.8	10.8	18.0	8.9	9.2	9.7	1.8	2.0	0.87	0.92	0.94	0.99	8.8	8.9	9.4	9.8	1.8	1.8	0.88	0.92	0.95	0.98
W/TEEP180	30	UC	0.87	10.0	11.0	18.8	7.3	8.8	9.3	1.8	2.0	0.89	0.93	0.95	9.8	9.8	9.8	9.8	1.8	1.8	0.91	0.95	0.97	0.99	
W/TEEP180	40	UC	1.08	11.0	12.5	19.2	7.5	9.0	9.5	1.8	2.0	0.92	0.94	0.96	9.8	9.8	9.8	9.8	1.8	1.8	0.95	0.98	0.99	0.99	
W/TEEP180	50	UC	1.52	12.0	13.8	19.1	7.8	9.8	1.4	1.8	2.0	0.93	0.94	0.95	10.8	9.8	9.7	9.7	1.8	1.7	0.97	0.98	0.98	0.98	
W/TEEP180	60	UC	2.00	13.0	15.8	17.8	7.7	10.0	1.4	1.7	2.0	0.95	0.94	0.92	10.8	9.8	9.7	9.2	1.8	1.7	0.98	0.97	0.97	0.97	
W/TEEP200	30	DC	1.43	9.0	11.0	18.0	10.0	9.8	7.8	8.2	0.8	0.89	0.90	0.91	0.91	18.0	10.7	8.8	8.4	1.8	1.3	0.71	0.69	0.67	0.64
W/TEEP200	30	UC	1.78	11.0	12.0	18.8	12.8	14.0	7.8	8.8	0.8	0.88	0.91	0.91	0.91	18.0	12.0	9.8	7.2	1.8	1.8	0.81	0.80	0.81	0.81
W/TEEP200	40	UC	2.88	11.0	14.0	18.0	12.0	9.2	7.8	4.8	0.7	0.88	0.90	0.91	0.91	17.7	11.8	8.8	7.1	1.8	1.8	0.81	0.80	0.80	0.81
W/TEEP200	50	UC	3.28	11.0	16.0	18.2	12.8	14.8	7.7	8.7	0.8	0.88	0.89	0.91	0.91	18.8	12.4	8.8	7.8	1.8	1.8	0.81	0.81	0.81	0.81
W/TEEP200	60	UC	3.98	11.0	18.0	20	13.8	10.1	8.7	8.8	0.7	0.88	0.89	0.91	0.91	19.8	12.8	8.7	7.7	1.8	1.8	0.81	0.81	0.81	0.81
W/TEEP250	30	DC	2.87	11.0	12.0	22	22	10.1	12.0	8.8	6.5	1.5	0.99	0.74	0.59	20	10.7	14.8	11.8	1.9	1.9	0.99	0.99	0.99	0.94
W/TEEP250	30	UC	3.03	12.0	14.0	24	22	10.0	10.4	8.8	6.7	1.5	1.0	0.75	0.62	20	20	10.1	10.1	1.9	1.9	0.99	0.99	0.99	0.99
W/TEEP250	40	UC	4.88	14.0	15.5	25	24	17.7	14.1	8.4	7.0	1.6	1.1	0.81	0.60	20	21	16.8	12.8	1.9	1.9	0.97	0.97	0.97	
W/TEEP250	50	UC	4.55	12.0	16.0	28	25	19.0	13.0	10.0	7.5	1.7	1.1	0.86	0.69	20	21	17.8	14.1	1.9	1.9	0.97	0.97	0.97	
W/TEEP250	60	UC	5.88	12.0	17.0	28	25	19.0	13.0	10.0	7.7	1.8	1.1	0.89	0.71	20	24	17.0	14.1	1.9	1.9	0.97	0.97	0.97	

Spraying Systems Co. TeeJet Tips and Nozzles

Tips and Nozzles		Size	Orifice Insert/Tip Body Material	Example Tip No.	Price each
	XR TeeJet Extended Range Tips (Tapered Flat Spray)	-01 and larger	Stainless Steel/ Celcon	XR8001-VS	\$6.46
	AIXR Air Induction Flat Spray	all sizes	UHMWPE Poly- mer (110° only)	AIXR11004-VP AIXR110 08+	\$6.70 \$7.90
	Turbo TeeJet Spray Tip (Wide Angle Flat Spray)	all sizes	Polymer (110° only)	TT11001-VP TT110 10+	\$6.10 \$7.30
	Turbo TeeJet Induction Air Induction Spray Tip	all sizes	Polymer (110° only)	TTI11004-VP TTI110 08+	\$10.40 \$12.20
	AI Turbo TwinJet Twin Flat Spray Tip	all sizes	Polymer (110° only)	AITTJ60-11004-VP AITT111 08+	\$7.60 \$8.80
	Turbo TwinJet			TTJ60-11004VP	\$7.30
	TwinJet Spray Tips (Twin Tapered Flat Spray)	all sizes	Stainless Steel/ Celcon	TJ60-8003-VS	\$11.20
	Turbo FloodJet Spray Tips (Wide Angle Flat Spray)	all sizes	Stainless Steel/ Celcon w/ Poly- mer Pre-Orifice	TF-VS4	\$12.10
	A1 TeeJet Spray Tips (Tapered Flat Spray) VisiFlo Color Coded	-015 thru -10	Stainless Steel/ Celcon	AI110015-VS	\$12.30
	TeeJet Orifice Plates	all sizes	Stainless Steel	CP4916-49	\$2.98
	Blank Disc	one size fits all	Polypropylene		35¢

	Nozzle Strainers			Check Valve Strainers			
	Part No.	Descr.	Price	Part No.	Descr.	Price	
	SN 50	50 Mesh	\$1.20	4193A-PP-50	50 Mesh	\$4.80	
SN 100	100 Mesh	\$1.20	4193A-PP-100	100 Mesh	\$4.80		

TriggerJet Spray Gun

Features:

- ◆ 15" extension wand
- Includes ConeJet spray tips with a 30° offset
- Trigger lock permits locking gun in an open position for continuous flow
- Replaceable internal working components
- Maximum operating pressure--100 psi (7 bar)
- 3/8" hose shank connection
- Accepts all standard Spraying Systems Co. spray tips and tip strainers
- Lightweight design for use with backpack, canister or other low-pressure sprayers



\$16⁵⁰

Spray Gun



#1700-02-013

13" Super-Jet Aluminum Trigger Spray Gun with thermal plastic handle and dripless shut-off at nozzle.

1" aluminum barrel, 800 psi, 8 GPM and #5 hardened stainless steel D-disc.

1/2" female pipe thread.

#1700-02-013 TriggerJet

\$49⁸⁰

No. 5500 Adjustable Tips

Polypropylene or Brass



Adjustable ConeJet Tips fit standard TeeJet Spray Nozzle body.

#5500-X__ Brass Adjustable Tip..... \$18.60
 #5500-PPB-X__ Polypropylene Adjustable Tip.. \$8.80

TriggerJet #22670 Spray Gun



22670 Trigger Jet

Trigger Jet No.	Extension Length	List Price
22670-PP-15-1/4	15"	\$43.30

Features:

The **22670 TriggerJet spray gun kit** combines the 22650 TriggerJet spray gun with an extension wand and the items listed in features. Maximum pressure rating 150 psi (10 bar).

- 22650 TriggerJet spray gun with a 1/4" BSPT (F) thread inlet connection
- Trigger lock permits locking gun in an open position for continuous flow (optional)
- #22665, 15" extension wand
- 8079-50-PP tip strainer
- 5500-PPB-X8-VI adjustable ConeJet spray tip with Viton® o-ring
- CP22673-PP 45° and CP22664-PP straight adapters (other capacities available)
- Accepts all standard Spraying Systems Co. spray tips and tip strainers

RECTANGULAR TANKS



20 Gallon Tank
14" x 28" x 12"
\$134³⁰

12 Gallon Tank
14" x 18" x 12"
\$100²⁰

POLY TANKS

SPOT SPRAYER TANKS



15 Gallon
14" x 30" x 14"
\$62⁰⁰

25 Gallon
18" x 34" x 18"
\$82⁰⁰



2½-Gallon Rectangle
7" x 15" x 14"
\$51⁴⁰

CONE BOTTOM TANKS

5 Gallon Square
11" x 11" x 20"
\$79⁵⁸

10 Gallon Square
13" x 13" x 21"
\$131²⁰



60 Gallon
24" x 36" x 26"
\$112¹⁴

40 Gallon
24" x 36" x 19"
\$92⁰⁶



3½-Gallon Round
11" x 16"
\$65⁶⁸

THREAD SEALANTS



Teflon Tape, 1/2" x 520"
\$1.35



Teflon Thread Sealant

4 oz. can \$15.90
8 oz. can \$27.60
2 oz. tube \$ 8.40

HOTLINE

Defoamer/Anti-Foaming Agent



Prevents foam over and foam damage to chemical when filling/mixing. Spray to knock down foam or pretreat to prevent production

1 gallon **\$55⁰⁰**

NEUTRA-CHEM

Tank and Equipment Cleaner

Designed for cleaning tanks, lines and nozzles to remove pesticide, herbicide and fertilizer residues.



2 lb. container ... **\$15⁹⁰**



Inductors

Inductors	Tank w/ Stand	Tank, Stand, Valves, and Rinse Nozzle
15 gallon	\$228 ⁰⁰	\$338 ⁰⁰
30 gallon	\$270 ⁰⁰	\$380 ⁰⁰
60 gallon	\$453 ⁰⁰	\$563 ⁰⁰
85 gallon	\$498 ⁰⁰	\$608 ⁰⁰

Blow Molded Inductor Tank Sets

Tank Sets	Tank w/ poly legs	Tank, Legs, Valves, and Rinse Nozzle
35 gallon	\$220 ⁰⁰	\$330 ⁰⁰
60 gallon	\$257 ⁰⁰	\$367 ⁰⁰



Installs on the discharge side of a pump, which keeps pump and water tank free of chemical contamination.

Plumbed to bypass inductor for faster transferring of water only.

2" barbed fittings, standard

Venturi Kit

\$398⁰⁰



Measuring Pitcher

128 oz.

\$19.80



Boom Wheel Kit

\$255⁰⁰ / pair

Applicable to most spray booms.

