

WPFGB ABRIDGED RULES - ARCHERY - Page 1

GUIDING BODIES

World Police and Fire Games Federation (WPFGB)
8304 Clairemont Mesa Blvd., # 107, San Diego, CA 92111
Tele. (858) 571-9919 FAX: (858) 571-1641 E-MAIL: 4info@cpaf.org

World Archery Previously known as Federation Internationale de Tir a L'Arc (FITA)
Ave de Cour 135, 1007 Lusanne, Switzerland.
Tele: +41-21-614-3050 FAX: +41-21-614-3055
E-Mail: fita@worldcom.ch

EVENTS

Archery at the World Police and Fire Games 2015 shall be presented in three events; Target Archery, Field Archery and 3D Field Archery Competitions. Awards for all events shall be by bow class, gender and adult age whereby adult Athletes of Open Age and 50 years or over on the date of the competition can enter by gender for their bow class.

1. TARGET ARCHERY COMPETITION (WPFGB/FITA/IFAA Rules)

Consists of one 900 ROUND. 30 arrows (Five-6 arrow ends) shot at each distance of 60m (65.61 yds), 50m (54.68 yds), 40m (43.74 yds), all shot on 122cm (48") target face.

Practice Range will be available on the day prior to the Competition.

2. FIELD ARCHERY COMPETITION (WPFGB/FITA/IFAA Rules)

Consists of one 28 Mixed FITA Field Round. [The organisers reserve the right to increase the number of targets to 32 to accommodate additional athletes if numbers dictate.

Practice Targets will be available on the morning the Competition.

3. 3-D ROUND (WPFGB/FITA/IFAA Rules)

Consists of one 25 Target Round, with "life-size" animal targets.

Practice Targets will be available on the morning the Competition.

BOW CLASSES: Each competition (Target, Field and 3-D) is a separate tournament with awards in each of the following IFAA Bow Style classes:

BAREBOW COMPOUND	FREESTYLE LIMITED RECURVES
FREESTYLE LIMITED	FREESTYLE UNLIMITED
BOWHUNTER	BOWHUNTER FREESTYLE UNLIMITED
BOWHUNTER FREESTYLE LIMITED	TRADITIONAL

The Organizers reserve the right to combine Bow Classes where participant numbers are low.

WPFG ABRIDGED RULES - ARCHERY - Page 2

NOTE: Freestyle classes allow mechanical releases. Freestyle Limited classes prohibit the use of release aids.

The maximum bow weight in all classes will be 60lbs

Bow Class Ready Reckoner:

Bow Class No.:	1	2	3	4	5	6	7	8
Bow Class:	Barebow Compound	Freestyle Limited Recurve	Freestyle Limited	Freestyle Unlimited	Bowhunter	Bowhunter Freestyle Unlimited	Bowhunter Limited	Traditional
Bow Class Abbreviation:	BBC	FSR	FSC	FU	BH	BFU	BL	T
Arrow Speed: <300 ft/sec (91.5 m/s)	✓	✓	✓	✓	✓	✓	✓	✓
<=12 Inch, 305mm, Stabiliser	✓	✓	✓	✓	✓	✓	✓	
>12 Inch Stabiliser	✓	✓	✓	✓				
Sliding Sight		✓	✓	✓				
Scope		✓	✓	✓				
Level	✓	✓	✓	✓				
Clicker	✓	✓	✓	✓				
1-3 Pin Sight		✓	✓	✓				
4-5 Pin Sight		✓	✓	✓		✓	✓	
Arrow Rest	✓	✓	✓	✓	✓	✓	✓	
Peep Sight		✓	✓	✓		✓	✓	
Kisser Button	✓	✓	✓	✓	✓	✓	✓	
Fixed Nock Locators	✓	✓	✓	✓	✓	✓	✓	✓
Release Aid				✓		✓		
Tab or Glove	✓	✓	✓	✓	✓	✓	✓	✓
String Silencer	✓	✓	✓	✓	✓	✓	✓	
Plastic Vanes	✓	✓	✓	✓	✓	✓	✓	
Feather Vanes	✓	✓	✓	✓	✓	✓	✓	✓
Stringwalking	✓	✓	✓	✓				✓
3 Fingers Below, Index Finger to touch Arrow	✓	✓	✓	✓	✓	✓	✓	✓
Mediterranean Split Release	✓	✓	✓	✓	✓	✓	✓	✓
Carbon/ Aluminium Arrows	✓	✓	✓	✓	✓	✓	✓	
Wooden Arrows								✓

Key: Allowed but not seen as standard Either/ or. Not both Level and Clicker not above Arrow

WPFGB ABRIDGED RULES - ARCHERY - Page 3

PARTICIPANTS

As stated previously, awards for all events shall be by bow class, age and gender. Athletes 50 years or over on the date of the competition can enter by gender for their bow class.

There are therefore four Age Categories: OPEN FEMALES,
 OPEN MALES,
 50+ FEMALES,
 50+ MALES

Athletes can now compete in any one of Bow Classes, in each of the three Archery Events of Target, Field and 3D Rounds.

EQUIPMENT

TARGETS:

TARGET COMPETITION: 122cm (48") round multi-colored targets are required. One target for each four competitors. Targets and range are to be laid out in compliance with FITA rules.

FIELD COMPETITION: Targets and range for Field Round must conform to FITA [or national/state affiliate] rules & laid out as directed. Field Competition Targets are to be prepared with stiff backing.

3-D COMPETITION: 3-D "life-size" animal targets to FITA rules

Inspection: All equipment, including competitor's personal equipment, must be to the satisfaction of the appropriate Tournament Chairman prior to commencement of competition.

Range Layout: 900 Round Range and Field Archery Range must be laid out in compliance with FITA/WPFGF or [national/state affiliate] Rules.

BRACKETING

Point System bracket: See Bracketing Rules. All bracketing must meet WPFGF rule requirements.

SCORING

Scoring shall be in accordance with the FITA/WPFGF rules in existence at the time of the tournament. The total score of each bow class in each event will be collected for ranking.

WPMFG ABRIDGED RULES - ARCHERY - Page 4

GENERAL SPORT RULES for Archery

Order of shooting: Only one competition is to be shot each day.

There shall be no break in shooting, for lunch (except the FITA 900 competition) or any non-emergency reason, or unless weather conditions would dictate a break in the shooting.

Each competition (Field, Target & 3-D) is a separate tournament and is scored separately.

Practice Targets: Practice shall not be allowed on the competition field of the Field Round. For the Target Archery Range, competitors practice on the competition range.

Practice on the day of the competition shall take place on the tournament range.

- This practice shall be for a minimum of 20 minutes and a maximum of 45 minutes on the day(s) of the Competition.
- Practice ends with the pulling of the practice arrows.
- The practice targets shall be set up at the first distance to be shot by each class.

No alcoholic beverages may be carried or consumed on any range or practice area by anyone during shooting hours. WPMFGF rules apply.

Officials shall warn all archers prior to practice and/or competition that any competitor drawing a bow with the bow hand above the top of the head, when drawing on a horizontal plane, shall be immediately disqualified from further use of the range.

No archer shall draw a bow with the bow hand above the top of the head when drawing on a horizontal plane. He/She shall be disqualified from further use of the range whether it is for practice or competition. The judgment of any official making the call shall be final.

The competition for the WPMFG will consist of three separate Rounds: FITA 900 Target Round, 28 Mixed FITA Field Round and a FITA 25 Target 3-D Round. Each Round is a separate competition with separate medals awarded to winners.

A competitor may enter one, two, or all three rounds.

A competitor may shoot the same equipment for all Rounds, or change styles for different rounds.

WPFG ABRIDGED RULES - ARCHERY - Page 5

1.0 TARGET ROUND COMPETITION – FITA 900

1.1 The round shall comprise of one 900 Round: 30 arrows (Five - 6 arrow ends) shot at each distance of 60m (65.61 yds), 50m (54.68 yds), 40m (43.74 yds), all shot on 122cm (48 in) target face.

1.1.1 Target Face

The diameters of the target face is 122cm. (freestyle unlimited compounds may choose a half target)

The line marking the outermost edge of the white shall not exceed 2mm in width and shall be entirely within the scoring zone.

The target face is divided as follows:

(i) Each colour zone is divided into two zones of equal radial width

(ii) The resulting central zone is further divided into two zones of equal radial width.

(iii) The dividing lines shall not exceed 2mm in width and shall be entirely within the higher scoring zone.

(f) The centre of the gold is termed the 'pinhole and shall be marked with a small cross

(x) the lines of which shall not exceed 2mm in width.

(g) Tolerances on the diameter of each scoring zone on both target faces are permitted as follows:











(i) Gold zones and Inner Red zone – } 1mm

(ii) All other zones – } 3mm

Recurve and barebow/traditional archers will shoot at the full 122 cm target.

Compound (freestyle unlimited), archers will have a choice of shooting on either the full target or on a target with only the yellow and red. On the half-size target, one or two archers will be on each target.

1.1.2 Scoring Zones

Zone		Points
Inner 10		Record as X, Score value 10
Inner Gold		10
Outer Gold		9
Inner Red		8
Outer Red		7
Inner Blue		6
Outer Blue		5
Inner Black		4
Outer Black		3
Inner White		2
Outer White		1

WPFG ABRIDGED RULES - ARCHERY - Page 6

1.1.3 There is a time limit for an athlete to shoot an end.

- The maximum time permitted for an athlete to shoot an end of six arrows is four minutes.
- An arrow shot before the start signal or after the stop signal shall cause the athlete to lose the highest scoring arrow of that end which shall be scored as a miss.
- If an athlete, while drawing the bow with an arrow on the competition field after the Director of Shooting has officially closed the practice session (which is after the pulling of the practice arrows); or before the shooting starts, or during the breaks between distances or rounds and releases the arrow, intentionally or otherwise, this shall cause the athlete to lose the highest scoring arrow of the next scoring end. The scorer shall enter the values of all arrows of that end, but the highest scoring arrow shall be forfeited. This entry on the scorecard shall be initialled by a Judge and the athlete concerned.

1.1.4 Equipment Failure

In the event of an equipment failure, verified by a Judge, or a medical issue, verified by medical personnel, extra time may be given to make the necessary repairs, change the damaged equipment or for medical personnel to determine the problem and decide whether or not the athlete is fit to continue competing unassisted.

However the maximum time for make up arrows to be shot is 15 minutes (following regular order of shooting and timing). The athlete shall make up the appropriate number of arrows at the earliest opportunity under the supervision of a Judge.

- In the event of an equipment failure the athlete shall call a Judge while stepping back from the shooting line.
- The order of shooting may be changed temporarily for the purpose of an equipment repair or for medical treatment.

1.1.5 Athletes may not raise the bow arm until the signal to start shooting is given.

1.1.6 Except for persons with disabilities, athletes shall shoot from a standing position and without support, with their body above the shooting line.

1.1.7 Under no circumstances may an arrow be re-shot.

An arrow may be considered not to have been shot if:

- The arrow falls from the bow or is mis-shot and a part of the arrow shaft lies within the zone between the shooting line and the 3m line, and provided the arrow has not rebounded;
- The target face or butt blows over. The Judges shall take whatever measures they deem necessary, and compensate adequate time for shooting the relevant number of arrows. If the butt only slides down, it shall be left to the Judges to decide what action to take, if any.

WPFG ABRIDGED RULES - ARCHERY - Page 7

- 1.1.8 No athlete may touch the equipment of another without the latter's consent. Serious cases may lead to penalties being applied.
- 1.1.9 No smoking is allowed in or in front of the athletes' area.
- 1.1.10 The Director of Shooting shall be advised if an athlete, when drawing back the string of his bow uses any technique which, in the opinion of the Judges, could allow the arrow, if accidentally released, to fly beyond a safety zone or safety arrangements (overshoot area, net, wall etc.). If an athlete persists in using such a technique, he shall, in the interest of safety, be asked by the Chairperson of the Tournament Judge Commission or the Director of Shooting to stop shooting immediately and to leave the field.
- 1.1.11 No athlete may draw his/her bow, with or without an arrow, except when standing on the shooting line. If an arrow is used, the athlete shall aim toward the target butts, but only after being satisfied that the range is clear both in front of and behind the target butts.

1.2 ORDER OF SHOOTING AND TIMING CONTROL - TARGET ARCHERY

- 1.2.1 One, two or three athletes may shoot on the same target butt simultaneously.
- If four athletes shoot in pairs on a target butt, the rotation shall be AB-CD, CD-AB, AB-CD, etc.
 - Position on the shooting line will be assigned by the tournament committee.

1.2.2 VISUAL AND ACOUSTIC TIME CONTROL.

Shooting will be controlled by a timing system.

- The clock is set for 4 minutes, 10 seconds. Two beeps will sound. Archers will have 10 seconds to go to the shooting line.
 - A single beep indicates shooting to begin at 4:00. Archers should leave the line when each has finished shooting.
 - When the clock reaches 0:00, two beeps will sound for the second line to go to the target, and a single beep after 10 seconds to begin shooting,
 - When the clock reaches 0:00, three beeps indicate advancing to the target to score and pull arrows.
- 1.2.3 No athlete shall occupy the shooting line except when the appropriate signal has been given.
- 10 seconds shall be allowed for the athletes to leave and the next designated athletes to occupy the shooting line. This shall be indicated by two sound signals.
- 1.2.4 If the shooting is suspended during an end for any reason, the time limit shall be adjusted.
- 40 seconds per arrow shall be given for each arrow.
 - An athlete arriving after shooting has started shall forfeit the number of arrows already shot, unless the Chair of the Tournament Judges Commission, or his designee, is satisfied that the athlete was delayed by circumstances beyond his control. In this

WPFG ABRIDGED RULES - ARCHERY - Page 8

case the athlete shall be allowed to make up the lost arrows after the distance then being shot is completed, but in no circumstances may that be more than 12 arrows.

- 1.2.5 While shooting is in progress, only those athletes whose turn it is to shoot or who have a classified disability may be on the shooting line.
- All other athletes, with their equipment, shall remain behind the waiting line. After an athlete has shot his arrows, he shall immediately retire behind the waiting line. The athlete may leave the spotting scope on the shooting line between ends providing it does not create an obstacle for any other athlete.

1.3 SCORING – TARGET ROUND

- 1.3.1 Neither the target nor the arrow shall be touched until scoring is completed.
- Targets will be scored in groups of 3 or 4 archers. If there are less than 3 archers on a target, they may be combined with another target.
 - Within the scoring group, one archer will call the arrow values for each archer, high value to low value.
 - Two archers will record the arrow values on separate score cards. The arrow values will be totalled and the running total added by each scorer, then compared.
 - If there is a disagreement concerning the value of an arrow, the Judge makes the final decision.
 - Athletes with disabilities may have an Agent to assist with scoring and pulling arrows if they cannot go to the target.
 - Each arrow hole shall be marked before the arrow is pulled.
- 1.3.2 An arrow shall be scored according to the position of the shaft in the target face. If the shaft of an arrow touches two colours, or touches any dividing lines between two scoring zones, that arrow shall score the higher value of the two zones involved.
- Neither the arrows nor the target face shall be touched until the value of all the arrows on that target face has been recorded.
 - If more than the required number of arrows should be found in the target butt or on the ground near the butt, or in the shooting lanes, only the lowest six in value shall be scored. Athletes found to repeat this offence may be disqualified.
 - If a fragment of a target face is missing, including the dividing line or where two colours meet, or if the dividing line is pushed aside by an arrow, a line judge will determine the value of the arrow.
 - All arrow holes in the scoring zone shall be suitably marked by the athletes every time the arrows are scored and drawn from the target face by 2 marks at 12 & 3 O'clock.
 - Arrows embedded in the butt and not showing on the face can only be scored by a Judge.
 - An arrow hitting: The target butt and rebounding or hanging from the target, shall score, in the case of a rebound arrow, according to the mark it makes on the target face, provided that all the other arrow holes have been marked and an unmarked hole or mark can be identified and, in the case of a hanging arrow, as it lies in the target face.
 - When a rebound or hanging arrow occurs: All athletes on that target butt shall stop shooting but remain on the shooting line, calling a Judge; When all athletes on the

WPFG ABRIDGED RULES - ARCHERY - Page 9

shooting line for that end have finished shooting their arrows or the time limit has expired, whichever is appropriate, the Director of Shooting shall interrupt the shooting. The athlete with the rebound or hanging arrow shall go to the target butt together with a Judge, who shall decide the point of impact of the rebound arrow or determine the value of the hanging arrow, note the value, remove the hanging arrow and mark the hole. The Judge shall later participate in scoring that end. The rebound or hanging arrow is to be left behind the target butt until that complete end has been scored. When the field is clear, the Director of Shooting shall give the signal for those athletes on the target butt where the rebound or hanging arrow occurred to continue shooting; These athletes shall complete their end of three or six arrows, before general shooting or scoring is resumed. No other athlete is to occupy the shooting line.

- If the arrow hits the target butt and passing completely through the butt, provided all arrow holes have been marked and provided an unmarked hole can be identified, shall score according to the value of the unmarked hole in the target face.
- If the arrow hits another arrow in the nock and remaining embedded therein shall score the same value as the arrow struck.
- If the arrow hits another arrow and deflecting into the target face shall score as it lies in the target face.
- If the arrow hits another arrow, and then rebounding, shall score the value of the struck arrow, provided the damaged arrow can be identified.
- If the arrow hits a target face other than an athlete's own target face shall be considered part of that end and score as a miss.
- If the arrow hits outside the outermost scoring zone of the target face shall score as a miss.
- An arrow found on the ground in the shooting lane or behind the target butt, which has been claimed as a bouncer or pass through, shall, in the opinion of the Judge(s), have first hit the target butt. If more than one unmarked hole is located in the scoring zone of the target face after a bouncer or pass through has occurred, the value of the lowest scoring hole shall be given to the athlete;
- A miss shall be recorded as "M" in the scorecard.

1.3.3 The Director of Shooting shall see that, wherever possible following scoring, no arrows are left in the target butts before any signal is given to continue shooting.

- If arrows are accidentally left in the target butt, the shooting shall not be interrupted. An athlete may shoot that end with other arrows or make up the arrows lost after shooting over that distance has been completed. A Judge shall participate in the scoring of that end, making sure that the arrows which have remained in the target butt from the previous end were entered in the athlete's scorecard before any arrows are withdrawn from the target butt.
- In the event of an athlete leaving arrows he may use others provided a Judge is informed before shooting begins.

1.3.4 At the completion of the competition, scorecards shall be signed by the scorer and the athlete, indicating that the athlete agrees with the value of each arrow, the sum total, the number of 10s and the number of Xs. If the scorer is also the archer, his/her scorecard shall be signed by another athlete in the scoring group.

WPFG ABRIDGED RULES - ARCHERY - Page 10

- Each target will have two scorecards one of which may be electronic. If there is a discrepancy in the arrow values between an electronic and a paper score card, the paper card will take precedence.
- The organisers are not required to accept or record scorecards that have not been signed, and/or do not contain the sum total, and/or the number of 10s and/or the number of Xs and/or which contain mathematical errors.
- The organisers or officials are not required to verify the accuracy of any submitted scorecard, however if the organisers or the officials note an error, they will correct such error and the result as corrected will stand. Any such corrections must occur before the next stage of competition. Should a discrepancy be found in the sum total where: two paper scorecards are used, the sum total of the lower arrow scores will be used for the final result; one paper scorecard and one electronic scorecard are used, the sum total of the paper scorecard will be used for the final result unless the sum total reflected on the scorecard is greater than the actual score (in which case the lower actual score is used).

1.3.5 In the event of a tied score, the ranking of the results shall be determined in the following order.

- Greatest number of 10s (including inner 10s);
- Greatest number of Xs (inner 10s);
- After this, athletes still tied shall be declared equal.

1.3.6 At the end of the tournament the Organising Committee shall publish complete result lists.

1.4. PRACTICE

1.4.1 Practice on the day of the competition shall take place on the tournament range.

- This practice shall be for a minimum of 20 minutes and a maximum of 45 minutes on the day(s) of the Competition.
- The practice targets shall be set up at the first distance to be shot by each class.

1.5. QUESTIONS AND DISPUTES

1.5.1 Any athlete on the target butt shall refer any questions about the value of an arrow in the target face to a Judge before any arrows are drawn.

- A mistake in the recording of arrow values shall be corrected by the Judge before the arrows are pulled.
- Should range equipment be defective or a target face become unreasonably worn or otherwise damaged, an athlete may appeal to the Judges to have the defective item replaced or remedied.

1.5.2 Questions concerning the conduct of the shooting or the conduct of an athlete shall be lodged with the Judges before the next stage of the competition.

- Questions regarding any published results shall be lodged with the Judges without any undue delay, and in any event shall be lodged in time to allow corrections to be made before the prize giving.

WPFG ABRIDGED RULES - ARCHERY - Page 11

1.6. APPEALS

- 1.6.1 In the event of an athlete not being satisfied with a ruling given by the Judges, he may, except as provided for in “Questions and Disputes” above, appeal to the Jury of Appeal.
- 1.6.2 Trophies or prizes which may be affected by a dispute shall not be awarded until the Jury ruling has been given.
- The decision by the Judge on the value of an arrow before the withdrawal from the target face is final.
 - The decision of the Jury is final it cannot be appealed.

WPFG ABRIDGED RULES - ARCHERY - Page 12

2.0 FIELD ROUND COMPETITION

2.1 MIXED FITA ROUND

The course will comprise of marked and unmarked targets at various distances in accordance with the table below.

Unit for Marked Course

Number of Targets	Diameter of Field Faces in cm	<i>Distances in Metres</i>	
		Blue Post	Red Post
3	Ø20	5 - 10 - 15	10 - 15 - 20
3	Ø40	10 - 20 - 25	20 - 25 - 30
3	Ø60	30 - 35 - 40	35 - 40 - 45
3	Ø80	40 - 45 - 50	50 - 55 - 60

Unit for Unmarked Course

Number of Targets	Diameter of Field Faces in cm	<i>Distances in Metres</i>	
		Blue Post	Red Post
4	Ø20	5 - 10	10 - 15
4	Ø40	10 - 20	15 - 25
4	Ø60	15 - 30	20 - 35
4	Ø80	30 - 45	35 - 55

- 2.1.1 Each athlete shall shoot from the shooting peg without compromising safety.
- 2.1.2 The organisers shall assign the target at which each group shall start shooting.
- 2.1.3 In Field the athlete can stand or kneel up to approximately 1m in any direction beside or behind the shooting peg, taking into consideration the condition of the terrain. In exceptional circumstances a Judge may give permission to shoot from outside the defined area. Every shooting position shall have a shooting peg or mark to accommodate at least two athletes.
- 2.1.4 Athletes within a group waiting for their turn to shoot shall wait well back behind the athletes in the shooting position. (Athletes shall not cross the target waiting number)
- 2.1.5 Athletes shall wait well behind the athletes in the shooting position unless they are assisting the athletes at the shooting peg with shading.
- 2.1.6 Athletes/ may use binoculars to examine the target prior to shooting and at the shooting peg before shooting the arrow. The use of binoculars is allowed after having finished shooting the arrow.

WPGF ABRIDGED RULES - ARCHERY - Page 13

2.1.7 No athlete may approach the target until all athletes of the group have finished shooting, unless given permission by a Judge.

2.1.8 Under no circumstances may an arrow be re-shot.

An arrow shall not be considered to have been shot if:

The athlete can touch it with his bow without moving his feet from their position, and provided the arrow has not rebounded;

The target face or falls over. The Judges shall take whatever measures they deem necessary, and permit time for shooting the relevant number of arrows. If the target or butt only slides down it shall be left to the Judges to decide what action to take, if any.

2.1.9 No athlete may disclose the target distances to anybody on unmarked courses during the tournament.

2.1.10 There is to be no discussion of distances among the athletes of a group until the target has been scored.

WPGF ABRIDGED RULES - ARCHERY - Page 14

2.1 GENERAL ORDER OF SHOOTING AND TIMING CONTROL IN FIELD ROUNDS

- 2.2.1 Should the number of athletes exceed the normal capacity of the course, additional groups shall be formed and placed in the field as is convenient. Additional groups assigned to a target shall wait until the primary group on that target has shot and scored their arrows before proceeding.
- 2.2.2 The athletes number is to be prominently displayed on the athletes quiver or thigh and is to be visible from behind the shooting post at all times while shooting is in progress. Athletes shall be allocated targets and shooting positions according to their order of draw and subsequent placement from the top to the bottom on the start list.
- 2.2.3 In case of equipment failure the order of shooting may be temporarily changed. In any case no more than 30 minutes shall be allowed to repair any equipment failure. The other athletes in that group shall shoot and score their arrows before allowing any following groups to shoot through. If the repair is completed within the time limit, the athlete in question may make up any arrows remaining to be shot on that target. If the repair is completed later, the athlete may rejoin his group but shall lose the arrows his group has shot in the meantime.
- 2.2.4 In the case of an athlete being unable to continue shooting because of a medical reason which occurred after the beginning of the shoot, the same provisions apply.
- 2.2.5 Athletes in a group may allow other groups to shoot through, provided the organisers or the Judges are notified about the change.
- 2.2.6 When an athlete, or a group of athletes, is causing undue delay for that group or for other groups the Judge observing this shall warn the athlete or group with a first written warning on the scorecard, after which he or a fellow Judge may time the athlete, or group throughout the remainder of that round of the competition.
- 2.2.7 In that case a time limit per target of three minutes rounds shall be allowed from the time the athlete takes his position at the shooting peg, which he shall do as soon as possible after the shooting position becomes available.

A Judge, having observed an athlete exceed the time limit despite the above procedure, shall caution him verbally and give a second written warning indicating the time and date of the warning.

At the third and all subsequent warnings during that stage of the competition, the athlete shall lose the highest scoring arrow at the target.

- 2.2.8 The time limit may be extended in exceptional circumstances.
- 2.2.9 No shooting shall be allowed after the time limit has expired.

WPFG ABRIDGED RULES - ARCHERY - Page 15

- 2.2.10 If an athlete shoots an arrow after the Judge has stopped the shooting, the athlete shall lose the highest scoring arrow at the target.
- 2.2.11 Athletes shall shoot in groups of no more than four, but never fewer than three. Groups should be of even numbers as far as possible.
- 2.2.12 Each group shall shoot in pairs, rotating as follows:
- The Organising Committee shall assign shooting positions;
 - The first pair (with lowest athlete number(s)) shall start the shooting on the first target assigned to the group;
 - The other pair shall start shooting at the next target. The pairs shall rotate shooting at all subsequent targets throughout the competition;
 - If all athletes of the group agree they may change the above arrangement, pairing or shooting position;
- 2.2.13 If there are three athletes in a group the first two athletes on the start list (lowest athlete numbers) shall form the first pair, the third athlete shall be considered to be the second pair concerning rotation. He shall always shoot from the left side of the shooting peg.
- 2.2.14 Should there be sufficient room at a shooting peg, all athletes in the group may shoot at the same time.
- 2.2.15 Shooting at the blocks of 40cm faces: The four faces shall be placed in the form of a square. Of the pair of athletes whose turn it is to shoot first, the athlete on the left shall shoot at the top left hand face, while the athlete on the right shall shoot at the top right hand face. Of the pair of athletes whose turn it is to shoot second, the athlete on the left shall shoot at the lower left hand face, while the athlete on the right shall shoot at the lower right hand face.
- 2.2.16 Shooting at the blocks of 20cm faces: Of the pair of athletes whose turn it is to shoot first, the athlete on the left shall shoot at the faces in column 1, while the athlete on the right shall shoot at the faces in column 3. Of the pair of athletes whose turn it is to shoot second, the athlete on the left shall shoot at the faces in column 2, while the athlete on the right shall shoot at the faces in column 4. Each athlete shall shoot his arrows in any order, one at each face.
- 2.2.17 Groups shall be assigned to start simultaneously from various targets and shall complete the round at the target before the one at which they started.

WPGF ABRIDGED RULES - ARCHERY - Page 16

2.3 SCORING – FIELD ROUND

- 2.3.1 Scoring shall take place after all athletes in the group have shot their arrows. Unless otherwise agreed in the group, the group member with the lowest athlete number shall be the group leader and shall be responsible for the conduct of the group. The two athletes with the second and third lowest athlete numbers shall be the scorers and the fourth athlete shall mark the arrow holes if applicable.
- 2.3.2 In a group of three, the group leader shall also mark the arrow holes if applicable.
- 2.3.3 In Field rounds, the group of athletes shall not leave the target before all holes in the scoring zone are marked.
- 2.3.4 Scorers shall enter on the scorecard alongside the correct number of the target, and in descending order if applicable, the value of each arrow as called by the athlete to whom the arrow(s) belong. Other athletes in the group shall check the value of each arrow called. A mistake on the scorecard discovered before the arrows are drawn may be corrected. (All archers should initial the back of the score card indicating their agreement to the corrections and the target number should also be recorded)
- 2.3.5 An arrow shall be scored according to the position of the shaft in the target. Should the shaft of an arrow touch two zones or a dividing line between scoring zones, that arrow shall score the higher value of the zones affected.
- 2.3.6 None of the arrows shall be touched until all arrows on that target have been recorded and scores checked.
- 2.3.7 Should a fragment of a target (face) be missing, including a dividing line (or where two colours meet), or if the dividing line is displaced by an arrow, then an imaginary line shall be used for judging the value of any arrow that may hit such a part.
- 2.3.8 Arrows embedded in the target and not showing on the face can only be scored by a Judge.
- 2.3.9 In case of a rebound or pass-through the scoring shall take place as follows:
- If all of the athletes in that shooting group agree that a rebound or pass-through has occurred, they may also agree on the value of that arrow;
 - In Field rounds if they cannot agree on the value of the arrow, the athlete shall be awarded the value of the lowest unmarked arrow hole in the scoring zone;
 - If an arrow hits another arrow in the nock and remaining embedded therein shall score according to the value of the arrow struck.
 - If an arrow hits another arrow, and then hitting the target after deflection, shall score as it lies in the target.
 - If an arrow hits another arrow, and then rebounding shall score the value of the arrow struck, provided the damaged arrow can be identified.

WPFG ABRIDGED RULES - ARCHERY - Page 17

- If an arrow hits a target face other than the athlete's own target face shall be considered as part of that end and shall score as a miss.
 - If an arrow hits outside the outermost scoring zone of the target face shall score as a miss.
 - A miss shall be recorded as "M" on the scorecard.
- 2.3.10 If more than three arrows for Field rounds belonging to the same athlete should be found in the target or on the ground of the shooting lane, only the three lowest arrows shall be scored. Should an athlete be found to repeat this he may be disqualified.
- 2.3.11 If two or more arrows are shot in the same 20cm target face, they shall be considered as part of that end but only the arrow with the lower value shall score. The other arrow, or arrows, in the same face shall score as a miss, or as misses.
- 2.3.12 Tied scores are ranked using:
- Greatest number of 5's and 6's;
 - Greatest number of 6's;
 - After this, athletes still tying shall be declared equal.
- 2.3.13 Scorecards shall be signed by the scorer and the athlete, denoting that the athlete agrees with the value of each arrow, the sum total (identical on both scorecards), the number of 5's and 6's. The scorer's scorecard shall be signed by another athlete of the same group but of a different Nation / Association.
- 2.3.14 The organisers shall not be required to accept or record scorecards that have not been signed, do not contain the sum total, the number of 5's or 6's or which contain mathematical errors. The organisers or officials are not required to verify the accuracy of any submitted scorecard however if the organisers or the officials note an error, they shall correct such error and the result as corrected shall stand. Should a discrepancy be found in the sum total, the sum total of the lowest arrow scores shall be used for the final result.
- 2.3.15 At the end of the tournament the Organising Committee shall publish complete result lists.

WPGF ABRIDGED RULES - ARCHERY - Page 18

2.4 SHOOTING CONTROL AND SAFETY

- 2.4.1 The chairperson of the Tournament Judges shall be in control of the tournament.
- 2.4.2 The chairperson of the Tournament Judges shall satisfy himself that safety precautions have been observed in the layout of the courses and arrange with the organisers for any additional safety precautions he may find advisable before shooting commences.
- 2.4.3 He shall address the athletes and officials on the safety precautions and any other matters concerning the shooting that he may judge to be necessary.
- 2.4.4 Should it become necessary to abandon a competition because of bad weather, loss of daylight or for reasons that would otherwise compromise the safety conditions of the courses, such a decision shall be made by the collective decision of the head of the Organising Committee, the chairperson of Judges and the tournament organiser.
- 2.4.5 An acoustic sign to be heard throughout all the courses shall be given at the start of each competition day and shall also be given when the competition has to be stopped.
- 2.4.6 Should the competition have to be abandoned prior to the completion the total score of the same targets shot by all athletes in a division shall be used to determine the champions in that division.
- 2.4.7 The tournament organising committee reserved the right to re-schedule or amend the tournament format to progress according to the time remaining and conditions of the venues, to determine the winners.
- 2.4.8 In case of blinding sunshine, protective shade of a maximum size of A4 (or legal letter size, about 30x20cm) may be provided by the other members of the group or shall be provided by the organiser.
- 2.4.9 No athlete may touch the equipment of another without the latter's consent.
- 2.4.10 No smoking is allowed on the courses, in the practice or warm-up areas.
- 2.4.11 When drawing back the string of his bow an athlete shall not use any technique which, in the opinion of the Judges, could allow the arrow, if accidentally released, to fly beyond a safety zone or safety arrangements (overshoot area, net, wall, etc.). If an athlete persists in using such a technique, he will, in the interest of safety, be asked by any of the tournament judges to stop shooting immediately and to leave the course. The athlete must aim and draw up at the target only.

WPFG ABRIDGED RULES - ARCHERY - Page 19

2.5 CONSEQUENCES OF BREAKING RULES

- 2.5.1 Set out below is a summary of the penalties or sanctions applied to athletes when rules are broken.
- 2.5.2 An athlete found guilty of breaking any eligibility rule may be disqualified from the competition and shall lose any position he may have gained.
- 2.5.3 An athlete found competing in a class laid down in ATHLETES EQUIPMENT of which he does not fulfil the requirements, shall be disqualified from the competition and lose any position gained.
- 2.5.4 An athlete found to have committed an Anti-Doping Rules violation shall be subject to sanctions as determined by the World Police and Fire Games
- 2.5.5 Any athlete found to be using equipment contravening World Police and Fire Games Rules may have his or her scores disqualified.
- 2.5.6 An athlete proved to have knowingly broken any rules and regulations may be declared to be ineligible to participate in the competition. The athlete shall be disqualified and shall lose any position he may have gained.
- 2.5.7 Un-sportsmanlike conduct shall not be tolerated. Such conduct by an athlete or anyone deemed to be assisting an athlete shall result in disqualification of the athlete or the person in question and may further result in suspension from future events
- 2.5.8 Anyone who alters without authorization, or falsifies, a score, or knowingly has a score altered or falsified, shall be disqualified.
- 2.5.9 If an athlete repeatedly withdraws arrow from the target before they are scored, he may be disqualified.
- 2.5.10 An athlete who persists in using a dangerous method of drawing the string in the opinion of the Judges, shall be asked by the officiating judge or the Tournament Organiser to stop shooting immediately and shall be disqualified.
- 2.5.11 Losing the score of arrow.
- In the case of an equipment failure, an athlete who is unable to repair his equipment within 30 minutes shall lose the number of arrows still to be shot on that target and those arrows shot by his group after that time until he rejoins his group.
 - In the case of a Judge's timing an athlete and observing him exceeding the time limit, at the third and all subsequent warnings during that stage of the competition, the athlete shall lose the highest scoring arrow at the target.
 - If more than three arrows for Field rounds or more than one arrow for 3D rounds belonging to the same athlete should be found in the target or on the ground in the

WPFG ABRIDGED RULES - ARCHERY - Page 20

shooting lane, only the three lowest arrows for Field rounds or lowest arrow for 3D rounds shall be scored.

- If two or more arrows are shot into one 20cm target face, all arrows shot shall count as part of that end but only the lower arrow shall score.
- An arrow not hitting a scoring zone or hitting a target face other than the athlete's own target face, shall be considered as part of that end and shall score as a miss.

2.6 WARNINGS

- 2.6.1 Athletes who have been warned more than once and who continue breaking the following World Archery rules or who do not follow decisions and directives (which can be appealed) of the assigned Judges, shall be treated according to Section 2.8
- 2.6.2 Athletes are responsible for their own score cards. Duplicate cards shall not be issued for any lost, damaged or stolen cards.
- 2.6.3 No smoking is allowed on the course and in the practice and warm-up areas.
- 2.6.4 No athlete may touch the equipment of another without the latter's consent.
- 2.6.5 Those athletes belonging to a following group waiting for their turn to shoot, shall remain in the waiting area until the athletes shooting have moved on and the shooting position is clear. There shall be no communication about distances between the different shooting groups.
- 2.6.6 While shooting is in progress, only the athlete whose turn it is to shoot may approach the shooting position.
- 2.6.7 No athlete may approach the target until all athletes of the group have finished shooting, unless authority is given by a Judge.
- 2.6.8 None of the arrows nor the target face, target or butt may be touched until all the arrows on that target have been recorded.
- 2.6.9 When drawing back the string of his bow, an athlete shall not use any technique which, in the opinion of the Judges, could allow the arrow, if accidentally released, fly beyond a safety zone or safety arrangements (overshoot area, net, wall etc.).

2.7 PRACTICE

- 2.7.1 At World Police and Fire Games events no practice shall be permitted on the courses set out for the competition.
- 2.7.2 On the days of the tournament, warm up targets shall be set up near the assembly point(s) for the athletes.

WPFG ABRIDGED RULES - ARCHERY - Page 21

2.8 QUESTIONS AND DISPUTES

- 2.8.1 Any athlete on the target shall refer any questions about the value of an arrow in the target face, before the arrows are drawn, to the competitors in the group. The majority opinion of the group shall decide on the value – if there is split decision (50/50) the arrow shall be given the higher value. That decision of the athletes is final.
- 2.8.2 A mistake on a scorecard may be corrected before the arrows are drawn, provided that all the athletes on the target agree on the correction. The correction shall be witnessed and initialled by all the athletes on the target. Any other disputes concerning entries on a scorecard shall be referred to a Judge.
- 2.8.3 Should it be discovered:
- That the size of a target face has been changed during the competition in Field rounds;
 - The position of a shooting peg has been moved after competing athletes have already shot the target;
 - The target is or has become unshootable for certain athletes because of hanging branches etc.
- 2.8.4 That target shall be eliminated for the purpose of score for all athletes of the division involved, should an appeal be upheld. If one or more target(s) is disqualified, the remaining number of targets shall be considered a full round.
- 2.8.5 Should range equipment be defective or a target become unreasonably worn or otherwise damaged, an athlete may appeal to the Judges to have the defective item replaced or remedied.
- 2.8.6 Questions concerning the conduct of the shooting or the conduct of an athlete shall be lodged with the Judges within 15 minutes of the last group completing the course.
- 2.8.7 Questions regarding any published results shall be lodged with the Judges without any undue delay, and in any event shall be lodged in time to allow corrections to be made before the prize giving.

2.9 APPEALS

- 2.9.1 In the event of an athlete not being satisfied with a ruling given by the Judges, he may appeal to the Jury of Appeal. Trophies or prizes which may be affected by a dispute shall not be awarded until the Jury of Appeal's ruling has been given.

TARGET FACE POSITIONING AND SCORING

1-6 Scoring Zones Target Face

Scoring Zones - 80 and 60cm Target Face

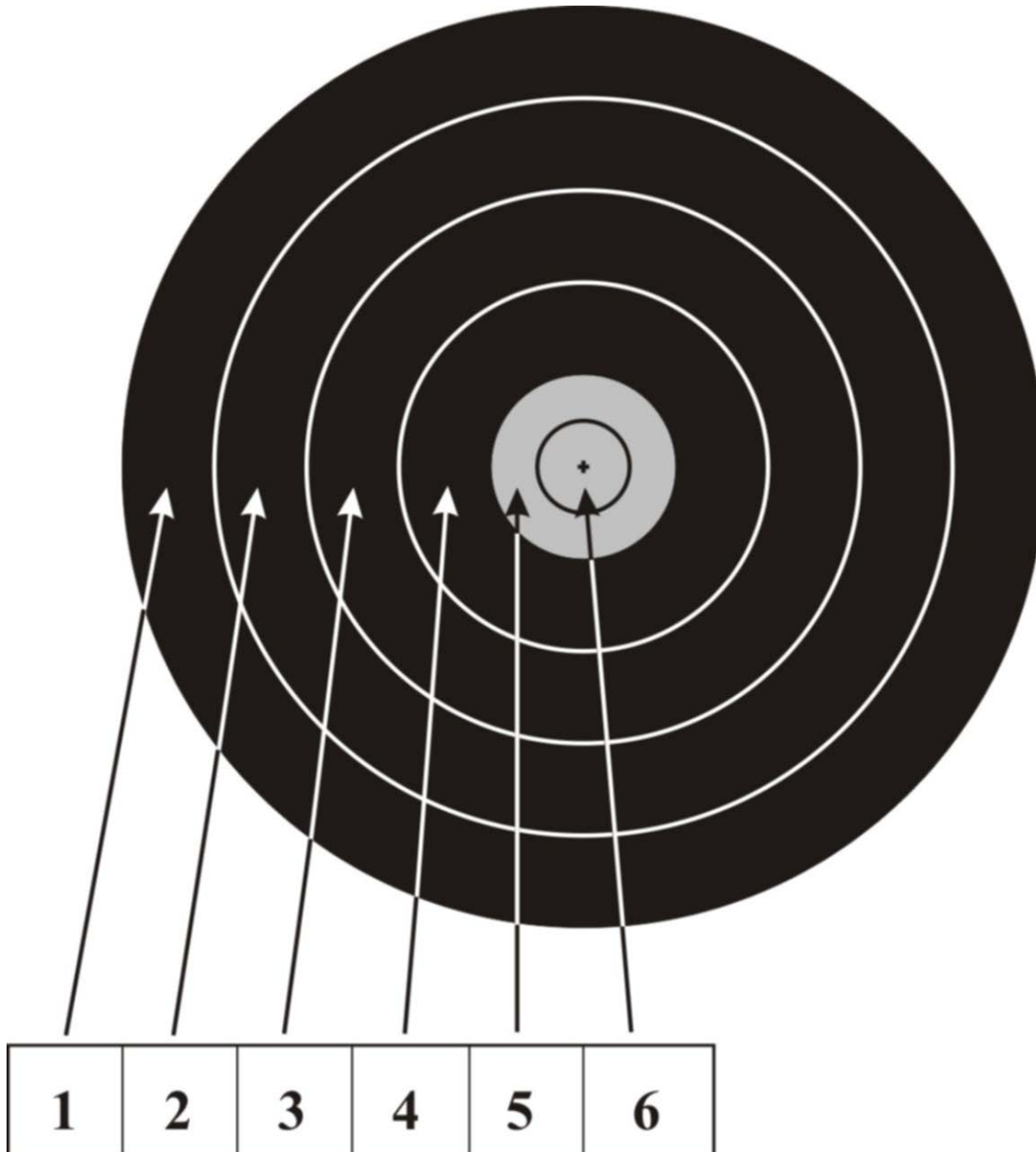

Target Face Positioning

80 and 60cm Target Face

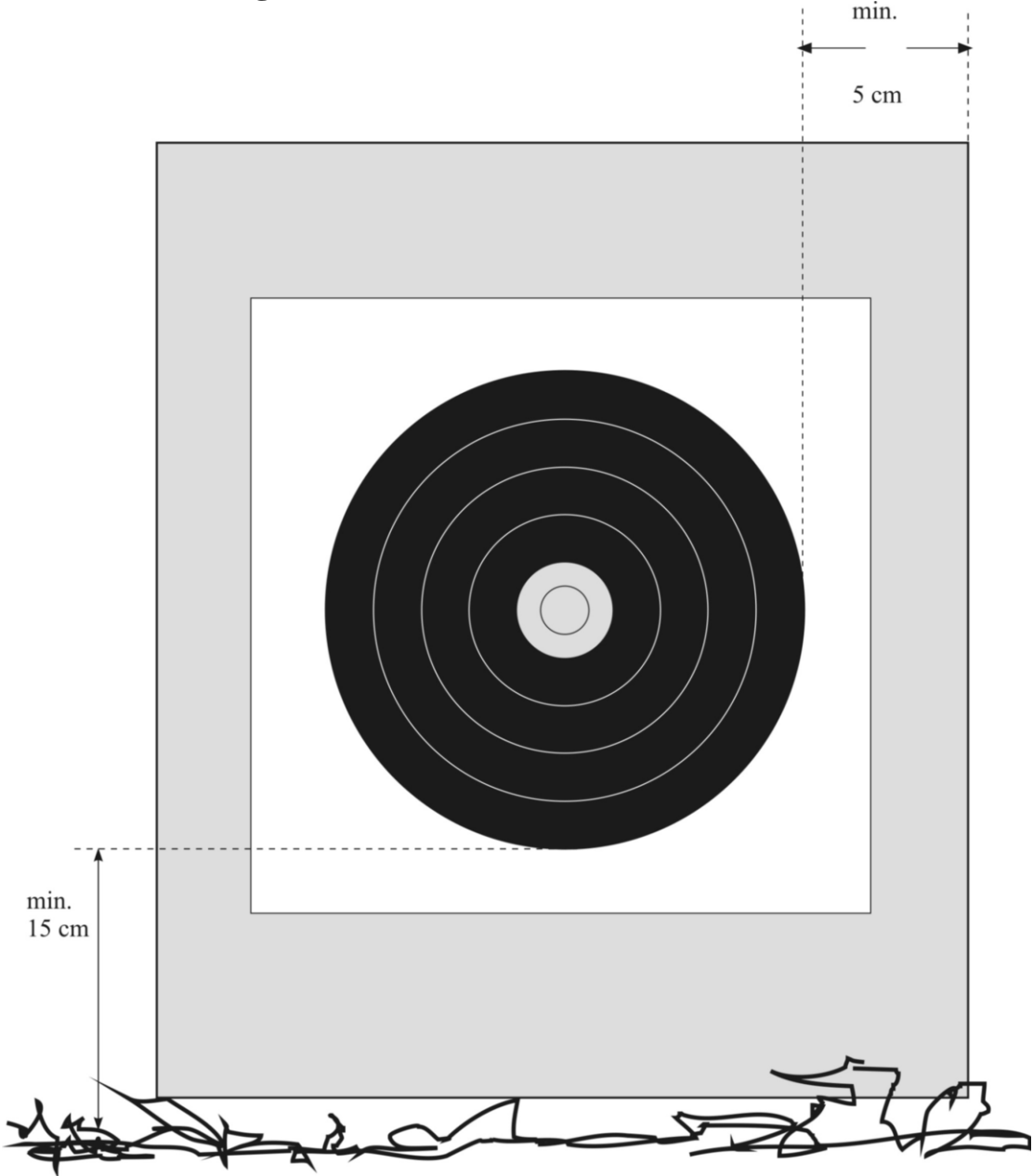

Target Face Positioning

4 x 4 40cm Target Face

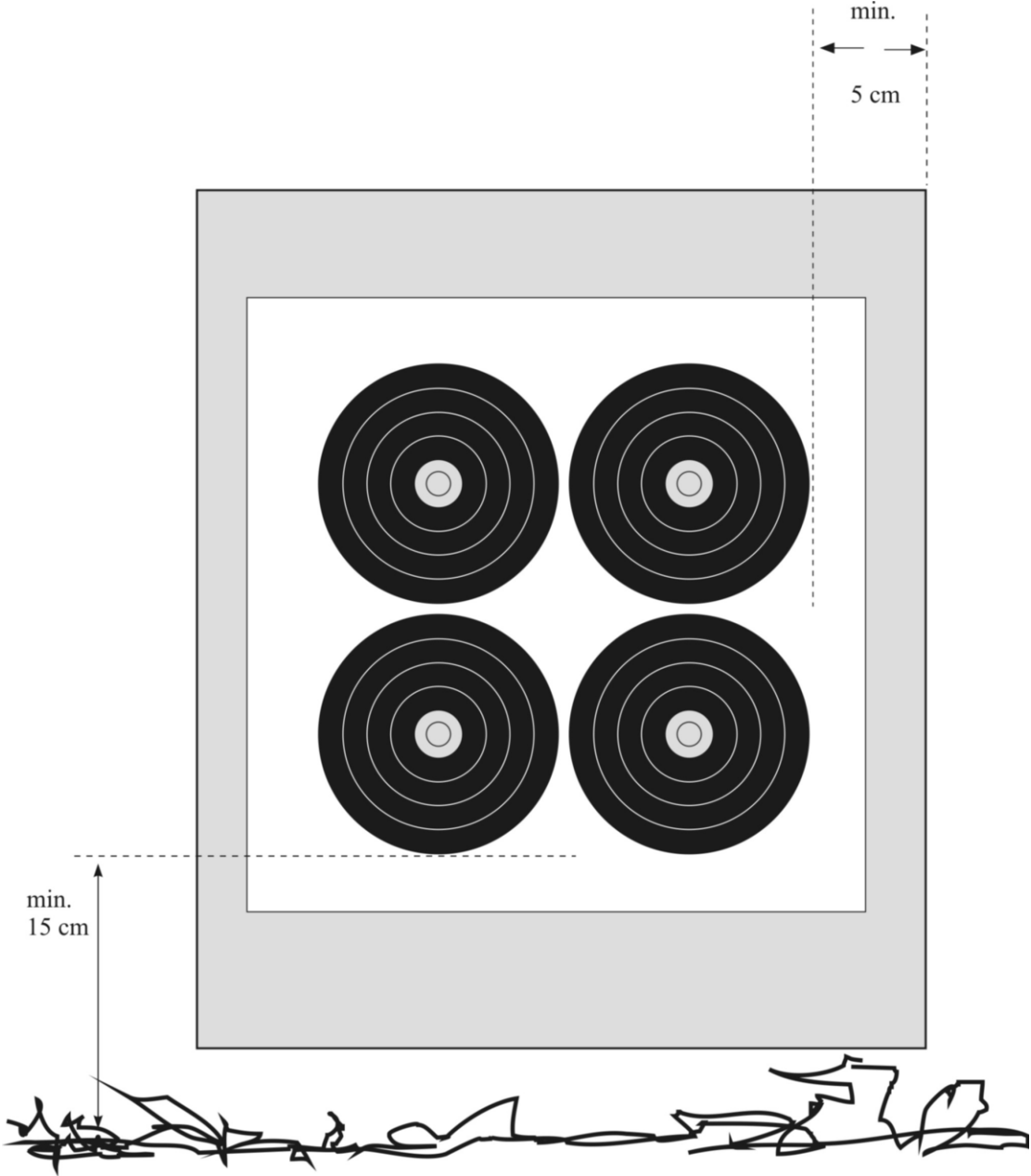

Target Face Positioning

4 x 3 Vertical Triple Target Face

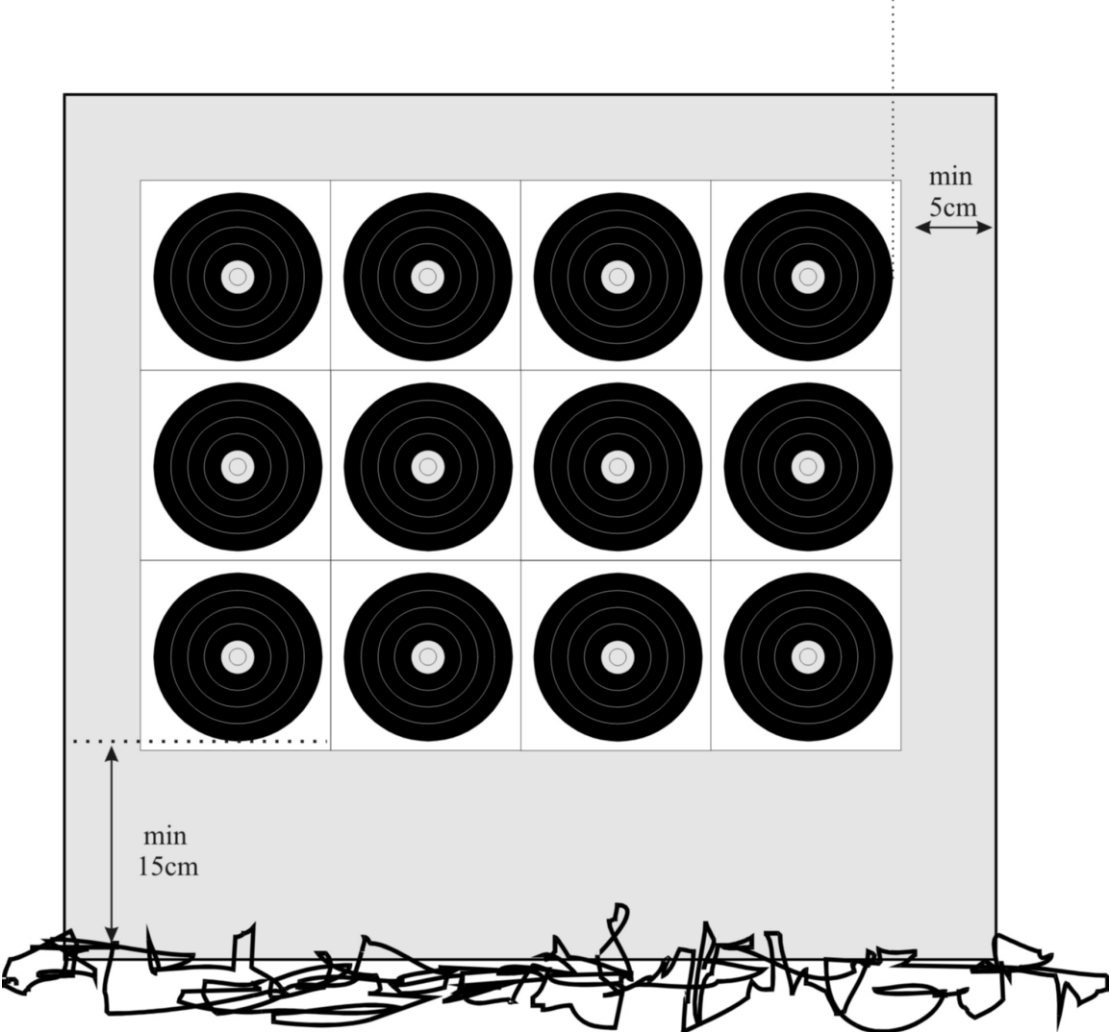

WPFG ABRIDGED RULES - ARCHERY - Page 26

3.0 3-D COMPETITION

3.1 3-D targets; unmarked distance round (25 Targets)

3.1.1 Each athlete shall shoot from the shooting peg without compromising safety.

3.1.2 The organisers shall assign the target at which each group shall start shooting.

3.1.3 In 3D Rounds the athlete can stand or kneel up to approximately 1m in any direction beside or behind the shooting peg, taking into consideration the condition of the terrain. In exceptional circumstances a Judge may give permission to shoot from outside the defined area.

3.1.4 Every shooting position shall have a shooting peg or mark to accommodate at least two athletes.

3.1.5 Athletes within a group waiting for their turn to shoot shall wait well back behind the athletes in the shooting position. (Athletes shall not cross the target waiting number)

3.1.6 Athletes shall wait well behind the athletes in the shooting position unless they are assisting the athletes at the shooting peg with shading.

3.1.7 Number of arrows to shoot in 3D rounds
One arrow per animal-target is allowed in all rounds.

3.1.8 Use of binoculars in 3D rounds:
Athletes/ may use binoculars to examine the target prior to shooting and at the shooting peg before shooting the arrow. The use of binoculars is allowed after having finished shooting the arrow.

3.1.9 No athlete may approach the target until all athletes of the group have finished shooting, unless given permission by a Judge.

3.1.10 Under no circumstances may an arrow be re-shot.
An arrow shall not be considered to have been shot if:

- The athlete can touch it with his bow without moving his feet from their position, and provided the arrow has not rebounded;
- The 3D target falls over. The Judges shall take whatever measures they deem necessary, and permit time for shooting the relevant number of arrows. If the target or butt only slides down it shall be left to the Judges to decide what action to take, if any.

3.1.11 No athlete may disclose the target distances to anybody on unmarked courses during the tournament.

WPFG ABRIDGED RULES - ARCHERY - Page 27

3.1.12 There is to be no discussion of distances among the athletes of a group until the target has been scored.

3.2 ORDER OF SHOOTING AND TIMING CONTROL IN 3D ROUNDS I

3.2.1 Should the number of athletes exceed the normal capacity of the course, additional groups shall be formed and placed in the field as is convenient. Additional groups assigned to a target shall wait until the primary group on that target has shot and scored their arrows before proceeding.

3.2.2 The athlete's number is to be prominently displayed on the athlete's quiver or thigh and is to be visible from behind the shooting post at all times while shooting is in progress. Athletes shall be allocated targets and shooting positions according to their order of draw and subsequent placement from the top to the bottom on the start list.

3.2.3 In case of equipment failure the order of shooting may be temporarily changed. In any case no more than 30 minutes shall be allowed to repair any equipment failure. The other athletes in that group shall shoot and score their arrows before allowing any following groups to shoot through. If the repair is completed within the time limit, the athlete in question may make up any arrows remaining to be shot on that target. If the repair is completed later, the athlete may rejoin his group but shall lose the arrows his group has shot in the meantime.

3.2.4 In the case of an athlete being unable to continue shooting because of a medical reason which occurred after the beginning of the shoot, the same provisions apply.

3.2.5 Athletes in a group may allow other groups to shoot through, provided the organisers or the Judges are notified about the change.

3.2.6 When an athlete, or a group of athletes, is causing undue delay for that group or for other groups the Judge observing this shall warn the athlete or group with a first written warning on the scorecard, after which he or a fellow Judge may time the athlete, or group throughout the remainder of that round of the competition.

3.2.7 In that case a time limit per target of one minute for 3D rounds shall be allowed from the time the athlete takes his position at the shooting peg, which he shall do as soon as possible after the shooting position becomes available;

- A Judge, having observed an athlete exceed the time limit despite the above procedure, shall caution him verbally and give a second written warning indicating the time and date of the warning;
- At the third and all subsequent warnings during that stage of the competition, the athlete shall lose the highest scoring arrow at the target;

3.2.8 The time limit may be extended in exceptional circumstances.

WPFG ABRIDGED RULES - ARCHERY - Page 28

- 3.2.9 No shooting shall be allowed after the time limit has expired;
- 3.2.10 If an athlete shoots an arrow after the Judge has stopped the shooting, the athlete shall lose the highest scoring arrow at the target.
- 3.2.11 Athletes shall shoot in groups of no more than four, but never fewer than three. Groups should be of even numbers as far as possible.
- 3.2.12 Each group shall shoot in pairs, rotating as follows:
The Organising Committee shall assign shooting positions;
- The first pair (with lowest athlete number(s)) shall start the shooting on the first target assigned to the group;
 - The other pair shall start shooting at the next target. The pairs shall rotate shooting at all subsequent targets throughout the competition;
- 3.2.14 If all athletes of the group agree they may change the above arrangement, pairing or shooting position;
- 3.2.15 If there are three athletes in a group the first two athletes on the start list (lowest athlete numbers) shall form the first pair, the third athlete shall be considered to be the second pair concerning rotation. He shall always shoot from the left side of the shooting peg;
- 3.2.16 Should there be sufficient room at a shooting peg, all athletes in the group may shoot at the same time.
- 3.2.17 Groups shall be assigned to start simultaneously from various targets and shall complete the round at the target before the one at which they started.

WPFG ABRIDGED RULES - ARCHERY - Page 29

3.3 ORDER OF SHOOTING AND TIMING CONTROL - 3D ROUNDS II

- 3.3.1 From the entries for each division, the athlete numbers, and allocation to groups and to targets shall be decided by draw for women and men separately.
- 3.3.2 Each group is composed of between three and four athletes (groups should be of even numbers as much as possible) with not more than two athletes from the same nation/region
- 3.3.3 The Tournament Organiser and the Director of shooting shall decide on special cases.
- 3.3.4 Unless otherwise agreed in the group, the group member with the lowest athlete number shall be the group leader and shall be responsible for the conduct of the group.
- 3.3.5 When the target is free the first two athletes of the group at the post with the animal picture shall go to the shooting peg as soon as possible. The other members of the group stay behind at an appropriate distance.
- 3.3.6 It is not allowed for the athletes to walk in the direction of the shooting peg, and stand still at a short distance behind the shooting peg estimating the distance before shooting.
- 3.3.7 Each pair of athletes in the group shall shoot together rotating as follows: In the shooting group, the athletes with the lowest athlete numbers shall start shooting at the first target, followed by the next higher athlete numbers etc;
- 3.3.8 The last one or two athletes of one target shall start shooting first on the next target assigned to the group; followed by the athletes who started the shooting before.
- 3.3.9 The athletes shall rotate shooting at all subsequent targets throughout the competition.
- 3.3.10 Groups shall be assigned to start simultaneously from various targets and shall complete the rounds at the target before the one at which they started.
- 3.3.11 Allotted shooting time
One minute is the time limit for an athlete to shoot one arrow. As soon as the group in front has cleared the shooting peg the next group moves from the waiting area to the area with the picture of the animal target to be shot.
- 3.3.12 When the group in front has cleared the target and is assumed to be at safe distance, the group may go forward from the picture-area to the shooting peg and the first athlete in the group starts shooting. Due to safety reasons and the time-limit, the arrow can only be nocked at the shooting peg.
- 3.3.13 The time limit of one minute for each athlete in the group begins when he arrives at the peg.

WPGF ABRIDGED RULES - ARCHERY - Page 30

3.4 SCORING - 3D ROUND

- 3.4.1 Scoring shall take place after all athletes in the group have shot their arrows.
- 3.4.2 Unless otherwise agreed in the group, the group member with the lowest athlete number shall be the group leader and shall be responsible for the conduct of the group.
- 3.4.3 The two athletes with the second and third lowest athlete numbers shall be the scorers.
- 3.4.5 Scorers, who can be athletes, shall enter on the scorecard alongside the correct number of the target, and in descending order if applicable, the value of each arrow as called by the athlete to whom the arrow(s) belong. Other athletes in the group shall check the value of each arrow called. A mistake on the scorecard discovered before the arrows are drawn may be corrected. (All archers should initial the back of the score card indicating their agreement to the corrections and the target number should also be recorded)
- 3.4.6 For 3D rounds all scoring zones are valid unless otherwise noted at the shooting peg.

A 3D animal target is divided into 4 scoring zones (11; 10; 8 and 5).

An arrow touching the dividing line between 2 scoring zones or the border line of the scoring area will score the higher value.

- 11 points the small circle in the centre of the 10-ring (about 25% of the 10-ring zone);
- 10 points the larger circle within the vital area.
- 8 points vital area outside the 10 point circle.
- 5 points remaining body colour zone.
- A hit in the horn or the hoof, not touching the body colour zone, a glance off or any other miss counts as a miss (M)

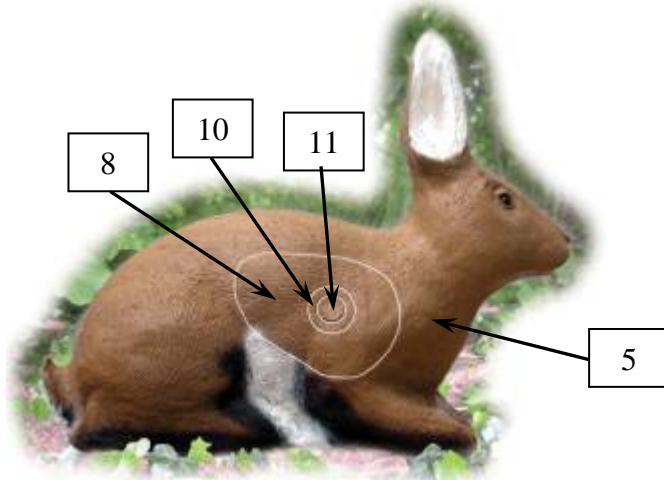

- 3.4.7 An arrow shall be scored according to the position of the shaft in the target. Should the shaft of an arrow touch two zones or a dividing line between scoring zones, that arrow shall score the higher value of the zones affected.

WPFG ABRIDGED RULES - ARCHERY - Page 31

- 3.4.8 None of the arrows, shall be touched until all arrows on that target have been recorded and scores checked.
- 3.4.9 Arrows embedded in the targey and not readily showing on the animal can only be scored by a Judge.
- 3.4.10 In case of a rebound or pass-through the scoring shall take place as follows:
- If all of the athletes in that shooting group agree that a rebound or pass-through has occurred, they may also agree on the value of that arrow;
 - In 3D rounds if they cannot agree on the value of the arrow, the arrow shall be scored a miss.
- 3.4.11 An arrow hitting:
- Another arrow in the nock and remaining embedded therein shall score according to the value of the arrow struck.
 - Another arrow, and then hitting the target after deflection, shall score as it lies in the target.
 - Another arrow, and then rebounding shall score the value of the arrow struck, provided the damaged arrow can be identified.
 - Outside the outermost scoring area of the 3D target shall score as a miss.
 - A miss shall be recorded as "M" on the scorecard.
- 3.4.12 If more than one arrow for 3D rounds belonging to the same athlete should be found in the target or on the ground of the shooting lane, only the lowest arrow shall be scored. Should an athlete be found to repeat this he may be disqualified.
- 3.4.13 Tied scores are ranked using:
- Greatest number of 10's and 11's;
 - Greatest number of 11's for 3D;
 - After this, athletes still tying shall be declared equal.
- 3.4.14 Scorecards shall be signed by the scorer and the athlete, denoting that the athlete agrees with the value of each arrow, the sum total (identical on both scorecards), the number of 10's and 11's. The scorer's scorecard shall be signed by another athlete of the same group but of a different Nation / Association.
- 3.4.15 The organisers shall not be required to accept or record scorecards that have not been signed, do not contain the sum total, the number of 10's and 11's or which contain mathematical errors. The organisers or officials are not required to verify the accuracy of any submitted scorecard however if the organisers or the officials note an error, they shall correct such error and the result as corrected shall stand.
- 3.4.16 Should a discrepancy be found in the sum total, the sum total of the lowest arrow scores shall be used for the final result.
- 3.4.17 At the end of the tournament the Organising Committee shall publish complete result lists.