



HDPE WATER CONTROL DEVICES



**MODEL 70HFV AND 70HSG
FLAP VALVES
SLIDE GATES**

WHY HDPE?

HDPE (high density polyethylene) is an extremely rugged thermoplastic that has been used in the water and wastewater industries for decades. Not to be confused with PVC, the molecular construction of HDPE will not break down or deteriorate during the life of the product. HDPE provides exceptional durability, strength-to-weight ratio, and ease-of-manufacturing, making it an ideal material for use in water control devices.



MATERIAL PROPERTIES:

- Resistant to corrosion and shock
- Highly chemical resistant
- UV stable and ozone resistant (very good aging resistance compared to general plastics)
- Standard thickness: 1.2" (30mm). Provides the ideal combination of manufacturing efficiency and material strength.

BENEFITS:

- Heavy-duty construction without excess weight
 - Low transport cost
 - Low installation cost
- Low maintenance, high reliability
 - Will never rust
 - Extremely resilient
 - Resists organic and marine growth
- Material is very easy to work with
 - Low assembly costs
 - Quick lead times
 - Custom designs are easy to manufacture
- Unused material can be recycled

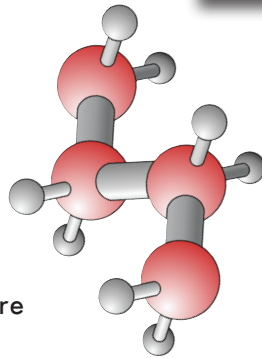

	HDPE	Cast Iron	Stainless Steel
Durable	✓	✓	✓
8x less weight	✓		
Low transport cost	✓		
Low rigging cost	✓		
Low installation cost	✓		
Easily customized	✓		

MANUFACTURING

HDPE has a proven track record of durability and performance within the water and wastewater industries. The rapid increase in HDPE pipe usage over the last half-century has paved the way for other HDPE water products. Pioneered in Europe in the mid 1980's, HDPE water control products have seen constant improvement. Unlike traditional cast iron and steel valves and gates, our HDPE product line can easily be modified for unique flow control solutions.

Our team offers project-based solutions, with all design and manufacturing done in a 20,000 square foot ISO9001 certified facility featuring state-of-the-art equipment. Our commitment is to provide our customers with high quality water control solutions that have a short lead-time and low total cost of ownership.



HDPE FLAP VALVES

ROSS 70HFV SERIES

SIZES:

Standard line for 4" to 60" pipe (100mm to 1500mm). Custom shapes and sizes up to 120" are available.

DESIGN:

HDPE's high strength-to-weight ratio and rust-proof qualities make it the perfect material for rugged, efficient flap valves. They are highly responsive under all pressure conditions, and will provide a lifetime of reliable, low-maintenance service.



KEY FEATURES:



- 1** The HDPE flap contains a stainless steel handle and reinforcements (when required).
- 2** The innovative slotted-hinge design allows the flap to self-align and operate at both high and low pressures.
- 3** The HDPE base is available in a variety of sizes, shapes, and styles to suit any application.
- 4** A resilient EPDM seal is pressed into a precision machined groove for tight seating.

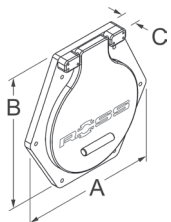

ADDITIONAL FEATURES & BENEFITS:

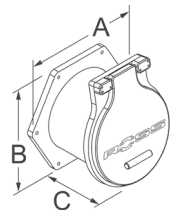
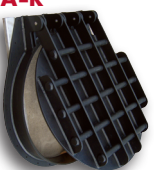
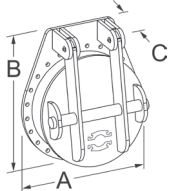
- HDPE valves work exceptionally well over a wide pressure range and offer flexibility to meet specific design criteria. Additional weight added to the handle or an angled base can easily be incorporated to fine tune a valve for optimal performance in any application.
- Our HDPE valves work efficiently at low pressures while still allowing full flow capacity. Metal valves typically require a significant pressure build-up before opening (causing higher losses and larger pump requirements), or utilize a cumbersome double-hinge design.
- The fact that HDPE is so durable and easily machined means that we can very economically offer a range of non-standard shapes and sizes that are easy to manufacture and install.
- All non-HDPE components like hinge pins, fasteners and handles are constructed of stainless steel.

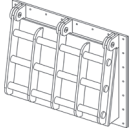
	Size	"A" Width	"B" Height	"C" Depth	Weight (lbs)		Notes
MODEL 70HFV Our standard flap valve with wall mounted connection 	4	9	11.25	3.75	9		<ul style="list-style-type: none"> ■ All valves are rated for installations with up to 20ft of head. ■ Standard connection types include wall mounted and flanged. Special hole patterns available upon request. ■ Dimensions are subject to change. Please refer to individual part drawings. ■ Dimensions are in inches
	5	9.25	11.75	3.75	9		
	6	10.25	12.75	3.75	9		
	8	12.25	15	3.75	11		
	10	14.25	17	3.75	15		
	12	16.25	19	3.75	18		
	16	24	23.75	3.75	24		
	20	28	27.5	3.75	31		
	24	32	32.5	3.75	40		
MODEL 70HFV-A This model adds an angled extension tube for more positive closure 	4	10	12	12.25	9		
	5	10	12	12.25	11		
	6	10	12.75	12.25	13		
	8	11.5	14.5	12.25	15		
	10	13.5	16.5	12.25	20		
	12	15.5	18.5	12.25	22		
	16	19.5	23	16.5	29		
	20	23.25	27	16.5	40		
24	27.25	31.25	16.5	49			
MODEL 70HFV-A-R Sizes 28" and up are supplied with an angled base and reinforced door as standard 	28	39.5	44.5	18.25	121		
	32	43.5	48.25	19	132		
	36	47.25	52.25	19.5	165		
	40	51.25	56.25	20	187		
	48	59	64	21.5	243		
	60	71	75.75	22.25	330		

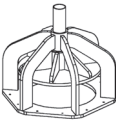
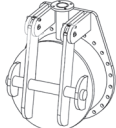
OPTIONS	Alternate Shapes	Contoured Base	Floor Mounted	For Pump Discharge
	<ul style="list-style-type: none"> ■ Square ■ Rectangular ■ Oval 	To match the wall profile inside a curved pit. 		<ul style="list-style-type: none"> ■ Stroke limiter prevents valve from getting stuck in open position ■ Air bleed connection removes air from pump discharge 

HDPE SLIDE GATES

ROSS 70HSG SERIES

SIZES:

Standard line for 6" to 60" passages (150mm - 1500mm).
For larger sizes, consult factory.

DESIGN:

The innovative design of our slide gate integrates the rugged yet forgiving nature of HDPE components with the proven durability of a stainless steel framework, for a product that provides surprisingly good performance and long life.

KEY FEATURES:

- 1** The HDPE door contains dual seals for the most water-tight connection available.
- 2** The HDPE back plate is a robust design that ensures proper stem alignment, even if debris becomes lodged in the valve.
- 3** The stainless steel z-profile frame has been designed for rigid construction and easy mounting.
- 4** Non-rising stainless steel stem incorporates end stops at both the upper and lower limits.

**Extremely low leak rates.
Out performs the requirements
for AWWA Standard C561.**

ADDITIONAL FEATURES & BENEFITS:

- Suitable for round, square or rectangular passages
- Double acting design
- Thrust bearings are Teflon or stainless steel for considerable reduction of operating torque.
- Special stem thread design is optimized for operating speed and ease of use.
- Optional rising stem is available.

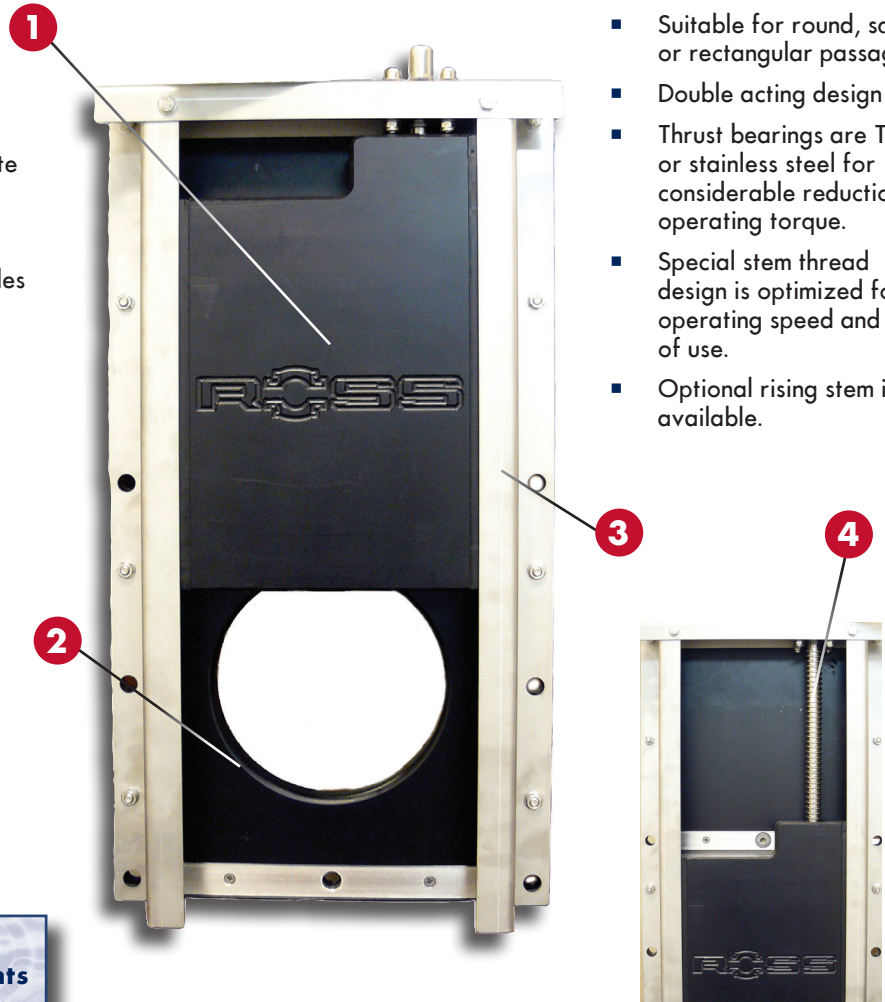

HDPE's unique manufacturability allows us to provide dual seals very efficiently. This redundancy can further reduce leakage, with no effect on the coefficient of friction.



Our slide gates can be fitted with a variety of actuators, including manual, electric, hydraulic, and pneumatic.

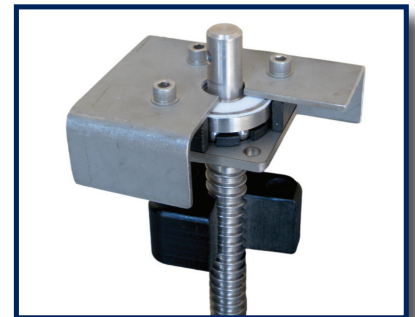

Our stem assemblies are designed with self-lubricating stem blocks and reinforced stem tubes so they never require any maintenance.

ROSS 70HSG SERIES HDPE SLIDE GATE

Size	"A" Width	"B" Height	"C" Center to Top	"D" Depth	Weight (lbs)
6	13.5	23.5	17	3.75	35
8	15.5	27.5	20	3.75	49
10	17.5	31.5	23	3.75	57
12	19.5	35.5	26	3.75	68
16	26.5	45.5	32	5.5	121
20	30.5	53	38	5.5	165
24	34.5	61	44	5.5	198
28	38.25	69	50	5.5	243
32	42	77	56	5.5	287
36	46	84.5	62	5.5	342
40	53	94.5	68	6.5	463
50	62.5	114.5	93	6.5	706
60	72.5	134	97.5	6.5	860

Note: Dimensions are subject to change. Please refer to individual part drawings. Dimensions are in inches.

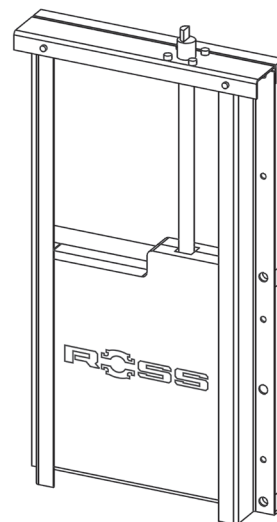
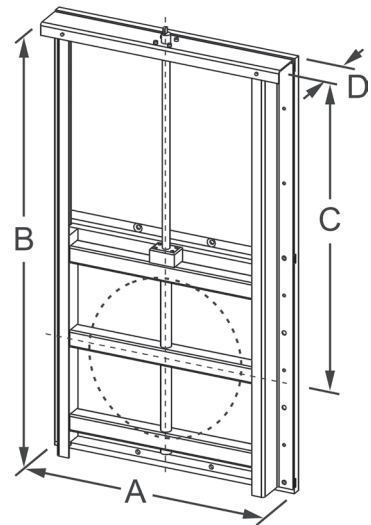

Gates 12" and smaller utilize an offset stem design, which allows easy access to bolts that would otherwise be hidden, and makes installation much easier.



A multi-stem design may be used on larger gates, based on width-to-height ratio. This incorporates synchronized stem rotation, to ensure symmetric opening and closing.



Regardless of size, our slide gates' lifetime of reliable service and low total cost of ownership begins with easy installation.

STANDARD PRODUCT OVERVIEW

HDPE FLAP VALVES

**70HFV
STANDARD BASE**

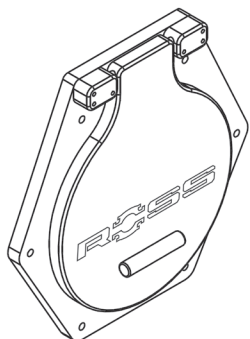

**70HFV-A
ANGLED BASE**

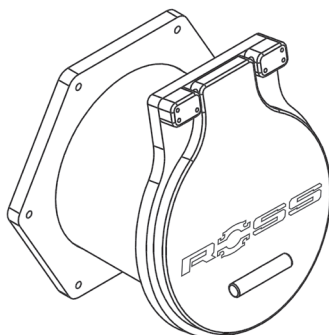

**70HFV-A-R
ANGLED AND REINFORCED**

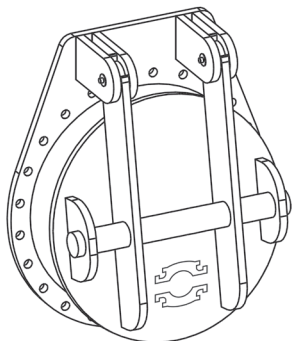

**70HFV-C
CONTOURED BASE**

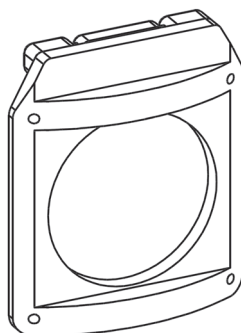

**70HFV-F
FLOOR MOUNT**

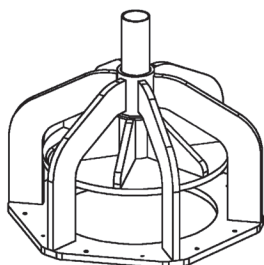

**CUSTOM SHAPES
AND SIZES**

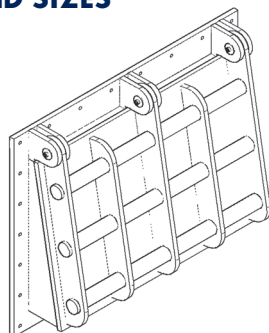

HDPE SLIDE GATES

**70HSG
OFFSET STEM
(6" - 12")**

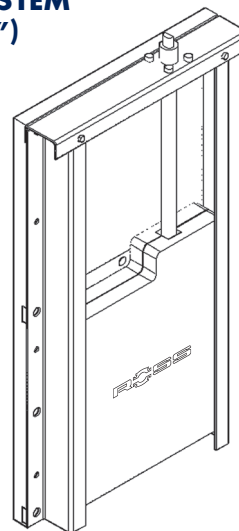

**70HSG
CENTER STEM
(OVER 12")**

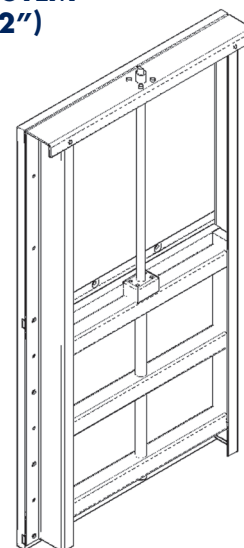

Multiple stem designs and a variety of actuator options are available as needed.



Ross Valve Mfg. Co., Inc.
P.O. Box 595, Troy, NY 12181-0595, USA
Tel: 518-274-0961 • Fax: 518-274-0210
Email: sales@rossvalve.com • www.rossvalve.com



All Ross Valves meet or exceed all current AWWA standards for construction and pressure ratings.
HDPE 05-11 5000