

Superconductivity

4-24-2014



Brian Egenriether
egenriether@gmail.com



Agenda

- *What is superconductivity?*
- *History*
- *Critical temperature and the superconducting phase change*
- *Is it the same as a perfect electric conductor (PEC)?*
- *Behavior of magnetic fields in superconductors*
- *Behavior of current in superconductors*
- *Classification: Type I & Type II superconductors*
- *Evolution of higher temperature superconducting materials*
- *Theoretical explanations*
- *Examples and applications of superconductors*
- *Questions*

What is superconductivity?

Superconductivity is characterized by the loss of all electrical resistance and total ejection of all magnetic fields below a material-dependent critical temperature, T_c .

- *Superconductivity is a quantum mechanical effect which cannot be explained using classical physics.*
- *Above the critical temperature T_c , the superconductivity state is destroyed.*
- *Above a critical magnetic field H_c , the superconductivity state is destroyed.*
- *Above a critical current I_c , the superconductivity state is destroyed.*
- *Most elemental superconducting materials exhibit $T_c < 5K$ and $H_c < 0.05T$*
- *Many alloy superconductors exhibit $T_c \sim 80K$ and $0.05T < H_c < 70T$*
- *The highest temperature SC to date is $HgBa_2Ca_2Cu_3O_8$ with $T_c = 134K$.*

History

- *Superconductivity was first discovered by H. Kamerlingh Onnes in 1911.*
- *Onnes was the first person to liquefy helium and reach the coldest conditions to date on Earth, 1.4K*
- *Did first research on solidified mercury.*
- *Won the 1913 Nobel Prize for his discovery.*
- *Many physicists, including Lord Kelvin, thought resistivity would become infinite at such low temperatures.*
- *Onnes correctly predicted resistivity would become zero, although he thought it might do so less abruptly.*

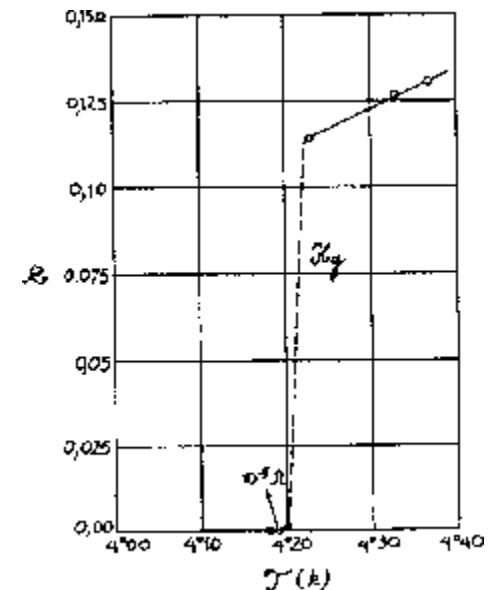

Critical Temperature and the Superconducting Phase Change

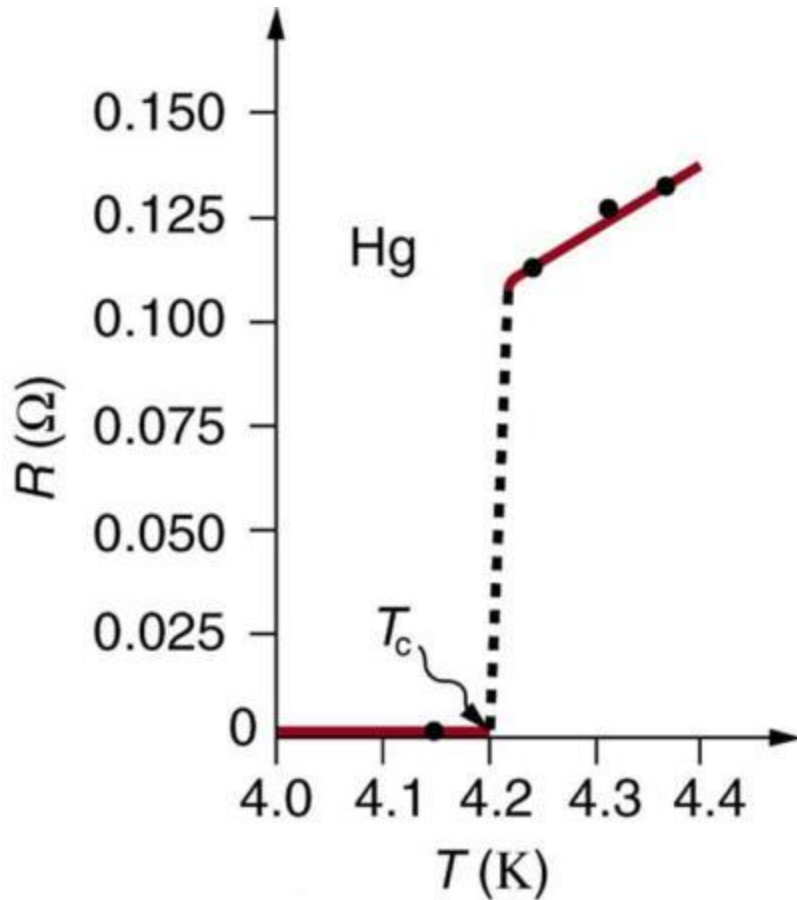

At a critical temperature, T_c , the resistivity of some materials abruptly falls to zero. This temperature depends on the material in question, and happens slower for some materials.

The plot on the left is a recreation of Onnes' plot for mercury ($T_c = 4.2$ K). The drop in resistivity is accompanied by an exponential increase in heat capacity (not pictured), signifying a phase change.

Critical Temperature and the Superconducting Phase Change

There is a finite ΔT over which the phase transition occurs. This region is important to physicists because it shows that SC regions are forming.

The zero point is important to engineers because this is the region where the material can support a super current.

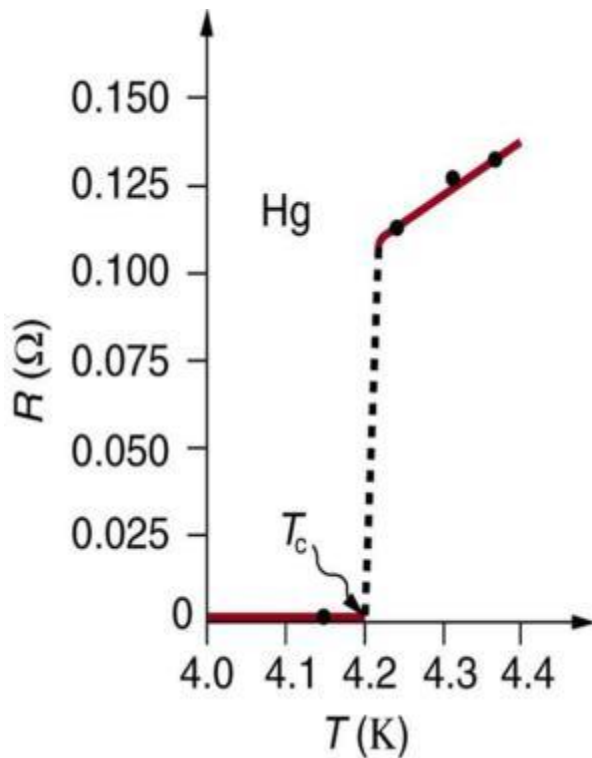

Are Superconductors the Same as a PEC?

A perfect electrical conductor (PEC) is a tool used in classical electromagnetics to simplify calculations and speed up computer simulations. Zero resistance is the only imposed condition.

As such, time varying magnetic fields are also not present because by Faraday's Law there would also be electric fields.

Are Superconductors the Same as a PEC?

*What about **static** magnetic fields?*

*There is nothing in the math that would prevent **static** magnetic fields from existing in a PEC, provided they had always been there.*

*If you could cool a metal into a PEC state, any B field present at the onset of the phase change would exist inside the PEC. In fact, it would persist even after the external field was removed. This is known as **field retention**.*

Behavior of Magnetic Fields in Superconductors (PEC Example)

PECs exhibit **magnetic field exclusion** and **magnetic field retention**.

Exclusion means no **changing** B field penetrates the PEC while in a perfect conducting state.

Retention means that while perfectly conducting, it retains its original magnetic field from the time of phase change regardless of the behavior of an external magnetic field.

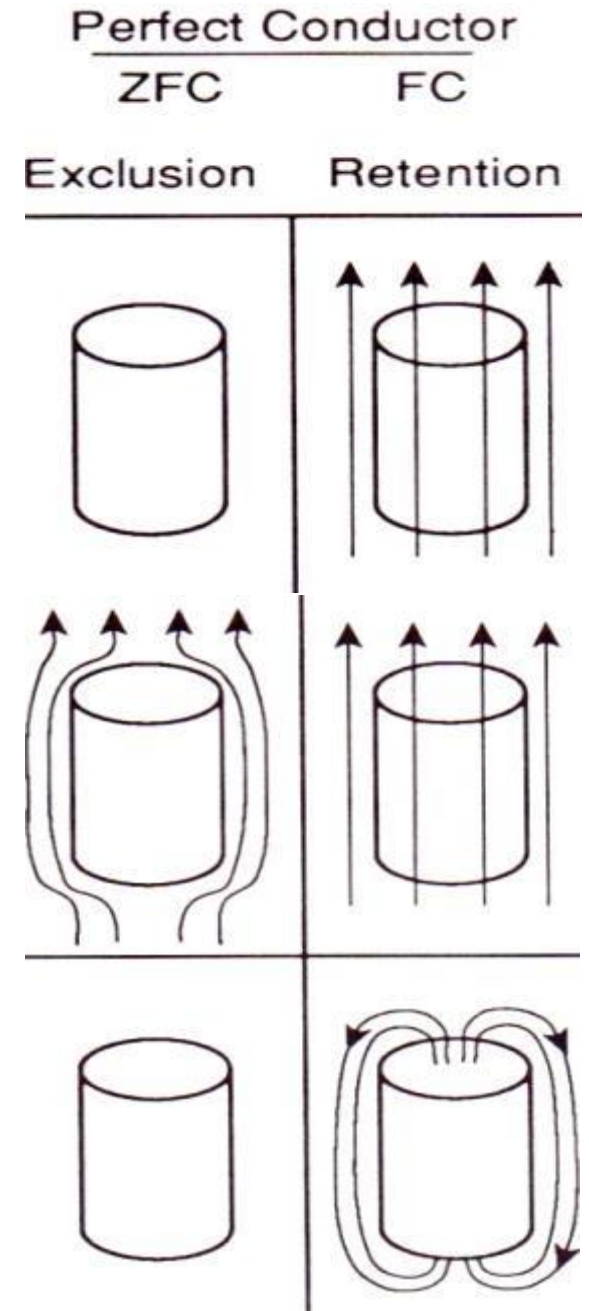

*In addition to **magnetic field exclusion** and **retention**, SCs also exhibit **magnetic field expulsion**.*

***Exclusion** means no B field penetrates the SC while in a perfect conducting state.*

***Expulsion** means that no magnetic field can penetrate the bulk of the SC when below the transition temperature (more on this effect later).*

*So with expulsion, how do we ever get retention? **Geometry!***

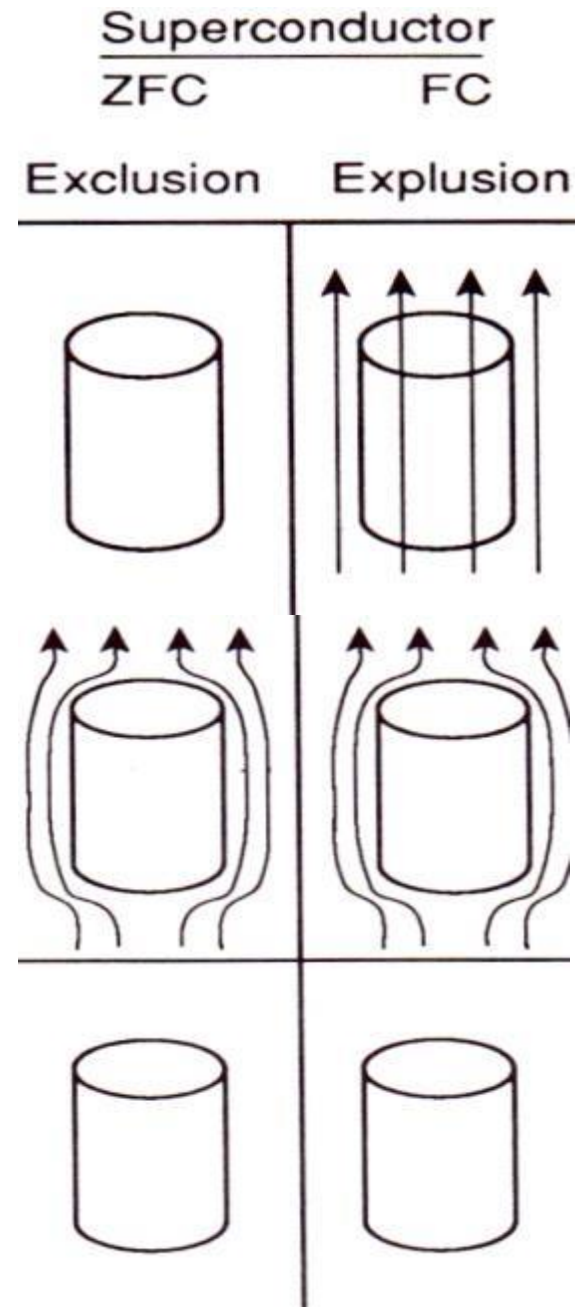

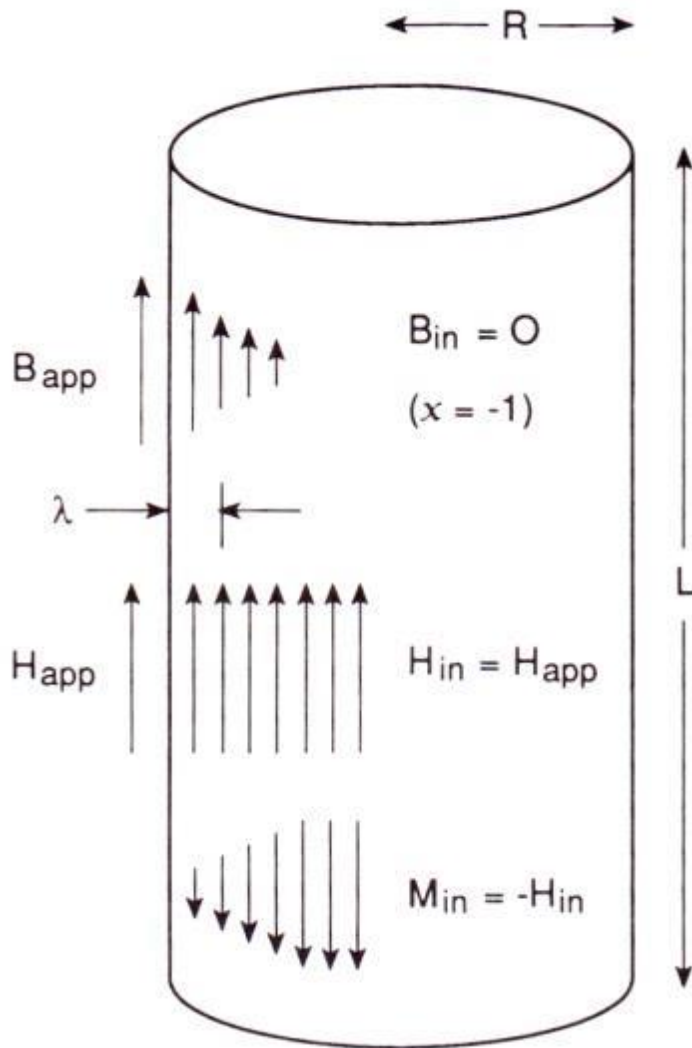

To understand how we get retention even with expulsion, let us first look at how a magnetic field is screened. Under an applied field, a SC cylinder will generate a counter magnetism M , which is given by:

$$\vec{M}(r) \approx -\vec{H}_{app} \left[1 - e^{-((R-r)/\lambda)} \right]$$

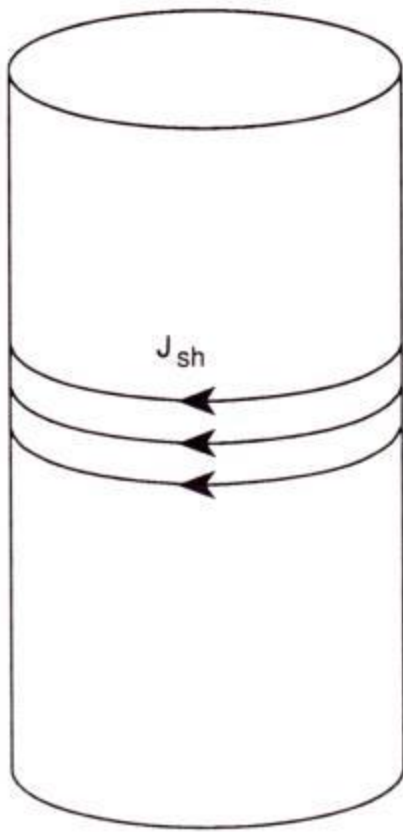

This demagnetizing field is set up by a shielding current, flowing circumferentially around the cylinder and is given by

$$\vec{J}_{sh}(r) \approx -\vec{J}_0 e^{-\left(\frac{R-r}{\lambda}\right)}$$

And is related to the magnetism by

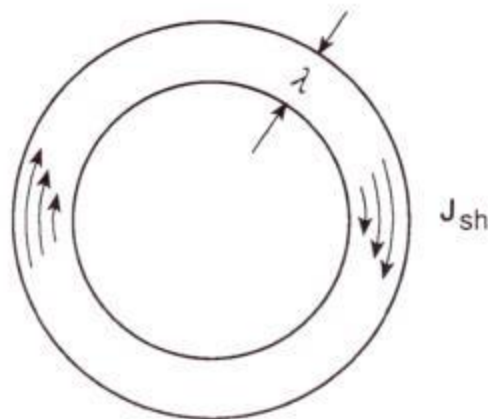

$$\vec{J}_{sh} \approx \nabla \times \vec{M}$$



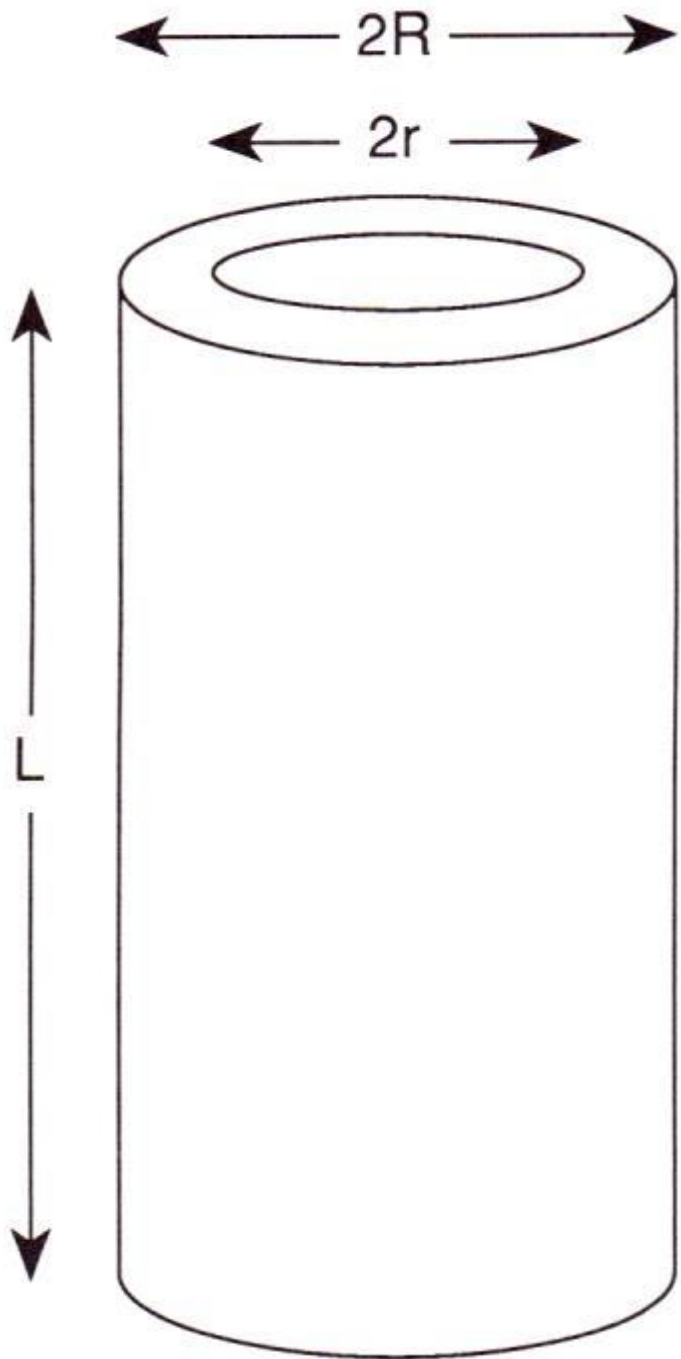

Now consider a SC cylinder with a hole axially through it.

If the SC cylinder were field cooled, once the field is expelled, there would still be field lines around the outside of it as well as through the hole in the middle.

Retention in SCs requires a hole to be in the body of the SC.

Retention here means the field retains its original magnetic field through the hole from the time of phase change regardless of the behavior of an external magnetic field. Without the hole, Faraday's Law cannot act, since there will never be any B field within the bulk of the SC. Experiments lasting several years show that these currents can continue without diminishing, and without an external source of power.

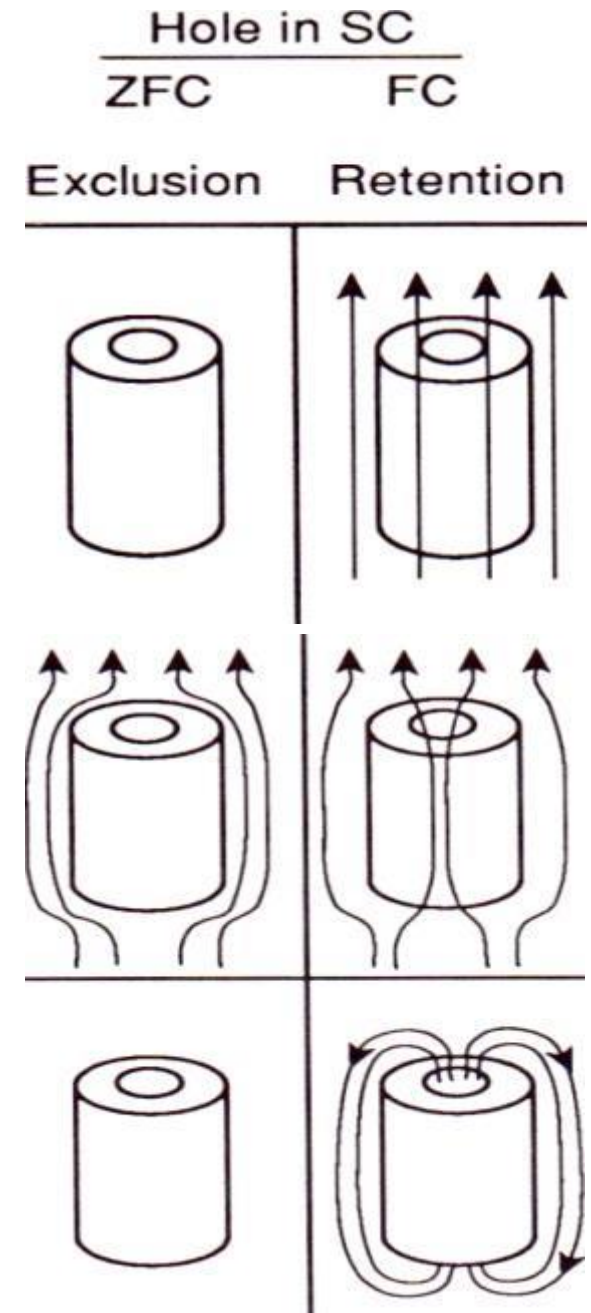

Thus the superconductor and the hole both possess perfect diamagnetism.

$$\chi = -1 \quad ; \quad \mu_r = 0$$

Important note: All magnetic flux lines passing through a superconducting loop must be **quantized**. The unit of quantization is the **fluxon** and is given by the following relation:

$$\Phi_0 = \frac{h}{2e} \approx 2.067833758(46) \times 10^{-15} \text{Wb}$$

Unlike a PEC, SCs exhibit a quantum phenomenon called the **Meissner Effect**. This is the complete ejection of any magnetic field (static or dynamic) from its interior whether the field was present at the beginning or not. The field is actually not completely expelled; the field will fall off exponentially as

$$B_0 e^{-x/\lambda}$$

Where λ is the London penetration depth and is a fundamental length scale in superconducting physics. In most conventional SCs, $\lambda \approx 50\text{nm}$

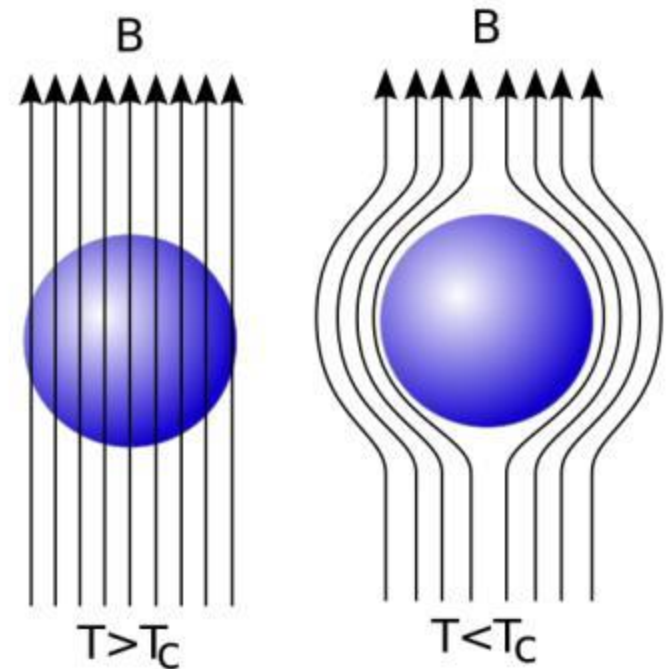

Behavior of Magnetic Fields in Superconductors

The Meissner Effect gives rise to the possibility of superconducting levitation. Since all magnetic fields must be expelled from the bulk of a SC, they behave as (nearly) perfect diamagnetic materials, with $\mu_r=0$.

This allows a magnet to be supported by

The counter magnetic field from the surface super currents that arise due to the Meissner Effect.

If a SC was just a PEC, cooling it below T_c with a permanent magnet resting on its surface would not cause it to levitate, because there would not be a changing magnetic field to induce surface currents.

Flux Exclusion

<https://www.youtube.com/watch?v=4IE8QWtrEvQ>

Flux Expulsion (Meissner Effect)

https://www.youtube.com/watch?feature=player_detailpage&v=40iukb264PM#t=77

Behavior of Magnetic Fields in Superconductors

Any sufficiently strong external magnetic field will destroy the superconducting state, just as heat will. This field is known as the

***critical field** and is given by the symbol H_c . Above the critical temperature,*

$H_c=0$ and $\lambda=\infty$.

As the SC is cooled, B_c reaches its final value.

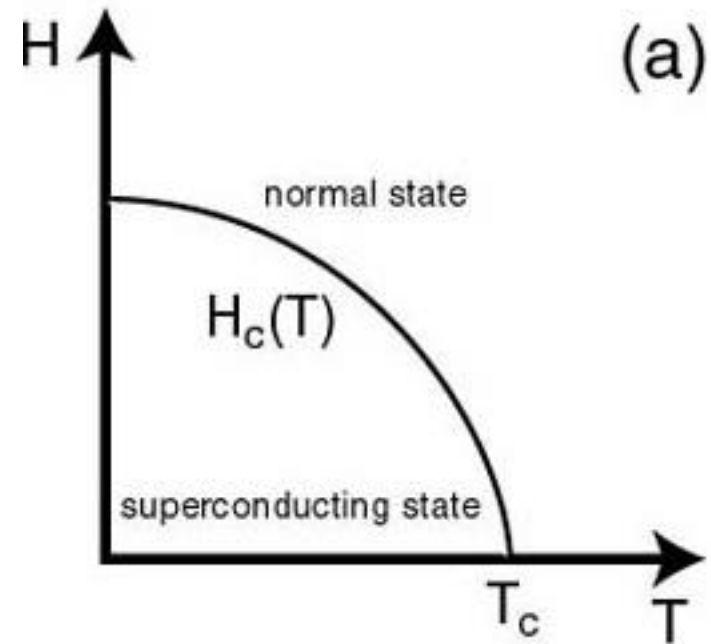

Behavior of Magnetic Fields in Superconductors

Note the dependency of T_c on H_c . As the temperature rises toward the critical temperature, the material is less able to deal with an external field. Right at T_c , the SC cannot handle even the slightest magnetic field without going into a normal conducting state. The critical flux density is given by

$$\mathbf{B}_c = \mu_0 \lambda \mathbf{J}_c$$

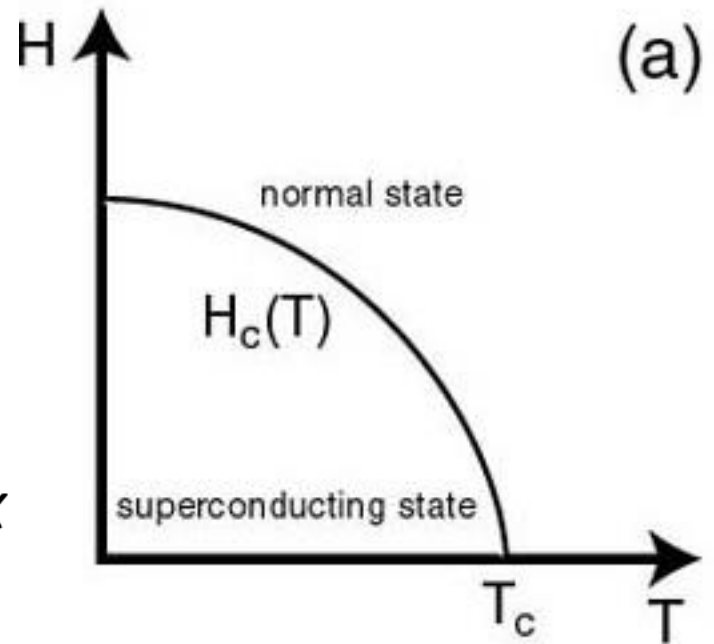

Behavior of Current in Superconductors

*There are two types of current in a superconductor:
Shielding current which screens magnetic fields and
Transport current which travels along the conductor.*

*Along with critical temperature and magnetic field, a sufficiently high current density of either type of current will cause a SC to go into a normal conducting state. This is known as the **critical current density** and is given by J_c .*

Behavior of Current in Superconductors

A superconducting wire of radius R has a critical current, I_c , which is given by $2\pi R\lambda J_c$. Note the dependence on the London penetration depth, λ .

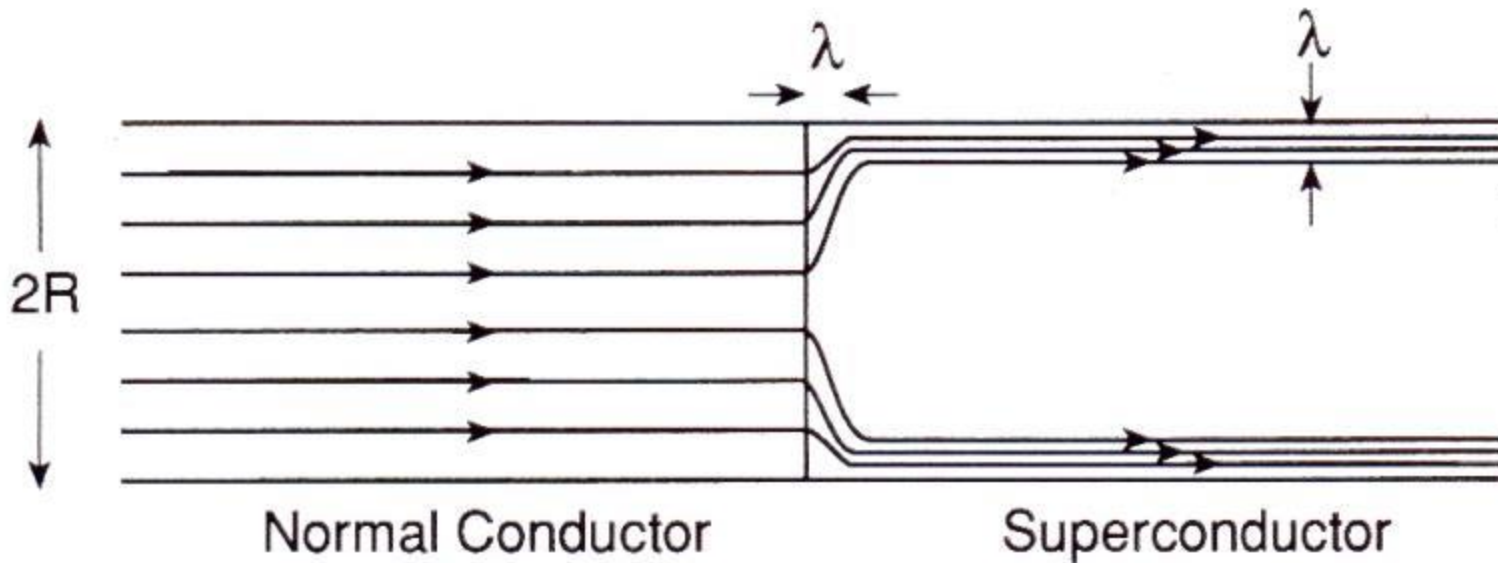

Behavior of Current in Superconductors

$2\pi R\lambda$ is the effective cross section of the wire, much like the skin depth for AC signals in normal conductors. This is because Amperes Law would set up magnetic fields inside the bulk of the SC and this is forbidden. The existence of a critical current is known as the **Silsbee effect**.

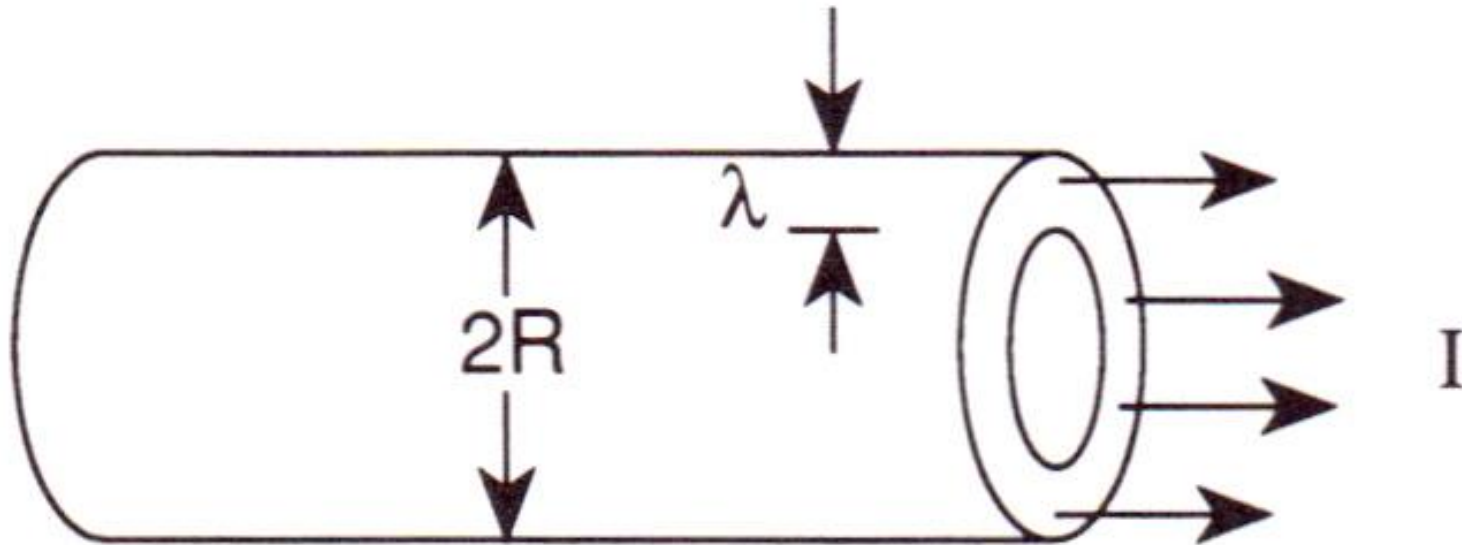

Behavior of Current in Superconductors

The magnetic field created by this current is the same outside the wire as a normal conductor carrying wire, but is quite different inside.

Normal conductor

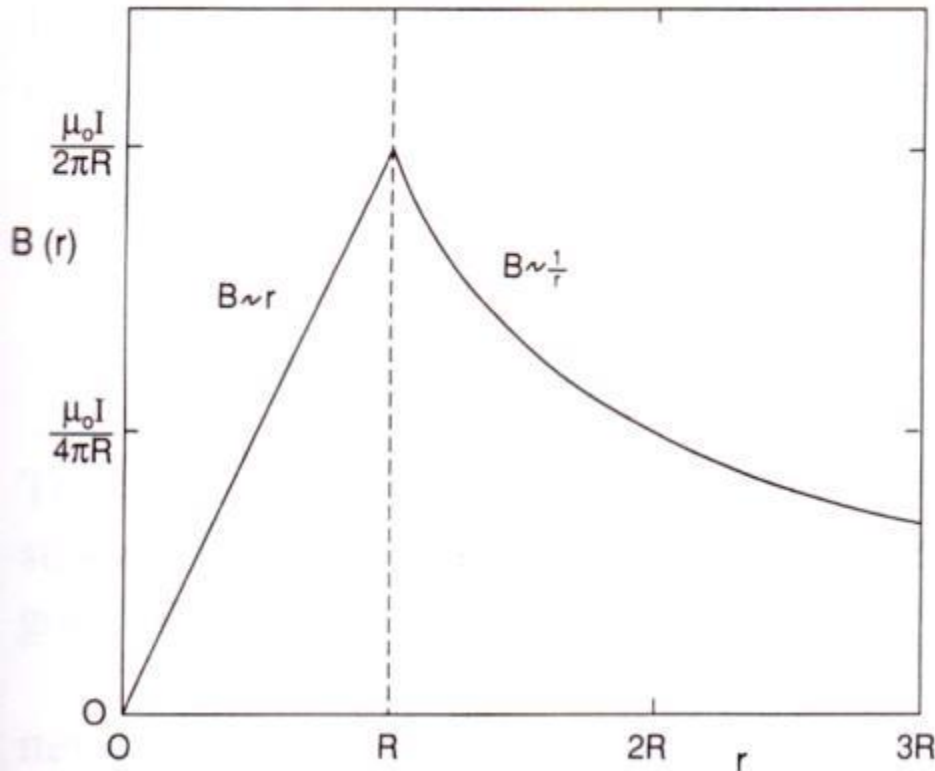

Superconductor

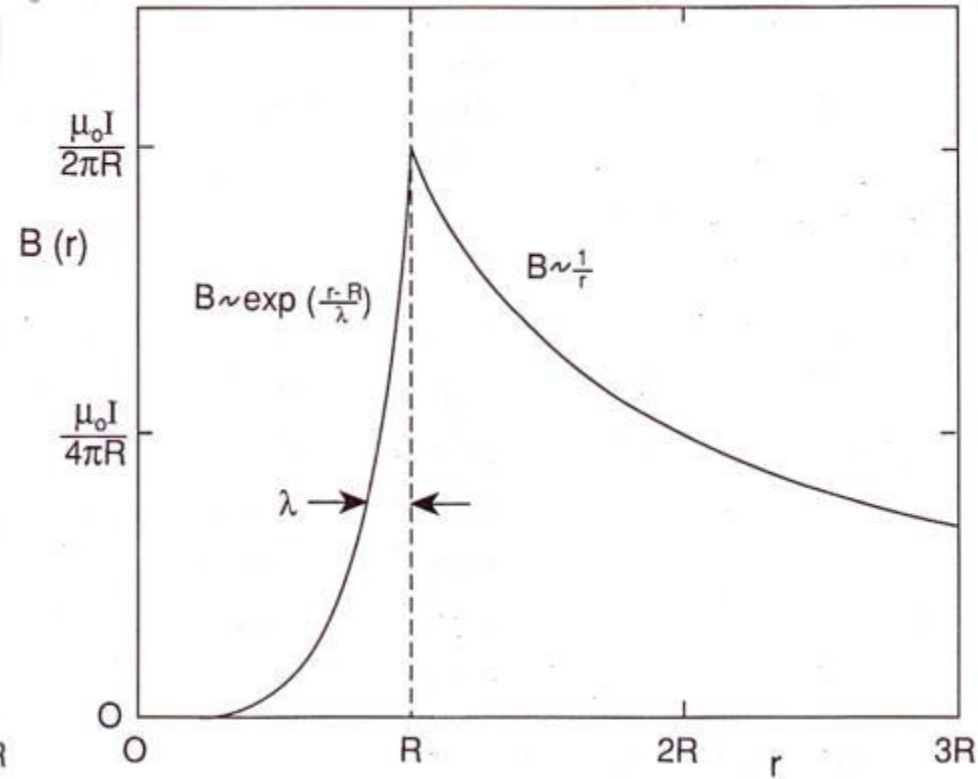

Criticality in Superconductors

*So far we have seen the effects of **temperature, magnetic field intensity, and current** on the superconducting state.*

So how do they all fit together?

Critical Magnetic Field as a Function of T

$B(t)$

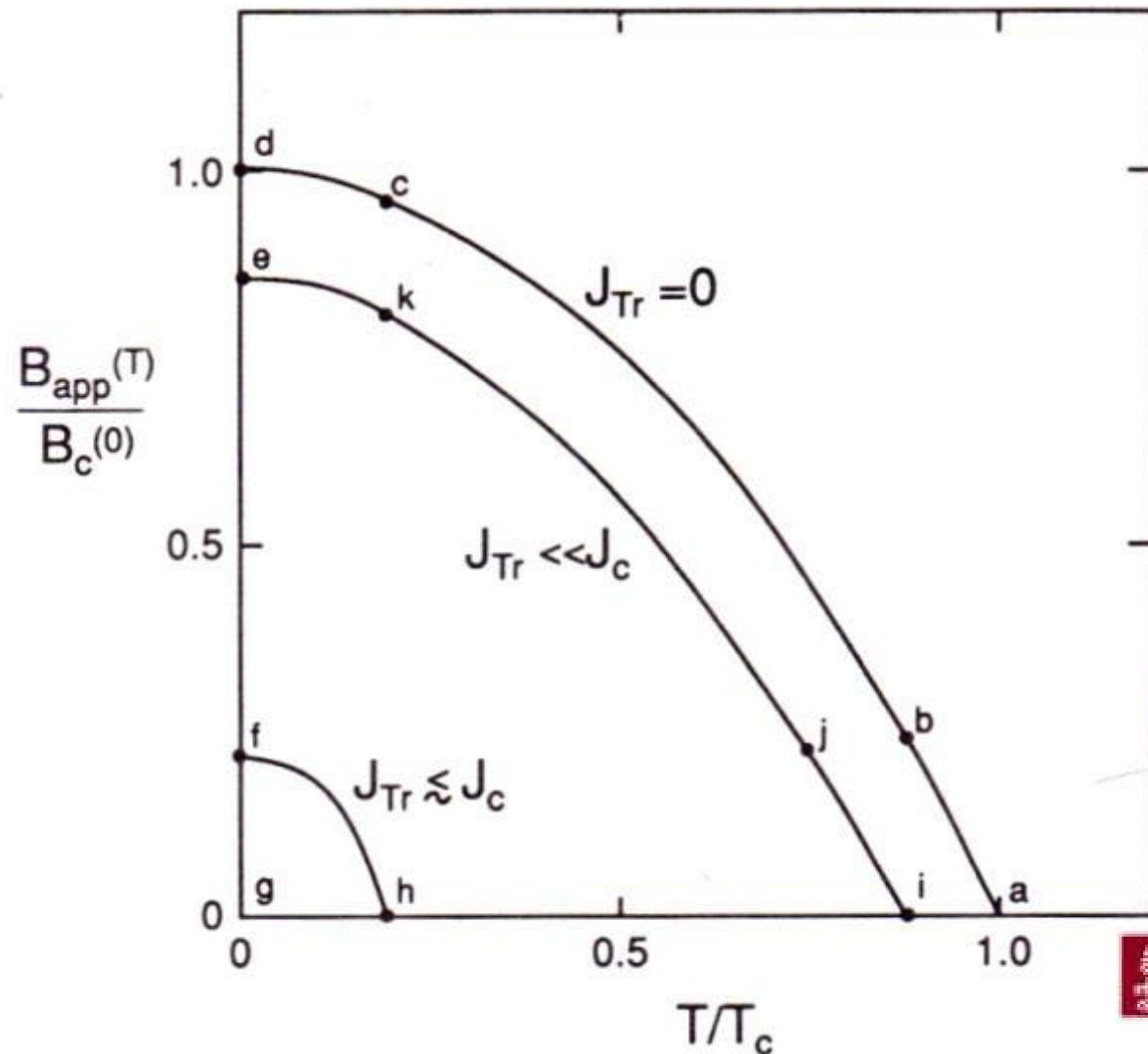

Critical Current Density as a Function of T

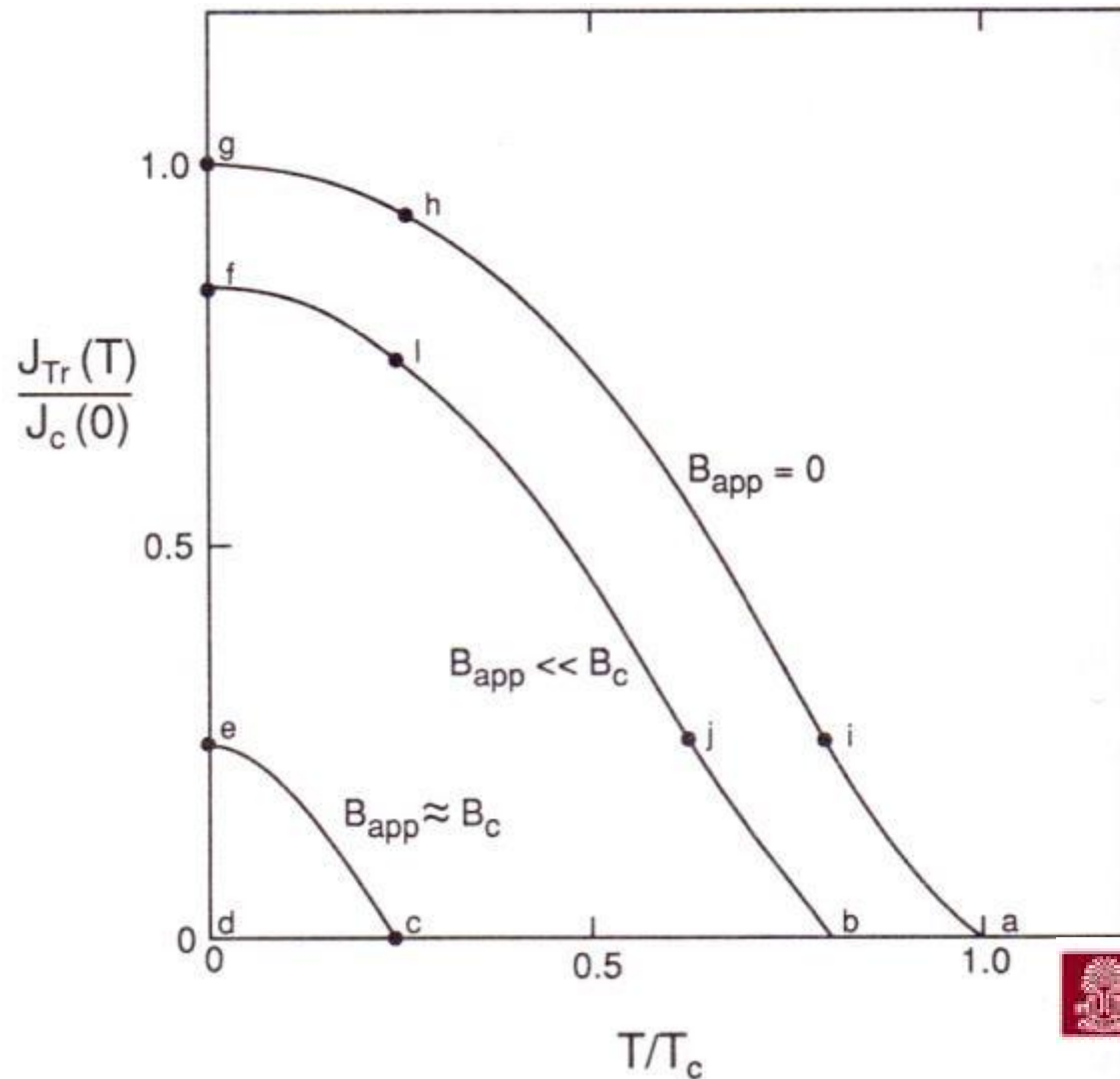

Critical Current Density as a Function of B

$J(B)$

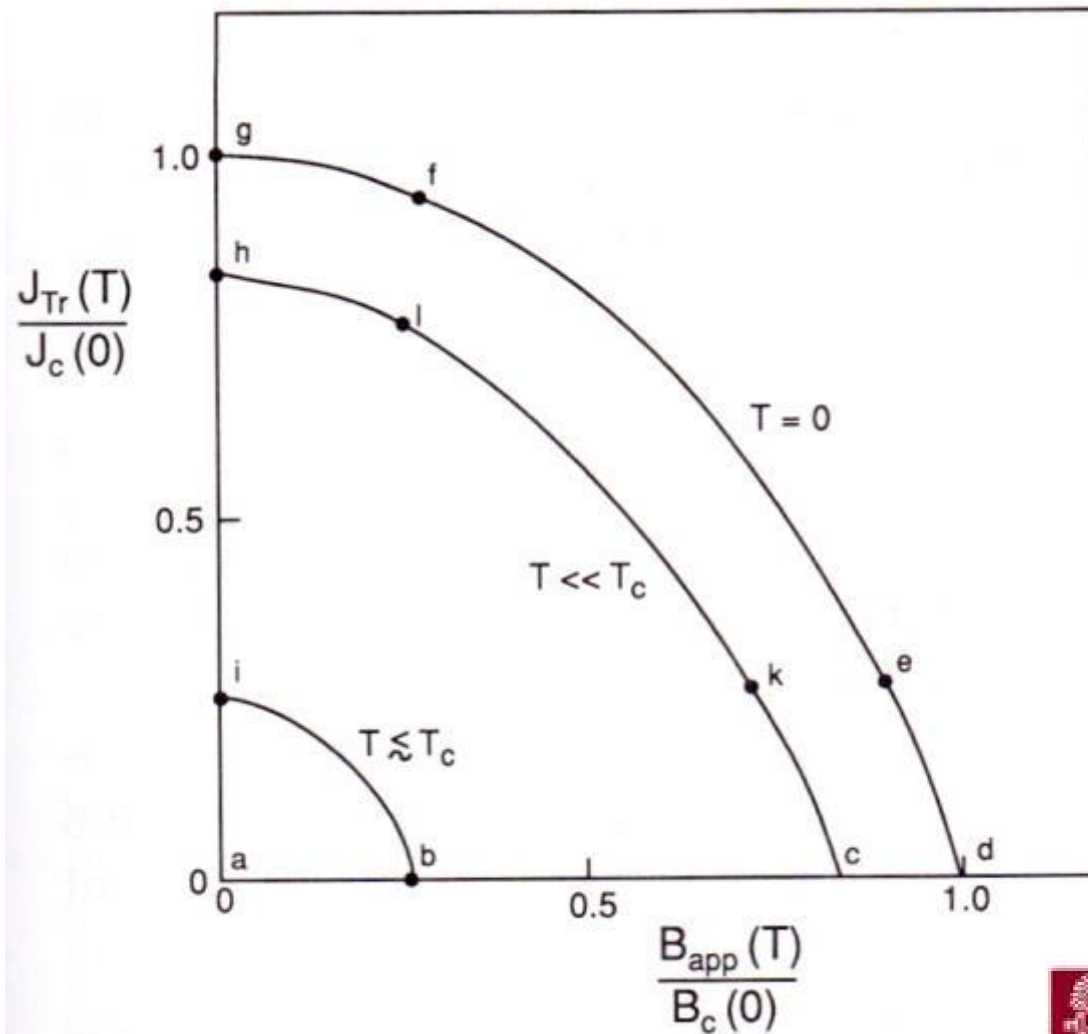

Criticality in Superconductors

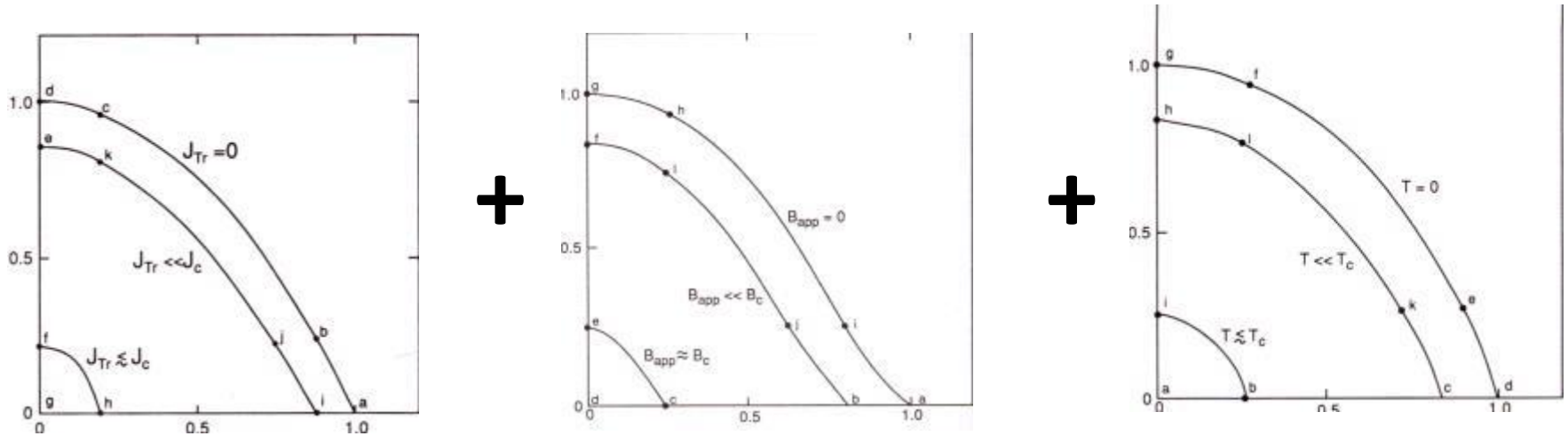

*These 3 dependencies can be plotted as functions of one another, since they are interdependent. This gives a 3-D plot of a surface, aptly named the **critical surface**, under which a material is in the SC state, and above which it is not.*

Critical Surface

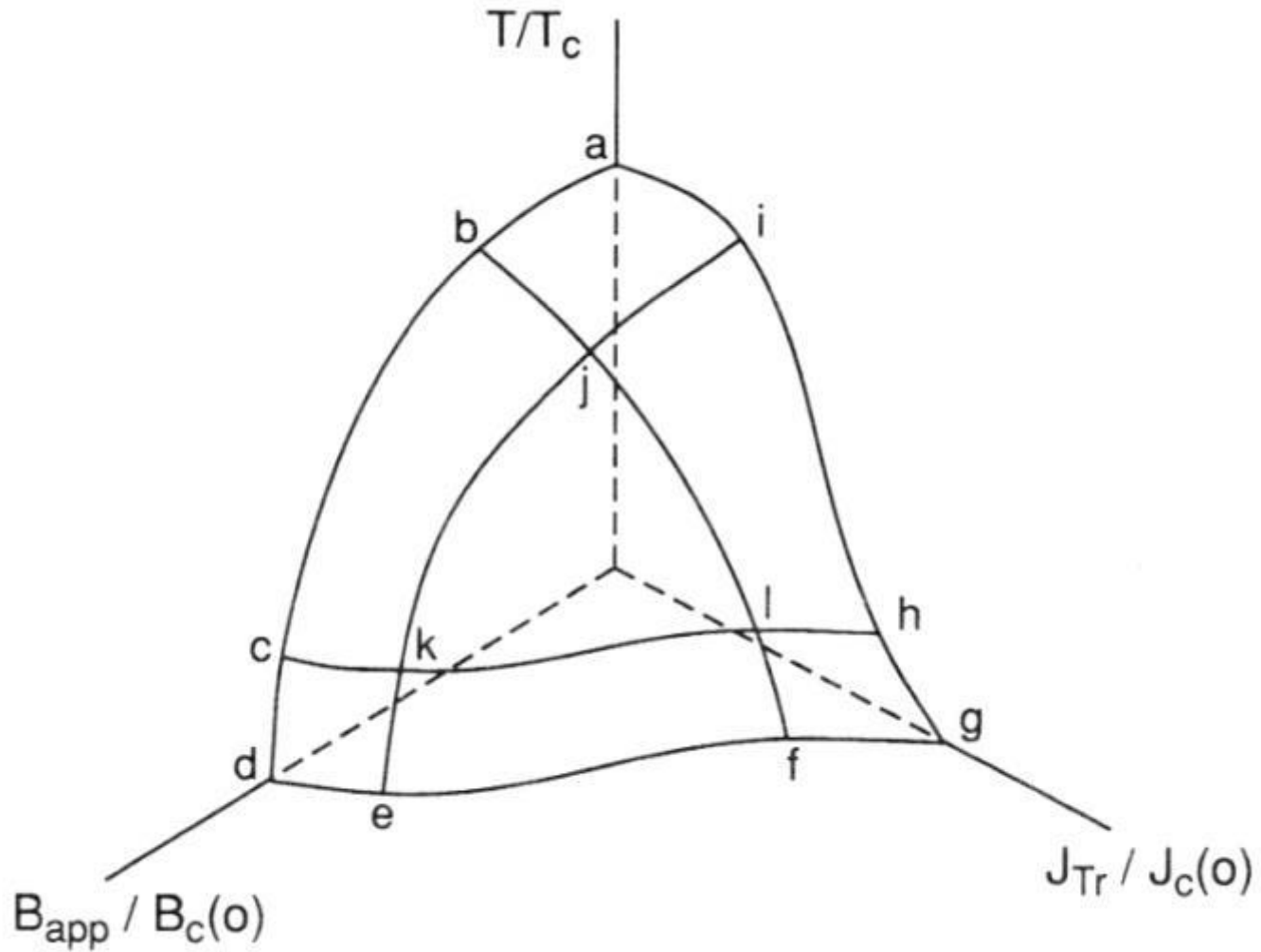

Type I & Type II Superconductors

Superconductors can be classified into two groups depending on how they deal with external magnetic fields.

***Type I** SCs do not allow any magnetic fields to penetrate the bulk of the material, like the ones we have been looking at.*

***Type II** are usually of different composition (alloys and compounds) and can accept some magnetic fields. An exception to alloyed composition is niobium; it is type II.*

*In a **Type II** there are actually 2 critical magnetic fields, B_{c1} , and B_{c2} .*

Type II Superconductors

In a **Type II** there are actually 2 critical magnetic fields, B_{c1} , and B_{c2} . Where $B_{c1} < B_{c2}$

Below B_{c1} , it acts like a type I superconductor, expelling fields.

In a **Type II** substance, there are domains of SC and non-SC regions. Above B_{c1} , but below B_{c2} , quantized flux trapped in the non-SC domains can penetrate the walls of the domains forming magnetic vortices.

Close to B_{c2} these vortices can overlap, magnetizing the sample, while maintaining zero electrical resistance.

Type II Superconductors

If a **Type II** superconductor is in a magnetic field above B_{c2} , it will then revert to a normal conducting state.

This magnetic penetration gives rise to **flux pinning**.

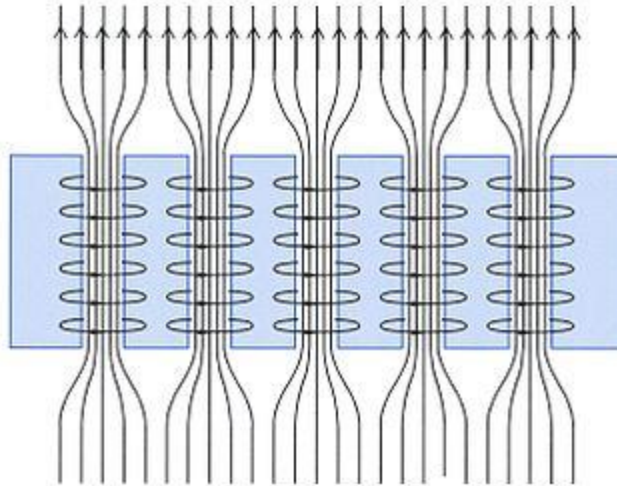

This allows [Quantum Locking Levitation](#)

Type II Superconductors

Type II are more useful in that they tend to operate at higher temperatures and critical fields.

Pros:

Higher current, temperatures, and magnetic fields.

More suited to applications.

Cons:

Tend to be exotic materials not easily discovered or fabricated.

Harder to analyze.

Not completely understood by modern theories of SC.

Evolution of Higher Temperature Superconductors

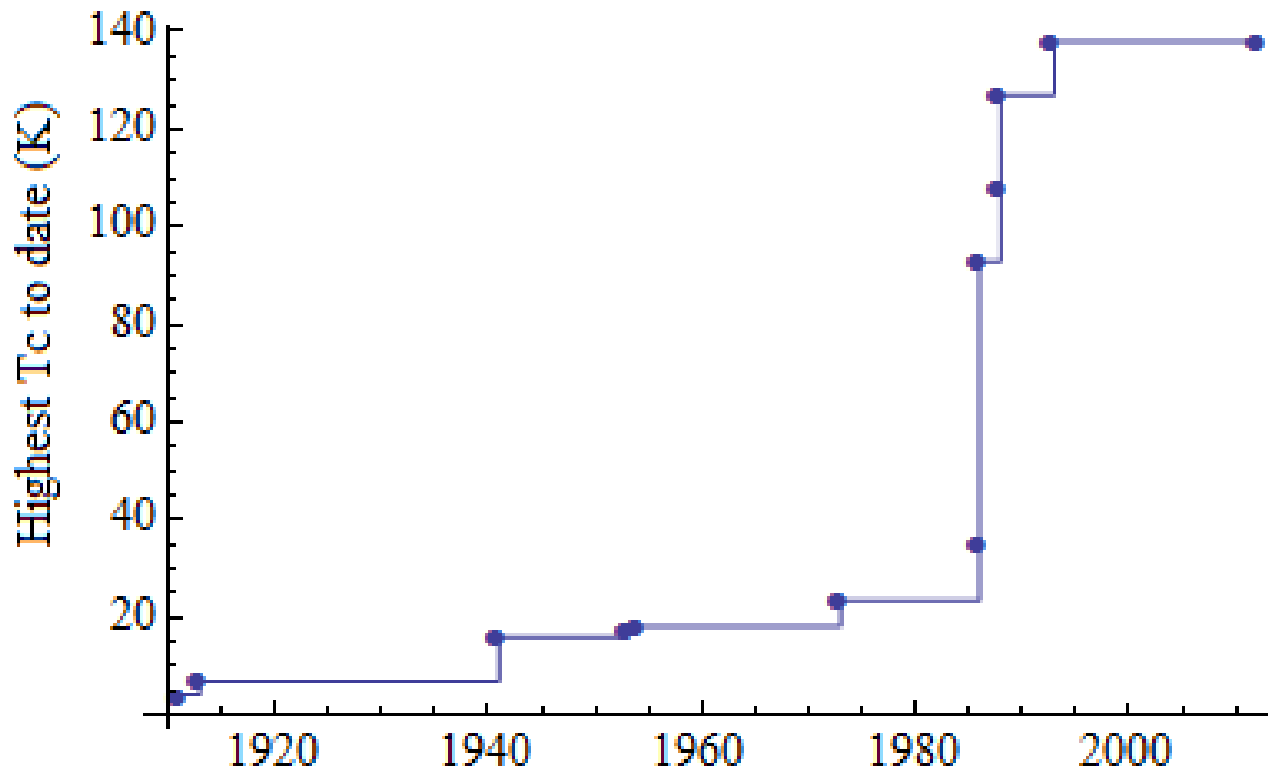

Evolution of Higher Temperature Superconductors



Yttrium Barium Copper Oxide was the first SC to operate above the boiling point of nitrogen (77K).

This was a landmark discovery because liquid N₂ is relatively cheap and available.

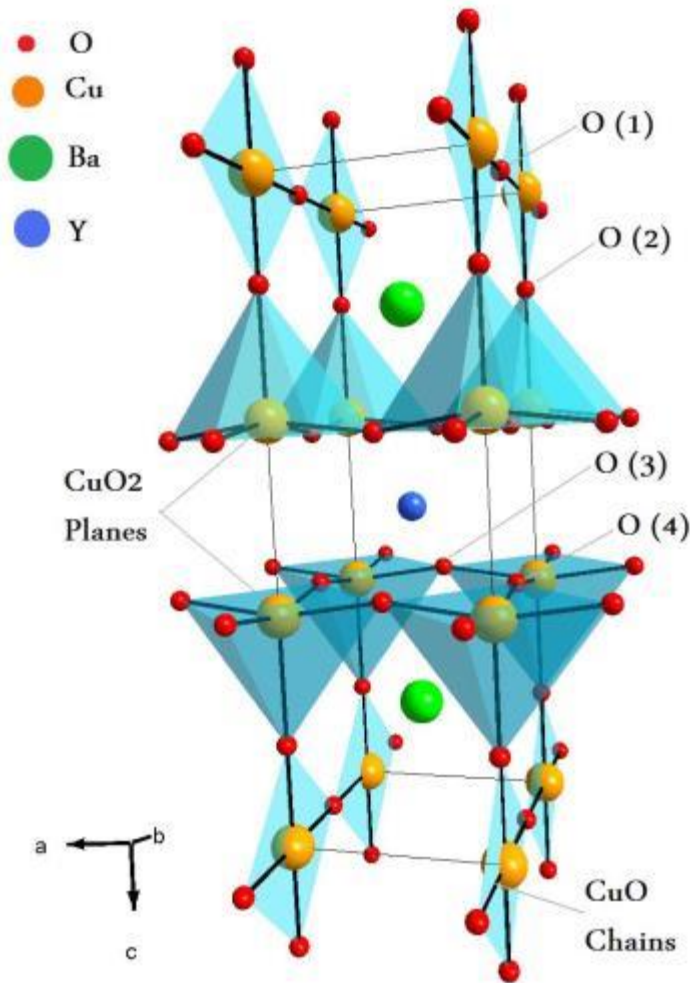

Evolution of Higher Temperature Superconductors

Formula	Notation	T_c (K)
$\text{Bi}_2\text{Sr}_2\text{CuO}_6$	Bi-2201	20
$\text{Tl}_2\text{Ba}_2\text{CuO}_6$	Tl-2201	80
$\text{Bi}_2\text{Sr}_2\text{CaCu}_2\text{O}_8$	Bi-2212	85
$\text{YBa}_2\text{Cu}_3\text{O}_7$	123	92
$\text{HgBa}_2\text{CuO}_4$	Hg-1201	94
$\text{Tl}_2\text{Ba}_2\text{CaCu}_2\text{O}_8$	Tl-2212	108
$\text{Bi}_2\text{Sr}_2\text{Ca}_2\text{Cu}_3\text{O}_6$	Bi-2223	110
$\text{TlBa}_2\text{Ca}_3\text{Cu}_4\text{O}_{11}$	Tl-1234	122
$\text{Tl}_2\text{Ba}_2\text{Ca}_2\text{Cu}_3\text{O}_{10}$	Tl-2223	125
$\text{HgBa}_2\text{CaCu}_2\text{O}_6$	Hg-1212	128
$\text{HgBa}_2\text{Ca}_2\text{Cu}_3\text{O}_8$	Hg-1223	134

Theories of Superconductivity

BCS theory (1957)

A microscopic theory of SC put forth by Bardeen, Cooper, Schrieffer. Nobel Prize in Physics awarded in 1972.

Concept: *At low temperatures, electrons form into “pairs”. The spins of these pairs, called **Cooper Pairs**, add together. Since electrons are fermions which have half-integer spin, the sum of two electron spins will result in an integer spin. Thus the electron pairs behave like bosons and can then all occupy the same quantum state. Breaking the pairing now requires raising the energy of all the pairs. Thus an **energy gap** is formed. The lattice, however, does not possess the required interaction energy because of its low temperature. This is why SCs must be cold to operate.*



Theories of Superconductivity

Ginzburg-Landau theory (1950)

A macroscopic theory of SC put forth by L. Ginzburg and L. Landau.

In a SC, the number density of Cooper pairs starts out at zero at the surface and is asymptotic to a constant value inside the bulk material. The distance over which this transition takes place is called the coherence length.

*It defines the Ginzburg-Landau Parameter: $\kappa = \lambda/\xi$, which is the ratio of the **London penetration depth** and the **coherence length**. This allows one to draw a quantitative distinction between Type I and type II. When the coherence length is shorter than the penetration depth, it is a type II superconductor.*



Josephson Effect

*When two superconductors are joined by a thin insulating barrier, Cooper pairs can quantum tunnel across the barrier, giving rise to a DC current with no outside voltage source applied. The current is a function of the phase difference of superconducting electrons on either side of the barrier. (All superconducting electrons on a given side share the same wave function) This barrier is a **Josephson Junction**.*

$$I(t) = I_c \sin(\Delta\phi(t))$$

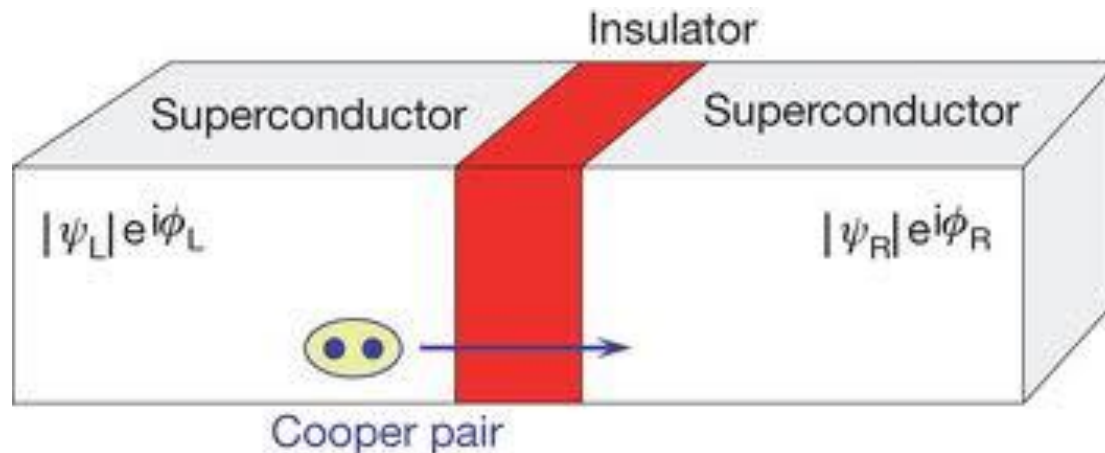

Applications of Superconductivity

Superconductors can be used in many practical applications that take advantage of their unique electric and magnetic properties.

The majority of applications involve type II superconductors due their non-zero magnetic field penetration and higher critical currents, fields, and temperatures.



S.Q.U.I.D. (Superconducting Quantum Interference Device)

- Extremely sensitive magnetometer
- Uses the DC Josephson Effect to route DC current in parallel paths around a SC loop comprising two J.J.s
- When magnetic flux penetrates the loop, shielding current arises.
- If the flux is over half the value of the fluxon, it is energetically favorable to not screen it but **increase** it to one fluxon.
- This causes the shielding current to change directions, which it continues to do for each half-integer increase in fluxons.
- This creates an AC current that gives rise to a voltage across the insulating J.J. which can be measured.

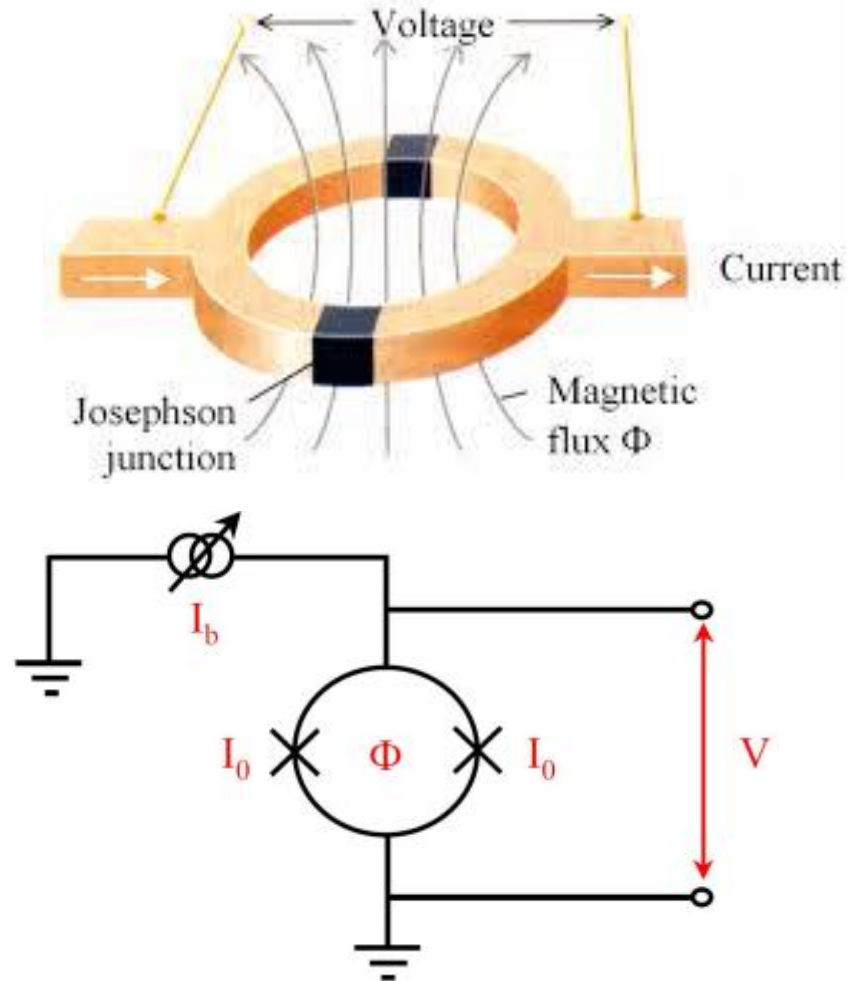

$$\Delta V = (R/L)\Delta\Phi$$

Superconducting Digital Circuits

Rapid Single Flux Quantum (RSFQ) is a method of using Josephson junctions to process digital signals.

In SC digital circuits, JJs take the place of transistors (i.e. they are the active devices)

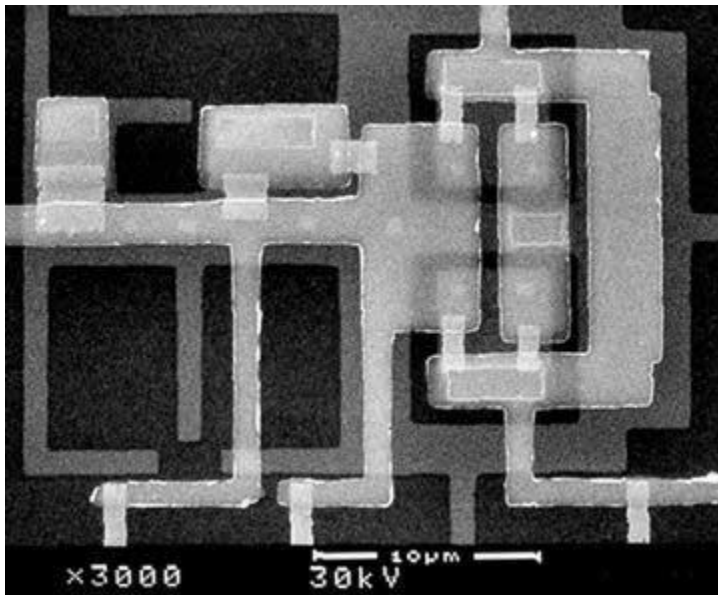

Rather than use electric charge to store a bit, a single fluxon of magnetism in a JJ is used. Hence the name “Single Flux Quantum”

Superconducting Digital Circuits

Rapid Single Flux Quantum transmission lines and a host of logic gates have been developed since the late 1970s.

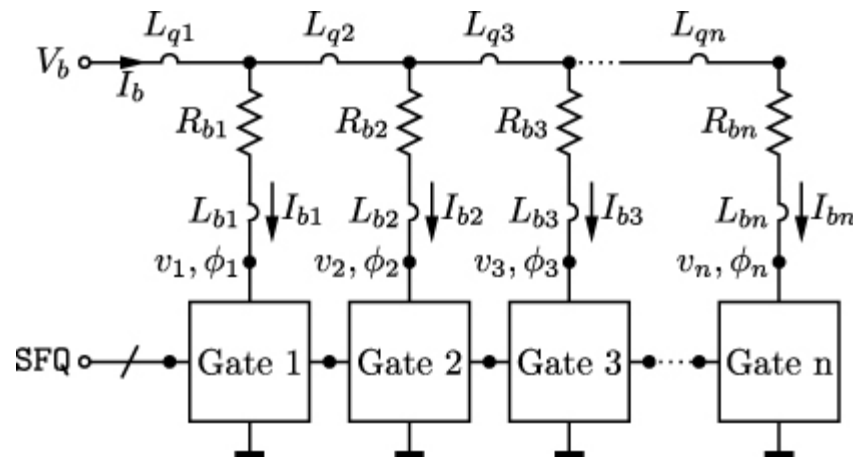

An individual RSFQ element can operate up to the characteristic frequency of a junction

$$f_c = \frac{I_c R_n}{\phi_0} = \frac{V_c}{\phi_0}$$

Superconducting Digital Circuits

Recall that the single magnetic flux quanta (fluxon) is

$$\Phi_0 = \frac{h}{2e} \approx 2.067833758(46) \times 10^{-15} \text{Wb}$$

Using the typical Nb/AlO_x/Nb junction with $V_c \cong 2\text{mV}$

$$f_c = \frac{V_c}{\Phi_0} \cong 950\text{GHz}$$

Circuits comprising these elements require nonhysteretic (overdamped) Josephson Junctions which have shunt resistances at the insulating junction. This lowers the overall operating range of a complex network to around 100GHz.

Superconducting Digital Circuits

RSFQ circuits have other advantages besides high frequency operation:

- SC transmission lines are low dispersion and low loss due to the fact that field penetration is less than a typical skin depth and not a function of frequency*
- A 100GHz processor with one million junctions is projected to consume $\sim 0.8W$ of power*
- Junctions create low voltage pulses ($\sim 2mV$) that are only a few picoseconds long and are all precisely identical*
- Negligible crosstalk at 60GHz demonstrated*



Superconducting Digital Circuits

Hurdles on the path to RSFQ computing include:

- *RSFQ is a “Disruptive” technology: it requires an industry paradigm shift*
- *RSFQ chip and multichip module (MCM) manufacturing*
- *Cryogenic RAM development*
- *Wideband input/output from 4K to ambient temperature electronics*
- ***Development of higher temperature superconductors would alleviate many of these problems***

Superconducting Magnets



- *This model is made from niobium-tin.*
- *Used in particle accelerators.*
- *Can produce around 16 tesla, twice the nominal field of the LHC.*
- *Designed to withstand heating and subsequent “quenching”.*
- *Designed by Fermilab, Brookhaven, Berkeley, and SLAC and DOE funded.*

Superconducting Magnets



Magnets of this type are used to steer beams of particles around circular tracks in particle accelerators.

Superconducting Magnets Failure

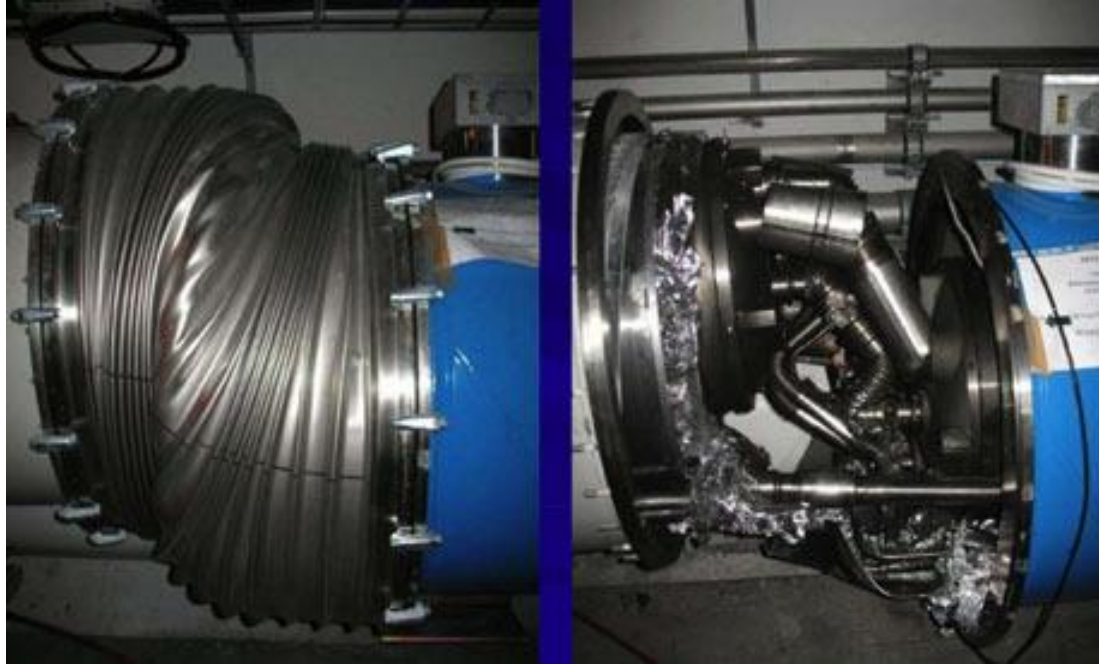

About 50 magnets were damaged at the LHC after a superconducting wire with a faulty connector became normally conducting while carrying around 13,000 amps. The explosion shifted the several ton magnets off their axes.



Cables with the same current rating: 12,500A

12500 AMPERES
CABLE
SUPRA-CONDUCTEUR



Superconductor rated for 12,500 amperes!

Particle Accelerators

- *Can be circular or straight.*
- *Largest is LHC in Geneva, with a 17 mile circumference.*
- *Smallest is the new “particle accelerator on a chip” which uses lasers to boost electrons to relativistic speeds. It is the size of a grain of rice.*
- *Used in particle physics research and nuclear medicine.*
- *Require SC magnets to steer particles in uniform circles, and SC RF cavities to accelerate them tangentially*
- *Radius of relativistic particle:*

$$R = \frac{\gamma m_p v}{qB}$$



Fermi National Accelerator Laboratory,
Batavia, Illinois

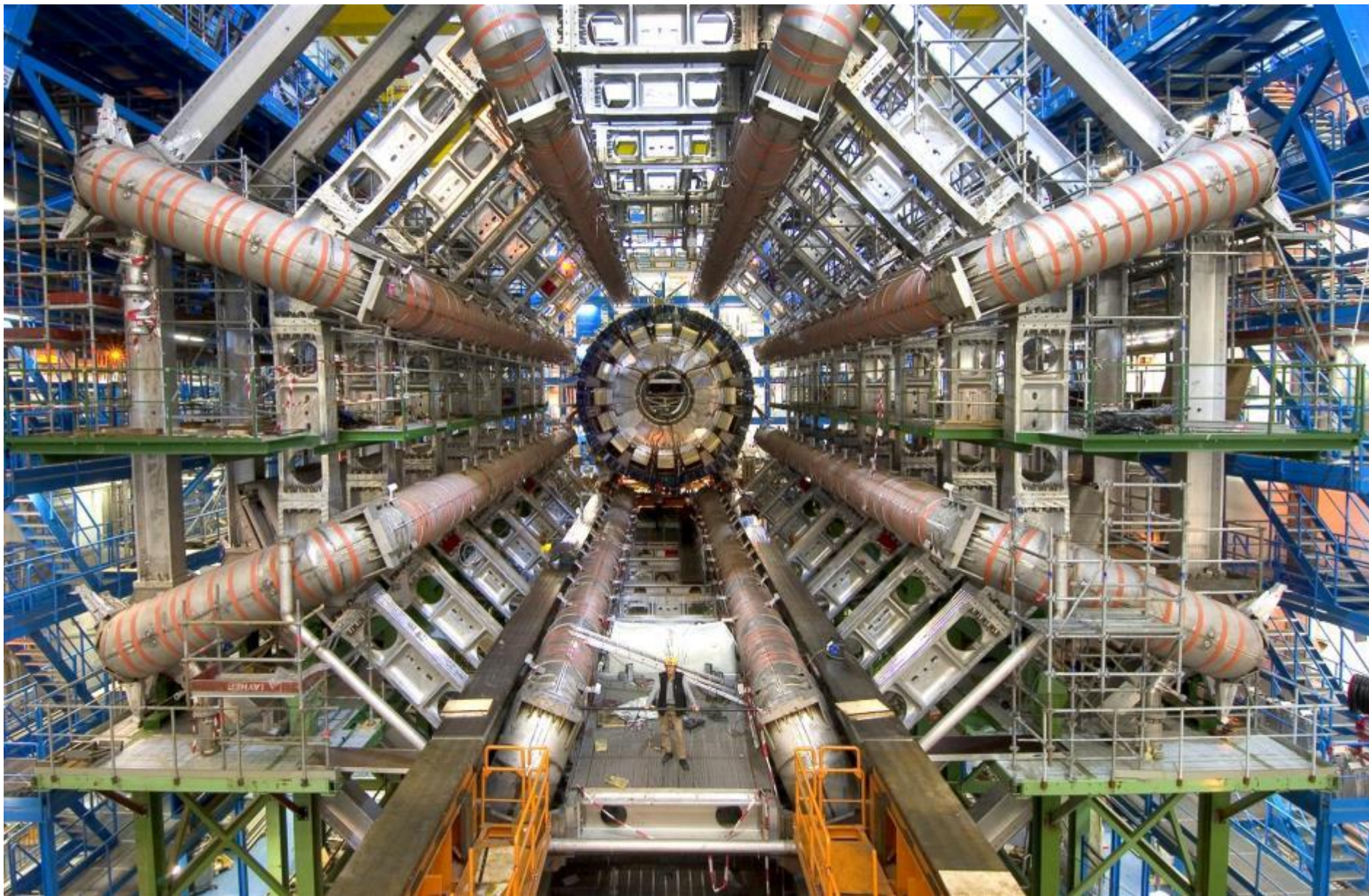

ATLAS Detector at LHC. Grey “ducts” are SC magnets.

Magnetic Resonance Imaging

- *First practical machine used in 1980*
- *Uses superconducting magnets to make resonant fields around 1.5T*
- *H Field causes atomic dipoles to align with it. They are then hit with RF waves which cause them to fall out of alignment. When the RF field is turned off the dipoles realign and emit waves.*
- *The dipoles are H₂O, which found in all human tissue.*
- *Magnets cooled with liquid Helium*



Maglev Trains

- *Not widely used to date.*
- *Superconducting versions not able to levitate at standstill and hence have wheels until they are around 5mph, then levitate.*
- *Uses type II SCs cooled with liquid nitrogen.*
- *More smooth and faster than conventional trains.*
- *More expensive than conventional trains to build but cost less due to high efficiency and low maintenance.*



Questions:

- 1) In what way could your research benefit from superconductors?
- 2) How will superconductors impact the world of electrical engineering in the coming decade?

References

- Poole, Charles, Horatio Farach, & Richard Creswick. *Superconductivity*. San Diego: Academic Press, 1995. Print.
- <http://jeppejuul.com/category/research/projects/>
- <http://www.bluesci.org/wordpress/wp-content/uploads/2011/09/MAGLEV.jpg>
- <http://www.bnl.gov/newsroom/news.php?a=21547>
- <http://www.bnl.gov/bnlweb/pubaf/pr/photos/2013/07/atlas-detector-hr.jpg>
- <http://en.wikipedia.org/wiki/Superconductivity>
- http://theory.fnal.gov/trtles/Fermilab_site.jpg
- <http://en.wikipedia.org/wiki/Maglev>

Josephson Junctions Explained:

- http://www.nature.com/nature/journal/v474/n7353/box/nature10122_BX1.html

Superconductors in Digital Logic Circuits:

- <http://pavel.physics.sunysb.edu/RSFQ/Research/WhatIs/rsfqre2m.html>
- <http://129.49.56.136/~sasha/docs/sasha/refs/pdfs/770GHzTffASC1998.pdf>
- <http://sc05.supercomputing.org/schedule/pdf/pan112.pdf>