

Index

| A | |
|--------------------------------------|----------------------------|
| Acme Compatible Labels | 69, 72 |
| Adhesive Dividers | 44 |
| Adhesive Fasteners | 31-35 |
| Adhesive Pockets | 37-38 |
| Aging Labels | 77-79 |
| All-State Legal Indexes | 47-48 |
| Allergy Labels | 84-85 |
| Alphabetic Labels | 56-68 |
| Ames Compatible Labels | 57, 69, 77-78 |
| Appointment Cards | 95-99 |
| Auto Industry Exclusives | 19-20 |
| Avery Legal Indexes | 49-50 |
| B | |
| Band Labels | 29 |
| Barkley Compatible Labels | 57-58, 70, 77-78, 80 |
| Billing Labels | 88-90 |
| Binders | 30 |
| Blank Indexes | 52 |
| Blank Labels | 81-83 |
| Blumberg Legal Indexes | 51 |
| Bonded Fasteners | 2, 34 |
| Brunswick Compatible Labels | 71 |
| C | |
| ChargeOut Slips | 36 |
| Chart Divider Tabs | 24, 45-46 |
| Chart Dividers | 24, 40-54 |
| Chart Fasteners | 2, 31-35 |
| Chart Labels | 84-90 |
| Classification Folders | 10, 15-16, 23 |
| Clinical Forms | 91-92 |
| Codeaprint.com Labeling Software | 83 |
| Collection Labels | 88-90 |
| ColorCoded Labels | 56-81 |
| Colored Folders | 3, 7, 10-11, 16, 21-24 |
| Colored Pockets | 17-19 |
| Col'R Tab Compatible Labels | 60, 71, 77-78 |
| Colwell Jewel Tone Compatible Labels | 59, 71, 77-78 |
| Communication Labels | 84-90 |
| Confidential Sign-In Sheets | 94 |
| Control-O-Fax Compatible Labels | 59, 77-78 |
| Conversion Tabs & Flaps | 33, 35-36 |
| Copier Tabs | 53-54 |
| Custom Binders & Report Covers | 30 |
| Custom Chart Dividers | 40-41 |
| Custom Expandable File Pockets | 27 |
| Custom Folders | 2, 23 |
| Custom Installed Fasteners | 2, 34 |
| Custom Presentation Folders | 30 |
| CutLess™ Folders | 24 |
| D | |
| Data File Compatible Labels | 60, 72, 79-80 |
| Dental Charting System | 93-94 |
| Divider Sheets/Tabs | 24, 45-46 |
| Dividers Custom | 40-41 |
| Dividers Fileback | 40-41, 44 |
| Dividers Self-Adhesive | 40-41, 44 |
| Dividers Table of Contents | 24 |
| DocuClip Fastener | 35 |
| E | |
| Earflap | 33 |
| End Tab Folders | 3-8, 10-15, 19 |
| Envelopes File | 18 |
| Envelopes HCFA | 92 |
| EverFile® Archival Folders | 24 |
| Exhibit Labels | 29 |
| Expandable File Pockets | 25-27 |
| Expanding Fileback | 44 |
| F | |
| Fasteners Custom Installed | 2, 34 |
| Fasteners Standard | 2-3, 31-35 |
| Fastfix™ | 81 |
| File Envelopes | 18 |
| File Fasteners | 2-3, 31-35 |
| File Folders | 2-28 |
| FILE FOLDERS | |
| Classification | 10, 15-16, 23-24 |
| Colored | 3, 7, 10-11, 16, 21-22, 24 |

| Custom | 2, 23 |
|-------------------------------|----------------------------------|
| CutLess™ | 24 |
| End Tab | 3-8, 10-15, 19 |
| EverFile® Archival | 24 |
| Expansion | 5, 7, 9, 15-16, 18, 22-23, 25-27 |
| Kardex Comparable | 21-22 |
| Mylar Reinforced | 5, 15 |
| Patent/Trademark Application | 28 |
| Pocket | 11-15 |
| Presentation | 30 |
| Pressboard | 16, 23, 30 |
| Printed | 2, 9, 19 |
| SJP Fusion™ | 23 |
| Top Tab | 9-10 |
| Tyvek Expansion | 15, 21-23 |
| W-Fold | 5, 7 |
| w/Dividers | 10, 15-16, 23 |
| w/Fasteners | 3-16, 21-24, 28 |
| w/Pockets | 11-15 |
| WaterShed™ | 24 |
| File Name Labels | 81 |
| File Outguides | 36 |
| File Pockets | 17-19, 25-27 |
| FILE POCKETS | |
| Adhesive Paper | 37 |
| Adhesive See Through | 38 |
| End Tab | 17-19 |
| Expandable | 25-27 |
| Mini | 18 |
| Top Tab | 17-19 |
| Fileback Dividers | 40-41, 44 |
| File Doctor Compatible Labels | 72 |
| Foamclip Fastener | 31-32 |
| FORMS | |
| Clinical | 91-92 |
| Dental | 93-94 |
| Insurance (HCFA) | 92 |
| Medical | 91-92 |
| Patient Sign-In | 94 |
| G | |
| GBS/VRE Compatible Labels | 64, 72, 77-78, 81 |
| H | |
| HCFA Claim Forms | 92 |
| HIPAA Labels | 85-87 |
| I | |
| IFC/AFV Compatible Labels | 72 |
| Indexes Legal | 47-54 |
| Index Tabs | 24, 40-54 |
| Index Dividers - Stock | 24, 43 |
| Index Sets - Stock | 24, 42 |
| Insurance Labels | 88-90 |
| J | |
| Jeter Compatible Labels | 61-62, 73-74, 77-80 |
| K | |
| Kardex Compatible Labels | 63, 74 |
| Kardex Comparable Folders | 21-22 |
| Key Tags | 20 |
| Kraft Pockets | 18, 37 |
| L | |
| LABELS | |
| Aging | 77-79 |
| Allergy | 84-85 |
| Alphabetic | 56-68 |
| Bands | 29 |
| Billing | 88-90 |
| Blank | 24, 81-83 |
| Chart | 84-90 |
| Collection | 88-90 |
| ColorCoded | 56-81 |
| Communication | 84-90 |
| Designator | 80 |
| Exhibit | 29 |
| HIPAA | 85-87 |
| Insurance | 88-90 |
| Laser | 24, 81-83 |
| MAP Compatible | 77-78 |
| Month | 79 |
| Name | 81 |

| Numeric | 69-76 |
|---------------------------------------|---------------------|
| PlazStyx™ | 24 |
| Protectors | 81 |
| Recycled | 24 |
| Software | 83 |
| Solid Color | 80 |
| Transcription | 82 |
| Vehicle Make | 20 |
| Year | 77-78 |
| Label Protectors | 81 |
| Laser Appointment Cards | 95-99 |
| Legal Industry Exclusives | 29-30 |
| Legal Indexes | 47-54 |
| Lock-It Pockets | 38 |
| M | |
| Medical Alert Labels | 86-87 |
| Medical Charting System | 91 |
| MediClip Fastener | 35 |
| Month Labels | 79 |
| Mylar Protectors | 81 |
| N | |
| Name Label Protectors | 81 |
| Name Labels | 81 |
| Never-Jam Copier Tabs | 53-54 |
| Numeric Labels | 69-76 |
| O | |
| On-Demand Labels | 83 |
| Open Shelf Folders | 3-16, 21-22 |
| Outguides | 36 |
| P | |
| Patent Application Folders | 28 |
| PlazStyx™ Labels | 24 |
| PMA Compatible Labels | 56 |
| Pocket Folders | 11-15 |
| Pockets Factory Applied | 37 |
| Pockets File | 11-15 |
| Pockets See Through | 38 |
| POS Compatible Labels | 64, 68, 73, 77 |
| Presentation Folders | 30 |
| Pressboard Folders | 16, 23, 30 |
| Pressure Sensitive Fasteners | 31-35 |
| Pressure Sensitive Pockets | 38 |
| Progress Notes | 42-43, 45-47, 91-93 |
| R | |
| Recall Cards | 95-99 |
| Recycled Labels | 24 |
| Reinforcing Strips | 33, 35 |
| Report Covers | 30 |
| Reynolds & Reynolds Compatible Labels | 20, 65, 73, 77-79 |
| S | |
| Safeguard Compatible Labels | 65, 77-78 |
| Sales Jackets | 19 |
| Sav-Tyme Compatible Labels | 75 |
| Self-Adhesive Dividers | 44 |
| SJ Paper | 23-24 |
| SJP Fusion™ Classification Folders | 23 |
| Slash Pockets | 17 |
| Smead Compatible Labels | 66, 75, 77-78, 80 |
| Solid Color Labels | 80 |
| Speedex™ Table of Contents Dividers | 24 |
| Strip Labels | 2, 83 |
| Sycom Compatible Labels | 58, 70, 79 |
| T | |
| TAB Compatible Labels | 67-68, 76-80 |
| Traco Compatible Labels | 77-78 |
| Trademark Application Folders | 28 |
| Transcription Labels | 82 |
| U V W | |
| UClip Fastener | 35 |
| UFileM Strip | 12-13, 35 |
| Vehicle Make Labels | 20 |
| Vinyl Outguides | 36 |
| Vinyl Pockets | 38 |
| WaterShed™ Folders | 24 |
| Window Stock Stickers | 20 |
| Y Z | |
| Year Labels | 77-78 |
| Ziplock Pockets | 38 |

Stock Folders 1

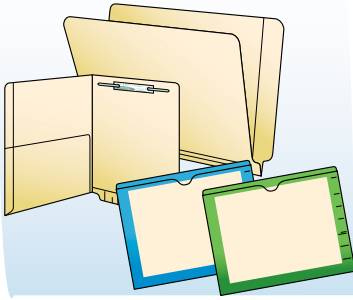

Pressboard 16



Auto Exclusives 19

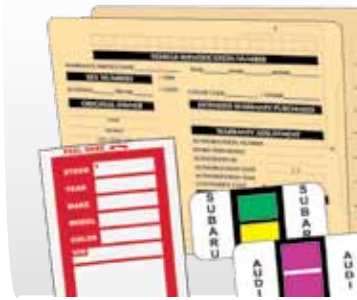

SJ Paper Products 23



Expandable File Pockets 25

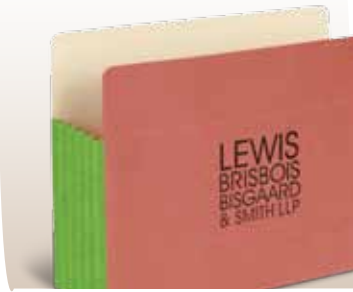

Legal Exclusives 29



Fasteners 31

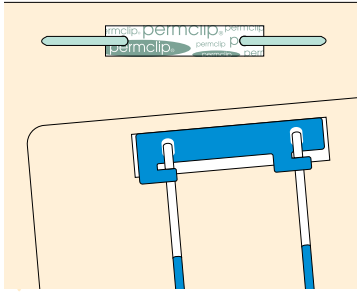

Outguides 36



Pockets 37



Stock Chart Dividers 42

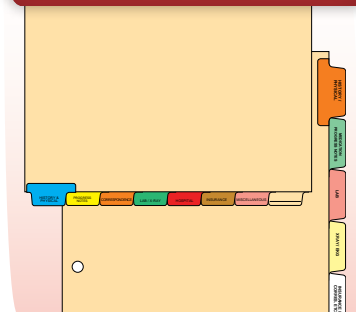

Self-Adhesive Dividers 44

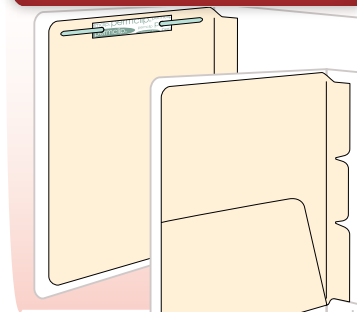

Index Tabs 45

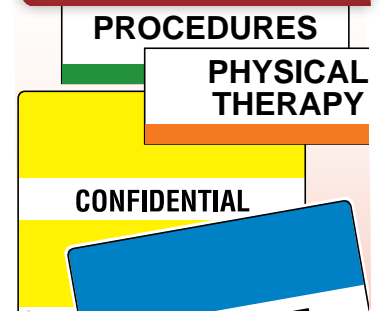

Legal Indexes 47

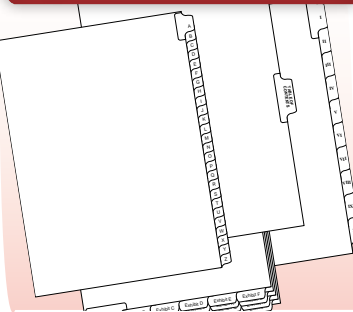

Never-Jam™ Copier Tabs 53

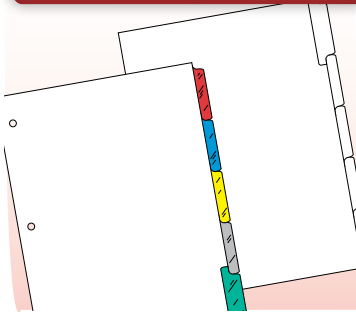

Color Code Labels 55



Month & Year Labels 77

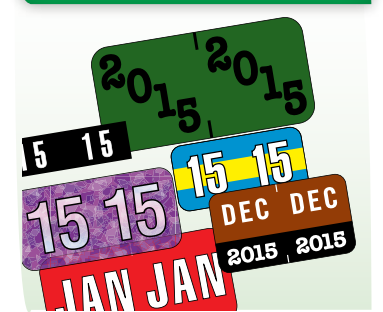

Codeaprint.com 83



Chart Labels 84



Forms 91

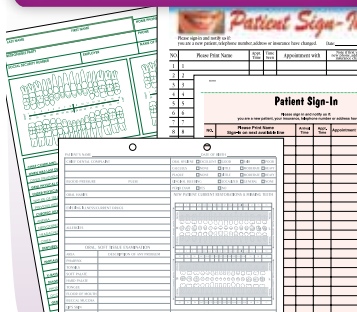

Appt Reminder Cards 95



Folders

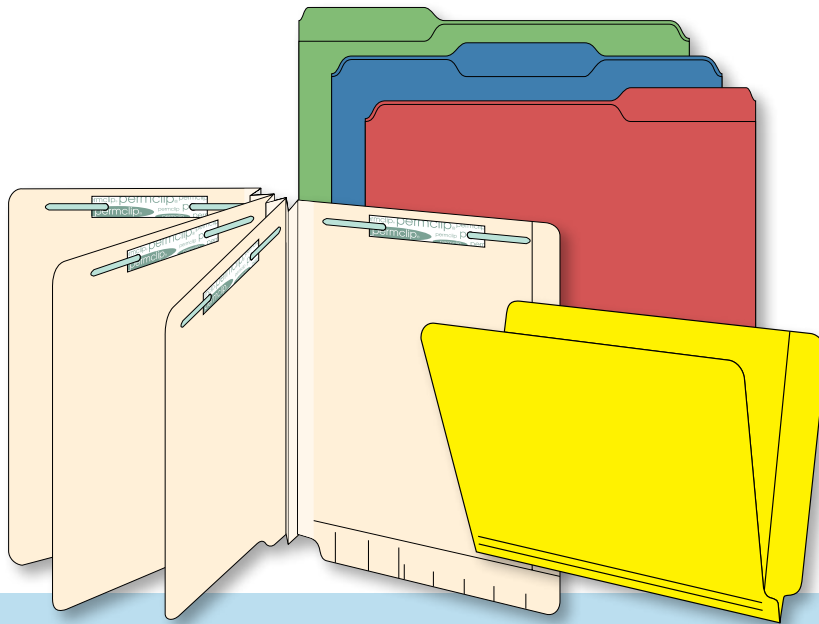

File Folders

The folder is the most fundamental record management tool for:

- document storage and retrieval
- information management
- document privacy and protection
- presentation

From Stock to Custom and In-Between

We feature over 300 stock file folders and file pockets in a wide range of sizes and colors to match many of today's most popular systems. From end tab to top tab, manila or color, dividers, and expansion, we're bound to have a solution to your filing needs.

In addition to the great selection of stock file folders, we offer a large collection of value-added folder components such as fasteners, dividers, pockets, and labels.

When a stock or value-added solution doesn't meet your filing or presentation needs, we can customize a folder that satisfies your exact requirements.

Markets

Our custom filing products and solutions can be tailored to enhance a variety of industry filing applications.

HEALTHCARE



LEGAL



AUTOMOTIVE



INSURANCE / BANKING



WE'RE CUSTOM FILING EXPERTS

Whether it's a simple printed logo, or a custom crafted classification folder, our expertise and craftsmanship are unmatched.

CUSTOM OPTIONS INCLUDE

- Custom Construction
- Paper Colors & Weights
- Fasteners
- Printing
- Dividers
- Indexes
- Applied Labels
- Constructed Pockets
- Applied Pockets
- Reinforcing
- Custom Expansion
- Bar Coding
- Consecutive Numbering

TYVEK® GUSSET EXPANSION

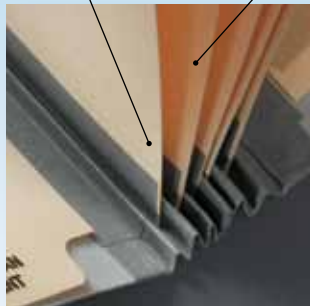

DIVIDERS

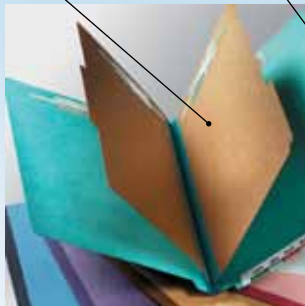

CUSTOM CONSTRUCTION



CONSTRUCTED POCKET



BORDER PRINTING



CONSECUTIVE NUMBERING

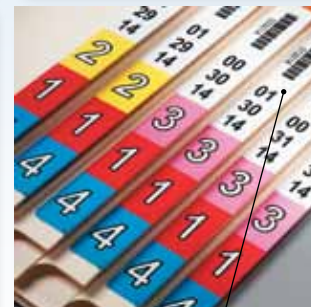

APPLIED STRIP LABEL WITH BAR CODE

PRINTING

FASTENERS

Factory installed fasteners or clips can be ordered in any position. Please refer to the charts for clip and fastener position numbers.

permclip® - Heat bonded to the surface of the folder and nearly impossible to rip from the folder.

Medi-Clip - This unique fastener converts any file folder into a ring binder, loose-leaf format.

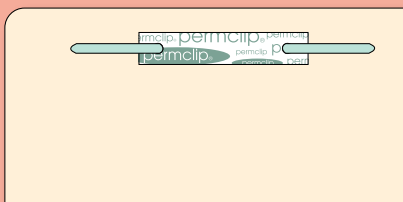

PERMCLIP®

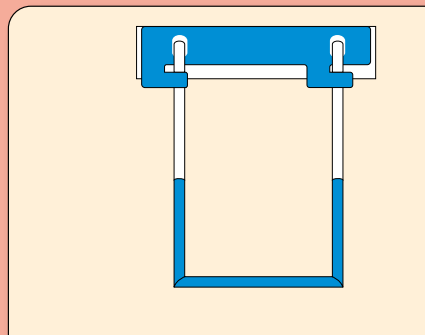

MEDI-CLIP

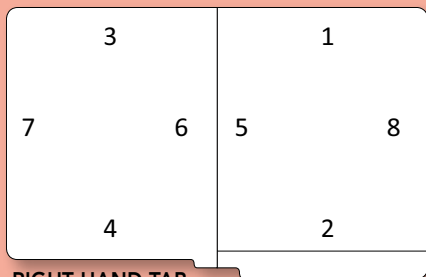

RIGHT HAND TAB

When ordering, state the folder item number, size of the fastener, type of the fastener and the desired position(s).

Example: MRS10213 – MRS10 base folder, 2" fastener, position #1 and #3.

Pay special attention to fastener positions when ordering a left-hand tab folder or pocket folders.

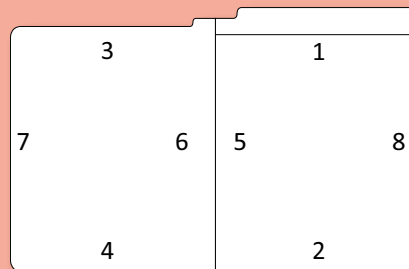

LEFT HAND TAB

Reinforced End Tab Folders

MRS10 & MRS20 | CRS10 & CRS15

Comparable to Tab, Smead, Barkley – AS15X & AS25X, TB1103 & TB1123

- Overall Size: 9-1/2" H x 12-1/4" W
- Front Size: 9-1/2" H x 11-3/4" W
- Undercut to: 11-3/8"
- Reinforced end tab
- Tab Length: 8-1/2"
- Scored for 3/4" expansion

| Item # | Paper Weight | Fastener Position | Qty per box | Qty per Ctn | Lb / 1,000 |
|------------|--------------|-------------------|-------------|-------------|------------|
| MRS10 | 11pt | None | 100 | 500 | 90 |
| MRS1021 | 11pt | 1 | 50 | 250 | 95 |
| MRS10213 | 11pt | 1 & 3 | 50 | 250 | 100 |
| MRS20 | 14pt | None | 50 | 250 | 110 |
| MRS2021 | 14pt | 1 | 50 | 250 | 115 |
| MRS20213 | 14pt | 1 & 3 | 50 | 250 | 120 |
| MRSD10* | 11pt | None | 100 | 500 | 90 |
| MRSD1021* | 11pt | 1 | 50 | 250 | 95 |
| MRSD10213* | 11pt | 1 & 3 | 50 | 250 | 100 |

*9" high front panel

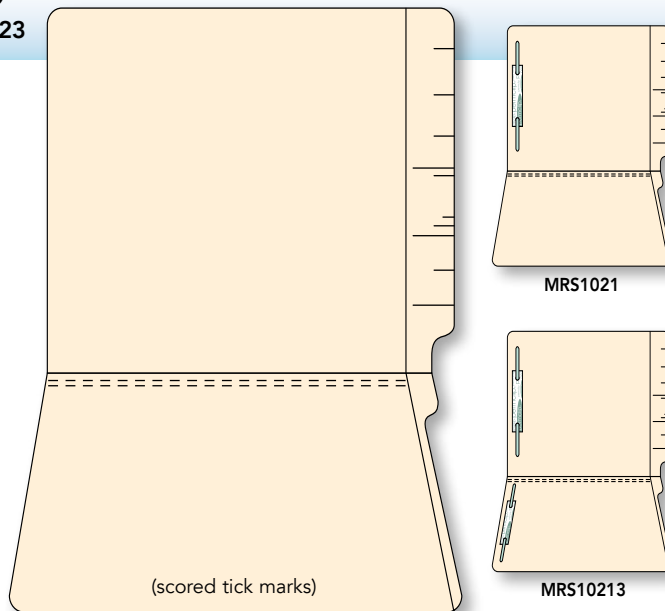

MRS10

MRS10 also available single ply: AS13X

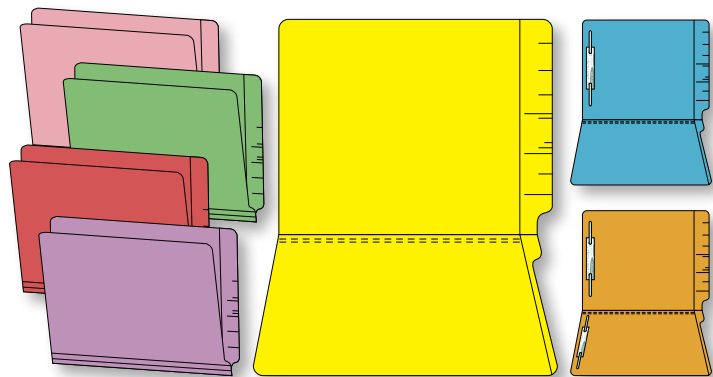

| Item # | Paper Weight | Fastener Position | Qty per box | Qty per Ctn | Lb / 1,000 |
|------------------|--------------|-------------------|-------------|-------------|------------|
| CRS10** + color | 11pt | None | 100 | 500 | 95 |
| CRS1021 + color | 11pt | 1 | 50 | 250 | 100 |
| CRS10213 + color | 11pt | 1 & 3 | 50 | 250 | 105 |
| CRS15*** + color | 15pt | None | 50 | 250 | 110 |
| CRS1521 + color | 15pt | 1 | 50 | 250 | 115 |
| CRS15213 + color | 15pt | 1 & 3 | 50 | 250 | 120 |



AS15X + color *AS25X + color

| 18 Available 11pt Colors | | | | | | | | |
|--------------------------|-------------|-----------|-----------|------------|--------|--------|--------|----------|
| red | yellow | pink | green | white | brown | blue | orange | tan |
| gray | dark orange | dark gray | dark blue | dark green | purple | canary | gldnrd | lavender |

| 11 Available 15pt Colors | | | | | |
|--------------------------|-------------|-----------|-----------|--------|----------|
| red | canary | pink | green | white | lavender |
| gray | dark orange | dark gray | dark blue | gldnrd | |

TB1103 & TB1123 only available in manila

MRS10L & MRS20L

Comparable to Tab, Smead, Barkley – AS35X & AS45X

Overall Size: 9-1/2" H x 15-1/4" W, Front Size: 9-1/2" H x 14-3/4" W, Undercut to: 14-3/8", Tab Length: 8-1/2", Scored for 3/4" expansion

| Item # | Paper Weight | Fastener Position | Qty per box | Qty per Ctn | Lb / 1,000 |
|-----------|--------------|-------------------|-------------|-------------|------------|
| MRS10L | 11pt | None | 100 | 500 | 125 |
| MRS10L21 | 11pt | 1 | 50 | 250 | 130 |
| MRS10L213 | 11pt | 1 & 3 | 50 | 250 | 135 |
| MRS20L | 14pt | None | 50 | 250 | 140 |
| MRS20L21 | 14pt | 1 | 50 | 250 | 145 |
| MRS20L213 | 14pt | 1 & 3 | 50 | 250 | 150 |

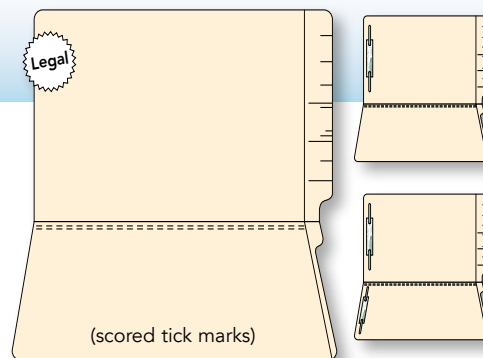

MRS20L also available single ply: AS43X

FASTENER POSITIONS

RIGHT HAND TAB FOLDER

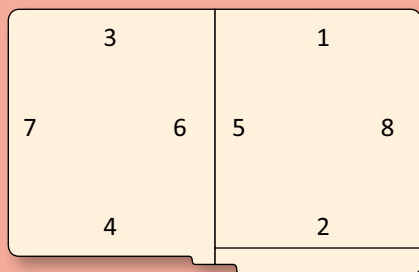

Fasteners or clips can be ordered in any position. Please refer to the charts for clip and fastener position numbers. When ordering, state the folder item number, size of the fastener, type of the fastener and the desired position(s).

Example: MRS10213 – MRS10 base folder, 2" fastener, position #1 and #3.

Pay special attention to fastener positions when ordering a left-hand tab folder or pocket folders.

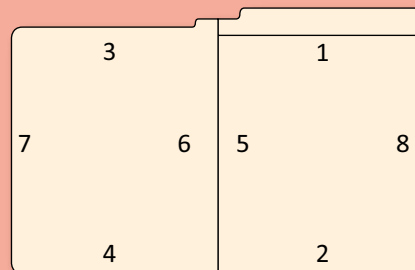

LEFT HAND TAB FOLDER

JRET11 & JRET14

Comparable to Jeter – JT1050 & JT1241

Overall Size: 9-1/2" H x 12-1/4" W, Front Size: 9-1/2" H x 11-3/4" W, Undercut to: 11-3/8", Tab Length: 8-1/2", Scored for 3/4" expansion

| Item # | Paper Weight | Fastener Position | Qty per box | Qty per Ctn | Lb / 1,000 |
|-----------|--------------|-------------------|-------------|-------------|------------|
| JRET11 | 11pt | None | 100 | 500 | 90 |
| JRET1121 | 11pt | 1 | 50 | 250 | 95 |
| JRET11213 | 11pt | 1 & 3 | 50 | 250 | 100 |
| JRET14 | 14pt | None | 50 | 250 | 110 |
| JRET1421 | 14pt | 1 | 50 | 250 | 115 |
| JRET14213 | 14pt | 1 & 3 | 50 | 250 | 120 |

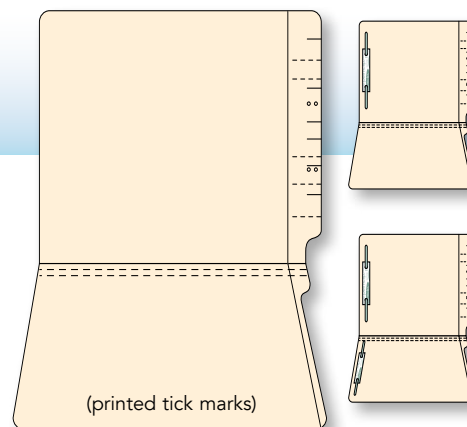

JRET14 also available single ply: JT1231

MR11 & MR15

Comparable to Jeter – TR1490R, SF29X, & JT2241 (MR15 Matches)

Overall Size: 9-1/2" H x 12-1/4" W, Front Size: 9-1/2" H x 11-3/8" W, Tab Length: 9-3/8", Scored for 3/4" expansion

| Item # | Paper Weight | Fastener Position | Qty per box | Qty per Ctn | Lb / 1,000 |
|---------|--------------|-------------------|-------------|-------------|------------|
| MR11 | 11pt | None | 100 | 500 | 95 |
| MR1121 | 11pt | 1 | 50 | 250 | 100 |
| MR11213 | 11pt | 1 & 3 | 50 | 250 | 105 |
| MR15 | 14pt | None | 50 | 250 | 110 |
| MR1521 | 14pt | 1 | 50 | 250 | 115 |
| MR15213 | 14pt | 1 & 3 | 50 | 250 | 120 |

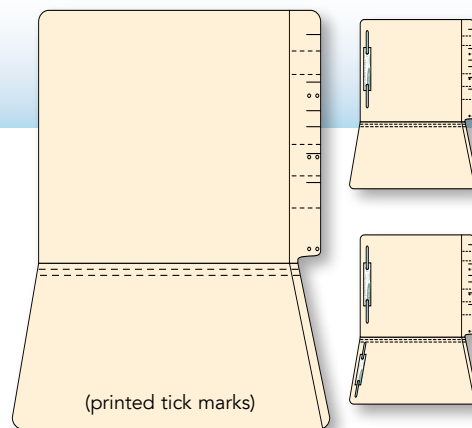

MAM11 & MAM15

Comparable to Ames – AM1190RTS & AM1590RTS

Overall Size: 9-1/2" H x 12-1/4" W, Front Size: 9-1/2" H x 11-3/8" W, Tab Length: 9", Scored for 1-3/8" expansion, Interlocking reinforced top and end tab

| Item # | Paper Weight | Fastener Position | Qty per box | Qty per Ctn | Lb / 1,000 |
|----------|--------------|-------------------|-------------|-------------|------------|
| MAM11 | 11pt | None | 100 | 500 | 105 |
| MAM1121 | 11pt | 1 | 50 | 250 | 110 |
| MAM11213 | 11pt | 1 & 3 | 50 | 250 | 115 |
| MAM15 | 14pt | None | 50 | 250 | 130 |
| MAM1521 | 14pt | 1 | 50 | 250 | 135 |
| MAM15213 | 14pt | 1 & 3 | 50 | 250 | 140 |

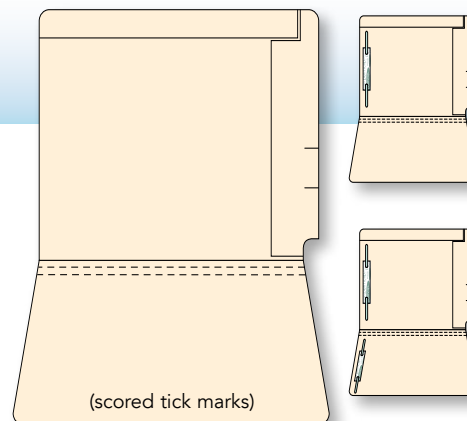

End Tab Folders

M11SH

Comparable to Barkley

- Overall Size: 9-1/2" H x 12" W
- Front Size: 9" H x 11-1/4" W
- Tab Length: 8-1/2"
- Scored for 3/4" expansion
- Reinforced top and end tab

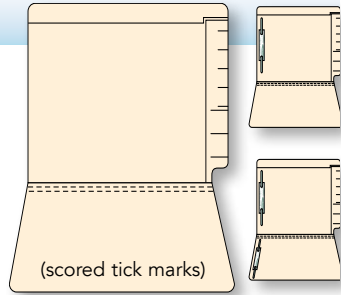

| Item # | Paper Weight | Fastener Position | Qty per box | Qty per Ctn | Lb / 1,000 |
|----------|--------------|-------------------|-------------|-------------|------------|
| M11SH | 11pt | None | 100 | 500 | 105 |
| M11SH21 | 11pt | 1 | 50 | 250 | 110 |
| M11SH213 | 11pt | 1 & 3 | 50 | 250 | 115 |

10% post-consumer waste

M11BC

Border Printed Folder

- Overall Size: 9-1/2" H x 12-1/4" W
- Front: 9-1/2" H x 11-3/4" W
- Undercut to: 11-3/8"
- Tab Length: 8-1/2"
- Scored for 3/4" expansion

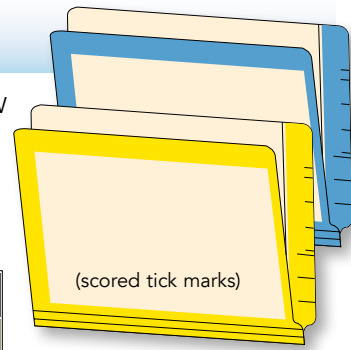

| M11BC Colors | | | | |
|--------------|--------|------|-------|--------|
| red | yellow | pink | green | brown |
| gray | orange | tan | blue | violet |

| Item # | Paper Weight | Fastener Position | Qty per box | Qty per Ctn | Lb / 1,000 |
|------------------|--------------|-------------------|-------------|-------------|------------|
| M11BC + color | 11pt | None | 100 | 500 | 90 |
| M11BC21 + color | 11pt | 1 | 50 | 250 | 95 |
| M11BC213 + color | 11pt | 1 & 3 | 50 | 250 | 100 |

10% post-consumer waste

MW15

2" W-Fold Expansion Folder
Comparable to Ames

- Overall Size: 9-1/2" H x 12-1/4" W
- Front Size: 9-1/2" H x 11-3/8" W
- Tab Length: 9-3/8"
- Scored for 2" W-fold expansion
- Interlocking reinforced top and end tab
- Ships bulk packed, flat

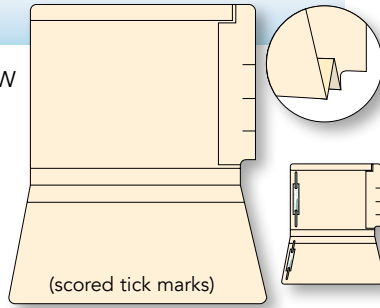

| Item # | Paper Weight | Fastener Position | Qty per Ctn | Lb / 1,000 |
|---------|--------------|-------------------|-------------|------------|
| MW15 | 14pt | None | 200 | 95 |
| MW1521 | 14pt | 1 | 150 | 100 |
| MW15213 | 14pt | 1 & 3 | 150 | 105 |

10% post-consumer waste

AM1590RTS-W

1-3/4" W-Fold Expansion Folder
Comparable to Ames

- Overall Size: 9-1/2" H x 12-1/4" W
- Front Size: 9-1/2" H x 11-3/8" W
- Tab Length: 9-3/8"
- Scored for 1-3/4" W-fold expansion
- Interlocking reinforced top and end tab
- Ships bulk packed, flat

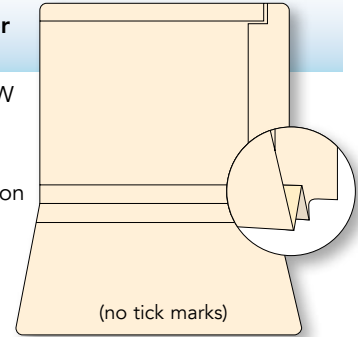

| Item # | Paper Weight | Fastener Position | Qty per Ctn | Lb / 1,000 |
|----------------|--------------|-------------------|-------------|------------|
| AM1590RTS-W | 14pt | None | 150 | 95 |
| AM1590RTS-W21 | 14pt | 1 | 250 | 100 |
| AM1590RTS-W213 | 14pt | 1 & 3 | 250 | 105 |

10% post-consumer waste

AS19X

End Tab Folder

- Overall Size: 9-1/2" H x 12-1/4" W
- Front Size: 9-1/2" H x 11-1/4" W
- Tab Length: 9-3/8"
- Scored for 3/4" expansion
- Reinforced end tab

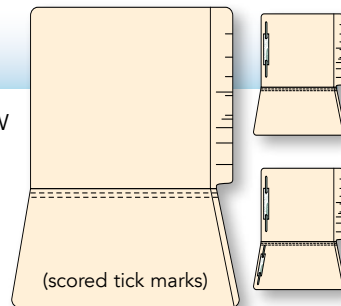

| Item # | Paper Weight | Fastener Position | Qty per box | Qty per Ctn | Lb / 1,000 |
|----------|--------------|-------------------|-------------|-------------|------------|
| AS19X | 11pt | None | 100 | 500 | 90 |
| AS19X21 | 11pt | 1 | 50 | 250 | 95 |
| AS19X213 | 11pt | 1 & 3 | 50 | 250 | 100 |

10% post-consumer waste

AS44X

3/4 Tab Cut End Tab Folder

- Overall Size: 9-1/2" H x 15" W
- Front Size: 9-1/2" H x 14-3/8" W
- Tab Length: 8-1/2"
- Scored for 3/4" expansion
- Reinforced end tab

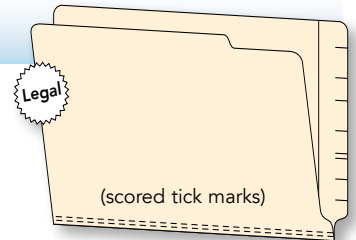

| Item # | Paper Weight | Fastener Position | Qty per box | Qty per Ctn | Lb / 1,000 |
|----------|--------------|-------------------|-------------|-------------|------------|
| AS44X | 14pt | None | 50 | 250 | 110 |
| AS44X21 | 14pt | 1 | 50 | 250 | 115 |
| AS44X213 | 14pt | 1 & 3 | 50 | 250 | 120 |

10% post-consumer waste

MS100 & MS200

Comparable to Tab, Smead, Barkley

- Overall Size: 9-1/2" H x 12-1/4" W
- Front Size: 9-1/2" H x 11-3/4" W
- Undercut to: 11-3/8"
- Tab Length: 8-1/2"
- Scored for 3/4" expansion

10% post-consumer waste

| Item # | Paper Weight | Fastener Position | Qty per box | Qty per Ctn | Lb / 1,000 |
|----------|--------------|-------------------|-------------|-------------|------------|
| MS100 | 11pt | None | 100 | 500 | 75 |
| MS10021 | 11pt | 1 | 50 | 250 | 80 |
| MS100213 | 11pt | 1 & 3 | 50 | 250 | 85 |
| MS200 | 14pt | None | 100 | 500 | 95 |
| MS20021 | 14pt | 1 | 50 | 250 | 100 |
| MS200213 | 14pt | 1 & 3 | 50 | 250 | 105 |

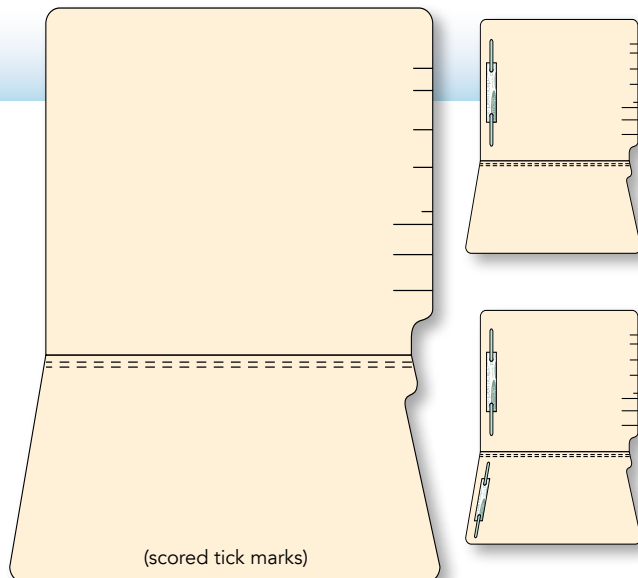

WF23X & WF73X

2" W-Fold Expansion Folder

- Overall Size: 9-1/2" H x 12-1/4" W
- Front Size: 9-1/2" H x 11-3/8" W
- Tab Length: 9-3/8"
- Scored for 2" W-fold expansion
- Ships bulk packed, flat

| Item # | Paper Weight | Fastener Position | Qty per Ctn | Lb / 1,000 |
|----------|--------------|-------------------|-------------|------------|
| WF23X | 14pt | None | 250 | 110 |
| WF23X21 | 14pt | 1 | 250 | 115 |
| WF23X212 | 14pt | 1 & 3 | 250 | 120 |
| WF73X | 18pt | None | 250 | 150 |
| WF73X21 | 18pt | 1 | 250 | 155 |
| WF73X213 | 18pt | 1 & 3 | 250 | 160 |

14pt - 10% post-consumer waste

18pt - 30% recycled content

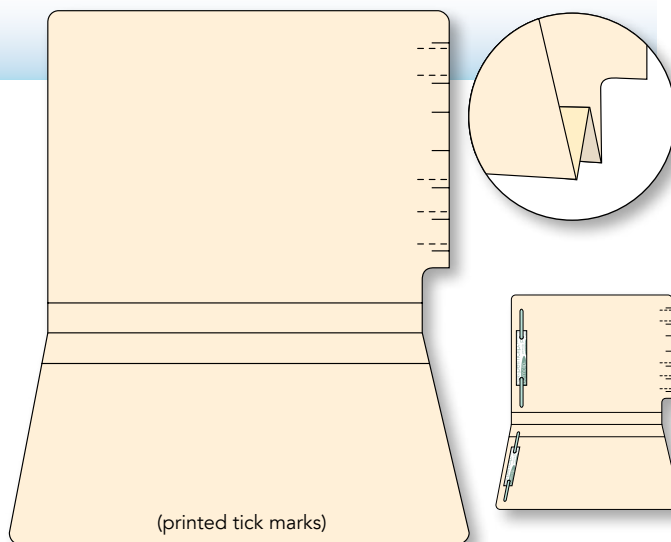

AS24X

2/3 Tab Cut End Tab Folder

- Overall Size: 9-1/2" H x 12" W
- Front Size: 9-1/2" H x 11-3/8" W
- Undercut to: 11-1/8"
- Tab Length: 7-1/4"
- Scored for 3/4" expansion

10% post-consumer waste

| Item # | Paper Weight | Fastener Position | Qty per box | Qty per Ctn | Lb / 1,000 |
|----------|--------------|-------------------|-------------|-------------|------------|
| AS24X | 14pt | None | 100 | 500 | 110 |
| AS24X21 | 14pt | 1 | 50 | 250 | 115 |
| AS24X213 | 14pt | 1 & 3 | 50 | 250 | 120 |

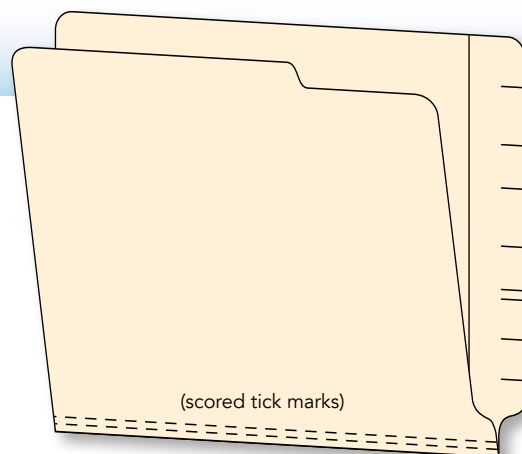

End Tab Folders

SF15X & SF25X

Comparable to Smead

- Overall Size: 9-1/2" H x 12-1/4" W
- Front Size: 9-1/2" H x 11-3/4" W
- Undercut to: 11-3/8"
- Tab Length: 8-1/2"
- Scored for 3/4" expansion
- Reinforced end tab

| Item # | Paper Weight | Fastener Position | Qty per box | Qty per Ctn | Lb / 1,000 |
|----------|--------------|-------------------|-------------|-------------|------------|
| SF15X | 11pt | None | 100 | 500 | 90 |
| SF15X21 | 11pt | 1 | 50 | 250 | 95 |
| SF15X213 | 11pt | 1 & 3 | 50 | 250 | 100 |
| SF25X | 14pt | None | 50 | 250 | 110 |
| SF25X21 | 14pt | 1 | 50 | 250 | 115 |
| SF25X213 | 14pt | 1 & 3 | 50 | 250 | 120 |

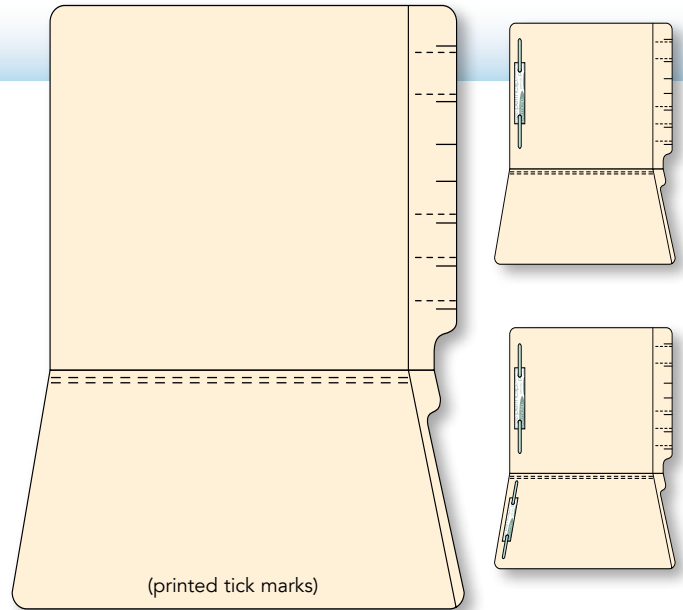

Available single ply: SF23X (14pt) and SF73X (18pt)

| Item # | Paper Weight | Fastener Position | Qty per box | Qty per Ctn | Lb / 1,000 |
|------------------|--------------|-------------------|-------------|-------------|------------|
| SF15X + color | 11pt | None | 100 | 500 | 90 |
| SF15X21 + color | 11pt | 1 | 50 | 250 | 95 |
| SF15X213 + color | 11pt | 1 & 3 | 50 | 250 | 100 |
| SF25X + color | 14pt | None | 50 | 250 | 110 |
| SF25X21 + color | 14pt | 1 | 50 | 250 | 115 |
| SF25X213 + color | 14pt | 1 & 3 | 50 | 250 | 120 |

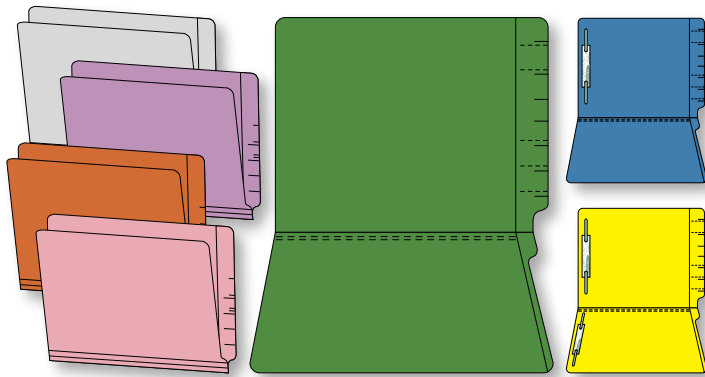

10 Available 11pt & 14pt Colors



SS18 & SS18MMY

18pt Single Ply – AS18X

- Overall Size: 9-1/2" H x 12-1/4" W
- Front Size: 9-1/2" H x 11-3/4" W
- Undercut to: 11-3/8"
- Tab Length: 8-1/2"
- Scored for 3/4" expansion
- Optional Mylar reinforced spine
- Packed 50/box

| Item # | Paper Weight | Fastener Position | Lb / 1,000 |
|------------|--------------|-------------------|------------|
| SS18M | 18pt | None | 150 |
| SS18M21 | 18pt | 1 | 155 |
| SS18M213 | 18pt | 1 & 3 | 160 |
| SS18MMY | 18pt | None | 150 |
| SS18MMY21 | 18pt | 1 | 155 |
| SS18MMY213 | 18pt | 1 & 3 | 160 |

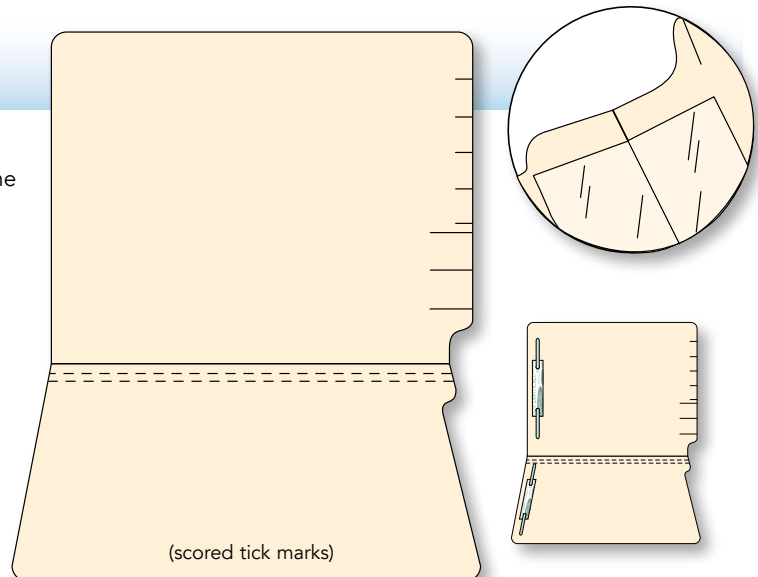

Items MY include Mylar reinforced spine.

RTE11X & RTE29X

Comparable to Barkley

- Overall Size: 9-1/2" H x 12-1/4" W
- Front Size: 9-1/2" H x 11-3/4" W
- Undercut to: 11-3/8"
- Tab Length: 9"
- Scored for 1-3/8" expansion
- Reinforced top and end tab

| Item # | Paper Weight | Fastener Position | Qty per box | Qty per Ctn | Lb / 1,000 |
|-----------|--------------|-------------------|-------------|-------------|------------|
| RTE11X | 11pt | None | 100 | 500 | 90 |
| RTE11X21 | 11pt | 1 | 50 | 250 | 95 |
| RTE11X213 | 11pt | 1 & 3 | 50 | 250 | 100 |
| RTE29X | 14pt | None | 50 | 250 | 110 |
| RTE29X21 | 14pt | 1 | 50 | 250 | 115 |
| RTE29X213 | 14pt | 1 & 3 | 50 | 250 | 120 |

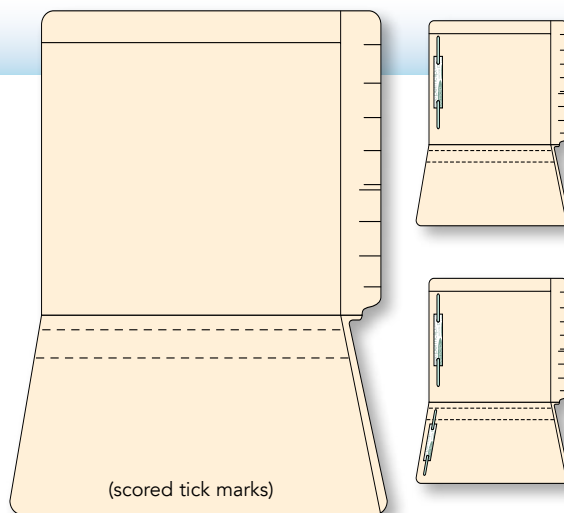

14pt available with 9" drop front: RTE29X-DF

G8687 & G8688

Comparable to GBS

- Overall Size: 9-1/2" H x 12-1/4" W
- Front Size: 9-1/2" H x 11-3/4" W
- Undercut to: 11-1/2"
- Tab Length: 8-1/2"
- Scored for 3/4" expansion
- Reinforced end tab

| Item # | Paper Weight | Fastener Position | Qty per box | Qty per Ctn | Lb / 1,000 |
|----------|--------------|-------------------|-------------|-------------|------------|
| G8687 | 11pt | None | 100 | 500 | 90 |
| G868721 | 11pt | 1 | 50 | 250 | 95 |
| G8687213 | 11pt | 1 & 3 | 50 | 250 | 100 |
| G8688 | 14pt | None | 50 | 250 | 110 |
| G868821 | 14pt | 1 | 50 | 250 | 115 |
| G8688213 | 14pt | 1 & 3 | 50 | 250 | 120 |

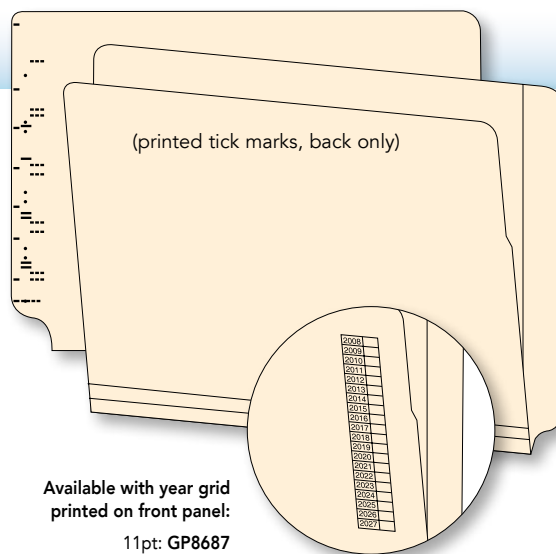

Available with year grid printed on front panel:

11pt: GP8687
14pt: GP8688

SG1500

Comparable to Safeguard

- Overall Size: 9-1/2" H x 12-1/4" W
- Front Size: 9-1/2" H x 11-3/8" W
- Tab Length: 9-3/8"
- Scored for 3/4" expansion
- Reinforced end tab

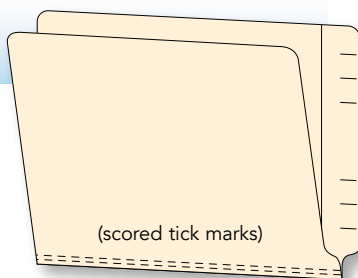

| Item # | Paper Weight | Fastener Position | Qty per box | Qty per Ctn | Lb / 1,000 |
|-----------|--------------|-------------------|-------------|-------------|------------|
| SG1500 | 15pt | None | 50 | 250 | 115 |
| SG150021 | 15pt | 1 | 50 | 250 | 120 |
| SG1500213 | 15pt | 1 & 3 | 50 | 250 | 125 |



MS15

Comparable to Jeter – F27X & JT2231

- Overall Size: 9-1/2" H x 12-1/4" W
- Front Size: 9-1/2" H x 11-3/8" W
- Tab Length: 9-3/8"
- Scored for 3/4" expansion

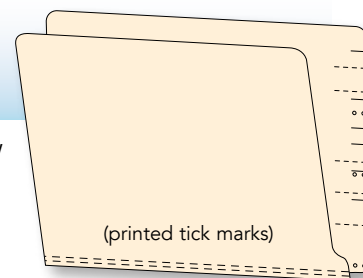

| Item # | Paper Weight | Fastener Position | Qty per box | Qty per Ctn | Lb / 1,000 |
|---------|--------------|-------------------|-------------|-------------|------------|
| MS15 | 14pt | None | 100 | 500 | 95 |
| MS1521 | 14pt | 1 | 50 | 250 | 100 |
| MS15213 | 14pt | 1 & 3 | 50 | 250 | 105 |



Top Tab Folders

M9518, TTC11

Comparable to Smead, Barkley

- Overall Size: 9-1/2" H x 11-3/4" W
- Front Size: 8-7/8" H x 11-3/4" W
- Tab Length: 3-3/4"
- Scored for 3/4" expansion
- Reinforced 1/3 cut top tab



| Item # | Paper Weight | Fastener Position | Qty per box | Lb / 1,000 |
|-----------------------------|--------------|-------------------|-------------|------------|
| M9518 + tab position | 11pt | None | 100 | 90 |
| M951821 + tab position | 11pt | 1 | 50 | 95 |
| M9518213 + tab position | 11pt | 1 & 3 | 50 | 100 |
| TTC11 (33 L, 33 C, 34 R) | 11pt | None | 100 | 95 |
| TTC1121 (17 L, 17 C, 16 R) | 11pt | 1 | 50 | 100 |
| TTC11213 (17 L, 17 C, 16 R) | 11pt | 1 & 3 | 50 | 105 |

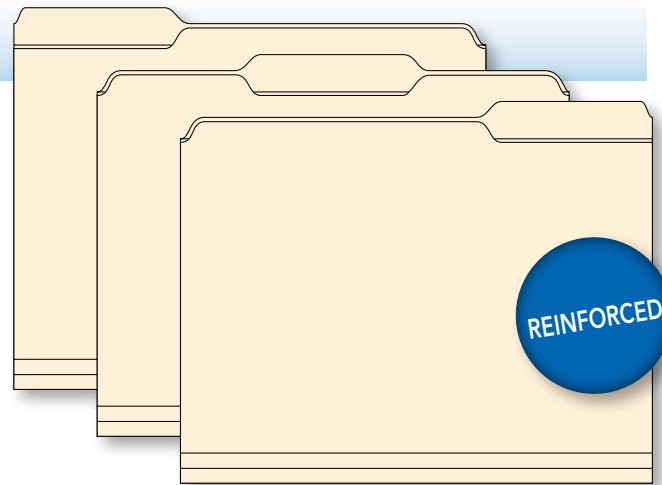

M9518: one position (L, C, or R) per box
TTC11: assorted positions (L, C, and R) per box

SM11

Comparable to Smead

- Overall Size: 9-1/2" H x 11-3/4" W
- Front Size: 9" H x 11-3/4" W
- Full top tab
- Scored for 3/4" expansion
- Full reinforced right end
- 0-9 scale printed in two locations, top & right side on outside back panel

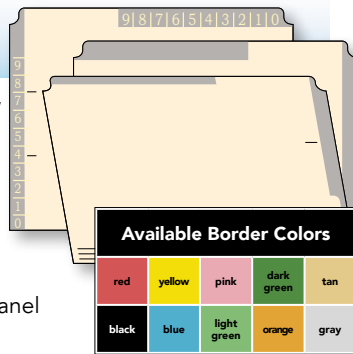

| Available Border Colors | | | | |
|-------------------------|--------|-------------|------------|------|
| red | yellow | pink | dark green | tan |
| black | blue | light green | orange | gray |

| Item # | Paper Weight | Fastener Position | Qty per box | Lb / 1,000 |
|-----------------|--------------|-------------------|-------------|------------|
| SM11 + color | 11pt | None | 100 | 90 |
| SM1121 + color | 11pt | 1 | 50 | 95 |
| SM11213 + color | 11pt | 1 & 3 | 50 | 100 |



M11TT

- Overall Size: 9-15/16" H x 11-3/4" W
- Front Size: 8-7/8" H x 11-3/4" H
- Tab Length: 8"
- Scored for 3/4" expansion
- Reinforced top tab

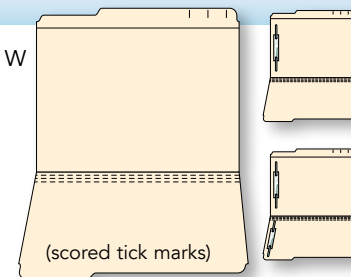

| Item # | Paper Weight | Fastener Position | Qty per box | Qty per Ctn | Lb / 1,000 |
|----------|--------------|-------------------|-------------|-------------|------------|
| M11TT | 11pt | None | 100 | 500 | 90 |
| M11TT21 | 11pt | 1 | 50 | 250 | 95 |
| M11TT213 | 11pt | 1 & 3 | 50 | 250 | 100 |



MR50, 420R

Comparable to Smead, Barkley

- Overall Size: 9-1/2" H x 11-3/4" W
- Front Size: 8-7/8" H x 11-3/4" W
- Tab Length: 11-3/4"
- Scored for 3/4" expansion
- Straight cut reinforced top tab
- Also available single ply: 420



| Item # | Paper Weight | Fastener Position | Qty per box | Qty per Ctn | Lb / 1,000 |
|---------|--------------|-------------------|-------------|-------------|------------|
| MR50 | 11pt | None | 100 | 500 | 90 |
| MR5021 | 11pt | 1 | 50 | 250 | 95 |
| MR50213 | 11pt | 1 & 3 | 50 | 250 | 100 |



423

Comparable to Smead, Barkley

- Overall Size: 9-1/2" H x 11-3/4" W
- Front Size: 8-7/8" H x 11-3/4" W
- Tab Length: 3-3/4"
- 4 scores for 3/4" expansion
- Single ply 1/3 cut top tab
- One position (1, 2, or 3) per box

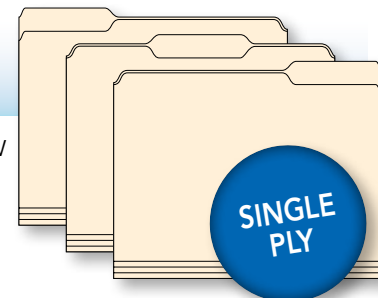

| Item # | Paper Weight | Fastener Position | Qty per box | Qty per Ctn | Lb / 1,000 |
|------------------|--------------|-------------------|-------------|-------------|------------|
| 423-1 (L) | 11pt | None | 100 | 500 | 75 |
| 423-2 (C) | 11pt | None | 100 | 500 | 75 |
| 423-3 (R) | 11pt | None | 100 | 500 | 75 |
| 423-(L, C, R)21 | 11pt | 1 | 50 | 250 | 80 |
| 423-(L, C, R)213 | 11pt | 1 & 3 | 50 | 250 | 85 |



520 & 620

- Overall Size: 9-1/2" H x 14-3/4" W
- Front Size: 8-7/8" H x 14-3/4" W
- Full top tab
- 4 scores for 3/4" expansion
- Single ply

| Item # | Paper Weight | Fastener Position | Qty per box | Qty per Ctn | Lb / 1,000 |
|--------|--------------|-------------------|-------------|-------------|------------|
| 520 | 11pt | None | 100 | 500 | 120 |
| 52021 | 11pt | 1 | 50 | 250 | 125 |
| 520213 | 11pt | 1 & 3 | 50 | 250 | 130 |
| 620 | 14pt | None | 50 | 250 | 135 |
| 62021 | 14pt | 1 | 50 | 250 | 140 |
| 620213 | 14pt | 1 & 3 | 50 | 250 | 145 |

10% post-consumer waste

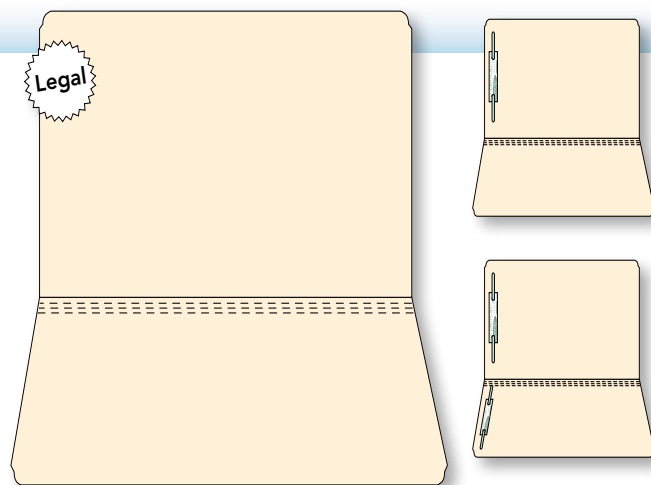

Folders with Manila Dividers

9-1/2" H x 12-1/4" W

Assembled from stock components, these folders feature an 11pt or 14pt reinforced folder with one or two 11pt manila dividers and permclicps®. (25/box, 125/ctn)

Divider folders allow the contents of each chart to be easily categorized and sub-divided.

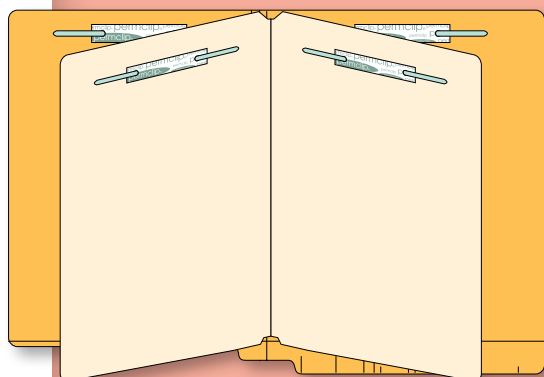

CRS10D2

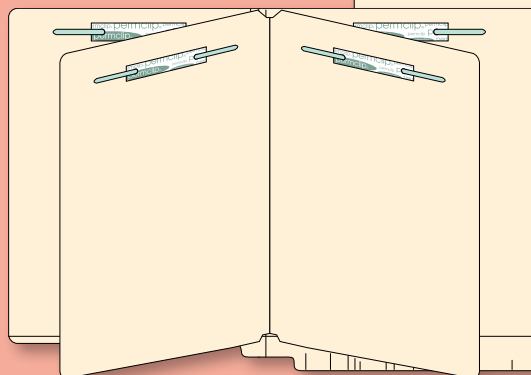

MRS20D2

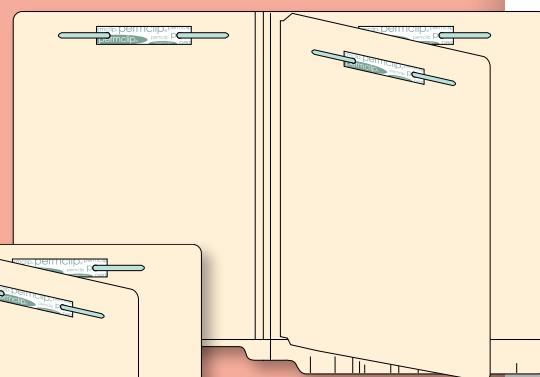

MRS10D1

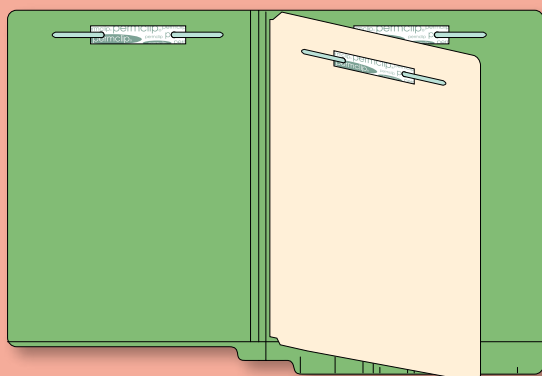

CRS10D1

Specify color when ordering.

| | | | | | | | |
|------|-------------|-------|-----------|--------|--------|--------|----------|
| red | yellow | pink | green | brown | blue | orange | tan |
| gray | dark orange | white | dark blue | purple | canary | gldnrd | lavender |

| Item # | Paper Weight | Fasteners | Qty per box | Lb / 1,000 |
|-----------------|--------------|-----------|-------------|------------|
| MRS10D1 | 11pt | 4 total | 25 | 150 |
| MRS10D2 | 11pt | 6 total | 25 | 200 |
| MRS20D1 | 14pt | 4 total | 25 | 195 |
| MRS20D2 | 14pt | 6 total | 25 | 245 |
| CRS10D1 + color | 11pt | 4 total | 25 | 150 |
| CRS10D2 + color | 11pt | 6 total | 25 | 200 |
| MRSD10D1* | 11pt | 4 total | 25 | 150 |
| MRSD10D2* | 11pt | 6 total | 25 | 200 |

* 9" high front panel

10% post-consumer waste

Pocket Folders

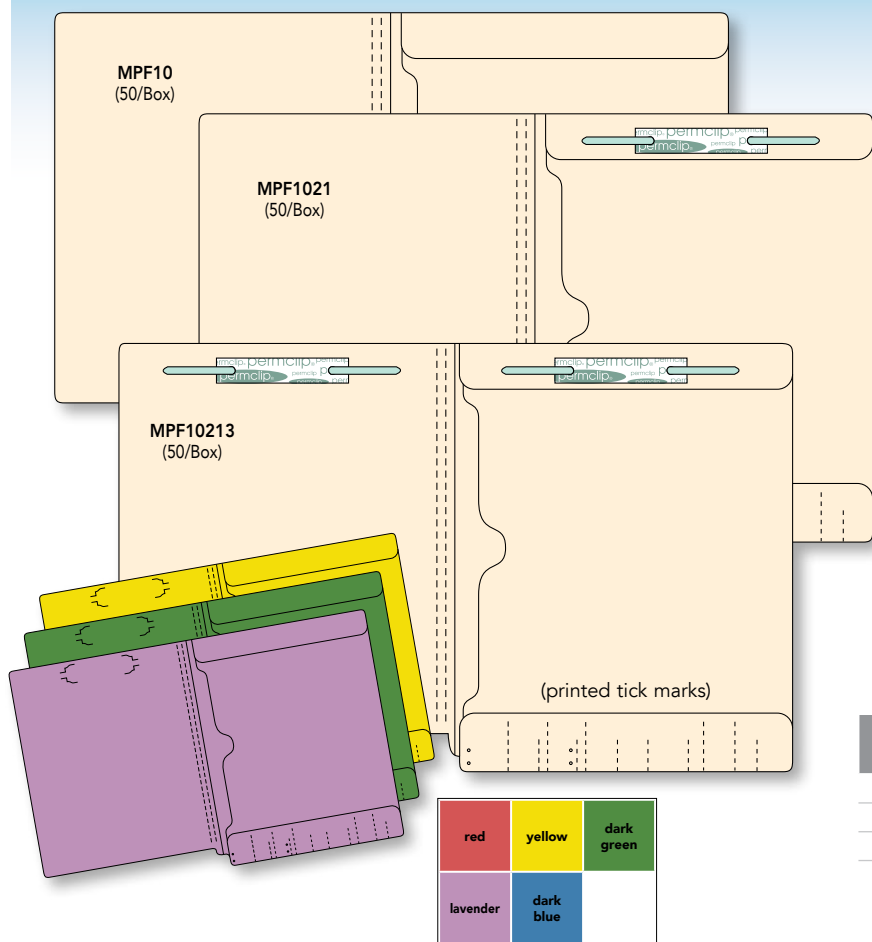

Structurally designed pocket folders and folders with installed pockets have become essential, because of the broad assortment of documents and document sizes being stored today. Choose from a large selection of multi-functional pocket folders to meet your particular needs.

MPF10

Comparable to Barkley

Constructed from 11pt manila or colored stock with an integral side seam pocket sealed on three sides. Full size pocket is 9-3/8" H x 12-1/4" W and has printed label placement marks. Overall size is 9-1/2" H x 12-1/4" W.

| Item # | Paper Weight | Fastener Position | Qty per box | Qty per Ctn | Lb / 1,000 |
|----------|--------------|-------------------|-------------|-------------|------------|
| MPF10 | 11pt | None | 50 | 250 | 130 |
| MPF1021 | 11pt | 1 | 50 | 250 | 135 |
| MPF10213 | 11pt | 1 & 3 | 50 | 250 | 140 |

Specify color when ordering.



MRSP10 & MRSP14

Left Hand Single-Pocket Folder

- 11 & 14pt Manila
- 9-1/2" H x 12-1/4" W; pocket 5-3/4" D

MPFA10

Full Cut-Corner Pocket Folder

- 9-1/2" H x 12-1/4" W; pocket 9-3/8" H x 11-3/4" W
- 11pt manila stock, double ply tab

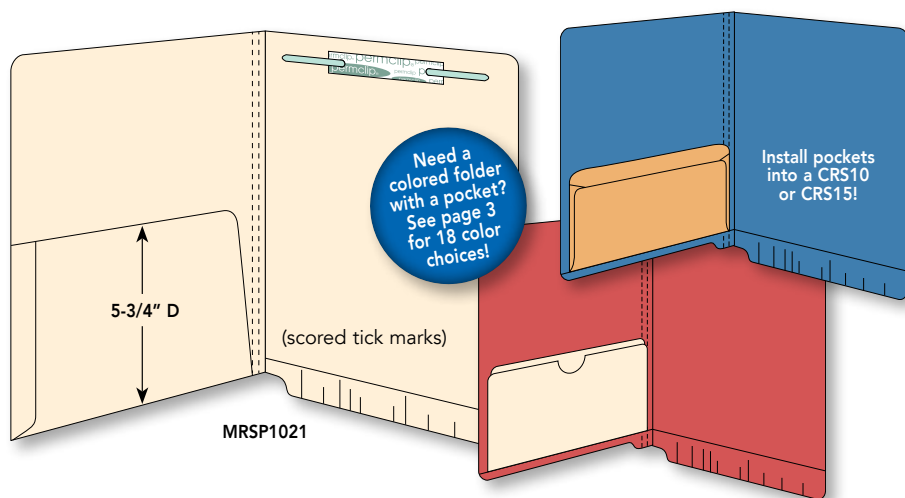

| Item # | Paper Weight | Fastener Position | Qty per box | Qty per Ctn | Lb / 1,000 |
|----------|--------------|-------------------|-------------|-------------|------------|
| MRSP10 | 11pt | None | 50 | 250 | 110 |
| MRSP1021 | 11pt | 1 | 50 | 250 | 115 |
| MRSP14 | 14pt | None | 50 | 250 | 150 |
| MRSP1421 | 14pt | 1 | 50 | 250 | 155 |

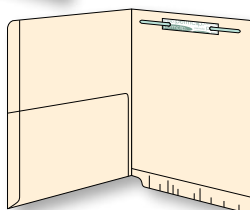

MRSPDF10 or RPF-11 (without clips - not shown)
MRSPDF1021 (shown)
available 9" H front, manila only (50/Box)



Pre-assembled Pocket Folders

9-1/2" H x 12-1/4" W

Base folder is an 11pt manila MRS10.

10% post-consumer waste

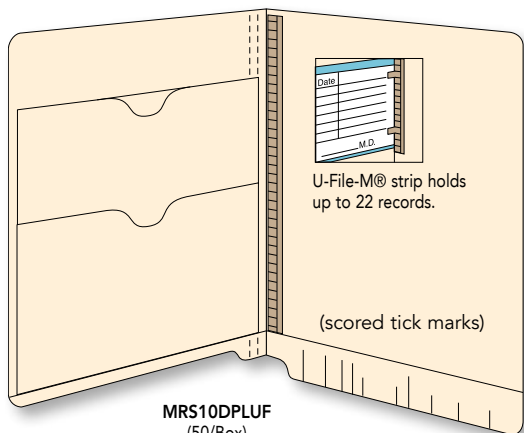

MRS10DPLUF
(50/Box)

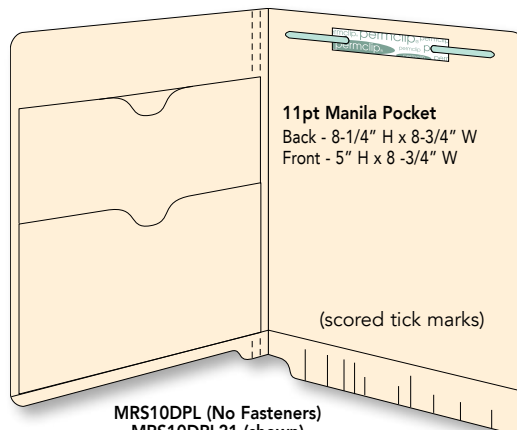

MRS10DPL (No Fasteners)
MRS10DPL21 (shown)
(50/Box)

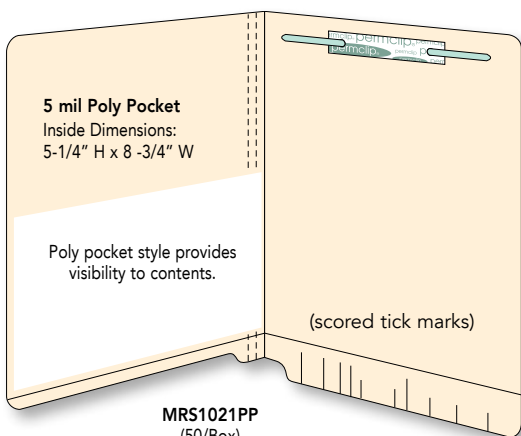

MRS1021PP
(50/Box)

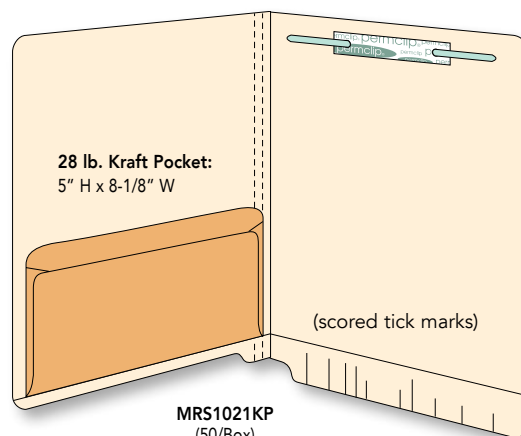

MRS1021KP
(50/Box)

ADDED-VALUE

A variety of components – such as printing, fasteners, pockets, dividers, indexes, and labels – can be custom-added to any folder to best meet your document filing and retrieval needs.



PRINTING: PAGE 2

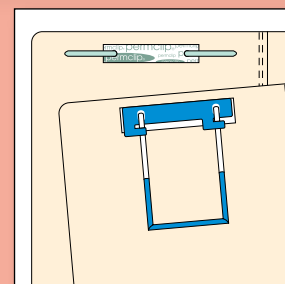

FASTENERS: PAGES 2, 31

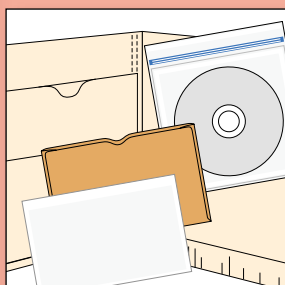

POCKETS: PAGES 37-38

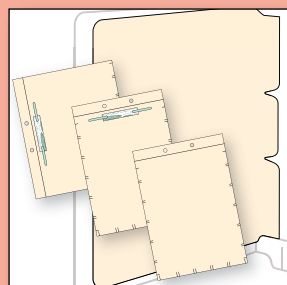

DIVIDERS: PAGE 44

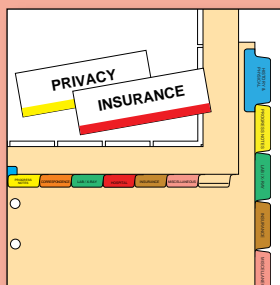

INDEXES: PAGES 40-52



LABELS: PAGES 55-90

Pocket Folders

MDPOUT

Double Outside-Pocket Folders

9-1/2" H x 12-1/4" W

11pt manila construction; Folder design is perfect for dental practices to hold panorex x-rays, photos, etc.



MDPOUT - (50/Box)

Double pocket folder with no additional fasteners installed

MDPOUTUF - (50/Box)

Includes a U-File-M® strip in position #5; holds up to 22 records

MDPOUT213 - (50/Box)

2" Bonded fasteners in positions 1 & 3 for maximum storage capacity

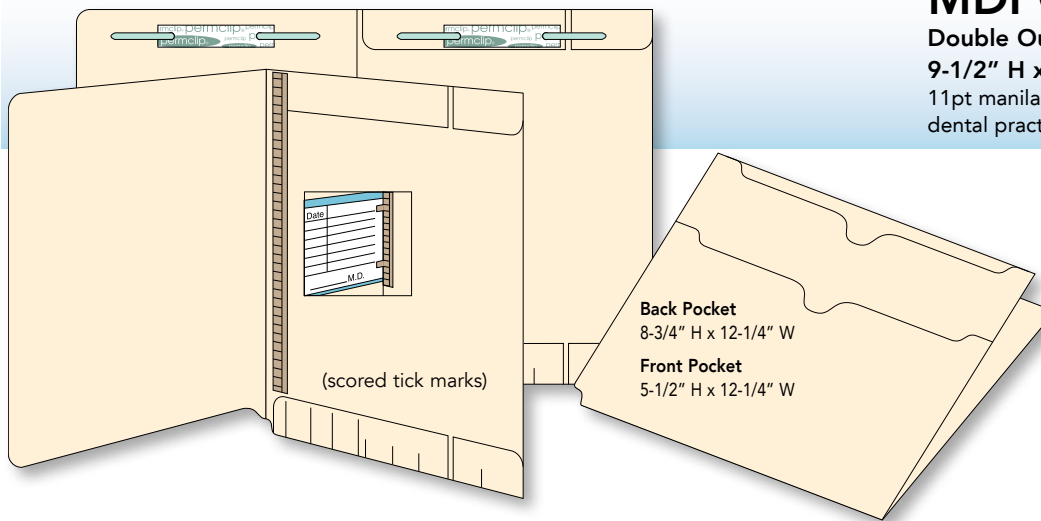

MTTPK

Right Hand Single-Pocket Folder

9-1/2" H x 12-1/4" W; pocket 5-3/4" H x 9" W

11pt manila stock, double ply tab.

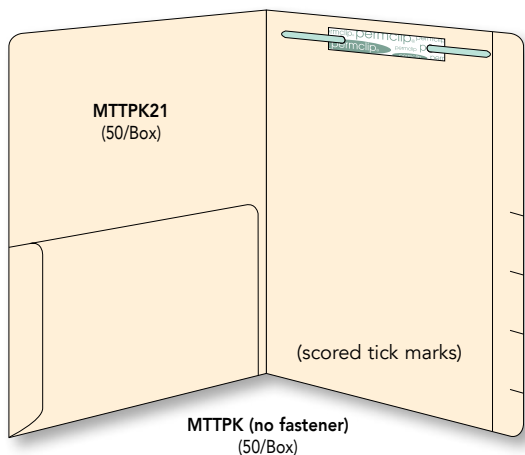

MPFI14

Inside Pocket Folder — 9-1/2" H x 12-1/4" W

This one-piece pocket folder is constructed from 14pt manila and features a single inside opening pocket great for storage.

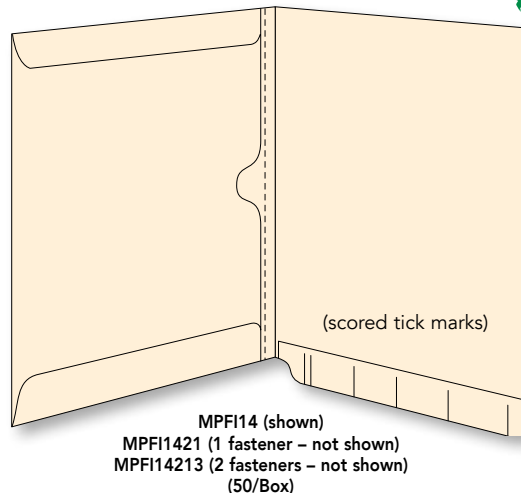

PF11TRIFOLD

Comparable to Barkley

9-1/2" H x 12-1/4" W; pocket 9-3/8" H x 12-1/4" W

Constructed from 11pt manila stock with an integral, full size, side seam pocket sealed on three sides.

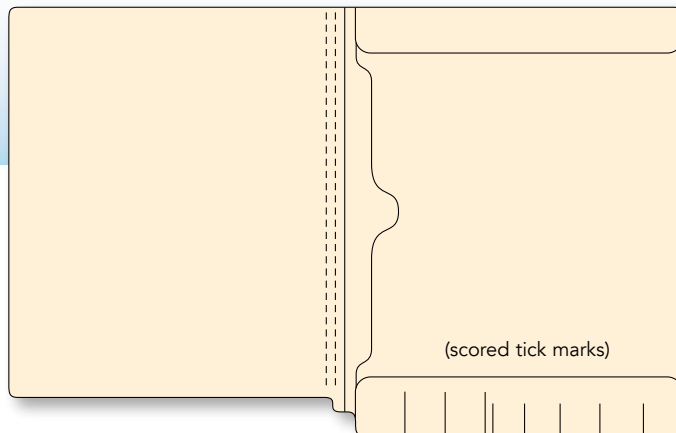

PF11TRIFOLD

| Item # | Paper Weight | Fastener Position | Qty per box | Qty per Ctn | Lb / 1,000 |
|----------------|--------------|-------------------|-------------|-------------|------------|
| PF11TRIFOLD | 11pt | None | 50 | 250 | 130 |
| PF11TRIFOLD21 | 11pt | 1 | 50 | 250 | 135 |
| PF11TRIFOLD213 | 11pt | 1 & 3 | 50 | 250 | 140 |

Pocket Folders with Strength & Capacity

MPFO14213

Full Size 14pt Pocket Folder — 11pt pocket laminated securely inside base folder

- Overall Size: 9-1/2" H x 12-1/4" W
- Pocket Size: 9-3/8" H x 12-1/4" W
- Constructed from 14pt folder (MS15)
- 11pt pocket (FP12) laminated to inside provides maximum durability

| Item # | Paper Weight | Fastener Position | Qty per box | Qty per Ctn | Lb / 1,000 |
|-----------|--------------|-------------------|-------------|-------------|------------|
| MPFO14 | 14pt | None | 50 | 250 | 195 |
| MPFO1421 | 14pt | 1 | 50 | 250 | 200 |
| MPFO14213 | 14pt | 1 & 3 | 50 | 250 | 210 |

10% post-consumer waste

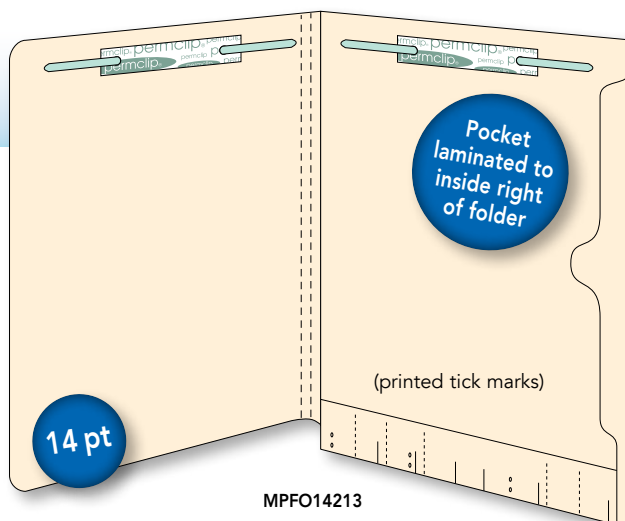

MPFO14213

PF11OUT

Full Size 14pt Pocket Folder — Manila panel glued inside base folder to create a pocket

- Overall Size: 9-1/2" H x 12-1/4" W
- Pocket Size: 9-3/8" H x 12-1/4" W
- Constructed from 14pt folder
- 14pt manila panel glued inside right panel flaps for full side pocket

| Item # | Paper Weight | Fastener Position | Qty per box | Qty per Ctn | Lb / 1,000 |
|------------|--------------|-------------------|-------------|-------------|------------|
| PF11OUT | 14pt | None | 50 | 250 | 210 |
| PF11OUT21 | 14pt | 1 | 50 | 250 | 215 |
| PF11OUT213 | 14pt | 1 & 3 | 50 | 250 | 220 |

10% post-consumer waste

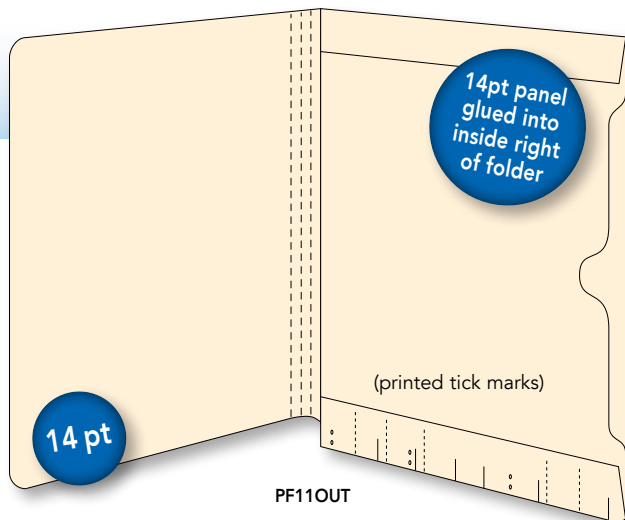

PF11OUT

MPFDP1021

Twin Pocket Folder — Two manila panels glued inside front and back of base folder

- Overall Size: 9-1/2" H x 12-1/2" W
- Left Pocket Size: 8-1/2" H x 11-5/8" W
- Right Pocket Size: 8-1/2" H x 12-1/4" W
- Constructed from 11pt manila
- Two pockets for storing panorex x-rays, photos, etc.

| Item # | Paper Weight | Fastener Position | Qty per box | Qty per Ctn | Lb / 1,000 |
|------------|--------------|-------------------|-------------|-------------|------------|
| MPFDP10 | 11pt | None | 50 | 250 | 150 |
| MPFDP1021 | 11pt | 1 | 50 | 250 | 160 |
| MPFDP10213 | 11pt | 1 & 3 | 50 | 250 | 165 |

10% post-consumer waste

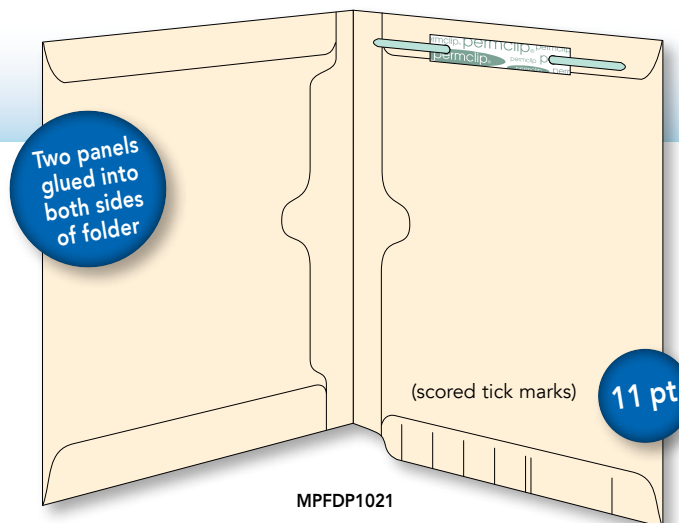

MPFDP1021

Divider / Classification Folders

14PT Folders with Manila Dividers

9-1/2" H x 12-1/4" W

Construction features 14pt outer folder with double-back 28pt thick dividers, 2" bonded fasteners and a 2" poly reinforced W-fold expansion.

Extra heavy dividers with 2" bonded fasteners provide the necessary rigidity to hold maximum volume of documents. Folders will not sag or bow on the shelf.

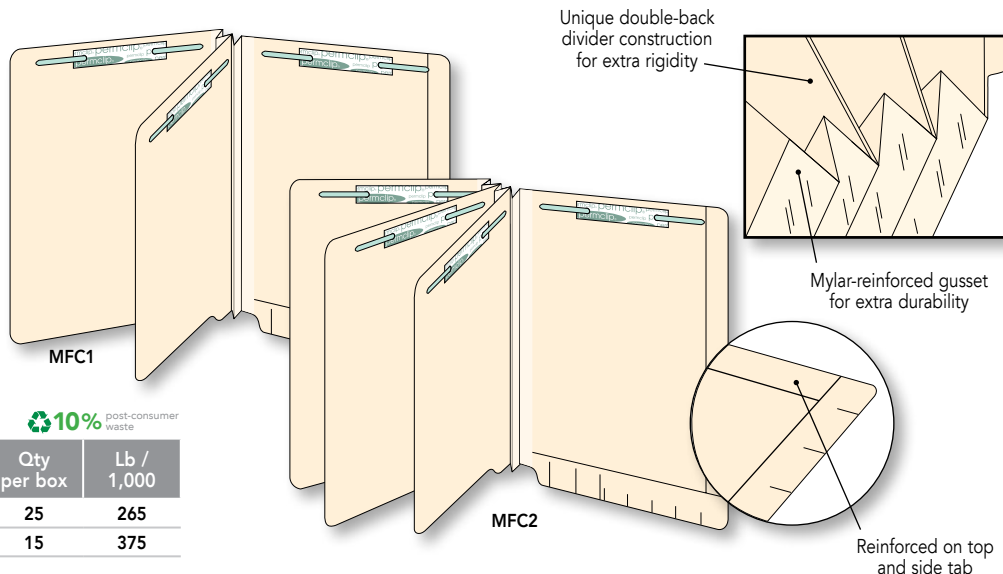

10% post-consumer waste

| Item # | Expansion | Fasteners | Qty per box | Lb / 1,000 |
|--------|-----------|-----------|-------------|------------|
| MFC1 | 2" W-fold | 4 total | 25 | 265 |
| MFC2 | 3" W-fold | 6 total | 15 | 375 |

18PT Folders with Manila Dividers

9-1/2" H x 12-1/4" W

Construction features 18pt single ply folder with Tyvek® gusset. Because of the flexible Tyvek® gusset, these folders will not bulk-up on the shelf and take up valuable space.

Tyvek® spine provides a flexible gusset and long life for active records.

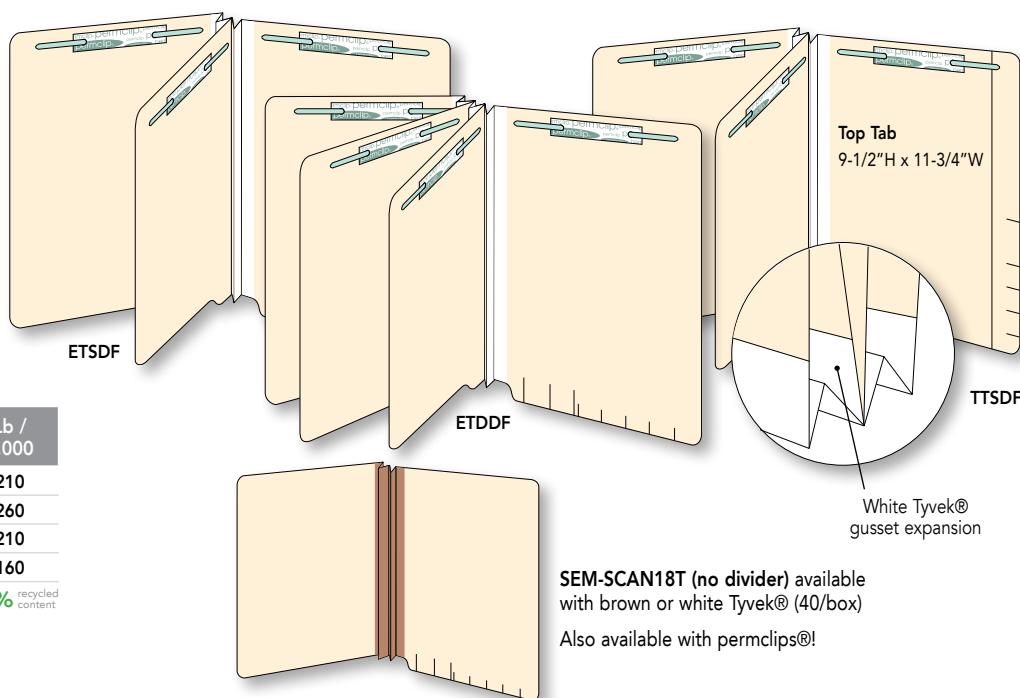

| Item # | Expansion | Qty per box | Lb / 1,000 |
|-------------|-----------|-------------|------------|
| ETADF | 1-1/2" | 25 | 210 |
| ETDDF | 2" | 20 | 260 |
| TTADF | 2" | 25 | 210 |
| SEM-SCAN18T | 1-1/2" | 40 | 160 |

30% recycled content

Pocket Folders with Manila Dividers

MRSP1421D1 – Base single pocket folder is 14pt thick with an 11pt divider installed in position #5.

DVP113 – Unique construction and features, this 11pt folder has full outside pocket that is 12-1/4" W x 8-1/4" D and will accommodate Panorex x-rays without having to trim them. Scored label placement lines.

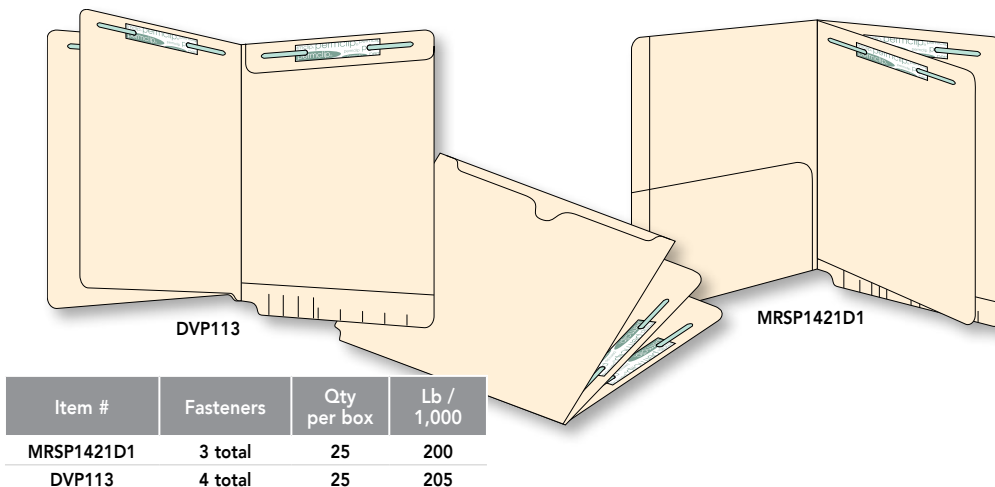

| Item # | Fasteners | Qty per box | Lb / 1,000 |
|------------|-----------|-------------|------------|
| MRSP1421D1 | 3 total | 25 | 200 |
| DVP113 | 4 total | 25 | 205 |

10% post-consumer waste

Pressboard

Great for presentation and durability, pressboard folders are manufactured using only the highest quality pressboard and can be customized with a wide range of color, divider, and expansion options.



customization...

Easy as 1, 2, 3

- 1 Select style and size
(end tab or top tab, letter or legal)
- 2 Choose material (type of pressboard) and color
- 3 Add fasteners, dividers, and more!

Pressboard

Type I Genuine Pressboard™ – 20pt

Used for classification folders, guides, and color coding files.



Type II Guidex® Pressboard – 25pt

One of the most durable materials in the industry.



Type III Valtex™ Pressboard – 25pt

Economical alternative to Type II Guidex™ Pressboard.

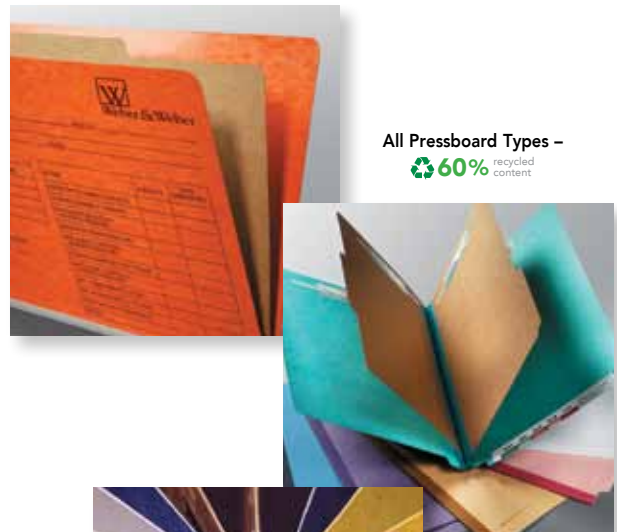

All Pressboard Types –
60% recycled content



Type I Genuine Pressboard™ and Type II Guidex® Pressboard are registered trademarks of FiberMark



Tyvek®

Expansions are created with Tyvek®, a strong, virtually tear-proof material. The most common colors are **New Brown** and **Dove Grey**. 22 additional colors available upon request, in minimum quantities.



Tyvek® is a trademark or registered trademark of E.I. du Pont de Nemours and Company.

Catalog color charts are not exact representations of actual products. Contact us for samples or swatches.

AC11, AC14, & DJ13X End Tab File Pockets

9-1/2" H x 12-1/4" W – 11pt & 14pt Manila and 11pt Colors
Diagonal cut front panel allows easy access to contents. Closed on two sides to secure documents from falling out. Label placement marks on a double ply end tab.



| | |
|-----------------------|-------------------|
| AC11DKG Dark Green | AC11CAN Canary |
| AC11DKB Dark Blue | AC11D Red |

All colors (100/box)

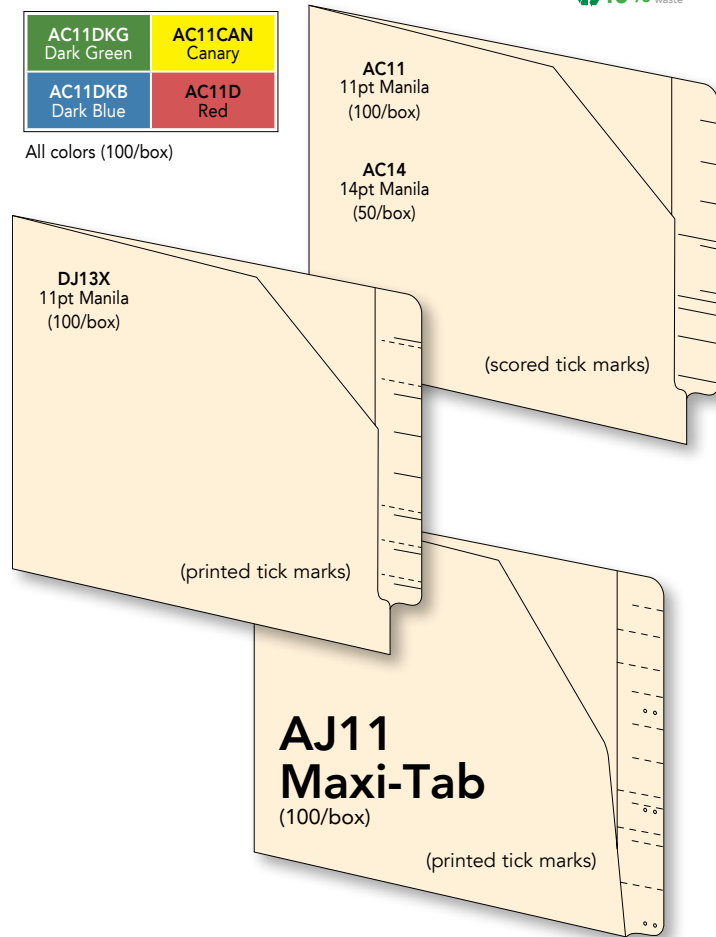

M11PK 11PT End Tab Pockets

9-1/2" H x 12-1/4" W – Printed Color Border
More economical than colored stock, these manila pockets with printed borders have a double ply top and side for extra durability. Pockets have scored tab scores for easy label placement. (100/box)



DP13E File Pocket

9-3/4" H x 12-5/8" W – 11pt Manila
Single ply pocket with top thumb notch to quickly reach documents. Scored at sides and bottom for 5/8" expansion. Ships flat. (100/box)

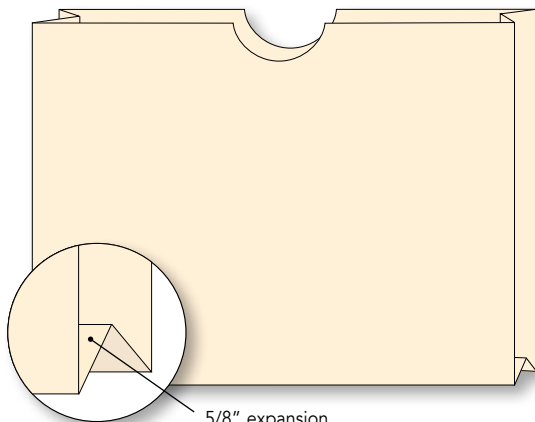

5/8" expansion

DP12X Top Tab File Pocket

9-1/2" H x 11-3/4" W
11pt Manila
Recessed thumb notch allows convenient access to documents. Double ply tab provides extra labeling space. (100/box)

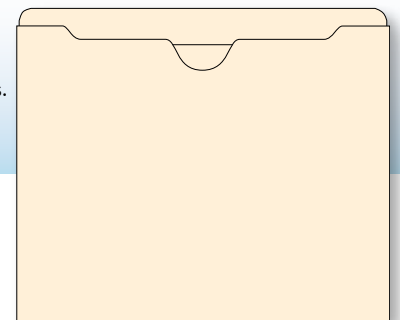

DP13X Top or End Tab File Pocket

9-1/2" H x 12-1/4" W
11pt Manila
Double ply top with reinforced side seam and pocket closed on three sides. Scored end tab tick marks. (100/box)

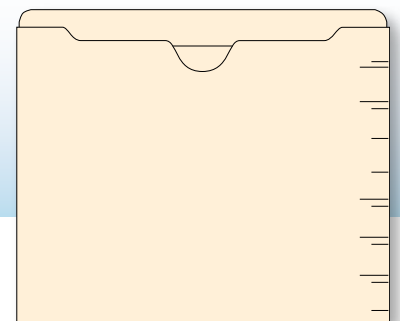

FP12 End Tab File Pocket

JT14901 – 9-1/2" H x 12-1/4" W – 11pt Manila
Reinforced side seam construction with single ply top. Pocket is closed on three sides for maximum security and document protection. (100/box)

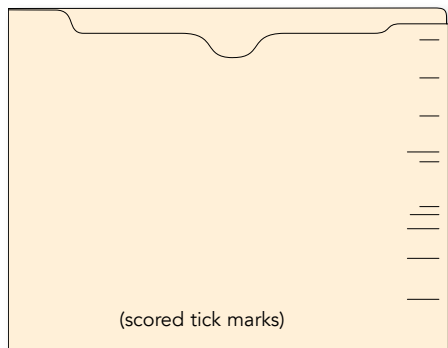

FP11 Top Tab Pockets

DP12R – 9-1/2" H x 11-3/4" W – 11pt Manila and Colors
Double ply tab with double recessed thumb notch allows more space for labeling and provides easier access to contents. Perfect for drawer filing when quick color references are required. (100/box)

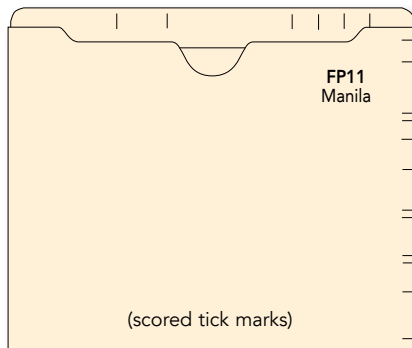

MXP11



11pt Expansion Pocket
9-1/2" H x 11-3/4" W - 9" H front
Double ply top tab with 1-1/2" paper gusset expansion. Ships tucked. (50/box)

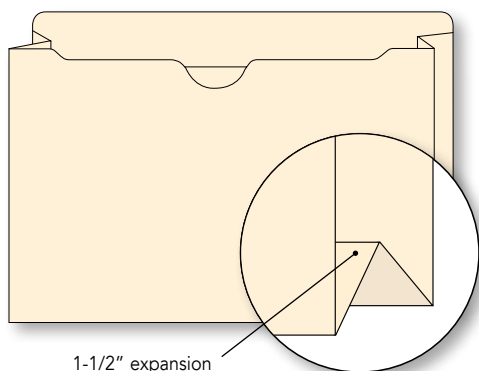

FPDT12



11PT Manila Pocket
9-1/2" H x 12-1/4" W
Double ply top tab with thumbcut front and scored tick marks. (100/box)

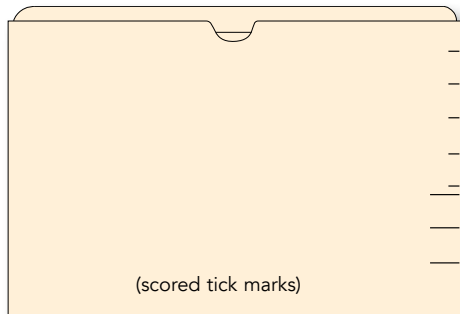

MJP11



11PT Mini-End Tab
6" H x 9-1/2" W – Manila
Single ply end tab designed for optical office applications or small document storage. Closed on 2 sides. (100/box)

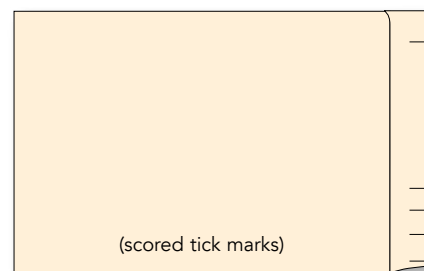

Economy File Envelopes

28 lb. and 32 lb. – Kraft Colors
8-3/4" H x 11-3/4" W
Perfect filing envelopes for lightly used files. Closed on three sides. Front is printed with spaces for name, home and business phone numbers plus addresses. (100/box)

28 lb. – All colors (white stock w/ printed border) except Kraft
32 lb. – 1071K – Kraft

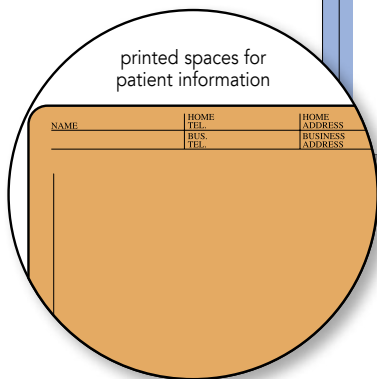

EXTP14 Service Folders

Overall Size: 9-1/2" H x 12-5/8" W

Front Size: 9-1/2" H x 11-1/4" W

14pt single-ply end tab folders give you a place to store hard copies of warranty work, repairs, and maintenance records. Features a full end tab for easy VIN identification and printed placement lines to aid in applying color-coded labels. (500/ctn)

EXT14 – No printing, inside or outside (not pictured)

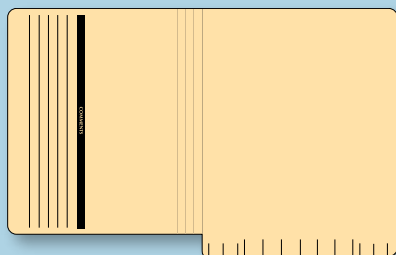

Inside

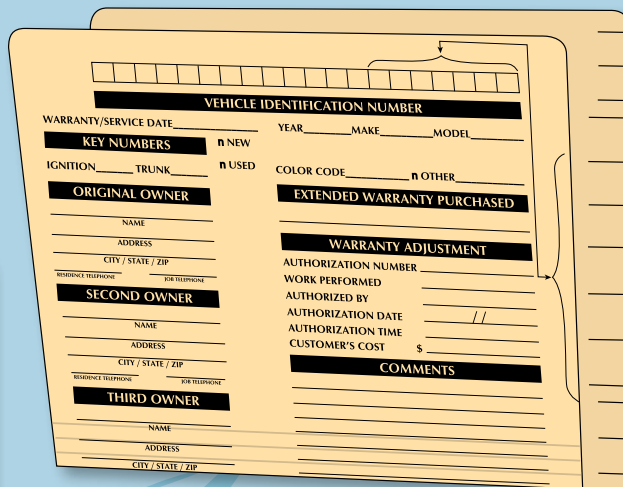

Outside

011-AJ Sales Jackets

Overall Size: 9-1/2" H x 12-5/8" W

11pt sales jackets are made from heavy-duty stock ideal for storing customer sales, lease, warranty, and delivery information. Use different colored jackets to distinguish between files. Closed on three sides to prevent materials from falling out. (500/ctn)



Yellow also available without printing (011-BAJY).

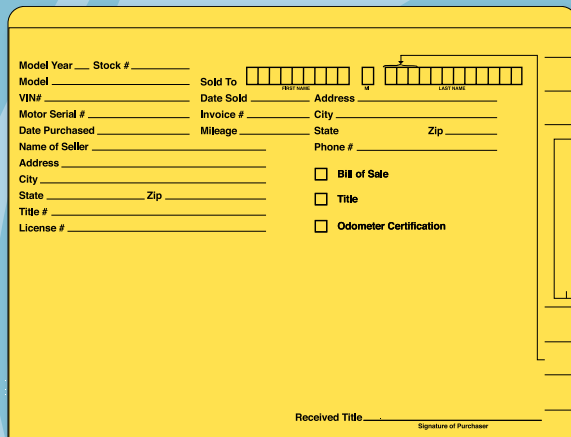

Filing Systems for Auto Dealerships

It's important to file and organize paperwork so that information can be quickly obtained when a customer returns! Depending on what each department uses for reference, the filing method may differ. Sales can sort files by the first three letters of the customer's last name (left), whereas Service could sort by the last six digits of the vehicle identification number (right).

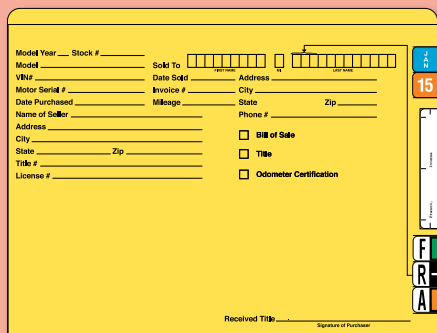

- 1 Manufacturer and year of vehicle, or month and year vehicle lease expires (shown)
- 2 Name label with customer's full name
- 3 First three letters of customer's last name

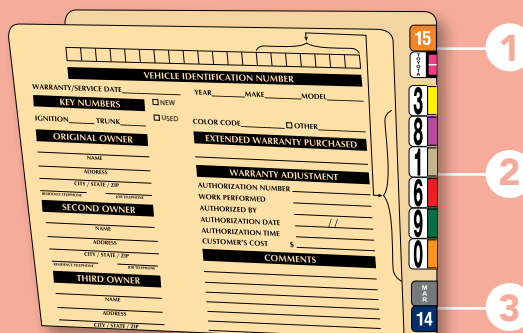

- 1 Manufacturer and year of vehicle
- 2 Last six digits of VIN from vehicle
- 3 Last month and year of service on vehicle

Window Stock Stickers

Size: 4" H x 3" W

These are the most widely used by both new and used car dealers. Large spaces provide plenty of room to write information, and clear plastic film with strong adhesive securely seals the sticker to the windshield. (100/pkg)



AUT-WSS100R Red

AUT-WSS100B Blue

Key Tags

Size: 3" H x 3" W (1-1/4" W when folded)

Our key tags have a tear-proof, self-laminating cover that keeps information legible by protecting from dirt, grease, and moisture. Write on them using any pen or marker, and simply fold to laminate. Easy to use and extremely durable! Key rings included. (250/box)



- AUT-AT250W White
- AUT-AT250B Blue
- AUT-AT250G Green
- AUT-AT250R Red
- AUT-AT250Y Yellow

600 Series Vehicle Make Labels

Reynolds & Reynolds® RF Compatible, 3/4" H x 1-1/2" W, Polylaminated (270 labels/pkg)

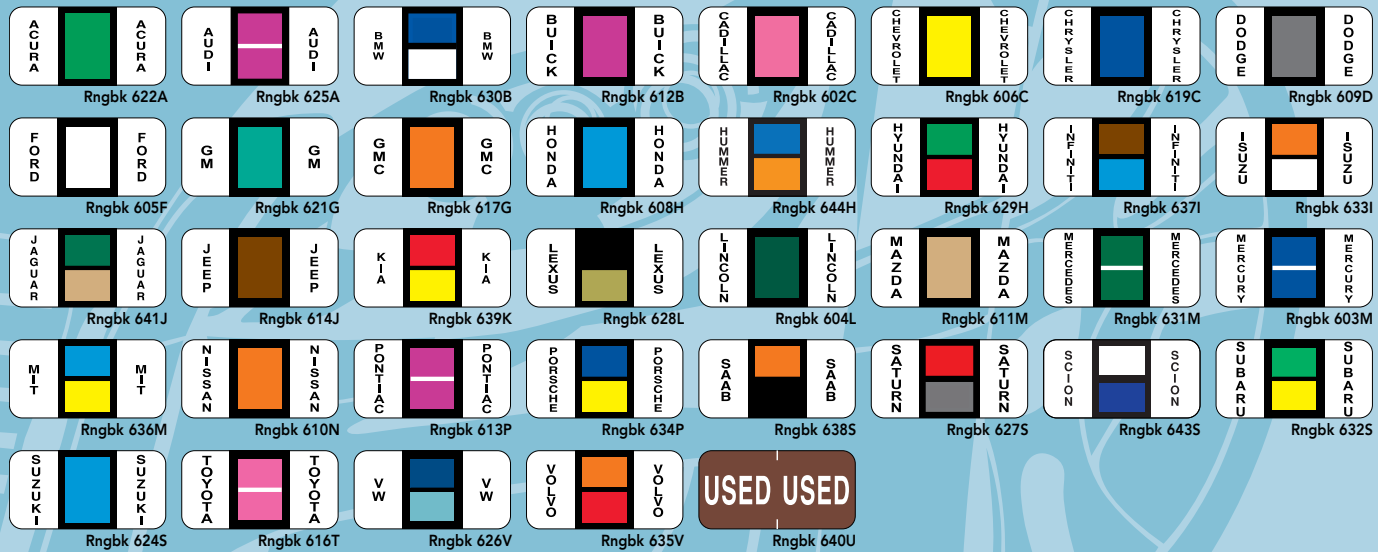

Year Labels

Reynolds & Reynolds® RF Compatible, 3/4" H x 1-1/2" W, Polylaminated (270 labels/pkg, 500 labels/roll)

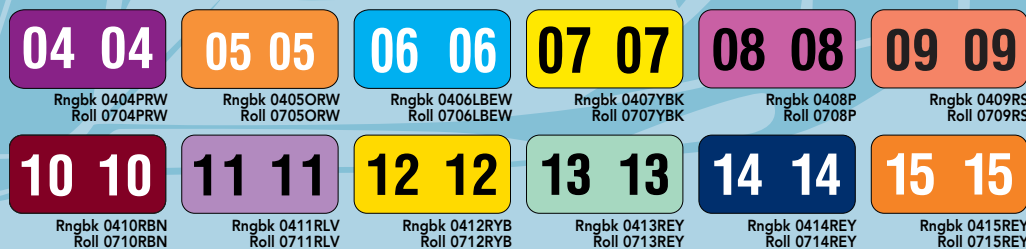

Find more Reynolds & Reynolds® labels for filing efficiency! (pages 65, 73, 79)

Kardex® Comparable Folders

Choose from a wide selection of folders constructed using only the highest quality pulp dyed colored stock and designed for use in the Kardex® 10 color system.

SEM-SCAN Numeric

Here's a highly effective terminal digit filing system that works great. It offers all the benefits of terminal digit filing with quick retrieval time.

SEM-SCAN Alpha

This system makes straight alphabetic filing obsolete. It dramatically cuts filing and retrieval time and practically eliminates misfiles, works extremely well for any size filing system, and is simple to learn and set up.



11pt - 10% post-consumer waste
20pt - 100% recycled content

SEM-SCAN Numeric

- 11pt Pulp Dyed Stock
- Overall Size: 9-1/2" X 11-3/4"
- Double-Ply Top & End Tab
- Scored for 3/4" expansion
- 0 - 9 scale printed on tab twice
- Available in 10 colors

| SEM-SCAN Numeric Color Chart | | | | |
|------------------------------|-----------|-------------|-------------|------------|
| 0 white | 1 red | 2 yellow | 3 pink | 4 green |
| 5 brown | 6 blue | 7 orange | 8 purple | 9 tan |

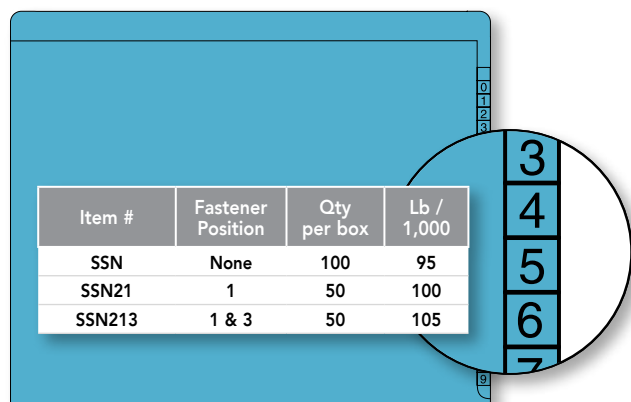

SEM-SCAN Alpha

- 11pt Pulp Dyed Stock
- Overall Size: 9-1/2" X 11-3/4"
- Double-Ply Top & End Tab
- Scored for 3/4" expansion
- A - Z scale printed on tab
- Available in 10 colors

| SEM-SCAN Alpha Color Chart | | | | |
|----------------------------|-------------|---------------|--------------|------------|
| AB red | C yellow | DEF pink | GHI green | J white |
| KL brown | MNO blue | PQR orange | ST purple | U-Z tan |

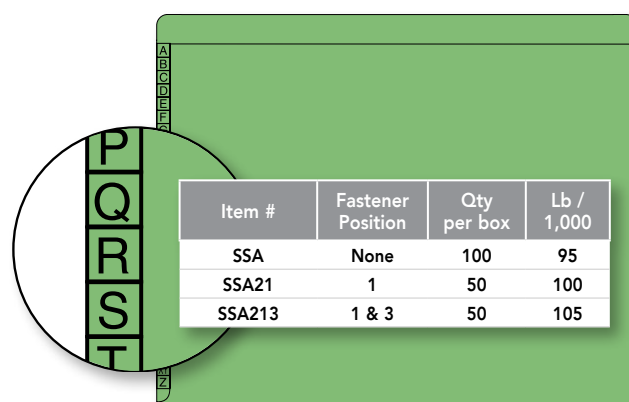

CT100

- 11pt Pulp Dyed Stock
- Overall Size: 9-1/2" X 11-3/4"
- Straight Cut 2-Ply Top Tab
- Available in 10 colors

| | |
|--------|--------|
| white | blue |
| yellow | red |
| pink | green |
| orange | tan |
| brown | purple |

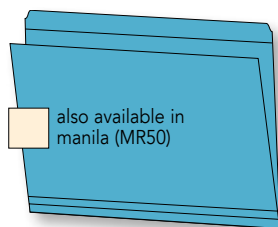

| Item # | Fastener Position | Qty per box | Lb / 1,000 |
|----------|-------------------|-------------|------------|
| CT100 | None | 100 | 95 |
| CT10021 | 1 | 50 | 100 |
| CT100213 | 1 & 3 | 50 | 105 |

SEM-SCAN 10

- 11pt Pulp Dyed Stock
- Overall Size: 9-1/2" X 12-1/4"
- Double-Ply Top & End Tab
- Scored for 3/4" expansion
- Available in 12 colors

| | |
|-----------|--------|
| white | blue |
| yellow | red |
| dark blue | pink |
| green | orange |
| tan | brown |
| purple | gray |

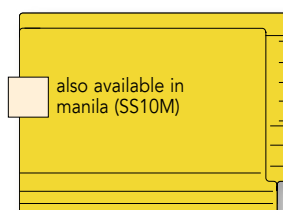

| Item # | Fastener Position | Qty per box | Lb / 1,000 |
|---------|-------------------|-------------|------------|
| SS10 | None | 100 | 100 |
| SS1021 | 1 | 50 | 105 |
| SS10213 | 1 & 3 | 50 | 110 |

SEM-SCAN 20

- 20pt Pulp Dyed Stock
- Overall Size: 9-1/2" X 12-1/4"
- Single-Ply End Tab
- Scored for 3/4" expansion
- Available in 12 colors

| | |
|-----------|--------|
| white | blue |
| yellow | red |
| dark blue | pink |
| green | orange |
| tan | brown |
| purple | gray |



| Item # | Fastener Position | Qty per box | Lb / 1,000 |
|---------|-------------------|-------------|------------|
| SS20 | None | 40 | 150 |
| SS2021 | 1 | 40 | 155 |
| SS20213 | 1 & 3 | 40 | 160 |

SEM-SCAN 20T

9-1/2" x 12-1/4"

- 20pt Pulp Dyed Stock
- Single-Ply End Tab
- 1-1/2" Tyvek® expansion
- Available in 12 colors

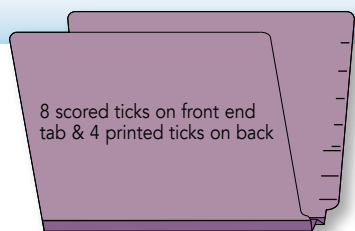

| Item # | Paper Weight | Fastener Position | Qty per box | Lb / 1,000 |
|----------|--------------|-------------------|-------------|------------|
| SS20T | 20pt | None | 50 | 165 |
| SS20T21 | 20pt | 1 | 50 | 170 |
| SS20T213 | 20pt | 1 & 3 | 50 | 175 |

SEM-SCAN 20T Legal

9-1/2" x 15-1/4"

- 20pt Pulp Dyed Stock
- Single-Ply End Tab
- 1-1/2" Tyvek® expansion
- Available in 12 colors



| Item # | Paper Weight | Fastener Position | Qty per box | Lb / 1,000 |
|-----------|--------------|-------------------|-------------|------------|
| SS20TL | 20pt | None | 50 | 200 |
| SS20TL21 | 20pt | 1 | 50 | 215 |
| SS20TL213 | 20pt | 1 & 3 | 50 | 220 |

SEM-SCAN 20T Numeric

9-1/2" x 11-3/4"

- 20pt Pulp Dyed Stock
- Single-Ply End Tab
- 1-1/2" Tyvek® expansion
- 0 - 9 scale printed on tab
- Available in 10 colors

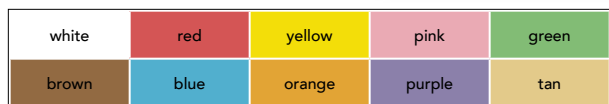
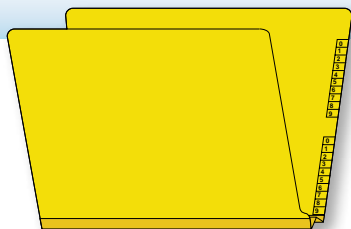

| Item # | Paper Weight | Fastener Position | Qty per box | Lb / 1,000 |
|-----------|--------------|-------------------|-------------|------------|
| SS20TN | 20pt | None | 50 | 165 |
| SS20TN21 | 20pt | 1 | 50 | 170 |
| SS20TN213 | 20pt | 1 & 3 | 50 | 175 |

SEM-SCAN 20T Numeric Legal

9-1/2" x 14-3/4"

- 20pt Pulp Dyed Stock
- Single-Ply End Tab
- 1-1/2" Tyvek® expansion
- 0 - 9 scale printed on tab
- Available in 10 colors

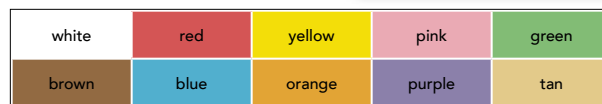
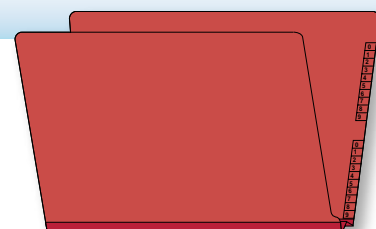

| Item # | Paper Weight | Fastener Position | Qty per box | Lb / 1,000 |
|------------|--------------|-------------------|-------------|------------|
| SS20TNL | 20pt | None | 50 | 200 |
| SS20TNL21 | 20pt | 1 | 50 | 215 |
| SS20TNL213 | 20pt | 1 & 3 | 50 | 220 |

SEM-SCAN 20T Alpha

9-1/2" x 11-3/4"

- 20pt Pulp Dyed Stock
- Single-Ply End Tab
- 1-1/2" Tyvek® expansion
- A - Z scale printed on tab
- Available in 10 colors

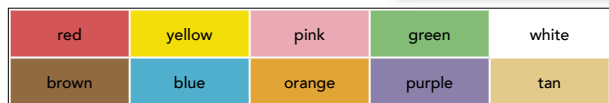

| Item # | Paper Weight | Fastener Position | Qty per box | Lb / 1,000 |
|-----------|--------------|-------------------|-------------|------------|
| SS20TA | 20pt | None | 50 | 165 |
| SS20TA21 | 20pt | 1 | 50 | 170 |
| SS20TA213 | 20pt | 1 & 3 | 50 | 175 |

SEM-SCAN 20T Alpha Legal

9-1/2" x 14-3/4"

- 20pt Pulp Dyed Stock
- Single-Ply End Tab
- 1-1/2" Tyvek® expansion
- A - Z scale printed on tab
- Available in 10 colors

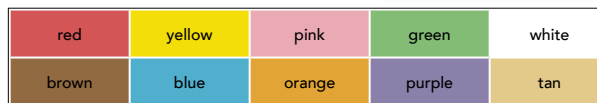
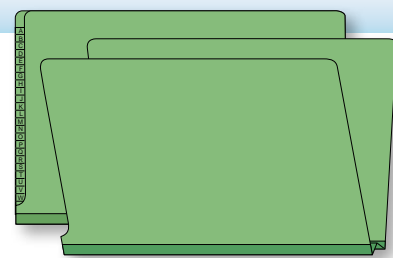

| Item # | Paper Weight | Fastener Position | Qty per box | Lb / 1,000 |
|------------|--------------|-------------------|-------------|------------|
| SS20TAL | 20pt | None | 50 | 200 |
| SS20TAL21 | 20pt | 1 | 50 | 215 |
| SS20TAL213 | 20pt | 1 & 3 | 50 | 220 |

Classification Folders and More

Classification folders are a great way to secure multiple documents, with strong and durable covers that will last nearly a lifetime. Dividers and permclip® fasteners help secure, divide, and organize information. We also provide a variety of unique filing accessories, from spill-resistant folders to polyester labels that can be used just about anywhere!



SJP Fusion™ 6-in-1® Pressboard Folders

Perfect for organizing, color coding projects, and more. Document storage in six separate sections, constructed of sturdy black pressboard bonded with long-lasting Tyvek® gussets. Letter size. (15/box)

| Item # | Color |
|--------|--------|
| S62621 | Red |
| S62622 | Yellow |
| S62624 | Blue |
| S62625 | Green |
| S62626 | Orange |

60% recycled content



Economy Classification Folders

These ideal project files allow you to create subdivisions of material or organize sequentially within one folder. Fasteners on front and back panels and dividers create separate filing surfaces. Available in end tab or top tab 2/5 cut right, with five color options.

| Item # | Color | Size | Dividers and expansion | Top or End Tab | Qty / box |
|--------|--------|--------|---------------------------------------|----------------|-----------|
| S59700 | Manila | Letter | 6-in-1@, 2 dividers, 1" expansion | TOP | 25 |
| S59702 | Blue | Letter | 6-in-1@, 2 dividers, 1" expansion | TOP | 25 |
| S59704 | Green | Letter | 6-in-1@, 2 dividers, 1" expansion | TOP | 25 |
| S59706 | Yellow | Letter | 6-in-1@, 2 dividers, 1" expansion | TOP | 25 |
| S59707 | Red | Letter | 6-in-1@, 2 dividers, 1" expansion | TOP | 25 |
| S59710 | Manila | Legal | 6-in-1@, 2 dividers, 1" expansion | TOP | 25 |
| S59750 | Manila | Letter | 8-in-1@, 3 dividers, 1-1/2" expansion | TOP | 15 |
| S59720 | Manila | Letter | 6-in-1@, 2 dividers, 1" expansion | END | 25 |
| S59722 | Blue | Letter | 6-in-1@, 2 dividers, 1" expansion | END | 25 |
| S59724 | Green | Letter | 6-in-1@, 2 dividers, 1" expansion | END | 25 |
| S59726 | Yellow | Letter | 6-in-1@, 2 dividers, 1" expansion | END | 25 |
| S59727 | Red | Letter | 6-in-1@, 2 dividers, 1" expansion | END | 25 |
| S59760 | Manila | Letter | 8-in-1@, 3 dividers, 1-1/2" expansion | END | 15 |

35% recycled content



Classification Folios

Covers made from embossed, coated pressboard bonded with tear-resistant Tyvek® gussets for a 2-1/4" expansion. Six permclip® fasteners for sectional storage. (10/box)

| Item # | Color | Size |
|--------|---------------|--------|
| S56000 | Executive Red | Letter |
| S56001 | Forest Green | Letter |
| S56003 | Pacific Blue | Letter |
| S56100 | Executive Red | Legal |
| S56101 | Forest Green | Legal |
| S56103 | Pacific Blue | Legal |

60% recycled content



WaterShed® / CutLess® Folders



Protect files, fingers, and the environment! Specially formulated stock protects against spills and reduces incidence of paper cuts. Letter size end tab or 1/3 cut top tab.

Legal size manila top tab available: S11561



| Item # | Color | Fastener Position | Top or End Tab | Qty / box |
|--------|--------|-------------------|----------------|-----------|
| S13630 | Manila | None | End | 100 |
| S13632 | Yellow | None | End | 100 |
| S13633 | Red | None | End | 100 |
| S13634 | Green | None | End | 100 |
| S13636 | Blue | None | End | 100 |
| S13639 | Purple | None | End | 100 |

| Item # | Color | Fastener Position | Top or End Tab | Qty / box |
|--------|--------|-------------------|----------------|-----------|
| S13641 | Manila | 1 & 3 | End | 100 |
| S13642 | Yellow | 1 & 3 | End | 50 |
| S13643 | Red | 1 & 3 | End | 50 |
| S13644 | Green | 1 & 3 | End | 50 |
| S13646 | Blue | 1 & 3 | End | 50 |
| S13649 | Purple | 1 & 3 | End | 50 |

| Item # | Color | Fastener Position | Top or End Tab | Qty / box |
|--------|--------|-------------------|----------------|-----------|
| S11531 | Manila | 1 | Top | 50 |
| S11541 | Manila | 1 & 3 | Top | 50 |
| S11542 | Yellow | 1 & 3 | Top | 50 |
| S11543 | Red | 1 & 3 | Top | 50 |
| S11544 | Green | 1 & 3 | Top | 50 |
| S11546 | Blue | 1 & 3 | Top | 50 |
| S11549 | Purple | 1 & 3 | Top | 50 |

EverFile® Archival Manila Folders

Made with durable and chemically-stable 11pt EverFile® manila stock; remains stable for 50 years or more. Anti-microbial coating resists formation of mold, mildew, and associated odors on the folder. Acid-free and lignin-free. 1/3 cut tabs in assorted positions.

| Item # | Size | Fastener Position | Qty / box |
|--------|--------|-------------------|-----------|
| S14901 | Letter | None | 100 |
| S11571 | Letter | 1 & 3 | 50 |
| S11581 | Legal | 1 & 3 | 50 |



PlazStyx™ Labels



PlazStyx™ laser labels are made from polyester, which is tear-, chemical-, and water-resistant. Permanent, specially formulated adhesive is great for both indoor and outdoor use.

100% recyclable labels and standard laser printer labels also available in various sizes and colors.

WHITE PLAZSTYX™

YELLOW PLAZSTYX™

100% RECYCLABLE

| Item # | Label Size | Labels / Sheet | # of Sheets | Total Labels |
|---------|---------------|----------------|-------------|--------------|
| SL12586 | 1" x 2-5/8" | 30 | 50 | 1,500 |
| SL15026 | 1/2" x 1-3/4" | 80 | 25 | 2,000 |
| SL24006 | 2" x 4" | 10 | 50 | 500 |
| SL81216 | 8-1/2" x 11" | 1 | 50 | 50 |
| SL12520 | 1" x 2-5/8" | 30 | 25 | 750 |
| SL24020 | 2" x 4" | 10 | 25 | 250 |
| SL81220 | 8-1/2" x 11" | 1 | 25 | 25 |
| SL11349 | 1-1/3" x 4" | 14 | 100 | 1,400 |
| SL12589 | 1" x 2-5/8" | 30 | 100 | 3,000 |
| SL15029 | 1/2" x 1-3/4" | 80 | 25 | 2,000 |
| SL24009 | 2" x 4" | 10 | 100 | 1,000 |
| SL31349 | 3-1/3" x 4" | 6 | 100 | 600 |

Table of Contents Dividers

SPEEDEX™ DIVIDERS

Compatible with laser and inkjet printers and copiers. (36 sets/ctn)

| Item # | Tab Cut | Tab Placement | Size |
|--------|---------|---------------|--------|
| S05175 | 5 | SIDE | Letter |
| S05178 | 8 | SIDE | Letter |
| S05275 | 5 | SIDE | Letter |
| S05278 | 8 | SIDE | Letter |
| S08175 | 5 | BOTTOM | Legal |
| S08178 | 8 | BOTTOM | Legal |
| S08275 | 5 | BOTTOM | Legal |
| S08278 | 8 | BOTTOM | Legal |

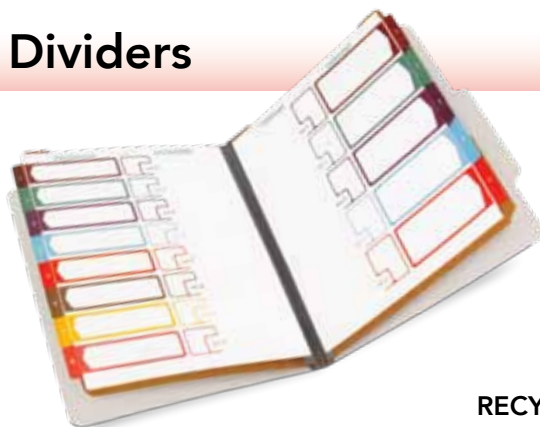

RECYCLED DIVIDERS

Recycled, printable Table of Content dividers with compatible with laser and inkjet printers and copiers. Use landscape or portrait orientation. Letter size. (8 sets/ctn)

| Item # | Tab Cut |
|---------|---------|
| ST64105 | 5 |
| ST64108 | 8 |
| ST64110 | 10 |
| ST64112 | 12 |

Expandable File Pockets

Premium Pockets

Our premium pockets are the strongest in the industry. Made with superior features, they are high-performing products with unmatched professional appearance. Design pairs with durability for guaranteed visual and functional satisfaction.

ALL EXPANDABLE FILE POCKETS:

- Premium or Standard design
- Three expansion sizes: 1-3/4", 3-1/2", and 5-1/4"
- Choose between letter or legal size
 - Letter:** 9-1/2" W x 11-3/4" H
 - Legal:** 9-1/2" W x 14-3/4" H
- Pocket or end tab style
- End tabs are double-ply
- Manufactured in Wisconsin
- Stock items ship same day

POCKETS

60% recycled content

| Item # | Size | Expansion | Qty per box | Qty per Ctn | Lb / 1,000 |
|----------|--------|-----------|-------------|-------------|------------|
| PRMP1211 | Letter | 1-3/4" | 50 | 200 | 260 |
| PRMP1213 | Letter | 3-1/2" | 25 | 100 | 280 |
| PRMP1215 | Letter | 5-1/4" | 25 | 100 | 320 |
| PRMP1511 | Legal | 1-3/4" | 50 | 200 | 280 |
| PRMP1513 | Legal | 3-1/2" | 25 | 100 | 320 |
| PRMP1515 | Legal | 5-1/4" | 25 | 100 | 360 |

END TAB POCKETS

60% recycled content

| Item # | Size | Expansion | Qty per box | Qty per Ctn | Lb / 1,000 |
|-----------|--------|-----------|-------------|-------------|------------|
| PRMET1211 | Letter | 1-3/4" | 50 | 200 | 260 |
| PRMET1213 | Letter | 3-1/2" | 25 | 100 | 280 |
| PRMET1215 | Letter | 5-1/4" | 25 | 100 | 320 |
| PRMET1511 | Legal | 1-3/4" | 50 | 200 | 280 |
| PRMET1513 | Legal | 3-1/2" | 25 | 100 | 320 |
| PRMET1515 | Legal | 5-1/4" | 25 | 100 | 360 |

PRMP1215



- 11pt premium textured Reprise Red wallet

- 18pt acid-free manila liners



PRMET1511

- 18pt reinforced manila outside back

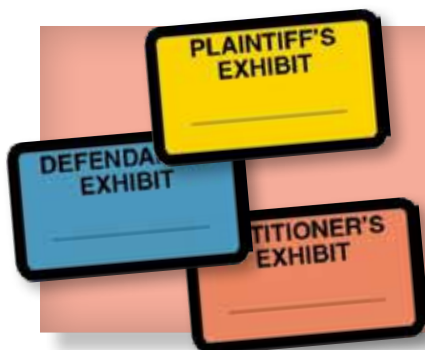

We've got your legal filing supplies covered. For Exhibit Labels, Label Bands, and more legal industry exclusives, check out pages 29-30.



Standard Pockets

Standard pockets are the ideal solution for frequently-accessed files and long-term storage. They are resilient and visually appealing, bringing reliability and convenience to your desk. Look no further for quality products at a friendly price.

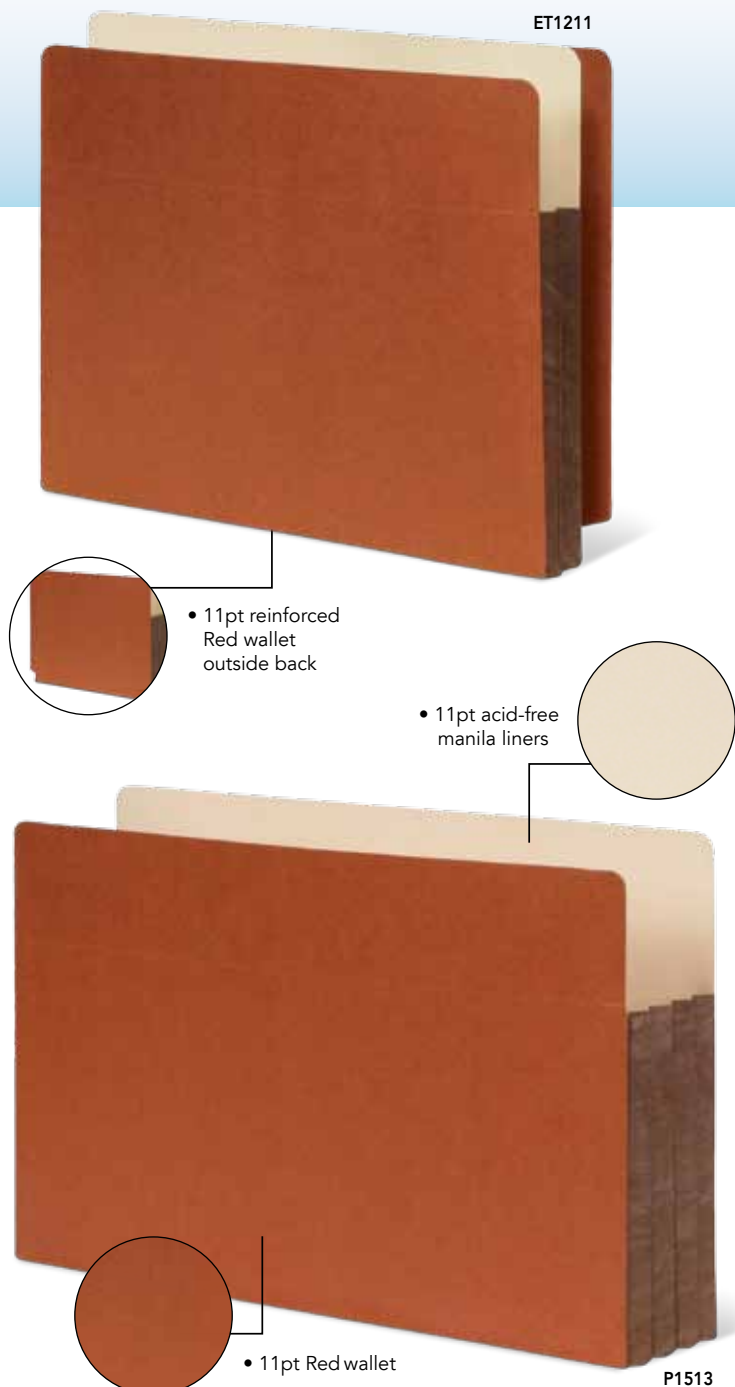

POCKETS

10% post-consumer waste

| Item # | Size | Expansion | Qty per box | Qty per Ctn | Lb / 1,000 |
|--------|--------|-----------|-------------|-------------|------------|
| P1211 | Letter | 1-3/4" | 50 | 200 | 240 |
| P1213 | Letter | 3-1/2" | 25 | 100 | 280 |
| P1215 | Letter | 5-1/4" | 25 | 100 | 320 |
| P1511 | Legal | 1-3/4" | 50 | 200 | 260 |
| P1513 | Legal | 3-1/2" | 25 | 100 | 280 |
| P1515 | Legal | 5-1/4" | 25 | 100 | 320 |

END TAB POCKETS

10% post-consumer waste

| Item # | Size | Expansion | Qty per box | Qty per Ctn | Lb / 1,000 |
|--------|--------|-----------|-------------|-------------|------------|
| ET1211 | Letter | 1-3/4" | 50 | 200 | 260 |
| ET1213 | Letter | 3-1/2" | 25 | 100 | 280 |
| ET1215 | Letter | 5-1/4" | 25 | 100 | 320 |
| ET1511 | Legal | 1-3/4" | 50 | 200 | 280 |
| ET1513 | Legal | 3-1/2" | 25 | 100 | 320 |
| ET1515 | Legal | 5-1/4" | 25 | 100 | 360 |



Wallets

10" H x 15" W expansion pocket with a full height Tyvek®-reinforced gusset, flap, and a secure elastic cord. Available in three expansions and 11pt or 17pt Red wallet. See page 27 for custom options!

Expandable File Pockets

Customize it!

We can customize our expandable file pockets with a variety of gussets, materials, and accessories. From panel details to gusset colors and more, our pockets are a blank canvas onto which you can paint your perfect filing solution!



Materials

Any of our 15pt pulp-dyed colors are at your fingertips to make a bold statement, or choose manila for a clean look.

15pt Pulp-Dyed Colors



Gussets

Tyvek® is extremely durable and available in a variety of colors. Here are just a few, but turn to page 23 for more options!

Common Gusset Colors



Eyelets

Reinforce gusset stability with eyelets on the front, back, or both panels.

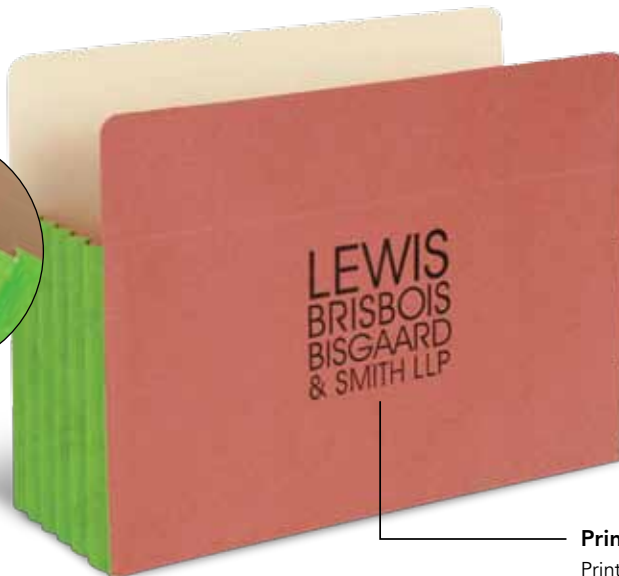
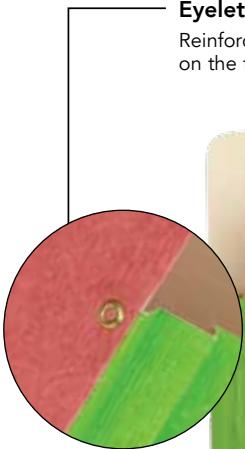

Printed Panels

Print logos, forms, or other information on any part of the pocket.

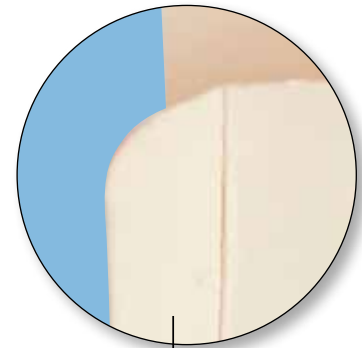

Flexible Side Tabs

Request flexible side tabs for maximum protection against wear and tear!

Patent and Trademark Application Folders

The tri-fold design of these patent and trademark folders keeps documents organized, secure, and easily accessible throughout the trademark process. Our folders are durable and designed to last.

Application Folders

10" x 14-1/2"

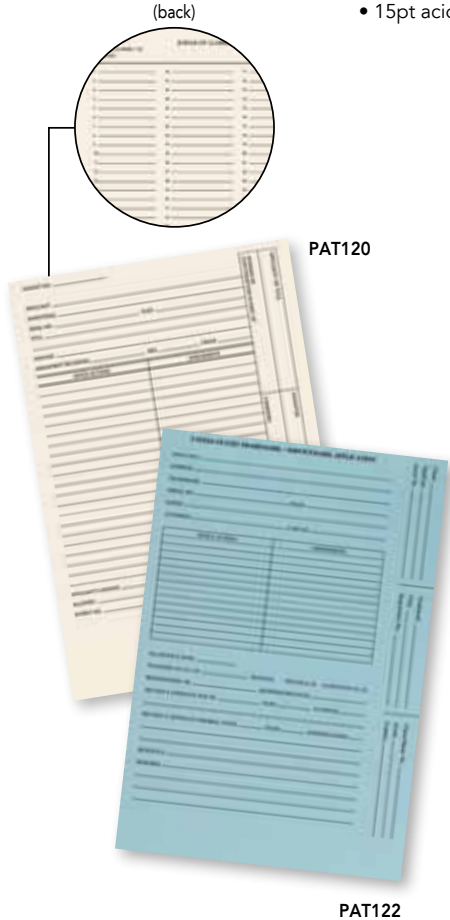
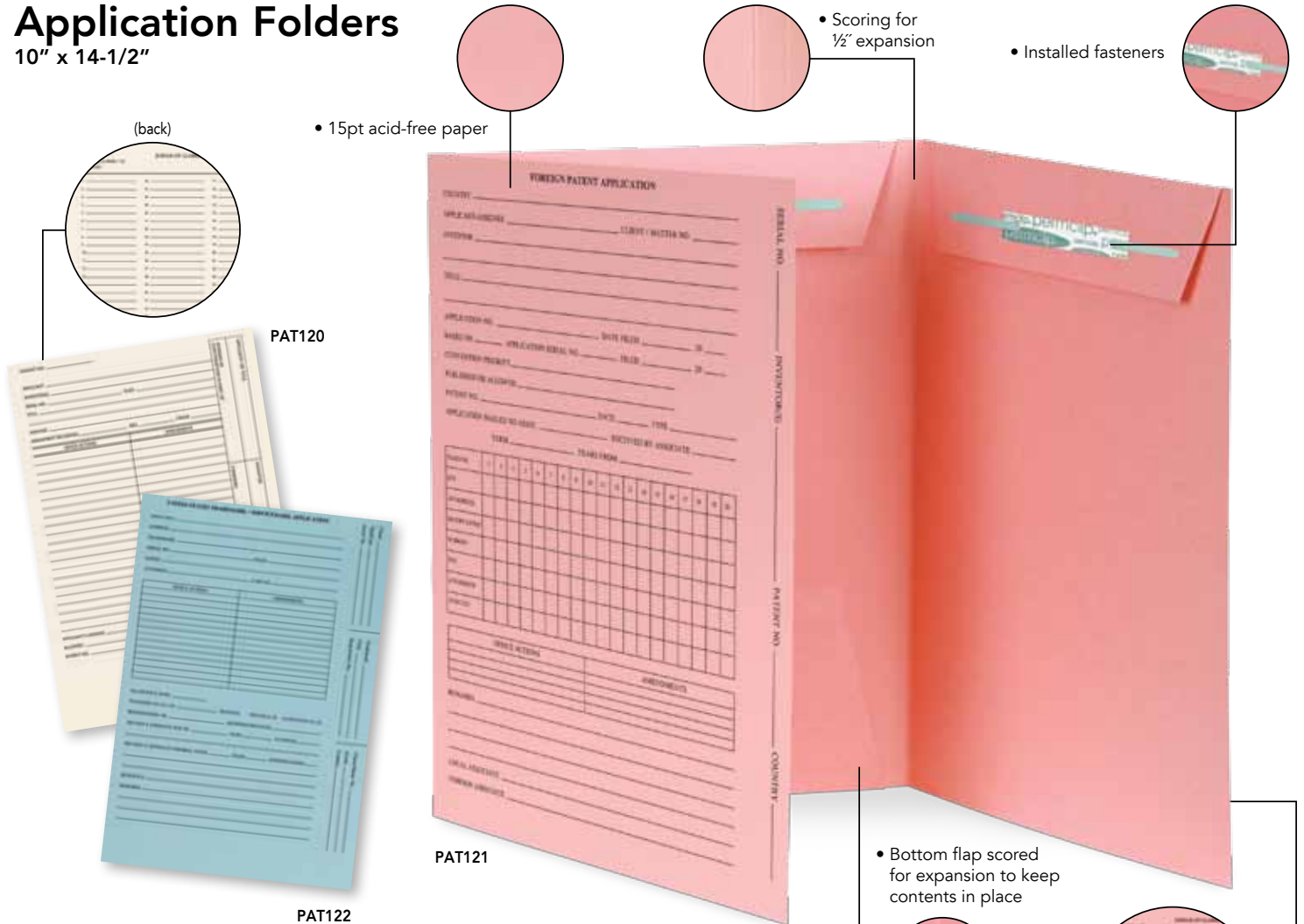

10% post-consumer waste

| Item # | Description | Qty per box |
|--------|--|-------------|
| PAT120 | Manila - Patent Application - Fasteners Installed | 25 |
| PAT121 | Salmon - Foreign Trade Application - Fasteners Installed | 25 |
| PAT122 | Blue - US Trade/Service Mark Application - Fasteners Installed | 25 |

CUSTOM OPTIONS

15pt Colors



20pt Colors



We can customize these to match nearly any style or design.

- End tab configuration
- Custom printing on any panel
- Hole-punching
- Elastic or VELCRO® closure
- Reinforced or flexible end tabs
- Tyvek® gussets
- Store digital media with our 2GB or 4GB DigiStrip (page 35)

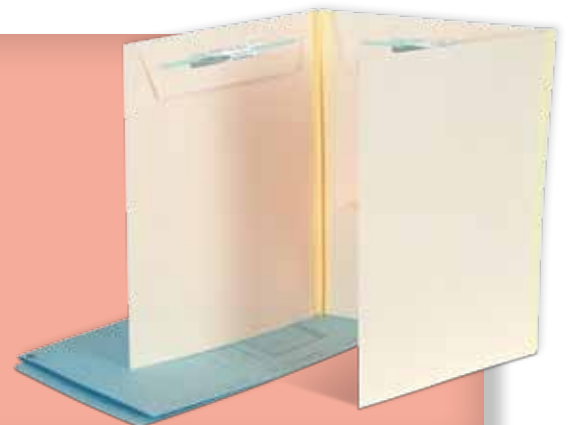



Label Bands

Size: 2" H x 9-5/8" W

Label and File Pocket handle, in one convenient strip! Durable adhesive Tyvek® stands up to wear and tear, and is nearly impossible to rip. (48/pkg)

| | | |
|----------------------|-----------------|----------------------|
| 9201YL Yellow | 9202RD Red | 9203LB Light Blue |
| 9204DBL Dark Blue | 9205GR Green | 9206WH White |

Exhibit Labels

Size: 1" H x 1-5/8" W

Color-coded for quick identification, plus space for writing letters or numbers. (252/pkg)

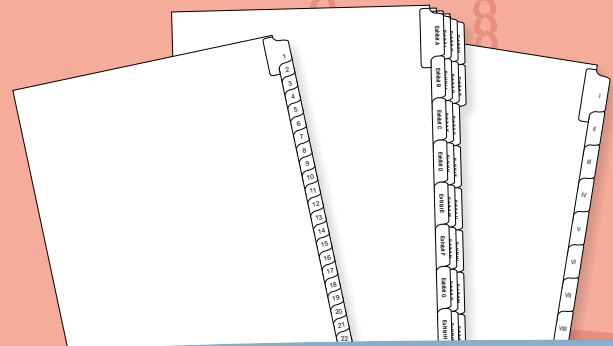
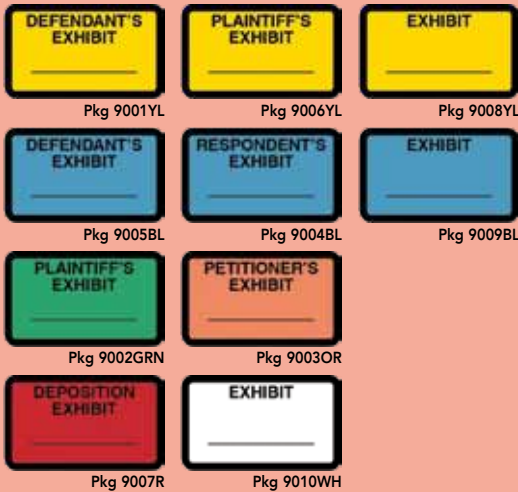

Full assortments of All-State®, Avery®, and Blumberg® legal indexes provide exceptional case organization! (pages 47–52)

Print-On Exhibit Labels

Size: 1" H x 1-5/8" W

Blank exhibit labels for laser printing. Instructions included in each package. (240/pkg)

| | |
|--------|--------|
| 9101WH | White |
| 9102BL | Blue |
| 9103YL | Yellow |
| 9104R | Red |
| 9105GR | Green |
| 9106OR | Orange |

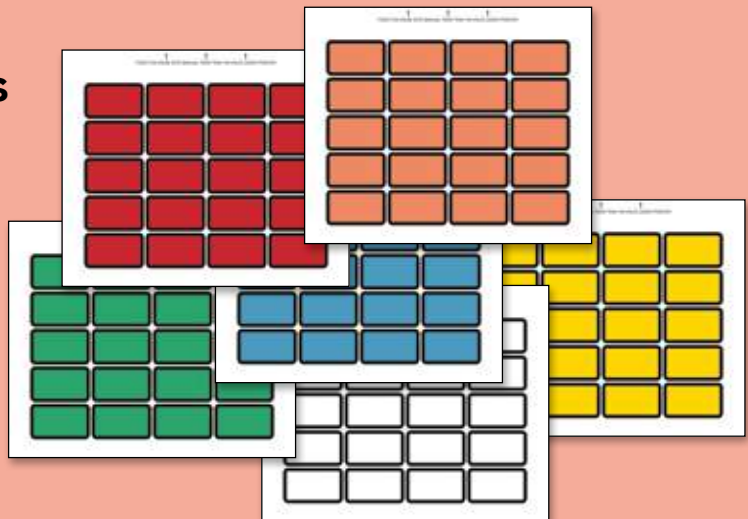

Custom Presentation Folders

You will stand out when you display a polished, consistent image with custom presentation solutions. Brand integrity is important, and you will build your presence in the community when you present legal documents to your clients using quality presentation materials. We've got you covered from portfolios to folders, paper colors to foil-stamped printing, plus optional business card diecuts in the pockets.



Paper Choices Include:

| | | |
|------------------|------------------------|--------------------|
| black linen | emerald green linen | burgundy linen |
| natural linen | midnight blue linen | evergreen felt |
| navy felt | merlot felt | soft white felt |

Call us and ask about more
paper and foil options!

Binders and Report Covers

Sturdy pressboard binders and report covers available in multiple colors and sizes.

- Perclip® fastener included
- Tyvek® reinforcement strengthens spine edges
- Choose from all pressboard types (page 23)
- Letter or legal
- Side or top binding



Fasteners



We use only permclip® – the world's finest bonded fasteners – in all of our products. Not sure what position or the number of fasteners you'll need? We've got your solution – just add fasteners as you go. With our line of functional self-applied fasteners, you can choose where and when they are needed!

Foamclip - Item #2914

6-3/4" x 3/4"
(100/Box)



unique, flexible,
non-woven
fabric-and-foam

Just peel liner
and press firmly!

Larger than actual size

twin metal 2" prongs
are made with the grain,
for more bending with
less breakage



Just Peel, Press, and Fasten

Foamclip® is the world's strongest self-applied pressure-sensitive file fastener. Its unique, flexible, non-woven fabric-and-foam construction guarantees a permanent, super-strong bond to paper, glass, plastic, metal, or wood. So papers can be securely fastened...

On file folders



To file cabinets



**SECURE
LISTS AND
CALENDARS
IN PLAIN
VIEW!**

On the wall



Even on your desk



**NEVER
FUMBLE FOR
NUMBERS
AGAIN!**

...WHEREVER! FOREVER!

Reinforcer

Peel and Stick

The permclip® reinforcer is a 2" fastener bonded onto a strong manila-base strip with a heavy-duty, pressure-sensitive adhesive. Brings extra strength to new files, or bring old files back to service, with one easy to use fastener. Just peel and stick!



- Self-adhesive back allows for easy application
- Broad-based surface provides larger bonding area
- Adds strength to new folders
- Rejuvenates old folders
- 2" permclip® prongs accommodate larger files
- 100 individual strips per box

Bring old, torn files back to life!



Smaller than actual size

Reinforcer - Item #2912
8-1/2" x 1" (100/Box)

Earflap

Simple, Quick, and Efficient

Break up the log jam of bulky files for ultimate ease in file organization and management. Earflaps let you sectionalize your files by any criteria you choose, as your files grow.

Earflap - Item #2916
7-7/8" x 2-1/2" (50/Box)



Smaller than actual size

Sectionalize by any criteria you choose, even add category dividers!

Standard 2-3/4" center-to-center holes; works best with permclip® fasteners.

Use pen, marker, or pencil on the writeable tab.

All Fasteners are Not Created Equal

We are proud to feature permclip® fasteners throughout the catalog! For more than 35 years, permclip® has been developing sophisticated manufacturing processes to achieve the highest standards and quality, creating the world's strongest, most reliable fastener.

See how competing fasteners compare to permclips®:

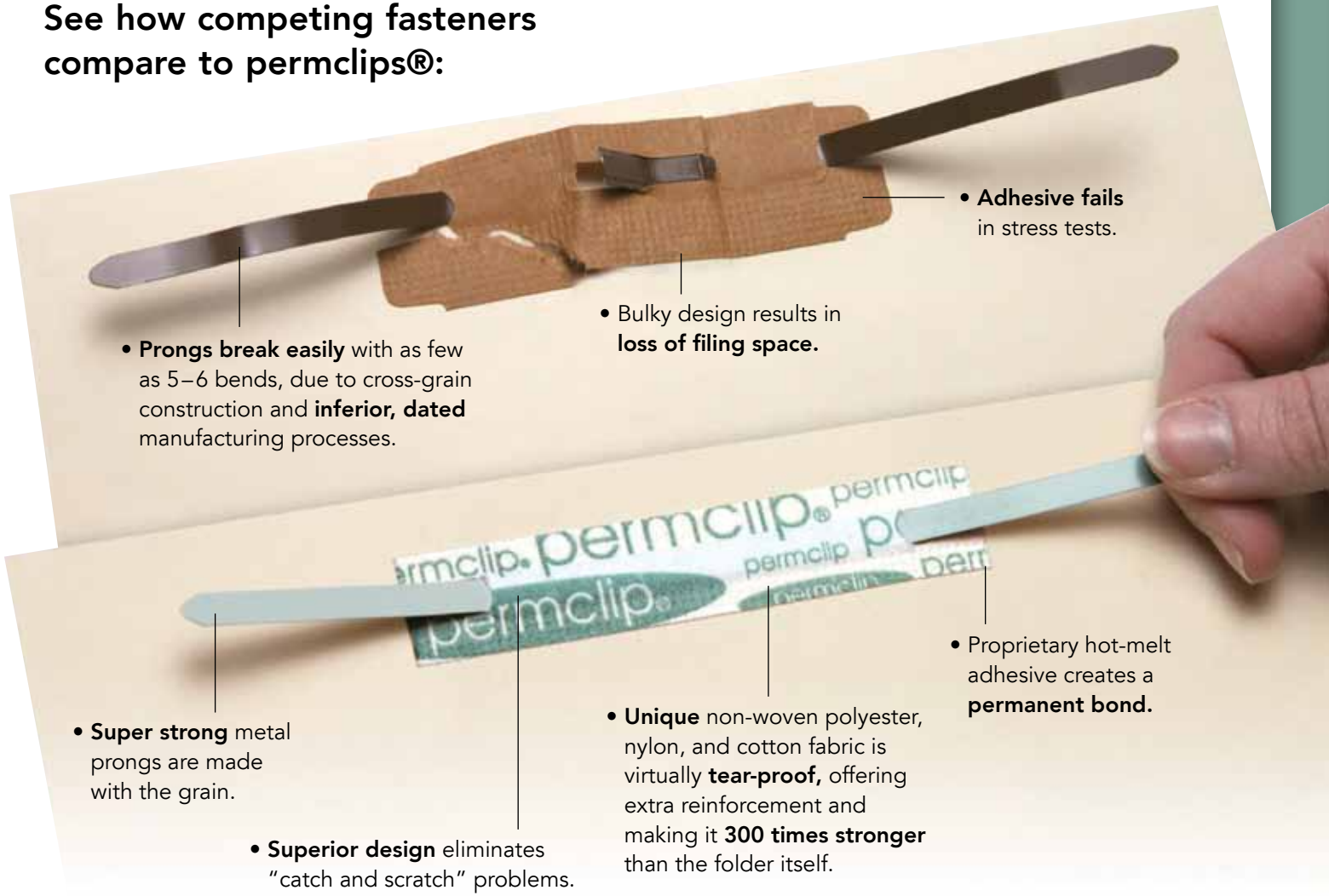

WHY CHOOSE LESS, WHEN YOU CAN HAVE THE BEST?

- Bend them again and again without breakage.
- Superior steel-encased design eliminates "catch" and "scratch" problems.
- Green by design! Permclip's® waste is .001% making it more environmentally friendly than any other brand.



The Only Fastener Accepted by
US Government Specifications

(GSA rejects all other fasteners)

Fasteners and Accessories

MediClip / DocuClip

This unique 5" capacity fastener converts any file folder into a ring binder, loose-leaf format. Flexible 3-piece construction attaches in seconds to any type of file folder. Item #2913 (100/Box)

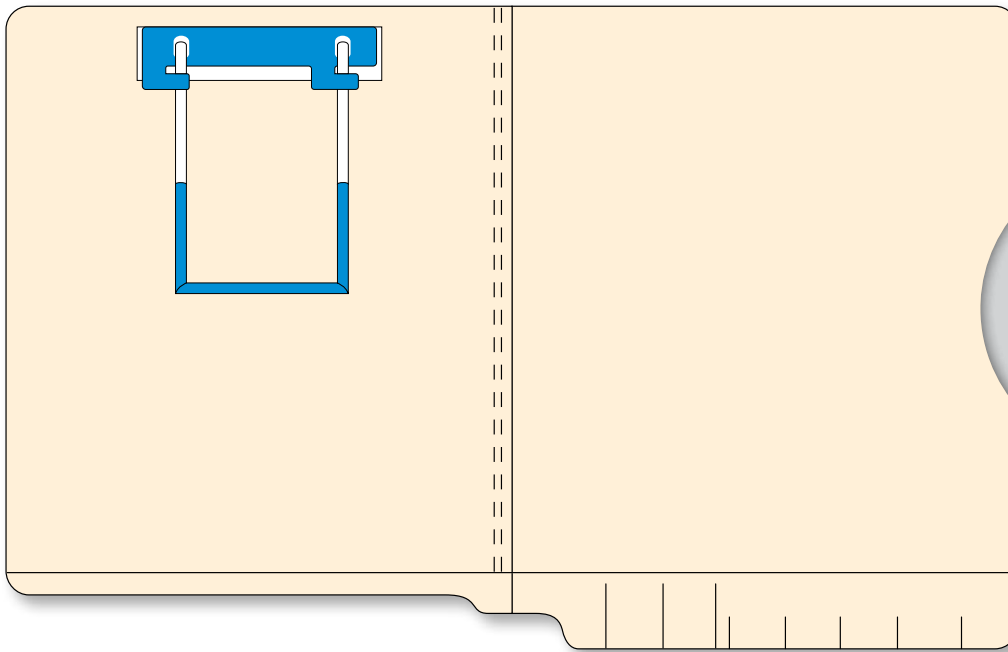

Reinforcing Strips (7551RS)
Add durability to important documents that are mounted within charts; or repair any ripped 2-hole punches. Strips are clear, self-adhesive, 3-5/8" W pre-punched with 1/4" holes on 2-3/4" center-to-center. (500/box)



U-File-M (U-FILE-M)
Make each folder read like a book. Records are affixed to tabs of the strip in either ascending or descending order. Put oldest information on the top, or newest information on the top, whichever you prefer. (100/box)



DocuStrip (DOCUSTRIP)
Adding a DocuStrip saves additional space by eliminating the compressor bar, and allows for easier viewing, insertion, or deletion of material. It also allows file dividers and pages to turn easily and lie flat, similar to a ring binder. (100/pkg) Order the complete kit, DOCUSET, and save! (includes MediClip and DocuStrip)

DigiStrip

KEEP PHYSICAL AND DIGITAL FILES TOGETHER!

The DigiStrip is a USB flash drive fastener attachment that makes it possible to store all corresponding digital files with the physical records.

- Perfect for storing presentations, images, & video
- Ideal for real estate agents, lawyers, & designers
- No more lost USB flash drives
- Available with either 2GB or 4GB capacity



safely secures onto fastener prongs

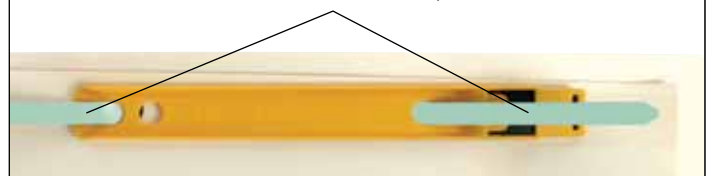

Bottom Tab Outguides

Body 9-1/2" x 11-7/8", Overall 9-1/2" x 13"
 Angle cut pocket and thumb-notched charge-out slip pocket. Double sided "OUT" tab on bottom.

- OG4814R Red
- OG4813P Purple
- OG4810BK Black
- OG4811OR Orange
- OG4812PK Pink
- OG4817Y Yellow
- OG4807G Green
- OG4801BE Blue
- OG4800CL Clear



Charge-Out Slips

These simple forms provide written records to control borrowed files. Slips are inserted into the smaller pockets of outguides. (100/pkg)

FILE NAME / NUMBER _____

DATE REMOVED _____

DATE TO BE RETURNED _____ REMOVED TO _____

SIGNATURE: _____

WHEN REMOVING A FOLDER FROM THE FILE, PLEASE ENTER FOLDER NUMBER AND / OR TITLE HEREON, SIGN YOUR NAME, INDICATE DATE REMOVED, DATE TO BE RETURNED AND INSERT THIS CARD INTO THE POCKET OF THE OUT GUIDE. INSERT OUT GUIDE IN PLACE OF FOLDER REMOVED.

FORM 92542 / 7800CO Charge Out Form 7800

7800CO

Center Tab Outguides

Body 9-1/2" x 11-7/8", Overall 9-1/2" x 12-7/8"
 Angle cut pocket and thumb-notched charge-out slip pocket. Center placed double sided "OUT" tab.

- | | |
|-----------------|----------------|
| OG7801BE Blue | OG7812PK Pink |
| OG7807GN Green | OG7813P Purple |
| OG7811OR Orange | OG7814R Red |
| OG7810BK Black | OG7817Y Yellow |



End Tab Converters

End Tab Converters are a quick and economical alternative to replacing entire file folders. The self-adhesive strip adheres to both the front and back of the folder.

- | | |
|-----------------|--------------|
| ETC9165 White | Full End Tab |
| ETC9150 White | 8" End Tab |
| ETC9150M Manila | 8" End Tab |
| ETC8150 White | Full End Tab |

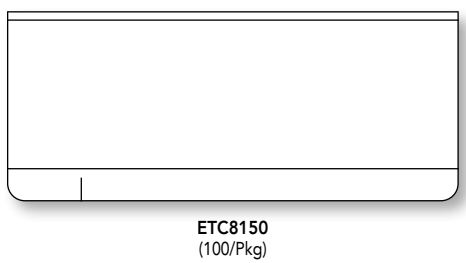
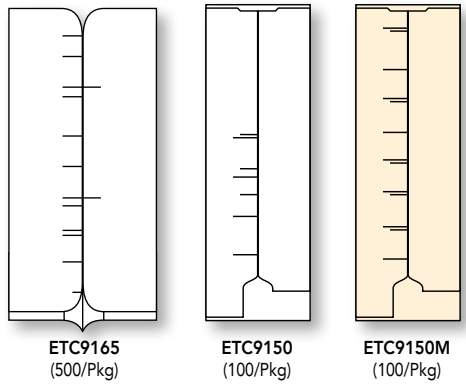

USE WITH ANY
POCKETS
OR FOLDERS!

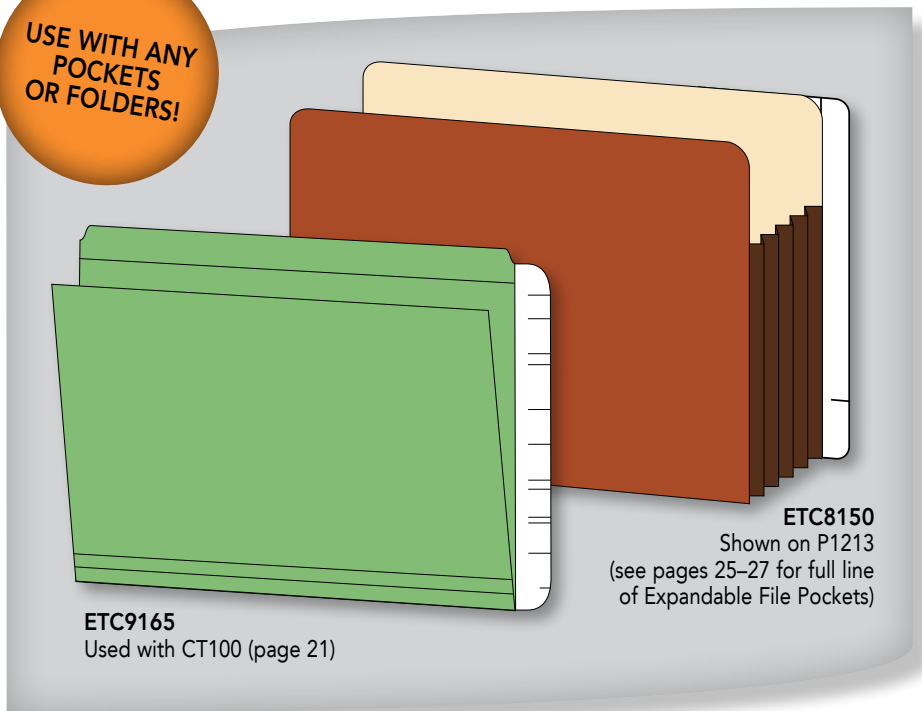

ETC9165
Used with CT100 (page 21)

ETC8150
Shown on P1213
(see pages 25-27 for full line of Expandable File Pockets)

Folder Pockets

Manila & Kraft Pockets

| Stock No. | Description | Size | Pack |
|-----------|---------------------------|-----------------------------------|------------|
| DP11 | 11pt Manila Double Pocket | Back: 8-1/2" x 9", Front: 5" x 9" | 100/Carton |
| 4024 | 11pt Manila Single Pocket | Overall Size: 5-1/2" x 8-3/4" | 100/Carton |
| 4021 | 11pt Manila Single Pocket | Overall Size: 5" x 9-1/4" | 100/Carton |
| FE96S | 32lb Kraft Envelope | Overall Size: 6" x 9" | 100/Carton |
| FE85 | 28lb Kraft Envelope | Overall Size: 5" x 8-1/8" | 100/Carton |
| FE64 | 28lb Kraft Envelope | Overall Size: 4" x 6-1/8" | 100/Carton |

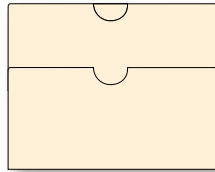

DP11

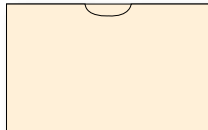

4024



4021



FE85

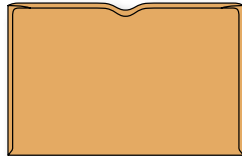

FE96S

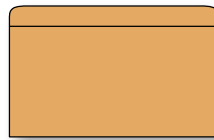

FE64

Pockets above are not self-adhesive.

Can be factory-installed into any stock folder

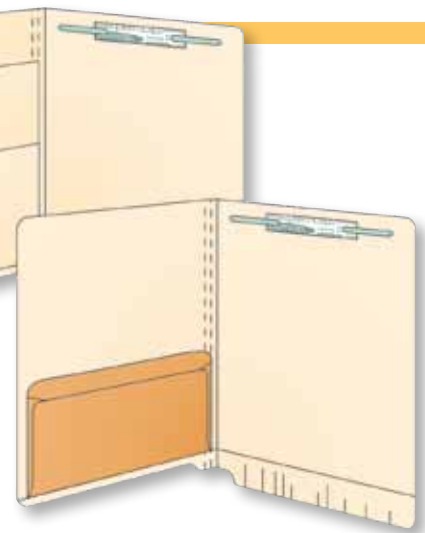

XR35

2-1/4" H x 3-1/2" W
Dental x-ray envelope to store bite plates.
(500/box)

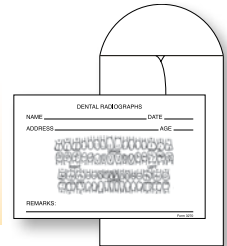

Self-Adhesive 11PT Manila Pockets

Whenever you need to add a pocket or fill in while factory is installing your order, these are a great solution.

SAP1175: 11-1/2" W x 7-1/2" H

SAE85: 8-5/8" W x 5" H

SAE20: Back 9" W x 8-1/2" H
Front 9" W x 5" H



SAP1175
(100/Box)

Unique single ply construction with self-adhesive flaps creates less bulk

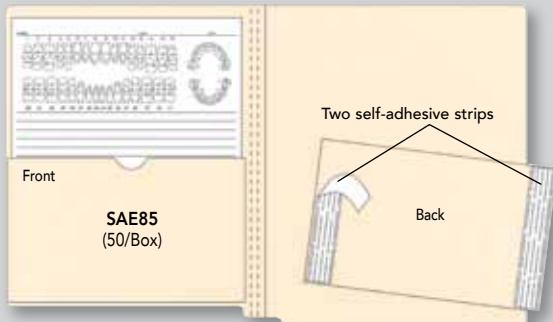

Front

SAE85
(50/Box)

Two self-adhesive strips

Back

11pt manila single pocket

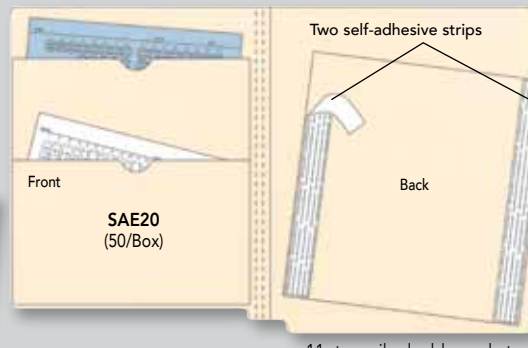

Front

SAE20
(50/Box)

Two self-adhesive strips

Back

11pt manila double pocket



Fold edges under, peel off backing and adhere to folder.

Self-adhesive Vinyl & Poly Pockets

Choose from several sizes of vinyl and poly pockets to fit your various needs. Pockets are ideal for:

- Lab reports
- Film
- ID cards
- Phone messages
- Script duplicates
- Any small document

Peel off the backing paper and apply to your patient charts or wherever it is most convenient for your use.

6 Mil Vinyl

Heavy-duty vinyl pockets resist punctures and tears.



5 Mil Poly

Pockets are an economical choice for storing loose items like notes, X-rays, etc.

UNDERLINED DIMENSION IS THE OPEN SIDE OF THE POCKET (100/PKG)

5 Mil Poly Pockets

| Stock No. | Overall Size | Inside Dimension |
|-----------|--------------------|--------------------------|
| 7205S | 2-3/4" x 3-5/8" | <u>2-3/8"</u> x 2-15/16" |
| 7210S | 3-1/8" x 4" | <u>2-1/2"</u> x 3-1/4" |
| 7220S | 4-1/2" x 5-9/16" | <u>4-1/8"</u> x 4-3/4" |
| 7240S | 5" x 7-1/4" | <u>4-1/2"</u> x 6-1/2" |
| 7215S | 5-1/2" x 3-1/4" | <u>5"</u> x 2-1/2" |
| 7225S | 5-3/4" x 3-3/4" | <u>3"</u> x 5-3/16" |
| PD64 | 7" x 5" | <u>6-1/2"</u> x 4-1/4" |
| 7250S | 9-1/4" x 6" | <u>8-3/4"</u> x 5-1/4" |
| 7260S | 11" x 8-3/4" | <u>10-1/2"</u> x 8" |
| 7255S | 9-5/16" x 11-1/16" | <u>8-3/4"</u> x 10-3/4" |

6 Mil Vinyl Pockets

| Stock No. | Overall Size | Inside Dimension |
|-----------|-----------------|------------------------|
| VP53SA | 5-3/8" x 3-5/8" | <u>5-1/8"</u> x 3" |
| VP64SA | 6-3/8" x 4-1/2" | <u>6-1/8"</u> x 3-7/8" |
| VP85SA | 9" x 5-1/2" | <u>8-1/2"</u> x 4 3/4" |

Lock-It Pockets (self-adhesive)

LP610SA: 6-1/2" W x 10" H

LP56SA: 5-1/2" W x 6-1/4" H

Durable, clear polyethylene ziplock style secures small documents including X-rays, photos, diskettes, CDs and more (100/Box)



Zip-It Pockets

Secure single track closures keep out dirt and moisture. 2 mil thick and allows visual observation (100/Box)

| Stock No. | Description | Size |
|-----------|-----------------|-----------------------|
| ZIP23 | Clear Front | Overall Size: 2" x 3" |
| ZIP34 | Clear Front | Overall Size: 3" x 4" |
| ZIP35 | Clear Front | Overall Size: 3" x 5" |
| ZIPW23 | Writeable Front | Overall Size: 2" x 3" |
| ZIPW35 | Writeable Front | Overall Size: 3" x 5" |
| ZIPW46 | Writeable Front | Overall Size: 4" x 6" |



Indexes

Features

- Colored, reinforced mylar tabs for easy identification
- Bind edge reinforced holes for added durability
- Create tab titles for any application
- Custom paper stock available, call for details



Highlights

Custom indexes are often needed to organize documents that reside within a file folder or divide sections within a binder. Indexes allow documents and subject matter to be located and referenced instantaneously allowing retrieval of information to be hassle-free. Reinforced index tabs are available in 16 standard tab colors, with special neon colors also available (call for details). Custom indexes are available in a variety of different tab lengths and widths and can have printing applied to both the front and back of the tab. Body copy is also available (some limitations apply, call for details).



Proven Index Solutions

Multi-Functional Solutions Organize Contents of Patient Records

Use one or all three styles of chart dividers to maximize document organization. Proven to provide a uniform and consistent method to categorize information, each style provides unique benefits.

INDEXES

The most common, economical style provides for multiple categories without excessive bulking in file.

FILEBACKS

Hinged/piggy-back style allows greater flexibility because each category can be utilized individually.

SELF-ADHESIVE DOUBLE DUTY FILEBACKS

Provide the same number of categories with just one half the amount of dividers because the tabs have a different title printed on each side. If ordered with a fastener installed on the front only, they can provide sections for quick, drop-in filing.

Combine the benefits of all three to create the patient chart that works best for you. Turn to the next page for custom options!



Combine Indexes and Filebacks Based on Document Activity

Indexes can be used to divide and categorize documents which have minimal activity or do not require active additions to each section. Filebacks used in conjunction with indexes allow more active use of sections within the chart.

Bottom and Side Tab Indexes Used With Self-Adhesive Filebacks

Maximize and divide without excessive bulk. These three styles of dividers used in conjunction with each other can provide over 20 sections in a standard folder with 3/4" expansion. Center section without fasteners allows for convenient drop-in filing.

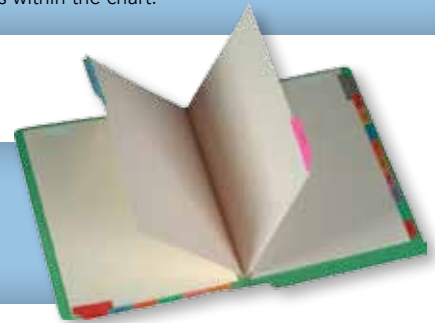

Two Styles of Filebacks Eliminate Folder Distortion

Using both flip-up style and book style filebacks provides for equalization of contents within the record. Also eliminates excessive bulking at one end of folder which allows easier filing and retrieval.

Dividers and Pockets Make a Perfect Chart

Small documents, papers you can't punch, active patient visits and archived information all in one chart...that's creative and efficient. For Pressure Sensitive Pockets see page 38.

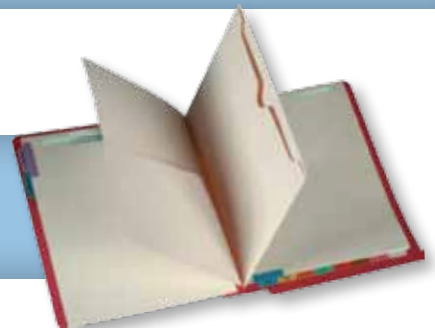

A Great Solution for Very Active Records

DocuClip fasteners (page 35) used in conjunction with standard book style/side tab indexes provide maximum access and flexibility to all patient information. Proven to be a real workhorse.

Custom Chart Dividers/Indexes & Filebacks

Easy Ordering Instructions

- 1 Choose the style of Chart Divider and Paper Color**
 - Index Style A-E
 - Stock Color
 - Fileback Style I-III
 - Self-Adhesive Fileback Style SA
- 2 Specify tab cut size.** See charts below. Plan ahead! Consider leaving an empty position for future use.
- 3 Specify each tab title (text), position, and color.** Side tab styles start at the top, bottom tab styles start at the left.
- 4 Specify packaging:**
 - Collated - Titles boxed together in sets (Filebacks are not attached to each other)
 - Not collated - Titles boxed individually

Chart Divider Styles



Index/Chart Dividers – Styles A-E

- Mylar-reinforced punches
- Tabs printed both sides/mylar-covered
- 8½" x 11" + tab extension



Self-Adhesive Filebacks – Style SA

- Scored hinge with ¾" pressure-sensitive tape
- Two pre-installed 2" bonded fasteners (1 each side)
- Tabs printed both sides with different titles/mylar-covered
- 8½" x 11" + tab extension



Flip-Up Hinged Filebacks – Styles I-III

- Scored hinge with mylar-reinforced slits
- One pre-installed 2" bonded fastener
- Tabs printed both sides/mylar-covered
- 8½" x 11" + tab extension (Style I and III also available in 8½" x 14")

Tab Cut Specifications

Side Tab

Dimensions may vary depending on shoulder margins.

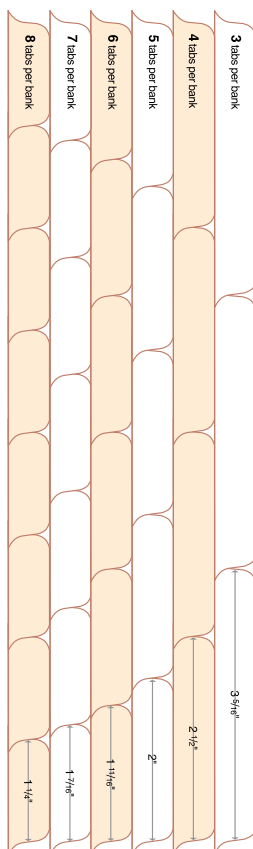

Bottom Tab

Dimensions may vary depending on shoulder margins.

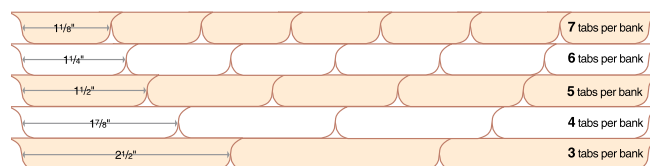

16 Standard Mylar Tab Colors

Neon colors are available for an additional charge.

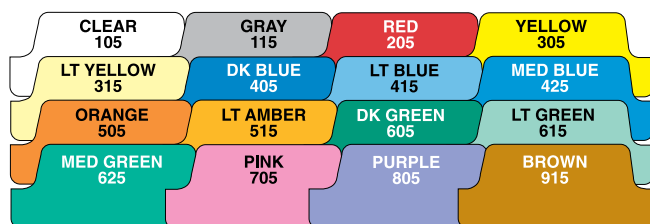

PLAN AHEAD! Consider leaving an empty position for future use.

General specifications are listed on this page. Contact your local sales representative for other options including: body printing, collating, assembly and installation, heavier paper weights and colors, etc.

Stock Printed Collated Sets - Bottom Tab

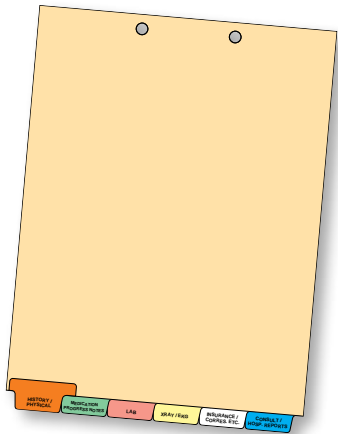

BT11186
50 sets/box

- Pos 1 - HISTORY / PHYSICAL
- Pos 2 - MEDICATION PROGRESS NOTES
- Pos 3 - LAB
- Pos 4 - XRAY / EKG
- Pos 5 - INSURANCE / CORRES. ETC.
- Pos 6 - CONSULT / HOSP. REPORTS

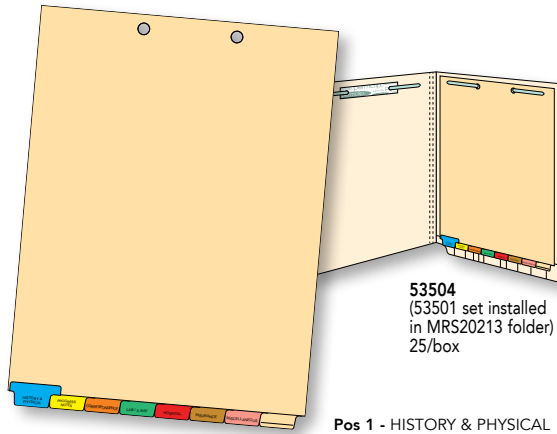

53504
(53501 set installed in MRS20213 folder)
25/box

53501
50 sets/box

- Pos 1 - HISTORY & PHYSICAL
- Pos 2 - PROGRESS NOTES
- Pos 3 - CORRESPONDENCE
- Pos 4 - LAB / XRAY
- Pos 5 - HOSPITAL
- Pos 6 - INSURANCE
- Pos 7 - MISCELLANEOUS
- Pos 8 - BLANK

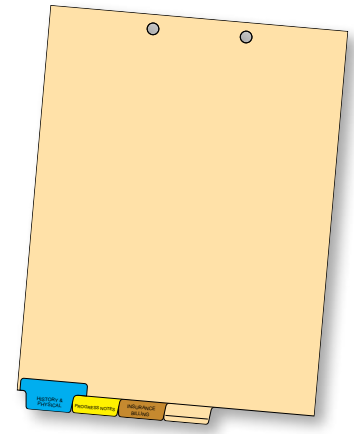

53521
100 sets/box

- Pos 1 - HISTORY & PHYSICAL
- Pos 2 - PROGRESS NOTES
- Pos 3 - INSURANCE BILLING
- Pos 4 - BLANK

Stock Printed Collated Sets - Side Tab

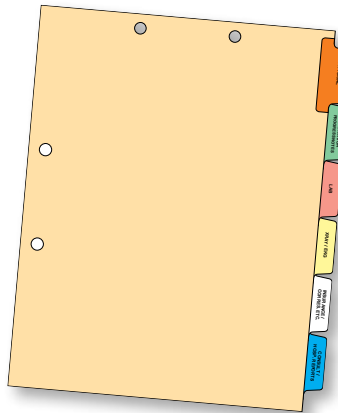

BT10186
50 sets/box

- Pos 1 - HISTORY / PHYSICAL
- Pos 2 - MEDICATION PROGRESS NOTES
- Pos 3 - LAB
- Pos 4 - XRAY / EKG
- Pos 5 - INSURANCE / CORRES. ETC.
- Pos 6 - CONSULT / HOSP. REPORTS

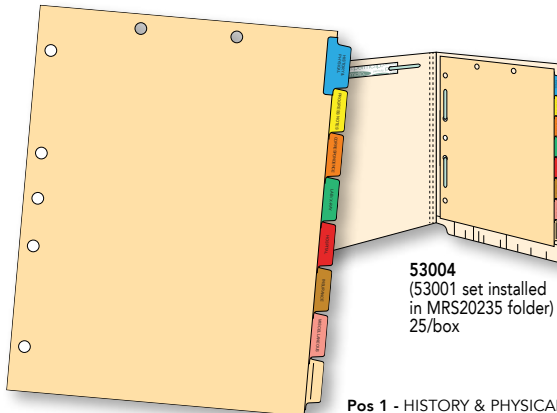

53004
(53001 set installed in MRS20235 folder)
25/box

53001
50 sets/box

- Pos 1 - HISTORY & PHYSICAL
- Pos 2 - PROGRESS NOTES
- Pos 3 - CORRESPONDENCE
- Pos 4 - LAB / XRAY
- Pos 5 - HOSPITAL
- Pos 6 - INSURANCE
- Pos 7 - MISCELLANEOUS
- Pos 8 - BLANK

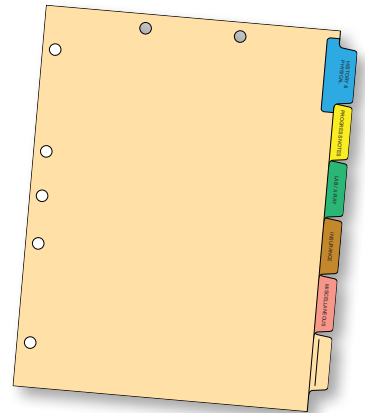

53011
65 sets/box

- Pos 1 - HISTORY & PHYSICAL
- Pos 2 - PROGRESS NOTES
- Pos 3 - LAB / X-RAY
- Pos 4 - INSURANCE
- Pos 5 - MISCELLANEOUS
- Pos 6 - BLANK

Blank Collated Sets

Clear writeable mylar tabs (25 Sets/Box)

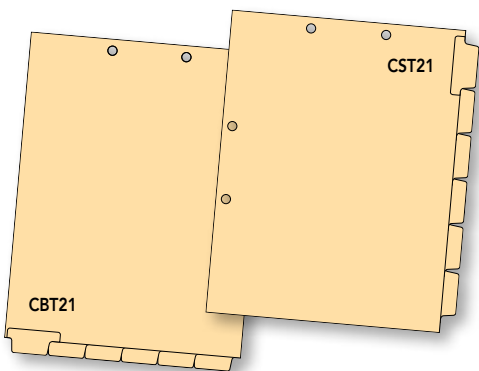

Keep your charts intact with clear, self-adhesive reinforcing strips (page 35)

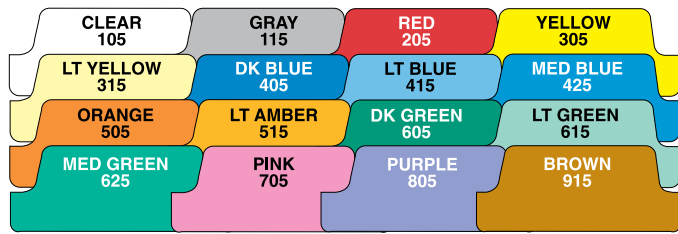

Bottom Tab

BOTTOM TAB STYLE WITH TITLES
1/6 CUT – PUNCHED TOP
SHRINK WRAPPED (100/PACK)

TAB POSITION 1

- History/Physical
52100 ■ Orange
- Immunizations/Injections
52102 ■ Orange
- Lab/Special Reports
52103 ■ LT. Green
- Patient Information
52108 ■ Med. Blue
- Progress Notes
52107 ■ Orange
- HIPAA
52111 ■ Red
- Blank
52121 Clear

TAB POSITION 2

- Correspondence
52204 ■ LT. Yellow
- Diagnostic Testing
52207 ■ Med. Green
- History/Physical
52203 ■ Pink
- Lab
52211 ■ LT. Green
- Medication/Progress Notes
52200 ■ LT. Green
- Prescriptions
52208 ■ Red
- Progress Notes
52201 ■ LT. Green
- X-Rays/Scans
52212 ■ LT. Amber
- Blank
52221 Clear

TAB POSITION 3

- Lab
52300 ■ Pink
- Operative Reports
52302 ■ Med. Blue
- Physical Therapy
52308 ■ Pink
- Physicians Orders
52306 ■ LT. Amber
- Procedures
52310 ■ LT. Amber
- Special Studies
52307 ■ Med. Blue
- Blank
52321 Clear

TAB POSITION 4

- Imaging
52408 ■ Gray
- Miscellaneous
52404 ■ LT. Green
- Nurses Notes
52406 ■ Gray
- Pathology
52407 ■ Brown
- X-Ray
52409 ■ LT. Green
- X-Ray/EKG
52400 ■ LT. Yellow
- Blank
52421 Clear

TAB POSITION 5

- Authorization/Referrals
52502 Clear
- Correspondence
52508 Clear
- EKG
52504 ■ Red
- Insur./Corres., Etc.
52500 Clear
- Letters
52512 Clear
- Miscellaneous
52501 Clear
- Telephone Messages
52503 ■ LT. Yellow
- Blank
52521 Clear

TAB POSITION 6

- Consultation
52612 ■ Red
- Consultation/Hosp. Reports
52600 ■ Med. Blue
- Correspondence
52604 ■ Med. Blue
- Hospital Records
52618 Clear
- Insurance
52609 ■ Med. Blue
- Medical Records
52606 ■ Med. Blue
- Blank
52621 Clear



Side Tab

SIDE TAB STYLE WITH TITLES, INTERCHANGEABLE RIGHT/LEFT SIDE
1/6 CUT — PUNCHED TOP AND SIDE
SHRINK WRAPPED (100/PACK)

TAB POSITION 1

- History/Physical
51103 ■ Orange
- Immunizations/Injections
51110 ■ Orange
- Lab/Special Reports
51105 ■ LT. Green
- Paps & Colposcopy
51101 ■ Orange
- Patient Info
51109 ■ Med. Blue
- Progress Notes
51108 ■ Orange
- HIPAA
51111 ■ Red
- Blank
51121 Clear

TAB POSITION 2

- Correspondence
51204 ■ LT. Yellow
- Diagnostic Testing
51201 ■ LT. Green
- Hospital Records
51200 ■ LT. Green
- Lab
51208 ■ LT. Green
- Medication/Progress
51202 ■ LT. Green
- Prescriptions
51206 ■ Red
- Progress Notes
51203 ■ LT. Green
- Surgery
51205 ■ LT. Green
- X-Rays/Scans
51209 ■ LT. Amber
- Blank
51221 Clear

TAB POSITION 3

- Audiograms
51302 ■ Pink
- Lab
51300 ■ Pink
- Operative Reports
51303 ■ Med. Blue
- Procedures
51310 ■ LT. Amber
- Special Orders
51311 ■ Med. Blue
- Blank
51321 Clear

TAB POSITION 4

- Allergy
51402 ■ LT. Yellow
- Miscellaneous
51406 ■ LT. Green
- Pathology
51401 ■ Brown
- Therapy
51403 ■ Purple
- X-Ray
51408 ■ Gray
- X-Ray/EKG
51400 ■ LT. Yellow
- Blank
51421 Clear

TAB POSITION 5

- Authorization/Referrals
51520 Clear
- Correspondence
51510 Clear
- Financial
51506 ■ LT. Green
- Insurance/Correspondence
51500 Clear
- Miscellaneous
51501 Clear
- Radiology
51505 ■ Red
- Blank
51521 Clear

TAB POSITION 6

- Consultation
51618 ■ Red
- Consult./Hosp. Reports
51604 ■ Med. Blue
- Correspondence
51606 ■ Med. Blue
- Hospital Records
51614 Clear
- Insurance
51602 ■ Med. Blue
- Medical Records
51603 ■ Med. Blue
- Other
51607 ■ Orange
- Previous Medical Records
51601 ■ Gray
- Blank
51621 Clear

Self-Adhesive Dividers and Filebacks Help Organize

Divide the contents of your folders to better organize documents. Easy to install. Use more than one style together in a folder. All dividers are made from 11pt manila stock and have a 7/8" flap with self-adhesive tape. Die-cuts on flaps allow positioning around fasteners.

Folders sold separately. MSDA11 = DIV11

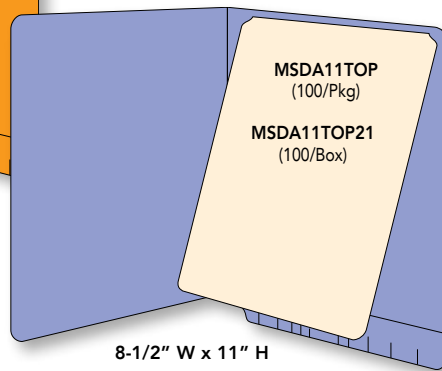
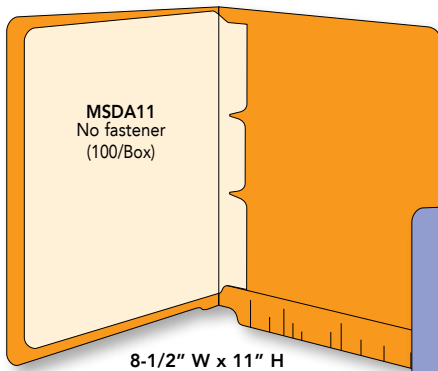
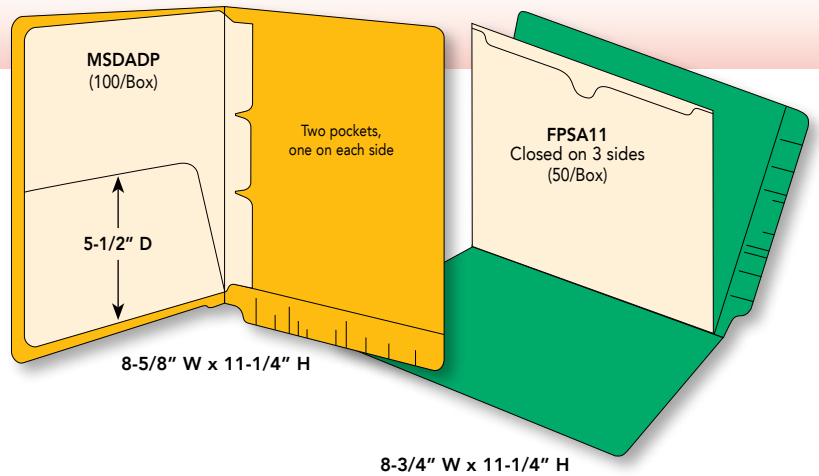
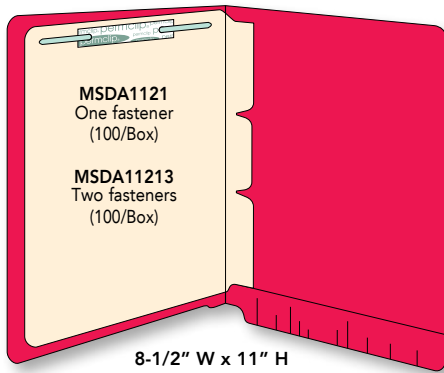

Not all sizes include 7/8" flap

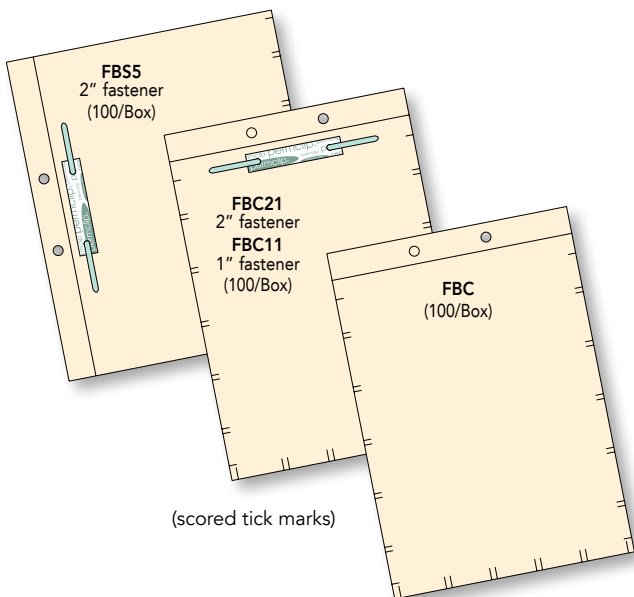
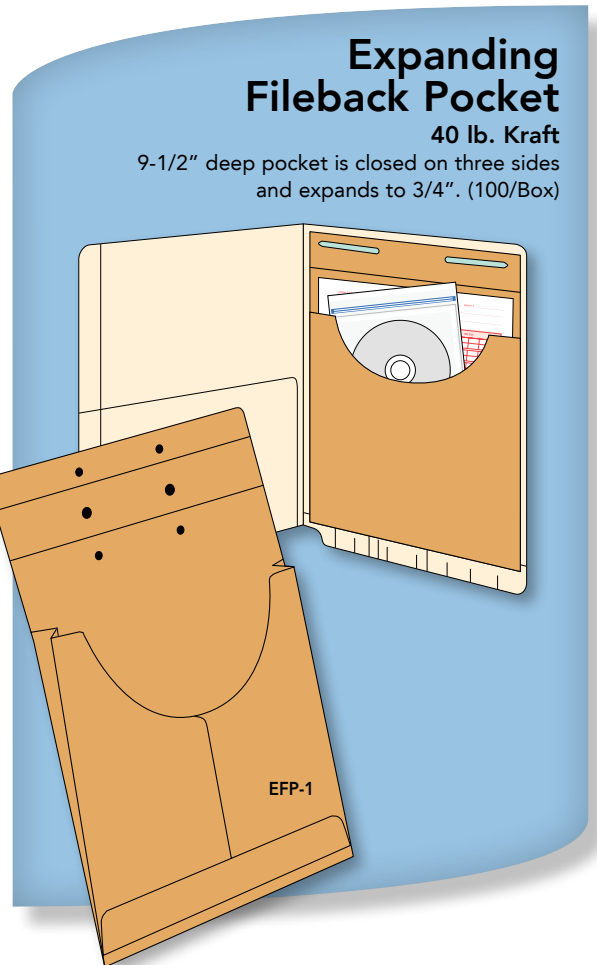

Fileback Dividers

Now get immediate access to each section without removing top sections from the chart. Just fold on score line to form flap and slip divider over existing fastener in folder. The next divider is attached to the fastener on the first divider, and so on. Sturdy 11pt manila stock.

- Add or remove sheets without tearing apart files
- Choose end or side fastener dividers

Index Tabs and Dividers

300 Series/Create Your Own Patient Chart Dividers

Size 1-1/2" x 1-1/2" (before folding)

Organize your patient files with our complete do-it-yourself indexing systems. Create up to thirty-three individual divisions of the patient charts. Use as few or as many as necessary to organize your files efficiently. Self-adhesive tabs are brightly colored for instant recognition. They are Mylar laminated for extra long life.

Can also be used on any of our dividers or filebacks featured on page 44.

PACK (6 tabs/sheet 102 labels per pkg) (see label number)

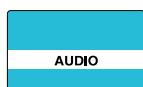

Pack 319A



Pack 302B



Pack 340CF



Pack 341C



Pack 303C

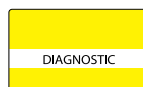

Pack 342D

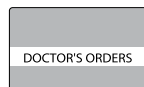

Pack 304D

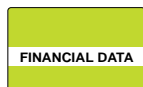

Pack 324F



Pack 346HH



Pack 366HIP

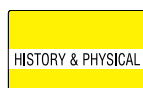

Pack 306HI

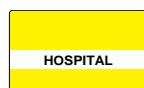

Pack 338HO



Pack 308I



Pack 309L



Pack 348LX

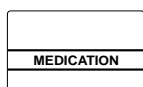

Pack 310ME



Pack 311MI



Pack 356PR



Pack 312PA



Pack 357PI



Pack 318PT

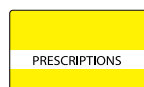

Pack 365P

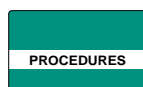

Pack 328P



Pack 313PR



Pack 314R



Pack 316S



Pack 362TP



Pack 321W



Pack 315X



Pack 331BE



Pack 332GN



Pack 333Y



Pack 334PK

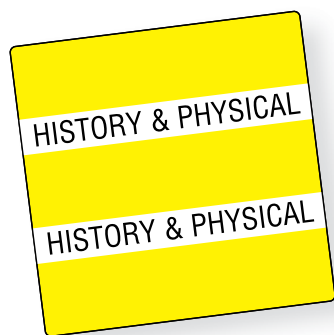

Shown Actual Size



Chart Divider Sheets

Size 8-1/2" x 11"

Divider sheets are 110 lb. white or manila index stock. They are drilled on the top and side for fastener or binder use. Guide lines are preprinted for accurate label application.

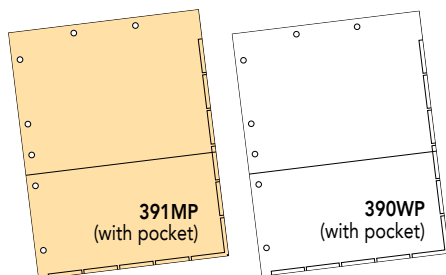
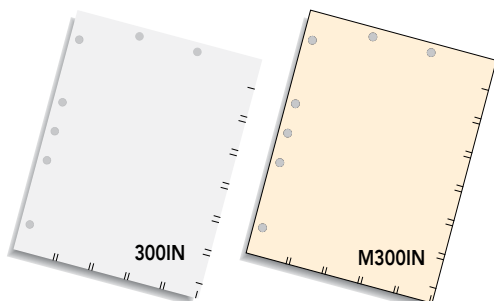

(100 sheets / pkg)

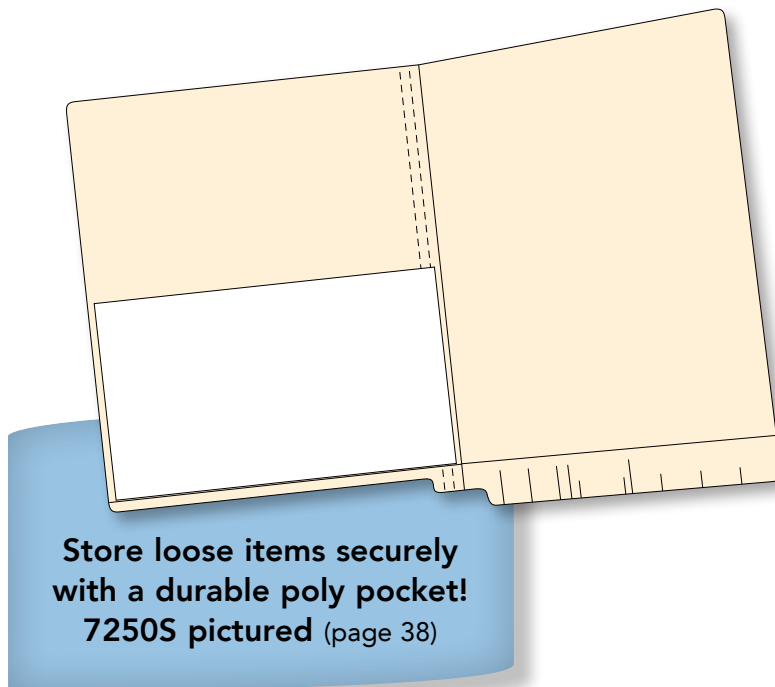

Store loose items securely with a durable poly pocket! 7250S pictured (page 38)

400 Series/Create Your Own Patient Chart Dividers

Size 1-1/4" x 1-1/2" (before folding)

Self-adhesive, laminated tabs help you organize information in patient files with color-coded edges for fast identification. Just choose which classifications you need and attach the pressure-sensitive tabs to the pre-printed position marks on our Chart Divider Sheets.

Can also be used on any of our dividers or filebacks featured on page 44.

PACK (10 tabs/sheet 100 labels per pkg) (see label number)

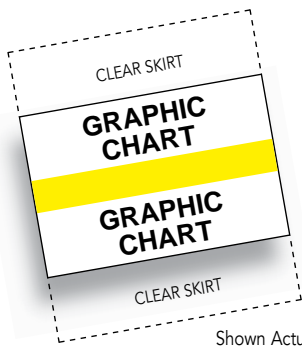

Shown Actual Size

| | | | | |
|--|------------------------------------|---|--|---------------------------------------|
| CONSENT Pack 462C | CONSENT FORMS Pack 431CF | CONSULTS Pack 404C | CORRESPONDENCE Pack 405C | DIAGNOSTIC Pack 438D |
| EKG Pack 403E | EXAM RECORDS Pack 430E | FINAL DIAGNOSIS Pack 406FD | FLOW SHEETS Pack 439F5 | GRAPHIC CHART Pack 407GC |
| HEALTH HISTORY Pack 432H | HIPAA Pack 460HIP | HISTORY & PHYSICAL Pack 408HP | HOSPITAL Pack 409H | INSURANCE Pack 410I |
| LAB REPORTS Pack 411LR | LAB/X-RAY Pack 412LX | MEDICATIONS Pack 413ME | MISC. Pack 414MI | NURSES NOTES Pack 415NN |
| OPERATIVE REPORT Pack 416OR | OTHER NOTES Pack 464ON | PATHOLOGY RESULTS Pack 418PR | PATIENT INFORMATION Pack 428PI | PHYSICAL THERAPY Pack 425PT |
| PHYSICIANS ORDERS Pack 419PO | PRESCRIPTIONS Pack 459PR | PROCEDURES Pack 437P | PROGRESS NOTES Pack 420PN | REFERRALS Pack 436R |
| RX Pack 455RX | SURGICAL Pack 421S | TREATMENT PLAN Pack 429TP | X-RAY Pack 423X | X-RAY-EKG Pack 424XE |
| Pack 434WBK writeable | | | | |



Chart Divider Sheets

Size 8-1/2" x 11"

Organize your practice files and separate them into sections. The 110 lb. white or manila index stock has top and side position marks for chart tabs. Two and three-hole punched for top and side fastener or binder use.

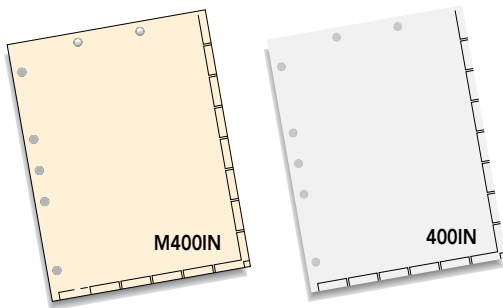

(100 sheets / pkg)

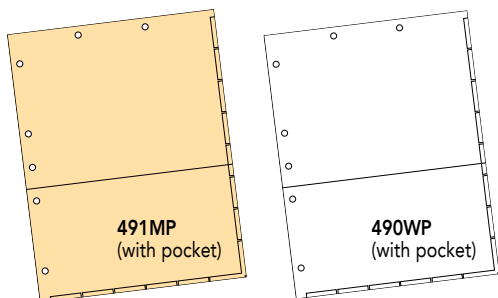

(50 sheets / pkg)



Send up to 50 insurance claims to the same carrier with this jumbo, side-seal HCFA envelope (page 92)

- Sold as individual packages or collated sets
- Printed on 80lb White FSC® stock
- Clear mylar laminated tabs
- Printed on both sides, Tumbler style

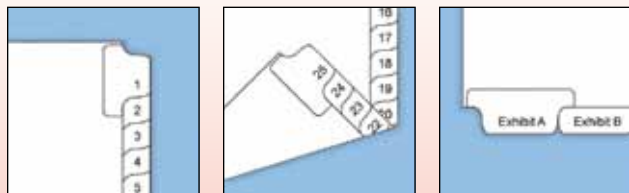

- Typeface is small and light
- Tabs printed Tumbler style
- Bottom exhibit tabs are 6 tabs/bank
- "Exhibit" is both upper and lower case

Additional titles available.

Collated Sets

11" LETTER SIZE

| Item # | Title | Tab |
|---|---------------|--------|
| ED11C001C (1-25) to ED11C160C (3976-4000) | 1-4000 | SIDE |
| ED11AZ | A-Z | SIDE |
| ED11AAZZ | AA-ZZ | SIDE |
| ED11E1C (1-25) to ED11E4C (76-100) | Exhibit 1-100 | SIDE |
| ED11EAZ | Exhibit A-Z | SIDE |
| ED11EAAZZ | Exhibit AA-ZZ | SIDE |
| ED11ROMI-X | I-X | SIDE |
| ED11ROMI-XX | I-XX | SIDE |
| ED11MED* | Medical* | SIDE |
| ED11JANDEC | Jan-Dec | SIDE |
| ED11B1C (1-25) & ED11B2C (26-50) | 1-50 | BOTTOM |
| ED11BAZ | A-Z | BOTTOM |
| ED11BE1C (1-24) & ED11BE2C (25-48) | Exhibit 1-48 | BOTTOM |
| ED11BEAZ | Exhibit A-Z | BOTTOM |
| ED11BEAAZZ | Exhibit AA-ZZ | BOTTOM |

14" LEGAL SIZE

| | | |
|---|-------|------|
| ED14C001C (1-25) to ED14C010C (226-250) | 1-250 | SIDE |
| ED14AZ | A-Z | SIDE |

Legal size not pictured for sets or packages.

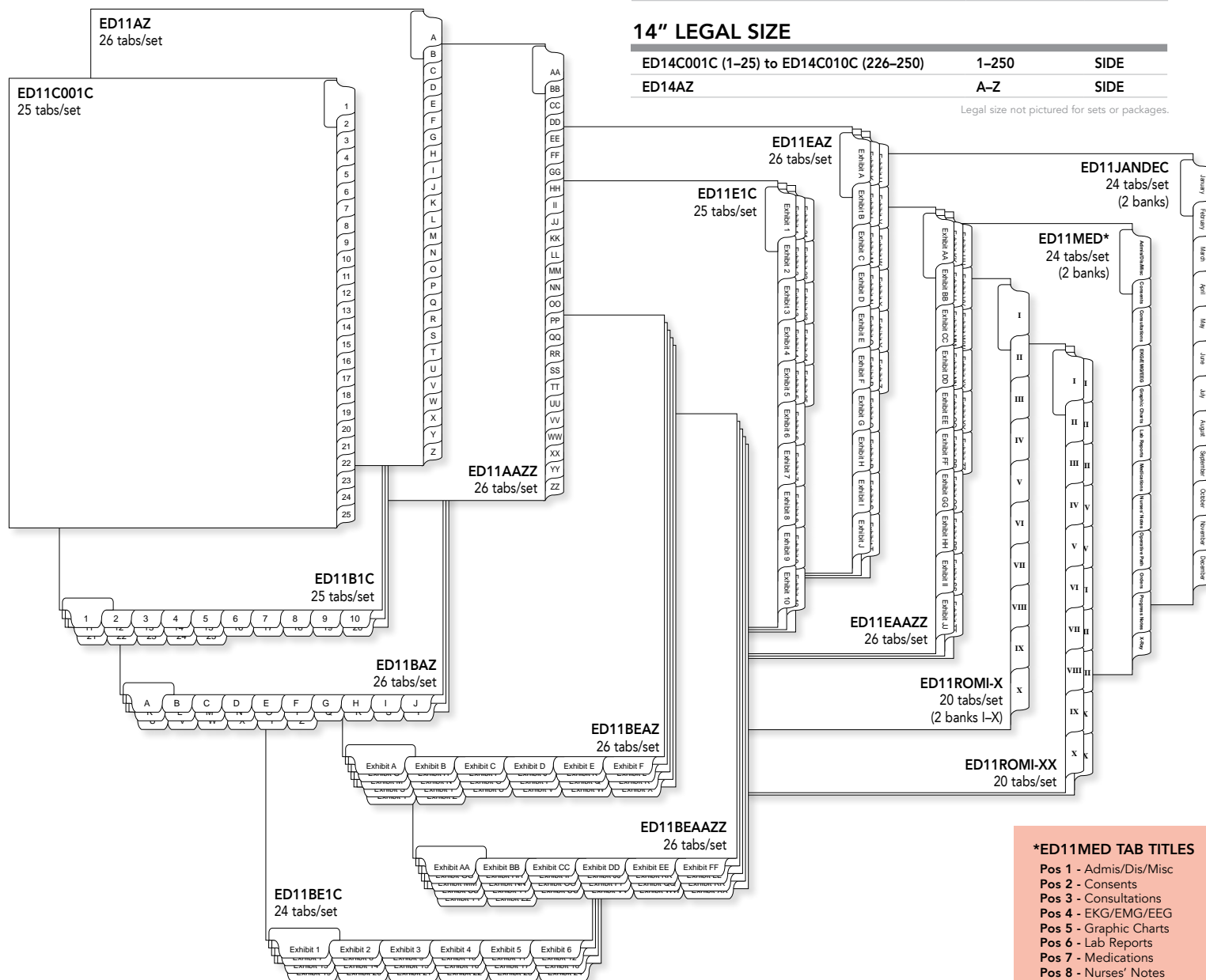

- *ED11MED TAB TITLES**
- Pos 1 - Admis/Dis/Misc
 - Pos 2 - Consents
 - Pos 3 - Consultations
 - Pos 4 - EKG/EMG/EEG
 - Pos 5 - Graphic Charts
 - Pos 6 - Lab Reports
 - Pos 7 - Medications
 - Pos 8 - Nurses' Notes
 - Pos 9 - Operative Path
 - Pos 10 - Orders
 - Pos 11 - Progress Notes
 - Pos 12 - X-Ray

Individual Packages

11" LETTER SIZE (25 sheets/pkg)

| Item # | Title | Tab |
|------------------------|-------------------|--------|
| ED11S001 to ED11S250 | 1-250 | SIDE |
| ED11SA to ED11SZ | A-Z | SIDE |
| ED11E001 to ED11E050 | Exhibit 1-50 | SIDE |
| ED11EA to ED11EZ | Exhibit A-Z | SIDE |
| ED11INDEX | Index | SIDE |
| ED11TOC | Table of Contents | SIDE |
| ED11BE001 to ED11BE050 | Exhibit 1-50 | BOTTOM |
| ED11BEA to ED11BEZ | Exhibit A-Z | BOTTOM |

14" LEGAL SIZE (25 sheets/pkg)

| | | |
|----------------------|-------------------|------|
| ED14S001 to ED14S050 | 1-50 | SIDE |
| ED14SA to ED14SZ | A-Z | SIDE |
| ED14INDEX | Index | SIDE |
| ED14TOC | Table of Contents | SIDE |

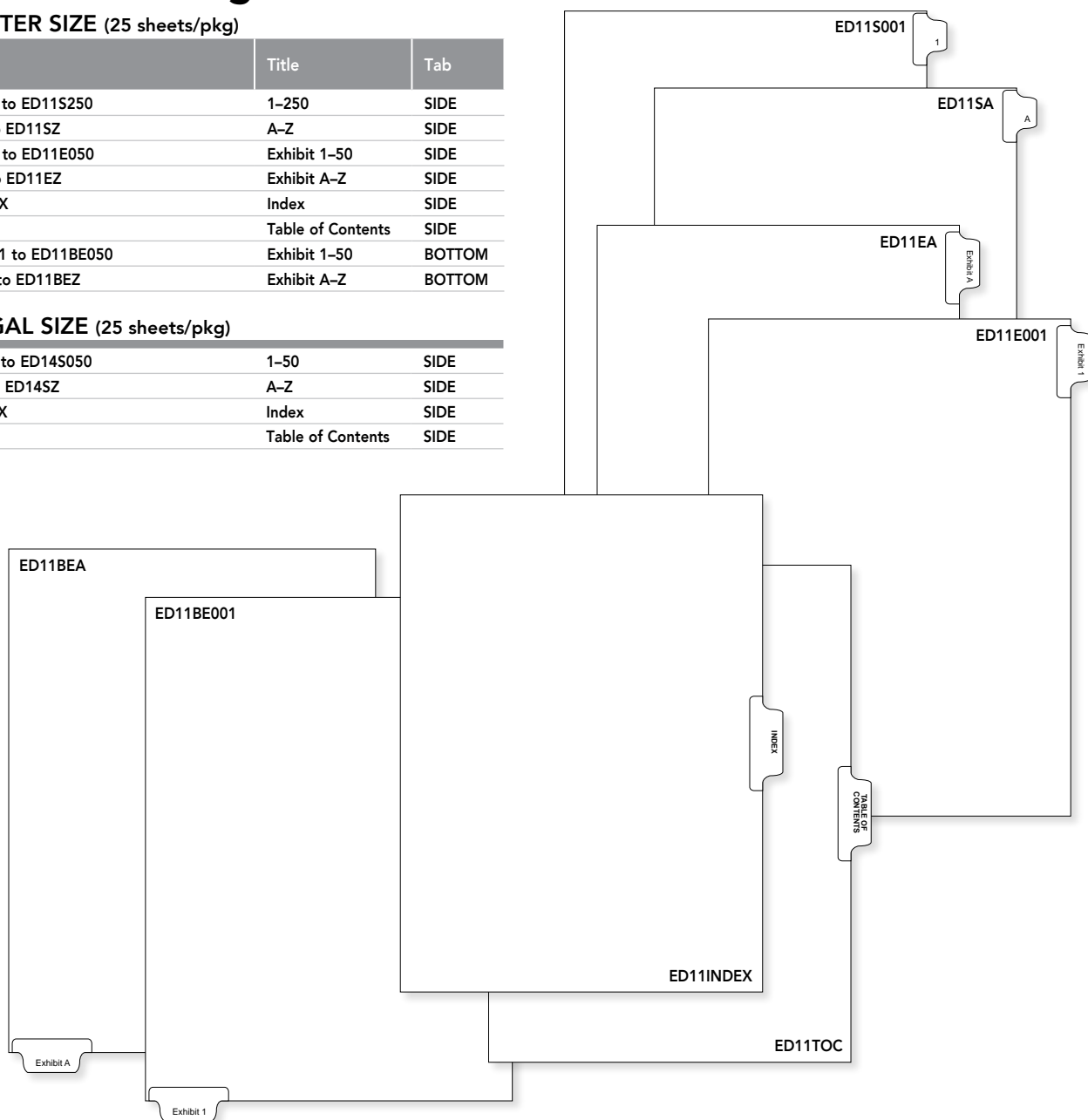

EXPANDABLE FILE POCKETS

Pair your indexes with our durable line of Expandable File Pockets, and you'll never lose a file again! (pages 25-27)



- Sold as individual packages or collated sets
- Printed on 80lb White FSC® stock
- Clear mylar laminated tabs
- Printed on both sides, Tumbler style

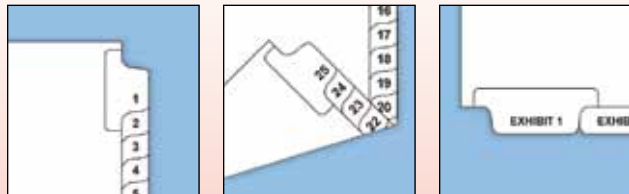

- Typeface is bold
- Tabs printed Tumbler style
- Bottom exhibit tabs are 5 tabs/bank
• "EXHIBIT" is all upper case

Additional titles available.

Collated Sets

11" LETTER SIZE

| Item # | Title | Tab |
|--|--------------|--------|
| SP11-1-5 | 1-5 | SIDE |
| SP11-1-10 | 1-10 | SIDE |
| SP11C001C (1-25) to SP11C400C (9976-10000) | 1-10000 | SIDE |
| SP11AZ | A-Z | SIDE |
| SP11AAZZ | AA-ZZ | SIDE |
| SP11AAZZZ | AAA-ZZZ | SIDE |
| SP11E1C (1-25) to SP11E2C (26-50) | Exhibit 1-50 | SIDE |
| SP11EAZ | Exhibit A-Z | SIDE |
| SP11ROMI-X | I-X | SIDE |
| SP11ROMXI-XX | XI-XX | SIDE |
| SP11JANDEC | Jan-Dec | SIDE |
| SP11BE1C (1-25) to SP11BE2C (26-50) | Exhibit 1-50 | BOTTOM |
| SP11BEAZ | Exhibit A-Z | BOTTOM |

14" LEGAL SIZE

| | | |
|---|-------|------|
| SP14C001C to (1-25) SP14C020C (476-500) | 1-500 | SIDE |
| SP14AZ | A-Z | SIDE |

Legal size not pictured for sets or packages.

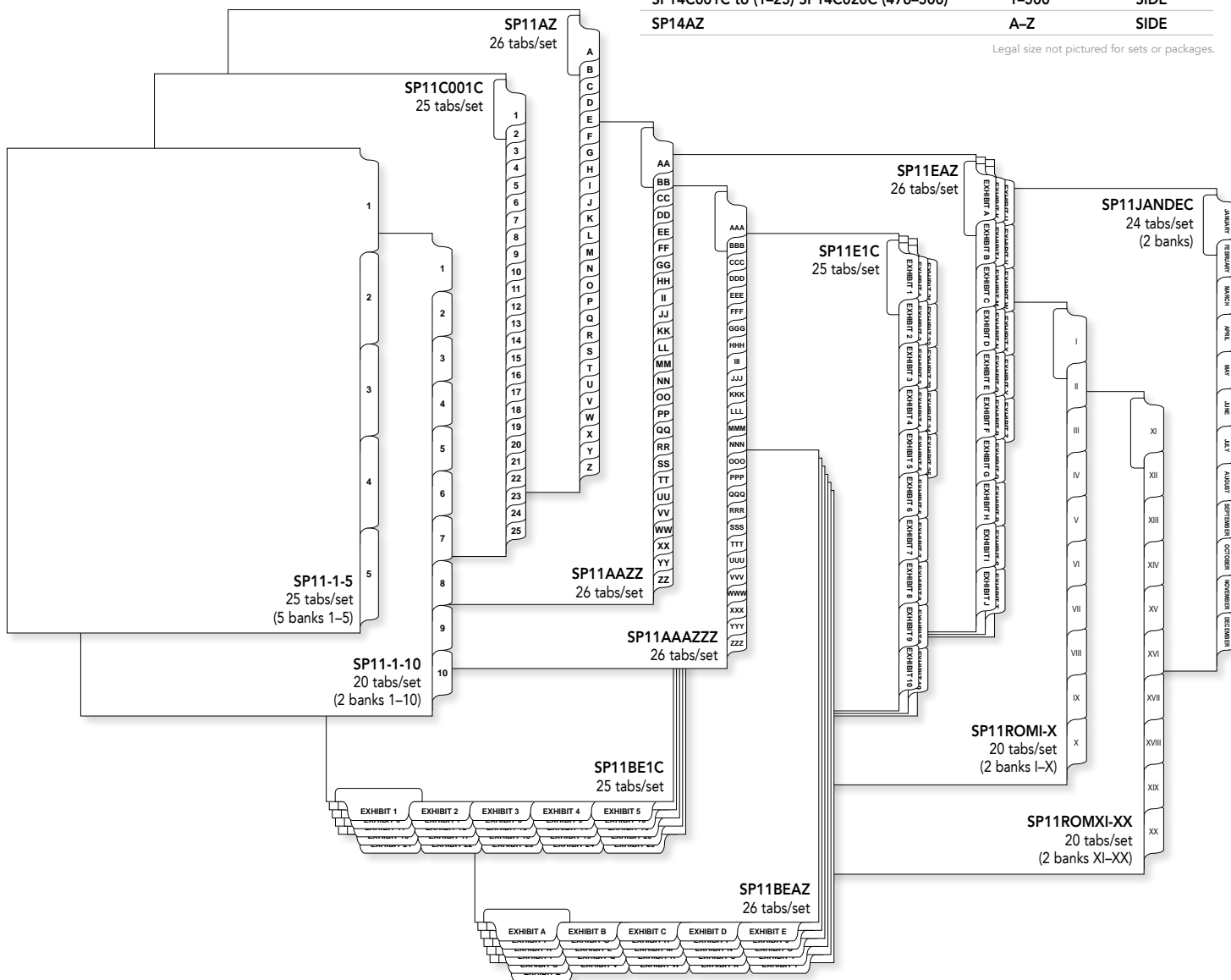

Individual Packages

11" LETTER SIZE (25 sheets/pkg)

| Item # | Title | Tab |
|------------------------|-------------------|--------|
| SP11S001 to SP11S500 | 1-500 | SIDE |
| SP11SA to SP11SZ | A-Z | SIDE |
| SP11SAA to SP11SZZ | AA-ZZ | SIDE |
| SP11E001 to SP11E100 | Exhibit 1-100 | SIDE |
| SP11EA to SP11EZ | Exhibit A-Z | SIDE |
| SP11ROMI to SP11ROMX | I-X | SIDE |
| SP11INDEX | Index | SIDE |
| SP11TOC | Table of Contents | SIDE |
| SP11APPN | Appendix | SIDE |
| SP11B001 to SP11B100 | 1-100 | BOTTOM |
| SP11BA to SP11BZ | A-Z | BOTTOM |
| SP11BE001 to SP11BE100 | Exhibit 1-100 | BOTTOM |
| SP11BEA to SP11BEZ | Exhibit A-Z | BOTTOM |
| SP11BINDEX | Index | BOTTOM |
| SP11BTOC | Table of Contents | BOTTOM |

14" LEGAL SIZE (25 sheets/pkg)

| | | |
|----------------------|-------------------|------|
| SP14S001 to SP14S100 | 1-100 | SIDE |
| SP14SA to SP14SZ | A-Z | SIDE |
| SP14INDEX | Index | SIDE |
| SP14TOC | Table of Contents | SIDE |

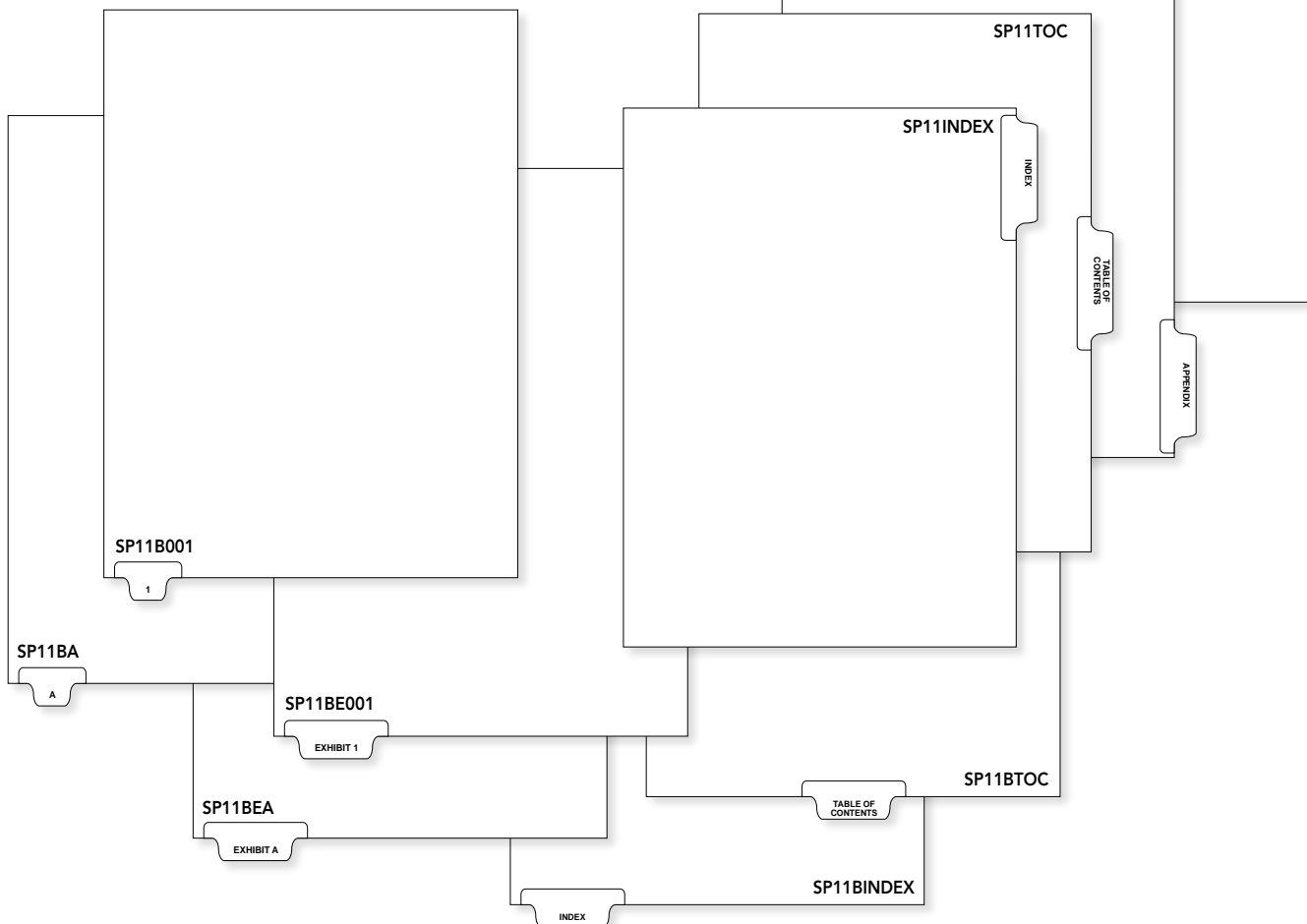
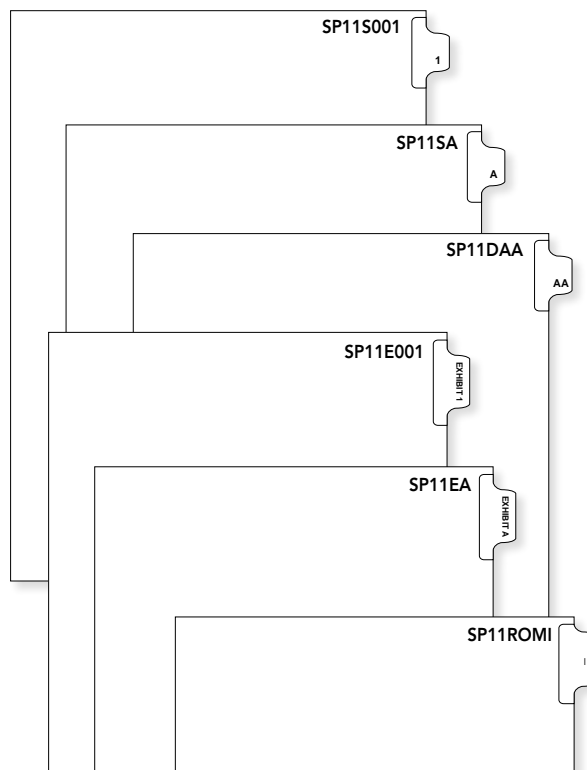

- Sold as individual packages or collated sets
- Printed on 80lb White
- Clear mylar laminated tabs
- Printed on both sides, Write Reading

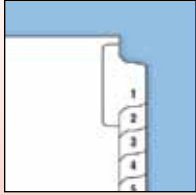

- Typeface is bold condensed

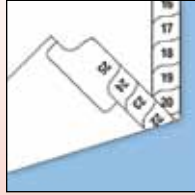

- Tabs printed Write Reading

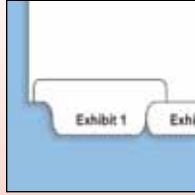

- Bottom exhibit tabs are 6 tabs/bank
- "Exhibit" is both upper and lower case

Collated Sets

11" LETTER SIZE

| Item # | Title | Tab |
|---|-------------|--------|
| BP11C001C (1-25) to BP11C020C (476-500) | 1-500 | SIDE |
| BP11AZ | A-Z | SIDE |
| BP11BEAZ | Exhibit A-Z | BOTTOM |

Individual Packages

11" LETTER SIZE (25 sheets/pkg)

| Item # | Title | Tab |
|------------------------|--------------|--------|
| BP11S001 to BP11S100 | 1-100 | SIDE |
| BP11SA to BP11SZ | A-Z | SIDE |
| BP11E001 to BP11E025 | Exhibit 1-25 | SIDE |
| BP11EA to BP11EZ | Exhibit A-Z | SIDE |
| BP11BE001 to BP11BE025 | Exhibit 1-25 | BOTTOM |
| BP11BEA to BP11BEZ | Exhibit A-Z | BOTTOM |

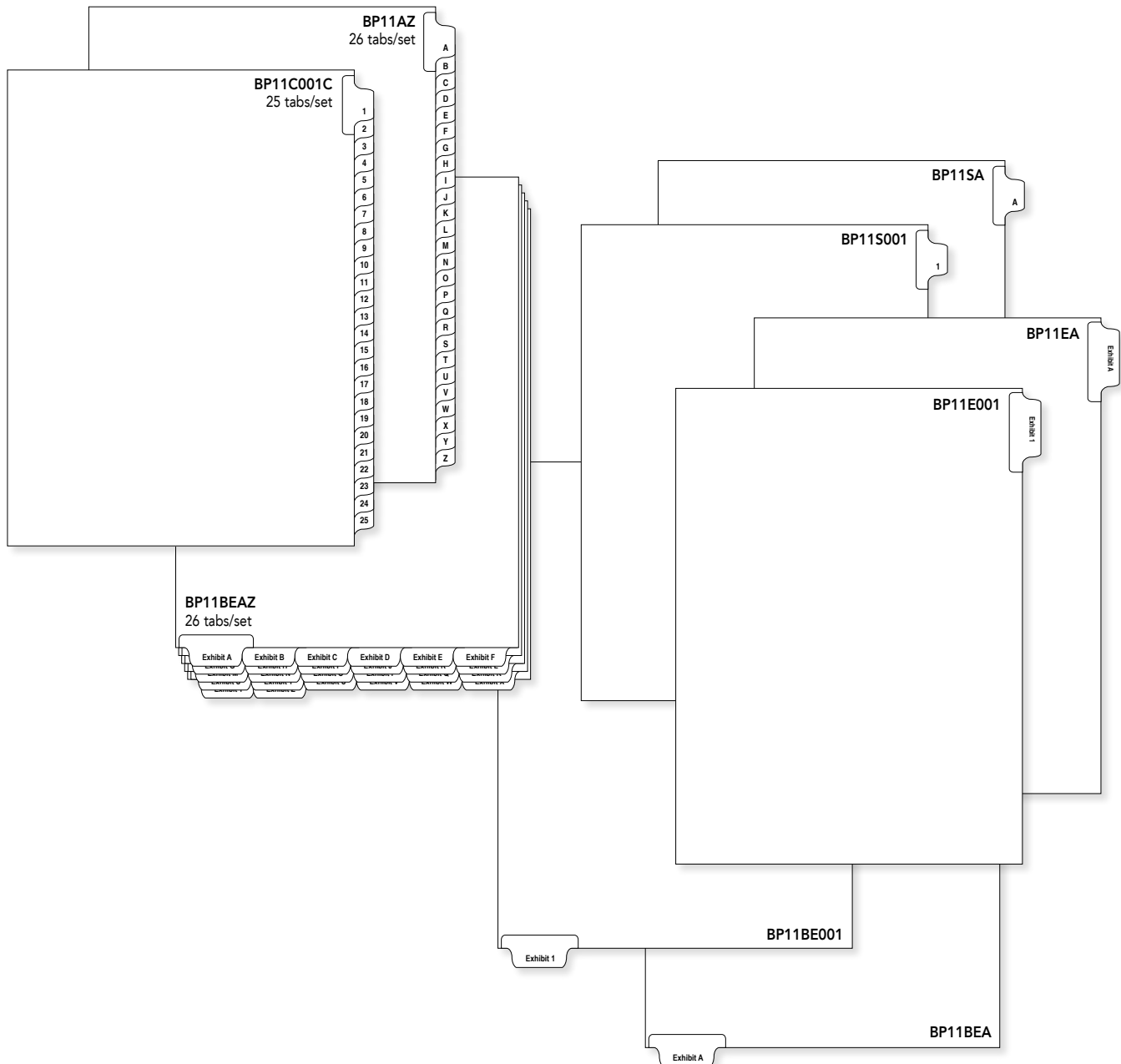

All-State® Compatible

All-State® compatible blank indexes are made from 80 lb FSC® stock, with writeable/eraseable tabs for easy customization. Label sheets are included as an alternate option to writing on the tabs.

11" LETTER SIZE

| Item # | Tab Cut | Tabs per Set | Tab |
|------------|---------|--------------|--------|
| ED11BLW07 | 1/7 | 28 (4 banks) | SIDE |
| ED11BBLW06 | 1/6 | 24 (4 banks) | BOTTOM |

14" LEGAL SIZE

| | | | |
|------------|-----|--------------|--------|
| ED14BLW09 | 1/9 | 27 (3 banks) | SIDE |
| ED14BBLW06 | 1/6 | 24 (4 banks) | BOTTOM |

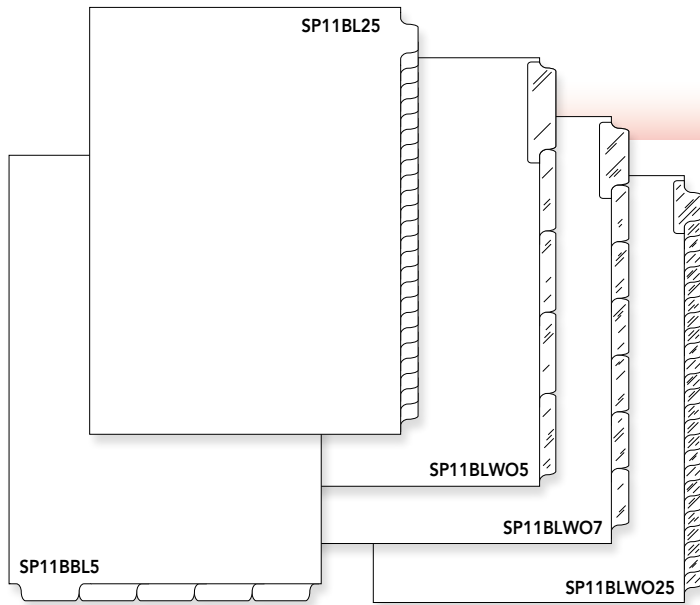
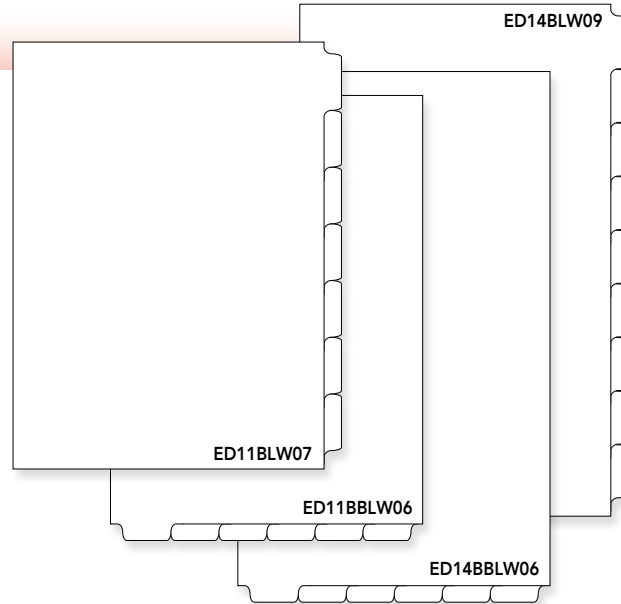

Avery® Compatible

Avery® compatible blank indexes are as standard tabs and with writeable mylar in 80 lb FSC® stock.

11" LETTER SIZE: STANDARD

| Item # | Tab Cut | Tabs per Set | Tab |
|----------|---------|--------------|--------|
| SP11BL25 | 1/25 | 25 (1 bank) | SIDE |
| SP11BBL5 | 1/5 | 25 (5 banks) | BOTTOM |

11" LETTER SIZE: WRITEABLE MYLAR

| | | | |
|------------|------|--------------|------|
| SP11BLW05 | 1/5 | 25 (5 banks) | SIDE |
| SP11BLW07 | 1/7 | 21 (3 banks) | SIDE |
| SP11BLW025 | 1/25 | 25 (1 bank) | SIDE |

Blumberg® Exhibit Compatible

Blumberg® compatible blank tabs are 80 lb stock, with either blank spaces or lines to write in exhibit information.

11" LETTER SIZE

| Item # | Tab Cut | Tabs per Set | Tab |
|----------|---------|--------------|--------|
| BP11BL8 | 1/8 | 24 (3 banks) | SIDE |
| BP11BBL6 | 1/6 | 24 (4 banks) | BOTTOM |
| BP11BE_6 | 1/6 | 24 (4 banks) | BOTTOM |

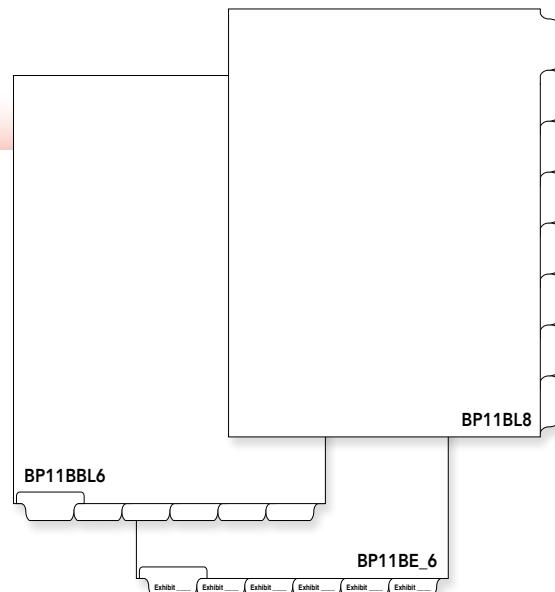

NEVER-JAM™

COPIER TABS

BLANK COPIER TABS



Never-Jam™ Copier Tabs are the solution to your immediate in-house index needs. Simply run them through your high-speed copy machine, and you'll have quality custom indexes in a matter of minutes. Available in multiple weights, collated or individual packages, and optional toner-receptive mylar – choose from our stock selection or request a custom size!

90# White

COLLATED (1250/ctn)

| Item # | Description |
|-----------|--|
| CT905ST | 1/5 Cut, Straight Collated |
| CT905ST-P | 1/5 Cut, Straight Collated, 3-Hole-Punched |
| CT905SR | 1/5 Cut, Reverse Collated |
| CT905SR-P | 1/5 Cut, Reverse Collated, 3-Hole-Punched |

INDIVIDUAL (1250/ctn)

| | |
|-----------------|--|
| CT905SP-1 OR 5 | 1/5 Cut, Position 1 or 5 |
| CT905SP-1 OR 5P | 1/5 Cut, Position 1 or 5, 3-Hole-Punched |
| CT905SP-2 OR 4 | 1/5 Cut, Position 2 or 4 |
| CT905SP-2 OR 4P | 1/5 Cut, Position 2 or 4, 3-Hole-Punched |
| CT905SP-3 | 1/5 Cut, Position 3 |
| CT905SP-3-P | 1/5 Cut, Position 3, 3-Hole-Punched |
| CT905SPM1-5 | 1/5 Cut, Mixed Positions (250/ea) |
| CT905SPM1-5-P | 1/5 Cut, Mixed Positions (250/ea), 3-H-P |

110# White

COLLATED (1000/ctn)

| Item # | Description |
|------------|--|
| CT1105ST | 1/5 Cut, Straight Collated |
| CT1105ST-P | 1/5 Cut, Straight Collated, 3-Hole-Punched |
| CT1105SR | 1/5 Cut, Reverse Collated |
| CT1105SR-P | 1/5 Cut, Reverse Collated, 3-Hole-Punched |

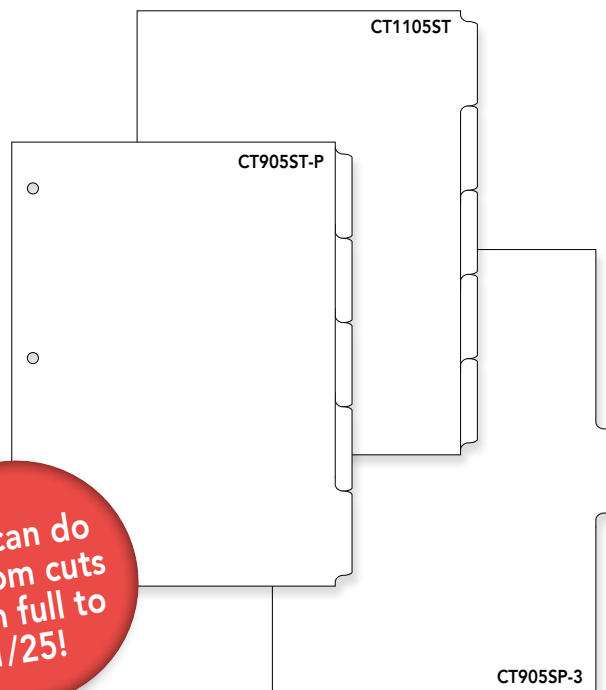

We can do custom cuts from full to 1/25!

90# White with Printable Mylar

COLLATED (1250/ctn)

| Item # | Description |
|------------|---|
| CTX905ST | 1/5 Cut w/ Mylar, Straight Collated |
| CTX905SR | 1/5 Cut w/ Mylar, Reverse Collated |
| CTX905SR-P | 1/5 Cut w/ Mylar, Reverse Collated, 3-H-P |
| CTX9010SR | 1/10 Cut w/ Mylar, Reverse Collated |

INDIVIDUAL (1250/ctn)

| | |
|-----------------|--|
| CTX905SP-1 OR 5 | 1/5 Cut w/ Mylar, Position 1 or 5 |
| CTX905SP-2 OR 4 | 1/5 Cut w/ Mylar, Position 2 or 4 |
| CTX905SP-3 | 1/5 Cut w/ Mylar, Position 3 |
| CTX905SPM1-5 | 1/5 Cut w/ Mylar, Mixed Positions (250/ea) |

COLORED - COLLATED (1250/ctn)

| | |
|--------------|---|
| CTX905SRMC | 1/5 Cut w/ Color, Reverse Collated |
| CTX905SRMC-P | 1/5 Cut w/ Color, Reverse Collated, 3-H-P |

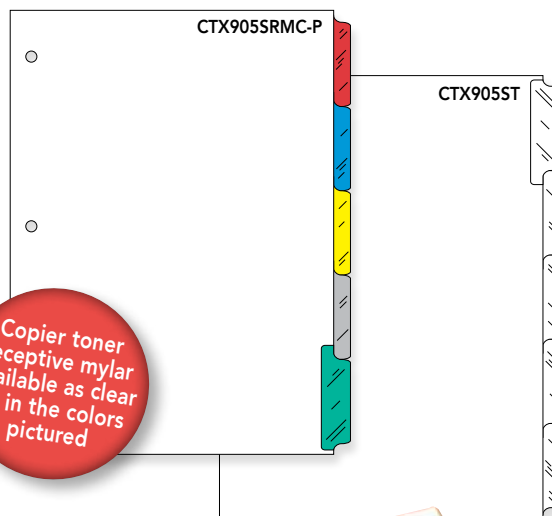

We package our copier tabs in crush-resistant cartons, and each inner box is shrink-wrapped to protect from moisture. This is how we ensure that the tabs will arrive without problems that can cause paper jams.



Patent and Trademark Folders

Three stock Patent and Trademark Application folders to choose from, or customize your own! (page 28)

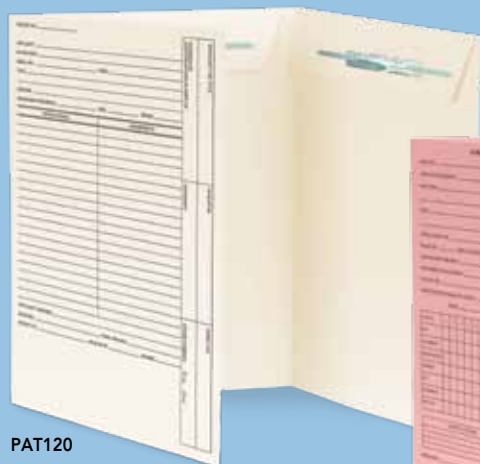

PAT120

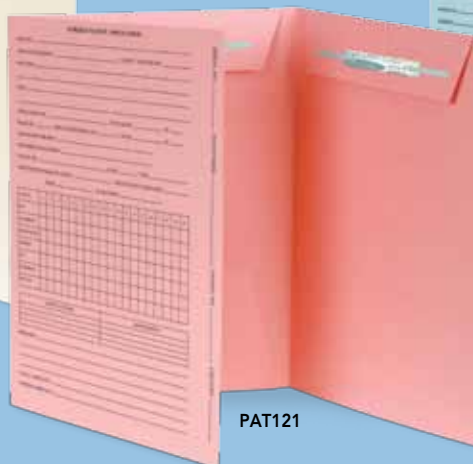

PAT121

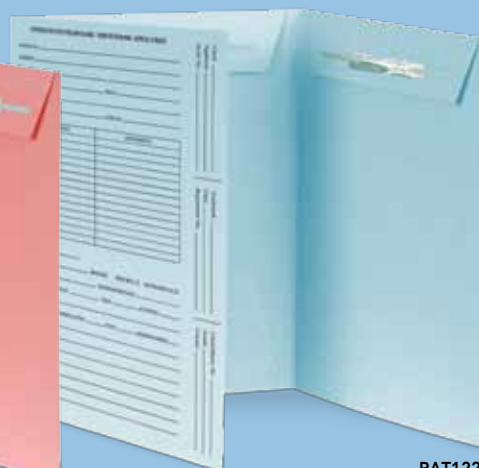

PAT122

Labels



Color Code Filing

Applying labels to the file folder tab to color code your filing systems adds a number of benefits and efficiencies to your filing system. Two of the more prominent benefits are referencing and locating file folders within the system and, perhaps the most cost saving benefit, is locating misfiles within a filing system. Using color coding in your filing system can speed up referencing and spotting costly misfiles by as much as 70 percent.

The four most commonly-used methods of color coding are as follows:

Alphabetical - The use of alpha labels to designate a file by patient, client or customer name. By using the first few characters of a name, there is little to no need for a cross reference system to access active files. The amount of alpha letters needed to color code a single file is determined by the size of the overall filing system, frequency of common names, etc.

Straight Numeric - The use of numeric labels to designate a file by customer number, date, social security number, etc... Use of numeric labels usually requires some level of cross reference and is very simple in nature. The most recent file (new customer, patient, etc.) is usually found at the end of a straight numeric filing system.

Alpha/Numeric - The use of a combination of alpha and numeric labels to create a filing system. The use of both alpha and numeric labels are used to create a specific file for customer files, court files, service records, property management files, etc.

Terminal Digit - The use of numeric labels for large volume filing systems. This unique systems breaks large filing systems up in groups of 100 or 1000 files, depending on the overall size of the filing system. This type of system places the initial emphasis on the ending digits of the file number to speed referencing, thus the name "Terminal Digit". You are basically creating smaller systems, or groups, within the entire filing system.

Other labels such as Year, Month, Solid (designator) labels can be used to further departmentalize or detail the information located on the tabs of files within your filing system.

PMA® Compatible

3900 Series

1" H x 1-1/2" W (Polylaminated)



Pack 3900A
Ringbook 3930A
Roll 3960A



Pack 3901B
Ringbook 3931B
Roll 3961B



Pack 3902C
Ringbook 3932C
Roll 3962C



Pack 3903D
Ringbook 3933D
Roll 3963D



Pack 3904E
Ringbook 3934E
Roll 3964E



Pack 3905F
Ringbook 3935F
Roll 3965F



Pack 3906G
Ringbook 3936G
Roll 3966G



Pack 3907H
Ringbook 3937H
Roll 3967H

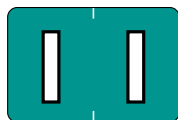

Pack 3908I
Ringbook 3938I
Roll 3968I



Pack 3909J
Ringbook 3939J
Roll 3969J



Pack 3910K
Ringbook 3940K
Roll 3970K



Pack 3911L
Ringbook 3941L
Roll 3971L



Pack 3912M
Ringbook 3942M
Roll 3972M



Pack 3913N
Ringbook 3943N
Roll 3973N

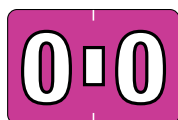

Pack 3914O
Ringbook 3944O
Roll 3974O



Pack 3915P
Ringbook 3945P
Roll 3975P

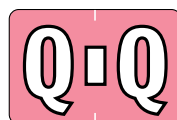

Pack 3916Q
Ringbook 3946Q
Roll 3976Q



Pack 3917R
Ringbook 3947R
Roll 3977R



Pack 3918S
Ringbook 3948S
Roll 3978S



Pack 3919T
Ringbook 3949T
Roll 3979T



Pack 3920U
Ringbook 3950U
Roll 3980U



Pack 3921V
Ringbook 3951V
Roll 3981V



Pack 3922W
Ringbook 3952W
Roll 3982W



Pack 3923X
Ringbook 3953X
Roll 3983X



Pack 3924Y
Ringbook 3954Y
Roll 3984Y



Pack 3925Z
Ringbook 3955Z
Roll 3985Z



Pack 3926Mc
Ringbook 3956Mc
Roll 3986Mc

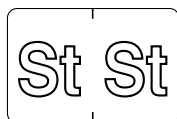

Pack 3926St
Ringbook 3956St
Roll 3986St

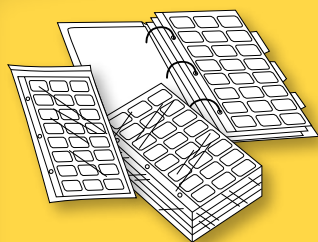

RINGBOOK (24 labels/sheet)
Binder only for starter kit - Item # MBINDER
Index set for starter kit - Item # MINDEX

Individual Letters
(see label number) 240 labels

Complete Set 3959SET
28 packs, 6,720 labels

Starter Kit 3957SK
Binder, indexes, 3,144 assorted labels

Refill Kit 3958RK
3,144 assorted labels

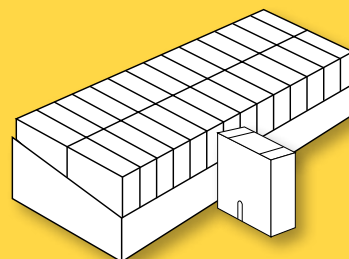

ROLL (500 labels/roll)
Tray only for set - Item # W-28

Individual Letters
(see label number) 500 labels

Complete Set 3989SET
28 rolls, display unit, 14,000 labels

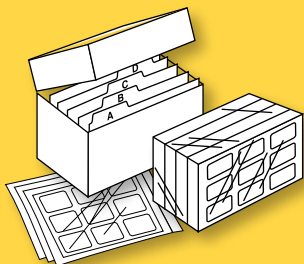

PACK (9 labels/sheet)
Kit box only for starter kit - Item # BBOX
Index set for starter kit - Item # BINDEX

Individual Letters
(see label number) 225 labels

Complete Set 3929SET
28 packs, 6,300 labels

Starter Kit 3927SK
File box, indexes, 2,016 assorted labels

Refill Kit 3928RK
2,016 assorted labels



Alphabetic Color Coded Labels

Ames® L178 Compatible

10500 Series

1-7/8" H x 1-7/8" W (Semi-Gloss)



| | | | | | | | | | |
|---------------------------|---------------------------|---------------------------|---------------------------|---------------------------|---------------------------|--|---------------------------|---------------------------|---------------------------|
| A A Roll 10560A | B B Roll 10561B | C C Roll 10562C | D D Roll 10563D | E E Roll 10564E | F F Roll 10565F | G G Roll 10566G | H H Roll 10567H | I I Roll 10568I | J J Roll 10569J |
| K K Roll 10570K | L L Roll 10571L | M M Roll 10572M | N N Roll 10573N | O O Roll 10574O | P P Roll 10575P | Q Q Roll 10576Q | R R Roll 10577R | S S Roll 10578S | T T Roll 10579T |
| U U Roll 10580U | V V Roll 10581V | W W Roll 10582W | X X Roll 10583X | Y Y Roll 10584Y | Z Z Roll 10585Z | <p>ROLL (500 labels/roll) Individual Letters (see label number) 500 labels Complete Set 10589SET 26 rolls, 13,000 labels</p> | | | |

Barkley® ABAM Compatible

10300 Series & ABAM Series

1/2" H x 1-1/2" W (Polylaminated)



| | | |
|---------------------------|---------------------------|------------------------------|
| A A Roll 10360A | B B Roll 10361B | C C Roll 10362C |
| D D Roll 10363D | E E Roll 10364E | F F Roll 10365F |
| G G Roll 10366G | H H Roll 10367H | I I Roll 10368I |
| J J Roll 10369J | K K Roll 10370K | L L Roll 10371L |
| M M Roll 10372M | N-N Roll 10373N | O-O Roll 10374O |
| P-P Roll 10375P | Q-Q Roll 10376Q | R-R Roll 10377R |
| S-S Roll 10378S | T-T Roll 10379T | U-U Roll 10380U |
| V-V Roll 10381V | W-W Roll 10382W | X-X Roll 10383X |
| Y-Y Roll 10384Y | Z-Z Roll 10385Z | Mc Mc Roll 10386Mc |

ROLL (500 labels/roll)
Tray only for set - Item # W-28

Individual Letters (see label number) 500 labels
Complete Set 10389SET
27 rolls, display unit, 13,500 labels

Barkley® ABYM Compatible

10600 Series

3/4" H x 1-1/2" W (Polylaminated)



| | | | |
|-------------------------------|-------------------------------|----------------------------------|-------------------------------|
| A A Ringbook 10630A | B B Ringbook 10631B | C C Ringbook 10632C | D D Ringbook 10633D |
| E E Ringbook 10634E | F F Ringbook 10635F | G G Ringbook 10636G | H H Ringbook 10637H |
| I I Ringbook 10638I | J J Ringbook 10639J | K K Ringbook 10640K | L L Ringbook 10641L |
| M M Ringbook 10642M | N-N Ringbook 10643N | O-O Ringbook 10644O | P-P Ringbook 10645P |
| Q-Q Ringbook 10646Q | R-R Ringbook 10647R | S-S Ringbook 10648S | T-T Ringbook 10649T |
| U-U Ringbook 10650U | V-V Ringbook 10651V | W-W Ringbook 10652W | X-X Ringbook 10653X |
| Y-Y Ringbook 10654Y | Z-Z Ringbook 10655Z | Mc Mc Ringbook 10656Mc | |

RINGBOOK (27 labels/sheet)
Binder only for starter kit - Item # MBINDER
Index set for starter kit - Item # MINDEX

Individual Letters (see label number) 270 labels

Complete Set 10659SET
27 packs, 7,290 labels

Starter Kit 10657SK

Binder, indexes, 3,510 assorted labels

Refill Kit 10658RK

3,510 assorted labels

Barkley® ABKM & Sycom® Compatible

2400 Series ABKM Series
1" H x 1-1/2" W (Polylaminated)



MAP-Pack 24M06G
Pack 2406G
Roll 2466G



MAP-Pack 24M07H
Pack 2407H
Roll 2467H

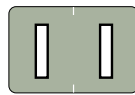

MAP-Pack 24M08I
Pack 2408I
Roll 2468I

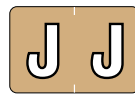

MAP-Pack 24M09J
Pack 2409J
Roll 2469J



MAP-Pack 24M10K
Pack 2410K
Roll 2470K



MAP-Pack 24M11L
Pack 2411L
Roll 2471L



MAP-Pack 24M12M
Pack 2412M
Roll 2472M



MAP-Pack 24M13N
Pack 2413N
Roll 2473N

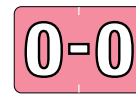

MAP-Pack 24M14O
Pack 2414O
Roll 2474O



MAP-Pack 24M15P
Pack 2415P
Roll 2475P



MAP-Pack 24M16Q
Pack 2416Q
Roll 2476Q



MAP-Pack 24M17R
Pack 2417R
Roll 2477R



MAP-Pack 24M18S
Pack 2418S
Roll 2478S

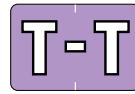

MAP-Pack 24M19T
Pack 2419T
Roll 2479T



MAP-Pack 24M20U
Pack 2420U
Roll 2480U

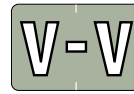

MAP-Pack 24M21V
Pack 2421V
Roll 2481V



MAP-Pack 24M22W
Pack 2422W
Roll 2482W



MAP-Pack 24M23X
Pack 2423X
Roll 2483X



MAP-Pack 24M24Y
Pack 2424Y
Roll 2484Y



MAP-Pack 24M25Z
Pack 2425Z
Roll 2485Z



MAP-Pack 24M26Mc
Pack 2426Mc
Roll 2486Mc

MAP-PACK (9 labels/sheet)

Kit box only for starter kit - Item # BBOX
Index set for starter kit - Item # BINDEX

Individual Letters

(see label number) 126 labels

Complete Set 24M29SET

27 packs, 3,402 labels

Starter Kit 24M27SK

File box, indexes, 2,025 assorted labels

Refill Kit 24M28RK

2,025 assorted labels

PACK (9 labels/sheet)

Kit box only for starter kit - Item # BBOX
Index set for starter kit - Item # BINDEX

Individual Letters

(see label number) 225 labels

Complete Set 2429SET

27 packs, 6,075 labels

Starter Kit 2427SK

File box, indexes, 2,016 assorted labels

Refill Kit 2428RK

2,016 assorted labels

ROLL (500 labels/roll)

Tray only for set - Item # W-28

Individual Letters

(see label number) 500 labels

Complete Set 2489SET

27 rolls, display unit, 13,500 labels



Barkley® Compatible

AAVPPK Series

5" H x 1-5/8" W (Laminated)



Pack
AAVPPK-A



Pack
AAVPPK-B



Pack
AAVPPK-C



Pack
AAVPPK-D



Pack
AAVPPK-E



Pack
AAVPPK-F

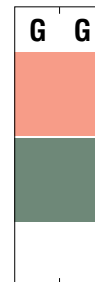

Pack
AAVPPK-G

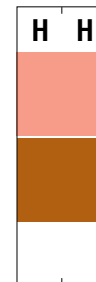

Pack
AAVPPK-H



Pack
AAVPPK-I

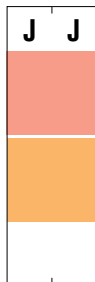

Pack
AAVPPK-J



Pack
AAVPPK-K



Pack
AAVPPK-L



Pack
AAVPPK-M



Pack
AAVPPK-N



Pack
AAVPPK-O

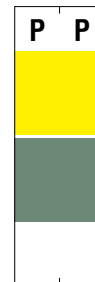

Pack
AAVPPK-P



Pack
AAVPPK-Q



Pack
AAVPPK-R



Pack
AAVPPK-S



Pack
AAVPPK-T



Pack
AAVPPK-U



Pack
AAVPPK-V



Pack
AAVPPK-W



Pack
AAVPPK-XYZ



Pack
AAVPPK-MC

PACK (100 labels/pack)

Individual Letters

(see label number) 100 labels

Complete Set AAVPPK-ST

24 packs, 2,400 labels, MC not included

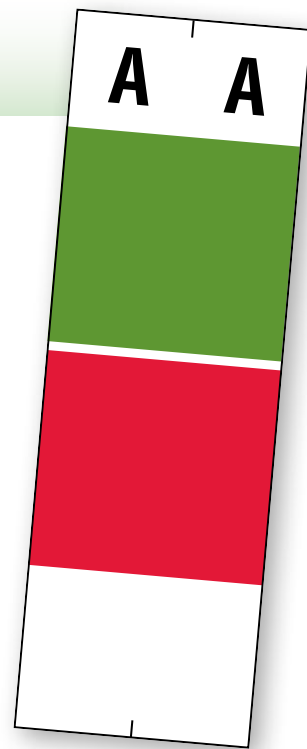

Alphabetic Color Coded Labels

Colwell Jewel Tone Compatible

▶ 8600 Series
1" H x 1-1/2" W (Polylaminated)



Control-O-Fax® 96-00-000 Compatible

▶ 2300 Series
15/16" H x 1-5/8" W (Vinyl)

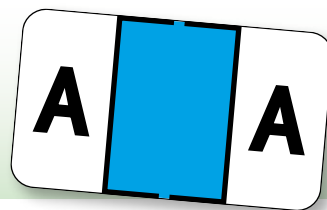

Pack 8600A
Ringbook 8630A
Roll 8660A
MAP-Pack 86M00A



Pack 8601B
Ringbook 8631B
Roll 8661B
MAP-Pack 86M01B



Pack 8602C
Ringbook 8632C
Roll 8662C
MAP-Pack 86M02C



Pack 8603D
Ringbook 8633D
Roll 8663D
MAP-Pack 86M03D



Pack 8604E
Ringbook 8634E
Roll 8664E
MAP-Pack 86M04E



Pack 8605F
Ringbook 8635F
Roll 8665F
MAP-Pack 86M05F



Pack 8606G
Ringbook 8636G
Roll 8666G
MAP-Pack 86M06G



Pack 8607H
Ringbook 8637H
Roll 8667H
MAP-Pack 86M07H



Pack 8608I
Ringbook 8638I
Roll 8668I
MAP-Pack 86M08I



Pack 8609J
Ringbook 8639J
Roll 8669J
MAP-Pack 86M09J



Pack 8610K
Ringbook 8640K
Roll 8670K
MAP-Pack 86M10K



Pack 8611L
Ringbook 8641L
Roll 8671L
MAP-Pack 86M11L



Pack 8612M
Ringbook 8642M
Roll 8672M
MAP-Pack 86M12M



Pack 8613N
Ringbook 8643N
Roll 8673N
MAP-Pack 86M13N



Pack 8614O
Ringbook 8644O
Roll 8674O
MAP-Pack 86M14O



Pack 8615P
Ringbook 8645P
Roll 8675P
MAP-Pack 86M15P

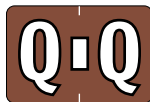

Pack 8616Q
Ringbook 8646Q
Roll 8676Q
MAP-Pack 86M16Q



Pack 8617R
Ringbook 8647R
Roll 8677R
MAP-Pack 86M17R



Pack 8618S
Ringbook 8648S
Roll 8678S
MAP-Pack 86M18S



Pack 8619T
Ringbook 8649T
Roll 8679T
MAP-Pack 86M19T



Pack 8620U
Ringbook 8650U
Roll 8680U
MAP-Pack 86M20U



Pack 8621V
Ringbook 8651V
Roll 8681V
MAP-Pack 86M21V



Pack 8622W
Ringbook 8652W
Roll 8682W
MAP-Pack 86M22W



Pack 8623X
Ringbook 8653X
Roll 8683X
MAP-Pack 86M23X



Pack 8624Y
Ringbook 8654Y
Roll 8684Y
MAP-Pack 86M24Y



Pack 8625Z
Ringbook 8655Z
Roll 8685Z
MAP-Pack 86M25Z



Pack 8626Mc
Ringbook 8656Mc
Roll 8686Mc
MAP-Pack 86M26Mc



Rngbk 2330A



Rngbk 2331B



Rngbk 2332C



Rngbk 2333D



Rngbk 2334E



Rngbk 2335F



Rngbk 2336G



Rngbk 2337H



Rngbk 2338I



Rngbk 2339J



Rngbk 2340K



Rngbk 2341L



Rngbk 2342M



Rngbk 2343N



Rngbk 2344O



Rngbk 2345P



Rngbk 2346Q



Rngbk 2347R



Rngbk 2348S



Rngbk 2349T



Rngbk 2350U



Rngbk 2351V



Rngbk 2352W



Rngbk 2353X



Rngbk 2354Y



Rngbk 2355Z



Rngbk 2356Mc

MAP-PACK (9 labels/sheet)
Kit box only for starter kit - Item # BBOX
Index set for starter kit - Item # BINDEX

Individual Letters
(see label number) 126 labels

Starter Kit 86M27SK
File box, indexes, 2,025 assorted labels

PACK (9 labels/sheet)
Kit box only for starter kit - Item # BBOX
Index set for starter kit - Item # BINDEX

Individual Letters
(see label number) 225 labels

Starter Kit 8627SK
File box, indexes, 2,898 assorted labels

RINGBOOK (24 labels/sheet)
Binder only for starter kit - Item # MBINDER
Index set for starter kit - Item # MINDEX

Individual Letters
(see label number) 240 labels

Starter Kit 8657SK
Binder, indexes, 3,144 assorted labels

ROLL (500 labels/roll)
Tray only for set - Item # W-28

Individual Letters
(see label number) 500 labels

Complete Set 8689SET
27 rolls, display unit, 13,500 labels

RINGBOOK (24 labels/sheet)
Binder only for starter kit - Item # MBINDER
Index set for starter kit - Item # MINDEX

Individual Letters
(see label number) 240 labels

Complete Set 2359SET
27 packs, 6,480 labels

Starter Kit 2357SK
Binder, indexes, 3,072 assorted labels

Refill Kit 2358RK
3,072 assorted labels

Col'R'Tab® 12000/12030 Compatible

▶ 3100 Series Ⓞ 12000 Series
 1" H x 1-1/2" W (Polylaminated)



| | | | | | | |
|--------------------------|--------------------------|--------------------------|--------------------------|--------------------------|----------------------------|--------------------------|
| Pack 3100A Roll 3160A | Pack 3101B Roll 3161B | Pack 3102C Roll 3162C | Pack 3103D Roll 3163D | Pack 3104E Roll 3164E | Pack 3105F Roll 3165F | Pack 3106G Roll 3166G |
| Pack 3107H Roll 3167H | Pack 3108I Roll 3168I | Pack 3109J Roll 3169J | Pack 3110K Roll 3170K | Pack 3111L Roll 3171L | Pack 3112M Roll 3172M | Pack 3113N Roll 3173N |
| Pack 3114O Roll 3174O | Pack 3115P Roll 3175P | Pack 3116Q Roll 3176Q | Pack 3117R Roll 3177R | Pack 3118S Roll 3178S | Pack 3119T Roll 3179T | Pack 3120U Roll 3180U |
| Pack 3121V Roll 3181V | Pack 3122W Roll 3182W | Pack 3123X Roll 3183X | Pack 3124Y Roll 3184Y | Pack 3125Z Roll 3185Z | Pack 3126Mc Roll 3186Mc | |

PACK (10 labels/sheet)
 Kit box only for starter kit - Item # SDBOX20
 Index set for starter kit - Item # OINDEX

Individual Letters
 (see label number) 100 labels

Complete Set 3129SET
 27 packs, 2,700 labels

Starter Kit 3127SK
 Box, indexes, 3,200 assorted labels

Refill Kit 3128RK
 3,200 assorted labels

ROLL (500 labels/roll)
 Tray only for set - Item # D-15

Individual Letters
 (see label number) 500 labels

Complete Set 3189SET
 27 rolls, display unit, 13,500 labels

Col'R'Tab® 11950 Compatible

▶ 3700 Series
 1/2" H x 1-1/2" W
 (Polylaminated 100# Tag)



| | | | | | |
|--------------------------|--------------------------|--------------------------|--------------------------|--------------------------|--------------------------|
| Pack 3700A Roll 3760A | Pack 3701B Roll 3761B | Pack 3702C Roll 3762C | Pack 3703D Roll 3763D | Pack 3704E Roll 3764E | Pack 3705F Roll 3765F |
| Pack 3706G Roll 3766G | Pack 3707H Roll 3767H | Pack 3708I Roll 3768I | Pack 3709J Roll 3769J | Pack 3710K Roll 3770K | Pack 3711L Roll 3771L |
| Pack 3712M Roll 3772M | Pack 3713N Roll 3773N | Pack 3714O Roll 3774O | Pack 3715P Roll 3775P | Pack 3716Q Roll 3776Q | Pack 3717R Roll 3777R |
| Pack 3718S Roll 3778S | Pack 3719T Roll 3779T | Pack 3720U Roll 3780U | Pack 3721V Roll 3781V | Pack 3722W Roll 3782W | Pack 3723X Roll 3783X |
| Pack 3724Y Roll 3784Y | Pack 3725Z Roll 3785Z | | | | |

PACK (10 labels/sheet)
 Kit box only for starter kit - Item # SDBOX20
 Index set for starter kit - Item # OINDEX

Individual Letters (see label number) 100 labels

Complete Set 3729SET 26 packs, 2,600 labels

Starter Kit 3727SK Box, indexes, 3,200 assorted labels

Refill Kit 3728RK 3,200 assorted labels

ROLL (500 labels/roll)

Individual Letters (see label number) 500 labels

Complete Set 3789SET 26 rolls, 13,000 labels

Data File® Compatible

Ⓞ Data-Mini Alpha Series
 7/16" H x 1-1/4" W (Polylaminated)



| | | | | |
|---------------|---------------|-----------------|---------------|---------------|
| Roll DATA-M-A | Roll DATA-M-B | Roll DATA-M-C | Roll DATA-M-D | Roll DATA-M-E |
| Roll DATA-M-F | Roll DATA-M-G | Roll DATA-M-H | Roll DATA-M-I | Roll DATA-M-J |
| Roll DATA-M-K | Roll DATA-M-L | Roll DATA-M-M | Roll DATA-M-N | Roll DATA-M-O |
| Roll DATA-M-P | Roll DATA-M-Q | Roll DATA-M-R | Roll DATA-M-S | Roll DATA-M-T |
| Roll DATA-M-U | Roll DATA-M-V | Roll DATA-M-W | Roll DATA-M-X | Roll DATA-M-Y |
| Roll DATA-M-Z | DATA-M-MC | Roll DATA-M-MAC | | |

ROLL (500 labels/roll)
 Dispenser tray for set - Item # DT-5

Individual Letters
 (see label number) 500 labels









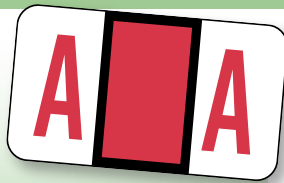



















Complete Set DATA-MA-ST
 26 rolls, 13,000 labels, MC and MAC not included

Alphabetic Color Coded Labels

Jeter® 5100 Compatible

▶ 1800 Series ◀ 5100 Series
15/16" H x 1-5/8" W (Polylaminated)



| | | | | |
|---|---|---|---|---|
|  Pack 1800A Roll 1860A |  Pack 1801B Roll 1861B |  Pack 1802C Roll 1862C |  Pack 1803D Roll 1863D |  Pack 1804E Roll 1864E |
|  Pack 1805FB Roll 1865FB |  Pack 1806G Roll 1866G |  Pack 1807H Roll 1867H |  Pack 1808I Roll 1868I |  Pack 1809J Roll 1869J |
|  Pack 1810K Roll 1870K |  Pack 1811L Roll 1871L |  Pack 1812M Roll 1872M |  Pack 1813N Roll 1873N |  Pack 1814OB Roll 1874OB |
|  Pack 1815P Roll 1875P |  Pack 1816Q Roll 1876Q |  Pack 1817R Roll 1877R |  Pack 1818S Roll 1878S |  Pack 1819T Roll 1879T |
|  Pack 1820U Roll 1880U |  Pack 1821V Roll 1881V |  Pack 1822W Roll 1882W |  Pack 1823X Roll 1883X |  Pack 1824Y Roll 1884Y |
|  Pack 1825Z Roll 1885Z |  Pack 1826Mc Roll 1886Mc | Alternate Characters | | |
|  Pack 1805FY Roll 1865FY |  Pack 1814OY Roll 1874OY | | | |

PACK (9 labels/sheet)
Kit box only for starter kit - Item # BBOX
Index set for starter kit - Item # BINDEX

Individual Letters
(see label number) 225 labels

Complete Sets 27 packs, 6,075 labels
1829SETB (Blue)
1829SETY (Yellow)

Starter Kits Box, indexes, 2,898 assorted labels
1827SKB (Blue)
1827SKY (Yellow)

Refill Kits 2,898 assorted labels
1828RKB (Blue)
1828RKY (Yellow)

ROLL (500 labels/roll)
Tray only for set - Item # W-28









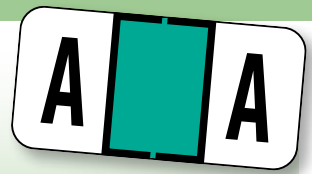

















Individual Letters
(see label number) 500 labels

Complete Sets 27 rolls, display unit, 13,500 labels
1889SETB (Blue)
1889SETY (Yellow)

Jeter® 2900 Compatible

▶ 1600 Series
3/4" H x 1-1/2" W (Polylaminated)



| | | | | |
|--|--|--|--|--|
|  Rngbk 1630A Roll 1660A |  Rngbk 1631B Roll 1661B |  Rngbk 1632C Roll 1662C |  Rngbk 1633D Roll 1663D |  Rngbk 1634E Roll 1664E |
|  Rngbk 1635F Roll 1665F |  Rngbk 1636G Roll 1666G |  Rngbk 1637H Roll 1667H |  Rngbk 1638I Roll 1668I |  Rngbk 1639J Roll 1669J |
|  Rngbk 1640K Roll 1670K |  Rngbk 1641L Roll 1671L |  Rngbk 1642M Roll 1672M |  Rngbk 1643N Roll 1673N |  Rngbk 1644O Roll 1674O |
|  Rngbk 1645P Roll 1675P |  Rngbk 1646Q Roll 1676Q |  Rngbk 1647R Roll 1677R |  Rngbk 1648S Roll 1678S |  Rngbk 1649T Roll 1679T |
|  Rngbk 1650U Roll 1680U |  Rngbk 1651V Roll 1681V |  Rngbk 1652W Roll 1682W |  Rngbk 1653X Roll 1683X |  Rngbk 1654Y Roll 1684Y |
|  Rngbk 1655Z Roll 1685Z |  Rngbk 1656Mc Roll 1686Mc | | | |

RINGBOOK (27 labels/sheet)
Binder only for starter kit - Item # MBINDER
Index set only for starter kit - Item # MINDEX

Individual Letters
(see label number) 270 labels

Complete Set 1659SET
27 packs, 7,290 labels

Starter Kit 1657SK
Binder, indexes, 3,861 assorted labels

Refill Kit 1658RK
3,510 assorted labels

ROLL (500 labels/roll)
Tray only for set - Item # W-28



























Individual Letters
(see label number) 500 labels

Complete Set 1689SET
27 rolls, display unit, 13,500 labels

Jeter® Double "J" Compatible

▶ 2200 Series ◀ 7700 Series
15/16" H x 1-5/8" W
(Polylaminated)



| | | | | | |
|--|--|---|--|--|--|
|  Rngbk 2230A Roll 2260A |  Rngbk 2231B Roll 2261B |  Rngbk 2232C Roll 2262C |  Rngbk 2233D Roll 2263D |  Rngbk 2234E Roll 2264E |  Rngbk 2235F Roll 2265F |
|  Rngbk 2236G Roll 2266G |  Rngbk 2237H Roll 2267H |  Rngbk 2238I Roll 2268I |  Rngbk 2239J Roll 2269J |  Rngbk 2240K Roll 2270K |  Rngbk 2241L Roll 2271L |
|  Rngbk 2242M Roll 2272M |  Rngbk 2243N Roll 2273N |  Rngbk 2244O Roll 2274O |  Rngbk 2245P Roll 2275P |  Rngbk 2246Q Roll 2276Q |  Rngbk 2247R Roll 2277R |
|  Rngbk 2248S Roll 2278S |  Rngbk 2249T Roll 2279T |  Rngbk 2250U Roll 2280U |  Rngbk 2251V Roll 2281V |  Rngbk 2252W Roll 2282W |  Rngbk 2253X Roll 2283X |
|  Rngbk 2254Y Roll 2284Y |  Rngbk 2255Z Roll 2285Z |  Rngbk 2256Mc Roll 2286Mc | | | |

RINGBOOK (24 labels/sheet)
Binder only for starter kit - Item # MBINDER
Index set only for starter kit - Item # MINDEX

Individual Letters
(see label number) 240 labels

Complete Set 2259SET
27 packs, 6,480 labels

Starter Kit 2257SK
Binder, indexes, 3,471 assorted labels

Refill Kit 2258RK
3,120 assorted labels

ROLL (500 labels/roll)
Tray only for set - Item # W-28

Individual Letters
(see label number) 500 labels



























Complete Set 2289SET
27 packs, display unit, 13,500 labels

Jeter® 2500 Compatible

1400 Series 2500 Series









15/16" H x 1-5/8" W (Polylaminated)

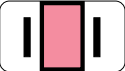

| | | | | | | | | |
|---|--|--|--|--|--|--|--|---|
|  Pack 1400A Rngbk 1430A Roll 1460A |  Pack 1401B Rngbk 1431B Roll 1461B |  Pack 1402C Rngbk 1432C Roll 1462C |  Pack 1403D Rngbk 1433D Roll 1463D |  Pack 1404E Rngbk 1434E Roll 1464E |  Pack 1405F Rngbk 1435F Roll 1465F |  Pack 1406G Rngbk 1436G Roll 1466G |  Pack 1407H Rngbk 1437H Roll 1467H |  Pack 1408I Rngbk 1438I Roll 1468I |
|  Pack 1409J Rngbk 1439J Roll 1469J |  Pack 1410K Rngbk 1440K Roll 1470K |  Pack 1411L Rngbk 1441L Roll 1471L |  Pack 1412M Rngbk 1442M Roll 1472M |  Pack 1413N Rngbk 1443N Roll 1473N |  Pack 1414O Rngbk 1444O Roll 1474O |  Pack 1415P Rngbk 1445P Roll 1475P |  Pack 1416Q Rngbk 1446Q Roll 1476Q |  Pack 1417R Rngbk 1447R Roll 1477R |
|  Pack 1418S Rngbk 1448S Roll 1478S |  Pack 1419T Rngbk 1449T Roll 1479T |  Pack 1420U Rngbk 1450U Roll 1480U |  Pack 1421V Rngbk 1451V Roll 1481V |  Pack 1422W Rngbk 1452W Roll 1482W |  Pack 1423X Rngbk 1453X Roll 1483X |  Pack 1424Y Rngbk 1454Y Roll 1484Y |  Pack 1425Z Rngbk 1455Z Roll 1485Z |  Pack 1426Mc Rngbk 1456Mc Roll 1486Mc |

Alternates

1400-200 Series 0200 Series

| | | | |
|---|--|--|--|
|  Rngbk 1432-200C Roll 1462-200C |  Rngbk 1436-200G Roll 1466-200G |  Rngbk 1438-200I Roll 1468-200I |  Rngbk 1441-200L Roll 1471-200L |
|  Rngbk 1445-200P Roll 1475-200P |  Rngbk 1449-200T Roll 1479-200T |  Rngbk 1451-200V Roll 1481-200V |  Rngbk 1454-200Y Roll 1484-200Y |

PACK (9 labels/sheet)

Kit box only for starter kit - Item # BBOX
Index set for starter kit - Item # BINDEX

Individual Letters

(see label number) 225 labels

Complete Set 1429SET

27 packs, 6,075 labels

Starter Kit 1427SK

File box, indexes, 2,898 assorted labels

Refill Kit 1428RK

2,898 assorted labels

RINGBOOK (24 labels/sheet)

Binder only for starter kit - Item # MBINDER
Index set for starter kit - Item # MINDEX

Individual Letters

(see label number) 240 labels

Complete Set 1459SET, 1459-200SET

27 packs, 6,480 labels

Starter Kit 1457SK, 1457-200SK

Binder, indexes, 3,471 assorted labels

Refill Kit 1458RK, 1458-200RK

3,120 assorted labels

ROLL (500 labels/roll)

Tray only for set - Item # W-28

Individual Letters

(see label number) 500 labels









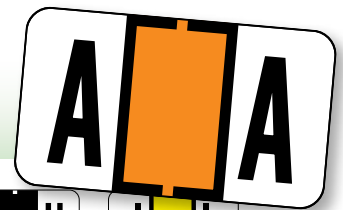

















Complete Set 1489SET, 1489-200SET

27 rolls, display unit, 13,500 labels

Jeter® 7200, 7100 & 5800 Compatible

1300 Series 7200 Series; 15/16" H x 1-5/8" W (Polylaminated)



| | | | | | | | | |
|--|---|---|---|---|---|---|---|---|
|  MAP-Pack 13M00A Pack 1300A Rngbk 1330A Roll 1360A |  MAP-Pack 13M01B Pack 1301B Rngbk 1331B Roll 1361B |  MAP-Pack 13M02C Pack 1302C Rngbk 1332C Roll 1362C |  MAP-Pack 13M03D Pack 1303D Rngbk 1333D Roll 1363D |  MAP-Pack 13M04E Pack 1304E Rngbk 1334E Roll 1364E |  MAP-Pack 13M05F Pack 1305F Rngbk 1335F Roll 1365F |  MAP-Pack 13M06G Pack 1306G Rngbk 1336G Roll 1366G |  MAP-Pack 13M07H Pack 1307H Rngbk 1337H Roll 1367H |  MAP-Pack 13M08I Pack 1308I Rngbk 1338I Roll 1368I |
|  MAP-Pack 13M09J Pack 1309J Rngbk 1339J Roll 1369J |  MAP-Pack 13M10K Pack 1310K Rngbk 1340K Roll 1370K |  MAP-Pack 13M11L Pack 1311L Rngbk 1341L Roll 1371L |  MAP-Pack 13M12M Pack 1312M Rngbk 1342M Roll 1372M |  MAP-Pack 13M13N Pack 1313N Rngbk 1343N Roll 1373N |  MAP-Pack 13M14O Pack 1314O Rngbk 1344O Roll 1374O |  MAP-Pack 13M15P Pack 1315P Rngbk 1345P Roll 1375P |  MAP-Pack 13M16Q Pack 1316Q Rngbk 1346Q Roll 1376Q |  MAP-Pack 13M17R Pack 1317R Rngbk 1347R Roll 1377R |
|  MAP-Pack 13M18S Pack 1318S Rngbk 1348S Roll 1378S |  MAP-Pack 13M19T Pack 1319T Rngbk 1349T Roll 1379T |  MAP-Pack 13M20U Pack 1320U Rngbk 1350U Roll 1380U |  MAP-Pack 13M21V Pack 1321V Rngbk 1351V Roll 1381V |  MAP-Pack 13M22W Pack 1322W Rngbk 1352W Roll 1382W |  MAP-Pack 13M23X Pack 1323X Rngbk 1353X Roll 1383X |  MAP-Pack 13M24Y Pack 1324Y Rngbk 1354Y Roll 1384Y |  MAP-Pack 13M25Z Pack 1325Z Rngbk 1355Z Roll 1385Z |  MAP-Pack 13M26Mc Pack 1326Mc Rngbk 1356Mc Roll 1386Mc |

MAP-PACK (9 labels/sheet)

Kit box only for starter kit - Item # BBOX
Index set for starter kit - Item # BINDEX

Individual Letters

(see label number) 126 labels

Complete Set 13M29SET

27 packs, 3,402 labels

Starter Kit 13M27SK

File box, indexes, 2,025 assorted labels

Refill Kit 13M28RK

2,025 assorted labels

PACK (9 labels/sheet)

Kit box only for starter kit - Item # BBOX
Index set for starter kit - Item # BINDEX

Individual Letters

(see label number) 225 labels

Complete Set 1329SET

27 packs, 6,075 labels

Starter Kit 1327SK

File box, indexes, 2,898 assorted labels

Refill Kit 1328RK

2,898 assorted labels

RINGBOOK (24 labels/sheet)

Binder only for starter kit - Item # MBINDER
Index set only for starter kit - Item # MINDEX

Individual Letters

(see label number) 225 labels

Complete Set 1359SET

27 packs, 6,480 labels

Starter Kit 1357SK

Binder, indexes, 3,471 assorted labels

Refill Kit 1358RK

3,120 assorted labels

ROLL (500 labels/roll)

Tray only for set - Item # W-28

Individual Letters

(see label number) 500 labels

Complete Set 1389SET

















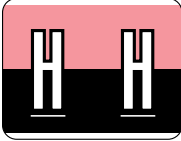
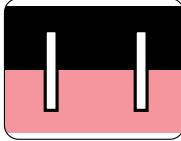



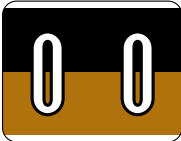

27 rolls, display unit, 13,500 labels

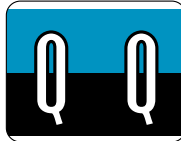
Alphabetic Color Coded Labels

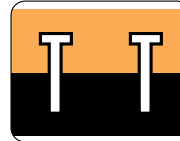
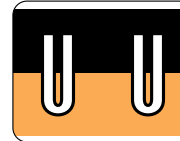
Kardex® Compatible

PSF139 Series

1-1/4" H x 1-5/8" W (Polylaminated)

| | | | | | | |
|--|--|--|--|---|--|--|
|  Roll PSF139-A |  Roll PSF139-B |  Roll PSF139-C |  Roll PSF139-D |  Roll PSF139-E |  Roll PSF139-F |  Roll PSF139-G |
|  Roll PSF139-H |  Roll PSF139-I |  Roll PSF139-J |  Roll PSF139-K |  Roll PSF139-L |  Roll PSF139-M |  Roll PSF139-N |
|  Roll PSF139-O |  Roll PSF139-P |  Roll PSF139-Q |  Roll PSF139-R |  Roll PSF139-S |  Roll PSF139-T |  Roll PSF139-U |
|  Roll PSF139-V |  Roll PSF139-W |  Roll PSF139-X |  Roll PSF139-Y |  Roll PSF139-Z | <p>Roll (500 labels/roll) Dispenser tray for set - Item # DT-3 (need 3 total)</p> <p>Individual Letters (see label number) 500 labels</p> <p>Complete Set PSF139-ST 26 rolls, 13,000 labels</p> | |



Kardex® Comparable Folders (pages 21-22)

- Blank, Alpha, or Numeric
- Letter or Legal
- Tyvek® Expansion

POS® 2000 Compatible

▶ 1700 Series
15/16" H x 1-5/8" W
(Polylaminated)

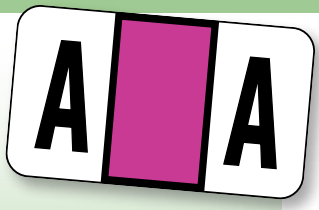

POS® 3300/3400 Compatible

▶ 1900 Series & POS Series
15/16" H x 1-5/8" W (Polylaminated)

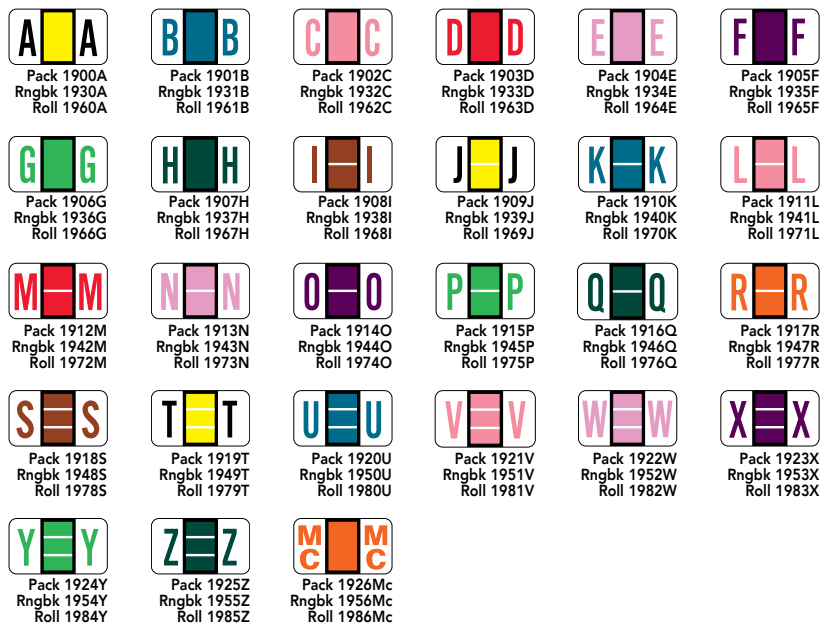
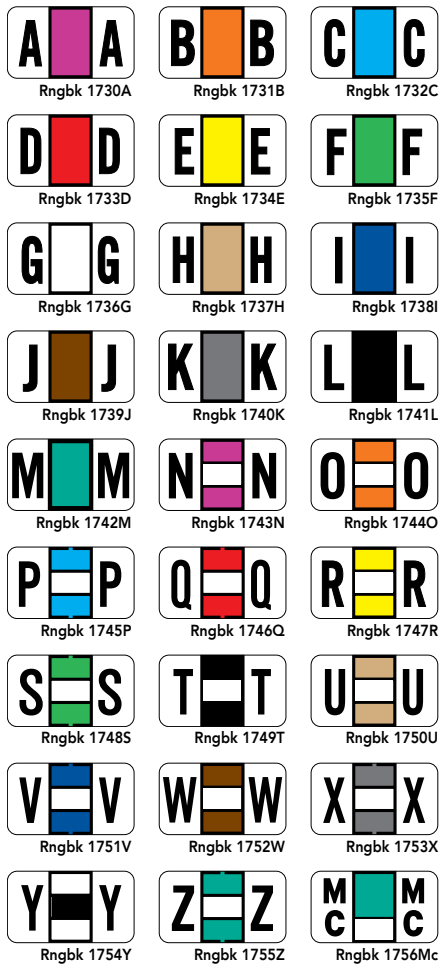
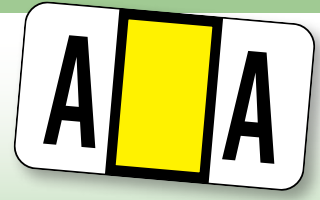

PACK (9 labels/sheet)
Kit box only for starter kit - Item # BBOX
Index set only for starter kit - Item # BINDEX

Individual Letters
(see label number) 225 labels

Complete Set 1929SET
27 packs, 6,075 labels

Starter Kit 1927SK
File box, indexes, 2,898 assorted labels

Refill Kit 1928RK
2,898 assorted labels

RINGBOOK (24 labels/sheet)
Binder only for starter kit - Item # MBINDER
Index set only for starter kit - Item # MINDEX

Individual Letters
(see label number) 240 labels

Complete Set 1959SET
27 packs, 6,480 labels

Starter Kit 1957SK
Binder, indexes, 3,120 assorted labels

Refill Kit 1958RK
3,120 assorted labels

ROLL (500 labels/roll)
Tray only for set - Item # W-28

Individual Letters
(see label number) 500 labels

Complete Set 1989SET
27 rolls, display unit, 13,500 labels

RINGBOOK (24 labels/sheet)
Binder only for starter kit - Item # MBINDER
Index set only for starter kit - Item # MINDEX

Individual Letters (see label number) 240 labels

Complete Set 1759SET 27 packs, 6,480 labels

Starter Kit 1757SK Binder, indexes, 3,120 assorted labels

Refill Kit 1758RK 3,120 assorted labels

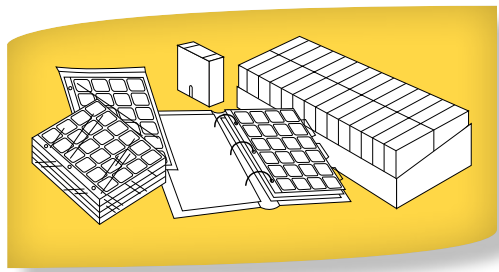

RINGBOOK (10 labels/sheet)
Binder only for starter kit - Item # SBINDER
Index set for starter kit - Item # SININDEX

Individual Letters
(see label number) 200 labels

Complete Set 3059SET
27 packs, 5,400 labels

Starter Kit 3057SK
Binder, indexes, 1,010 assorted labels

Refill Kit 3058RK
1,010 assorted labels

ROLL (500 labels/roll)
Tray only for set - Item # D-15

Individual Letters
(see label number) 500 labels

Complete Set 3089SET
27 rolls, 13,500 labels

GBS® (VRE) 8848/8850 Compatible

▶ 3000 Series & 1900A Series
1-5/16" H x 1-1/4" W (Polylaminated)



Alphabetic Color Coded Labels

Safeguard® 511/514 Compatible

1500 Series SG Series
15/16" H x 1-5/8" W (Polylaminated)

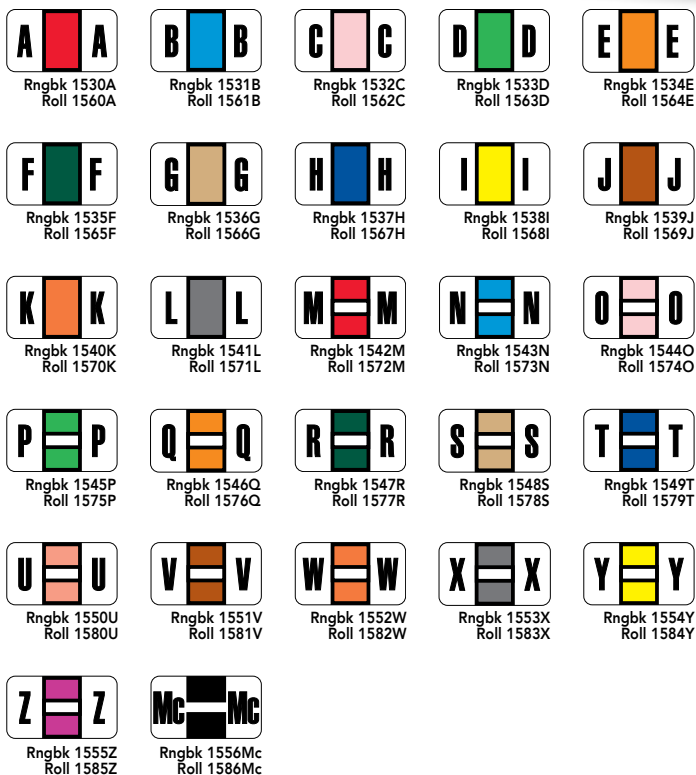
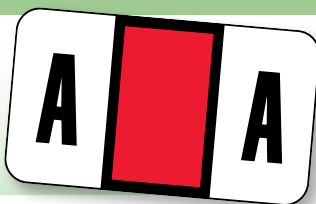

RINGBOOK (24 labels/sheet)
Binder only for starter kit - Item # MBINDER
Index set only for starter kit - Item # MINDEX

Individual Letters
(see label number) 240 labels

Complete Set 1559SET
27 packs, 6,480 labels

Starter Kit 1557SK
Binder, indexes, 3,471 assorted labels

Refill Kit 1558RK
3,120 assorted labels

ROLL (500 labels/roll)
Tray only for set - Item # W-28

Individual Letters
(see label number) 500 labels

Complete Set 1589SET
27 rolls, display unit, 13,500 labels

Reynolds & Reynolds® RF Compatible

3800 Series
3/4" H x 1-1/2" W (Polylaminated)

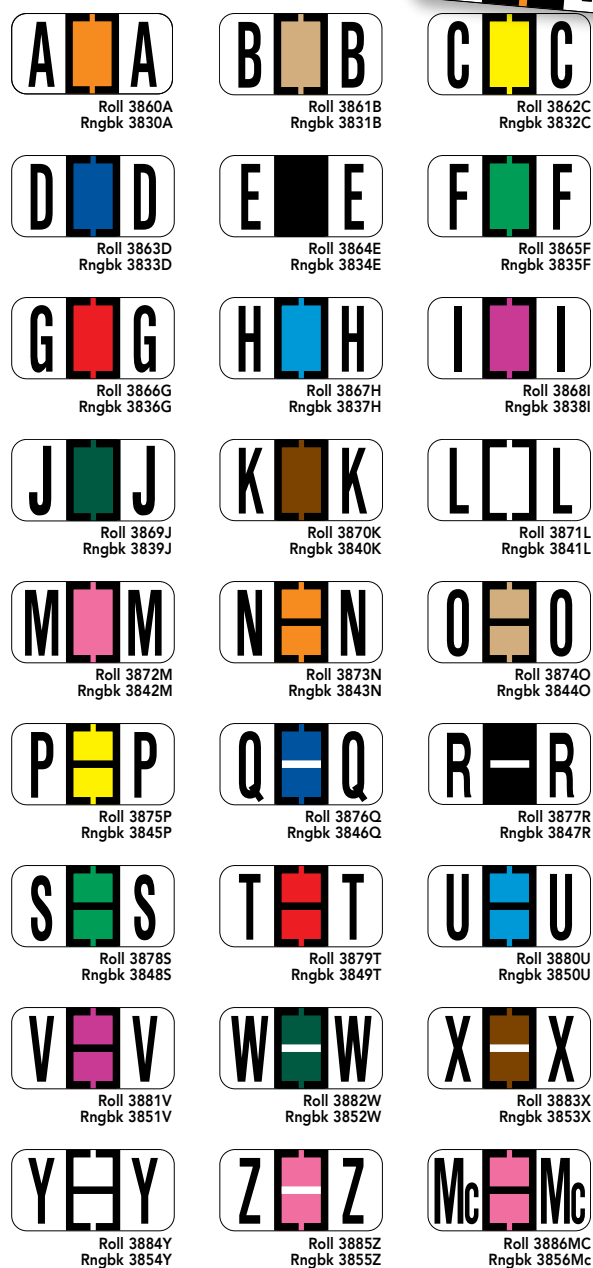

RINGBOOK (27 labels/sheet)
Binder only for starter kit - Item # MBINDER
Index set only for starter kit-Item # MINDEX

Individual Letters
(see label number) 270 labels

Complete Set 3859SET 27 packs, 7,290 labels

Starter Kit 3857SK Binder, indexes, 3,510 labels

Refill Kit 3858RK 3,510 assorted labels

ROLL (500 labels/roll)
Tray only for set - Item # W-28

Individual Letters
(see label number) 500 labels

Complete Set 3889SET 27 rolls, display unit, 13,500 labels

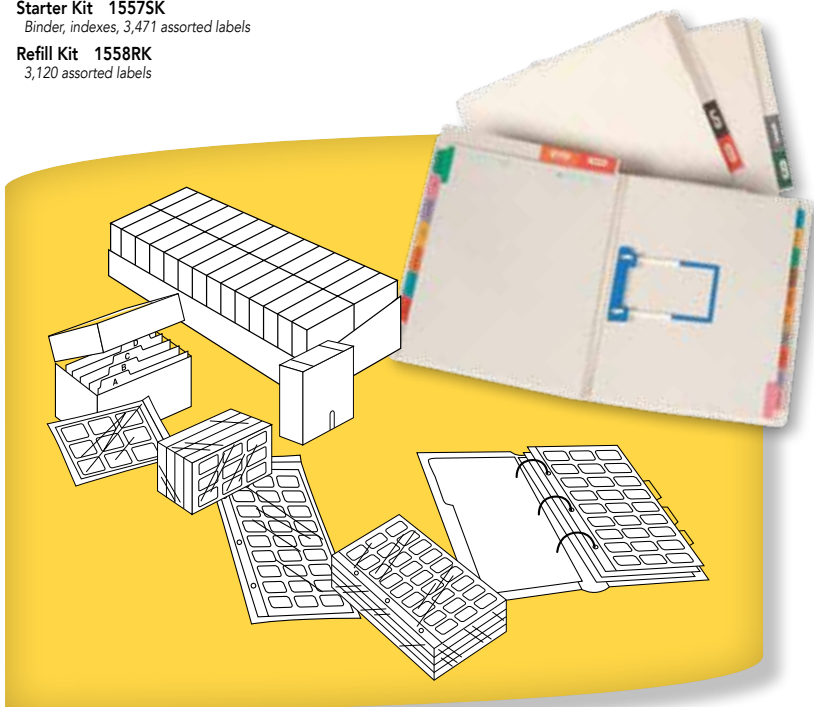

Smead® ACC/ACCS Compatible

▶ 2800 Series Ⓞ ACC Series
1" H x 1-5/8" W (Polylaminated)

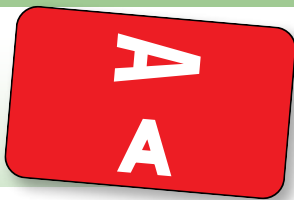

| | | | | |
|--------------------------|--------------------------|--------------------------|--------------------------|--------------------------|
| | | | | |
| Pack 2800A Roll 2860A | Pack 2801B Roll 2861B | Pack 2802C Roll 2862C | Pack 2803D Roll 2863D | Pack 2804E Roll 2864E |
| | | | | |
| Pack 2805F Roll 2865F | Pack 2806G Roll 2866G | Pack 2807H Roll 2867H | Pack 2808I Roll 2868I | Pack 2809J Roll 2869J |
| | | | | |
| Pack 2810K Roll 2870K | Pack 2811L Roll 2871L | Pack 2812M Roll 2872M | Pack 2813N Roll 2873N | Pack 2814O Roll 2874O |
| | | | | |
| Pack 2815P Roll 2875P | Pack 2816Q Roll 2876Q | Pack 2817R Roll 2877R | Pack 2818S Roll 2878S | Pack 2819T Roll 2879T |
| | | | | |
| Pack 2820U Roll 2880U | Pack 2821V Roll 2881V | Pack 2822W Roll 2882W | Pack 2823X Roll 2883X | Pack 2824Y Roll 2884Y |
| | | | | |

PACK (10 labels/sheet)
Kit box only for starter kit - Item # BBOX
Index set for starter kit - Item # AINDEX

Individual Letters
(see label number) 100 labels

Complete Set 2829SET
26 packs, 2,600 labels

Starter Kit 2827SK
File box, indexes, 2,200 assorted labels

Refill Kit 2828RK
2,200 assorted labels

ROLL (250 labels/roll)
Tray only for set - Item # W-28

Individual Letters
(see label number) 250 labels

Complete Set 2889SET
26 rolls, display unit, 6,500 labels

Smead® BCCR/BCCS Compatible

▶ 1200 Series
1" H x 1-1/4" W (Polylaminated)

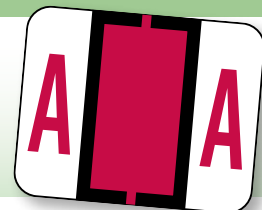

| | | | | |
|---|---|---|---|---|
| | | | | |
| Map-Pack 12M00A Pack 1200A Roll 1260A | Map-Pack 12M01B Pack 1201B Roll 1261B | Map-Pack 12M02C Pack 1202C Roll 1262C | Map-Pack 12M03D Pack 1203D Roll 1263D | Map-Pack 12M04E Pack 1204E Roll 1264E |
| | | | | |
| Map-Pack 12M05F Pack 1205F Roll 1265F | Map-Pack 12M06G Pack 1206G Roll 1266G | Map-Pack 12M07H Pack 1207H Roll 1267H | Map-Pack 12M08I Pack 1208I Roll 1268I | Map-Pack 12M09J Pack 1209J Roll 1269J |
| | | | | |
| Map-Pack 12M10K Pack 1210K Roll 1270K | Map-Pack 12M11L Pack 1211L Roll 1271L | Map-Pack 12M12M Pack 1212M Roll 1272M | Map-Pack 12M13N Pack 1213N Roll 1273N | Map-Pack 12M14O Pack 1214O Roll 1274O |
| | | | | |
| Map-Pack 12M15P Pack 1215P Roll 1275P | Map-Pack 12M16Q Pack 1216Q Roll 1276Q | Map-Pack 12M17R Pack 1217R Roll 1277R | Map-Pack 12M18S Pack 1218S Roll 1278S | Map-Pack 12M19T Pack 1219T Roll 1279T |
| | | | | |
| Map-Pack 12M20U Pack 1220U Roll 1280U | Map-Pack 12M21V Pack 1221V Roll 1281V | Map-Pack 12M22W Pack 1222W Roll 1282W | Map-Pack 12M23X Pack 1223X Roll 1283X | Map-Pack 12M24Y Pack 1224Y Roll 1284Y |
| | | | | |

MAP-PACK (12 labels/sheet)
Kit box only for starter kit - Item # BBOX
Index set for starter kit - Item # BINDEX

Individual Letters
(see label number) 132 labels

Complete Set 12M29SET
27 packs, 3,564 labels

Starter Kit 12M27SK
File box, indexes, 2,076 assorted labels

Refill Kit 12M28RK
2,076 assorted labels

PACK (12 labels/sheet)
Kit box only for starter kit - Item # BBOX
Index set for starter kit - Item # BINDEX

Individual Letters
(see label number) 120 labels

Complete Set 1229SET
27 packs, 3,240 labels

Starter Kit 1227SK
File box, indexes, 2,484 assorted labels

Refill Kit 1228RK
2,484 assorted labels

ROLL (500 labels/roll)
Tray only for set - Item # W-28

Individual Letters
(see label number) 500 labels

Complete Set 1289SET
27 rolls, display unit, 3,500 labels

Smead® NCC Compatible

▶ 2900 Series Ⓞ NCC Series
1-5/32" H x 3-5/8" W (Matte Paper)

| | | |
|-------------|-------------|-------------|
| | | |
| Pack 2900AN | Pack 2901BO | Pack 2902CP |
| | | |
| Pack 2905FS | Pack 2906GT | Pack 2907HU |
| | | |
| Pack 2908IV | Pack 2909JW | |
| | | |
| Pack 2910KX | Pack 2911LY | Pack 2912MZ |

PACKS (5 labels/sheet)
Kit box only for starter kit - Item # BBOX
Index set for starter kit - Item # DINDEX

Individual Letters
(see label number) 100 labels

Complete Set 2929SET
13 packs, 1,300 labels

Starter Kit 2927SK
File box, indexes, 1,500 assorted labels

Refill Kit 2928RK
1,500 assorted labels

Alphabetic Color Coded Labels

TAB® 1283/1286 Compatible

▶ 1000 Series Ⓞ 1283 Series
1" H x 1-1/4" W (Vinyl)

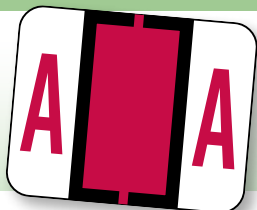

PACK (9 labels/sheet)
Kit box only for starter kit - Item # BBOX
Index set for starter kit - Item # BINDEK

Individual Letters
(see label number) 225 labels

Complete Set 1029SET
27 packs, 6,075 labels

Starter Kit 1027SK
File box, indexes, 2,898 assorted labels

Refill Kit 1028RK
2,898 assorted labels

RINGBOOK (50 labels/sheet)
Binder only for starter kit - Item # LBINDER
Index set only for starter kit - Item # LINDEK

Individual Letters
(see label number) 500 labels

Complete Set 1059SET
27 packs, 13,500 labels

Starter Kit 1057SK
Binder, indexes, 3,200 assorted labels

Refill Kit 1058RK
3,200 assorted labels

ROLL (500 labels/roll)
Tray only for set - Item # W-28

Individual Letters
(see label number) 500 labels

Complete Set 1089SET
27 rolls, display unit, 13,500 labels

TAB® 1383 Compatible

Ⓞ 1383 Series
1" H x 1-1/4" W (Polylaminated)

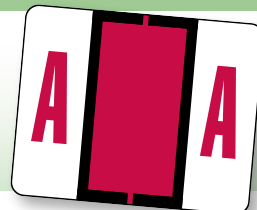

PACK
Binder only for set - Item # 3 Ring Binder

Individual Letters
(see label number) 240 labels

Complete Set 1383PK-ST-240
26 packs, 6,240 labels, MC not included

ROLL (500 labels/roll)
Tray only for set - Item # DT-6

Individual Letters
(see label number) 500 labels

Complete Set 1383-ST
26 rolls, 13,000 labels, MC not included

TAB® 1278 Compatible

▶ 1100 Series Ⓞ 1278 Series
1/2" H x 1" W (Vinyl)



Roll 1160A



Roll 1161B



Roll 1162C



Roll 1163D



Roll 1164E



Roll 1165F



Roll 1166G



Roll 1167H

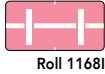

Roll 1168I



Roll 1169J



Roll 1170K



Roll 1171L



Roll 1172M



Roll 1173N



Roll 1174O



Roll 1175P

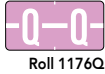

Roll 1176Q



Roll 1177R

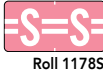

Roll 1178S



Roll 1179T



Roll 1180U



Roll 1181V



Roll 1182W



Roll 1183X



Roll 1184Y



Roll 1185Z

ROLL (500 labels/roll)
Tray only for set - Item # D-10
Individual Letters
(see label number) 500 labels
Complete Set 1189SET
26 rolls, display unit, 13,000 labels

POS® 3700/3800 Compatible

▶ 2000 Series Ⓞ POSR Series
1-1/2" H x 1-1/2" W (Poly laminated)



Pack 2000AB



Pack 2002C



Pack 2003DEF



Pack 2006GHI

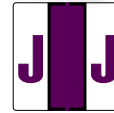

Pack 2009J



Pack 2010KL



Pack 2012MNO



Pack 2015PQR



Pack 2018ST



Pack 2020UZ



Pack 2000AD



Pack 2004EH



Pack 2008IN

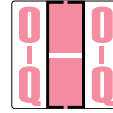

Pack 2014OQ



Pack 2017RZ

PACK (5 labels/sheet)
Individual Letters
(see label number) 100 labels

3700 Compatible: Complete Set 2029SET
100 per package, 10 packages, 1,000 labels
3800 Compatible/Complete Set 2039SET
100 per package, 5 packages, 500 labels

Patients will return
regularly when you
brighten their mailbox
with reminder cards!
(pages 95-99)

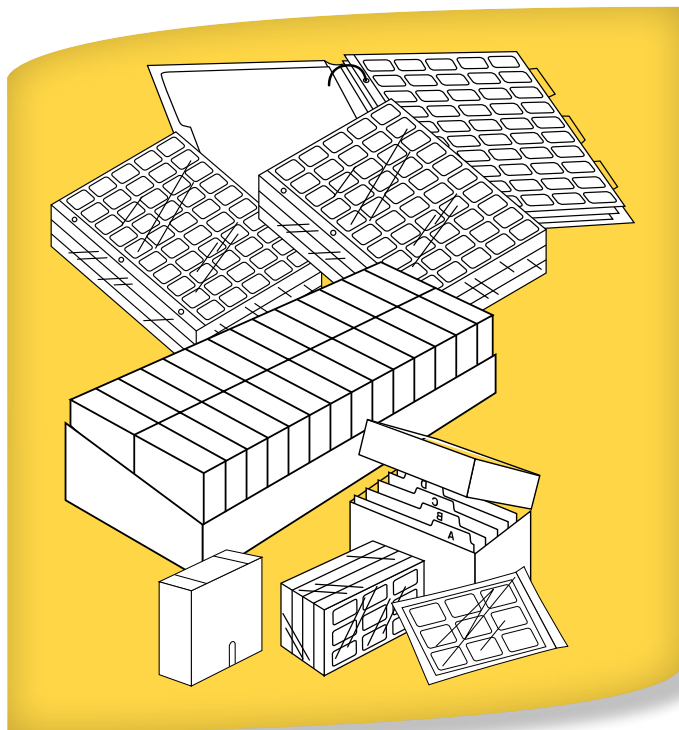

Numeric Color Coded Labels

Acme® Compatible

0500 Series
1-1/2"H x 1-1/2"W
(Polylaminated)



Roll 0500-0



Roll 0500-1



Roll 0500-2



Roll 0500-3



Roll 0500-4



Roll 0500-5



Roll 0500-6



Roll 0500-7



Roll 0500-8



Roll 0500-9

ROLL (500 labels)
Dispenser tray for set - Item # DT-3
Individual Rolls
(see label number) 500 labels
Complete Set 0500-ST
10 rolls, 5,000 labels

Acme® DAVM Compatible

DAVM Series
1"H x 1-1/2"W
(Polylaminated)

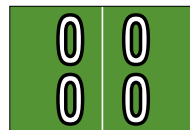
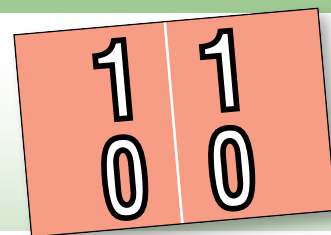

Roll DAVM-00 (00-09)

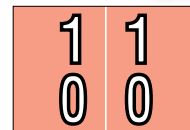

Roll DAVM-10 (00-19)

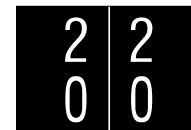

Roll DAVM-20 (20-29)



Roll DAVM-30 (30-39)



Roll DAVM-40 (40-49)



Roll DAVM-50 (50-59)

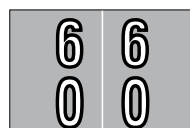

Roll DAVM-60 (60-69)



Roll DAVM-70 (70-79)

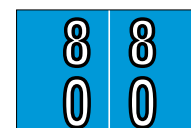

Roll DAVM-80 (80-89)



Roll DAVM-90 (90-99)

ROLL (500 labels)
Dispenser tray for set - Item # DT-3
Individual Rolls
(see label number) 500 labels
Complete Set DAVM-ST
10 rolls, 5,000 labels

Ames® Compatible Solid Color

0178 Series
1-7/8"H x 1-7/8"W
(Polylaminated)



Roll 0178-RD

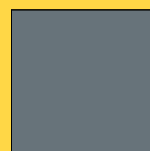

Roll 0178-GY

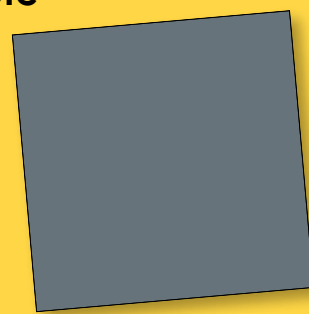

Roll 0178-BL

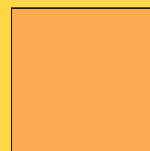

Roll 0178-OR



Roll 0178-PR



Roll 0178-BK

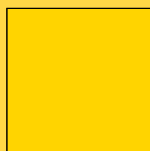

Roll 0178-YL



Roll 0178-BR

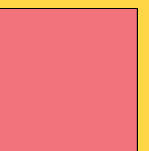

Roll 0178-PK

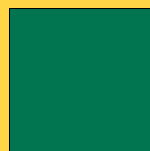

Roll 0178-GR

ROLL (500 labels)
Dispenser tray for set - Item # DT-4
Individual Rolls
(see label number) 500 labels
Complete Set 0178-ST
10 rolls, 5,000 labels

Ames® Compatible

40800 Series 0178N Series
1-7/8"H x 1-7/8"W
(Polylaminated)



Roll 40860R



Roll 40861GY

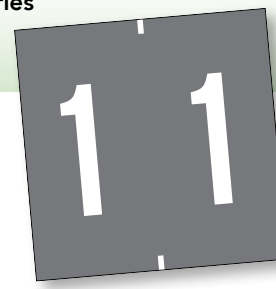

Roll 40862BE



Roll 40863OR



Roll 40864P



Roll 40865BK



Roll 40866Y



Roll 40867BN

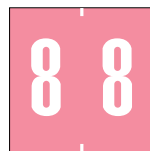

Roll 40868PK



Roll 40869GN

ROLL (500 labels)
Individual Rolls
(see label number) 500 labels
Complete Set 40889SET
10 rolls, 5,000 labels

Barkley® DBKM Compatible

DBKM Series
1" H x 1-1/2" W
(Polylaminated)

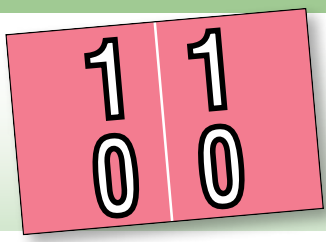

| | | |
|--|---|--|
| | | |
| | | |
| | | |
| | <p>ROLL (500 labels) Dispenser tray for set - Item # DT-3</p> <p>Individual Rolls (see label number) 500 labels</p> <p>Complete Set DBKM-ST 10 rolls, 5,000 labels</p> | |

Barkley® NBKM & Sycom® Compatible

5400 Series DBKM Series
1" H x 1-1/2" W
(Polylaminated)



| | | |
|--|--|---|
| | | <p>MAP-PACK (9 labels/sheet) Kit box only for starter kit - Item # BBOX Index set for starter kit - Item # BINDEX#</p> <p>Individual Numbers (see label number) 126 labels</p> <p>Complete Set 54M29SET 10 packs, 1,260 labels</p> <p>Starter Kit 54M30SK File box, indexes, 2,520 assorted labels</p> <p>PACK (9 labels /sheet) Kit box only for starter kit - Item # BBOX Index set for starter kit - Item # BINDEX#</p> <p>Individual Packs (see label number) 225 labels</p> <p>Complete Set 5429SET 10 packs, 2,250 labels</p> <p>Starter Kit 5427SK File box, indexes, 2,250 assorted labels</p> <p>ROLL (500 labels/roll) Tray only for set - Item # D-10</p> <p>Individual Rolls (see label number) 500 labels</p> <p>Complete Set 5489SET 10 rolls, display unit, 5000 labels</p> |
| | | |
| | | |
| | | |
| | | |
| | | |
| | | |
| | | |
| | | |
| | | |

Barkley® NAVM Compatible

NAVM Series
1-11/16" H x 1-1/2" W
(Polylaminated)

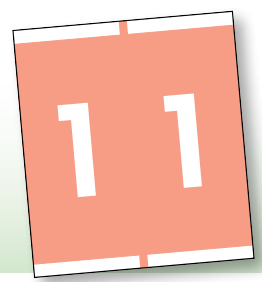

| | | | |
|--|--|---|--|
| | | | |
| | | | |
| | | <p>ROLL (500 labels) Dispenser tray for set - Item # DT-3</p> <p>Individual Rolls (see label number) 500 labels</p> <p>Complete Set NAVM-ST 10 rolls, 5,000 labels</p> | |

Barkley® NBAM & NBWM® Compatible

40200 Series DBKM Series
1/2" H x 1-1/2" W (Polylaminated)

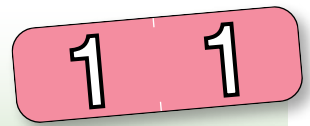

| | | | | |
|--|--|--|--|--|
| | | | | |
| | | | | |
| <p>ROLL (500 labels/roll) Tray only for set - Item # D-10</p> | | <p>Individual Rolls (see label number) 500 labels</p> | <p>Complete Set 40289SET 10 rolls, display unit, 5,000 labels</p> | |

Barkley® NBAM & NBWM® Compatible

40400 Series DBKM Series
1/2" H x 1-1/2" W (Polylaminated)

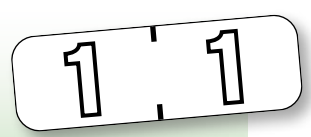

| | | | | |
|--|--|--|--|--|
| | | | | <p>ROLL (1,000 labels) Tray only for set - Item # D-10</p> <p>Individual Rolls (see label number) 1,000 labels</p> <p>Complete Set 40489SET 10 rolls, display unit, 10,000 labels</p> |
| | | | | |
| | | | | |

Numeric Color Coded Labels

Brunswick® Compatible Digi Color

DD0100 Series

15/16" H x 1-5/8" W (Polylaminated)



Roll DD0100



Roll DD0101



Roll DD0102



Roll DD0103



Roll DD0104



Roll DD0105



Roll DD0106



Roll DD0107



Roll DD0108



Roll DD0109

ROLL (500 labels)
Dispenser tray for set - Item # DT-1

Individual Rolls
(see label number) 500 labels

Complete Set DD0100-ST
10 rolls, 5,000 labels

Brunswick® Compatible

0950 Series

15/16" H x 1-5/8" W (Polylaminated)

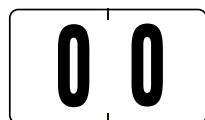

Roll 0950-0

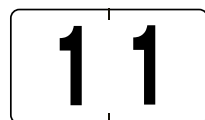

Roll 0950-1

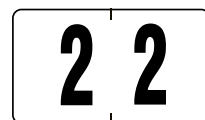

Roll 0950-2

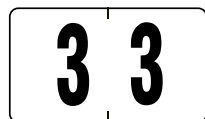

Roll 0950-3

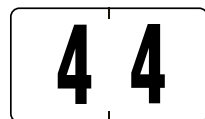

Roll 0950-4

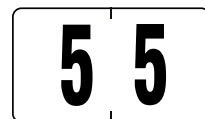

Roll 0950-5

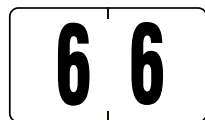

Roll 0950-6

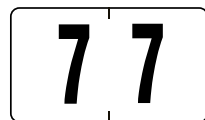

Roll 0950-7

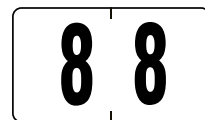

Roll 0950-8

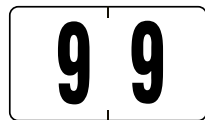

Roll 0950-9

ROLL (500 labels)
Dispenser tray for set - Item # DT-1

Individual Rolls
(see label number) 500 labels

Complete Set 0950-ST
10 rolls, 5,000 labels

Col'R'Tab® 11000 Compatible

5100 Series 11100 Series

1" H x 1-1/2" W (Polylaminated)



Roll 5160Y



Roll 5161LBE



Roll 5162R



Roll 5163LGN



Roll 5164GY



Roll 5165GD



Roll 5166DGN



Roll 5167DBE



Roll 5168OR



Roll 5169BK

ROLL (500 labels)
Tray only for set - Item # D-15
Individual Rolls
(see label number) 500 labels
Complete Set 5189SET
10 rolls, display unit, 5,000 labels

Col'R'Tab® 11200 Compatible

11200 Series

1" H x 1-1/2" W, (Polylaminated)

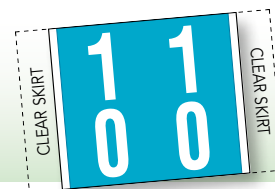

Roll 11200-0 (00-09)



Roll 11200-1 (10-19)



Roll 11200-2 (20-29)



Roll 11200-3 (30-39)



Roll 11200-4 (40-49)



Roll 11200-5 (50-59)



Roll 11200-6 (60-69)



Roll 11200-7 (70-79)



Roll 11200-8 (80-89)



Roll 11200-9 (90-99)

ROLL (500 labels)
Dispenser tray for set - Item # DT-3
Individual Rolls
(see label number) 500 labels
Complete Set 11200-ST
10 rolls, 5,000 labels

Colwell Jewel Tone Compatible

8300 Series

1" H x 1-1/2" W (Polylaminated)



Roll 8360Y



Roll 8361R



Roll 8362GN



Roll 8363BN



Roll 8364BE



Roll 8365V

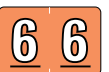

Roll 8366OR



Roll 8367LGN



Roll 8368P



Roll 8369GD

ROLL (500 labels/roll)
Tray only for set - Item # D-10

Individual Rolls
(see label number) 500 labels

Complete Set 8389SET
10 rolls, display unit, 5,000 labels

Data File® Compatible

④ Data-Mini Numeric Series
7/16" H x 1-1/4" W (Polylaminated)

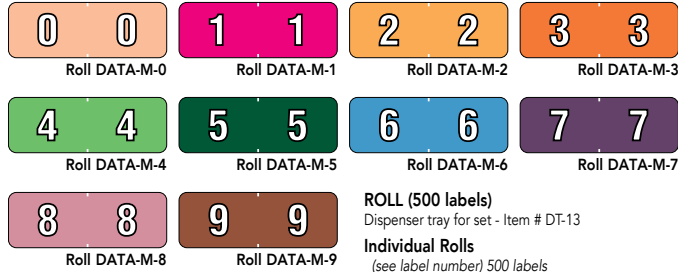
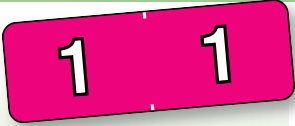

ROLL (500 labels)
Dispenser tray for set - Item # DT-13
Individual Rolls
(see label number) 500 labels
Complete Set DATA-MN-ST
10 rolls, 5,000 labels

Data Visible Acme® Compatible

④ 0570 Series
1-1/2"H x 1-1/2"W (Polylaminated)



ROLL (500 labels)
Dispenser tray for set - Item # DT-3
Individual Rolls
(see label number) 500 labels
Complete Set 0570-ST
10 rolls, 5,000 labels

File Doctor® Compatible

④ 9998 Series
1"H x 1-1/4"W (Vinyl)

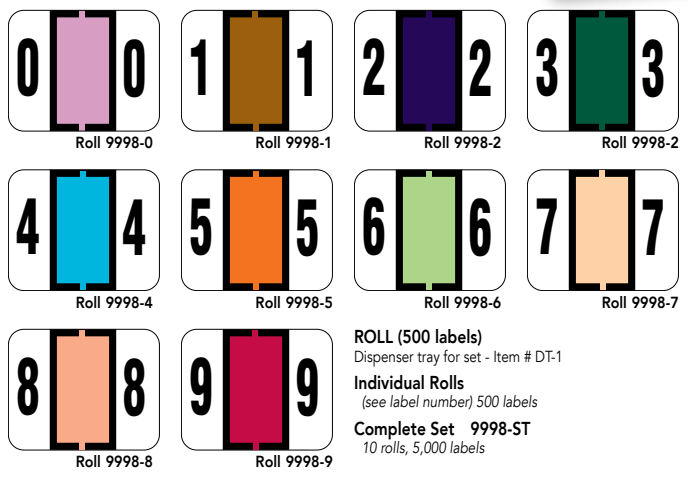
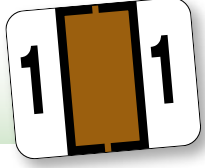

ROLL (500 labels)
Dispenser tray for set - Item # DT-1
Individual Rolls
(see label number) 500 labels
Complete Set 9998-ST
10 rolls, 5,000 labels

GBS® Compatible

④ 8816 Series
1/2" H x 1-1/4" W
(Polylaminated)

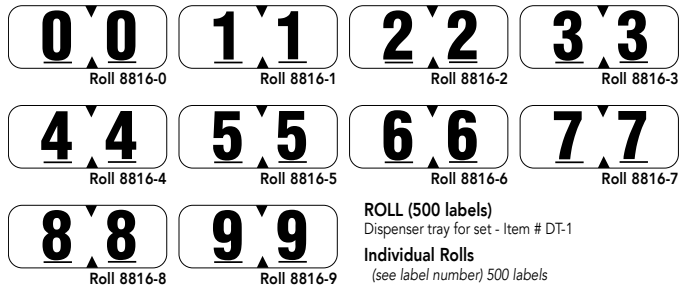

ROLL (500 labels)
Dispenser tray for set - Item # DT-1
Individual Rolls
(see label number) 500 labels
Complete Set 8816-ST
10 rolls, 5,000 labels

GBS® (VRE) 8860 Compatible

④ 5000 Series ④ 1900N Series
1-5/16"H x 1-1/4"W (Polylaminated)



ROLL (500 labels)
Tray only for set - Item # D-15
Individual Rolls
(see label number) 500 labels
Complete Set 5089SET
10 rolls, display unit, 5,000 labels

IFC/AFV® Compatible

④ 3300 Series
1-7/8"H x 1-7/8"W (Polylaminated)

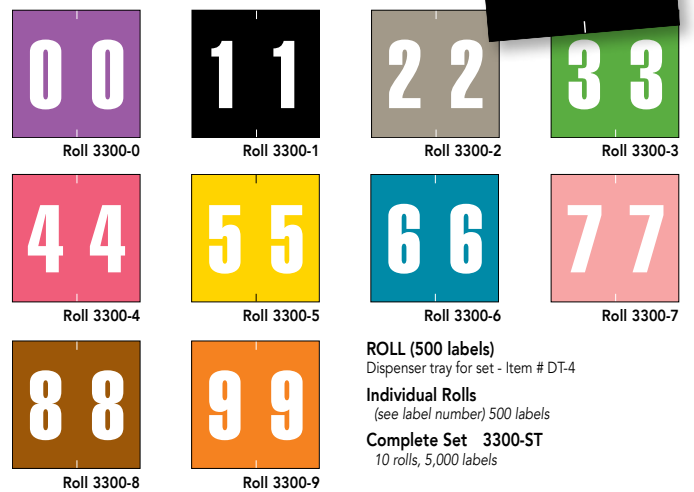









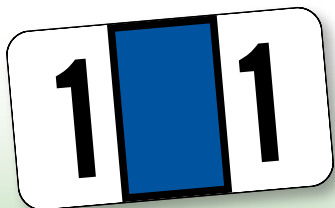

ROLL (500 labels)
Dispenser tray for set - Item # DT-4
Individual Rolls
(see label number) 500 labels
Complete Set 3300-ST
10 rolls, 5,000 labels





Numeric Color Coded Labels

Jeter® 2600 Compatible

▶ 5300 Series
15/16" H x 1-5/8" W
(Poly laminated)



| | |
|--|---|
|  Roll 5360BE |  Roll 5361DBE |
|  Roll 5362OR |  Roll 5363BK |
|  Roll 5364BN |  Roll 5365Y |
|  Roll 5366W |  Roll 5367LGN |
|  Roll 5368R |  Roll 5369P |

| | |
|--|---|
|  Roll 5361-200R |  Roll 5363-200LGN |
|  Roll 5364-200PK |  Roll 5367-200BK |
|  Roll 5368-200T | |

ROLL (500 labels/roll)
Tray only for set - Item # D-10







Individual Rolls
(see label number) 500 labels

Complete Sets
5389SET 10 rolls, display unit, 5,000 labels
5389-200SET 10 rolls, display unit, 5,000 labels
(No. 1, 3, 4, 7, 8 are substituted)

Jeter® 4500 Compatible

▶ 40300 Series
3/4" H x 1-1/2" W
(Poly laminated)



| | |
|---|--|
|  Roll 40360WBK |  Roll 40361WBK |
|  Roll 40362WBK |  Roll 40363WBK |
|  Roll 40364WBK |  Roll 40365WBK |
|  Roll 40366WBK |  Roll 40367WBK |
|  Roll 40368WBK |  Roll 40369WBK |

ROLL (500 labels/roll)
Tray only for set - Item # D-10







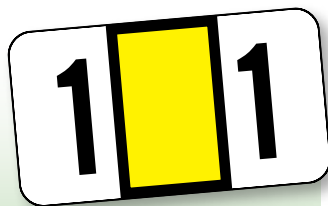

Individual Rolls
(see label number) 500 labels

Complete Set 40389SET
10 rolls, display unit, 5,000 labels

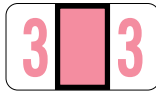
POS® 3500 Compatible

▶ 4900 Series ◉ POS-N Series
15/16" H x 1-5/8" W
(Poly laminated)



| | | | |
|--|--|--|--|
|  Roll 4960BN |  Roll 4961Y |  Roll 4962BE |  Roll 4963PK |
|  Roll 4964R |  Roll 4965L |  Roll 4966P |  Roll 4967GN |
|  Roll 4968DGN |  Roll 4969OR | | |

ROLL (500 labels)
Tray only for set - Item # D-10









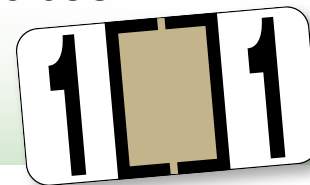

Individual Rolls
(see label number) 500 labels

Complete Set 4989SET
10 rolls, display unit, 5,000 labels

Reynolds & Reynolds® RF Compatible

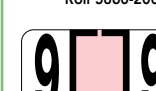
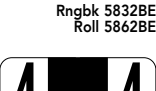
▶ 5800 Series
7/8" H x 1-5/8" W
(Poly laminated)

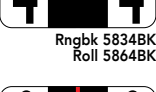
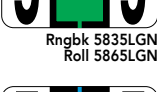

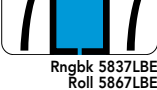
| | | | |
|---|--|--|--|
|  Rngbk 5830OR Roll 5860OR |  Rngbk 5831GD Roll 5861GD |  Rngbk 5830-200LG Roll 5860-200LG |  Rngbk 5835-200OR Roll 5865-200OR |
|  Rngbk 5832BE Roll 5862BE |  Rngbk 5833Y Roll 5863Y |  Rngbk 5839-200PK* Roll 5869-200PK* | |
|  Rngbk 5834BK Roll 5864BK |  Rngbk 5835LGN Roll 5865LGN | | |
|  Rngbk 5836R Roll 5866R |  Rngbk 5837LBE Roll 5867LBE | | |
|  Rngbk 5838P Roll 5868P |  Rngbk 5839DGN Roll 5869DGN | | |

RINGBOOK (24 labels/sheet)
Binder only for starter kit-Item # MBINDER
Index set for starter kit - Item # RMINDEX#

Individual Numbers
(see label number) 240 labels

Complete Sets
5859SET 10 packs, 2,400 labels (standard 0, 5, 9)
5859-200SET 10 packs, 2,400 labels (alternate 0, 5, 9)

Starter Kits
58575K Binder, indexes, 2,400 labels (standard 0, 5, 9)
5857-2005K Binder, indexes, 2,400 labels (alternate 0, 5, 9)

ROLLS (500 labels/roll)
Tray only for set - Item # D-10

Individual Rolls
(see label number) 500 labels

Complete Sets
5889SET 10 rolls, display unit, 5,000 labels (standard 0, 5, 9)
5889-200SET 10 rolls, display unit, 5,000 labels (alternate 0, 5, 9)

Jeter® 8800 Compatible

8800 Series
15/16"H x 1-5/8"W
(Polylaminated)



ROLL (500 labels/roll)
Dispenser tray for set - Item # DT-1
Individual Rolls
(see label number) 500 labels
Complete Set 8800-ST
10 rolls, 5,000 labels

Jeter® 7300 Compatible

4300 Series 7300 Series
15/16"H x 1-5/8"W
(Polylaminated)

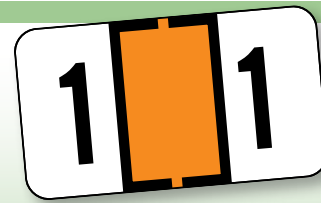

ROLL (500 labels/roll)
Tray only for set - Item # D-10
Individual Rolls
(see label number) 500 labels
Complete Set 4389SET
10 rolls, display unit, 5,000 labels

Jeter® 3000/7400 Compatible

4600 Series 3000 Series
3/4"H x 1-1/2"W
(Polylaminated)

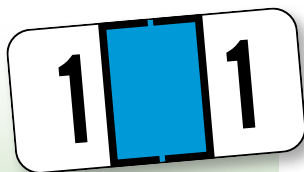

RINGBOOK (27 labels/sheet)
Binder - Item # MBINDER
Individual Packs
(see label number) 270 labels
Complete Set 4659SET
10 packs, 2,700 labels
ROLL (500 labels/roll)
Tray only for set - Item # D-10
Individual Rolls
(see label number) 500 labels
Complete Set 4689SET
10 rolls, display unit, 5,000 labels

Jeter® 6100 Compatible

4800 Series 6100 Series
15/16"H x 1-5/8"W
(Polylaminated)

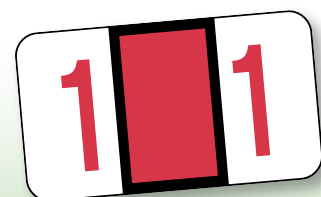

ROLL (500 labels/roll)
Tray only for set - Item # D-10
Individual Rolls
(see label number) 500 labels
Complete Sets
4889SETB 10 rolls, display unit,
5,000 labels (Orange 2/Blue 6)
*4889SETY 10 rolls, display unit,
5,000 labels (Blue 2/Yellow 6)

Kardex® Ten-Scan Compatible

Ten-Scan Series
1-1/4"H x 1-5/8"W (Polylaminated)

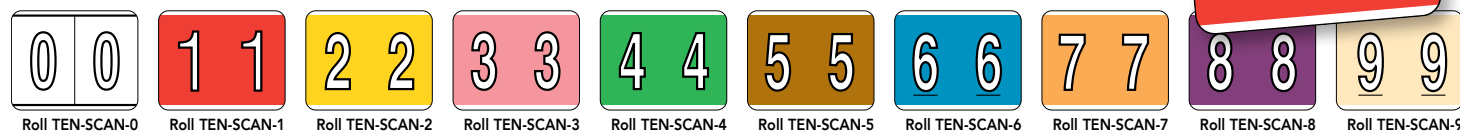

ROLL (500 labels/roll)
Dispenser tray for set - Item # DT-13
Individual Rolls
(see label number) 500 labels
Complete Set TENSCAN-ST
10 rolls, 5,000 labels

Numeric Color Coded Labels

Sav-Tyme® Compatible

NSFM Series

1-11/16"H x 1-1/2"W (Polylaminated)

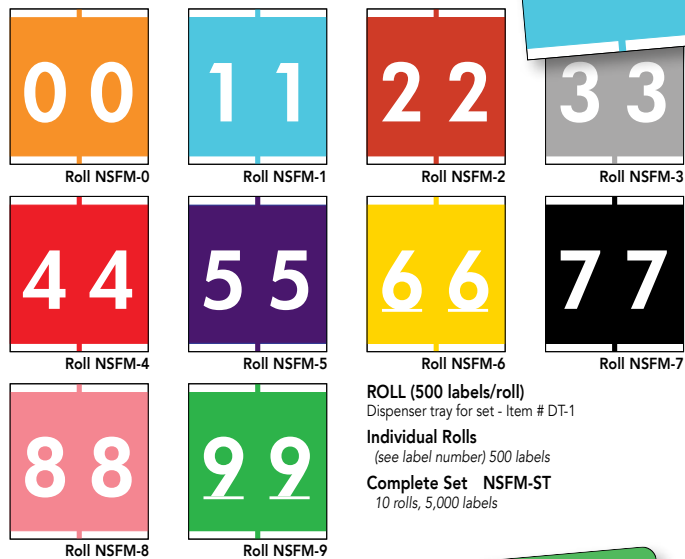

ROLL (500 labels/roll)
Dispenser tray for set - Item # DT-1

Individual Rolls
(see label number) 500 labels

Complete Set NSFM-ST
10 rolls, 5,000 labels

Sav-Tyme® 1700 Compatible

1700 Series

1-1/2"H x 1-1/2"W (Polylaminated)



ROLL (500 labels/roll)
Dispenser tray for set - Item # DT-1

Individual Rolls
(see label number) 500 labels

Complete Set 1700-ST
10 rolls, 5,000 labels

Smead® DCCRN Compatible

DCCRN Series

1"H x 1-1/4"W (Polylaminated)

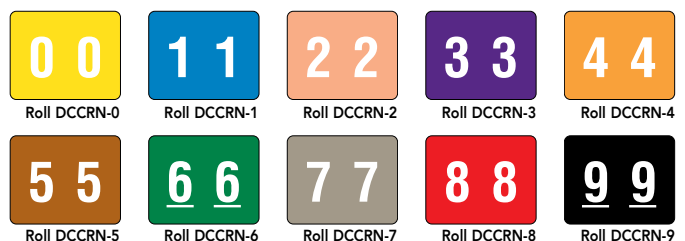

ROLL (500 labels/roll)
Dispenser tray for set - Item # DT-1

Individual Rolls
(see label number) 500 labels

Complete Set DCCRN-ST
10 rolls, 5,000 labels

Smead® LCC Compatible

5600 Series XLCC Series

2"H x 1"W (Matte Paper)



ROLL (250 labels/roll)
Tray only for set - Item # D-10

Individual Rolls
(see label number) 250 labels

Complete Set 5689SET
10 rolls, display unit, 2,500 labels

Smead® BCCRN/BCCSN Compatible

5200 Series

1"H x 1-1/4"W (Polylaminated)



MAP-PACK (12 labels/sheet)
Kit box only for starter kit - Item # BBOX
Index set for starter kit - Item # BINDEX#

PACK (12 labels/sheet)
Kit box - Item # BBOX
Index set - Item # BINDEX#

Individual Packs
(see label number) 120 labels

Complete Set 5229SET
10 packs, 1,200 labels

ROLL (500 labels/roll)
Tray only for set - Item # D-10

Individual Rolls
(see label number) 500 labels

Complete Set 5289SET
10 rolls, display unit, 5,000 labels

TAB® 1282 Compatible

4 1282 Series, 1"H x 1-1/4"W (Vinyl)

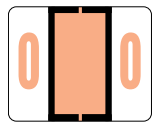
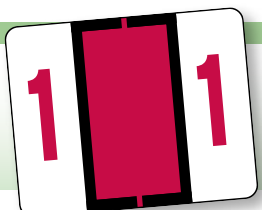

Roll 1282-0



Roll 1282-1

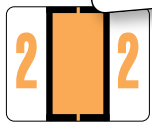

Roll 1282-2



Roll 1282-3

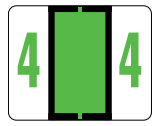

Roll 1282-4



Roll 1282-5

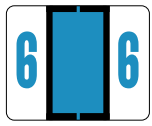

Roll 1282-6



Roll 1282-7

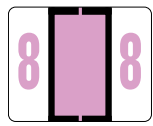

Roll 1282-8



Roll 1282-9

ROLL (500 labels/roll)
Dispenser tray for set - Item # DT-1

Individual Rolls
(see label number) 500 labels

Complete Set 1282-ST
10 rolls, 5,000 labels

TAB® 1282 Compatible

4 4000 Series 4 1282 Series
1"H x 1-1/4"W (Vinyl)

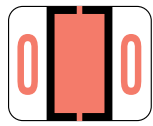
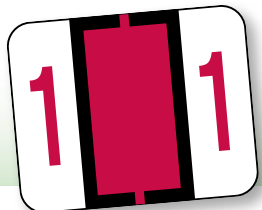

Roll 4060PK

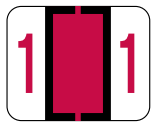

Roll 4061R



Roll 4062LOR



Roll 4063DOR

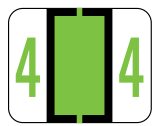

Roll 4064LGN



Roll 4065DGN

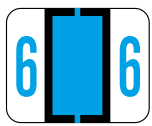

Roll 4066BE



Roll 4067P

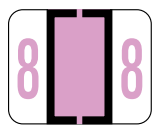

Roll 4068L



Roll 4069BN

ROLL (500 labels/roll)
Tray only for set - Item # D-10

Individual Rolls
(see label number) 500 labels

Complete Set 4089SET
10 rolls, display unit, 5,000 labels

TAB® 1277 Compatible

4 4100 Series 4 1277 Series; 1/2"H x 1"W (Vinyl)

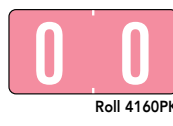

Roll 4160PK



Roll 4161R

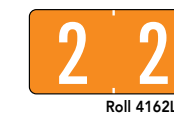

Roll 4162LOR

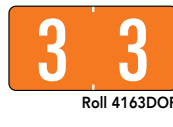

Roll 4163DOR

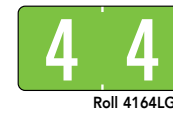

Roll 4164LGN



Roll 4165DGN

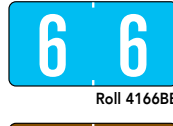

Roll 4166BE



Roll 4167P



Roll 4168L

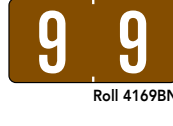

Roll 4169BN

ROLL (500 labels/roll)
Tray only for set - Item # D-10

Individual Rolls
(see label number) 500 labels

Complete Set 4189SET
10 rolls, display unit, 5,000 labels

TAB® 1280 Compatible

4 4200 Series 4 1280 Series
1/2"H x 1"W (Vinyl)



Roll 4260OR



Roll 4261GN



Roll 4262DBE

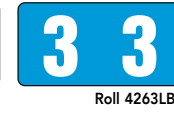

Roll 4263LBE



Roll 4264BN

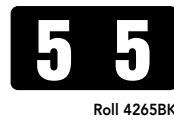

Roll 4265BK

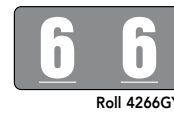

Roll 4266GY

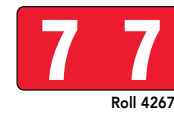

Roll 4267R

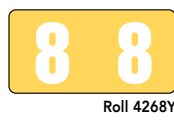

Roll 4268Y

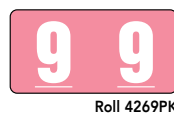

Roll 4269PK

ROLL (500 labels/roll)
Tray only for set - Item # D-10

Individual Rolls
(see label number) 500 labels

Complete Set 4289SET
10 rolls, display unit, 5,000 labels

TAB® 1382 Compatible

4 1382 Series
1"H x 1-1/4"W (Polylaminated)

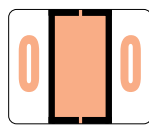
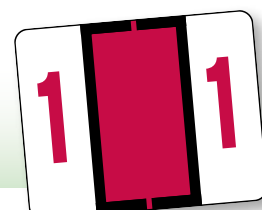

Roll 1382-0

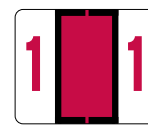

Roll 1382-1



Roll 1382-2



Roll 1382-3

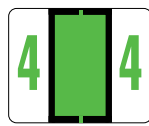

Roll 1382-4



Roll 1382-5

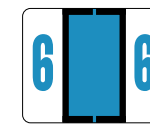

Roll 1382-6

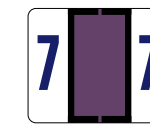

Roll 1382-7

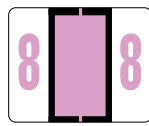

Roll 1382-8



Roll 1382-9

ROLL (500 labels/roll)
Dispenser tray for set - Item # DT-1

Individual Rolls
(see label number) 500 labels

Complete Set 1382-ST
10 rolls, 5,000 labels

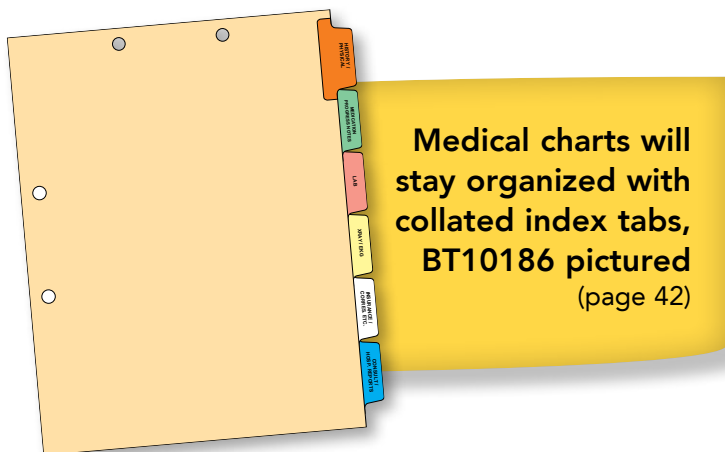

Medical charts will stay organized with collated index tabs, BT10186 pictured (page 42)

Year/Aging Color Coded Labels

PMA
Fluorescent Series
1-1/2" W x 3/4" H
Polylaminated
500/Roll



2015 • 0715FLGN
2014 • 0714FLGN



2015 • 0715FLY
2014 • 0714FLY



2015 • 0715FLPK
2014 • 0714FLPK



2015 • 0715FLRD
2014 • 0714FLRD



2015 • 0715FLOR
2014 • 0714FLOR

Best Tab
1-1/2" W x 3/4" H
Polylaminated
500/Roll



2015 • 0715GNY
2014 • 0714GNY



2015 • 0715ORY
2014 • 0714ORY



2015 • 0715BEY
2014 • 0714BEY



2015 • 0715RY
2014 • 0714RY

PMA
Holographic Series
1-1/2" W x 3/4" H
Polylaminated
500/Roll



2015 • 0715HBE
2014 • 0714HBE



2015 • 0715HGN
2014 • 0714HGN



2015 • 0715HOR
2014 • 0714HOR



2015 • 0715HV
2014 • 0714HV



2015 • 0715HAQ
2014 • 0714HAQ



2015 • 0715HRD
2014 • 0714HRD



Acme 1-1/2" W x 3/4" H
Polylaminated
500/Roll • AC-3015



Patterson/Colwell 1" W x 1/2" H
500/Pkg • 0215VJTE



CI 1-1/8" W x 1/2" H
Polylaminated
500/Roll • PROP-A-15



Amerifile 1-1/2" W x 3/4" H
Polylaminated
500/Roll • 0715OR



Patterson/Colwell 1/2" W x 1" H
500/Pkg • 0215VJTT



CI 1-1/2" W x 3/4" H
Polylaminated
500/Roll • PROP-B-15



Ames 1-7/8" W x 1-7/8" H
Semi-Gloss
1000/Roll • 0815AMBK

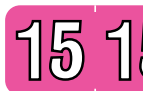

Patterson/Colwell 1-1/2" W x 3/4" H
500/Roll • 0715VJTE



Data File 1-1/4" W x 15/16" H
Polylaminated
500/Roll • DF-3015



Ames 1-3/4" W x 1/2" H
Semi-Gloss
1000/Roll • 0615AMBK



Col'R'Tab 1-1/2" W x 3/4" H
Polylaminated
500/Roll • 0715GD



Digicolor 1-5/8" W x 15/16" H
Polylaminated
500/Roll • DD-1015



Ames 1-1/2" W x 3/4" H
Polylaminated
500/Roll • AM-3015



Control-O-Fax 1-1/2" W x 3/4" H
Vinyl
500/Roll • 0715COF
270/RB Pkg • 0415COF



GBS System 10 1-3/4" W x 3/4" H
Polylaminated
250/Roll • AD1318-15



Barkley 1-1/2" W x 3/4" H
Polylaminated
500/Roll • 0715BE

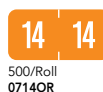

GBS/VRE 1-1/2" W x 3/4" H
Polylaminated
500/Roll • 0715BR



Jeter 1-1/2" W x 3/4" H
 Poly laminated
 500/Roll • 0715JBK
 270/RB Pkg • 0415JBK

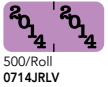

Jeter - R Series 1-1/2" W x 3/4" H
 Poly laminated
 500/Roll • 0715JRCP

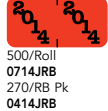

Jeter Proprietary 1-1/2" W x 3/4" H
 Poly laminated
 500/Roll • 0715JDGB
 270/RB Pkg • 0415JDGB

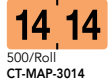

Medical Arts Press 1-1/2" W x 3/4" H
 Poly laminated
 500/Roll • MAP-3015

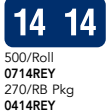

Reynolds & Reynolds 1-1/2" W x 3/4" H
 Poly laminated
 500/Roll • 0715REY
 270/RB Pkg • 0415REY

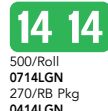

Safeguard 1-1/2" W x 3/4" H
 Poly laminated
 500/Roll • 0715LOR
 270/RB Pkg • 0415LOR



Sav-Tyme 1-1/2" W x 3/4" H
 Poly laminated
 500/Roll • ST-3015

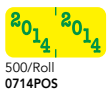

POS 1-1/2" W x 3/4" H
 Poly laminated
 500/Roll • 0715POS



POS 1-1/2" W x 1/2" H
 Vinyl
 500/Roll • 0615DGNV

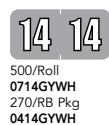

POS 1-1/2" W x 3/4" H
 Vinyl
 500/Roll • 0715DGNV
 270/RB Pkg • 0415DGNV



POS 1-1/2" W x 3/4" H
 Poly laminated
 500/Roll • 0715PGY

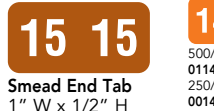

Smead End Tab 1" W x 1/2" H
 Poly laminated
 500/Roll • 0115BNE
 250/Pkg • 0015BNE



Smead Top Tab 1/2" W x 1" H
 Poly laminated
 500/Roll • 0115BNT
 250/Pkg • 0015BNT



Smead 1-1/2" W x 3/4" H
 Poly laminated
 500/Roll • SM-3015



Smead/Jeter 1-1/2" W x 3/4" H
 Poly laminated
 500/Roll • 0715SMBK



Spectrakode 1-3/4" W x 3/4" H
 Poly laminated
 250/Roll • AD1317-15



TAB 1-1/4" W x 3/4" H
 Vinyl
 500/Roll • 0715DGN



TAB 1-1/8" W x 1/2" H
 Vinyl
 500/Roll • 0615DGN



Tabbies 1-1/2" W x 3/4" H
 Poly laminated
 500/Roll • TA-3015



Traco 1-1/2" W x 3/4" H
 Poly laminated
 500/Roll • 0715ORBK
 270/RB Pkg • 0415ORBK

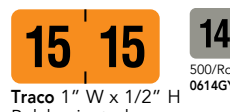

Traco 1" W x 1/2" H
 Poly laminated
 500/Roll • 0615ORBK

Print custom designed strip labels directly from your desktop! (page 83)



Month/Aging Color Coded Labels

Reynolds & Reynolds® RF Compatible

▶ 15000 Series
3/4" H x 1-1/2" W (Polylaminated)

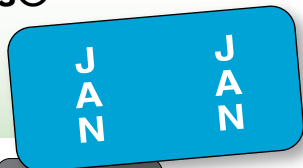

Rngbk 15031J
Roll 15061J

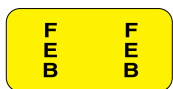

Rngbk 15032F
Roll 15062F



Rngbk 15033M
Roll 15063M



Rngbk 15034A
Roll 15064A



Rngbk 15035M
Roll 15065M



Rngbk 15036J
Roll 15066J



Rngbk 15037J
Roll 15067J



Rngbk 15038A
Roll 15068A



Rngbk 15039S
Roll 15069S



Rngbk 15040O
Roll 15070O



Rngbk 15041N
Roll 15071N



Rngbk 15042D
Roll 15072D

RINGBOOK (27 labels/sheet)

Individual Months (see label number) 270 labels

Complete Set 15059SET 3,240 labels

ROLL (500 labels/roll)

Complete Set 15089SET 6,000 labels

Jeter® Compatible

▶ 11000 Series 2015
15/16" H x 1-5/8" W
(Polylaminated)

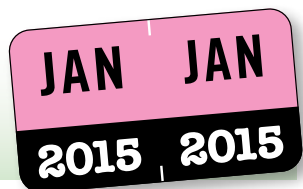

Pkg 11501J



Pkg 11502F



Pkg 11503M



Pkg 11504A



Pkg 11505M



Pkg 11506J



Pkg 11507J



Pkg 11508A



Pkg 11509S



Pkg 11510O



Pkg 11511N



Pkg 11512D

PACKAGE (225/Pkg)

Kit box - Item # BBOX
Index set - Item # JDINDEX

Individual Months (see label number) 225 labels

Starter Kit 115275K Box, indexes, 2,700 labels

Complete Set 11529SET 2,700 labels

Complete Set 11529MSET 216 labels



2014 Also Available

Sycom® 5918 Compatible

▶ 17000 Series
3/4" H x 1-1/2" W (Polylaminated)



Roll 17061J



Roll 17062F



Roll 17063M



Roll 17064A



Roll 17065M



Roll 17066J



Roll 17067J



Roll 17068A



Roll 17069S



Roll 17070O



Roll 17071N



Roll 17072D

ROLL (500 labels/roll)

Individual Months (see label number) 500 labels

Complete Set 17089SET 6,000 labels

TAB® 2379 Compatible

▶ 18600 Series
1/2" H x 1" W (Vinyl)



Roll 18601J



Roll 18602F



Roll 18603M



Roll 18604A



Roll 18605M



Roll 18606J



Roll 18607J



Roll 18608A



Roll 18609S



Roll 18610O



Roll 18611N



Roll 18612D

ROLL (500/Roll)

Individual Months (see label number) 500 labels

Complete Set 18689SET 6,000 labels

Data File® Compatible

▶ Data-MB Series
15/16" H x 1-1/4" W (Polylaminated)

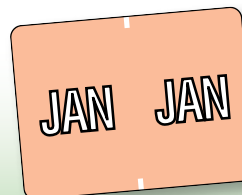

Pkg DATA-MB-JAN



Pkg DATA-MB-FEB



Pkg DATA-MB-MAR



Pkg DATA-MB-APR



Pkg DATA-MB-MAY



Pkg DATA-MB-JUN



Pkg DATA-MB-JUL



Pkg DATA-MB-AUG



Pkg DATA-MB-SEP



Pkg DATA-MB-OCT



Pkg DATA-MB-NOV



Pkg DATA-MB-DEC

PACKAGE (256/Pkg)

Dispenser tray for set - Item # Data-Box

Individual Months (see label number) 256 labels

Complete Set DATA-MB-ST 3,072 labels

Jeter® 9500/5300 Compatible

6000 Series
3/4" H x 1-1/2" W (Polylaminated)



| | | | |
|--|--|---|---|
|  Roll 6060BK |  Roll 6062BN |  Roll 6070LGN |  Roll 6064DGN |
|  Roll 6071OR |  Roll 6072PK |  Roll 6073P |  Roll 6076W |
|  Roll 6082LBE |  Roll 6080FOR |  Roll 6074R |  Roll 6077Y |
|  Roll 6061BE | Roll (500 labels/roll) Individual Colors (see label number) 500 labels Complete Set 6089SET 13 rolls, 6,500 labels | | |

Jeter® 5800/7100 Compatible

7600 Series
3/4" H x 1-1/2" W (Polylaminated)

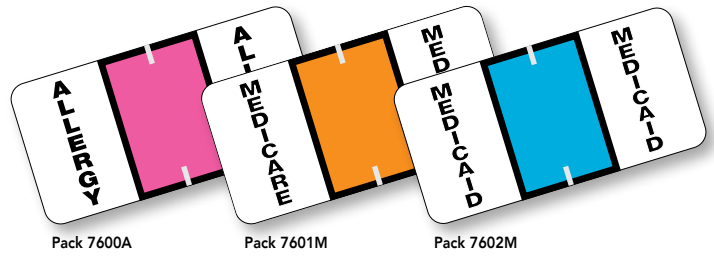





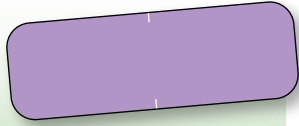

Pack 7600A Pack 7601M Pack 7602M

PACK (12 labels/sheet)
Individual Label (see number) 240 labels

Barkley® XBAM Compatible

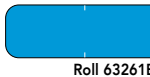
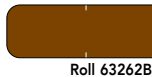
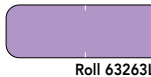
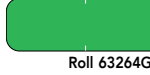
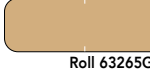
63200 Series XBAM Series
1/2" H x 1-1/2" W (Polylaminated)

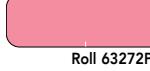

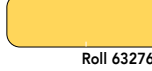
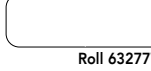







| | | | |
|--|---|---|--|
|  Roll 63260BK |  Roll 63261BE |  Roll 63262BN |  Roll 63263LV |
|  Roll 63264GN |  Roll 63265GD |  Roll 63266GY |  Roll 63271DOR |
|  Roll 63272PK |  Roll 63274R |  Roll 63276Y |  Roll 63277W |

ROLL (500 labels/roll)
Tray only for set - Item # D-10
Individual Colors (see label number) 500 labels
Complete Set 63289SET 12 rolls, display unit, 6,000 labels

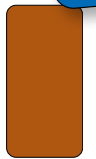
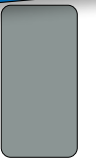
Smead® CC Compatible

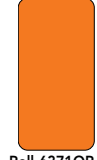
6300 Series
2" H x 1" W (Matte)

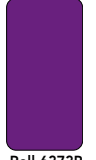

| | | | | |
|--|---|---|---|--|
|  Roll 6360BK |  Roll 6361BE |  Roll 6362BN |  Roll 6366GY |  Roll 6370LGN |
|  Roll 6371OR |  Roll 6372PK |  Roll 6373P |  Roll 6374R |  Roll 6377Y |

ROLL (250 labels/roll)
Individual Colors (see number) 250 labels
Complete Set 6389SET 2,500 labels

Data File® Compatible

Data-DL Series
11/16" H x 1-1/4" W (Polylaminated)

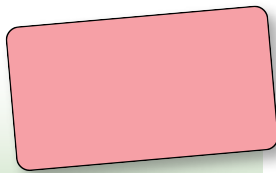









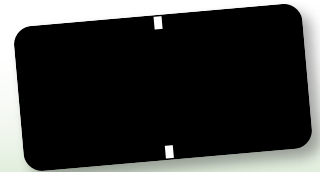



| | | | |
|---|--|--|--|
|  Roll DATA-DL-PK |  Roll DATA-DL-RD |  Roll DATA-DL-LO |  Roll DATA-DL-DO |
|  Roll DATA-DL-LG |  Roll DATA-DL-DG |  Roll DATA-DL-LB |  Roll DATA-DL-PR |
|  Roll DATA-DL-MV |  Roll DATA-DL-BR |  Roll DATA-DL-YL |  Roll DATA-DL-BK |
|  Roll DATA-DL-NY |  Roll DATA-DL-GY |  Roll DATA-DL-PG | |

ROLL (500 labels/roll)
Dispenser tray for set - Item # DT-13
Individual Colors (see label number) 500 labels
Complete Set DATA-DL-ST
15 rolls, 7,500 labels

TAB® Compatible

1281 Series
1/2" H x 1" W (Polylaminated)



| | | | |
|---|---|---|---|
|  Roll 1281-BL |  Roll 1281-BR |  Roll 1281-LB |  Roll 1281-DG |
|  Roll 1281-GY |  Roll 1281-DB |  Roll 1281-LG |  Roll 1281-OR |
|  Roll 1281-PK |  Roll 1281-PR |  Roll 1281-RD |  Roll 1281-YL |

ROLL (1,000 labels/roll) Dispenser tray for set - Item # DT-1
Individual Colors (see number) 1,000 labels
Complete Set 1281-ST 12,000 labels

Name & Mylar Protector Labels

7500 Series Clear Label Protectors

3-1/2" length protects name label only, and 8" length protects full tab.

| Item # | Qty | Dimensions Before Folding |
|------------|-----|---------------------------|
| 7500TP | 500 | 3-1/2" W x 1-3/4" H |
| 7510TP | 100 | 8" W x 1-3/4" H |
| 7550TP/500 | 500 | 8" W x 1-3/4" H |

Mylar Label Protectors

- Add durability
- Protect typed name labels from smudging
- Wraparound design
- Repair worn chart tabs or spines

Name Labels

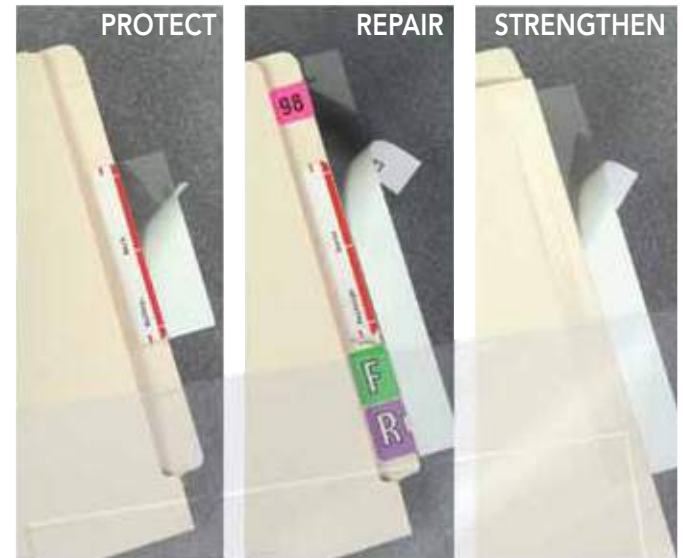

GBS® Compatible Name Labels

1920-ID Series
1-1/2" H x 3-1/8" W (Matte)

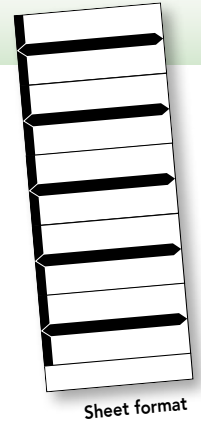
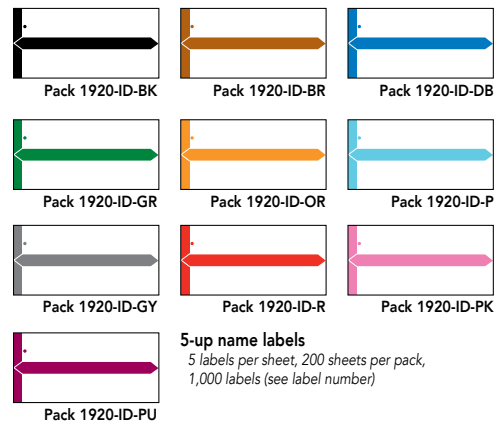

FASTFIX™ Folder Reinforcer

- ◀ PROTECT
- ◀ REPAIR
- ◀ SEAL
- ◀ STRENGTHEN

Applied label is 2-1 2" H x 10-5 8" W

- 1 Dispense just 1" of a FASTFIX™ label.
- 2 Place exposed adhesive onto the center of the folder spine and hold down with one hand.
- 3 Without holding the box use your other hand to pull the release strip (white paper) straight back. The box will follow and dispense one FASTFIX™ label.
- 4 Press firmly to secure. (Based on condition of the folder a label roller may be required for good adhesion.)



LNL Series

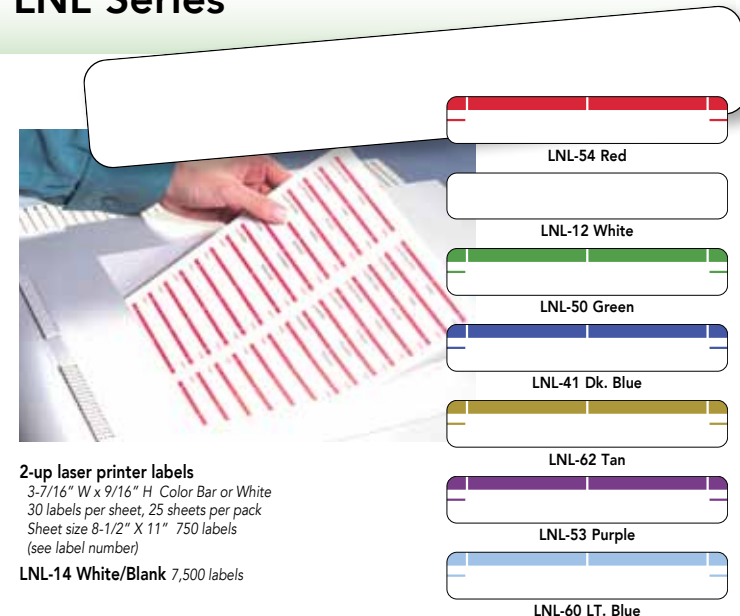

2-up laser printer labels
3-7/16" W x 9/16" H Color Bar or White
30 labels per sheet, 25 sheets per pack
Sheet size 8-1/2" X 11" 750 labels
(see label number)
LNL-14 White/Blank 7,500 labels

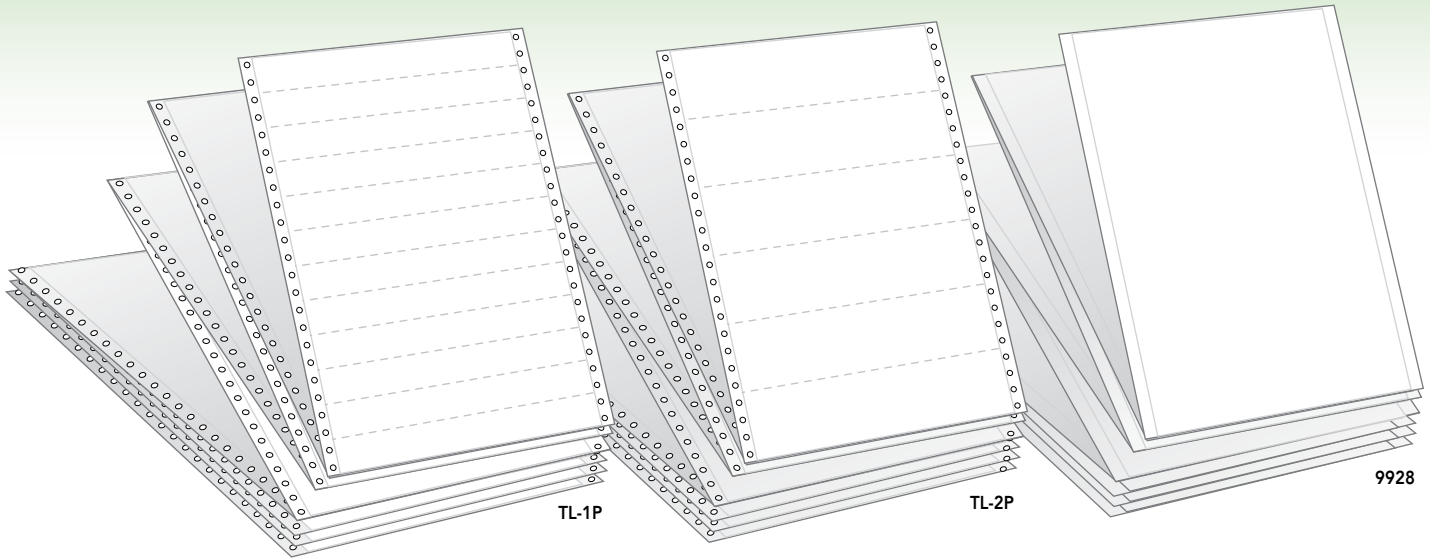

Fan-Folded w/Pinfeeds

(7-3/4" W label) 8-1/2" W x 12" H sheet

| Item # | Height | Color | Qty per pkg |
|--------|--------|-------|-------------|
| TL-1P | 1" | White | 2500 |
| TL-2P | 2" | White | 1250 |
| TL-12P | 12" | White | 209 |

Fan-Folded w/out Pinfeeds

(8" W label) 8-1/2" W x 12" W sheet

| Item # | Height | Color | Qty per pkg |
|--------|--------|-------|-------------|
| 3548 | 1" | White | 1000 |
| 3549 | 2" | White | 1000 |
| 9928 | 12" | White | 500 |

Laser Printer Sheets

(8" W label) 8-1/2" W x 11" H sheet

Perforated

| Item # | Height | Color | Qty per pkg |
|--------|--------|-------|-------------|
| 3426 | 1" | White | 1000 |
| 3427 | 2" | White | 1000 |
| 3421 | 11" | White | 100 |
| LTL-11 | 11" | White | 500 |

Quick-Peel

| Item # | Height | Color | Qty per pkg |
|--------|--------|-------|-------------|
| 27070 | 1" | White | 1000 |
| 27071 | 2" | White | 500 |
| 27072 | 3-1/2" | White | 300 |

Perforated Style

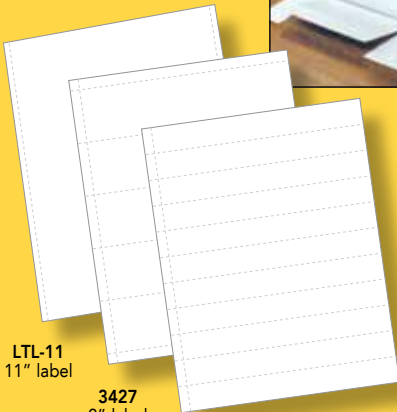

LTL-11
11" label

3427
2" label

3426
1" label

Quick-Peel Style



27070
1" label

27071
2" label

27072
3-1/2" label

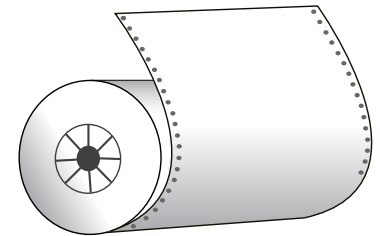

9934

Continuous Paper Roll

(8" W label) 8-1/2" W x 4800" long

| Item # | Height | Color | Qty |
|--------|-----------|-------|--------|
| 9934 | Full Roll | White | 400 ft |



Code A Print

Codeaprint.com puts you in charge of file-labeling systems from your very own desktop. Because it's web-based, there's no specialized label creation software to install. You don't need to worry about sensitive and confidential data leaving your computer. You can administer and control account access, and you're able to have an unlimited number of simultaneous users from as many computers as you need.

With codeaprint.com, you have the ability to print brilliant color-coded labels on-demand, complete with individualized bar codes and graphics. Match your existing systems, or customize with our help, then print on your laser or inkjet printer. It's as easy as 1-2-3!



1

Choose your label design

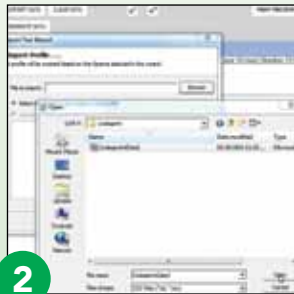

2

Enter or import your data



3

Print and affix your labels

What You Need:

- Internet access
- Your account license
- Codeaprint.com label stock
- Your label data
- Custom designed label (if required)
- Your printer

For more information regarding codeaprint.com, please contact us or visit www.codeaprint.com.

8" Folder Labels



FS68L - Laser
FS68WS - Ink Jet
1-1/2" x 8"
6 labels per sheet
50 sheets per package

4" Filing Labels

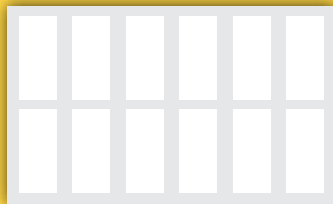

FS4L - Laser
FS4WS - Ink Jet
1-1/2" x 3-56.8/64"
12 labels per sheet
50 sheets per package

codeaprint.com

on-demand label printing

Refill labels for various Codeaprint.com label designs

Convert-A-Tab

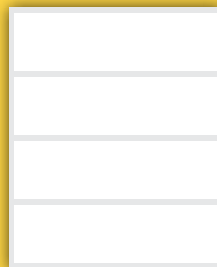

FSCVTL - Laser
FSCVTW - Ink Jet
8" x 2-5/8"
4 labels per sheet
50 sheets per package

7-11/16" Tab Match

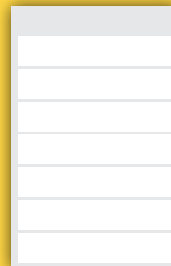

LZFS-78 - Laser
IJFS-78 - Ink Jet
7-11/16" x 1-11/16"
7 labels per sheet
350 labels total

8" Labels Smead Match

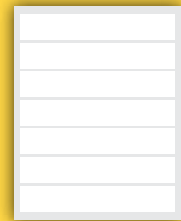

LZ7FS - Laser
IJ7FS - Ink Jet
8" x 1-7/16"
7 labels per sheet
350 labels total

ALLERGIC: _____

UL927 White/Red 5-1/2" x 1" (175/Roll)

ALLERGIES

MAP3220 FL. Red 2" x 2" (250/Roll)



ALLERGIES/DRUG REACTIONS

NO KNOWN ALLERGIES

MAP327 FL. Red 4" x 2-1/2" (100/Roll)

ALLERGIES

MAP1630 FL. Red 3-1/4" x 1-3/4" (250/Roll)

ALLERGIES

UL926 FL. Red 2-1/2" x 2-1/2" (390/Roll)

ALLERGIC TO:

- PENICILLIN
- CODEINE
- SULFA
- _____
- _____
- _____



MAP488 FL. Red 4" x 2-1/2" (100/Roll)

ALLERGIES/DRUG REACTIONS

NO KNOWN ALLERGIES

MAP1730 FL. Pink 3-1/4" x 1-3/4" (250/Roll)

ALLERGIC TO:

- PENICILLIN
- CODEINE
- SULFA
- _____
- _____
- _____

MAP4890 FL. Red 2" x 2" (250/Roll)

ALLERGIES

- LATEX
- DYE
- TAPE
- OTHER
- PENICILLIN
- CODEINE
- SULFA
- ERYTHROMYCIN
- NO KNOWN ALLERGIES

MAP3250 FL. Red 3-1/4" x 1-3/4" (250/Roll)

ALLERGIC TO:

- PENICILLIN
- CODEINE
- SULFA
- _____
- _____
- _____

MAP1550 FL. Chartreuse 3-1/4" x 1-3/4" (250/Roll)

NO KNOWN ALLERGIES

MAP1510 LT. Blue 1-1/2" x 7/8" (250/Roll)

ALLERGIC TO:

AG-1 FL. Orange 2-1/2" x 1-3/4" (500/Roll)

ALLERGIES

AG-3 FL. Orange 2-1/2" x 2-1/2" (500/Roll)

ALLERGIC TO:

AG-10 FL. Orange 1-5/8" x 15/16" (500/Roll)

ALLERGY ALERT:

AG-12 FL. Orange 1-5/8" x 15/16" (500/Roll)

ALLERGIC TO:

UL439 FL. Red 1-1/4" x 5/16" (500/Roll)

Allergy Warning Labels

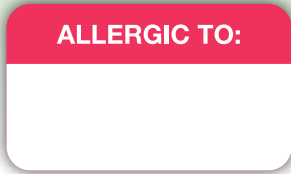

MAP1000 Red 1-1/2" x 7/8" (250/Roll)

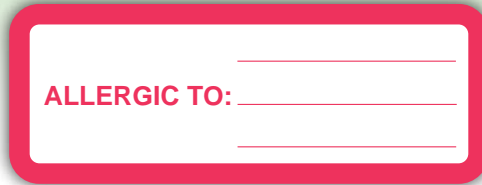

UL702 White/Red 3" x 1-1/8" (320/Roll)



MAP6260 Red 1-1/2" x 7/8" (250/Roll)



MAP3380 Red 1-1/2" x 7/8" (250/Roll)



MAP3240 FL. Red 3" x 1" (250/Roll)



UL810 White/Red 2-1/4" x 7/8" (420/Roll)



UL180 FL. Red 1-5/8" x 7/8" (500/Roll)



MAP4930 FL. Red 1-1/2" x 7/8" (250/Roll)



SS16 FL. Red 1-7/8" x 3/4" (500/Roll)

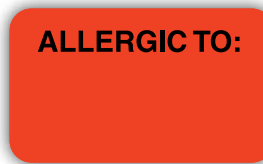

MAP3390 FL. Red 1-1/2" x 7/8" (250/Roll)



UL808 FL. Red 2-1/4" x 7/8" (420/Roll)



MAP3300 Red 3-1/4" x 1-3/4" (250/Roll)



MAP6430 Red 3" x 1" (250/Roll)



MAP3290 Red 3" x 1" (250/Roll)

Chart Labels



MAP252 Green 6-1/2" x 1" (100/Roll)

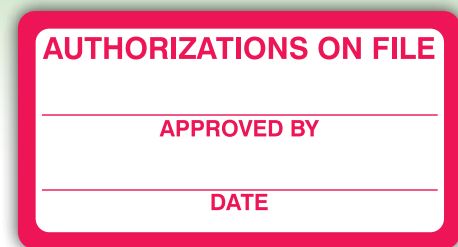

MAP6880 Red 3-1/4" x 1-3/4" (250/Roll)

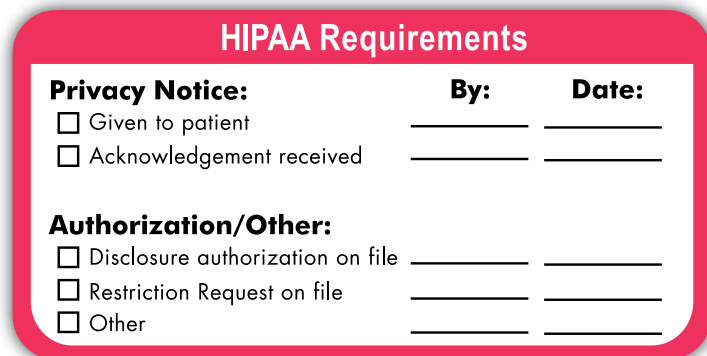

MAP7130 FL. Red 4" x 2" (250/Roll)



MAP255 Green 2" x 2" (500/Roll)



MAP254 Red 2" x 2" (500/Roll)

ADVANCE DIRECTIVE
 _____ Yes _____ No
 Signature _____ Date _____

UL588 FL. Green 2-1/4" x 7/8" (420/Roll)

Blank green label

MAP500 FL. Green 2-1/2" x 3/4" (300/Roll)

NAME ALERT
 Date of Birth _____
NAME ALERT

MAP3110 Blue 3" x 1" (250/Roll)

ATTENTION:

MAP1010 Red 1-1/2" x 7/8" (250/Roll)

MEDICAL ALERT:

MAP1600 Red 1-1/2" x 7/8" (250/Roll)

NOTE:

MAP1660 Red 1-1/2" x 7/8" (250/Roll)

NAME ALERT
 Birthdate _____

AG-16 FL. Orange 1-5/8" x 15/16" (500/Roll)

CONFIDENTIAL

AG-17 FL. Orange 1-5/8" x 15/16" (500/Roll)

DIABETIC

MAP3530 FL. Pink 1-1/2" x 7/8" (250/Roll)

PREMEDICATE

MAP2490 Red 1-1/2" x 7/8" (250/Roll)

X-RAYS
 Handle with Care

MAP2410 FL. Red 1-1/2" x 7/8" (250/Roll)

NAME ALERT
 Two patients with same name

MAP1050 FL. Chartreuse 1-1/2" x 7/8" (250/Roll)

NAME ALERT
 Birthdate _____

MAP1180 FL. Red 1-1/2" x 7/8" (250/Roll)

SEE HEALTH HISTORY

MAP2480 Red 1-1/2" x 7/8" (250/Roll)

HEALTH HISTORY UPDATE

| | |
|--|--|
| | |
| | |
| | |
| | |
| | |

MAP3570 FL. Green 1-1/2" x 7/8" (250/Roll)

2015 Authorization On File

MAP7215 FL. Orange 1-1/2" x 7/8" (500/Roll)

2014 Authorization On File

MAP7214 FL. Red 1-1/2" x 7/8" (500/Roll)

2015 Authorizations On File

MAP675 FL. Orange 1-1/4" x 5/16" (500/Roll)

2014 Authorizations On File

MAP674 FL. Red 1-1/4" x 5/16" (500/Roll)

CONFIDENTIAL

AG-5 FL. Orange 2-1/2" x 1" (500/Roll)

ADVANCE DIRECTIVES

AG-6 FL. Orange 2-1/2" x 1" (500/Roll)

NAME ALERT

AG-7 FL. Orange 2-1/2" x 1" (500/Roll)

PREMEDICATE

MAP344 FL. Pink 1-1/4" x 5/16" (500/Roll)

MEDICAL ALERT

MAP164 FL. Red 1-1/4" x 5/16" (500/Roll)

Blank pink label with horizontal lines

UL849 FL. Pink 2-1/4" x 2-3/8" (45/Pack)

Blank yellow label with horizontal lines

UL843 Yellow 2-1/4" x 2-3/8" (45/Pack)

Use an attractive sign-in sheet to keep track of patient attendance (page 94)

Chart Labels

Medical Alert

AG-24 FL. Orange
1-5/8" x 3/4" (500/Roll)

Signed Acknowledgement of Notice of Privacy Practices on File

MAP710 FL. Blue
2" x 1" (500/Roll)

Name Alert
Two patients
With the same name

AG-50 FL. Yellow
1-5/8" x 3/4" (500/Roll)

MEDICAL ALERT

AG-2 FL. Orange
2-1/2" x 1-3/4" (500/Roll)

ALERTS

| | |
|--|--|
| <input type="checkbox"/> DIABETIC | <input type="checkbox"/> NAME ALERT |
| <input type="checkbox"/> HEART CONDITION | <input type="checkbox"/> IMPLANTS |
| <input type="checkbox"/> ON ANTICOAGULANTS | <input type="checkbox"/> PREMEDICATE |
| <input type="checkbox"/> COUMADIN PATIENT | <input type="checkbox"/> HEARING IMPAIRED |
| <input type="checkbox"/> PACEMAKER | <input type="checkbox"/> ADVANCE DIRECTIVE |
| <input type="checkbox"/> NO EPINEPHRINE | <input type="checkbox"/> OTHER |
| <input type="checkbox"/> MITRAL VALVE PROLAPSE | |

MAP3400 FL. Chartreuse
3-1/4" x 1-3/4" (250/Roll)

ASTHMA

AG-4 FL. Orange
2-1/2" x 2-1/2" (500/Roll)

CONFIDENTIAL
For Authorized Personnel Only

CC-281 FL. Orange
2-1/2" x 2-1/2" (500/Roll)

CONFIDENTIAL
For Authorized Personnel Only

MAP251 Red 6-1/2" x 1" (100/Roll)

PRIVACY RESTRICTIONS

- DO NOT PHONE AT HOME
- DO NOT PHONE AT WORK
- SEND ALL MAIL TO ALTERNATIVE ADDRESS
- RESTRICT INFORMATION TO INDIVIDUALS
- DO NOT LEAVE MESSAGES ON ANSWERING MACHINE
- DO NOT MAIL REMINDER CARDS
- DO NOT CONTACT BY E-MAIL
- OTHER PRIVACY REQUEST

CC-303 FL. Orange 3-1/4" x 2" (500/Roll)

HIPPA PRIVACY ALERTS

_____(date) Acknowledgement of NPP on file

_____(date) Restrictions on file

_____(date) Confidential communications on file

_____(date) Amendments on file

CC-304 FL. Green 3-1/4" x 2" (500/Roll)

ADVANCE DIRECTIVE

Living Will _____

Health Care Proxy _____

Durable Power of Attorney
for Health Care _____

Other _____

MAP3500 FL. Orange 3-1/4" x 1-3/4" (250/Roll)

MEDICAL HISTORY UPDATE

| | | |
|--|--|--|
| | | |
| | | |
| | | |
| | | |
| | | |
| | | |

MAP3600 FL. Chartreuse 3-1/4" x 1-3/4" (250/Roll)

MEDICAL ALERT







MAP3420 White/Red 3-1/4" x 1-3/4" (250/Roll)

MEDICAL ALERT

MAP5180 FL. Red 3-1/4" x 1-3/4" (250/Roll)

6200 Series Transition Labels
Easily mark and identify the status of files, documents and records.

- Poly laminated
- Permanent adhesive
- 3/4" H x 1-1/2" W overall size
- 500/Roll
- Convenient dispenser box

| | |
|---|---|
|  |  |
| 6201RD SHRED | 6202YL STORE |
|  |  |
| 6204LBE SCAN | 6205OR ACTIVE |
|  |  |
| 6203LGN KEEP | 6206BLK INACTIVE |

MEDICAL ALERT

MEDICAL ALERT

MAP6270 Red 3" x 1" (250/Roll)

ATTENTION

ATTENTION

MAP3200 Red 3-1/4" x 1-3/4" (250/Roll)

Insurance Chart Labels

INSURANCE PROVIDER:

MAP1110 White/Red
1-1/2" x 7/8" (250/Roll)

ATTENTION OFFICE STAFF:
CO-PAY

\$ _____
Collect at time of visit

MAP1310 FL. Red
1-1/2" x 7/8" (250/Roll)

CO-PAY

MAP2890 FL. Orange
1-1/2" x 7/8" (250/Roll)

INSURANCE

MAP2840 FL. Red
1-1/2" x 7/8" (250/Roll)

REFERRAL NEEDED

MAP1170 FL. Pink
1-1/2" x 7/8" (250/Roll)

MEDICARE

MAP1160 FL. Orange
1-1/2" x 7/8" (250/Roll)

MEDICAID

MAP1340 FL. Pink
1-1/2" x 7/8" (250/Roll)

REFERRING PHYSICIAN

MAP5340 FL. Pink
1-1/2" x 7/8" (250/Roll)

ATTENTION OFFICE STAFF:
CO-PAY

\$ _____
Collect at time of visit

AG-21 FL. Orange
1-5/8" x 15/16" (500/Roll)

SELF PAY

MAP123 FL. Green
1-1/4" x 5/16" (500/Roll)

INSURANCE

MAP119 FL. Red
1-1/4" x 5/16" (500/Roll)

INSURANCE

MAP1570 FL. Red 3-1/4" x 1-3/4" (250/Roll)

INSURANCE

MAP2830 FL. Pink 3-1/4" x 1-3/4" (250/Roll)

Medicare Worker Comp.
 Medicaid Self Pay
 BC/BS Auto
 United Healthcare Kaiser
 Aetna CIGNA
 Other _____

MAP2940 FL. Chartreuse 3-1/4" x 1-3/4" (250/Roll)

INSURANCE PROVIDER

INSURANCE PROVIDER

MAP5190 Blue 3-1/4" x 1-3/4" (250/Roll)

INSURANCE

INSURANCE

MAP6420 FL. Pink 3" x 1" (250/Roll)

ATTENTION OFFICE STAFF:
CO-PAY

\$ _____
Collect at time of visit

CO-PAY

MAP6460 FL. Red 3" x 1" (250/Roll)

Collection - Billing/Reminder Labels

If Payment is Not Received
By _____ Account
Will Be Forwarded For
Collection

UL529 FL. Green 2-1/4" x 7/8" (420/Roll)

Our records still show that you have not cleared your overdue account. If payment is not possible now, please let us hear from you so that we won't have to take further action.

UL1400 FL. Chartreuse 3" x 7/8" (320/Roll)

 **WE HATE TO KEEP HOUNDING YOU, BUT YOUR BILL IS PAST DUE.**

UL520 FL. Pink 2-1/4" x 7/8" (420/Roll)

FINAL NOTICE

Your payment must be received within 10 days

OR IMMEDIATE ACTION WILL BE TAKEN.

MAP4460 FL. Red 3" x 1" (250/Roll)

YOUR INSURANCE COMPANY HAS PAID ITS SHARE OF YOUR BILL.

This statement is for the amount payable directly by you.

MAP4470 FL. Orange 3" x 1" (250/Roll)

FRIENDLY REMINDER

Please check your records. We have not received your payment and a check would be appreciated.

MAP4440 FL. Pink 3" x 1" (250/Roll)

THIS BALANCE IS OVERDUE!

Prompt payment will avoid collection procedures.

MAP5820 FL. Green 3" x 1" (250/Roll)

FINAL NOTICE

This is the last statement that will be sent to you. Unless paid at once, this account will be reported to the CREDIT BUREAU.

MAP5810 FL. Orange 3" x 1" (250/Roll)

WE ACCEPT MAJOR CREDIT CARDS

To pay with your credit card please complete:

Acct. No. _____
 VISA _____ MasterCard _____ American Ex _____ Discover _____
 Exp. Date _____ Signature _____

MAP5790 FL. Chartreuse 3" x 1" (250/Roll)

Collection - Billing/Reminder Labels

PAST DUE
Please remit TODAY!

MAP1350 FL. Red
1-1/2" x 7/8" (250/Roll)

Just a friendly reminder
that your account is overdue. Won't you please mail your remittance?

MAP4220 FL. Green
1-1/2" x 7/8" (250/Roll)

IF YOU ARE UNABLE TO PAY IN FULL
PLEASE SEND A PARTIAL PAYMENT

MAP2020 FL. Pink
1-1/2" x 7/8" (250/Roll)

THIS BALANCE IS OVERDUE!
Prompt payment will avoid collection procedures.

MAP4490 FL. Red
1-1/2" x 7/8" (250/Roll)

ACCOUNT OVERDUE!
Please remit payment in full or call for a payment plan.

MAP1380 FL. Pink
1-1/2" x 7/8" (250/Roll)

THANK YOU for your recent payment on your account. We trust you will continue these remittances until the account is paid in full.

MAP4210 FL. Pink
1-1/2" x 7/8" (250/Roll)

WE MISSED YOUR MONTHLY PAYMENT
Won't you please send it in now?

MAP4320 FL. Chartreuse
1-1/2" x 7/8" (250/Roll)

PLEASE NOTE
This account is PAST DUE.
Your prompt attention is courteously requested.

MAP4500 FL. Chartreuse
1-1/2" x 7/8" (250/Roll)

MAY WE HELP YOU?
We are willing to make arrangements for regular payments to clear up this balance. Please call or stop in today.

MAP4290 FL. Pink
1-1/2" x 7/8" (250/Roll)

SECOND NOTICE
Have you overlooked our first statement? Please remit the payment or contact our office to make arrangements.

MAP4540 FL. Orange
1-1/2" x 7/8" (250/Roll)

FINAL NOTICE
This is the last statement that will be sent to you. Unless paid at once the account will be turned over for collection.

MAP1360 FL. Red
1-1/2" x 7/8" (250/Roll)

Regular payments must be made every month in order to maintain good credit.

MAP4260 FL. Pink
1-1/2" x 7/8" (250/Roll)

FINAL NOTICE
Your payment must be received within 10 days or your account will be reported to the CREDIT BUREAU.

MAP5690 FL. Red
1-1/2" x 7/8" (250/Roll)

FRIENDLY REMINDER
This account is past due. Your prompt attention is courteously requested.

MAP4250 FL. Orange
1-1/2" x 7/8" (250/Roll)

Past Due
PLEASE REMIT TODAY

AG-27 FL. Orange
1-5/8" x 3/4" (250/Roll)

Thank You!

MAP4300 FL. Chartreuse
1-1/2" x 7/8" (250/Roll)

THANK YOU!
Your prompt payment is appreciated

MAP4240 LT. Blue
1-1/2" x 7/8" (250/Roll)

SECOND NOTICE
This account is past due. Please remit payment today. If payment has been made, please disregard this notice.

MAP2170 FL. Pink
1-1/2" x 7/8" (250/Roll)

YOUR ACCOUNT IS PAST DUE.
We would appreciate your payment today!

MAP4480 FL. Red
1-1/2" x 7/8" (250/Roll)

Designer Collection and Insurance Labels

Catch your clients' eyes with these brightly colored designer labels. 1-1/2" x 1-1/2" (250/Roll)

FINAL NOTICE!
This is the last statement that will be sent to you. Unless paid at once the account will be turned over for collection.

MAP5920 Purple/Black

Your insurance company has already paid its share of your bill.
THIS STATEMENT IS FOR THE AMOUNT YOU OWE

MAP5910 Orange/Black

JUST A FRIENDLY REMINDER . . .
that your account is overdue. Won't you please mail your remittance?

MAP5980 Purple/Black

YOUR ACCOUNT IS PAST DUE!
We would appreciate your payment today!

MAP6740 Orange/Black

PAST DUE
Please remit today!

MAP5940 Teal/Black

YOUR INSURANCE COMPANY HAS PAID ITS SHARE OF YOUR BILL.
This statement is for the amount payable directly by you.

MAP6720 Teal/Black

SECOND NOTICE
Have you overlooked our first statement? Please remit the payment or contact our office to make arrangements.

MAP6020 Orange/Black

ACCOUNT SERIOUSLY OVERDUE
Remit payment in full to prevent collections.

MAP6030 Purple/Black

No Appointments can be made until the balance shown on this statement is paid.

MAP6760 Purple/Black

Credit Card Labels

Inform clients about payment options and watch your accounts receivables improve.

THIS BALANCE MAY BE TRANSFERRED TO YOUR
 OR 
JUST CALL US

MAP4630 FL. Chartreuse
1-1/2" x 7/8" (250/Roll)





COLLECTION

MAP1070 FL. Red
1-1/2" x 7/8" (250/Roll)

MISSED APPOINTMENT
ON

MAP2370 FL. Pink
1-1/2" x 7/8" (250/Roll)

For your convenience, you may transfer this balance to your credit card account. To pay with your credit card, please complete the information below:

Acct. No. _____ Exp. Date _____
Amount _____ Signature _____

MAP2350 FL. Orange 3-1/4" x 1-3/4" (250/Roll)

Collection - Billing/Reminder Labels

Jumbo Collection Labels

Open the lines of communication! These attention-getting labels can help prompt clients to take the appropriate steps regarding their account.

FINAL NOTICE

This is the last statement that will be sent to you. Unless paid at once your account will be referred to the credit bureau and collection service.

MAP4820 FL. Red 3-1/4" x 1-3/4" (250/Roll)

CAUTION:

Your account is now 90 days PAST DUE.
Pay now and avoid collection action.

MAP4840 FL. Red 3-1/4" x 1-3/4" (250/Roll)

ATTENTION:

Your account is now 60 days PAST DUE.
Please send all back payments today.

MAP4850 FL. Pink 3-1/4" x 1-3/4" (250/Roll)

Collection - Insurance/Patient Responsibility

YOUR INSURANCE COMPANY HAS PAID ITS SHARE OF YOUR BILL.
This statement is for the amount payable directly by you.

MAP3690 FL. Red 1-1/2" x 7/8" (250/Roll)

YOUR BALANCE DUE TO:
 Your Deductible
 Non-Covered Services
 Co-Pay
\$ _____

MAP3720 FL. Chartreuse 1-1/2" x 7/8" (250/Roll)

This statement is for your information.
YOUR INSURANCE CLAIM HAS BEEN BILLED.

MAP3730 LT. Blue 1-1/2" x 7/8" (250/Roll)

INSURANCE PENDING
\$ _____
AMOUNT DUE NOW
\$ _____

MAP3750 FL. Orange 1-1/2" x 7/8" (250/Roll)

YOUR INSURANCE COMPANY HAS ALREADY PAID ITS SHARE OF YOUR BILL.
This statement is for the amount you owe.

MAP2200 FL. Orange 1-1/2" x 7/8" (250/Roll)

Your insurance covered all but the amount shown on this statement. May we please have your remittance by return mail.

MAP3770 FL. Green 1-1/2" x 7/8" (250/Roll)

Your insurance company has sent YOU payment of its share of this bill...
YOUR ACCOUNT IS NOW DUE AND PAYABLE.

MAP4100 FL. Orange 1-1/2" x 7/8" (250/Roll)

ALL INSURANCE CLAIMS HAVE BEEN PAID

MAP3890 LT. Blue 1-1/2" x 7/8" (250/Roll)

REMINDER

- Your insurance has paid its share.
- This is the amount that you owe.
- Please remit TODAY!

MAP5620 FL. Green 3-1/4" x 1-3/4" (250/Roll)

PATIENT RESPONSIBILITY DUE TO:

- Deductible
- Non-Covered Services
- Too Many Services in Time Period
- Maximum Benefit Allowed Reached
- Co-Payment

PLEASE REMIT \$ _____ AS SOON AS POSSIBLE

MAP4180 FL. Red 3-1/4" x 1-3/4" (250/Roll)

YOUR INSURANCE COMPANY has paid its share of your bill.

This statement is for the amount payable directly by you.

MAP4200 FL. Pink 3-1/4" x 1-3/4" (250/Roll)

We Have Not Been Paid On This Claim Because Your Insurance Company:

- Sent payment to you
- Applied these charges to your deductible
- Does not cover this service
- Has not yet received the information requested from you
- Terminated your coverage on _____
- Other _____

Please remit in full or call to arrange a payment schedule.

MAP1560 FL. Chartreuse 3-1/4" x 1-3/4" (250/Roll)

Insurance Carrier Collection Labels

Unless this claim is paid or denied within 30 days of this date, we will file a formal written COMPLAINT with the INSURANCE COMMISSIONER
Date: _____

MAP2640 FL. Red 1-1/2" x 7/8" (250/Roll)

Submitting for secondary coverage.
SEE ATTACHED PLEASE

MAP2660 FL. Pink 1-1/2" x 7/8" (250/Roll)

RESUBMISSION:
This is not a duplicate billing. This claim has either been denied or never received. Please consider for benefits or instruct if patient owes.

MAP2680 FL. Chartreuse 1-1/2" x 7/8" (250/Roll)

PLEASE PAY PROVIDER
Insured signature on file

MAP6150 FL. Orange 1-1/2" x 7/8" (250/Roll)

CORRECTIVE CLAIM

MAP1460 FL. Pink 1-1/2" x 7/8" (250/Roll)

DOCUMENTATION ATTACHED DO NOT SEPARATE FROM CLAIM

MAP2650 FL. Green 1-1/2" x 7/8" (250/Roll)

PRIMARY EOB ATTACHED

MAP1480 FL. Green 1-1/2" x 7/8" (250/Roll)

Medical Charting Systems

MAKE YOUR PRACTICE MORE EFFICIENT: BUILD YOUR OWN MEDICAL SYSTEM!

You'll never have to spend staff time putting together the perfect chart system again. **We'll do it for you!**

- Choose a folder
- Add forms and fasteners
- Include pockets, index tabs, or other accessories

We'll take care of assembly, and you can begin using your efficient new charts as soon as they hit your doorstep.

Sold in quantities of 100.



29011 (100/pkg)

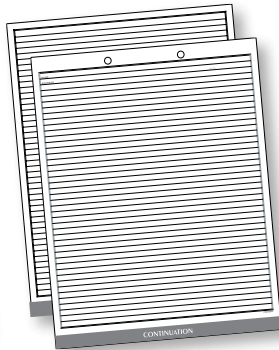

29014 (100/pkg)

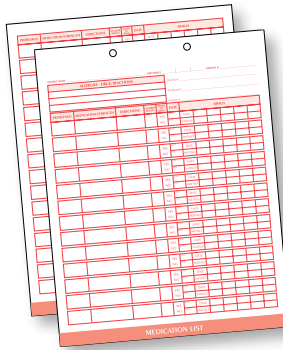

29015 (100/pkg)

Individual Forms

Available in packages of 100

Health History Form - (29011)

Used to gather detailed patient and family medical history. The yes/no format makes it easy for patients to complete.

Continuation Sheet - (29014)

For recording patient visits, phone calls and other aspects of patient care.

Medication List Form - (29015)

A vital record of previous and current patient medications on one handy form for quick reference.

Clinical Data Forms

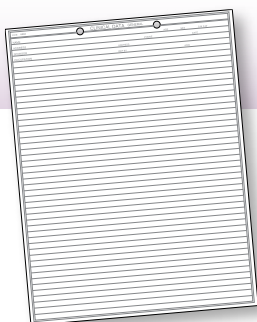

CF8288
Clinical Data Form
with holes (100/pkg)

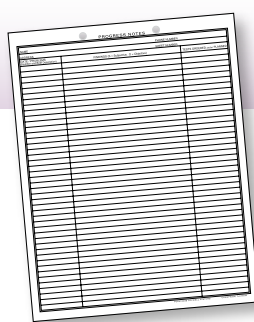

CF8045
Progress Notes
2 sides with holes (100/pkg)

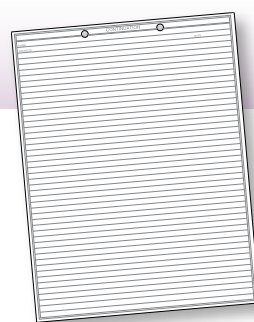

CF8290
Continuation Form
with holes (100/pkg)



CF8111
Continuation Form
without holes (100/pkg)

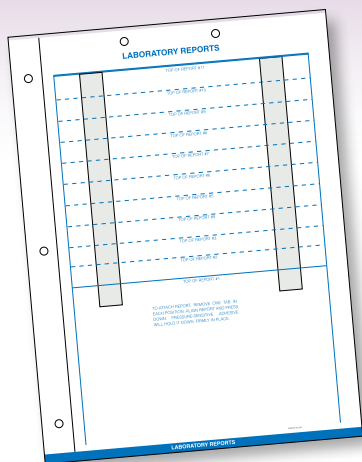

CF8051
Laboratory Reports
(100/pkg)



CF3097
Telephone Messages
(100/pkg)



CF13415
Prescriptions
(100/pkg)

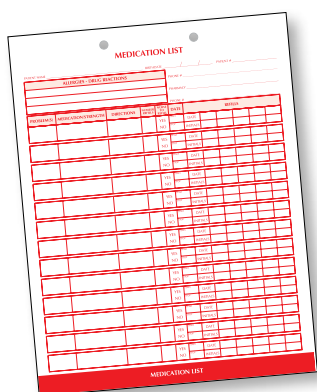

CF16655
Medications List
2 Sides (100/pkg)

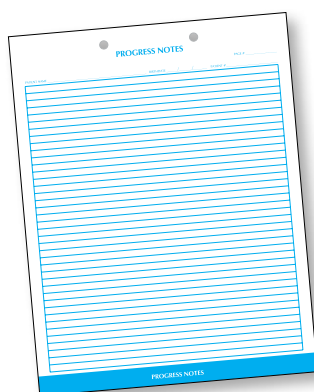

CF16653
Progress Notes
2 Sides (100/pkg)

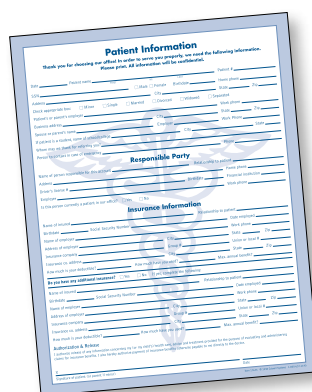

CF17634
Patient Information
(100/pkg)



CF16302
Welcome - Patient Reg
(100/pkg)

HCFA Forms

HCFA Approved Medical Insurance Forms

All forms are government approved HCFA-1500 to serve federal programs and private insurers as a universal claim form. The 2-part form is carbonless. (Revision 02-12)

| Stock No. | Description | Carton Qty |
|-----------|-------------------|------------|
| 79109QR | Cut Sheet | 1000 |
| 79120QR | 2-Part Continuous | 1000 |

Submission Envelopes

The window placement is specifically designed to have the insurance carrier's name and address show through the window (provided your computer prints out the insurance carrier's name and address in the upper right-hand corner.)

Available in regular moist & seal or convenient self-seal, both have security interior tint. Right hand window.

HC10RG: Regular (9-1/2" x 4-1/8") Blank (500/box)

HC10SS: Self-Seal (9-1/2" x 4-1/8") Blank (500/box)

Jumbo insurance envelope is designed to accommodate up to 50 insurance claims to the same carrier.

HC912: Side-Seal HCFA Envelopes (9" x 13") (100/pkg)

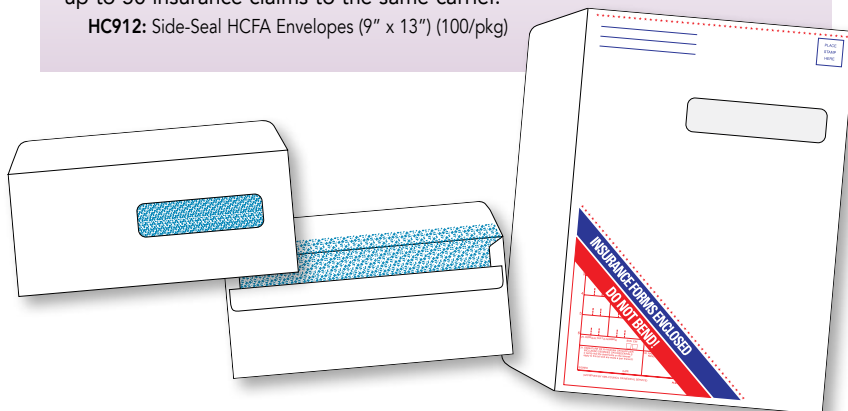

Dental Charting System

A PREASSEMBLED DENTAL SYSTEM MAKES YOUR PRACTICE MORE EFFICIENT!

The Complete Dental System

Our popular, preassembled chart contains all the necessary forms a dental office needs, and costs less than purchasing each separately.

Each preassembled chart includes:

- Durable 11pt pocket folder (#MPFA-10) with 2" bonded fastener; an MSDA-11 file divider with a twin prong fastener; and a 5-mil poly pocket 8-3/4" W x 5-1/2" H.
- Eight (8) clinical forms



26999 - Complete Chart
(25/box)

Patient Registration – (27000)
gathers complete personal, billing, and insurance information.

Recall Examination – (27002)
updates health information, exam history, x-ray history, hygiene instructions and more at subsequent visits.

Progress Notes – (27003)
columns record tooth, anesthetic given and treatment documentation. 2 sides.

Health History Update – (27004)
documents changes in health or medication.

Correspondence Log – (27006)
tracks correspondence sent or received by the office.

Clinical Examination – (27007)
documents patient's first visit, including chief complaint and existing or previous condition.

Treatment Plan with Chart – (27009)
records exam on a diagram with additional space to document treatment plans and completion dates.

Health History– (27011)
detailed medical and dental condition questions, previous dental treatments and more. 2 sides.

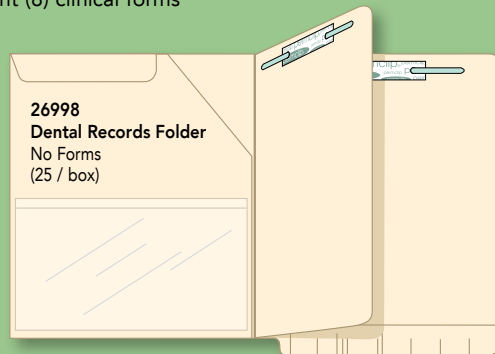

Individual forms available in packages of 100.

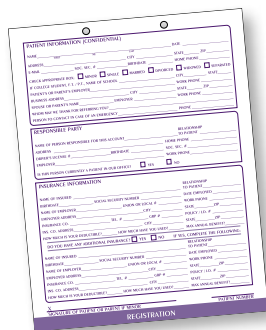

27000
(100/pkg)

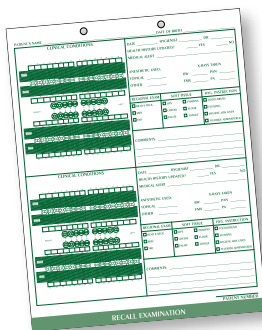

27002
(100/pkg)



27003
(100/pkg)

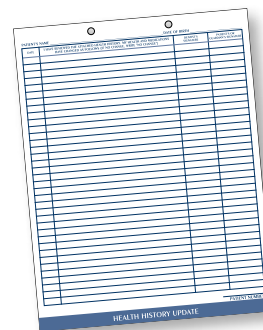

27004
(100/pkg)

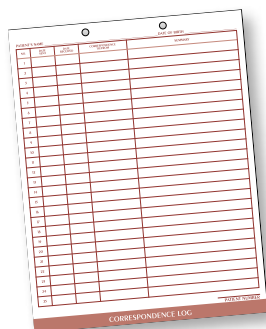

27006
(100/pkg)

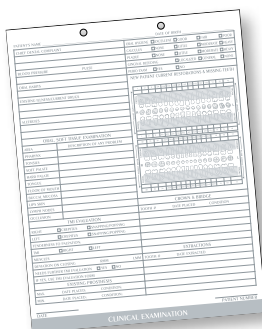

27007
(100/pkg)

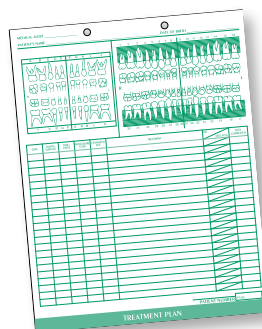

27009
(100/pkg)

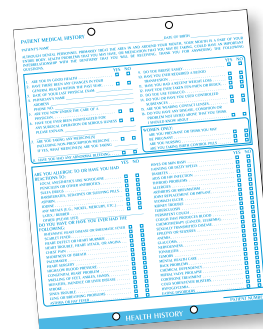

27011
(100/pkg)

DF9444 Four-Page Medical/ Dental Records
 Overall size: 11" x 17"
 Page size: 8-1/2" x 11" folded (50/PKG)

DF9123 80# Offset Opaque (100/PKG)
DF9124 100# Index Stock (100/PKG)

DF9420 80# Offset Opaque (100/PKG)
DF9460 100# Index Stock (100/PKG)

DF1429 Examination Slips
 5-1/2" x 3-1/2", 20# offset, 100 slips per pad,
 5 pads per box. Printed in green ink.

DF9152 80# Offset Opaque (100/PKG)

DF0420 Patient Records
 Folds to 5" x 8", 80# offset opaque (100/PKG)
 Printed in green ink.

SIGN-IN SHEETS (HIPAA APPROVED)

14037 Salmon
(250/pkg)

18229 Green
(250/pkg)

18228 Blue
(250/pkg)

17017 Fish
(100/pkg)

17014 Toothbrush
(100/pkg)

17008 Smile
(100/pkg)

Reminder Cards

Dazzling Designs! Easy to Print! Cost Effective!

Laser Recall Cards Provide the Ultimate Flexibility for Communication with Patients

Choose from a wide variety of vibrant graphics and attention grabbing designs

- Standard 8-1/2" X 11" stock feeds smoothly through laser printers
- Cards are blank on one side allowing for customized messages and practice information
- Each sheet has four 4-1/4" x 5-1/2" cards, micro-perforated for easy separation
- Sold in 25 sheet packages (100 cards)

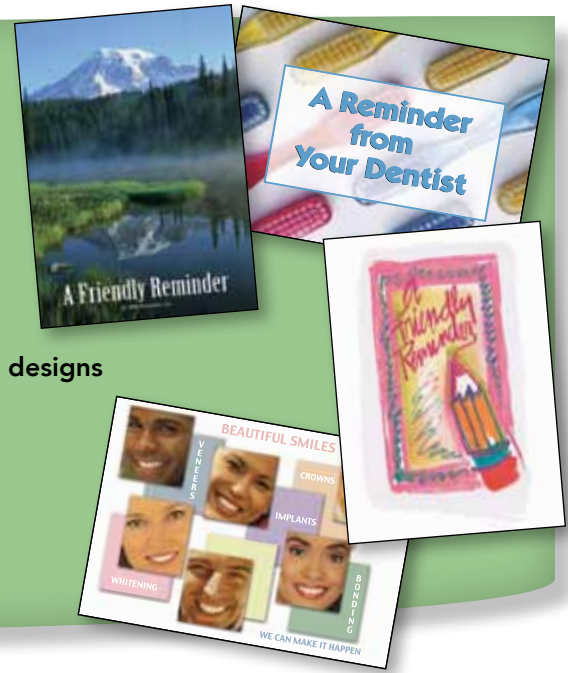

Cartoons

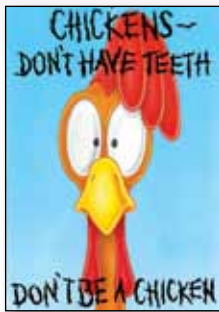

RC124

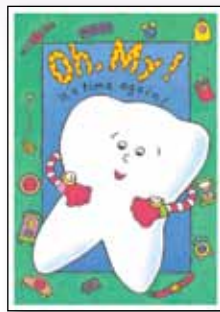

RC126



RC182



RC172



RC122

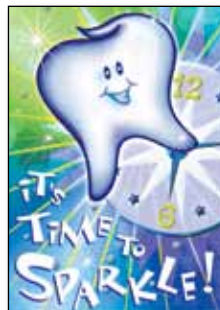

RC102

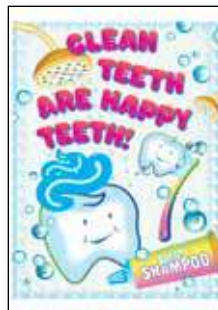

RC140



RC143

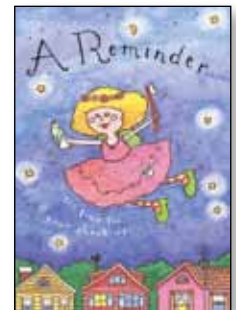

RC113

Toothbrushes



RC161



RC101

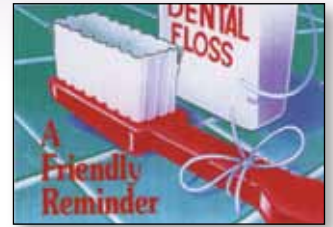

RC111



RC141



RC166



RC137



RC170



RC108

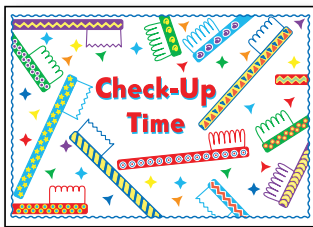

RC150



RC173



RC160



RC100



RC131

Reminder Cards

Designer



RC144



RC114

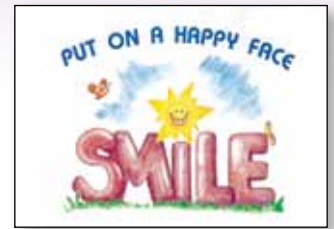

RC154



RC169



RC129



RC156



RC157



RC110 - Time for Checkup



RC147

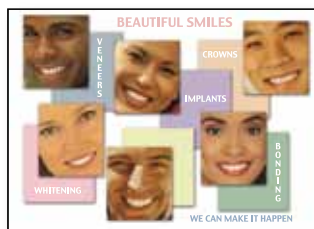

RC162



RC136 - Reminder from Hygienist

Designer



RC148



RC167



RC151



RC152



RC177



RC104



RC175



RC119

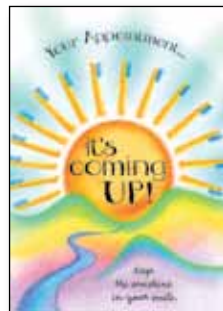

RC105



RC180



RC149

Nature



RC118



RC186



RC155



RC139



RC123

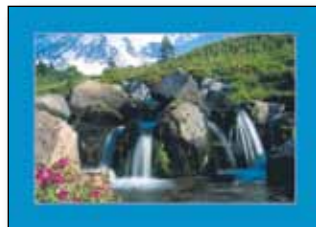

RC130



RC138



RC178



RC107



RC183



RC171



RC112



RC132

Animals



RC121



RC133



RC117

Index

| | |
|--------------------------------------|----------------------------|
| A | |
| Acme Compatible Labels | 69, 72 |
| Adhesive Dividers | 44 |
| Adhesive Fasteners | 31–35 |
| Adhesive Pockets | 37–38 |
| Aging Labels | 77–79 |
| All-State Legal Indexes | 47–48 |
| Allergy Labels | 84–85 |
| Alphabetic Labels | 56–68 |
| Ames Compatible Labels | 57, 69, 77–78 |
| Appointment Cards | 95–99 |
| Auto Industry Exclusives | 19–20 |
| Avery Legal Indexes | 49–50 |
| B | |
| Band Labels | 29 |
| Barkley Compatible Labels | 57–58, 70, 77–78, 80 |
| Billing Labels | 88–90 |
| Binders | 30 |
| Blank Indexes | 52 |
| Blank Labels | 81–83 |
| Blumberg Legal Indexes | 51 |
| Bonded Fasteners | 2, 34 |
| Brunswick Compatible Labels | 71 |
| C | |
| ChargeOut Slips | 36 |
| Chart Divider Tabs | 24, 45–46 |
| Chart Dividers | 24, 40–54 |
| Chart Fasteners | 2, 31–35 |
| Chart Labels | 84–90 |
| Classification Folders | 10, 15–16, 23 |
| Clinical Forms | 91–92 |
| Codeaprint.com Labeling Software | 83 |
| Collection Labels | 88–90 |
| ColorCoded Labels | 56–81 |
| Colored Folders | 3, 7, 10–11, 16, 21–24 |
| Colored Pockets | 17–19 |
| Col'R® Tab Compatible Labels | 60, 71, 77–78 |
| Colwell Jewel Tone Compatible Labels | 59, 71, 77–78 |
| Communication Labels | 84–90 |
| Confidential Sign-In Sheets | 94 |
| Control-O-Fax Compatible Labels | 59, 77–78 |
| Conversion Tabs & Flaps | 33, 35–36 |
| Copier Tabs | 53–54 |
| Custom Binders & Report Covers | 30 |
| Custom Chart Dividers | 40–41 |
| Custom Expandable File Pockets | 27 |
| Custom Folders | 2, 23 |
| Custom Installed Fasteners | 2, 34 |
| Custom Presentation Folders | 30 |
| CutLess™ Folders | 24 |
| D | |
| Data File Compatible Labels | 60, 72, 79–80 |
| Dental Charting System | 93–94 |
| Divider Sheets/Tabs | 24, 45–46 |
| Dividers Custom | 40–41 |
| Dividers Fileback | 40–41, 44 |
| Dividers Self-Adhesive | 40–41, 44 |
| Dividers Table of Contents | 24 |
| DocuClip Fastener | 35 |
| E | |
| Earflap | 33 |
| End Tab Folders | 3–8, 10–15, 19 |
| Envelopes File | 18 |
| Envelopes HCFA | 92 |
| EverFile® Archival Folders | 24 |
| Exhibit Labels | 29 |
| Expandable File Pockets | 25–27 |
| Expanding Fileback | 44 |
| F | |
| Fasteners Custom Installed | 2, 34 |
| Fasteners Standard | 2–3, 31–35 |
| Fastfix™ | 81 |
| File Envelopes | 18 |
| File Fasteners | 2–3, 31–35 |
| File Folders | 2–28 |
| FILE FOLDERS | |
| Classification | 10, 15–16, 23–24 |
| Colored | 3, 7, 10–11, 16, 21–22, 24 |

| | |
|-------------------------------|----------------------------------|
| Custom | 2, 23 |
| CutLess™ | 24 |
| End Tab | 3–8, 10–15, 19 |
| EverFile® Archival | 24 |
| Expansion | 5, 7, 9, 15–16, 18, 22–23, 25–27 |
| Kardex Comparable | 21–22 |
| Mylar Reinforced | 5, 15 |
| Patent/Trademark Application | 28 |
| Pocket | 11–15 |
| Presentation | 30 |
| Pressboard | 16, 23, 30 |
| Printed | 2, 9, 19 |
| SJP Fusion™ | 23 |
| Top Tab | 9–10 |
| Tyvek Expansion | 15, 21–23 |
| W-Fold | 5, 7 |
| w/Dividers | 10, 15–16, 23 |
| w/Fasteners | 3–16, 21–24, 28 |
| w/Pockets | 11–15 |
| WaterShed™ | 24 |
| File Name Labels | 81 |
| File Outguides | 36 |
| File Pockets | 17–19, 25–27 |
| FILE POCKETS | |
| Adhesive Paper | 37 |
| Adhesive SeeThrough | 38 |
| End Tab | 17–19 |
| Expandable | 25–27 |
| Mini | 18 |
| Top Tab | 17–19 |
| Fileback Dividers | 40–41, 44 |
| File Doctor Compatible Labels | 72 |
| Foamclip Fastener | 31–32 |
| FORMS | |
| Clinical | 91–92 |
| Dental | 93–94 |
| Insurance (HCFA) | 92 |
| Medical | 91–92 |
| Patient Sign-In | 94 |
| G | |
| GBS/VRE Compatible Labels | 64, 72, 77–78, 81 |
| H | |
| HCFA Claim Forms | 92 |
| HIPAA Labels | 85–87 |
| I | |
| IFC/AFV Compatible Labels | 72 |
| Indexes Legal | 47–54 |
| Index Tabs | 24, 40–54 |
| Index Dividers - Stock | 24, 43 |
| Index Sets - Stock | 24, 42 |
| Insurance Labels | 88–90 |
| J | |
| Jeter Compatible Labels | 61–62, 73–74, 77–80 |
| K | |
| Kardex Compatible Labels | 63, 74 |
| Kardex Comparable Folders | 21–22 |
| Key Tags | 20 |
| Kraft Pockets | 18, 37 |
| L | |
| LABELS | |
| Aging | 77–79 |
| Allergy | 84–85 |
| Alphabetic | 56–68 |
| Bands | 29 |
| Billing | 88–90 |
| Blank | 24, 81–83 |
| Chart | 84–90 |
| Collection | 88–90 |
| ColorCoded | 56–81 |
| Communication | 84–90 |
| Designator | 80 |
| Exhibit | 29 |
| HIPAA | 85–87 |
| Insurance | 88–90 |
| Laser | 24, 81–83 |
| MAP Compatible | 77–78 |
| Month | 79 |
| Name | 81 |

| | |
|---------------------------------------|---------------------|
| Numeric | 69–76 |
| PlazStyx™ | 24 |
| Protectors | 81 |
| Recycled | 24 |
| Software | 83 |
| Solid Color | 80 |
| Transcription | 82 |
| Vehicle Make | 20 |
| Year | 77–78 |
| Label Protectors | 81 |
| Laser Appointment Cards | 95–99 |
| Legal Industry Exclusives | 29–30 |
| Legal Indexes | 47–54 |
| Lock-It Pockets | 38 |
| M | |
| Medical Alert Labels | 86–87 |
| Medical Charting System | 91 |
| MediClip Fastener | 35 |
| Month Labels | 79 |
| Mylar Protectors | 81 |
| N | |
| Name Label Protectors | 81 |
| Name Labels | 81 |
| Never-Jam Copier Tabs | 53–54 |
| Numeric Labels | 69–76 |
| O | |
| On-Demand Labels | 83 |
| Open Shelf Folders | 3–16, 21–22 |
| Outguides | 36 |
| P | |
| Patent Application Folders | 28 |
| PlazStyx™ Labels | 24 |
| PMA Compatible Labels | 56 |
| Pocket Folders | 11–15 |
| Pockets Factory Applied | 37 |
| Pockets File | 11–15 |
| Pockets See Through | 38 |
| POS Compatible Labels | 64, 68, 73, 77 |
| Presentation Folders | 30 |
| Pressboard Folders | 16, 23, 30 |
| Pressure Sensitive Fasteners | 31–35 |
| Pressure Sensitive Pockets | 38 |
| Progress Notes | 42–43, 45–47, 91–93 |
| R | |
| Recall Cards | 95–99 |
| Recycled Labels | 24 |
| Reinforcing Strips | 33, 35 |
| Report Covers | 30 |
| Reynolds & Reynolds Compatible Labels | 20, 65, 73, 77–79 |
| S | |
| Safeguard Compatible Labels | 65, 77–78 |
| Sales Jackets | 19 |
| Sav-Tyme Compatible Labels | 75 |
| Self-Adhesive Dividers | 44 |
| SJ Paper | 23–24 |
| SJP Fusion™ Classification Folders | 23 |
| Slash Pockets | 17 |
| Smead Compatible Labels | 66, 75, 77–78, 80 |
| Solid Color Labels | 80 |
| Speedex™ Table of Contents Dividers | 24 |
| Strip Labels | 2, 83 |
| Sycom Compatible Labels | 58, 70, 79 |
| T | |
| TAB Compatible Labels | 67–68, 76–80 |
| Traco Compatible Labels | 77–78 |
| Trademark Application Folders | 28 |
| Transcription Labels | 82 |
| U V W | |
| UClip Fastener | 35 |
| UFileM Strip | 12–13, 35 |
| Vehicle Make Labels | 20 |
| Vinyl Outguides | 36 |
| Vinyl Pockets | 38 |
| WaterShed™ Folders | 24 |
| Window Stock Stickers | 20 |
| Y Z | |
| Year Labels | 77–78 |
| Ziplock Pockets | 38 |

FOLDERS | INDEXES | CHART DIVIDERS
FASTENERS | POCKETS | LABELS
FORMS | APPOINTMENT PRODUCTS
STORAGE | FILING ACCESSORIES

