



US009153960B2

(12) **United States Patent**
Lanni

(10) **Patent No.:** **US 9,153,960 B2**
(45) **Date of Patent:** **Oct. 6, 2015**

(54) **POWER SUPPLY EQUIPMENT UTILIZING INTERCHANGEABLE TIPS TO PROVIDE POWER AND A DATA SIGNAL TO ELECTRONIC DEVICES**

(58) **Field of Classification Search**
CPC H02J 2003/00; H02J 1/00; H02J 7/0055; H02J 7/0029; H01R 29/00
See application file for complete search history.

(75) Inventor: **Thomas W. Lanni**, Laguna Niguel, CA (US)

(56) **References Cited**

U.S. PATENT DOCUMENTS

(73) Assignee: **Comarco Wireless Technologies, Inc.**, Lake Forest, CA (US)

5,164,652 A 11/1992 Johnson et al.
5,254,931 A 10/1993 Martensson

(Continued)

(*) Notice: Subject to any disclaimer, the term of this patent is extended or adjusted under 35 U.S.C. 154(b) by 89 days.

FOREIGN PATENT DOCUMENTS

(21) Appl. No.: **13/461,149**

WO WO 98/19223 5/1998
WO WO 2006/116298 A1 11/2006

OTHER PUBLICATIONS

(22) Filed: **May 1, 2012**

European Search Report dated Sep. 19, 2006 for EP Patent Application No. EP05250133.5, 3 pages.

(65) **Prior Publication Data**

US 2012/0212078 A1 Aug. 23, 2012

(Continued)

Related U.S. Application Data

Primary Examiner — Daniel Cavallari

(63) Continuation-in-part of application No. 13/209,636, filed on Aug. 15, 2011, now Pat. No. 8,330,303, which is a continuation of application No. 12/840,952, filed on Jul. 21, 2010, now Pat. No. 7,999,412, which is a continuation of application No. 11/604,950, filed on Nov. 28, 2006, now Pat. No. 7,868,486, which is a continuation-in-part of application No. 10/758,933, filed on Jan. 15, 2004, now Pat. No. 7,453,171.

(74) *Attorney, Agent, or Firm* — Ethan R. Fitzpatrick

(57) **ABSTRACT**

(51) **Int. Cl.**
G05F 3/06 (2006.01)
H02J 1/00 (2006.01)
H02J 7/00 (2006.01)
H01R 29/00 (2006.01)

Power supply equipment includes an adapter which converts power from a power source to DC power for powering an electronic device. The power supply equipment includes circuitry which produces a data signal for use by the electronic device to control power drawn by the electronic device. A cable extends from the adapter. The power supply equipment further includes a tip which has an input side and an output side. The input side of the tip is detachably mateable to the cable. The output side of the tip is detachably mateable to the electronic device. The tip output side has a shape and size dependent on the shape and size of a power input opening of the electronic device. The tip provides the data signal, as well as the DC power, to the electronic device. Different tips may be used to provide appropriate data signals to different electronic devices.

(52) **U.S. Cl.**
CPC **H02J 1/00** (2013.01); **H02J 7/0029** (2013.01); **H02J 7/0055** (2013.01); **H01R 29/00** (2013.01)

3 Claims, 10 Drawing Sheets

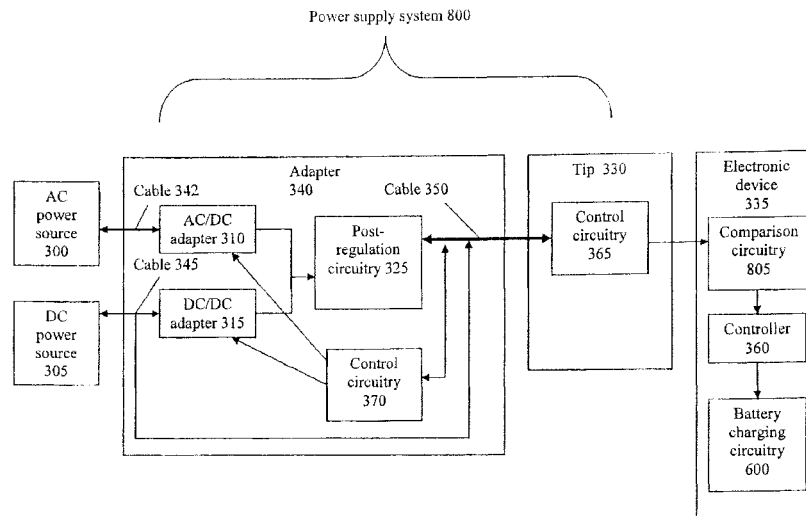

(56)

References Cited

U.S. PATENT DOCUMENTS

5,333,177	A	7/1994	Braitberg et al.	
5,350,993	A	9/1994	Toya et al.	
5,369,352	A	11/1994	Toepfer et al.	
5,420,496	A	5/1995	Ishikawa	
5,506,490	A	4/1996	DeMuro	
5,534,765	A	7/1996	Kreisinger et al.	
5,570,002	A	10/1996	Castleman	
5,573,425	A	11/1996	Morisawa et al.	
5,593,323	A	1/1997	Dernehl	
5,615,344	A	3/1997	Corder	
5,648,711	A	7/1997	Hakkarainen	
5,694,024	A	12/1997	Dias et al.	
5,703,467	A	12/1997	Patino	
5,783,926	A	7/1998	Moon et al.	
5,836,783	A	11/1998	Morisawa et al.	
5,861,729	A	1/1999	Maeda et al.	
5,912,544	A	6/1999	Miyakawa et al.	
5,939,856	A	8/1999	Demuro et al.	
5,955,797	A	9/1999	Kim	
5,969,438	A	10/1999	Odaohara	
6,054,846	A	4/2000	Castleman	
6,288,522	B1	9/2001	Odaohhara et al.	
6,358,096	B1	3/2002	Beckman	
6,360,177	B1	3/2002	Curt et al.	
6,368,155	B1	4/2002	Bassler et al.	
6,459,175	B1	10/2002	Potega	
6,528,970	B1	3/2003	Liu et al.	
6,597,565	B1	7/2003	Kluth et al.	
6,628,535	B1	9/2003	Wu	
6,751,109	B2	6/2004	Doss et al.	
6,795,302	B2	9/2004	Kluth et al.	
6,903,950	B2	6/2005	Afzal et al.	
6,934,561	B2	8/2005	Burrus, IV	
6,936,936	B2	8/2005	Fischer et al.	
6,999,505	B2	2/2006	Yokoo et al.	
RE39,036	E	3/2006	Castleman	
7,028,202	B2	4/2006	Long et al.	
7,039,821	B1	5/2006	Potega	
7,058,484	B1*	6/2006	Potega	700/297
7,127,623	B2	10/2006	Potega	
7,145,312	B2	12/2006	Lanni	
7,193,398	B2	3/2007	Lanni	
7,392,099	B2	6/2008	Atkinson et al.	
7,392,410	B2	6/2008	Allen	
7,453,171	B2	11/2008	Lanni	
7,868,486	B2	1/2011	Lanni	
7,937,603	B2	5/2011	Haberle et al.	
7,999,412	B2	8/2011	Lanni	
8,330,303	B2	12/2012	Lanni	
8,492,933	B2	7/2013	Lanni	
2002/0171980	A1	11/2002	Tsukihashi	
2003/0085621	A1*	5/2003	Potega	307/18
2003/0207603	A1	11/2003	Potega	
2003/0222503	A1	12/2003	Lam et al.	
2004/0075419	A1	4/2004	Massey et al.	
2005/0127758	A1	6/2005	Atkinson et al.	
2005/0162020	A1	7/2005	Lanni	
2006/0164061	A1	7/2006	Formenti et al.	
2006/0220465	A1	10/2006	Kingsmore, Jr. et al.	

OTHER PUBLICATIONS

European Search Report dated Nov. 24, 2008 for EP Patent Application No. 07254497.6, 13 pages.

Radio Shack 1990 Catalog, cover page and p. 151, 1990.

Radio Shack 1994 Catalog, cover page and p. 142, 1994.

Radio Shack 1995 Catalog, cover page and pp. 150-151, 1995.

Minwa Products, "MW182", Minwa Products Catalog 1993, 1 page.

Power Stream Technology, "High Quality Automobile to Laptop DC/DC Converter" Specification sheet copyright 2000, 2002, 2003, 2004—4 pages.

"Universal Serial Bus Specification Revision 2.0" Compaq Computer Corporation, et al., Apr. 27, 2000, Cover page, Copyright notice page, Content pp. v-xiii, Section 7.2 Power Distribution, pp. 171-178.

European Patent Office, "Examination Report/Communication Pursuant to Article 94(3) EPC" re: Patent Application Serial No. 02 250 133.5, Date: Jun. 14, 2012, 11 pages.

ACCO Brands USA LLC vs. Comarco Wireless Technologies, Inc., Case No. C11-4378 RS, U. S. District Court for the Northern District of California, Plaintiff and Counterdefendant ACCO's Invalidation Contentions, pp. 1-3 and Exhibit E, pp. 1-6, Jun. 27, 2012.

Case No. C11-4378-RS, Patent L.R. 4-3 Joint Claim Construction and Prehearing Statement, Pacer Document No. 33, Aug. 31, 2012, 26 pages.

Case No. C11-4378-RS, Comarco Wireless Technologies, Inc.'S Patent L.R. 4-5(a) Opening Claim Construction Brief, Pacer No. Document 36, Sep. 21, 2012, 33 pages.

Case No. C11-4378-RS, Plaintiff ACCO Brands USA LLC'S Opening Markman Brief, Pacer Document No. 38, Oct. 12, 2012, 31 pages.

Case No. C11-4378-RS, Comarco Wireless Technologies, Inc.'S Memorandum of Points and Authorities in Opposition to Plaintiff'S Motion to Strike the Declaration of Thomas W. Lanni, Pacer Document No. 40, Oct. 26, 2012, 16 pages.

Case No. C11-4378-RS, ACCO Brands USA LLC'S Reply in Support of Motion to Strike the Declaration of Thomas W. Lanni, Pacer Document No. 41, Nov. 2, 2012, 17 pages.

Case No. C11-4378-RS, Comarco Wireless Technologies, Inc.'S Patent L.R. 4-5(c) Claim Construction Reply Brief, Pacer Document No. 42, Nov. 2, 2012, 18 pages.

Case No. C11-4378-RS, Claim Construction Order, Pacer Document No. 49, Mar. 6, 2013, 23 pages.

European Search Report dated Sep. 28, 2006 for EP Patent Application No. EP05250133.5, 3 pages.

European Search Report dated Feb. 6, 2009 for EP Patent Application No. 07254497.6, 13 pages.

European Patent Office, "Examination Report/Communication Pursuant to Article 94(3) EPC" re: Patent Application Serial No. 05 250 133.5, Date: Jun. 14, 2012, 11 pages.

National Semiconductor Corporation, "Datasheet for LM2601 Adapter Interface Circuit", dated Apr. 2001, 6 pages.

Declaration of Thomas W. Lanni Regarding Comarco N19 and N24 Tips, May 14, 2013, 2 pages.

Comarco Wireless Technologies, Inc. Specification Control Drawing No. 1910-0219, "Tip N19", May 14, 2004, 5 pages.

Comarco Wireless Technologies, Inc. Specification Control Drawing No. 1245-0021-T, "EPROM DS2502, TO-92", Jun. 21, 2005, 1 page.

Comarco Wireless Technologies, Inc. Specification Control Drawing No. 1910-0224, "Tip N24", Oct. 23, 2004, 5 pages.

* cited by examiner

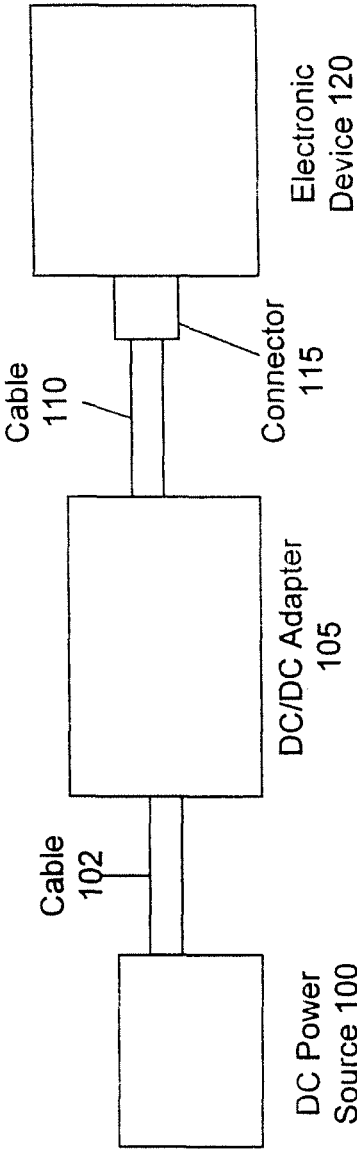

Fig. 1 (Prior Art)

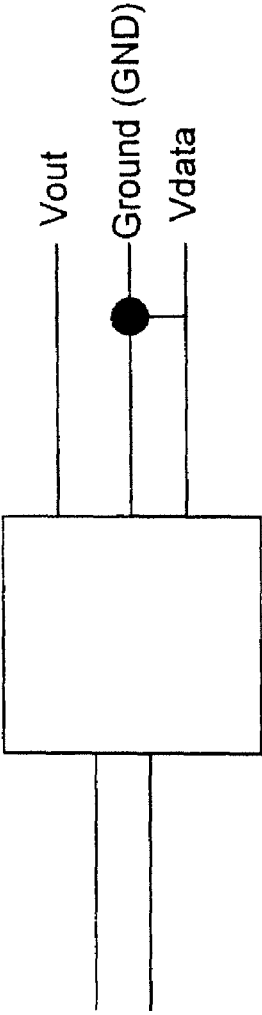

Fig. 2A (Prior Art)

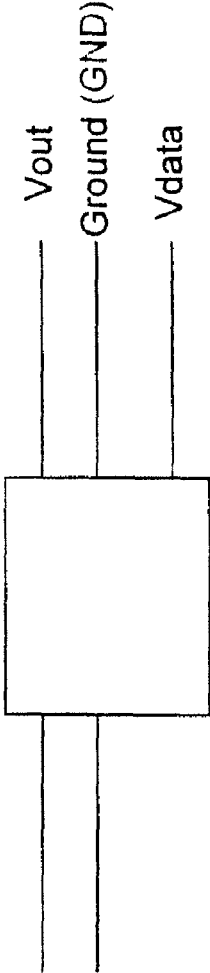

Fig. 2B (Prior Art)

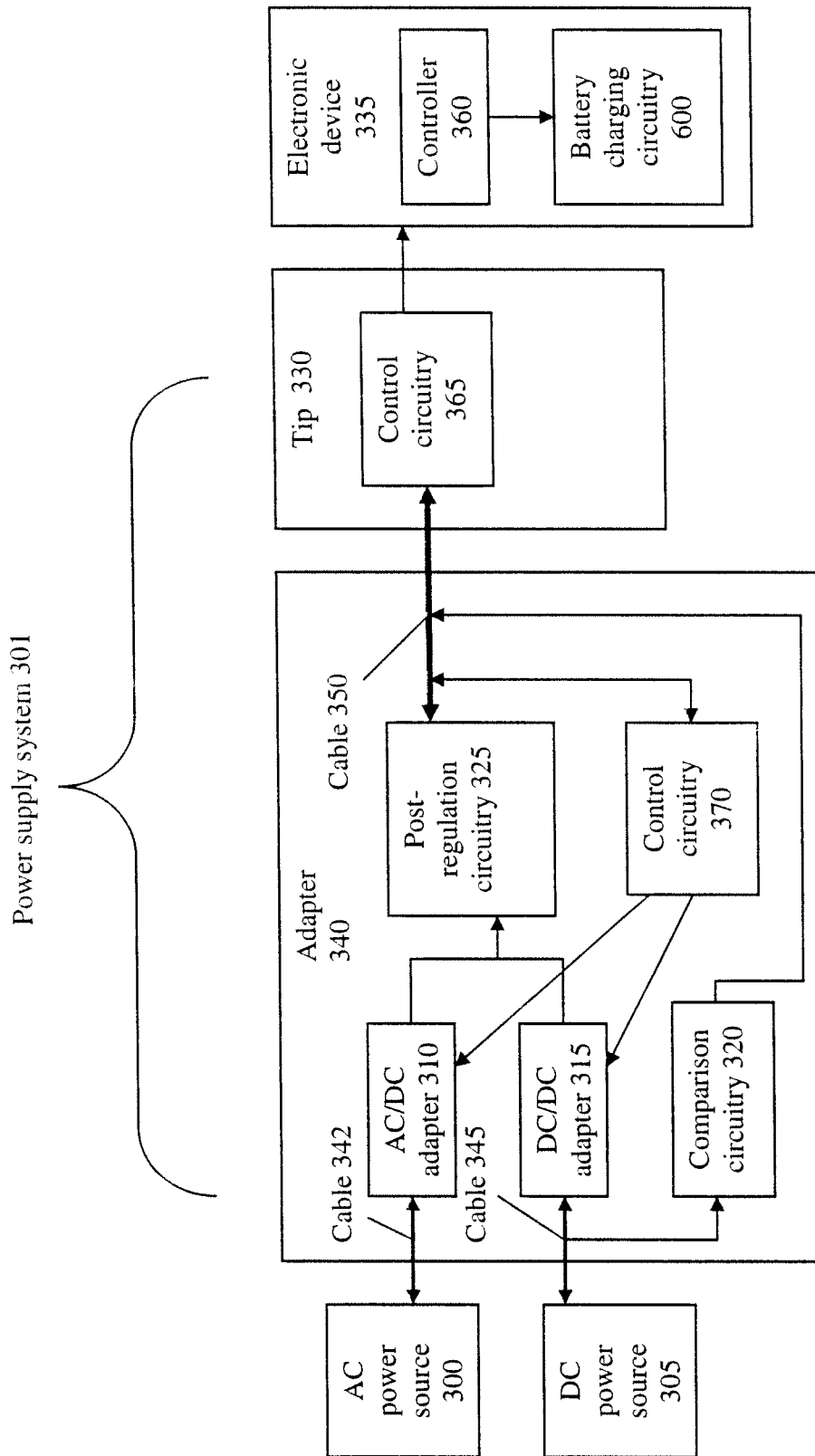

FIG. 3

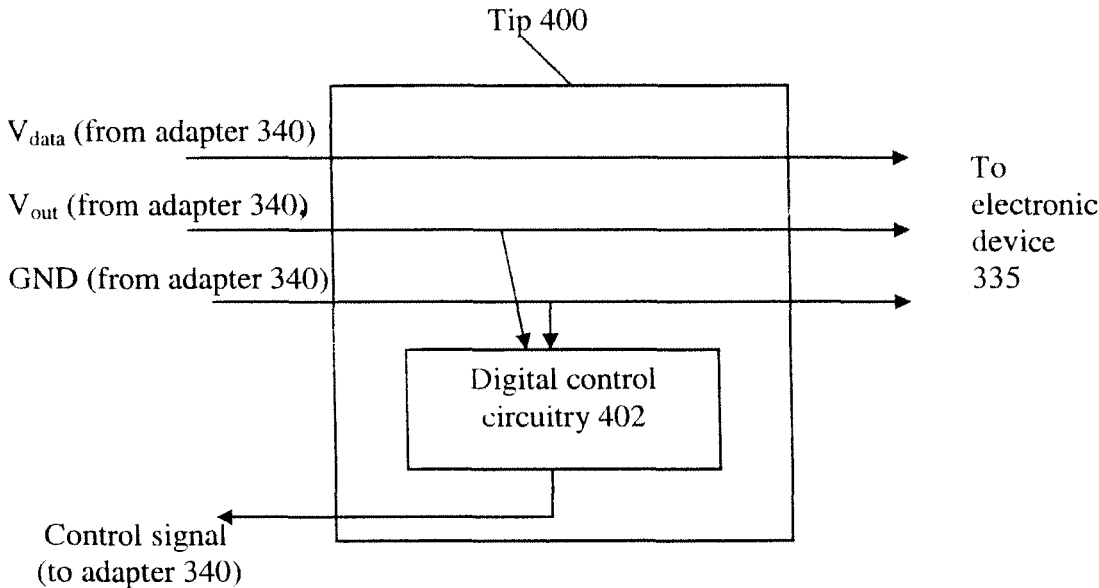

FIG. 4A

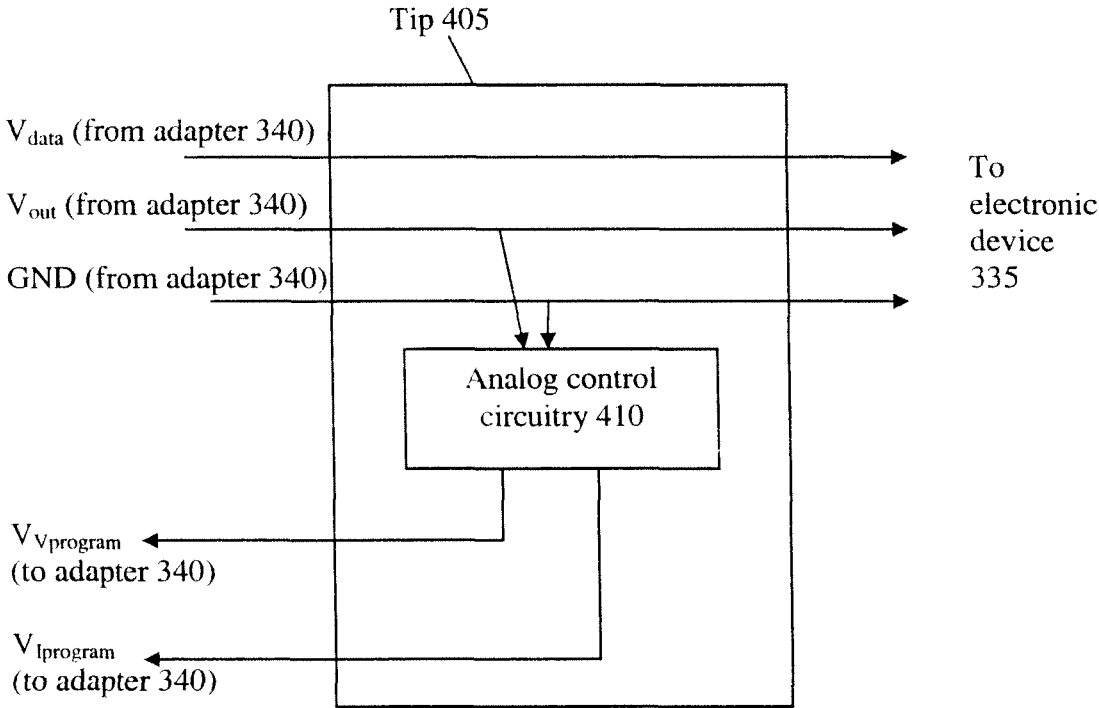

FIG. 4B

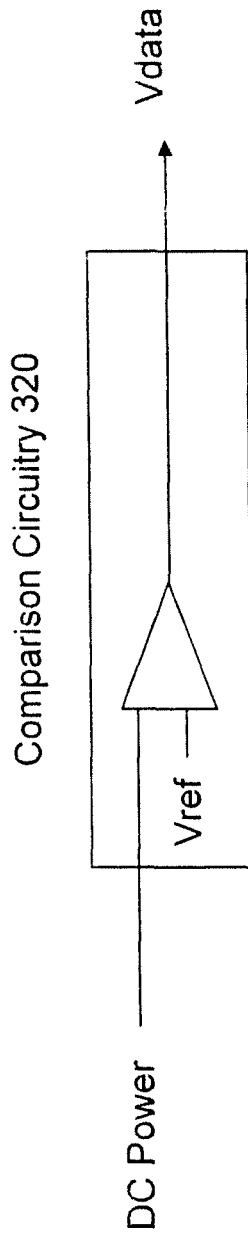

Fig. 5A

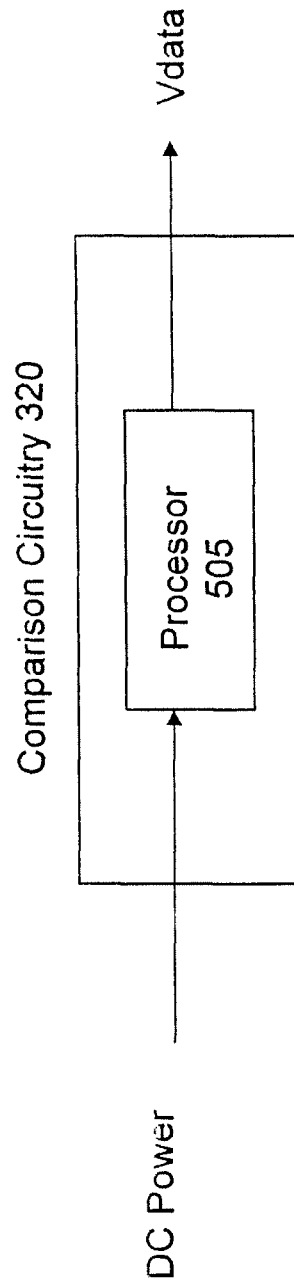

Fig. 5B

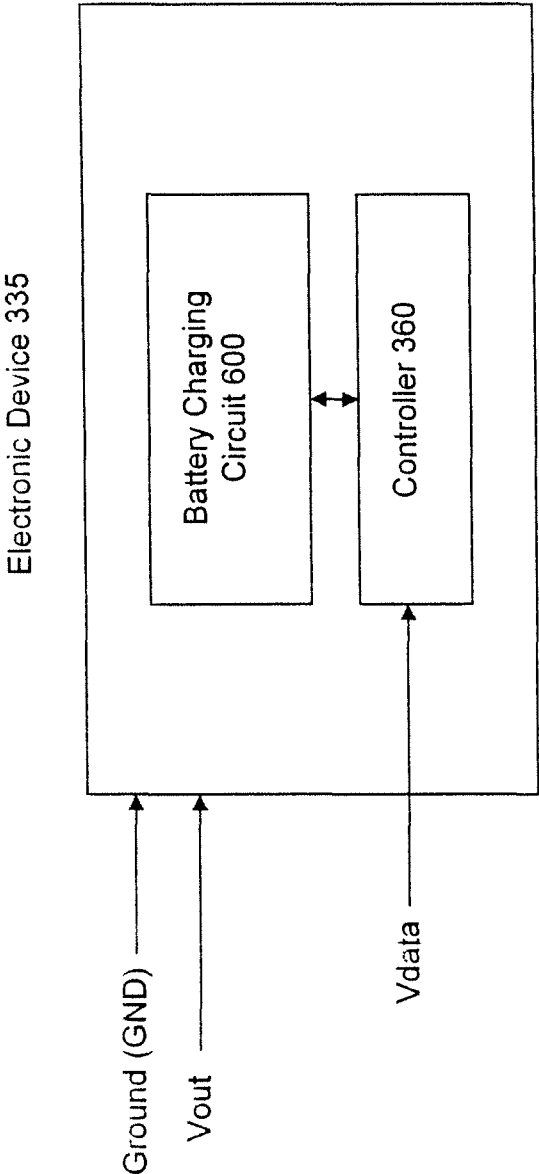

Fig. 6

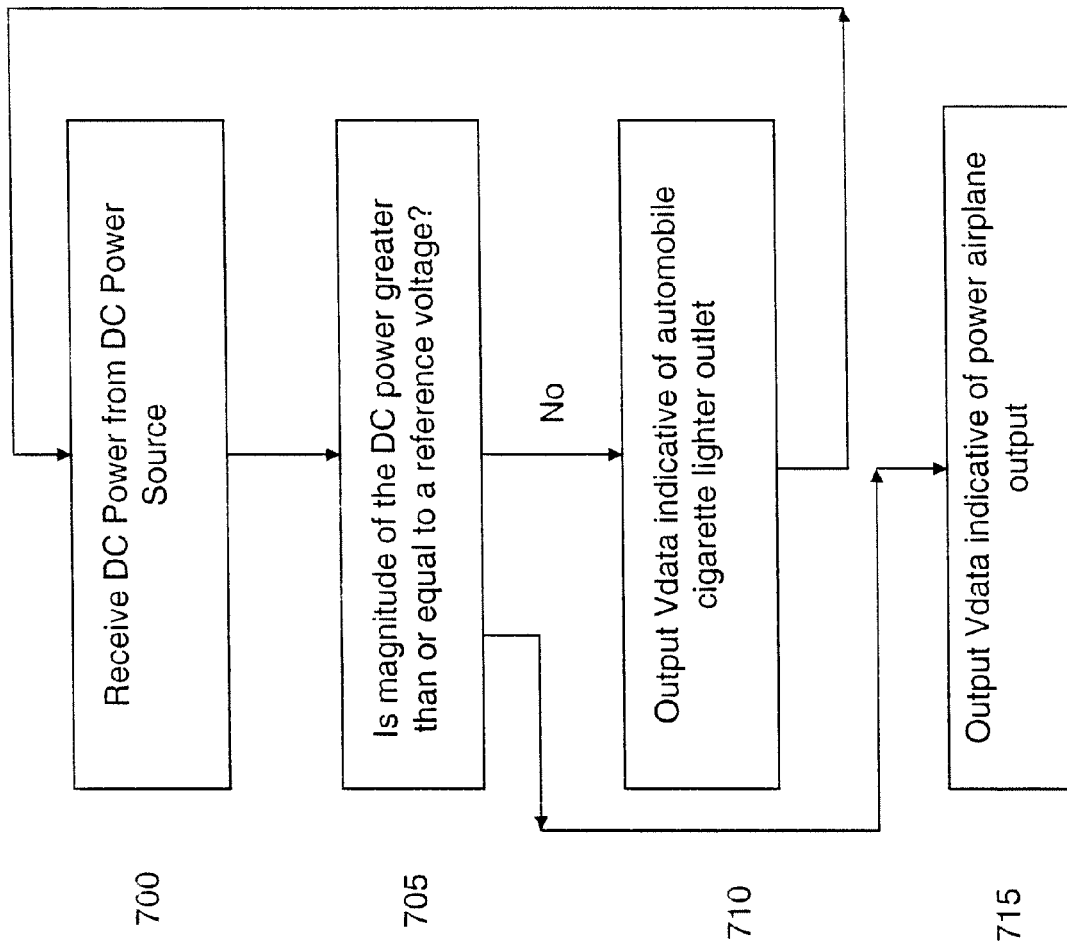

Fig. 7A

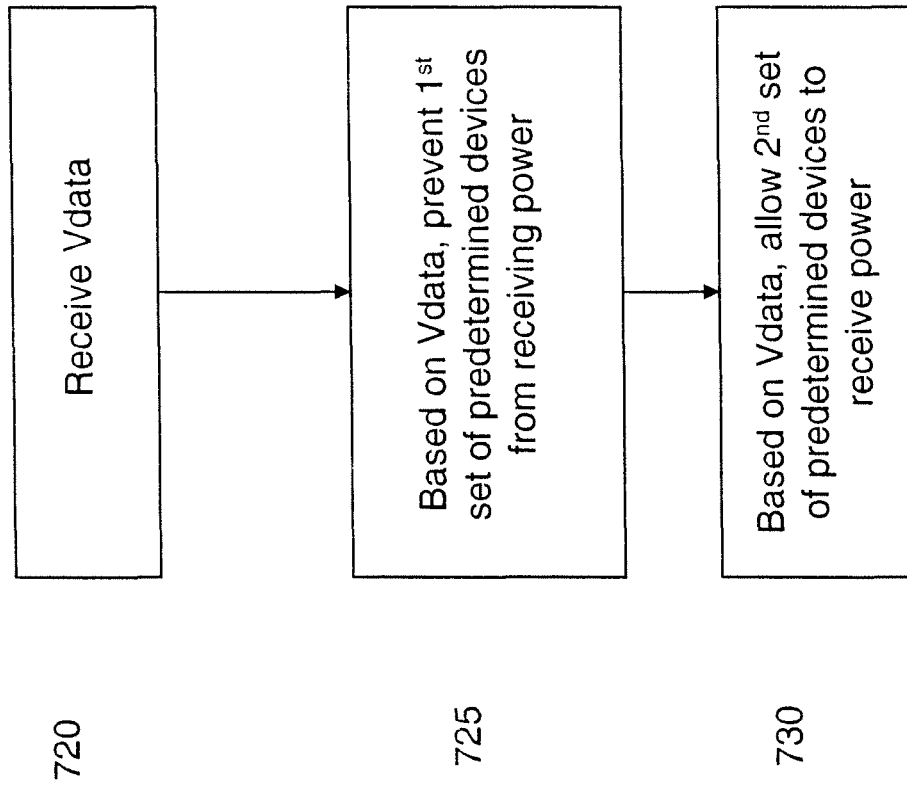

Fig. 7B

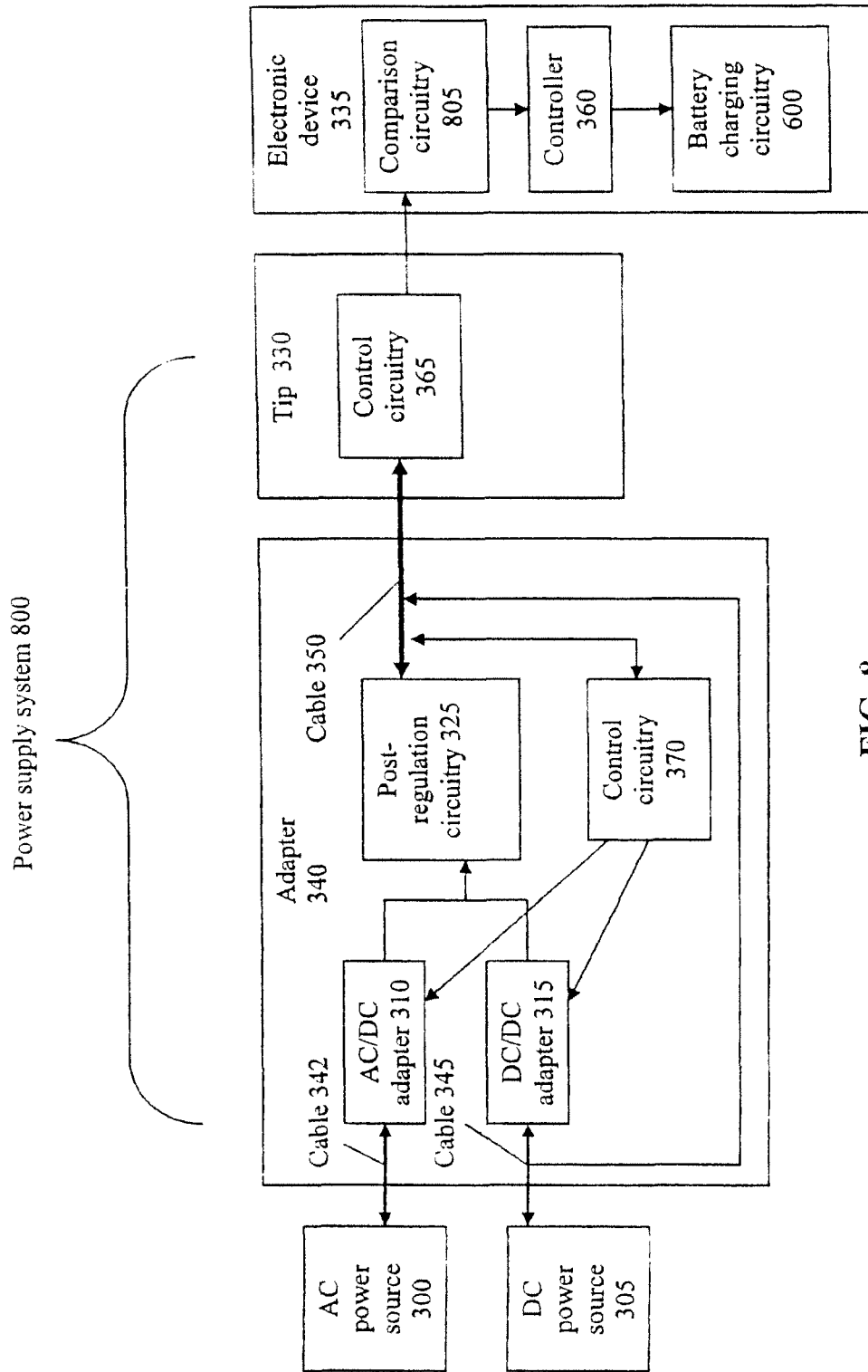

FIG. 8

**POWER SUPPLY EQUIPMENT UTILIZING
INTERCHANGEABLE TIPS TO PROVIDE
POWER AND A DATA SIGNAL TO
ELECTRONIC DEVICES**

RELATED APPLICATIONS

This application is a continuation-in-part of application Ser. No. 13/209,636, filed on Aug. 15, 2011, which is a continuation of application Ser. No. 12/840,952, filed on Jul. 21, 2010, now U.S. Pat. No. 7,999,412 issued on Aug. 16, 2011, which is a continuation of application Ser. No. 11/604,950, filed on Nov. 28, 2006, now U.S. Pat. No. 7,868,486 issued on Jan. 11, 2011, which is a continuation-in-part of application Ser. No. 10/758,933, filed on Jan. 15, 2004, now U.S. Pat. No. 7,453,171 issued on Nov. 18, 2008.

BACKGROUND OF THE INVENTION

1. Technical Field

This invention relates to DC power adapters for powering electronic devices.

2. Description of the Related Arts

There are power systems in the art which allow a user to hook up a DC/DC adapter to an automobile outlet, to supply regulated DC power to power an electronic device, such as a notebook computer. Automobile outlets typically provide a DC voltage in a range between 11.0 and 14.1 Volts. Some power systems also allow the user to hook up the DC/DC adapter to an airplane output such as the EMPOWER system. EMPOWER typically provides a DC voltage in a range between 14.5 and 15.5 Volts.

Accordingly, some DC/DC adapters can be used with both an automobile outlet and the EMPOWER system to provide a regulated DC power to the electronic device such as the notebook computer. Notebook computers often contain lithium ion batteries. Such batteries can be recharged when the notebook computer is hooked up to the DC/DC adapter. For example, if the user is in a car, the user can couple a DC/DC adapter to the notebook computer and to the cigarette lighter outlet to power the notebook computer. The batteries in the notebook computer will draw some of the DC power supplied to recharge the batteries of the notebook computer if they are low in power. Accordingly, the user can simultaneously use the notebook computer and recharge the batteries therein.

The user can also use the DC/DC adapter while on an airplane, by plugging the DC/DC adapter into the EMPOWER outlet. The EMPOWER outlet and the automobile outlets have different sizes and shapes. Accordingly, the user can directly plug the DC/DC adapter into the EMPOWER outlet, and can place a connector over the EMPOWER plug of the DC/DC adapter and then plug the connector into the automobile cigarette lighter outlet. When the user hooks the DC/DC adapter up to the EMPOWER outlet and then to the electronic device, the electronic device receives the regulated DC power. However, if the charging circuitry in the battery malfunctions, the battery can overheat or even catch on fire when recharging from an EMPOWER DC source. If the battery were to catch on fire while an airplane in which the emPower outlet is located is flying, the fire would have the potential to cause the airplane to crash or cause substantial damage.

To address this problem, one system in the art provides a connector to connect between the DC/DC adapter and the notebook computer to inform the notebook computer not to recharge the batteries. FIG. 1 illustrates a power supply sys-

tem according to the prior art. As shown, a DC power source **100** is coupled to a DC/DC adapter **105** via a cable **102**. The DC/DC adapter **105** receives power from the DC power source **100** and outputs regulated DC power to an electronic device **120**, via a cable **110** and a connector **115** coupled to the end of the cable **110**.

The DC/DC adapter **105** can provide three output pins to the electronic device **120**, as shown in FIGS. **2A** and **2B** of the prior art. The first pin can provide the output voltage (i.e., V_{out}), the second pin can provide a ground reference (i.e., GND), and the third pin can provide a data line (i.e., V_{data}) to instruct the notebook as to whether the batteries should be recharged or not. For example, as shown in FIG. **2A**, V_{data} could be tied to GND to indicate that the DC power source **100** is the EMPOWER system and therefore the battery should not be recharged. Alternatively, as shown in FIG. **2B**, V_{data} could also be left open (i.e., to provide a non-grounded floating voltage) when the DC power source **100** in a cigarette lighter outlet of an automobile. Accordingly, when using the DC/DC adapter **105** while in an automobile, the user would use a connector **115** having the V_{data} line floating, and when using the DC/DC adapter **105** with the EMPOWER system of an airplane, the user would use a connector **115** having the V_{data} line tied to GND.

However, problems arise when the user forgets to change the connector **115** for use with the automobile when the user is in an airplane. Accordingly, if the user has the wrong connector **115** attached when using with the EMPOWER system, a battery of an electronic device **120** such as a notebook computer can charge the battery even when used with the EMPOWER system, and if the charging circuitry of the battery malfunctions, overheating or even a fire can occur, resulting in damage to the notebook computer. Also, if the connector **115** is damaged or flawed, then it may not provide the correct V_{data} signal to the notebook computer, allowing the notebook computer to recharge the batteries in an airplane when they shouldn't be allowed to do so.

Accordingly, current DC/DC power adapter systems are deficient because they are incapable of automatically and intelligently informing an electronic device **120** coupled thereto of the DC power source (i.e., the EMPOWER system or an automobile cigarette lighter outlet).

BRIEF DESCRIPTION OF THE DRAWINGS

FIG. **1** illustrates a power supply system according to the prior art;

FIG. **2A** illustrates a first connector to coupled a power supply system to an electronic device according to the prior art;

FIG. **2B** illustrates a second connector to coupled a power supply system to an electronic device according to the prior art;

FIG. **3** illustrates a power supply system according to an embodiment of the invention;

FIG. **4A** illustrates a tip having digital control circuitry according to an embodiment of the invention;

FIG. **4B** illustrates a tip having analog control circuitry according to an embodiment of the invention;

FIG. **5A** illustrates comparison circuitry according to an embodiment of the invention;

FIG. **5B** illustrates comparison circuitry according to an additional embodiment of the invention;

FIG. **6** illustrates an electronic device according to an embodiment of the invention;

FIG. **7A** illustrates a method of determining and outputting V_{data} according to an embodiment of the invention;

FIG. 7B illustrates a method of receiving V_{data} and allowing power to flow to devices within the electronic device based on V_{data} according to an embodiment of the invention; and

FIG. 8 illustrates a power supply system according to an embodiment of the invention.

DETAILED DESCRIPTION

An embodiment of the present invention is directed to a power supply system to determine a DC power source (e.g., an automobile cigarette lighter outlet or an EMPOWER airplane outlet) coupled thereto and send a signal indicative of the power source to an electronic device coupled thereto. The electronic device may be a notebook computer or other portable consumer electronic device, for example. Based on the signal sent to the electronic device, the electronic device may control the amount of power drawn to prevent overheating. For example, when a notebook computer is hooked up and the power source is the EMPOWER system, the electronic device may disable charging of the internal batteries of the notebook computer, in order to prevent damage or overheating of the batteries due to malfunction or failure. The DC power source may be determined by voltage comparison circuitry, such as a comparator, or by a voltage comparison device including a processor.

FIG. 3 illustrates a power supply system 301 according to an embodiment of the invention. As shown, the adapter 340 may be used with an AC power source 300 or a DC power source 305. In other embodiments, only a DC power source 305 may be utilized to supply power. The AC power source 300 may be coupled to an AC/DC adapter 310 via a cable 342. The DC power source 305 may be coupled to both a DC/DC adapter 315 and comparison circuitry 320 via a cable 345. The DC power source 305 may be an automobile's cigarette lighter outlet or an airplane's EMPOWER system outlet, for example. AC/DC adapter 310 may convert AC power from the AC power source 300 into regulated DC power, which is supplied to post-regulation circuitry 325. The post-regulation circuitry 325 may provide an output voltage (V_{out}) and a ground reference (GND) to a tip 330 coupled to the adapter 340 via a cable 350, as further explained below with respect to FIGS. 4A and 4B. The tip 330 may be coupled to an electronic device 335 to provide the power thereto from the power supply system 301. The tip 330 may be removable from the cable 350 and may be inserted into a power input opening of the electronic device. Tips 330 may have different shapes and sizes, depending up the shape and sizes of the power input openings of the respective electronic devices 335 being powered. The tip 330 may also include control circuitry 365 to provide a signal to control circuitry 370 of the adapter 340. The signal may be sent to the control circuitry 370 via the cable 350. In one embodiment, the control circuitry 365 of the tip 330 may include digital components to provide a digital signal to the control circuitry 370 of the adapter 340. The digital signal may be utilized to set the magnitude of V_{out} and limit the amount of current which may be drawn from the adapter 340. The post-regulation circuitry 325 regulates the voltage to what the tip 330 tells it to provide.

Alternatively, the tip 330 may include analog components and may provide voltage programming and current programming voltages ($V_{Vprogram}$ and $V_{Iprogram}$, respectively) to the adapter 340. $V_{Vprogram}$ may be utilized to set the magnitude of V_{out} . For example, there may be a linear relationship between $V_{Vprogram}$ and V_{out} where V_{out} is 3 times as large as $V_{Vprogram}$. Accordingly, if $V_{Vprogram}$ had a magnitude of 3.0 Volts, V_{out} would have a magnitude of 9.0 Volts, and if $V_{Vprogram}$ had a

magnitude of 2.0 Volts, V_{out} would have a magnitude of 6.0 Volts. The analog circuitry may contain passive or active components.

Accordingly, regardless of whether the tip 330 has analog or digital control circuitry, a single adapter 340 may be used to supply power to a plurality of different electronic devices 335 having different power requirements.

The adapter 340 may also include comparison circuitry 320. The comparison circuitry 320 may compare a magnitude of a voltage received from the DC power source 305 with a reference voltage to determine whether the DC power source 305 is an automobile cigarette lighter outlet or an EMPOWER airplane outlet. As stated above, automobile cigarette lighter outlets typically provide a DC voltage having a magnitude within the range of 11.0 Volts and 14.1 Volts. An EMPOWER airplane outlet typically provides a DC voltage having a magnitude within the range of 14.5 and 15.5 Volts. Accordingly, the reference voltage may be set at a level between the high end of the automobile cigarette light outlet voltage (i.e., 14.1 Volts) and the low end of the EMPOWER airplane outlet voltage (i.e., 14.5 Volts). For example, the reference voltage may be set at 14.3 Volts. Accordingly, if the magnitude of the DC power source is greater than 14.3 Volts, then the comparison voltage may determine that the received DC voltage has a greater magnitude than the reference voltage and the DC power source 305 is therefore the EMPOWER airplane outlet. However, if the magnitude of the DC power source is less than 14.3 Volts, then the comparison voltage may determine that the received DC voltage has a smaller magnitude than the reference voltage and the DC power source 305 is therefore the automobile cigarette lighter outlet.

The comparison circuitry 320 may output a signal V_{data} based upon whether the DC power source is determined to be the automobile cigarette lighter outlet or the EMPOWER airplane outlet. For example, the comparison may output 5 Volts if the automobile cigarette lighter outlet is detected, and 0.0 Volts if the EMPOWER airplane outlet is detected. In alternative embodiments, different voltages for V_{data} may be used. In additional embodiments, the comparison circuitry 320 may output a digital signal, such as a stream of bits, indicative of the DC power source 305. V_{data} may be sent via cable 350 to the tip 330, and straight over to the electronic device 335. The electronic device 335 may include a controller 360 which is responsive to V_{data} . For example, if the electronic device 335 is a notebook computer and V_{data} is indicative of the EMPOWER airplane outlet system, the controller 360 may disable battery charging circuitry 600, thereby preventing recharging of the batteries. And if the V_{data} is indicative of the automobile cigarette lighter outlet as the DC power source 305, the controller 360 may enable battery charging circuitry to allow the batteries to be recharged.

Although FIG. 3 illustrates an adapter 340 which includes both a AC/DC adapter and a DC/DC adapter, other embodiments may include only a DC/DC adapter, and no AC/DC adapter.

FIG. 4A illustrates a tip 400 having digital control circuitry 402 according to an embodiment of the invention. As shown, the tip 400 receives V_{data} , V_{out} and GND from the adapter 340 and allows them to all flow to the electronic device 335. The digital control circuitry 402 may receive the V_{out} and GND signals and may output a control signal to the adapter 340 to set the magnitude of V_{out} and limit the current provided. The control signal may be sent to the adapter 340 via the cable 350 between the tip 400 and the adapter 340. The digital control circuitry 402 may include a processor and a memory device, for example. In some embodiments, the tip 400 may be sepa-

5

rable from cable 350, and in other embodiments, the tip 400 may be physically part of the cable 350.

FIG. 4B illustrates a tip 405 having analog control circuitry 410 according to an embodiment of the invention. As shown, the tip 405 receives V_{data} , V_{out} and GND from the adapter 340 and allows them to all flow to the electronic device 335. The analog control circuitry 410 may receive the V_{out} and GND signals and may output $V_{Vprogram}$ and $V_{Iprogram}$ to the adapter 340. $V_{Vprogram}$ and $V_{Iprogram}$ may be sent to the adapter 340 via the cable 350 between the tip 405 and the adapter 340. The analog control circuitry 400 may include passive or active components, for example. In some embodiments, the tip 400 may be separable from cable 350, and in other embodiments, the tip 400 may be physically part of the cable 350.

FIG. 5A illustrates comparison circuitry 320 according to an embodiment of the invention. As shown, the comparison circuitry 320 includes a comparator 500. The comparator 500 receives (a) the DC power signal from the DC power source 305, and (b) a reference voltage, V_{ref} . The comparator outputs V_{data} based on whether the magnitude of the DC power from the DC power source exceeds V_{ref} as described above with respect to FIG. 3.

FIG. 5B illustrates comparison circuitry 320 according to an additional embodiment of the invention. As shown, the comparison circuitry 320 includes a processor 505. The processor 505 receives (a) the DC power signal from the DC power source 305, and (b) value of a reference voltage stored in memory. The processor 505 then outputs V_{data} based on whether the magnitude of the DC power from the DC power source exceeds V_{ref} as described above with respect to FIG. 3. The processor 505 may output a single high or low voltage (e.g., 5.0 Volts or 0.0 Volts) based on the detected DC power source. Alternatively, the processor 505 may output a stream of bits to indicate the DC power source.

FIG. 6 illustrates an electronic device 335 according to an embodiment of the invention. As shown, the electronic device 335 may receive GND, V_{out} and V_{data} from the tip 330. V_{data} may be received by a controller 360. The controller 360 may disable battery charging circuitry 600 of the electronic device 335 from charging batteries when V_{data} is indicative of the EMPOWER outlet. Alternatively, the controller 360 enables battery charging circuitry 600 so that the batteries of the electronic device may be charged based on the value of V_{data} .

FIG. 7A illustrates a method of determining and outputting V_{data} according to an embodiment of the invention. The processing shown in FIG. 7A may be implemented by the adapter 340. First, DC power is received 700 from the DC power source 305. Next, the comparison circuitry determines 705 whether the magnitude of the voltage of the DC power received is greater than V_{ref} . If "no," the comparison circuitry determines the DC power source 305 to be an automobile cigarette lighter outlet, and processing proceeds to operation 710, where V_{data} is output with a signal/voltage magnitude indicating that the DC power source 305 is the automobile cigarette lighter outlet. Processing then returns to operation 700. If "yes," at operation 705, processing proceeds to operation 715, where V_{data} is output with a signal/voltage magnitude indicating that the DC power source 305 is the EMPOWER airplane outlet.

FIG. 7B illustrates a method of receiving V_{data} and allowing power to flow to devices within the electronic device 335 based on V_{data} according to an embodiment of the invention. First, the electronic device 335 receives 720 the V_{data} signal. As discussed above, the V_{data} signal is sent from the adapter 340 through the tip 330 and over to the control circuitry 365 of the electronic device 335. Next, based on the V_{data} signal, a first set of predetermined devices may be prevented 725

6

from receiving power. For example, if the electronic device 335 is a notebook computer, the control circuitry 365 may prevent batteries from recharging if V_{data} indicates that the DC power source is the EMPOWER airplane outlet. Other devices/components in the electronic device 335 may also be prevented from receiving power or from functioning in a certain way.

At operation 730, a second set of predetermined devices may be allowed to receive power based on the V_{data} signal. For example, if V_{data} indicates that the DC power source is an automobile cigarette lighter outlet, then power may be available to batteries of the electronic device 335 to allow recharging. Other devices/components in the electronic device 335 may also be allowed to receive power or function in a particular way.

In embodiments described above, the V_{data} signal may be used to send a signal to the control circuitry 365 indicating the DC power source. This signaling may be done via a discrete bit, an analog signal, a data signal line, an analog voltage, or via any other suitable manner. The V_{data} signal may be transmitted from the adapter 340 to the tip 330 and electronic device 335 via a single signaling line or multiple signaling lines.

FIG. 8 illustrates a power supply system 800 according to an embodiment of the invention. The power supply system 800 is similar to the power supply system 301 shown in FIG. 3. However, unlike the power supply system 301, in which the adapter 340 itself contains comparison circuitry 370, the adapter 340 of power supply system 800 does not contain the comparison circuitry 805. Instead, a regular adapter 340 may be used and the electronic device 335 itself includes the comparison circuitry 805 for determining the DC power source. The electronic device 335 may be a notebook computer and may implement the methods shown in FIGS. 7A and 7B.

While the description above refers to particular embodiments of the present invention, it will be understood that many modifications may be made without departing from the spirit thereof. The accompanying claims are intended to cover such modifications as would fall within the true scope and spirit of the present invention. The presently disclosed embodiments are therefore to be considered in all respects as illustrative and not restrictive, the scope of the invention being indicated by the appended claims, rather than the foregoing description, and all changes which come within the meaning and range of equivalency of the claims are therefore intended to be embraced therein.

What is claimed is:

1. Power supply equipment for powering an electronic device comprising:
 - an adapter to convert power from a power source, external to the adapter, from AC to DC power or from DC to DC power, for powering the electronic device which is external to the power source and the adapter;
 - a cable having a first end and a second end, the first end being electrically coupled to the adapter to receive the DC power from the adapter;
 - circuitry having a memory to store a data signal for use by the electronic device to control an amount of power drawn by the electronic device; and
 - a tip which includes:
 - an input side which is removeably coupleable to the second end of the cable; and
 - an output side which is removeably coupleable to the electronic device, the output side having a shape and size dependent on the shape and size of a power input opening of the electronic device,

wherein the tip provides the DC power and the data signal to the electronic device via conductive lines.

2. The power supply equipment of claim 1, the tip further comprising a single signaling line and a ground reference line, wherein the data signal is transmitted to the electronic device via the single signaling line relative to the ground reference for the DC power. 5

3. The power supply equipment of claim 1 including a second tip having a second input side which is removeably coupleable to the second end of the cable and having a second output side which is removeably coupleable to the second electronic device, the second output side of the second tip having a shape and size dependent on the shape and size of a power input opening of the second electronic device, wherein the second tip provides the DC power to the second electronic device. 10 15

* * * * *