

ASSORTMENT INDEX

| | |
|-------------------------------------|--|
| Acorn Cap Nuts | 2712 |
| Adapters, Hydraulic | 2590-2591 |
| Adhesives | 2646 |
| Allthread | 2610 |
| Anchors | 2555, 2558, 2716 |
| | |
| Batteries | 2513 |
| Battery Lugs | 2507, 2511 |
| Battery Terminals | 2510 |
| Bolts | |
| Body..... | 2643 |
| Carriage..... | 2606, 2612, 2639 |
| Flange..... | 2593, 2595, 2600, 2606, 2240 |
| JIS Head..... | 2595 |
| Metric Flange..... | 2598-2599 |
| Metric Hex Cap..... | 2597-2598, 2607-2609 |
| SAE Hex Cap.... | 2596,2601,2603,2605,2612 |
| Stainless..... | 2632-2635, 2637 |
| USS Hex Cap.... | 2596,2602,2603,2604,2611 |
| Brass Fittings | |
| Brakeline Adapters..... | 2576, 2578-2579, 2724-2725 |
| Compression..... | 2573 |
| Hose Barbs..... | 2576 |
| Inverted Flare..... | 2574 |
| NTA..... | 2575, 2580-2581 |
| Pipe..... | 2574 |
| Press-to-Connect..... | 2577 |
| Prestolok..... | 2578 |
| SAE Flare..... | 2573 |
| | |
| Cable Wire Ties | 2506, 2512, 2728 |
| Caplugs | 2592 |
| Carbide Burs | 2726 |
| Carriage Bolts | 2606, 2612, 2639 |
| Chain Links | 2539 |
| Circuit Breakers | 2511 |
| Clevis Pins | 2536 |
| Concrete Screw Anchors | 2555, 2558 |
| Copper Lugs | 2507 |
| Copper Washers | 2729 |
| Cotter Pins | 2537-2538, 2704 |
| | |
| Dies & Taps | 2566 |
| Disc Lock Washers | 2621 |
| Dowel Pins | 2629 |
| Drywall Screws | 2521, 2709 |
| | |
| E-Rings | 2545, 2705 |
| Easy Outs | 2726 |
| Extractors | 2713 |
| | |
| Fender Washers | 2620 |
| | |
| Files | 2567 |
| Flange Bolts | 2593, 2595, 2598-2599 2600, 2606, 2240 |
| Flap Wheels | 2565 |
| Flat Head Socket Caps | 2625, 2629 |
| Fuses | 2640, 2644, 2647, 2717, 2720, 2724, 2726-2728 |
| | |
| Grease Fittings | 2645, 2721 |
| Grommets | 2645, 2721 |
| | |
| Hairpins | 2535, 2705 |
| Heat Shrink Tubing | 2513, 2701 |
| Heli-Coils | 2642 |
| Hole Saws | 2567-2568 |
| Hose Clamps | 2552-2555 |
| Hydraulic Adapters | 2590-2591 |
| Hydraulic O-rings | 2592 |
| | |
| John Guest Fittings | 2579 |
| | |
| Keenserts | 2569 |
| Keystock | 2540 |
| Krimp-N-Seals | 2503-2504, 2700 |
| | |
| Locknuts | 2615-2616 |
| Low Head Socket Caps | 2631 |
| Lynch Pins | 2535 |
| | |
| Machine Screws | |
| Flat Head..... | 2528, 2633 |
| Metric..... | 2529 |
| Pan Head..... | 2525-2526 |
| Round Head..... | 2526-2527 |
| Stainless..... | 2633, 2635 |
| Mounted Stones | 2565 |
| | |
| Nutserts | 2570 |
| Nuts, Small | 2616 |
| Nylon Flat Washers | 2725 |
| Nylon Locknuts | 2615-2616 |
| Nylon Ties | 2512 |
| | |
| O-Rings | 2546-2549, 2592, 2705 |
| | |
| Paint Markers | 2716 |
| Pipe Fittings | 2584-2589 |
| | |
| Reciprocating Blades | 2569, 2713 |
| Retainers | 2643 |
| Retaining Rings | 2544-2545, 2708 |
| Rivets | 2559 |

ASSORTMENT INDEX

| | |
|---|-----------------------------|
| Roll Pins | 2533-2534, 2704 |
| Rolon Sanding Discs | 2564 |
| Rolon Surface Conditioning Discs | 2564 |
| Screwdriver Bits | 2716 |
| Self Threading Nuts | 2724 |
| Serrated Flange Bolts | 2593 |
| Set Screws | 2627-2628, 2638, 2701 |
| Sheet Metal Screws | |
| Black..... | 2522 |
| Hex Head..... | 2517, 2636 |
| Oval Head..... | 2638 |
| Pan Head..... | 2518, 2636 |
| Tek Screws..... | 2519-2520, 2522, 2639, 2709 |
| Thread Cutters..... | 2521 |
| Shrink Tubing | 2513, 2701 |
| Snap Pins | 2535 |
| Snap Rings | 2544-2545, 2708 |
| Socket Head Cap Screws | 2624-2626 |
| | 2630, 2637 |
| Button Head..... | 2239, 2634 |
| Flat Head..... | 2625, 2629 |
| Low Head..... | 2631 |
| Spring Lock Pins | 2533-2534, 2704 |
| Springs | 2642 |
| Stainless Products | 2632-2639 |
| Star Washers | 2621, 2712 |
| Stover Locknuts | 2615-2616 |
| Studs, Metric | 2640 |
| Switches | 2511 |
| | |
| Tap & Dies | 2566 |
| Taps | 2713 |
| Tee Nuts | 2712 |
| Tek Screws | 2519-2520, 2522, |
| | 2639, 2709, 2729 |
| Terminals | |
| Battery..... | 2510 |
| Delphi Packard..... | 2506 |
| Non-Insulated..... | 2505 |
| Nylon..... | 2500-2501, 2700 |
| Plastic..... | 2501-2502, 2700 |
| Shrink..... | 2503-2504, 2700 |
| Wire Nuts..... | 2505 |
| Thread Cutting Screws | 2521 |
| Threaded Rod | 2610 |
| Trim Clips | 2643 |
| Tubing Clamps | 2554 |
| | |
| Vacuum Connectors | 2641, 2720 |
| | |
| Well Nuts | 2729 |

| | |
|----------------------------|------------------|
| Wire Ends | |
| Delphi Packard..... | 2506 |
| Non-Insulated..... | 2505 |
| Nylon..... | 2500-2501, 2700 |
| Plastic..... | 2501-2502, 2700 |
| Shrink..... | 2503-2504, 2700 |
| Wire Nuts..... | 2505 |
| Wire Nuts | 2505 |
| Wire Ties | 2506, 2512, 2728 |
| | |
| Woodruff Keys | 2536, 2704 |
| Wood Screws | 2520 |
| | |
| Zerks | 2645, 2721 |

STORAGE BINS

OPEN HOLE BINS

(Heavy Duty Metal)

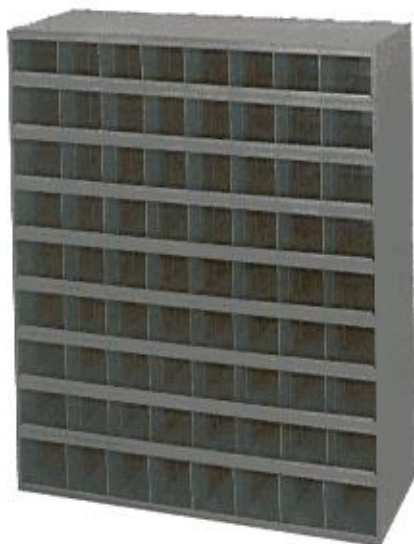

38177 (72 HOLES)



38190 (42 HOLES)

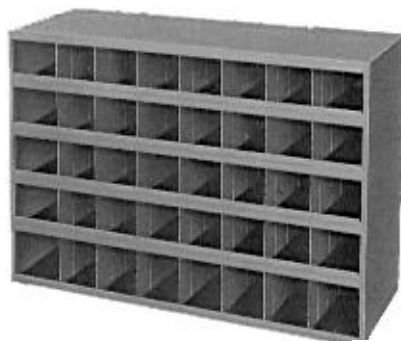

38176 (40 HOLES)
& ZZNS40

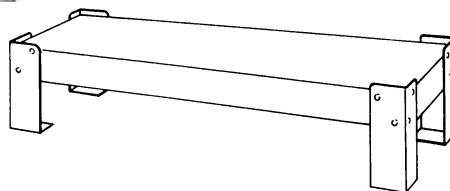

38288, 38443
41432 & 41431

| J&B # | OPENINGS | HEIGHT | WIDTH | DEPTH |
|--------|---|---------|--------------------------------------|-------|
| 38176 | 40 | 23-7/8" | 33-3/4" | 12" |
| ZZNS40 | 40 | 24" | 36" | 12" |
| *38190 | 42 | 42" | 33-3/4" | 12" |
| *38177 | 72 | 42" | 33-3/4" | 12" |
| 38288 | BASE STAND FOR EITHER HEIGHT = 5-3/4 | | #38176, #38177, #38190, OR #38418 | |
| 38446 | BASE STAND FOR EITHER HEIGHT = 12" | | #38176, #38177, #38190, OR #38418 | |
| 41432 | BASE STAND FOR ZZNS40 | | HEIGHT = 4" | |
| 41431 | BASE STAND FOR ZZNS40 | | HEIGHT = 12" | |

* 72 AND 42 HOLE BINS CANNOT SHIP UPS.

STORAGE BINS

4 DRAWER RACK (Heavy Duty Metal)

- Features four slide-out drawers for use with large drawers.

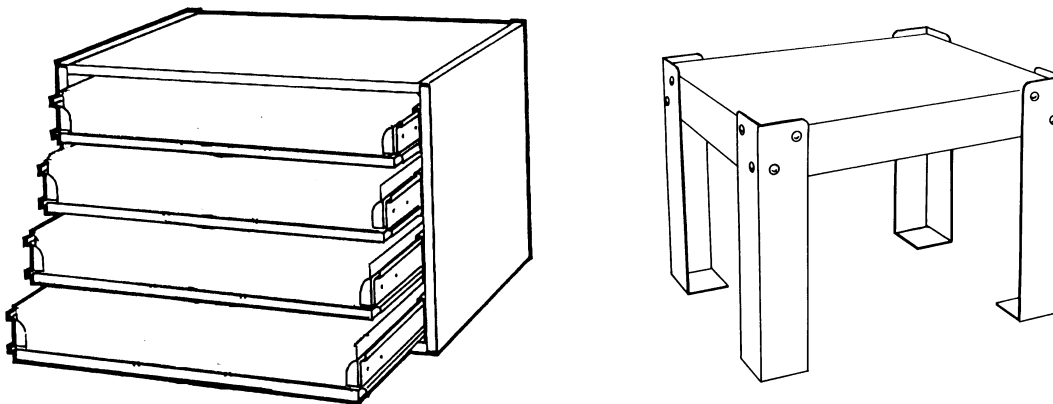

| J&B # | DESCRIPTION | HEIGHT | WIDTH | DEPTH |
|-------|----------------|---------|---------|---------|
| 38409 | H/D RACK | 15" | 20" | 15-3/4" |
| 38417 | RACK | 15" | 20-1/4" | 12-1/2" |
| 38283 | H/D BASE STAND | 15-5/8" | 20-5/8" | 16-1/4" |
| 38287 | BASE STAND | 15-5/8" | 20-5/8" | 12-5/8" |
| 38290 | BASE STAND | 5-3/4" | 20-3/8" | 12-5/8" |
| 38277 | H/D BASE STAND | 5-3/4" | 20-5/8" | 16-1/4" |

18 DRAWER CABINET (Heavy Duty Metal)

- Each drawer includes 2 dividers.

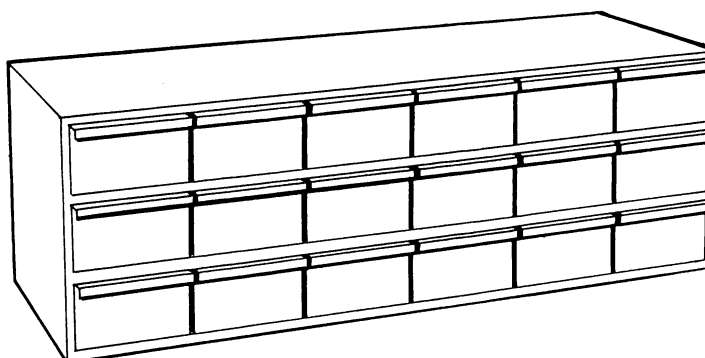

| EXTRA DIVIDERS | |
|----------------|-----|
| J&B # | QTY |
| 41306 | 12 |
| * 41307 | 12 |

* FOR DURHAM CABINETS

| J&B # | HEIGHT | WIDTH | DEPTH |
|-------|---------|---------|---------|
| 38418 | 10-7/8" | 33-3/4" | 11-5/8" |

STORAGE BINS

LARGE DRAWERS (Heavy Duty Metal)

- Round bottom “Scoop-Out” compartments.
- Excellent for storing small parts of all kinds.
- Comes with handle and pull down catch.

| DIMENSIONS | | |
|------------|-------|-------|
| HEIGHT | WIDTH | DEPTH |
| 3" | 18" | 12" |

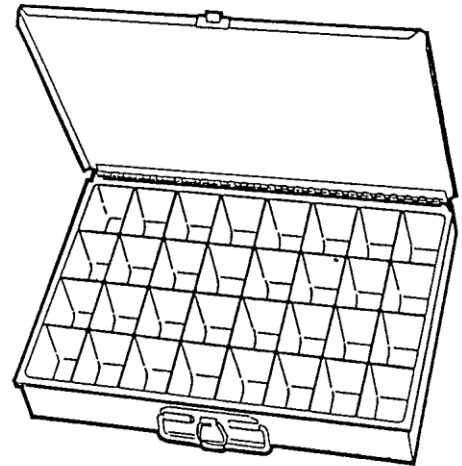

12-HOLE

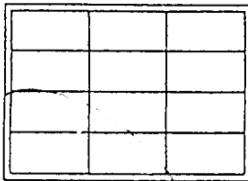

J&B #38279

21-HOLE

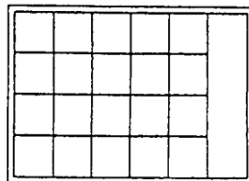

J&B #38280

24-HOLE

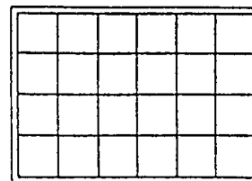

J&B #38178

32-HOLE

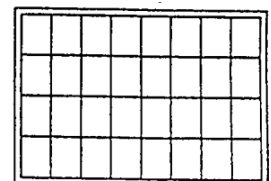

J&B #38282

ADJUSTABLE LARGE DRAWERS (Heavy Duty Metal)

VERTICAL

- Four vertical partitions; each partition is slotted on 1" centers.
- 9 dividers are provided with each box.

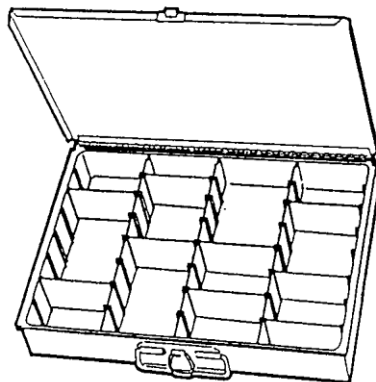

| EXTRA DIVIDERS | |
|----------------|-----|
| J&B # | QTY |
| 41305 | 9 |

| J&B # | QTY |
|-------|-----|
| 38281 | EA |

HORIZONTAL

- Six horizontal partitions; each partition is slotted on 2-1/4" centers.
- 12 dividers are provided with each box.

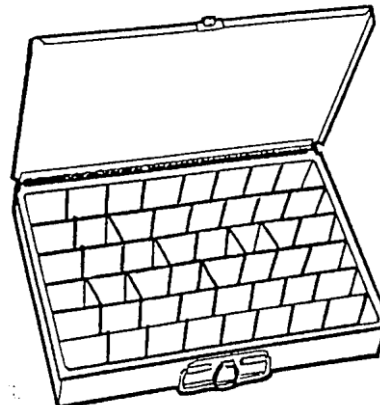

| EXTRA DIVIDERS | |
|----------------|-----|
| J&B # | QTY |
| 41304 | 12 |

| J&B # | QTY |
|-------|-----|
| 38293 | EA |

STORAGE BINS

KEYSTOCK RACK

(Heavy Duty Metal)

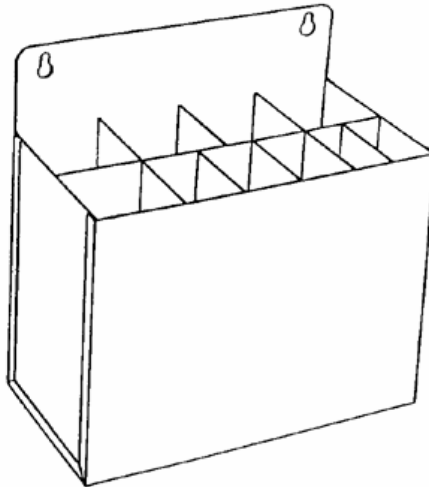

| J&B # | HEIGHT | WIDTH | DEPTH |
|-------|--------|---------|--------|
| 38444 | 12" | 12-1/4" | 6-1/4" |

THREADED ROD RACK

(Heavy Duty Metal)

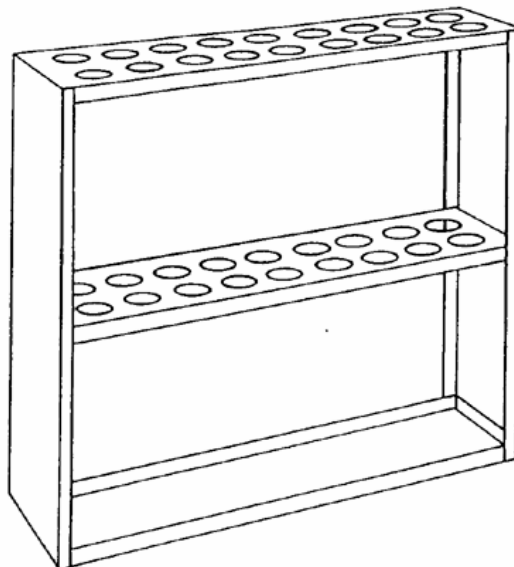

| J&B # | HEIGHT | WIDTH | DEPTH |
|-------|--------|---------|--------|
| 38443 | 24" | 24-1/8" | 6-7/8" |

STORAGE BINS

HOSE CLAMP RACKS

(Heavy Duty Metal)

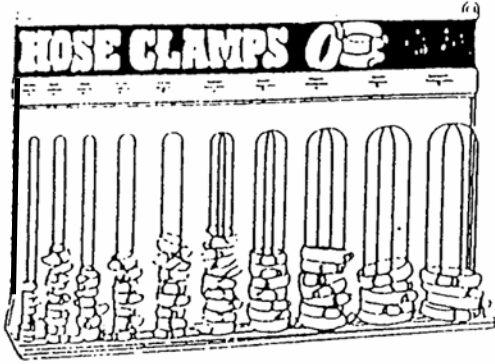

| J&B # | QTY |
|-------|-----|
| 38295 | EA |

*This rack is capable of holding industry sizes 4,5,6,10,12,16,20,28,32, and 36

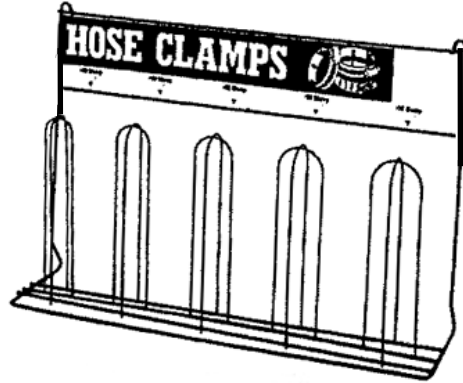

| J&B # | QTY |
|-------|-----|
| 38296 | EA |

*This rack is capable of holding industry sizes 40,48,52,56 and 72

WIRE RACK & HOSE RACK

(Heavy Duty Metal)

- Equipped with four (4) removable dowels.
- 30" ruler on the outer side of the rack assists in quick measuring.

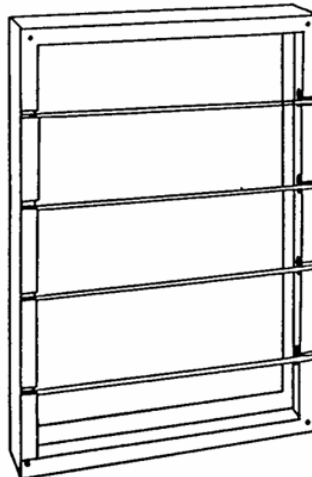

| J&B # | HEIGHT | WIDTH | DEPTH |
|-------|---------|---------|-------|
| 38289 | 37-1/8" | 26-1/8" | 6" |



STORAGE BINS

AEROSOL / UTILITY CABINETS

- Featuring two adjustable shelves and a lock attachment.
- Padlock not provided.
- Keyhole slots allow easy wall mounting.



| J&B # | DESCRIPTION | HEIGHT | WIDTH | DEPTH |
|-------|------------------|---------|---------|---------|
| 38696 | UTITLITY CABINET | 32-3/4" | 19-7/8" | 14-1/4" |

BULB CABINET

- 32 clear, rugged plastic trays.

| J&B # | SIZE | QTY |
|-------|----------------------|-----|
| 20942 | 19" W 26-3/4" H 4" D | EA |



STORAGE BINS

SMALL PLASTIC BOXES

- Resists solvents such as gasoline, oil and most common chemicals.
- Comes with 2 snap latches to assure closure.



6 HOLE

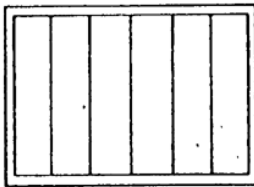

J&B #38284

12 HOLE

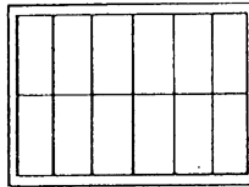

J&B #38285

18 HOLE

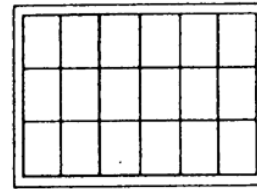

J&B #38286

| DIMENSIONS | | |
|------------|-------|--------|
| HEIGHT | WIDTH | DEPTH |
| 1-3/4" | 11" | 6-3/4" |

SMALL DRAWER COMPARTMENT BOX

- Prime cold rolled steel; durable gray powder coat finish.
- Keyhole slots on back allow mounting on walls and panels.
- Offset handle allows easy transport.
- Holds 5 boxes. (Not included)

| J&B # | HEIGHT | WIDTH | DEPTH |
|-------|---------|---------|--------|
| 38426 | 11-1/4" | 10-3/4" | 6-3/4" |

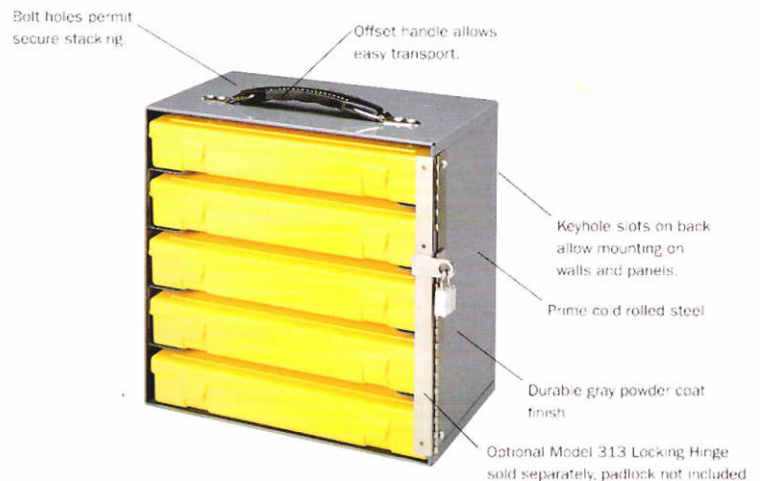

STORAGE BINS

DRILL DISPENSERS

- Sizes stamped into metal on front of each compartment.

| J&B # | DESCRIPTION | HEIGHT | WIDTH | DEPTH |
|---------|-------------|--------|---------|--------|
| 38690 | FRACTIONAL | 7-3/4" | 14-5/8" | 7-3/8" |
| * 38691 | NUMBER | 7-3/4" | 14-5/8" | 7-3/8" |
| * 38692 | LETTER | 7-1/4" | 14-1/2" | 7-1/4" |

* J&B #38690 is in stock, J&B #38691 & #38692 must be special ordered

#38690 - Holds 29 fractional drill sizes 1/16 to 1/2 by 64ths.

#38691 - Holds 60 number drill sizes 1 to 60.

#38692 - Holds 26 letter drill sizes A to Z.

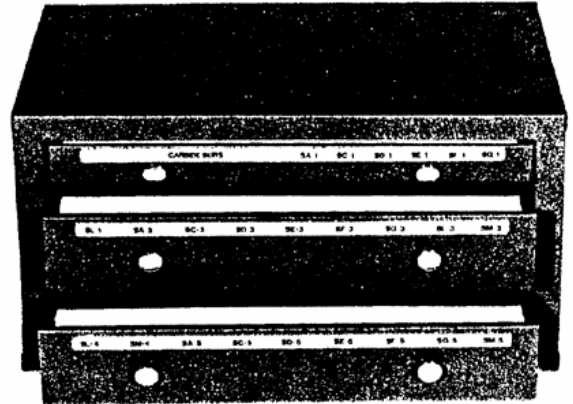

EMPTY DRILL INDEX BOXES

| J&B # | HOLES SIZES . . . |
|-------|---------------------|
| 20561 | 1/16 - 1/4 by 64ths |
| 20562 | 1/16 - 1/2 by 64ths |
| 20563 | 1/16 - 1/2 by 32nds |
| 20564 | #1 - 60 |
| 20565 | A - Z |
| 41183 | 9/16 - 1" (8 sizes) |

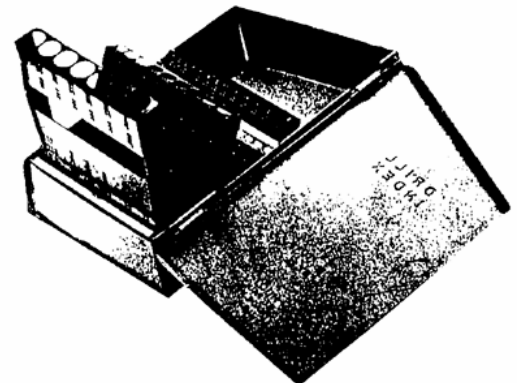

STORAGE BINS

TAP DISPENSERS

- Sizes stamped into metal on front of each compartment.

| J&B # | DESCRIPTION | HEIGHT | WIDTH | DEPTH |
|---------|---------------|--------|---------|--------|
| * 38693 | FRACTIONAL | 7-3/4" | 14-5/8" | 7-3/8" |
| * 38694 | MACHINE SCREW | 7-3/4" | 14-5/8" | 7-3/8" |
| * 38695 | METRIC | 7-3/4" | 14-5/8" | 7-3/8" |

J&B #38693, #38694, & #38695 must be special ordered.

#38693 Holds 10 coarse and 10 fine
(NON-STOCK) fractional tap sizes from 1/4 through 1".

#38694 Each size holds taper, plug, bottoming,
(NON-STOCK) spiral point taps. 60 compartments. Holds
machine screw sizes 2-56 through 12-28.

#38695 Holds 29 popular metric sizes from
(NON-STOCK) 3mm x .50 through 18mm x 2.50.

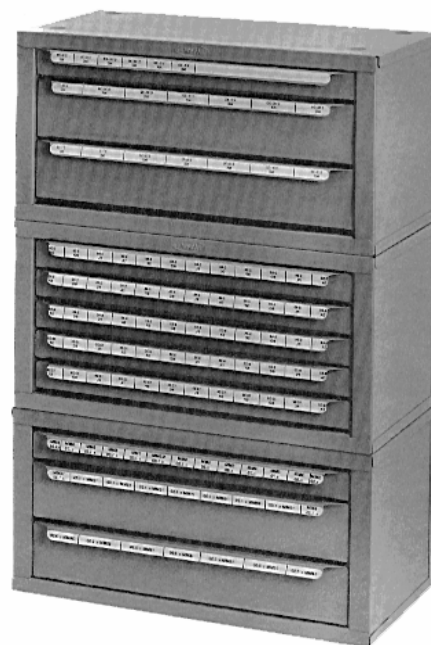

SALES AIDS

| J&B # | ITEM | QTY |
|--------|--------------------------------|-------------|
| 0001 | HAT | EA |
| 0003 | PEN | EA |
| 0005 | SCRATCH PADS | EA |
| 0007 | BOLT GAUGES | EA |
| 0009 | LIGHTERS | EA |
| 0011 | DRINK MUG 22 OZ. | EA |
| 0013 | PRODUCT CARD | 50 |
| 0014 | NSN PRODUCT CARD | EA |
| 0015 | TAP & DRILL CHART | 50 |
| 0017 | J&B FOIL LABELS (WITHOUT NAME) | EA |
| SP | J&B FOIL LABELS (WITH NAME) | ROLL / 1000 |
| 0037 | J&B DECALS (10" x 8") | EA |
| 0041 | PLASTIC SLEEVE BACKINGS | EA |
| * 0042 | BIN BOX 4 x 2 x 12 | 50/CS |
| * 0043 | BIN BOX 4 x 3 x 12 | 50/CS |
| * 0045 | BIN BOX 4 x 4 x 12 | 50/CS |
| * 0047 | BIN BOX 4 x 6 x 12 | 50/CS |
| * 0049 | BIN BOX 4 x 10 x 12 | 25/CS |
| * 0050 | BIN BOX 4 x 12 x 12 | 50/CS |
| * 0053 | BIN BOX 4 x 3 x 18 | 25/CS |
| * 0054 | BIN BOX 4 x 4 x 18 | 50/CS |
| * 0055 | BIN BOX 4 x 6 x 18 | 50/CS |
| * 0056 | BIN BOX 4 x 10 x 18 | 25/CS |
| 0051 | J&B BROWN ENVELOPES | 25 |
| 0052 | DRILL SET LABELS FOR CABINETS | 10 |

* ONLY FULL CASES CAN BE SHIPPED UPS/FEDEX



LABELS

| BOLTS | |
|-------|-----------------------------------|
| J&B # | ITEM |
| 0019 | USS G-5 HEX CAPS (185) |
| 0161 | USS G-5 HX CAP SMALL PACK (102) |
| 0020 | USS G-5 BIG HEX CAPS (63) |
| 0021 | SAE G-5 HEX CAPS (169) |
| 0162 | SAE G-5 HX CAP SMALL PACK (69) |
| 0022 | SAE G-5 BIG HEX CAPS (33) |
| 0023 | USS G-8 HEX CAPS (168) |
| 0024 | USS G-8 BIG HEX CAPS (126) |
| 0025 | SAE G-8 HEX CAPS (159) |
| 0026 | SAE G-8 BIG HEX CAPS (83) |
| 0029 | 8.8 METRIC HEX CAPS (174) |
| 0184 | JIS 8.8 METRIC HEX CAPS (12) |
| 0035 | STAINLESS STEEL HEX CAPS (95) |
| 0036 | CARRIAGE BOLTS (71) |
| 0180 | CARRIAGE BOLTS STAINLESS (20) |
| 0185 | CARRIAGE BOLTS G-5 (15) |
| 0085 | FLANGE BOLTS (41) |
| 0179 | SERRATED FLANGE BOLTS (18) |
| 0136 | 10.9 METRIC FLANGE BOLTS (14) |
| 0176 | 10.9 JIS METRIC FLANGE BOLTS (34) |
| 0086 | LAG SCREWS/SHIELDS (46) |
| 0102 | 10.9 METRIC HEX CAPS (135) |
| 0107 | EYE BOLTS (10) |
| 0108 | ELEVATOR BOLTS (13) |

| NUT & WASHERS | |
|---------------|-------------------------------|
| J&B # | ITEM |
| 0080 | STOVER LOCKNUTS (23) |
| 0081 | NYLON LOCKNUTS (33) |
| 0082 | CASTLE / SLOTTED NUTS (20) |
| 0109 | HIGH NUTS (9) |
| 0110 | HEAVY HEX NUTS (17) |
| 0111 | JAM NUTS (22) |
| 0112 | ROD COUPLING NUTS (10) |
| 0113 | KEPS NUTS (11) |
| 0114 | SERRATED FLANGE NUTS Z/P (12) |
| 0115 | BEVELED WASHERS (4) |
| 0116 | FENDER WASHERS (23) |
| 0183 | FENDER WASHERS STAINLESS (10) |
| 0115 | BEVELED WASHERS (4) |

| HYDRAULICS | |
|------------|--------------------------------|
| J&B # | ITEM |
| 0084 | 37°METRIC FLARE ADAPTERS (28) |
| 0087 | 71 SERIES (62) |
| 0088 | 78 SERIES (52) |
| 0089 | 43 SERIES METRIC (43) |
| 0090 | 43 SERIES (186) |
| 0091 | 55 SERIES (38) |
| 0092 | 20 SERIES (59) |
| 0093 | 90 SERIES (5) |
| 0094 | 88 SERIES (6) |
| 0095 | 91 SERIES (13) |
| 0096 | 37° FLARE ADAPTERS (167) |
| 0097 | 37° FLARE O-RING ADAPTERS (81) |
| 0098 | FEMALE SWIVEL ADAPTERS (56) |
| 0099 | HYDRAULIC PIPE ADAPTERS (80) |
| 0105 | SEALOK FITTINGS (33) |

| PIPE | |
|-------|-----------------------------|
| J&B # | ITEM |
| 0031 | BLACK PIPE 1-8" – 1" (156) |
| 0135 | BLACK PIPE 1-1/4" – 2" (79) |
| 0032 | GALVANIZED PIPE (123) |
| 0103 | HEAVY DUTY BLACK PIPE (106) |

| SOCKET PRODUCTS | |
|-----------------|-----------------------------------|
| J&B # | ITEM |
| 0072 | SOCKET CAP SCREWS (140) |
| 0119 | SOCKET CAP FINE SCREWS (36) |
| 0073 | FLAT SOCKET CAPS (70) |
| 0120 | BUTTON HEAD SOCKET CAPS (36) |
| 0074 | SHOULDER BOLTS (57) |
| 0078 | METRIC SOCKET CAPS (66) |
| 0181 | METRIC SOCKET CAPS STAINLESS (17) |
| 0178 | METRIC FLAT SOCKET CAPS (22) |
| 0121 | HEX SOCKET PIPE PLUGS (7) |
| 0122 | DOWEL PINS (59) |
| 0123 | STAINLESS SOCKET CAPS (35) |

| BRASS | |
|-------|---------------------------|
| J&B # | ITEM |
| 0060 | BRASS PIPE (102) |
| 0061 | BRASS SAE 45° FLARE (83) |
| 0062 | BRASS NTA (71) |
| 0063 | BRASS COPPER TUBE (46) |
| 0064 | REUSEABLE-AIR BRAKE (19) |
| 0065 | PUSH-LOK (36) |
| 0066 | BRASS COMPRESSION (95) |
| 0067 | BRASS INVERTED FLARE (79) |
| 0068 | PRESTOLOK (35) |
| 0132 | HOSE BARBS (23) |
| 0175 | HEATER HOSE BARBS (6) |
| 0069 | VALVES (19) |
| 0165 | BALL VALVES (8) |
| 0166 | TRUCK VALVES (6) |
| 0177 | PRESS-TO-CONNECT (65) |

| WHEEL WEIGHTS & ANCHORS | |
|-------------------------|-------------------------|
| J&B # | ITEM |
| 0070 | REGC WHEEL WEIGHTS (12) |
| 0139 | AWC WHEEL WEIGHTS (12) |
| 0140 | MCC WHEEL WEIGHTS (12) |
| 0141 | LHC WHEEL WEIGHTS (12) |
| 0142 | TSC WHEEL WEIGHTS (12) |
| 0143 | ENC WHEEL WEIGHTS (8) |
| 0144 | FNC WHEEL WEIGHTS (12) |
| 0145 | IAWC WHEEL WEIGHTS (12) |
| 0129 | SLEEVE ANCHORS (15) |
| 0130 | WEDGE ANCHORS (9) |
| 0131 | TOGGLE ANCHORS (11) |

| MISC. | |
|-------|---------------------------------|
| J&B # | ITEM |
| 0100 | TUBE CLAMPS (16) |
| 0101 | CHEMICALS (OLD) |
| 0106 | BULBS (70) |
| 0117 | WHEEL NUTS & STUDS (17) |
| 0118 | DRYWALL SCREWS (11) |
| 0124 | WIRE ROPE CLIPS & THIMBLES (18) |
| 0125 | SNAP & LYNCH PINS (12) |
| 0126 | CLEVIS HOOKS (10) |
| 0127 | CLEVIS PINS (40) |
| 0128 | RIVETS (25) |
| 0133 | HOSE CLAMPS STANDARD (24) |
| 0134 | HOSE CLAMPS LINER (13) |
| 0182 | HOSE CLAMPS ALL STAINLESS (18) |
| 0186 | CONSTANT TORQUE CLAMPS (10) |
| 0167 | ROLON CONDITIONING DISCS (14) |
| 0168 | ROLON SANDING DISCS (18) |
| 0169 | PRIMARY WIRE (48) |
| 0170 | WIRE LOOM (6) |
| 0187 | LOOM CLAMPS CARBON STEEL (8) |
| 0188 | LOOM CLAMPS STAINLESS STEEL (8) |

ZZNS ITEMS

| J&B # | DESCRIPTION | QTY |
|---------|---|----------|
| ZZNS48 | Teflon Hose 48" 919-12 with 42214 on each end | EA |
| ZZNS115 | Repair kits Parker # 14K | EA |
| ZZNS126 | DEL702 1/4 Fabric loom | 100FT/RL |
| ZZNS146 | HX CP GR8 NF 1 x 3 plain (1/4Kg only) | 65/BX |
| ZZNS147 | HX CP GR8 NF 1 x 3-1/2 plain (1/4Kg only) | 60/BX |
| ZZNS148 | HX CP GR8 NF 1 x 4 plain (1/4Kg only) | 50/BX |
| ZZNS272 | Gold Plate Weekend Paint K346 Net Wt 11 Oz. | 6/CS |
| ZZNS510 | Water filter pleated cartridge 20 micron | 24/CS |