

FOR THE  
OF THE

# GOOD PEOPLE

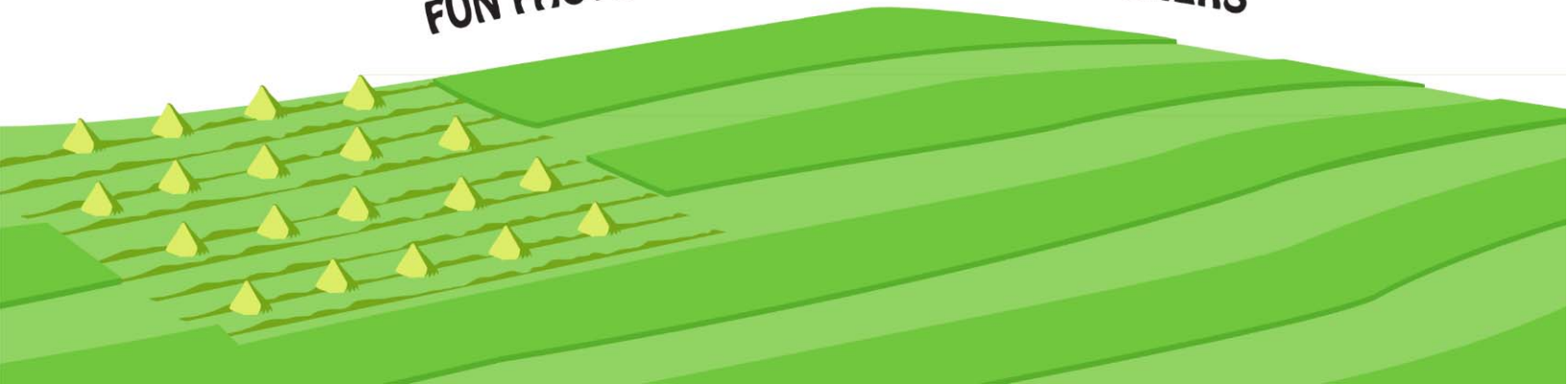

FUN FACTS ABOUT FARMERS & RANCHERS



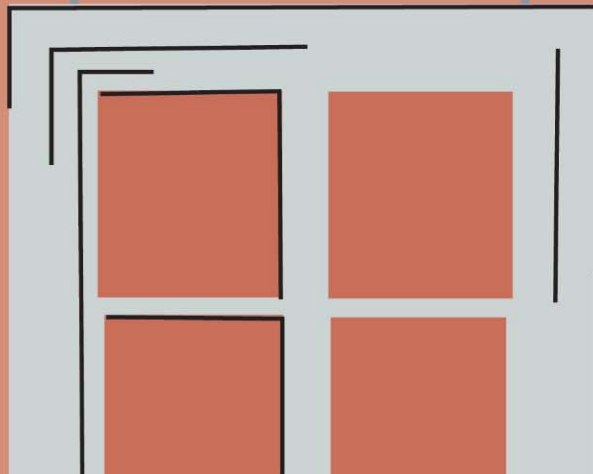
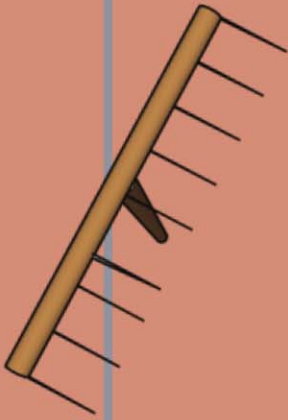
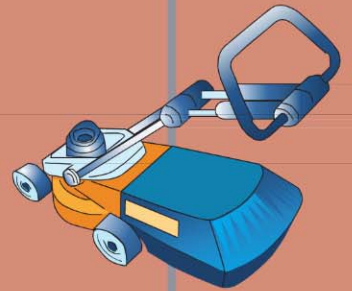
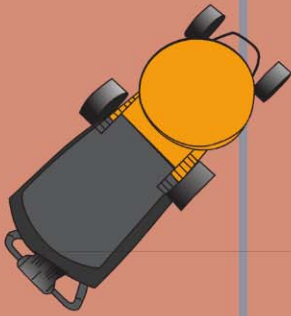
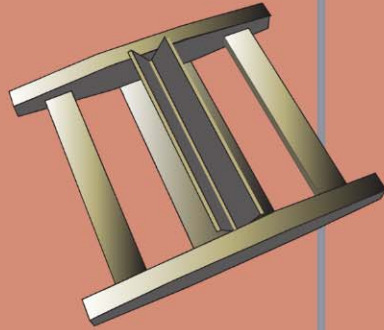

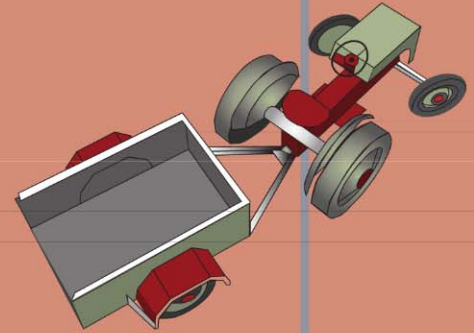
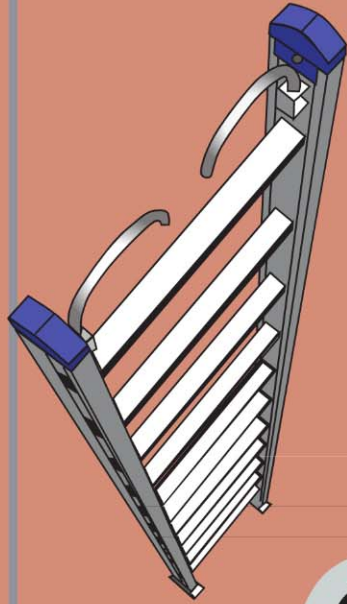

FOR THE **GOOD**  
OF THE **PEOPLE**

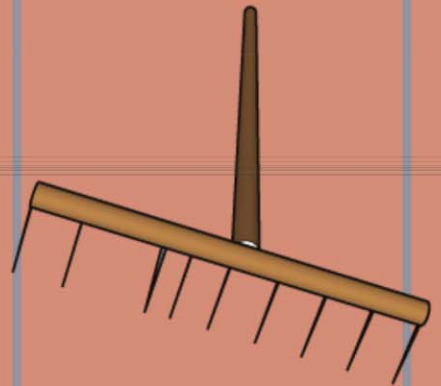
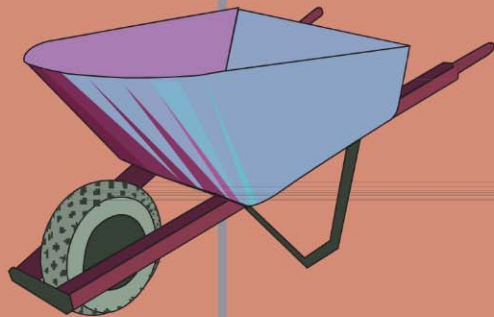

# INTRODUCTION

For thousands of years, civilization has built upon a foundation laid by farmers. Today's American farmers and ranchers produce an abundance of food and fiber, as well as flowers, fish, forest products, forage, and fuel. This bounty is provided to American consumers at prices that are among the lowest in the world. Much of it is exported, helping feed people around the globe.

TODAY, **ONE** AMERICAN FARMER PRODUCES ENOUGH FOOD TO FEED MORE THAN **144 PEOPLE**.

The information in this booklet helps tell the story of AMERICA'S FARMERS AND RANCHERS and illustrates the importance of agricultural products in our lives. It also illustrates the need to conserve, sustain, and improve the natural resources that future generations of American farmers and ranchers will need to continue providing food and clothing for a growing population.

The United States Department of Agriculture's (USDA) Natural Resources Conservation Service (NRCS) has the opportunity to work one-on-one with America's farmers and ranchers to help protect the long-term health of soil, water, air, plant, and animal resources. NRCS is pleased to present this information so that you, too, can see just some of what farmers and ranchers do FOR THE GOOD OF THE PEOPLE.



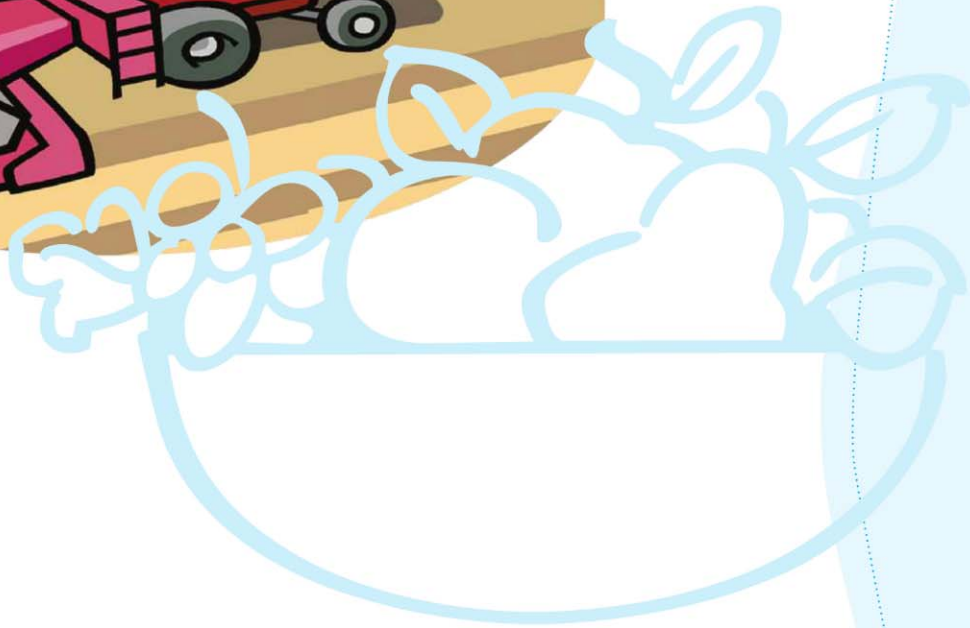

# FOOD IS MOST AFFORDABLE IN THE UNITED STATES



**M**ost of the food we eat is grown by farmers right here in the United States. That means we do not have to pay other countries to send it to us.

Abundant soil and water is what separates the United States from other countries that cannot grow enough food for their people. However, we must protect against taking our natural resources for granted. Some areas of the world once had fertile cropland that, over time, was transformed into wasteland because of careless use of the land.

This chart shows us that we spend approximately 10 percent of our income on food here in the United States, while people in India spend more than **HALF OF THEIR INCOME** for the same amount of food!

United States <b>10%</b>	England <b>11.2%</b>
Japan <b>17.6%</b>	France <b>14.8%</b>
Italy <b>17.2%</b>	Mexico <b>24.5%</b>
South Africa <b>27.5%</b>	India <b>51.3%</b>

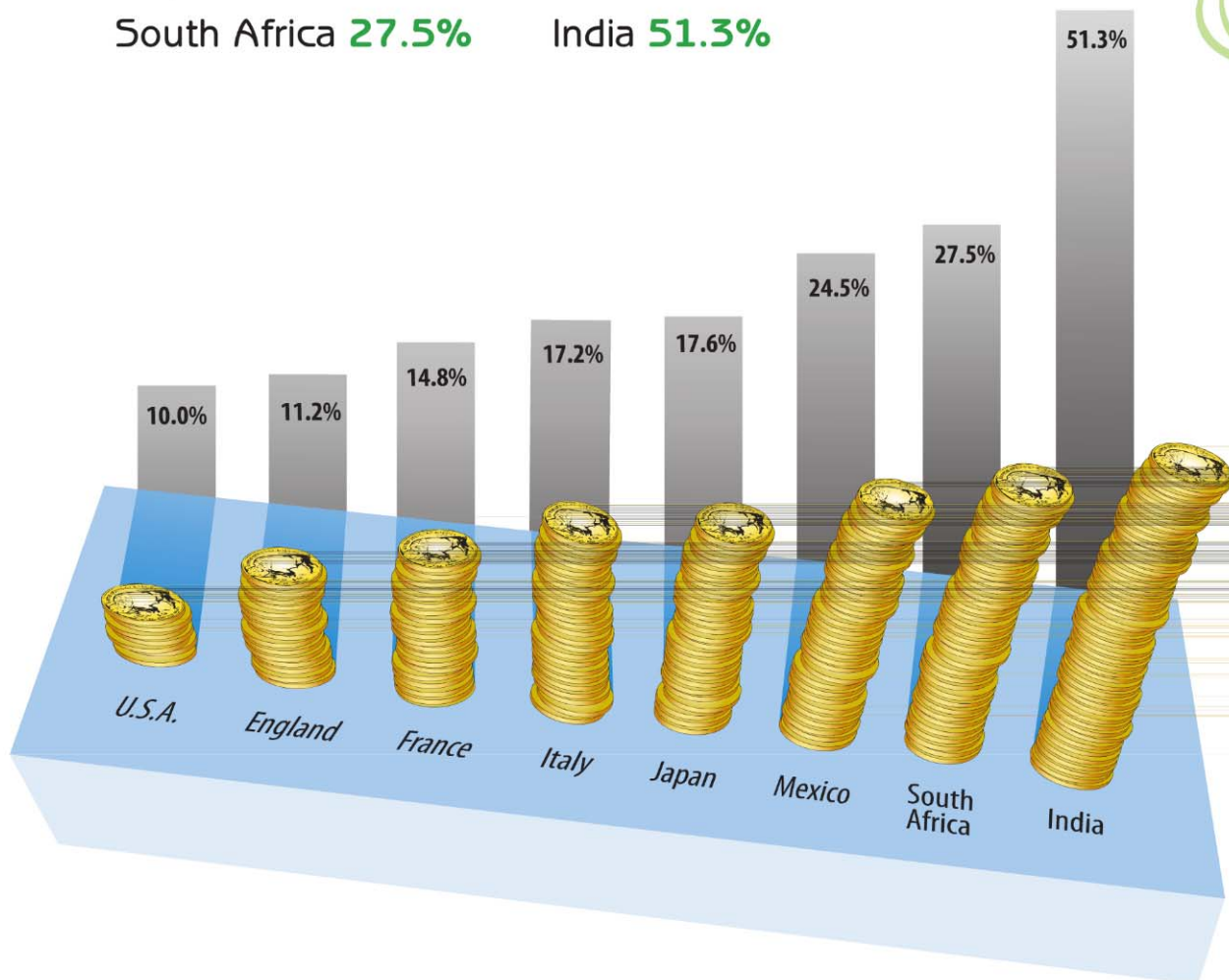



he late Walter Lowdermilk, an early leader in the United States' soil conservation movement, studied records of agriculture in countries where the land had been cultivated for hundreds, even thousands, of years. He discovered that soil erosion, deforestation, overgrazing, and neglect helped topple empires and wipe out entire civilizations. At the same time, he learned that careful stewardship of the Earth's resources has enabled other societies to flourish for centuries.

THE MESSAGE IS SIMPLE:  
IF NATURAL RESOURCES ARE DEPLETED AT A FASTER RATE  
THAN THEY CAN REPLENISH THEMSELVES, THEY EVENTUALLY  
WILL DISAPPEAR.

Fortunately, American farmers and ranchers understand. Through their voluntary use of soil and water conservation practices, they show that they are committed to making sure future generations of Americans will have plenty of affordable food.



## OUR BEST CUSTOMERS

**E**very year, other countries spend billions of dollars on American products, including food and grain produced by our farmers and ranchers. Four of our best customers are shown below. The money we receive from countries in exchange for our products is money we can use for other things.

For example: \$10.3 billion (almost as much as Canada spends on American products each year) could buy every man, woman, and child in the United States about **35 HAMBURGERS!**

JAPAN **\$7.9 BILLION**

CANADA **\$10.6 BILLION**

EUROPEAN UNION **\$6.8 BILLION**

MEXICO **\$9.4 BILLION**



# U.S. SHARE OF WORLD PRODUCTION

The United States produces a lot of the products used worldwide. Here is a breakdown:

SOYBEANS **38.7%**

WHEAT **9.2%**

COTTON **18.3%**

CORN **40.9%**

RICE **1.6%**

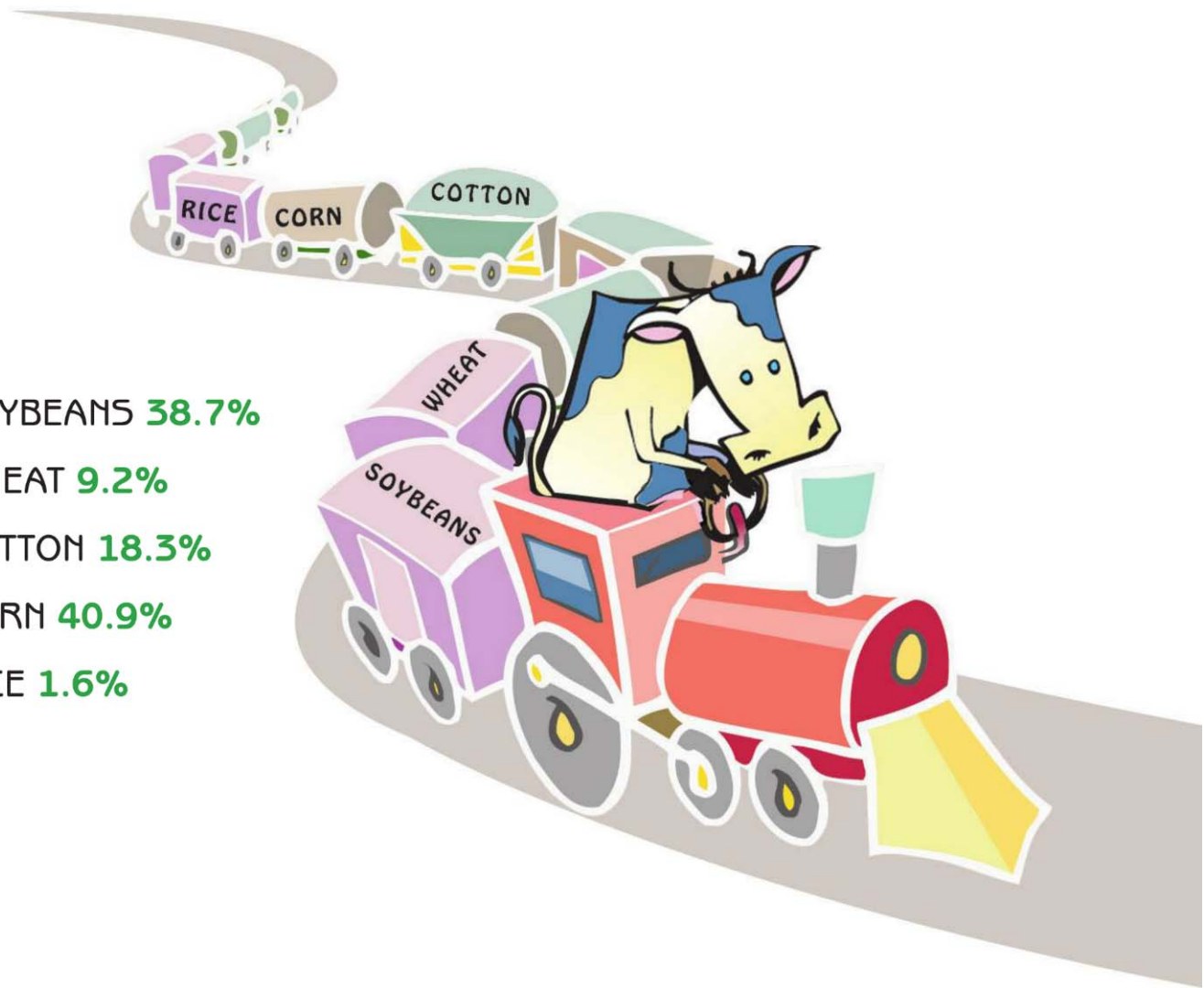

## WHO OWNS THE LAND?

There are nearly **2 BILLION ACRES** of land in the 48 connected States. How big is that? Well, 1 acre is about the size of a football field. This means we could fit nearly **2 BILLION FOOTBALL FIELDS** within the borders of the United States.

About 70 percent of that land is privately owned, and its care is in the hands of those who live and work on it. Most of that land, 1.4 billion acres, is managed by farmers and ranchers. More than 92 million acres of land—an area the size of California—is privately developed, and much of it is tended by homeowners.

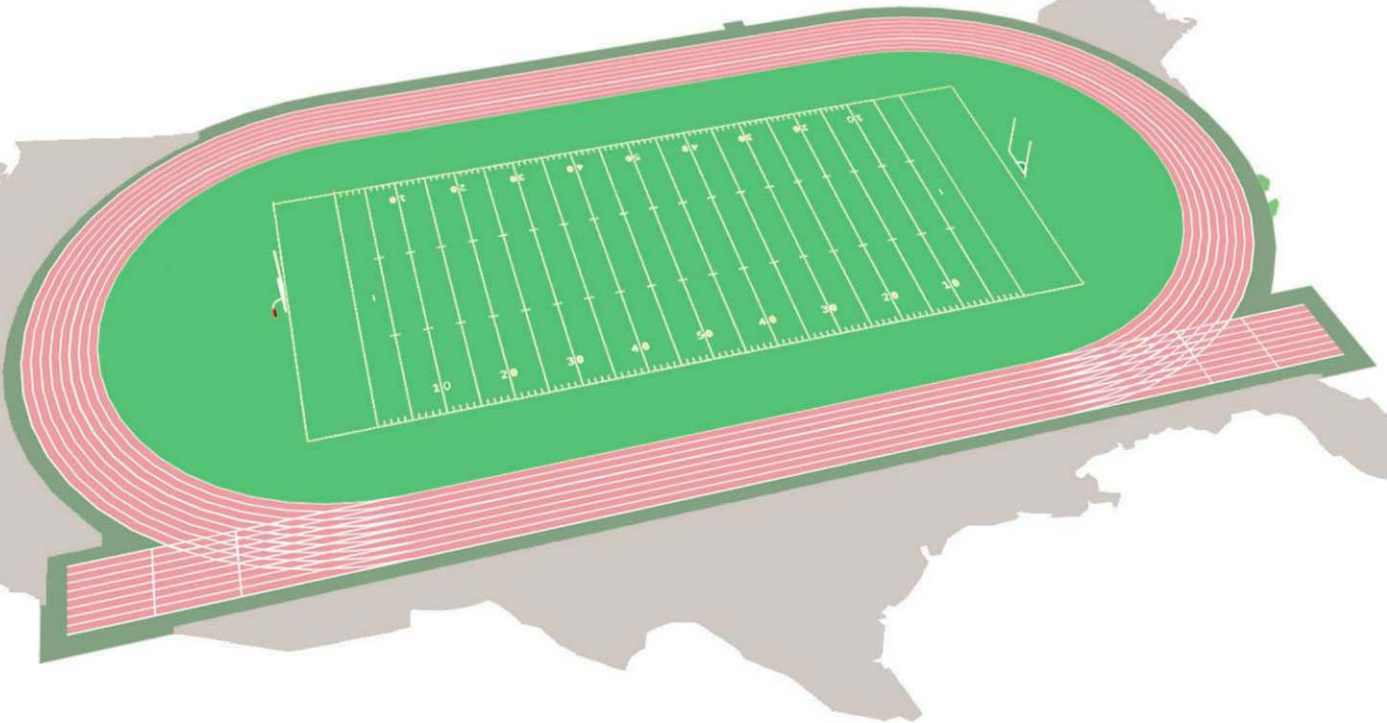



**E**veryone benefits when private landowners care for natural resources because it ensures that we will have cheap, plentiful food and clean water. So all people should help farmers and ranchers care for these resources. The Natural Resources Conservation Service has professionals who help farmers and ranchers develop plans to care for their land.

Thousands of other people volunteer their time. In 2006, more than 40,000 NRCS Earth Team volunteers donated nearly 1 million hours to the cause.

**YOU CAN HELP, TOO.**

TO FIND OUT HOW YOU CAN BECOME AN EARTH TEAM VOLUNTEER, CALL 1-888-LANDCARE (1-888-526-3227).

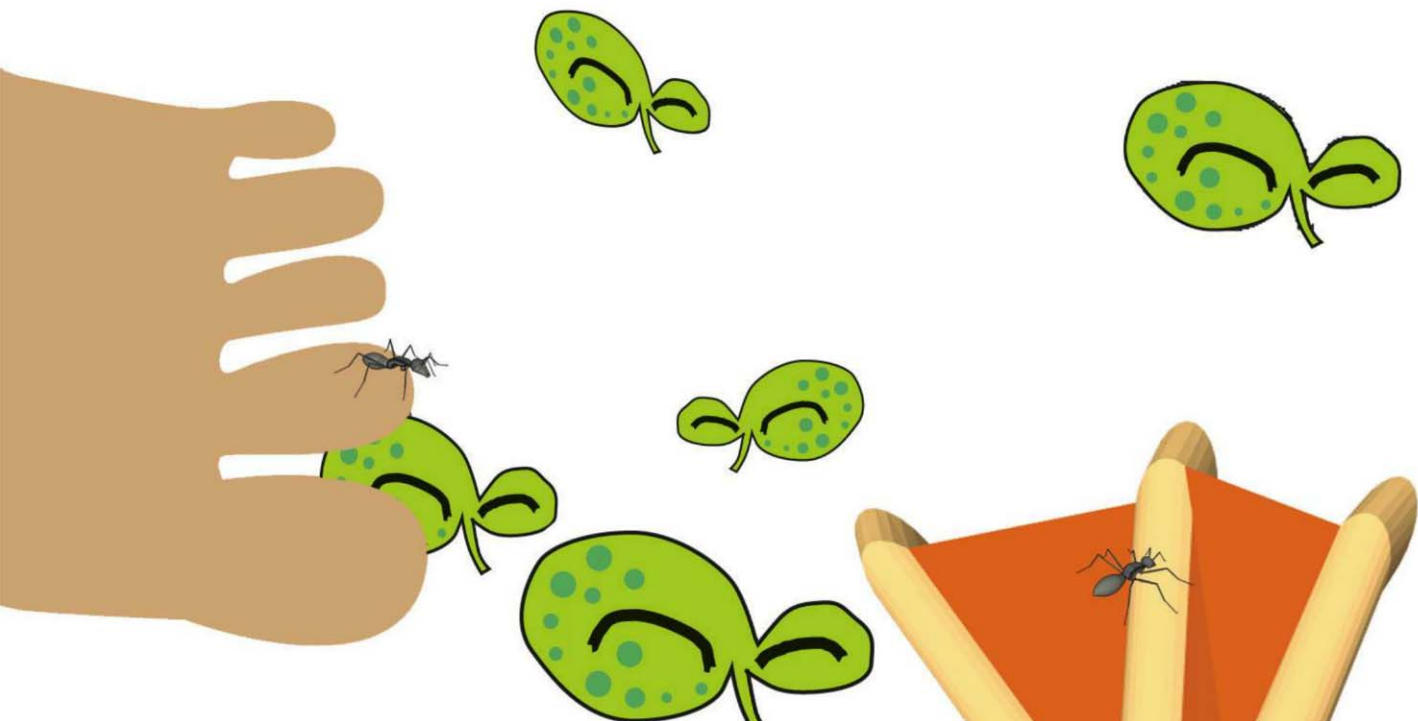



# FARMERS ARE STEWARDS OF THE LAND



To be a steward of the land means that you take responsible care of the land and do what is necessary to keep the Earth healthy and productive. The benefits of good land stewardship are cleaner water, improved wildlife habitat, and land protected from damages caused by wind and water erosion.

By 2006, farmers had voluntarily placed more than 34.9 million acres of their land in reserve to protect the environment and provide food and shelter for wildlife. These farmers do not plant crops or allow construction there. Instead, they have agreed to keep the land in a natural state that guards against soil erosion, protects water quality, and provides food and a safe environment for 75 percent of the wild animals in the United States.



A DAY IN THE LIFE  
OF A DAIRY COW

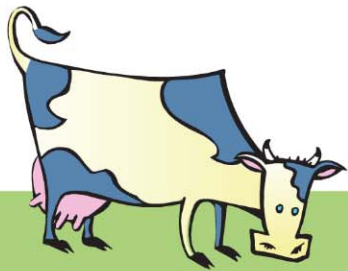

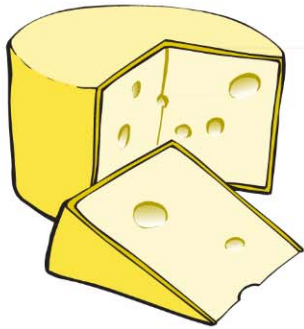

In 1 day, one cow produces 5.4 gallons of milk or 2.0 pounds of butter or **4.6 POUNDS OF CHEESE.**



A typical dairy cow weighs 1,400 pounds and produces more than **46 POUNDS OF MILK** per day.

A cow converts roughage like hay and grains not used by people into high energy foods.



In 1 day, one cow consumes 35 gallons of water, 20 pounds of grain, and **35 POUNDS OF HAY AND SILAGE.**



Just as importantly – as far as the environment is concerned – each dairy cow also produces 100 pounds of manure each day. Imagine how much manure a herd of a few hundred dairy cows produces!

**E**ach year, dairy, beef, pork, and poultry producers ask for and receive NRCS assistance to install animal waste management systems. These systems keep manure out of water supplies by storing it until farmers and ranchers can put it on fields to grow better grass or crops. When animal waste is properly managed, it helps farmers and ranchers grow more food, AND our water remains clean for drinking, fishing, and swimming.

THANK YOU, FARMERS AND RANCHERS!

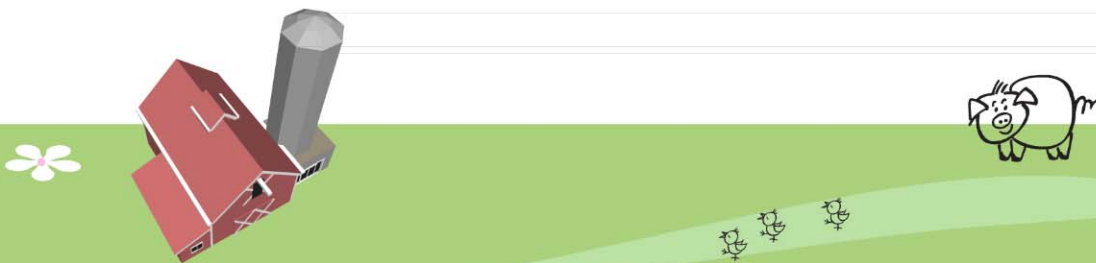



# FARMING IS STILL A FAMILY AFFAIR



Today, 99 percent of the farms in the United States are owned by individuals, family partnerships, or corporations with fewer than 10 stockholders. Only 1 percent of farms are owned by non-family corporations.

NON-FAMILY CORPORATIONS **1%**

FAMILY CORPORATIONS **3%**

FAMILY PARTNERSHIPS **6%**

INDIVIDUALS **90%**

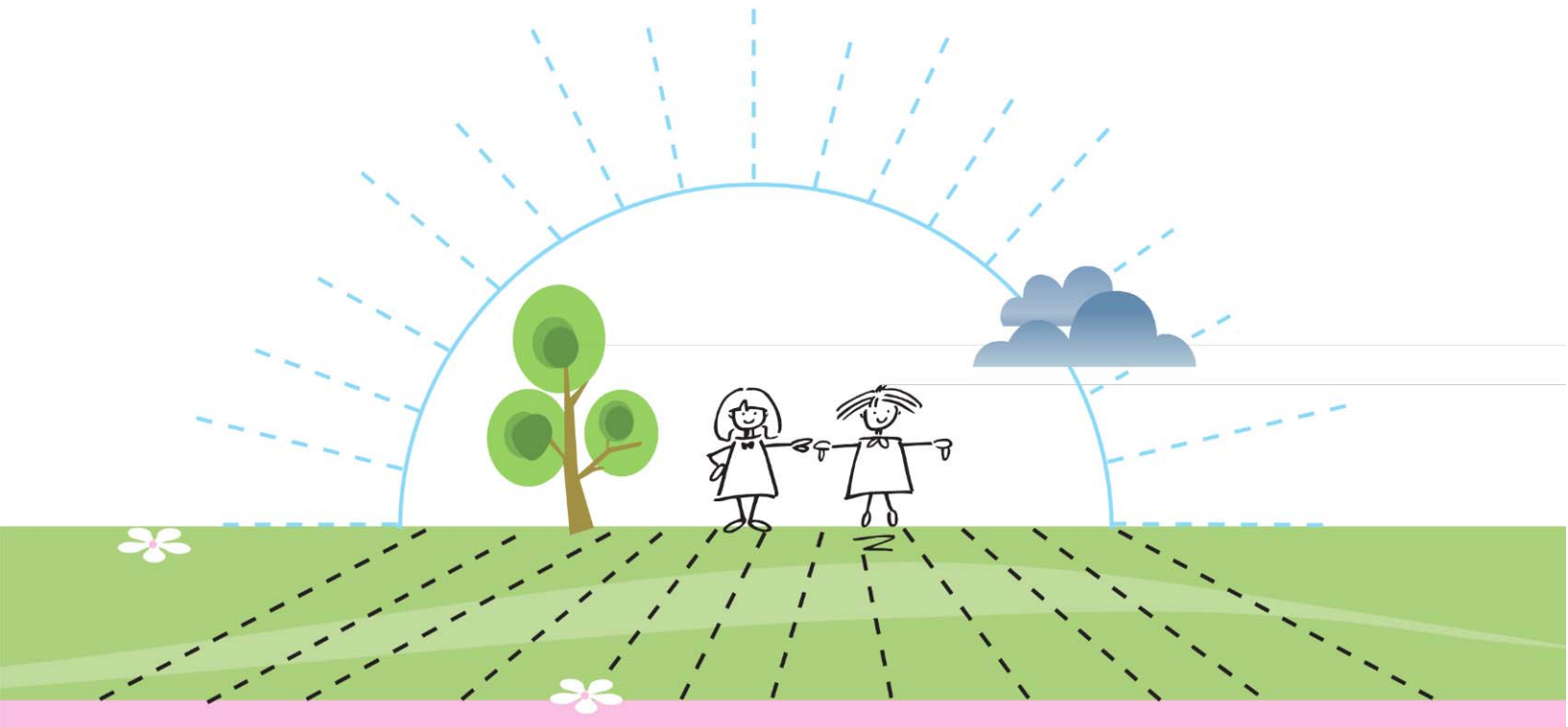

# FARMERS ARE WORKING TO MAKE A DIFFERENCE



In 1982, an average of **7.3 TONS** of topsoil washed or blew away from every acre of cultivated cropland in the United States. By 2003, the rate of soil erosion had dropped to **4.7 TONS** per acre.

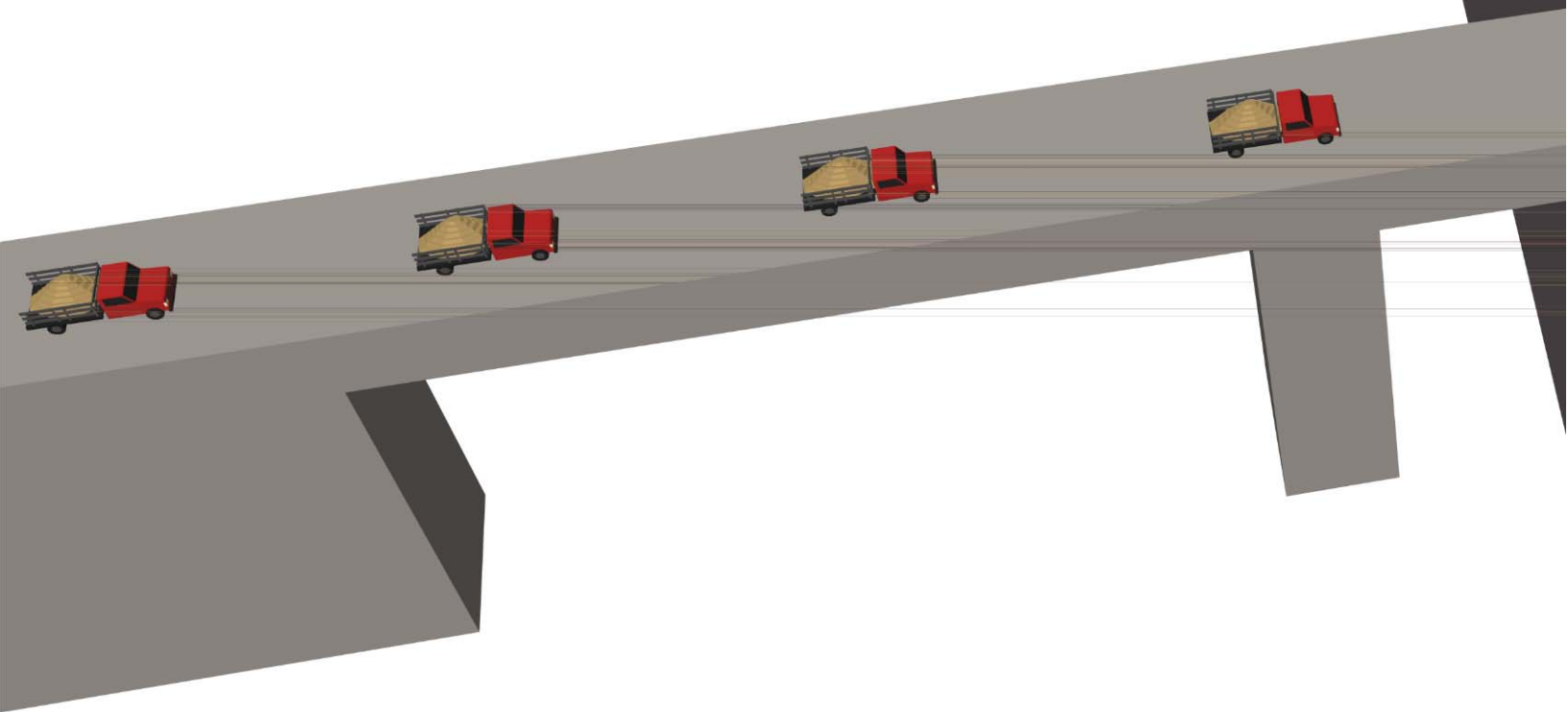

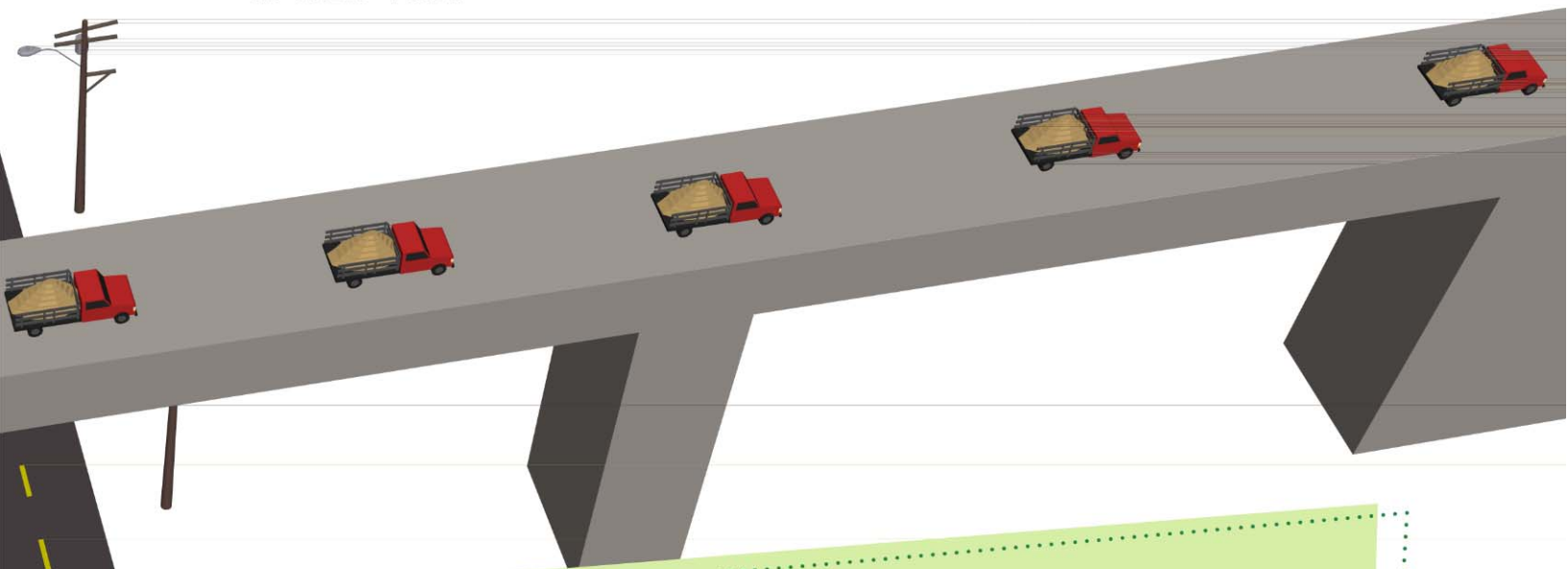
An illustration of a grey bridge with several red dump trucks carrying yellow soil. The bridge is supported by dark grey pillars. To the left, a road with yellow dashed lines has a white truck, a blue car, and a white van. A utility pole with a street light is also visible. The background is white with faint horizontal lines.

Farmers and ranchers, with assistance from NRCS and its conservation partners, reduced the Nation's annual soil loss from 3.1 billion tons in 1982 to 1.8 billion tons in 2001. That is enough topsoil saved in just 1 year to fill a convoy of dump trucks, 137 wide, stretching from Los Angeles to New York.

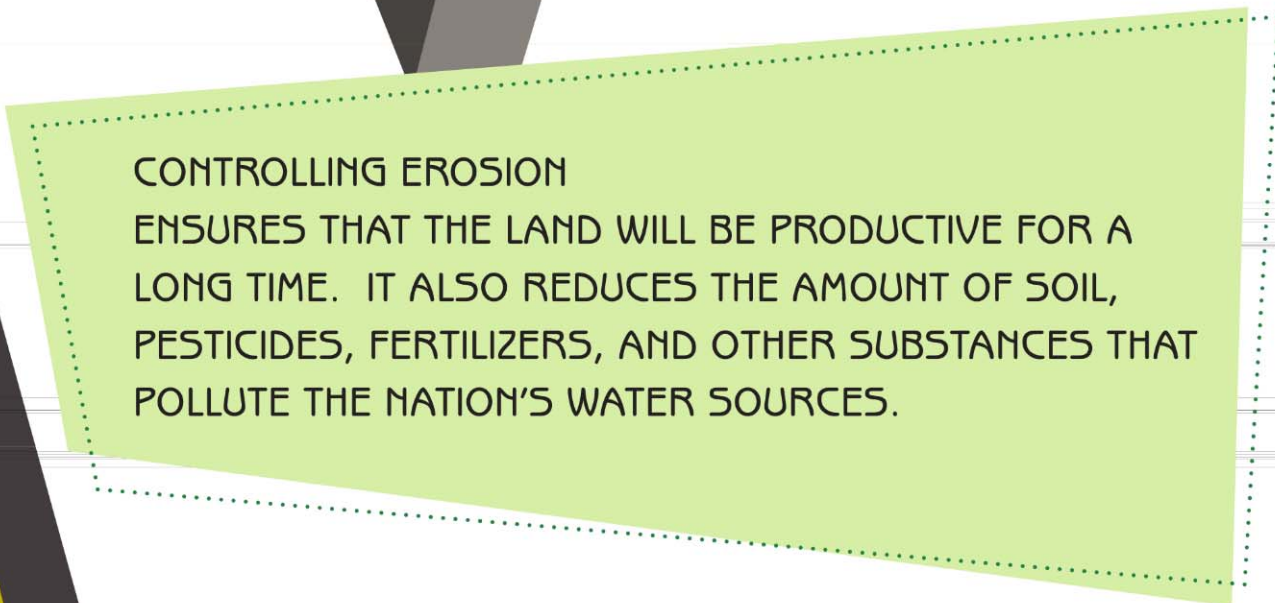
A light green callout box with a dotted border containing text about soil erosion control. The box is tilted slightly to the right.

**CONTROLLING EROSION**  
ENSURES THAT THE LAND WILL BE PRODUCTIVE FOR A LONG TIME. IT ALSO REDUCES THE AMOUNT OF SOIL, PESTICIDES, FERTILIZERS, AND OTHER SUBSTANCES THAT POLLUTE THE NATION'S WATER SOURCES.



# MORE AMAZING FACTS!

Agriculture is the **NATION'S LARGEST EMPLOYER**. More than 23.8 million people work in some phase of agriculture – from growing food and fiber to selling it at the supermarket.

## DID YOU KNOW...?

Did you know there are more than 2 million farms in the United States, including more than 189,000 operated by women?



Crops were harvested from MORE THAN **302 MILLION ACRES** in 2002, compared to 296 million acres in 1992. The remaining farmland was used for grazing, timber, and other agricultural uses.



U.S. consumers spent an average of **\$2,312 PER PERSON** for food in 2004, yet that was only 10 percent of total income, the lowest in the world!



The value of U.S. agricultural products sold in 2002 was **\$192 BILLION**, compared to \$162 billion in 1992.

The United States sold **\$70.9 billion** in agricultural products to other countries in 2006. The United States bought \$65.3 billion in farm products from other countries. That resulted in a trade surplus of \$5.6 billion in 2006. To have a “trade surplus” means the United States made more money than it spent on farm products.



# ALTERNATIVE ENERGY AND FARMERS AND RANCHERS

Farmers and ranchers are also playing a very active part in helping with the Nation's energy supply by producing and utilizing renewable resources. They have been using **wind and solar energy** for years. The United States used more than 140 billion gallons of gasoline and 60 billion gallons of diesel fuel in 2005. It is very important for us to find different fuel mixtures and resources. (For more information on energy, VISIT [WWW.USDA.GOV/ENERGY](http://WWW.USDA.GOV/ENERGY).) Some of the crops that farmers and ranchers grow, such as corn, wheat, soybeans, and sugarcane, as well as vegetable oil, fats, recycled grease, and other renewable products, are contributing to two types of biofuels -- **ethanol and biodiesel**. These are both fuel additives and alternatives that can be used instead of pure gasoline. Farmers are also experimenting with switchgrass and small poplar trees to see if they can be grown cheaply and abundantly for their use in ethanol. Imagine driving a car that runs on grass and trees!

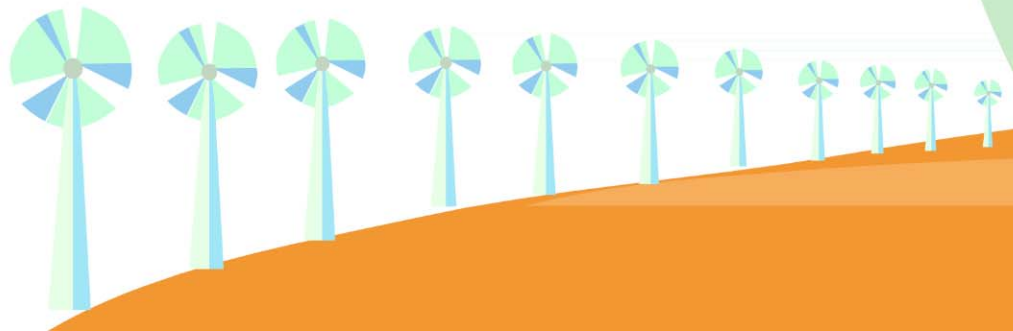

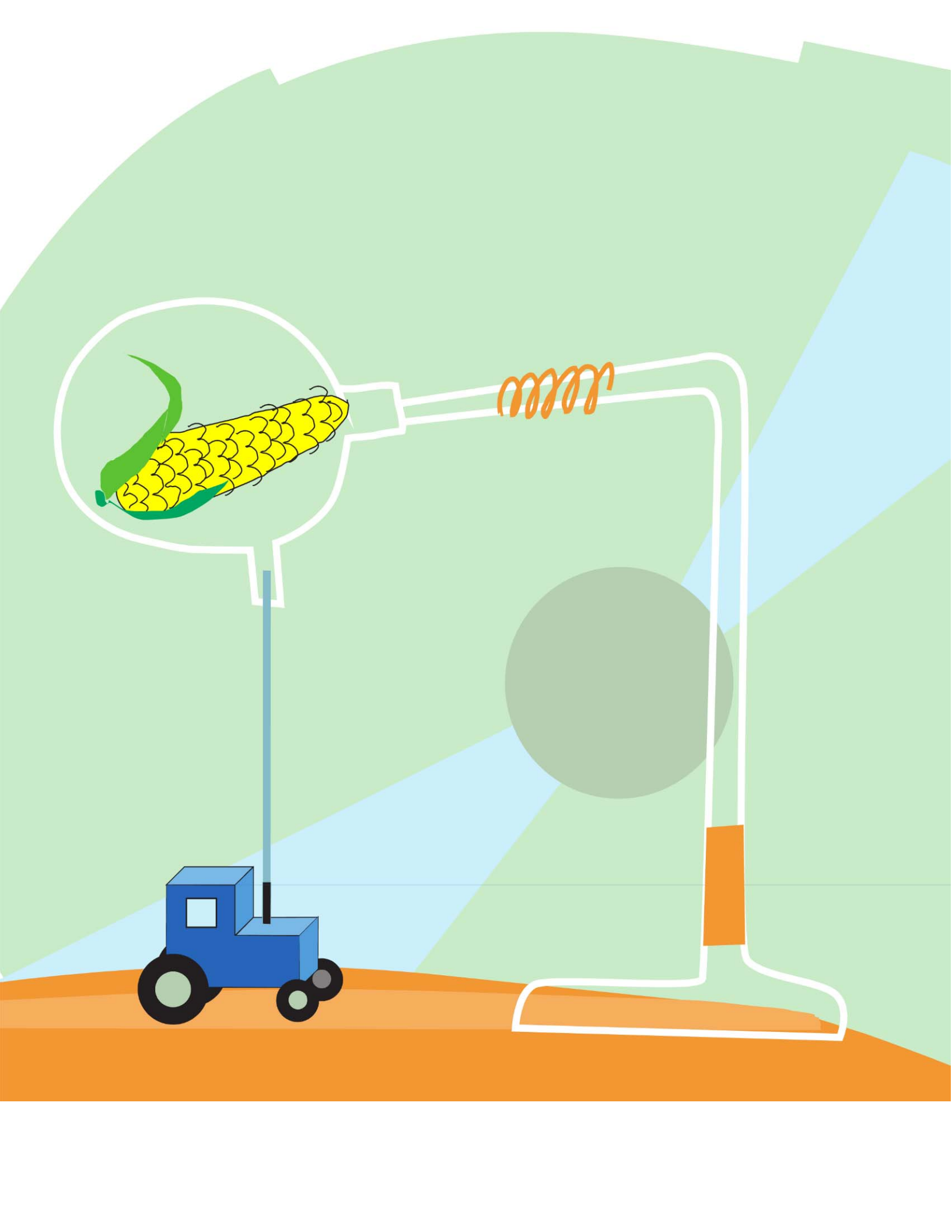

# IT'S IN THERE!

Here are just a few examples of things made with products provided by American farmers and ranchers:

## CORN:

- Food
- Plastic
- Cooking oil
- Cattle feed
- Diapers
- Sweetener
- De-icer
- Packing peanuts
- Ethanol
- Cleansing products

## SOYBEANS:

- Food
- Cooking oil
- Cattle feed
- Ink
- Paint stripper
- Crayons
- Lubricants
- Candles
- Engine oil
- Hand cleaner
- Nail polish remover
- Hair care products
- Adhesives
- Biodiesel fuel

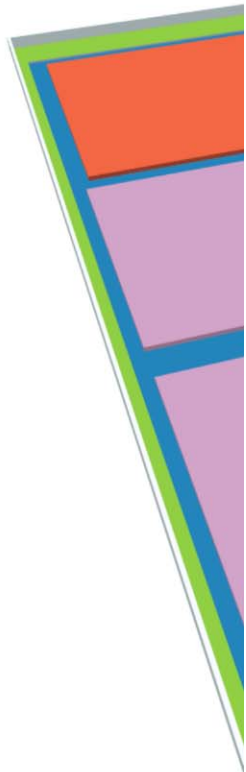



## RICE:

Food

Cattle feed

Dog food

Sake (Japanese wine)

## COTTON:

Bandages

Cooking oil

Paint

Paper

Clothing

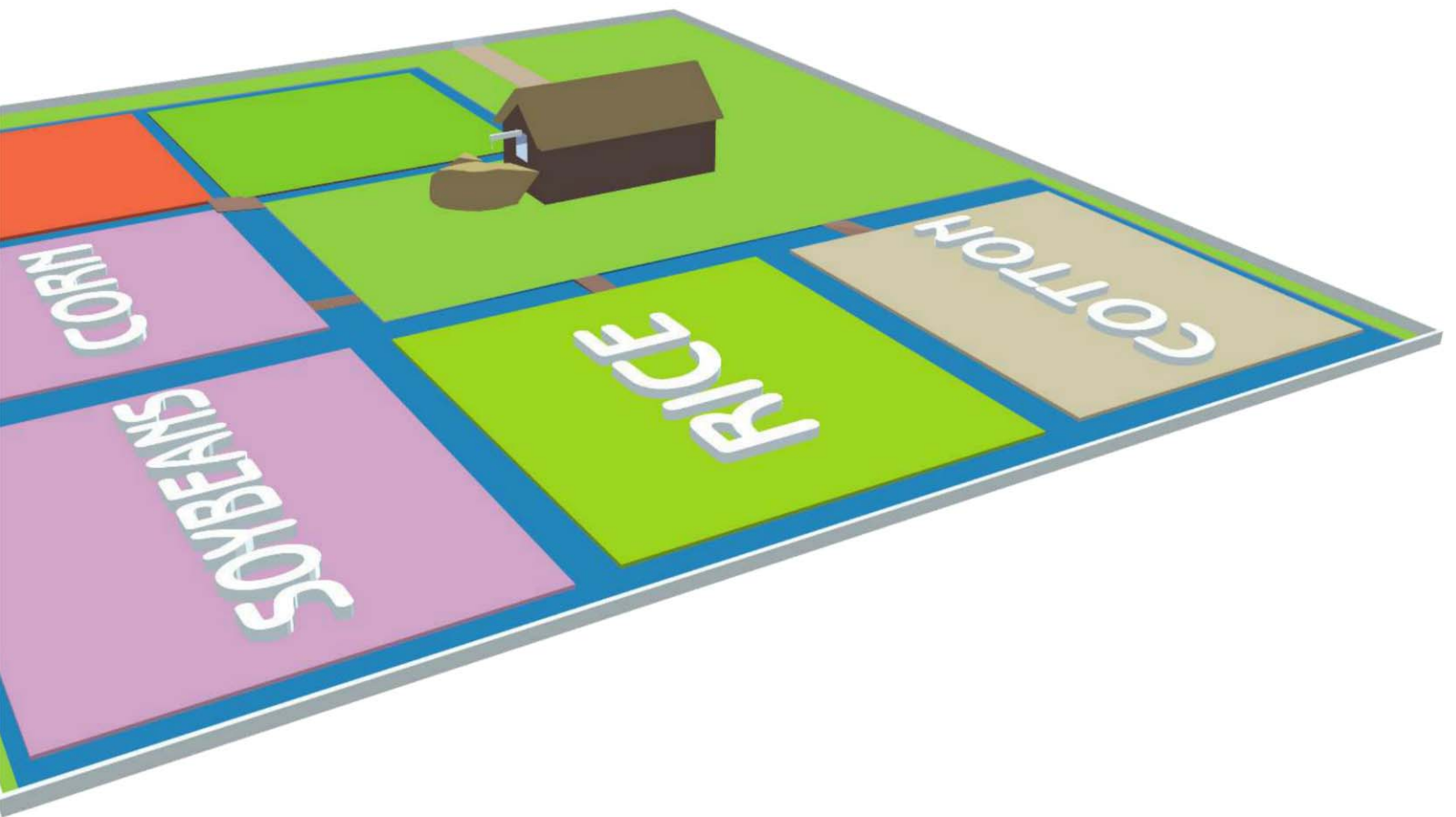

# There's More... IT'S IN THERE, TOO!

As you can see, American farmers and ranchers make many of the things you use, wear, and eat every day!

## PIGS:

Bacon  
Ham  
Sausage  
Pork chops  
Hot dogs  
Leather

## COWS:

Milk  
Cheese  
Butter  
Yogurt  
Ice cream  
Steaks  
Hamburgers  
Beef jerky  
Leather  
Film coatings  
Medicine  
Piano keys

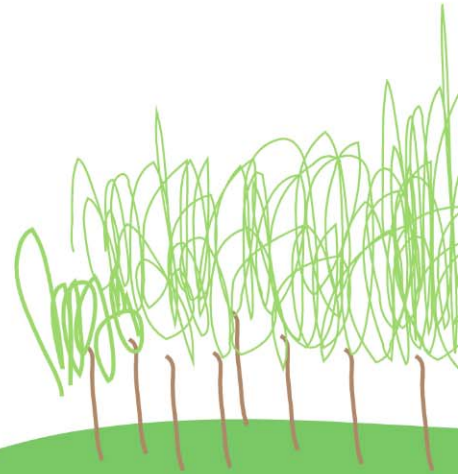

## TREES:

Lumber

Turpentine

Paper

Solvents

Oils

Medicine

Syrup

Nuts

Mulch

Film

Chewing gum

Nail polish

Rocket fuel

Make-up

Toothbrushes

Food additives

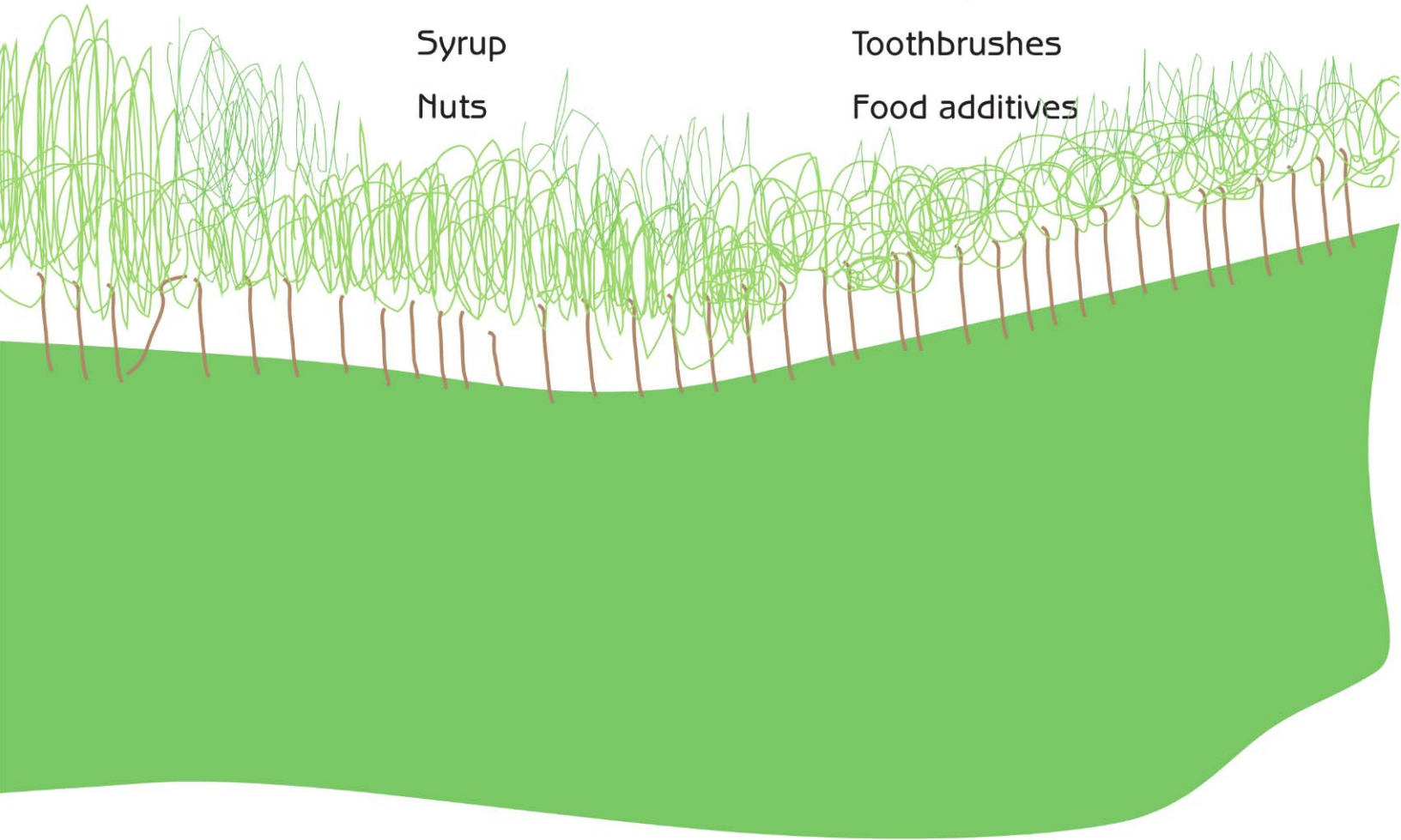

## ABOUT NRCS

With the mission of "Helping People Help the Land," the Natural Resources Conservation Service provides products and services that enable people to be good stewards of the Nation's soil, water, and related natural resources on non-Federal lands. With our help, people are better able to conserve, maintain, or improve their natural resources.

For more information about Federal conservation programs, contact your local USDA Service Center. You can find your local USDA Service Center's address and phone number in the phonebook under U.S. Government, on the U.S. Department of Agriculture's Web site at <http://offices.usda.gov>, or visit the NRCS Web site at: <http://www.nrcs.usda.gov>.



The U.S. Department of Agriculture (USDA) prohibits discrimination in all its programs and activities on the basis of race, color, national origin, age, disability, and where applicable, sex, marital status, familial status, parental status, religion, sexual orientation, genetic information, political beliefs, reprisal, or because all or a part of an individual's income is derived from any public assistance program. (Not all prohibited bases apply to all programs.) Persons with disabilities who require alternative means for communication of program information (Braille, large print, audiotape, etc.) should contact USDA's TARGET Center at (202) 720-2600 (voice and TDD). To file a complaint of discrimination, write to USDA, Director, Office of Civil Rights, 1400 Independence Avenue, S.W., Washington, D.C. 20250-9410 or call (800) 795-3272 (voice) or (202) 720-6382 (TDD).

USDA is an equal opportunity provider and employer.

July 2007



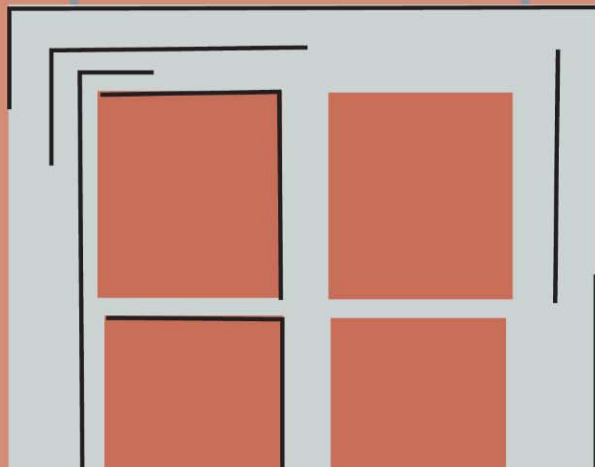
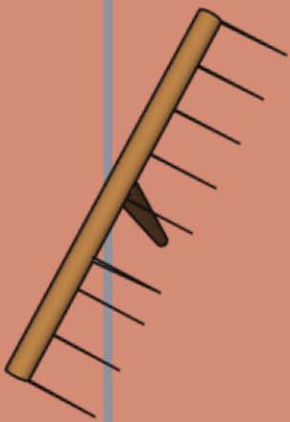
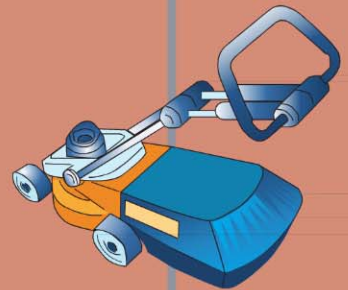
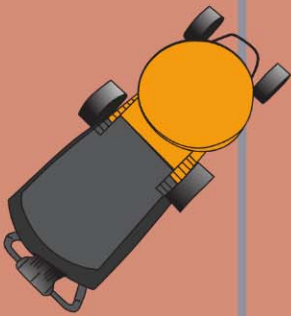
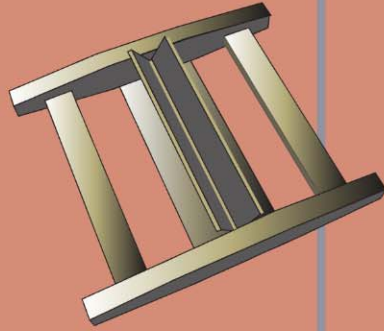

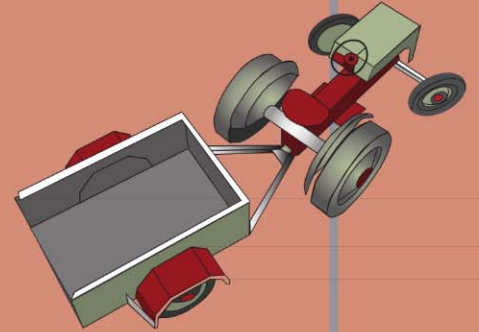
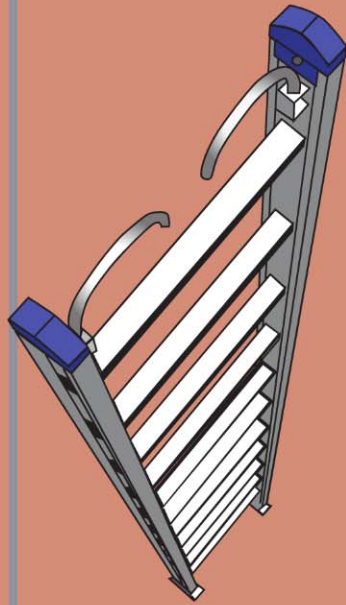

**THE END**

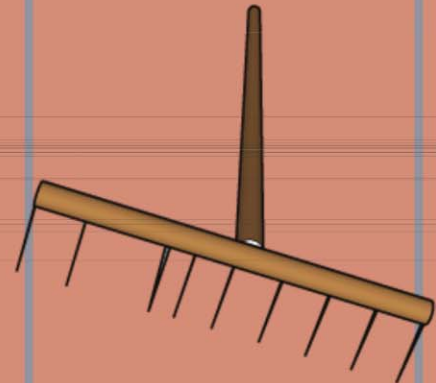
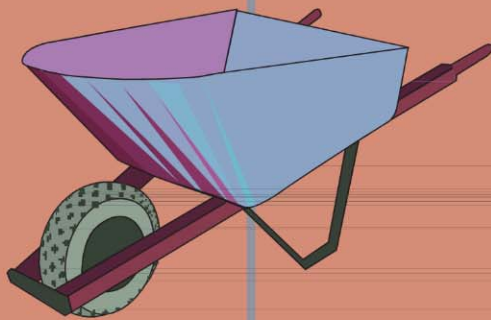



United States Department of Agriculture  
Natural Resources Conservation Service

*Helping People Help the Land*

 Printed on recycled paper

PA - 1936 July 2007