

TTVet M1M3 -100

Competitors/Compétiteurs

| # | Name/Nom | Grade | Club | 1 | 2 | 3 | W/G | Pts | Pos |
|---|-------------------------|-------|------------------|----|----|----|-----|-----|-----|
| 1 | BOURQUE Frédéric (0,00) | 1d | QC/Boucherville | XX | | | 0 | 0 | 3 |
| 2 | UZOKA Ugo (0,00) | 1d | ON/Ajax Budokan | 5 | XX | | 1 | 5 | 2 |
| 3 | JUTRAS David (0,00) | 1d | QC/Métropolitain | 10 | 10 | XX | 2 | 20 | 1 |

Matches/Matches

| Match | White/Blanc | | | Blue/Bleu | Res/Rés | Tim/Tmp | Code |
|-------|------------------|---|---|--------------|---------|---------|------|
| A-52A | BOURQUE Frédéric | 1 | 2 | UZOKA Ugo | 0 - 5 | 1:24 | WAZ |
| A-55A | BOURQUE Frédéric | 1 | 3 | JUTRAS David | 0 - 10 | 0:30 | GSI |
| A-61 | UZOKA Ugo | 2 | 3 | JUTRAS David | 0 - 10 | 0:33 | GSI |

Results/Résultats

| Pos | Name/Nom |
|-----|--------------------------------|
| 1 | JUTRAS David, QC/Métropolitain |
| 2 | UZOKA Ugo, ON/Ajax Budokan |
| | |

U14F -36

Competitors/Compétiteurs

| # | Name/Nom | Grade | Club | 1 | 2 | 3 | 4 | W/G | Pts | Pos |
|---|--------------------------|-------|--------------------|----|----|----|----|-----|-----|-----|
| 1 | PERRON Maika (0,00) | 3k | QC/Blainville | XX | | | 10 | 1 | 10 | 3 |
| 2 | CHARBONNEAU Malie (0,00) | 3k+ | QC/Haut-Richelieu | 10 | XX | | 10 | 2 | 20 | 2 |
| 3 | MINOGUE Mary (0,00) | 3k+ | USA/Cohen Brothers | 10 | 10 | XX | 10 | 3 | 30 | 1 |
| 4 | WARD Florence (0,00) | 2k | QC/Sept-Iles | | | | XX | 0 | 0 | 4 |

Matches/Matches

| Match | White/Blanc | | | Blue/Bleu | Res/Rés | Tim/Tmp | Code |
|-------|-------------------|---|---|-------------------|---------|---------|------|
| D-28 | PERRON Maika | 1 | 2 | CHARBONNEAU Malie | 0 - 10 | 0:18 | IPO |
| D-29 | MINOGUE Mary | 3 | 4 | WARD Florence | 10 - 0 | 0:16 | IPO |
| D-44 | PERRON Maika | 1 | 3 | MINOGUE Mary | 0 - 10 | 2:02 | IPO |
| D-45 | CHARBONNEAU Malie | 2 | 4 | WARD Florence | 10 - 0 | 1:42 | WIP |
| D-58 | PERRON Maika | 1 | 4 | WARD Florence | 10 - 0 | 1:01 | IPO |
| D-59 | CHARBONNEAU Malie | 2 | 3 | MINOGUE Mary | 0 - 10 | 0:11 | IPO |

Results/Résultats

| Pos | Name/Nom |
|-----|--------------------------------------|
| 1 | MINOGUE Mary, USA/Cohen Brothers |
| 2 | CHARBONNEAU Malie, QC/Haut-Richelieu |
| 3 | PERRON Maika, QC/Blainville |
| | |

U14F -40

Competitors/Compétiteurs

| # | Name/Nom | Grade | Club | 1 | 2 | 3 | 4 | 5 | W/G | Pts | Pos |
|---|--------------------------|-------|--------------|----|----|----|----|----|-----|-----|-----|
| 1 | BLOUIN Eleonore (0,00) | 3k | QC/CJVR | XX | | | 10 | | 1 | 10 | 4 |
| 2 | FLORES Alexandra (0,00) | 2k | ON/Tora | 10 | XX | 10 | 5 | | 3 | 25 | 2 |
| 3 | AU Leanna (0,00) | 3k | BC/Burnaby | 10 | | XX | 10 | | 2 | 20 | 3 |
| 4 | GARAND Noemie (0,00) | 3k | QC/Zenshin | | | | XX | | 0 | 0 | 5 |
| 5 | BEAUDIN Sara-Anne (0,00) | 2k | QC/Sept-Iles | 10 | 10 | 1 | 10 | XX | 4 | 31 | 1 |

Matches/Matches

| Match | White/Blanc | | | Blue/Bleu | Res/Rés | Tim/Tmp | Code |
|-------|-------------------------|---|---|-------------------|---------|---------|------|
| D-7 | GARAND Noemie | 4 | 5 | BEAUDIN Sara-Anne | 0 - 10 | 0:25 | WIP |
| D-8 | BLOUIN Eleonore | 1 | 2 | FLORES Alexandra | 0 - 10 | 0:00 | IPO |
| D-17 | AU Leanna | 3 | 4 | GARAND Noemie | 10 - 0 | 0:41 | IPO |
| D-18 | BLOUIN Eleonore | 1 | 5 | BEAUDIN Sara-Anne | 0 - 10 | 0:45 | WIP |
| D-23 | FLORES Alexandra | 2 | 3 | AU Leanna | 10 - 0 | 0:49 | WIP |
| D-24 | BLOUIN Eleonore | 1 | 4 | GARAND Noemie | 10 - 0 | 0:33 | WIP |
| D-37 | AU Leanna | 3 | 5 | BEAUDIN Sara-Anne | 0 - 1 | 3:00 | YUS |
| D-38 | FLORES Alexandra | 2 | 4 | GARAND Noemie | 5 - 0 | 3:00 | WAZ |
| D-53 | BLOUIN Eleonore | 1 | 3 | AU Leanna | 0 - 10 | 0:10 | IPO |
| D-54 | FLORES Alexandra | 2 | 5 | BEAUDIN Sara-Anne | 0 - 10 | 1:48 | HAN |

Results/Résultats

| Pos | Name/Nom |
|-----|---------------------------------|
| 1 | BEAUDIN Sara-Anne, QC/Sept-Iles |
| 2 | FLORES Alexandra, ON/Tora |
| 3 | AU Leanna, BC/Burnaby |
| 4 | BLOUIN Eleonore, QC/CJVR |
| | |

U14F -44

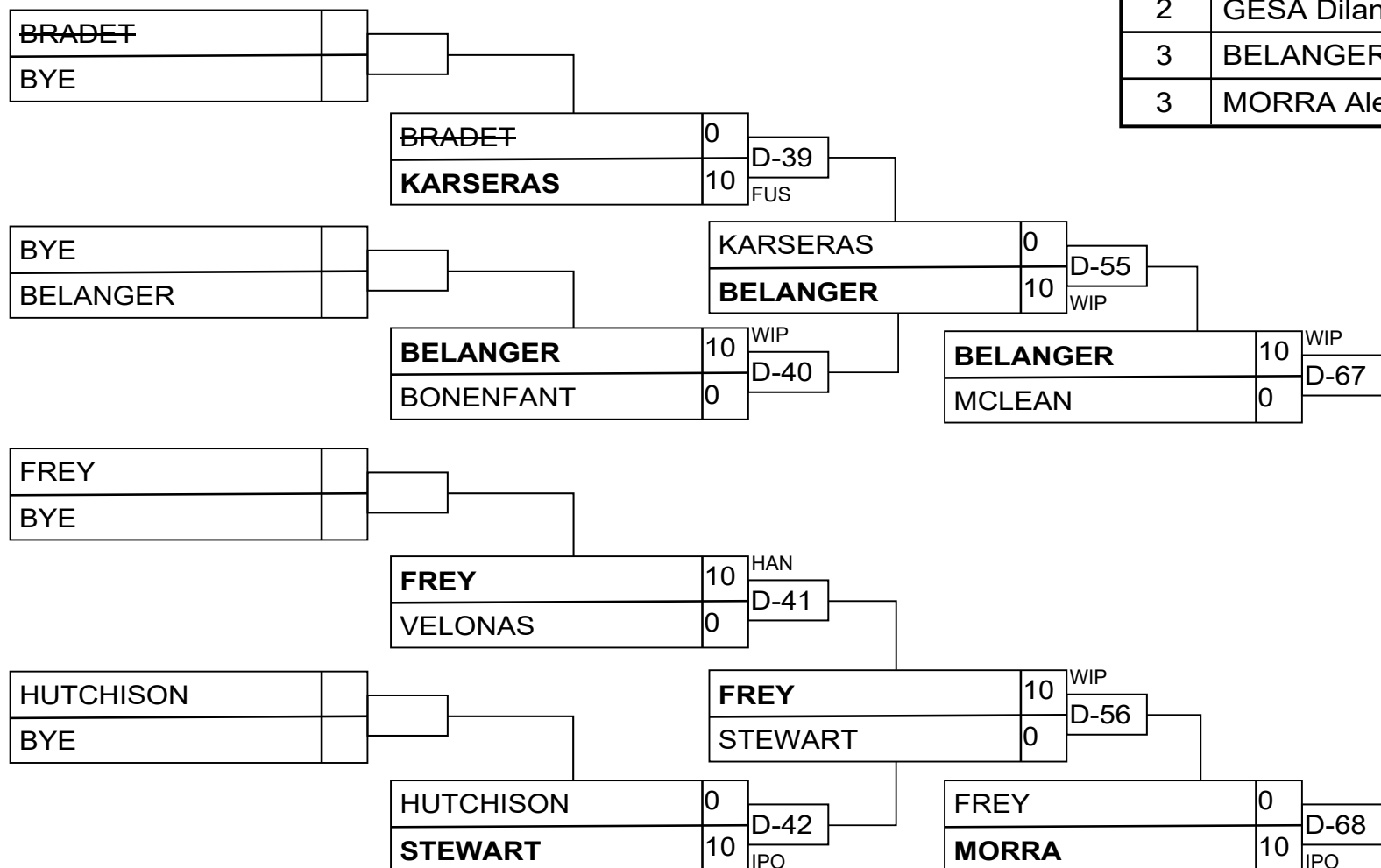
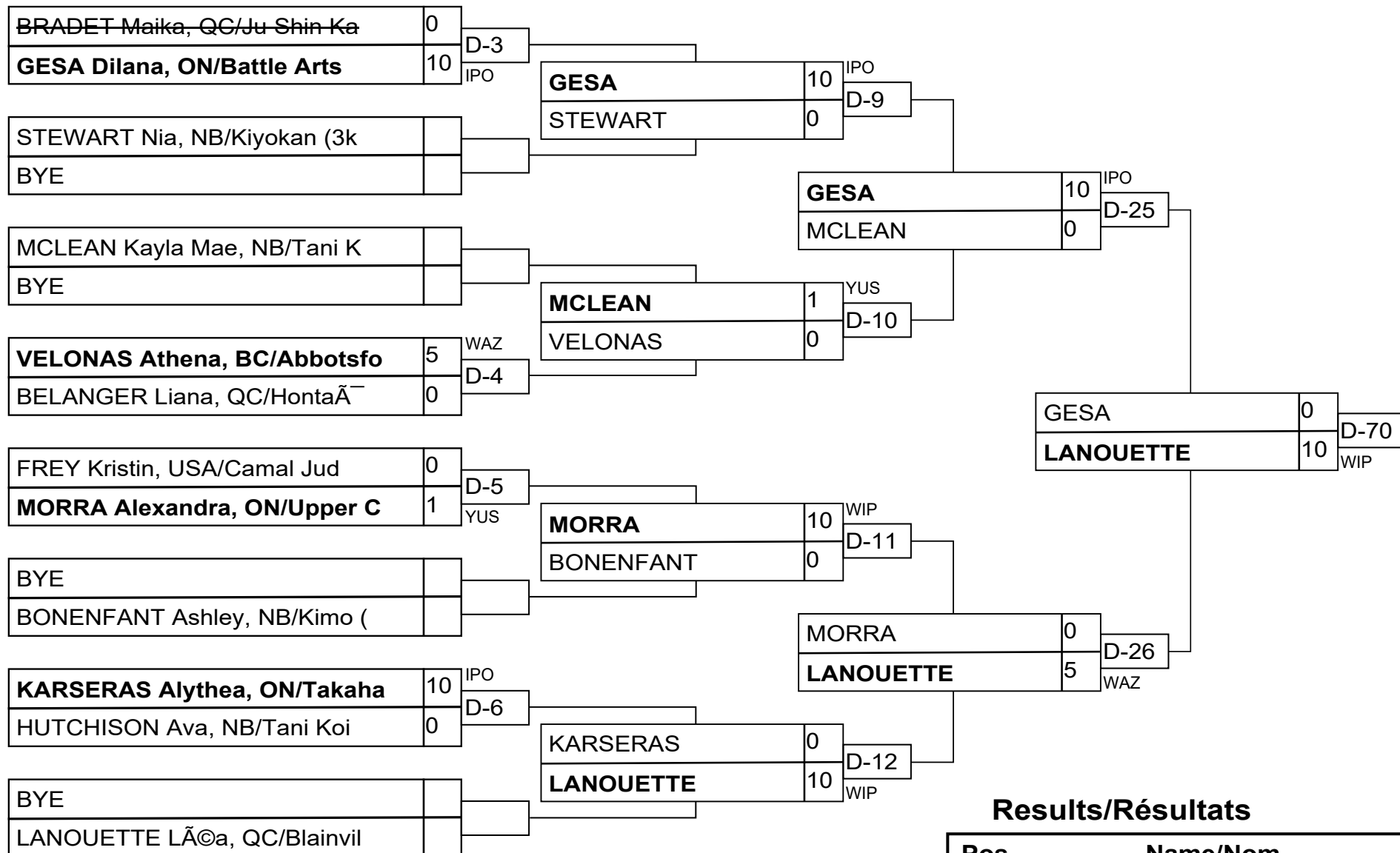

U14F -48

Competitors/Compétiteurs

| # | Name/Nom | Grade | Club | 1 | 2 | 3 | 4 | 5 | W/G | Pts | Pos |
|---|---------------------------|-------|---------------------|----|----|----|----|----|-----|-----|-----|
| 1 | MICHAUD Leah (0,00) | 3k | QC/Judo Beauce | XX | | | | 10 | 1 | 10 | 4 |
| 2 | THIBEAULT Hayden (0,00) | 2k | NB/Kiyokan | 10 | XX | | 10 | 10 | 3 | 30 | 2 |
| 3 | DE OLIVEIRA Helena (0,00) | 3k | Bresil/Maua | 10 | 10 | XX | 10 | 10 | 4 | 40 | 1 |
| 4 | LEWIS Kaylee (0,00) | 3k | QC/Perrot Shima | 10 | | | XX | 10 | 2 | 20 | 3 |
| 5 | THIBAUT Charlie (0,00) | 3k | QC/Señ kidokan (QC) | | | | | XX | 0 | 0 | 5 |

Matches/Matches

| Match | White/Blanc | | | Blue/Bleu | Res/Rés | Tim/Tmp | Code |
|-------|--------------------|---|---|--------------------|---------|---------|------|
| D-13 | LEWIS Kaylee | 4 | 5 | THIBAUT Charlie | 10 - 0 | 0:44 | IPO |
| D-14 | MICHAUD Leah | 1 | 2 | THIBEAULT Hayden | 0 - 10 | 0:30 | IPO |
| D-19 | DE OLIVEIRA Helena | 3 | 4 | LEWIS Kaylee | 10 - 0 | 1:35 | WIP |
| D-20 | MICHAUD Leah | 1 | 5 | THIBAUT Charlie | 10 - 0 | 1:43 | WIP |
| D-30 | THIBEAULT Hayden | 2 | 3 | DE OLIVEIRA Helena | 0 - 10 | 0:56 | WIP |
| D-31 | MICHAUD Leah | 1 | 4 | LEWIS Kaylee | 0 - 10 | 2:19 | IPO |
| D-46 | DE OLIVEIRA Helena | 3 | 5 | THIBAUT Charlie | 10 - 0 | 0:42 | IPO |
| D-47 | THIBEAULT Hayden | 2 | 4 | LEWIS Kaylee | 10 - 0 | 0:37 | IPO |
| D-60 | MICHAUD Leah | 1 | 3 | DE OLIVEIRA Helena | 0 - 10 | 1:02 | IPO |
| D-61 | THIBEAULT Hayden | 2 | 5 | THIBAUT Charlie | 10 - 0 | 0:05 | IPO |

Results/Résultats

| Pos | Name/Nom |
|-----|---------------------------------|
| 1 | DE OLIVEIRA Helena, Bresil/Maua |
| 2 | THIBEAULT Hayden, NB/Kiyokan |
| 3 | LEWIS Kaylee, QC/Perrot Shima |
| 4 | MICHAUD Leah, QC/Judo Beauce |
| | |

U14F -52

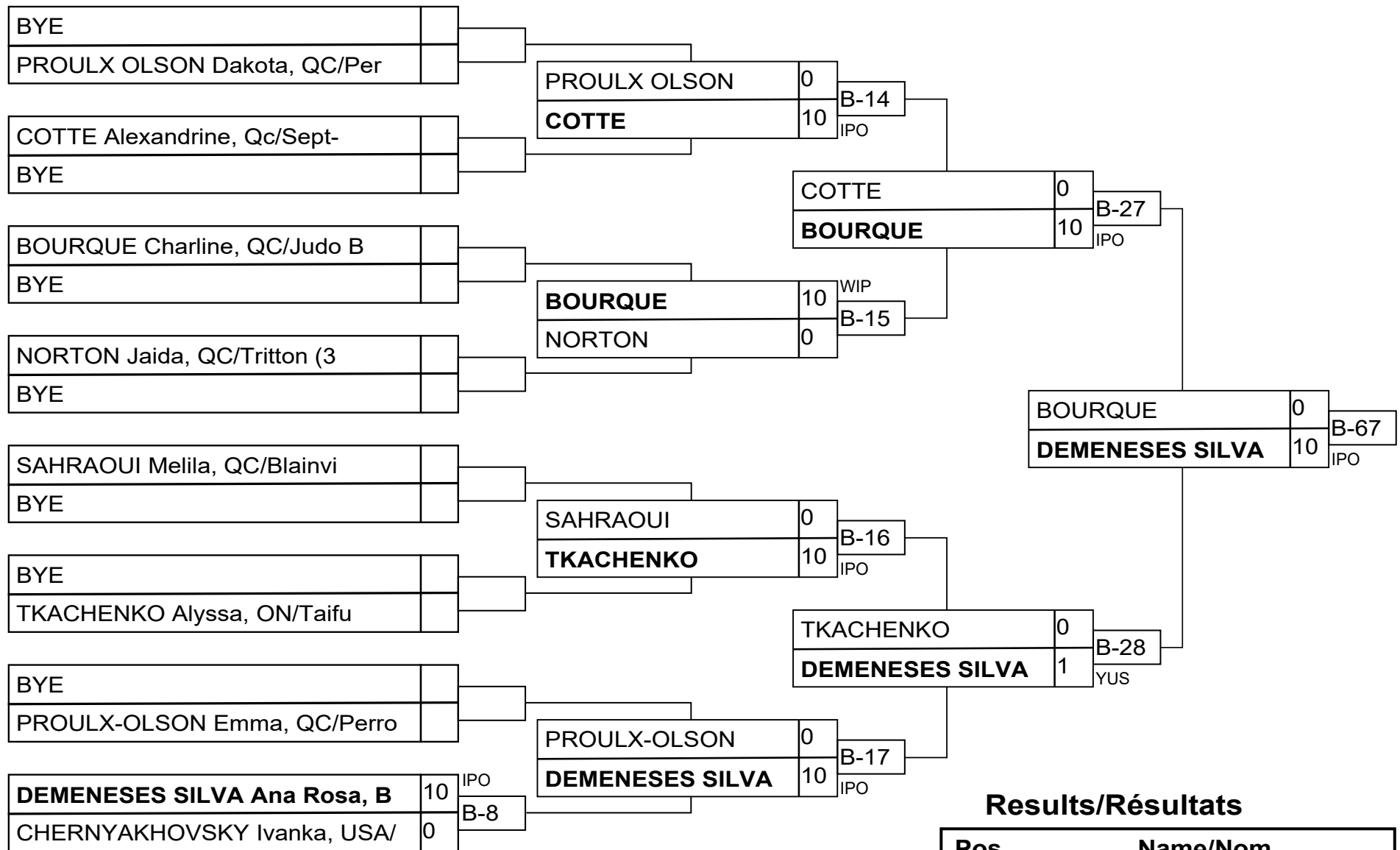

Results/Résultats

| Pos | Name/Nom |
|-----|--------------------------|
| 1 | DEMESESES SILVA Ana Rosa |
| 2 | BOURQUE Charline, QC/Jud |
| 3 | PROULX-OLSON Emma, QC/Pe |
| 3 | TKACHENKO Alyssa, ON/Tai |

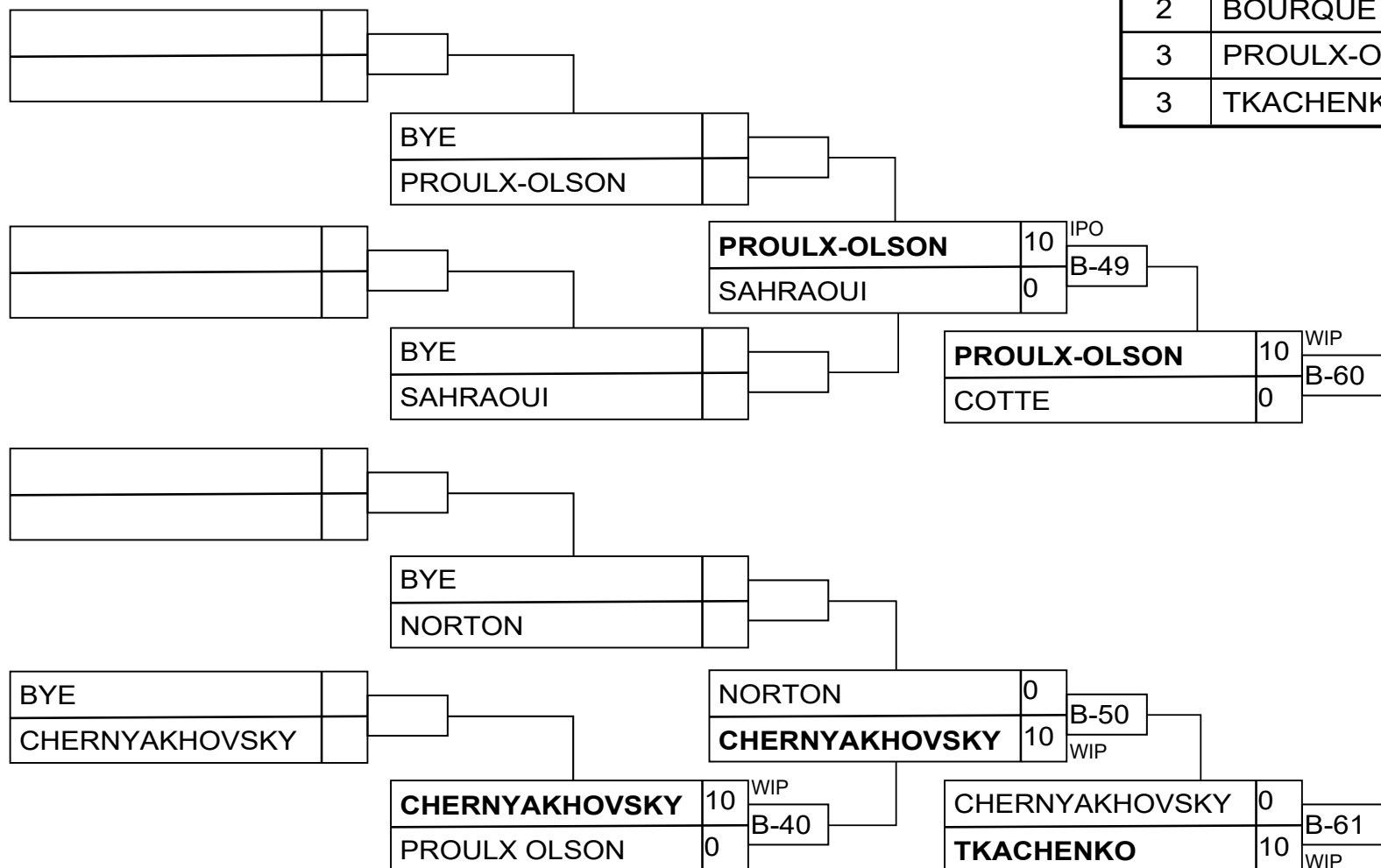

U14F -57

Competitors/Compétiteurs

| # | Name/Nom | Grade | Club | 1 | 2 | 3 | W/G | Pts | Pos |
|---|----------------------|-------|-------------------|----|----|----|-----|-----|-----|
| 1 | BRADAI Loubna (0,00) | 3k | QC/MÃ©tropolitain | XX | 10 | 10 | 2 | 20 | 1 |
| 2 | DEMERS Maude (0,00) | 1k | QC/Torakai | | XX | 10 | 1 | 10 | 2 |
| 3 | RABIA Nisrine (0,00) | 3k | QC/Torii | | | XX | 0 | 0 | 3 |

Matches/Matches

| Match | White/Blanc | | | Blue/Bleu | Res/Rés | Tim/Tmp | Code |
|-------|---------------|---|---|---------------|---------|---------|------|
| D-27 | BRADAI Loubna | 1 | 2 | DEMERS Maude | 10 - 0 | 0:07 | IPO |
| D-43 | BRADAI Loubna | 1 | 3 | RABIA Nisrine | 10 - 0 | 0:53 | WIP |
| D-57 | DEMERS Maude | 2 | 3 | RABIA Nisrine | 10 - 0 | 2:02 | IPO |

Results/Résultats

| Pos | Name/Nom |
|-----|----------------------------------|
| 1 | BRADAI Loubna, QC/MÃ©tropolitain |
| 2 | DEMERS Maude, QC/Torakai |
| | |

U14F -63

Competitors/Compétiteurs

| # | Name/Nom | Grade | Club | 1 | 2 | 3 | W/G | Pts | Pos |
|---|----------------------------|-------|-------------------|----|----|----|-----|-----|-----|
| 1 | FOWLER Naomi (0,00) | 3k | NB/Tani Koi | XX | | | 0 | 0 | 3 |
| 2 | DORVAL-MBELE Missy Jen (0, | 3k | QC/MÃ©tropolitain | 5 | XX | | 1 | 5 | 2 |
| 3 | DE ANDRADE Isabella (0,00) | 3k | Bresil/Maua | 10 | 10 | XX | 2 | 20 | 1 |

Matches/Matches

| Match | White/Blanc | | | Blue/Bleu | Res/Rés | Tim/Tmp | Code |
|-------|------------------------|---|---|------------------------|---------|---------|------|
| B-33 | FOWLER Naomi | 1 | 2 | DORVAL-MBELE Missy Jen | 0 - 5 | 2:55 | HAN |
| B-44 | FOWLER Naomi | 1 | 3 | DE ANDRADE Isabella | 0 - 10 | 0:07 | IPO |
| B-55 | DORVAL-MBELE Missy Jen | 2 | 3 | DE ANDRADE Isabella | 0 - 10 | 1:49 | IPO |

Results/Résultats

| Pos | Name/Nom |
|-----|---|
| 1 | DE ANDRADE Isabella, Bresil/Maua |
| 2 | DORVAL-MBELE Missy Jen, QC/MÃ©tropolitain |
| | |

U14M -31

Competitors/Compétiteurs A

| # | Name/Nom | Grade | Club | 1 | 2 | 3 | W/G | Pts | Pos |
|---|---------------------------|-------|----------------|----|----|----|-----|-----|-----|
| 1 | MAHEUX William (0,00) | 3k+ | QC/Judo Beauce | XX | | | 0 | 0 | 3 |
| 2 | L'ESPÉRANCE Samuel (0,00) | 3k+ | QC/Judo Beauce | 10 | XX | | 1 | 10 | 2 |
| 3 | GRACHTCHOUK Ivan (0,00) | 3k | ON/Challenge | 10 | 10 | XX | 2 | 20 | 1 |

Matches/Matches A

| Match | White/Blanc | Blue/Bleu | Res/Rés | Tim/Tmp | Code |
|-------|---------------------------|--------------------|---------|---------|------|
| B-34 | MAHEUX William 1 2 | L'ESPÉRANCE Samuel | 0 - 10 | 0:59 | IPO |
| B-45 | MAHEUX William 1 3 | GRACHTCHOUK Ivan | 0 - 10 | 0:18 | IPO |
| B-56 | L'ESPÉRANCE Samuel 2 3 | GRACHTCHOUK Ivan | 0 - 10 | 1:04 | WIP |

Competitors/Compétiteurs B

| # | Name/Nom | Grade | Club | 4 | 5 | 6 | W/G | Pts | Pos |
|---|-------------------------|-------|-----------------|----|----|----|-----|-----|-----|
| 4 | ROITMAN Arel (0,00) | 3k | ON/Taifu | XX | 10 | 10 | 2 | 20 | 1 |
| 5 | LAPOINTE Tristan (0,00) | 3k+ | QC/Boucherville | | XX | 10 | 1 | 10 | 2 |
| 6 | VACHON Alex (0,00) | 3k | QC/Judo Beauce | | | XX | 0 | 0 | 3 |

Matches/Matches B

| Match | White/Blanc | Blue/Bleu | Res/Rés | Tim/Tmp | Code |
|-------|-------------------------|------------------|---------|---------|------|
| B-35 | ROITMAN Arel 4 5 | LAPOINTE Tristan | 10 - 0 | 3:00 | IPO |
| B-46 | ROITMAN Arel 4 6 | VACHON Alex | 10 - 0 | 2:08 | WIP |
| B-57 | LAPOINTE Tristan 5 6 | VACHON Alex | 10 - 0 | 0:37 | WIP |

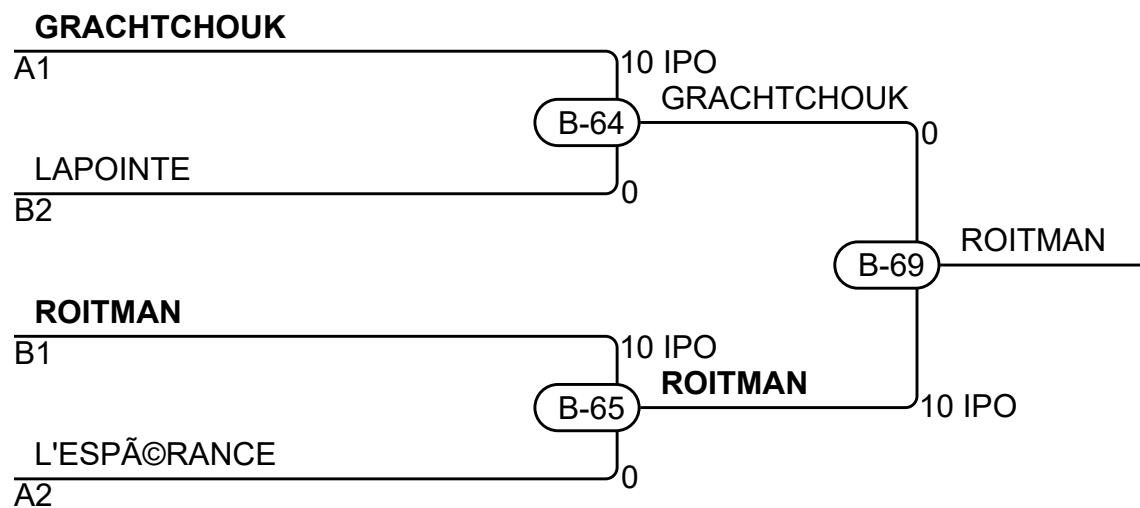

Results/Résultats

| Pos | Name/Nom |
|-----|------------------------------------|
| 1 | ROITMAN Arel, ON/Taifu |
| 2 | GRACHTCHOUK Ivan, ON/Challenge |
| 3 | LAPOINTE Tristan, QC/Boucherville |
| 3 | L'ESPÉRANCE Samuel, QC/Judo Beauce |

U14M -34

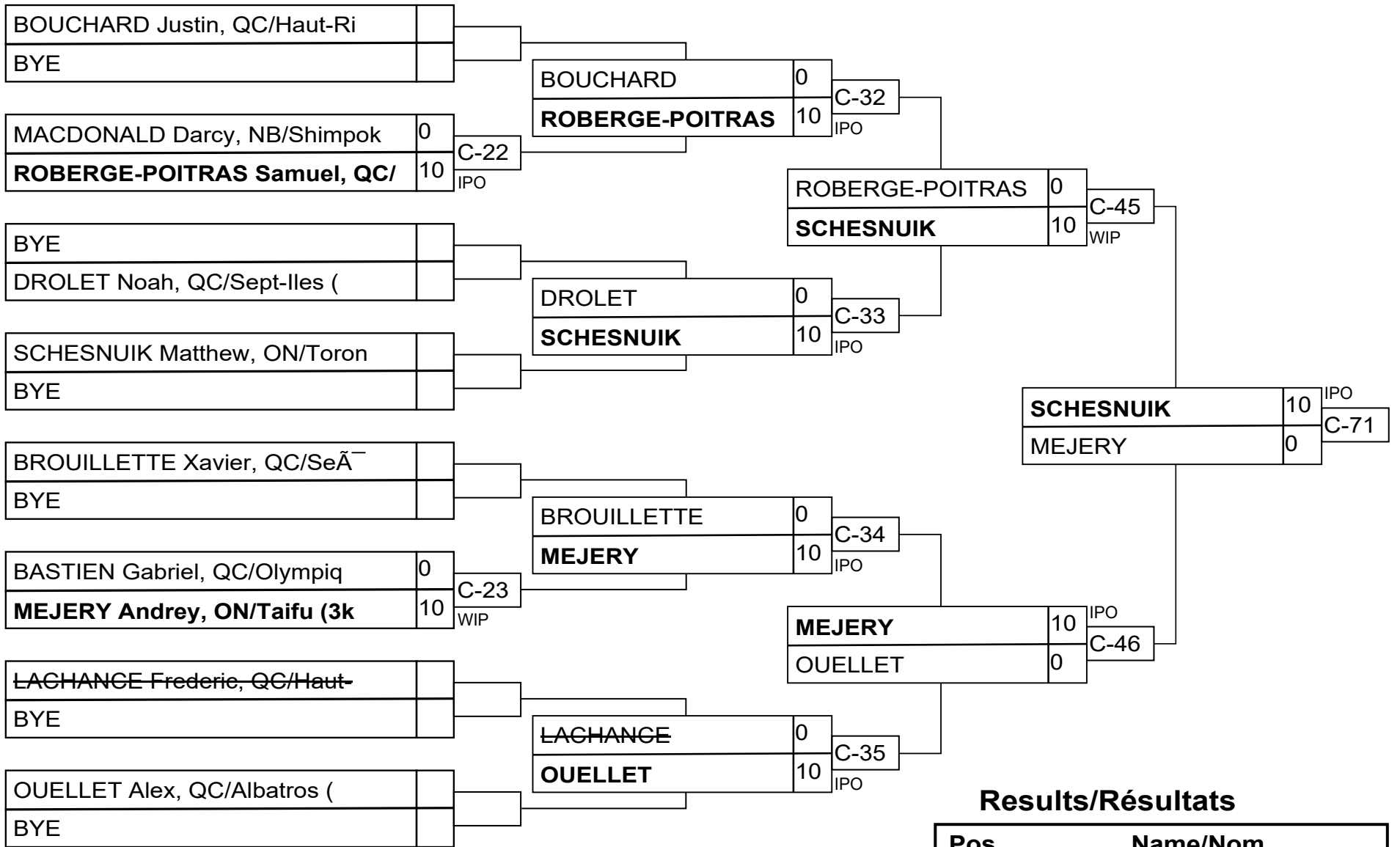

Results/Résultats

| Pos | Name/Nom |
|-----|---------------------------|
| 1 | SCHECHNUIK Matthew, ON/To |
| 2 | MEJERY Andrey, ON/Taifu |
| 3 | BROUILLETTE Xavier, QC/S |
| 3 | DROLET Noah, QC/Sept-Ile |

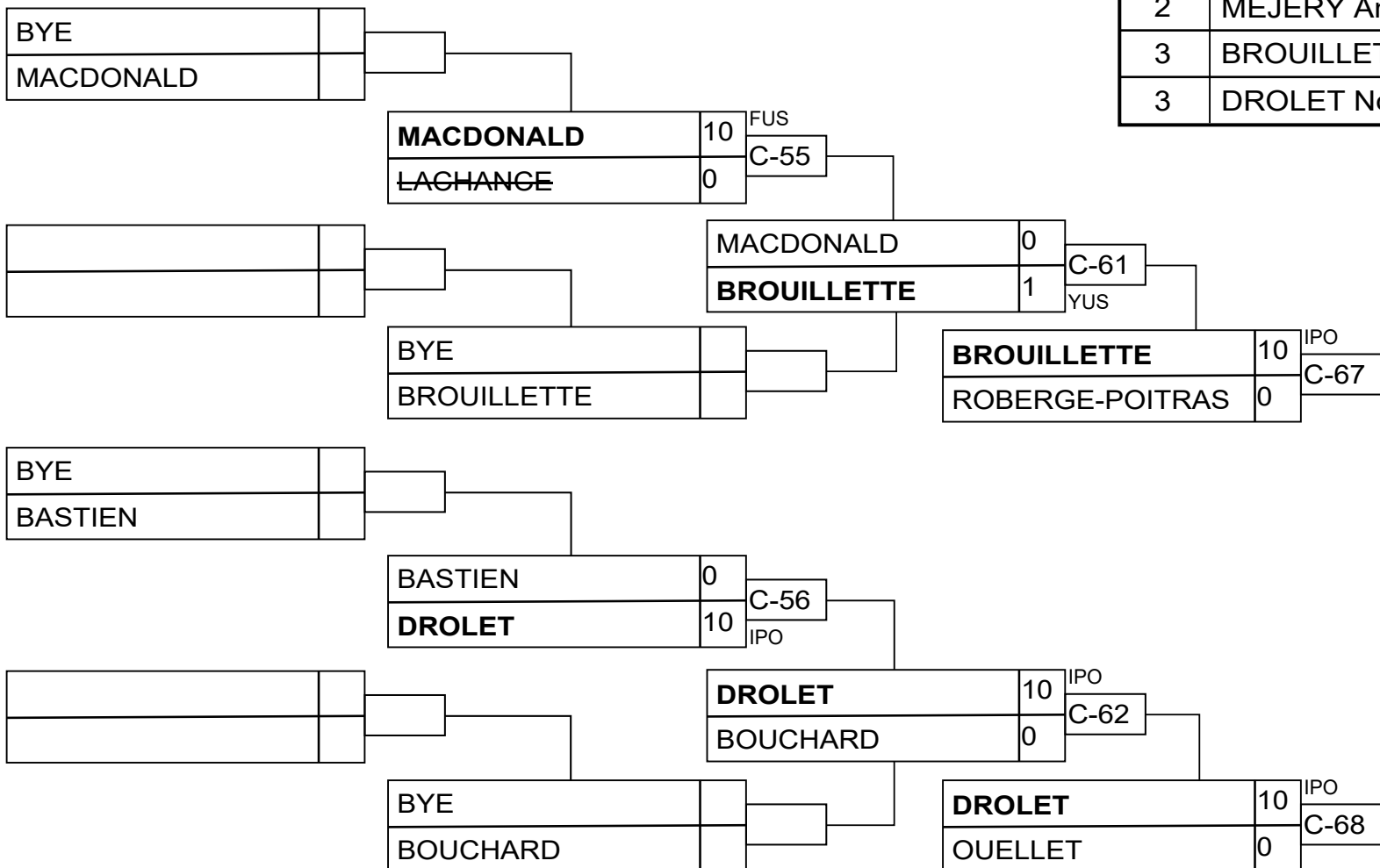

U14M -38

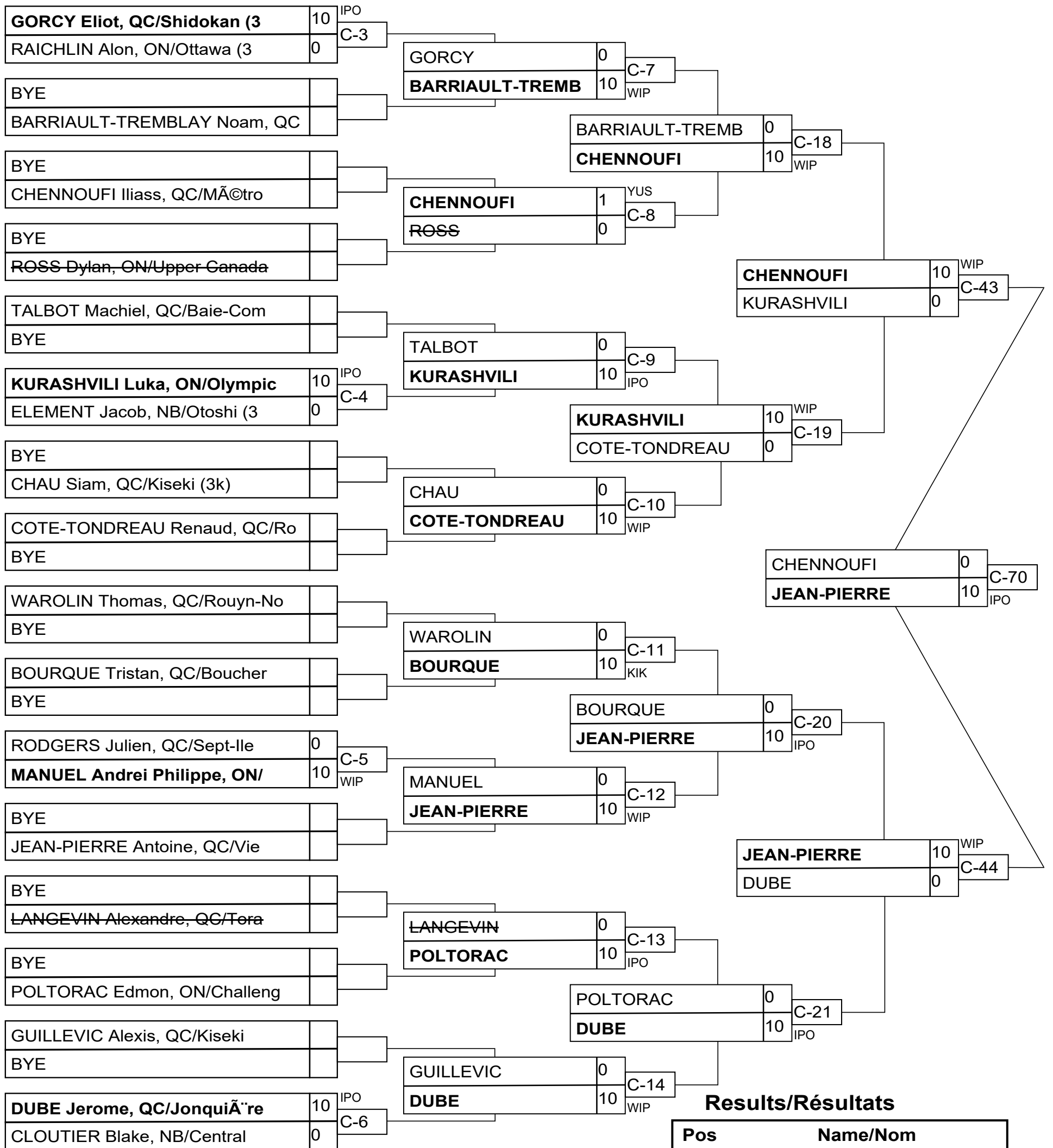

Results/Résultats

| Pos | Name/Nom |
|-----|--------------------------|
| 1 | JEAN-PIERRE Antoine, QC/ |
| 2 | CHENNOUFI Iliass, QC/MÃ© |
| 3 | POLTORAC Edmon, ON/Chall |
| 3 | DUBE Jerome, QC/JonquiÃ¨ |

U14M -38

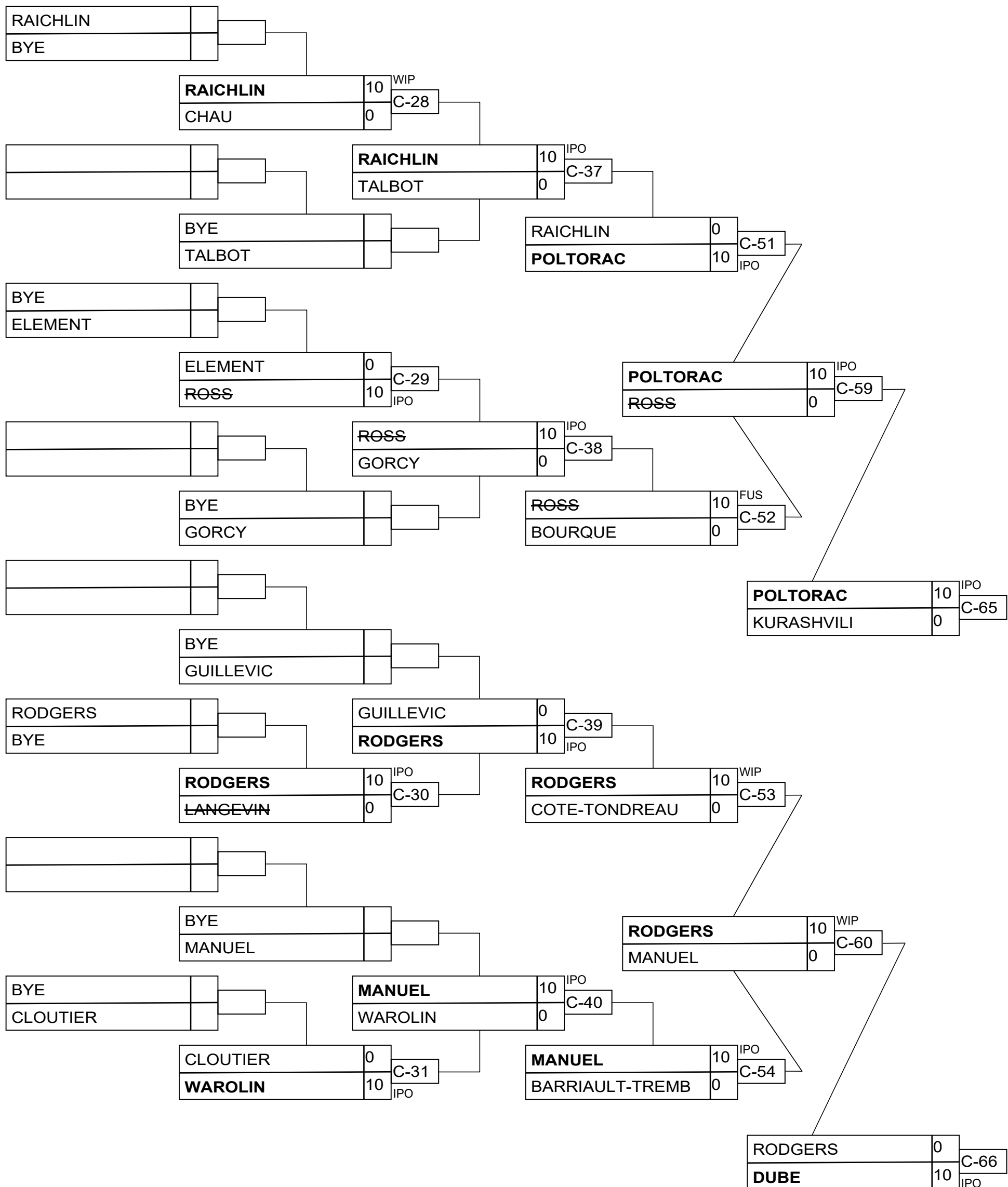

U14M -42

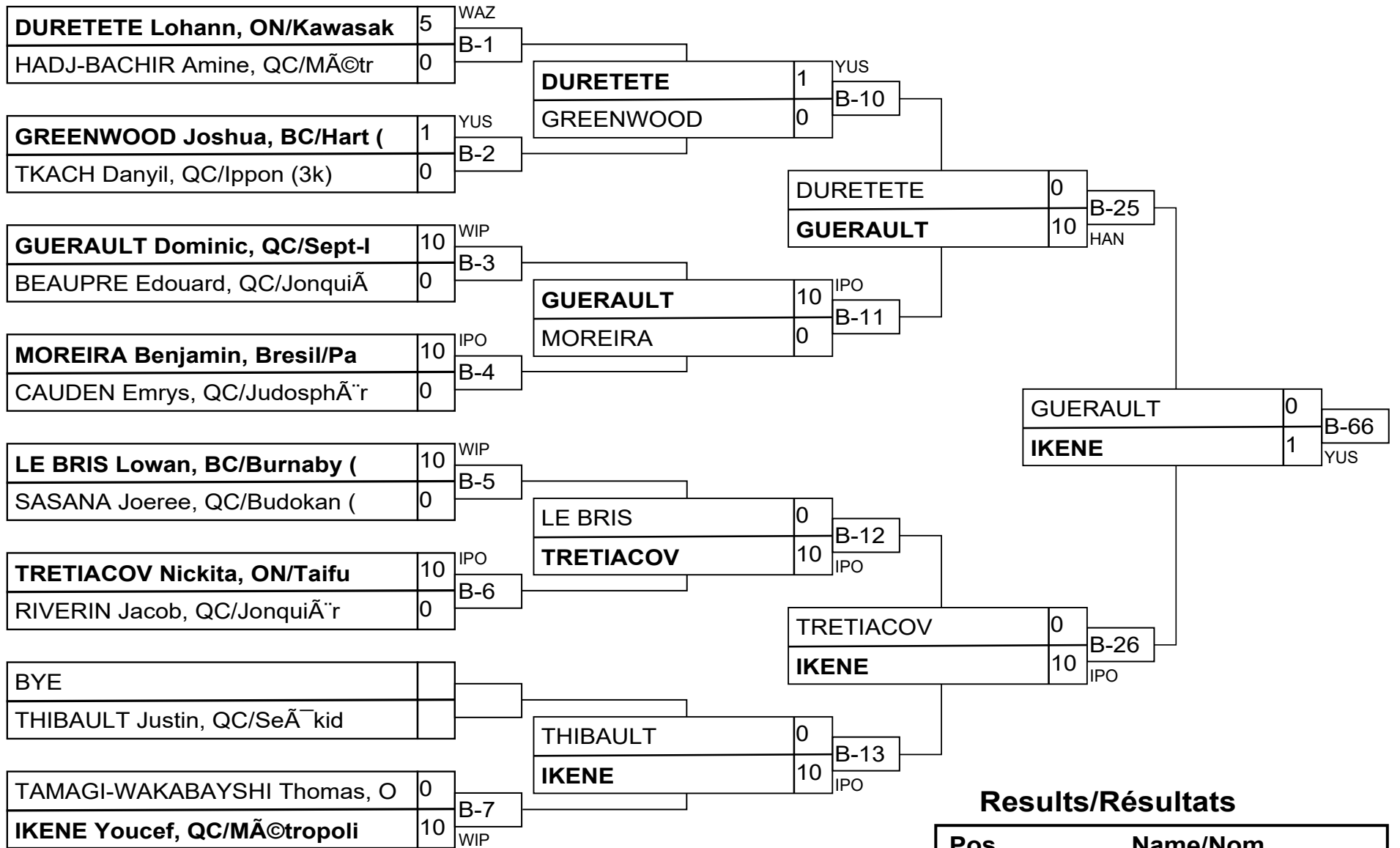

Results/RÃ©sultats

| Pos | Name/Nom |
|-----|---------------------------|
| 1 | IKENE Youcef, QC/MÃ©trop |
| 2 | GUERAULT Dominic, QC/Sep |
| 3 | HADJ-BACHIR Amine, QC/MÃ© |
| 3 | TRETIACOV Nickita, ON/Ta |

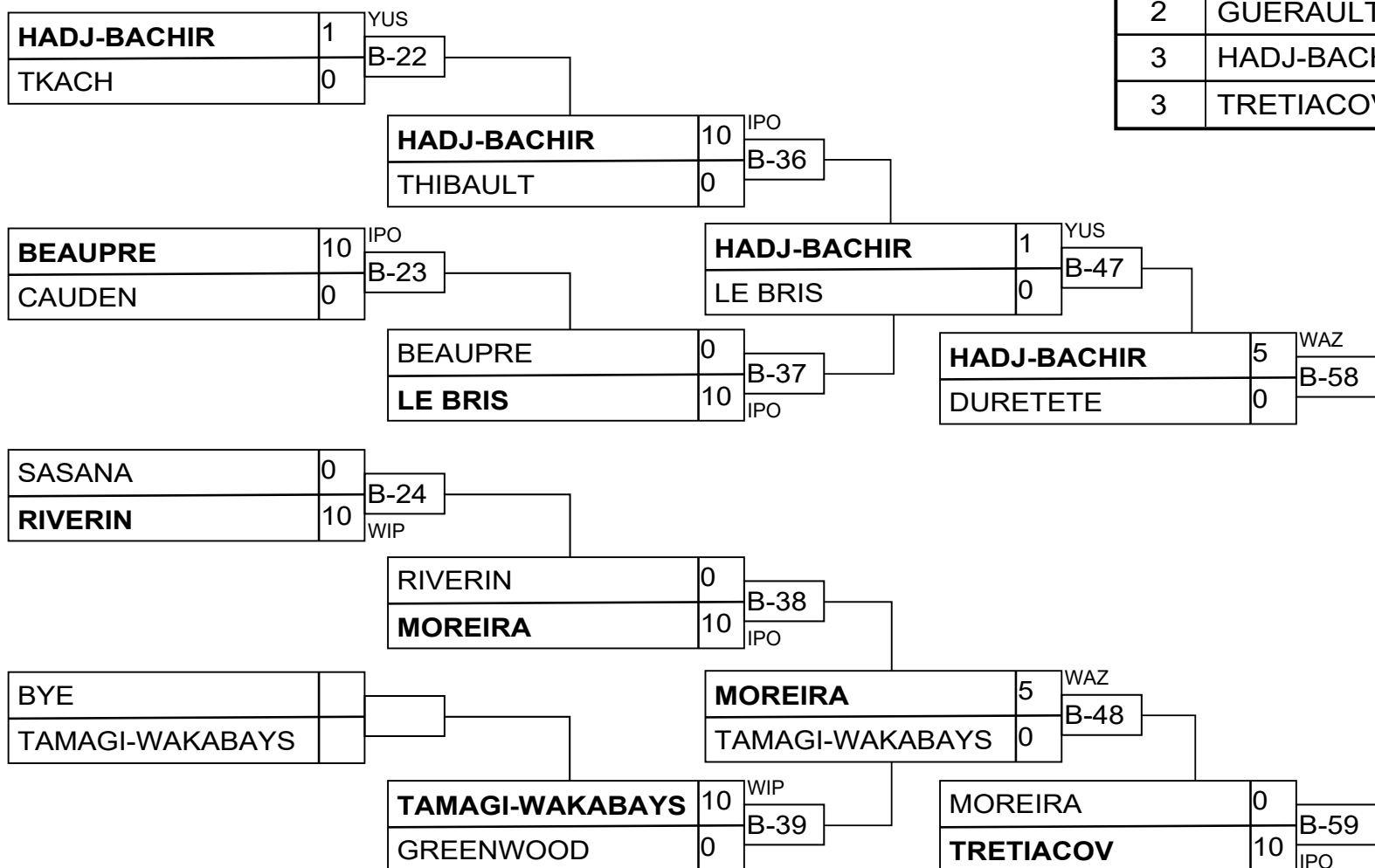

U14M -46

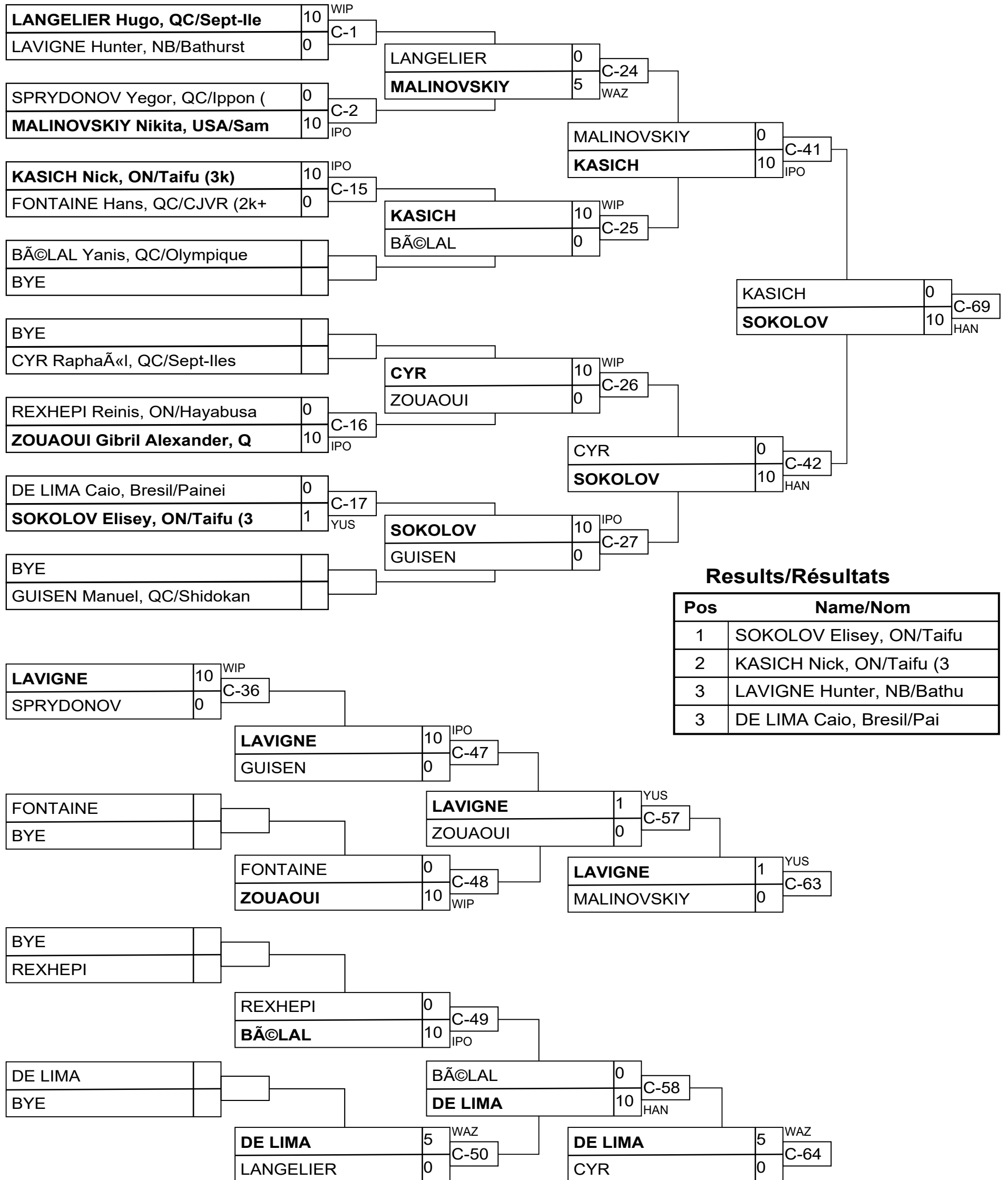

U14M -50

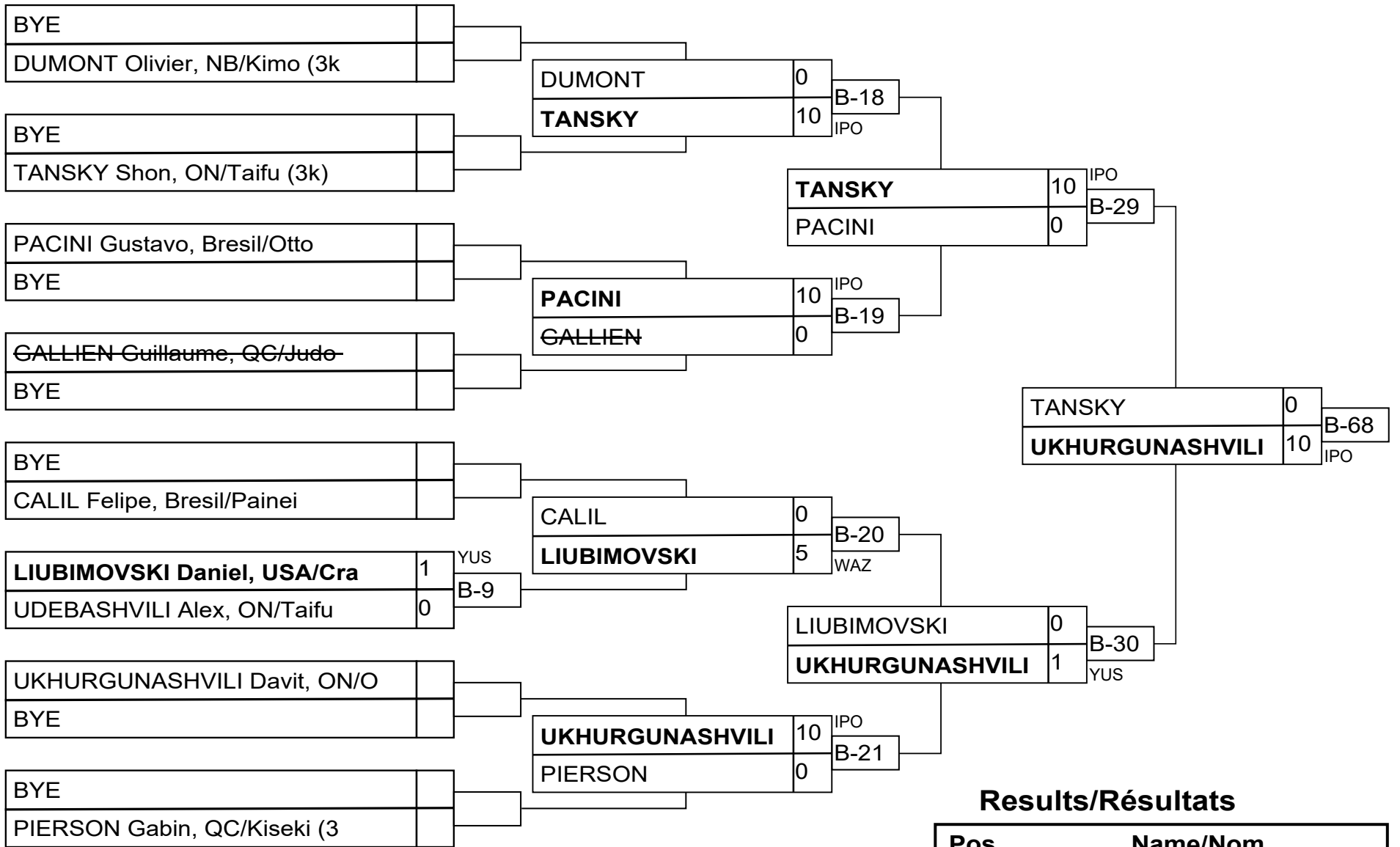

Results/Résultats

| Pos | Name/Nom |
|-----|--------------------------|
| 1 | UKHURGUNASHVILI Davit, O |
| 2 | TANSKY Shon, ON/Taifu (3 |
| 3 | PACINI Gustavo, Bresil/O |
| 3 | LIUBIMOVSKI Daniel, USA/ |

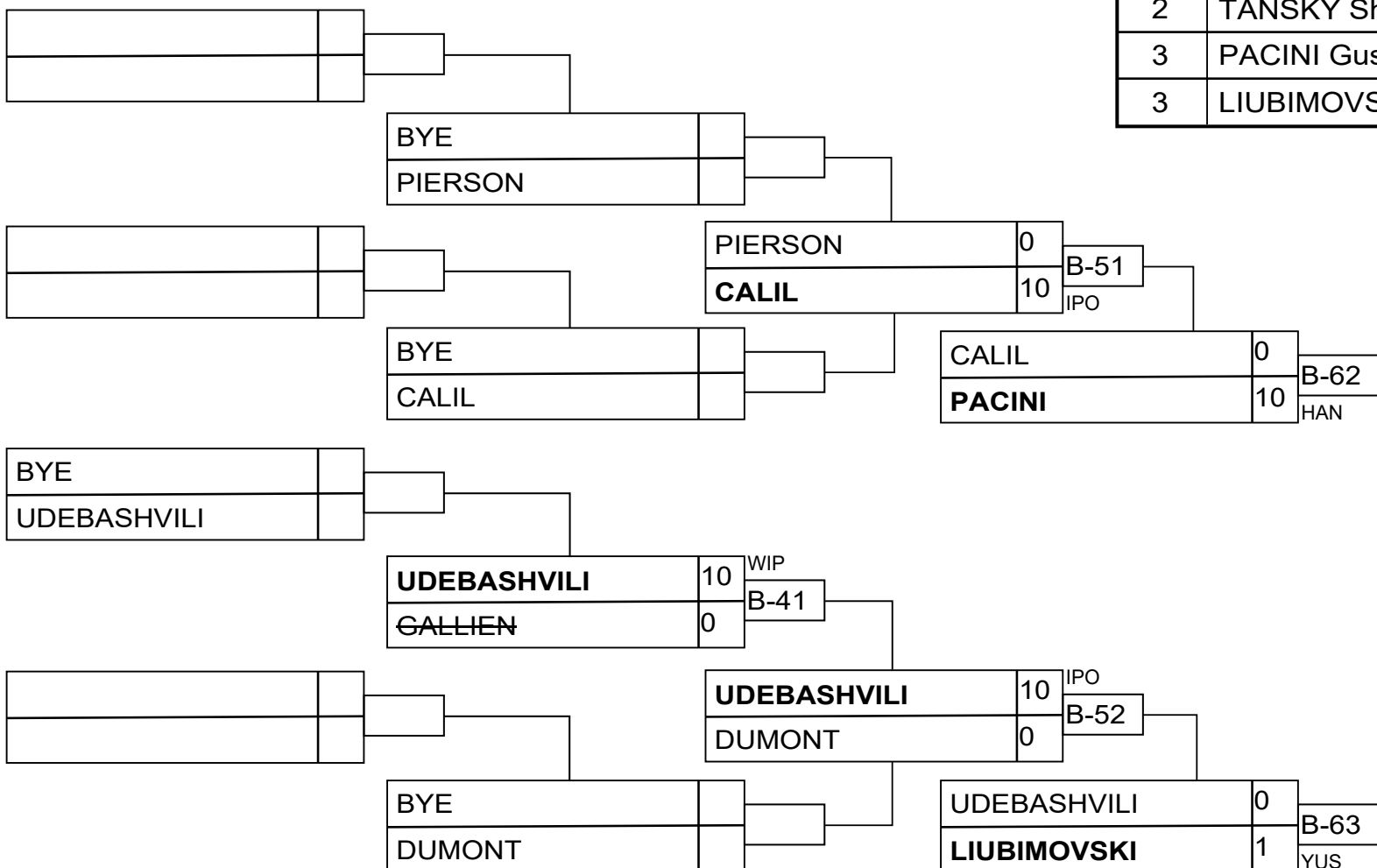

U14M -55

Competitors/Compétiteurs A

| # | Name/Nom | Grade | Club | 1 | 2 | 3 | W/G | Pts | Pos |
|---|------------------------|-------|-------------|----|----|----|-----|-----|-----|
| 1 | ZANATELI Murilo (0,00) | 3k | Bresil/Maua | XX | 10 | 10 | 2 | 20 | 1 |
| 2 | BOURGOIN Maxime (0,00) | 3k+ | NB/Otoshi | | XX | 10 | 1 | 10 | 2 |
| 3 | DI CESARE Tomo (0,00) | 3k+ | QC/Shidokan | | | XX | 0 | 0 | 3 |

Matches/Matches A

| Match | White/Blanc | Blue/Bleu | Res/Rés | Tim/Tmp | Code |
|-------|------------------------|-----------------|---------|---------|------|
| D-1 | ZANATELI Murilo 1 2 | BOURGOIN Maxime | 10 - 0 | 1:53 | WIP |
| D-35 | ZANATELI Murilo 1 3 | DI CESARE Tomo | 10 - 0 | 0:59 | WIP |
| D-51 | BOURGOIN Maxime 2 3 | DI CESARE Tomo | 10 - 0 | 2:34 | IPO |

Competitors/Compétiteurs B

| # | Name/Nom | Grade | Club | 4 | 5 | 6 | W/G | Pts | Pos |
|---|---------------------------------------|-------|------------|----|----|----|-----|-----|-----|
| 4 | ALBERT Jeremy (0,00) | 3k | NB/Kimo | XX | | | 0 | 0 | 3 |
| 5 | DION Noah (0,00) | 3k | QC/Torakai | 10 | XX | 10 | 2 | 20 | 1 |
| 6 | BOUCHARD Jean-David (0,00) | 2k+ | QC/Fermont | 10 | | XX | 1 | 10 | 2 |

Matches/Matches B

| Match | White/Blanc | Blue/Bleu | Res/Rés | Tim/Tmp | Code |
|-------|----------------------|---------------------|---------|---------|------|
| D-2 | ALBERT Jeremy 4 5 | DION Noah | 0 - 10 | 1:59 | WIP |
| D-36 | ALBERT Jeremy 4 6 | BOUCHARD Jean-David | 0 - 10 | 1:38 | WIP |
| D-52 | DION Noah 5 6 | BOUCHARD Jean-David | 10 - 0 | 1:16 | DHM |

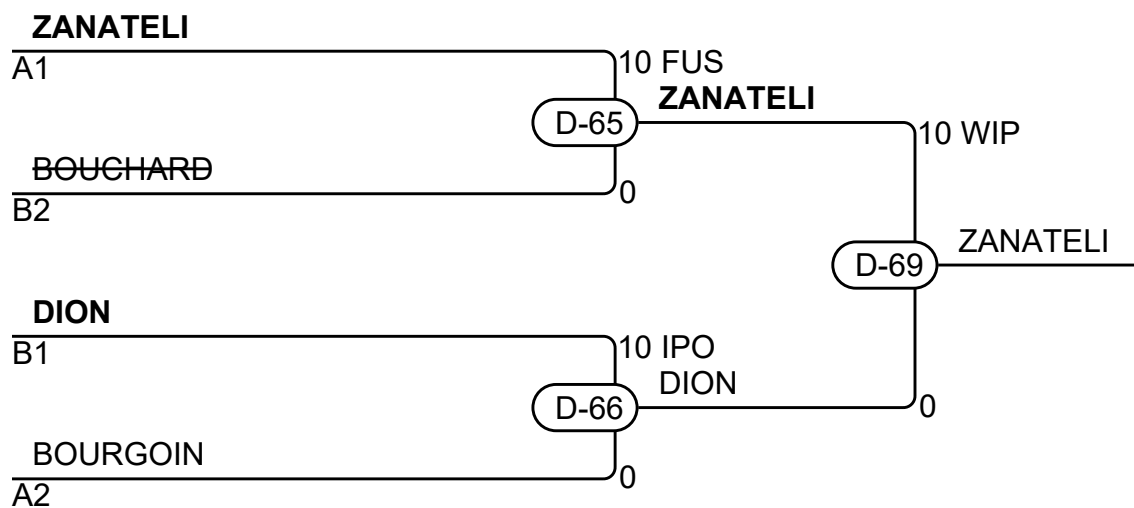

Results/Résultats

| Pos | Name/Nom |
|-----|--|
| 1 | ZANATELI Murilo, Bresil/Maua |
| 2 | DION Noah, QC/Torakai |
| 3 | BOUCHARD Jean-David, QC/Fermont |
| 3 | BOURGOIN Maxime, NB/Otoshi |

U14M -60

Competitors/Compétiteurs

| # | Name/Nom | Grade | Club | 1 | 2 | 3 | 4 | 5 | W/G | Pts | Pos |
|---|---------------------------------------|-------|-----------------------|----|----|----|----|----|-----|-----|-----|
| 1 | SHULGIN Daniel (0,00) | 2k | USA/Yawara Force Judo | XX | 10 | | 10 | | 2 | 20 | 3 |
| 2 | GLAUDE Philippe (0,00) | 3k+ | QC/Haut-Richelieu | | XX | 10 | 10 | 10 | 3 | 30 | 1 |
| 3 | DELLAQUILA Lucas (0,00) | 3k | Bresil/Paineiras | 10 | | XX | 10 | 1 | 3 | 21 | 2 |
| 4 | MERTARCHYAN Patrick (0,00) | 3k | ON/Challenge | | | | XX | | 0 | 0 | 5 |
| 5 | PEREGORODIEV Mikhail (0,00) | 3k | ON/Taifu | 1 | | | 10 | XX | 2 | 11 | 4 |

Matches/Matches

| Match | White/Blanc | | | Blue/Bleu | Res/Rés | Tim/Tmp | Code |
|-------|---------------------|---|---|----------------------|---------|---------|------|
| D-15 | MERTARCHYAN Patrick | 4 | 5 | PEREGORODIEV Mikhail | 0 - 10 | 0:42 | IPO |
| D-16 | SHULGIN Daniel | 1 | 2 | GLAUDE Philippe | 10 - 0 | 2:36 | IPO |
| D-21 | DELLAQUILA Lucas | 3 | 4 | MERTARCHYAN Patrick | 10 - 0 | 0:05 | IPO |
| D-22 | SHULGIN Daniel | 1 | 5 | PEREGORODIEV Mikhail | 0 - 1 | 3:00 | YUS |
| D-32 | GLAUDE Philippe | 2 | 3 | DELLAQUILA Lucas | 10 - 0 | 1:43 | IPO |
| D-33 | SHULGIN Daniel | 1 | 4 | MERTARCHYAN Patrick | 10 - 0 | 0:00 | FUS |
| D-48 | DELLAQUILA Lucas | 3 | 5 | PEREGORODIEV Mikhail | 1 - 0 | 3:00 | YUS |
| D-49 | GLAUDE Philippe | 2 | 4 | MERTARCHYAN Patrick | 10 - 0 | 0:00 | FUS |
| D-62 | SHULGIN Daniel | 1 | 3 | DELLAQUILA Lucas | 0 - 10 | 1:37 | WIP |
| D-63 | GLAUDE Philippe | 2 | 5 | PEREGORODIEV Mikhail | 10 - 0 | 2:33 | HAN |

Results/Résultats

| Pos | Name/Nom |
|-----|---------------------------------------|
| 1 | GLAUDE Philippe, QC/Haut-Richelieu |
| 2 | DELLAQUILA Lucas, Bresil/Paineiras |
| 3 | SHULGIN Daniel, USA/Yawara Force Judo |
| 4 | PEREGORODIEV Mikhail, ON/Taifu |
| | |

U14M -66

Competitors/Compétiteurs

| # | Name/Nom | Grade | Club | 1 | 2 | 3 | 4 | W/G | Pts | Pos |
|---|-------------------------------|-------|-------------------|----|----|----|----|-----|-----|-----|
| 1 | CHARRETTON-DELAGRAVE Benjamin | 3k | QC/Kiseki | XX | 10 | 10 | | 2 | 20 | 2 |
| 2 | SILEM Mohamed Amine (0,00) | 3k+ | QC/MÃ©tropolitain | | XX | 10 | | 1 | 10 | 3 |
| 3 | KHALFON Eden (0,00) | 3k | ON/Taifu | | | XX | | 0 | 0 | 4 |
| 4 | TEMATIEU Angelo (0,00) | 3k | QC/Budokai (QC) | 10 | 10 | 10 | XX | 3 | 30 | 1 |

Matches/Matches

| Match | White/Blanc | | | Blue/Bleu | Res/Rés | Tim/Tmp | Code |
|-------|--------------------------------------|---|---|------------------------|---------|---------|------|
| B-31 | CHARRETTON-DELAGRAVE Benjamin | 1 | 2 | SILEM Mohamed Amine | 10 - 0 | 2:34 | IPO |
| B-32 | KHALFON Eden | 3 | 4 | TEMATIEU Angelo | 0 - 10 | 0:14 | IPO |
| B-42 | CHARRETTON-DELAGRAVE Benjamin | 1 | 3 | KHALFON Eden | 10 - 0 | 2:45 | WIP |
| B-43 | SILEM Mohamed Amine | 2 | 4 | TEMATIEU Angelo | 0 - 10 | 1:59 | WIP |
| B-53 | CHARRETTON-DELAGRAVE Benjamin | 1 | 4 | TEMATIEU Angelo | 0 - 10 | 1:30 | IPO |
| B-54 | SILEM Mohamed Amine | 2 | 3 | KHALFON Eden | 10 - 0 | 2:02 | IPO |

Results/Résultats

| Pos | Name/Nom |
|-----|--|
| 1 | TEMATIEU Angelo, QC/Budokai (QC) |
| 2 | CHARRETTON-DELAGRAVE Benjamin, QC/Kiseki |
| 3 | SILEM Mohamed Amine, QC/MÃ©tropolitain |
| | |

U14M +66

Competitors/Compétiteurs

| # | Name/Nom | Grade | Club | 1 | 2 | 1 | 2 | 1 | 2 | W/G | Pts | Pos |
|---|-----------------------|-------|-------------|----|----|----|----|----|----|-----|-----|-----|
| 1 | REIS Gustavo (0,00) | 3k | Bresil/Maua | XX | 10 | XX | 10 | XX | | 2 | 20 | 1 |
| 2 | ZANATELI Bruno (0,00) | 3k | Bresil/Maua | | XX | | XX | | XX | 0 | 0 | 2 |

Matches/Matches

| Match | White/Blanc | | | Blue/Bleu | Res/Rés | Tim/Tmp | Code |
|-------|---------------------|---|---|---------------------|---------|---------|------|
| D-34 | REIS Gustavo | 1 | 2 | ZANATELI Bruno | 10 - 0 | 1:52 | IPO |
| D-50 | ZANATELI Bruno | 2 | 1 | REIS Gustavo | 0 - 10 | 0:46 | IPO |
| D-64 | REIS Gustavo | 1 | 2 | ZANATELI Bruno | | | |

Results/Résultats

| Pos | Name/Nom |
|-----|---------------------------|
| 1 | REIS Gustavo, Bresil/Maua |
| | |

Vet F1 -63

Competitors/Compétiteurs

| # | Name/Nom | Grade | Club | 1 | 2 | 1 | 2 | 1 | 2 | W/G | Pts | Pos |
|---|---------------------------|-------|-------------|----|----|----|----|----|----|-----|-----|-----|
| 1 | DO AMARAL JÃ©ssica (0,00) | 1d | Bresil/Maua | XX | 10 | XX | 10 | XX | | 2 | 20 | 1 |
| 2 | TARDIF Catherine (0,00) | 1k | QC/Torakai | | XX | | XX | | XX | 0 | 0 | 2 |

Matches/Matches

| Match | White/Blanc | | | Blue/Bleu | Res/Rés | Tim/Tmp | Code |
|-------|---------------------------|---|---|---------------------------|---------|---------|------|
| A-21 | DO AMARAL JÃ©ssica | 1 | 2 | TARDIF Catherine | 10 - 0 | 0:21 | IPO |
| A-36 | TARDIF Catherine | 2 | 1 | DO AMARAL JÃ©ssica | 0 - 10 | 1:30 | IPO |
| A-51 | DO AMARAL JÃ©ssica | 1 | 2 | TARDIF Catherine | | | |

Results/Résultats

| Pos | Name/Nom |
|-----|---------------------------------|
| 1 | DO AMARAL JÃ©ssica, Bresil/Maua |
| | |

Vet M1M2 -81

Competitors/Compétiteurs

| # | Name/Nom | Grade | Club | 1 | 2 | 3 | 4 | W/G | Pts | Pos |
|---|-----------------------------|-------|----------------------|----|----|----|----|-----|-----|-----|
| 1 | PINEL Julien (0,00) | 1k | QC/Kiseki | XX | 10 | 10 | | 2 | 20 | 2 |
| 2 | JOBIN Benoit (0,00) | 1d | QC/Univestrie/Donini | | XX | | | 0 | 0 | 4 |
| 3 | KRISTOFFERSEN Samuel (0,00) | 3d | NB/Fredericton | | 10 | XX | | 1 | 10 | 3 |
| 4 | WILLIAMS Steven (0,00) | 1d | AB/Hiro's | 10 | 10 | 10 | XX | 3 | 30 | 1 |

Matches/Matches

| Match | White/Blanc | | | Blue/Bleu | Res/Rés | Tim/Tmp | Code |
|-------|----------------------|---|---|-----------------------------|---------|---------|------|
| A-25 | PINEL Julien | 1 | 2 | JOBIN Benoit | 10 - 0 | 2:01 | IPO |
| A-26 | KRISTOFFERSEN Samuel | 3 | 4 | WILLIAMS Steven | 0 - 10 | 2:52 | WIP |
| A-40 | PINEL Julien | 1 | 3 | KRISTOFFERSEN Samuel | 10 - 0 | 0:14 | IPO |
| A-41 | JOBIN Benoit | 2 | 4 | WILLIAMS Steven | 0 - 10 | 1:26 | IPO |
| A-55 | PINEL Julien | 1 | 4 | WILLIAMS Steven | 0 - 10 | 4:00 | HAN |
| A-56 | JOBIN Benoit | 2 | 3 | KRISTOFFERSEN Samuel | 0 - 10 | 2:07 | WIP |

Results/Résultats

| Pos | Name/Nom |
|-----|--------------------------------------|
| 1 | WILLIAMS Steven, AB/Hiro's |
| 2 | PINEL Julien, QC/Kiseki |
| 3 | KRISTOFFERSEN Samuel, NB/Fredericton |
| | |

Vet M1M2 +100

Competitors/Compétiteurs

| # | Name/Nom | Grade | Club | 1 | 2 | 3 | W/G | Pts | Pos |
|---|---------------------------|-------|----------------|----|----|----|-----|-----|-----|
| 1 | LATOUR Jeremy (0,00) | 1k | ON/Battle Arts | XX | 10 | | 1 | 10 | 2 |
| 2 | POWER Shannon (0,00) | 1d | QC/Fermont | | XX | | 0 | 0 | 3 |
| 3 | DOS SANTOS Rogerio (0,00) | 1d | Bresil/Maua | 10 | 10 | XX | 2 | 20 | 1 |

Matches/Matches

| Match | White/Blanc | | | Blue/Bleu | Res/Rés | Tim/Tmp | Code |
|-------|----------------------|---|---|---------------------------|---------|---------|------|
| A-22 | LATOUR Jeremy | 1 | 2 | POWER Shannon | 10 - 0 | 1:29 | WIP |
| A-37 | LATOUR Jeremy | 1 | 3 | DOS SANTOS Rogerio | 0 - 10 | 3:41 | HAN |
| A-52 | POWER Shannon | 2 | 3 | DOS SANTOS Rogerio | 0 - 10 | 0:00 | FUS |

Results/Résultats

| Pos | Name/Nom |
|-----|---------------------------------|
| 1 | DOS SANTOS Rogerio, Bresil/Maua |
| 2 | LATOUR Jeremy, ON/Battle Arts |
| | |

Vet M1M3 -100

Competitors/Compétiteurs A

| # | Name/Nom | Grade | Club | 1 | 2 | 3 | W/G | Pts | Pos |
|---|-------------------------|-------|-------------------|----|----|----|-----|-----|-----|
| 1 | BOUCHARD Danny (0,00) | 2d | QC/Fermont | XX | 10 | 10 | 2 | 20 | 1 |
| 2 | KINGSTON Robert (0,00) | 1d | AB/Kodokwai | | XX | | 0 | 0 | 3 |
| 3 | ROCHELEAU Danick (0,00) | 1k | QC/MÃ©tropolitain | | 10 | XX | 1 | 10 | 2 |

Matches/Matches A

| Match | White/Blanc | Blue/Bleu | Res/Rés | Tim/Tmp | Code |
|-------|-----------------|----------------------|---------|---------|------|
| A-17 | BOUCHARD Danny | 1 2 KINGSTON Robert | 10 - 0 | 0:12 | IPO |
| A-32 | BOUCHARD Danny | 1 3 ROCHELEAU Danick | 10 - 0 | 1:58 | WIP |
| A-47 | KINGSTON Robert | 2 3 ROCHELEAU Danick | 0 - 10 | 0:14 | IPO |

Competitors/Compétiteurs B

| # | Name/Nom | Grade | Club | 4 | 5 | 6 | W/G | Pts | Pos |
|---|-------------------------|-------|-------------------|----|----|----|-----|-----|-----|
| 4 | BOURQUE Frédéric (0,00) | 1d | QC/Boucherville | XX | | | 0 | 0 | 3 |
| 5 | UZOKA Ugo (0,00) | 1d | ON/Ajax Budokan | 5 | XX | | 1 | 5 | 2 |
| 6 | JUTRAS David (0,00) | 1d | QC/MÃ©tropolitain | 10 | 10 | XX | 2 | 20 | 1 |

Matches/Matches B

| Match | White/Blanc | Blue/Bleu | Res/Rés | Tim/Tmp | Code |
|-------|------------------|------------------|---------|---------|------|
| A-18 | BOURQUE Frédéric | 4 5 UZOKA Ugo | 0 - 5 | 0:12 | WAZ |
| A-33 | BOURQUE Frédéric | 4 6 JUTRAS David | 0 - 10 | 0:11 | IPO |
| A-48 | UZOKA Ugo | 5 6 JUTRAS David | 0 - 10 | 0:44 | IPO |

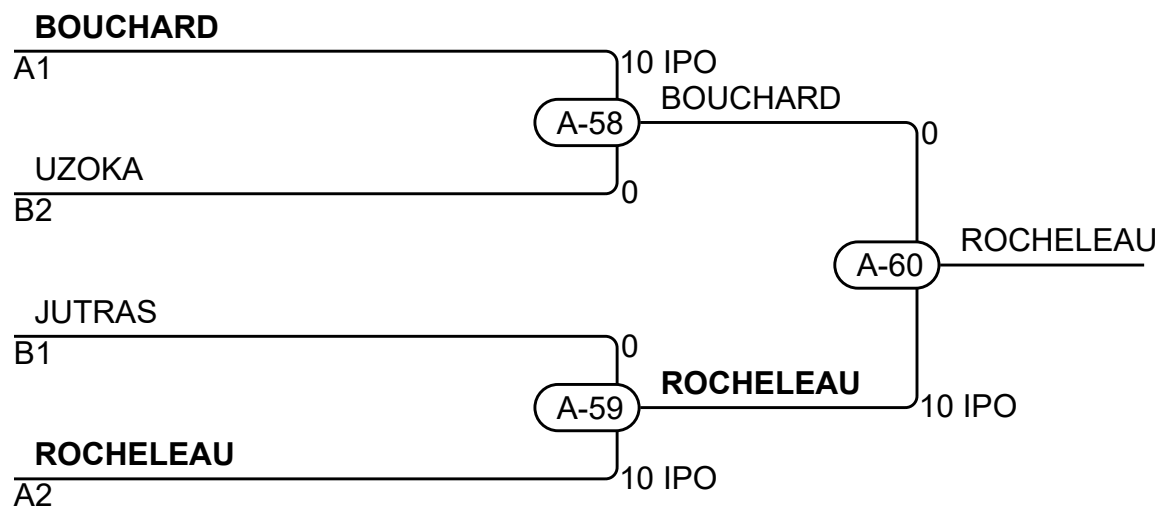

Results/Résultats

| Pos | Name/Nom |
|-----|-------------------------------------|
| 1 | ROCHELEAU Danick, QC/MÃ©tropolitain |
| 2 | BOUCHARD Danny, QC/Fermont |
| 3 | UZOKA Ugo, ON/Ajax Budokan |
| 3 | JUTRAS David, QC/MÃ©tropolitain |

Vet M1M3 -66

Competitors/Compétiteurs

| # | Name/Nom | Grade | Club | 1 | 2 | 3 | 4 | 5 | W/G | Pts | Pos |
|---|----------------------------|-------|--------------|----|----|----|----|----|-----|-----|-----|
| 1 | FONTAINE-BÃ©GIN Julien (0, | 2d | QC/Torakai | XX | | 10 | 10 | | 2 | 20 | 3 |
| 2 | VITUI Arthur (0,00) | 1k | QC/Olympique | 10 | XX | 10 | 10 | 10 | 4 | 40 | 1 |
| 3 | MAHAJAN Ankur (0,00) | 1k | ON/R.A. | | | XX | 10 | | 1 | 10 | 4 |
| 4 | KARN Justin (0,00) | 2d | QC/Shidokan | | | | XX | 10 | 1 | 10 | 5 |
| 5 | DURRIEU Ludovic (0,00) | 2d | QC/Shidokan | 10 | | 10 | | XX | 2 | 20 | 2 |

Matches/Matches

| Match | White/Blanc | | | Blue/Bleu | Res/Rés | Tim/Tmp | Code |
|-------|-------------------------------|---|---|------------------------|---------|---------|------|
| A-5 | KARN Justin | 4 | 5 | DURRIEU Ludovic | 10 - 0 | 0:47 | IPO |
| A-6 | FONTAINE-BÃ©GIN Julien | 1 | 2 | VITUI Arthur | 0 - 10 | 3:09 | GSI |
| A-11 | MAHAJAN Ankur | 3 | 4 | KARN Justin | 10 - 0 | 4:45 | GSI |
| A-12 | FONTAINE-BÃ©GIN Julien | 1 | 5 | DURRIEU Ludovic | 0 - 10 | 1:39 | IPO |
| A-23 | VITUI Arthur | 2 | 3 | MAHAJAN Ankur | 10 - 0 | 2:33 | IPO |
| A-24 | FONTAINE-BÃ©GIN Julien | 1 | 4 | KARN Justin | 10 - 0 | 2:21 | HAN |
| A-38 | MAHAJAN Ankur | 3 | 5 | DURRIEU Ludovic | 0 - 10 | 1:32 | IPO |
| A-39 | VITUI Arthur | 2 | 4 | KARN Justin | 10 - 0 | 1:20 | IPO |
| A-53 | FONTAINE-BÃ©GIN Julien | 1 | 3 | MAHAJAN Ankur | 10 - 0 | 0:38 | IPO |
| A-54 | VITUI Arthur | 2 | 5 | DURRIEU Ludovic | 10 - 0 | 0:28 | IPO |

Results/Résultats

| Pos | Name/Nom |
|-----|------------------------------------|
| 1 | VITUI Arthur, QC/Olympique |
| 2 | DURRIEU Ludovic, QC/Shidokan |
| 3 | FONTAINE-BÃ©GIN Julien, QC/Torakai |
| 4 | MAHAJAN Ankur, ON/R.A. |
| 5 | KARN Justin, QC/Shidokan |

Vet M3M4 -81

Competitors/Compétiteurs

| # | Name/Nom | Grade | Club | 1 | 2 | 3 | 4 | 5 | W/G | Pts | Pos |
|---|--------------------------|-------|-------------------|----|----|----|----|----|-----|-----|-----|
| 1 | BENYOUCEF Nourine (0,00) | 1d | QC/MÃ©tropolitain | XX | | 10 | 10 | 10 | 3 | 30 | 2 |
| 2 | BORAY Amro (0,00) | 3d | NB/Otoshi | 10 | XX | 10 | 10 | 10 | 4 | 40 | 1 |
| 3 | MACDONALD Scott (0,00) | 1k | ON/Jackpine | | | XX | | 10 | 1 | 10 | 4 |
| 4 | GRENIER Patrick (0,00) | 2d | QC/Ju Shin Kan | | | 10 | XX | 10 | 2 | 20 | 3 |
| 5 | NGUYEN Hong (0,00) | 1k | QC/Jikan | | | | | XX | 0 | 0 | 5 |

Matches/Matches

| Match | White/Blanc | | | Blue/Bleu | Res/Rés | Tim/Tmp | Code |
|-------|--------------------------|---|---|------------------------|---------|---------|------|
| A-1 | GRENIER Patrick | 4 | 5 | NGUYEN Hong | 10 - 0 | 3:00 | IPO |
| A-2 | BENYOUCEF Nourine | 1 | 2 | BORAY Amro | 0 - 10 | 4:23 | GSI |
| A-7 | MACDONALD Scott | 3 | 4 | GRENIER Patrick | 0 - 10 | 0:44 | IPO |
| A-8 | BENYOUCEF Nourine | 1 | 5 | NGUYEN Hong | 10 - 0 | 2:17 | WIP |
| A-13 | BORAY Amro | 2 | 3 | MACDONALD Scott | 10 - 0 | 0:25 | IPO |
| A-14 | BENYOUCEF Nourine | 1 | 4 | GRENIER Patrick | 10 - 0 | 2:44 | IPO |
| A-28 | MACDONALD Scott | 3 | 5 | NGUYEN Hong | 10 - 0 | 1:06 | IPO |
| A-29 | BORAY Amro | 2 | 4 | GRENIER Patrick | 10 - 0 | 0:19 | IPO |
| A-43 | BENYOUCEF Nourine | 1 | 3 | MACDONALD Scott | 10 - 0 | 2:51 | WIP |
| A-44 | BORAY Amro | 2 | 5 | NGUYEN Hong | 10 - 0 | 0:40 | WIP |

Results/Résultats

| Pos | Name/Nom |
|-----|--------------------------------------|
| 1 | BORAY Amro, NB/Otoshi |
| 2 | BENYOUCEF Nourine, QC/MÃ©tropolitain |
| 3 | GRENIER Patrick, QC/Ju Shin Kan |
| 4 | MACDONALD Scott, ON/Jackpine |
| | |

Vet M3M4 +100

Competitors/Compétiteurs

| # | Name/Nom | Grade | Club | 1 | 2 | 3 | W/G | Pts | Pos |
|---|----------------------------|-------|---------------|----|----|----|-----|-----|-----|
| 1 | BOUKHOU Mohammed-Amine (0, | 1d | QC/Torii | XX | | | 0 | 0 | 3 |
| 2 | KANE Amath (0,00) | 2d | QC/Olympique | 10 | XX | 10 | 2 | 20 | 1 |
| 3 | FRANCKOWIAK Ryan (0,00) | 1d | ON/Cloverdale | 10 | | XX | 1 | 10 | 2 |

Matches/Matches

| Match | White/Blanc | | | Blue/Bleu | Res/Rés | Tim/Tmp | Code |
|-------|------------------------|---|---|-------------------------|---------|---------|------|
| A-19 | BOUKHOU Mohammed-Amine | 1 | 2 | KANE Amath | 0 - 10 | 1:16 | IPO |
| A-34 | BOUKHOU Mohammed-Amine | 1 | 3 | FRANCKOWIAK Ryan | 0 - 10 | 0:33 | IPO |
| A-49 | KANE Amath | 2 | 3 | FRANCKOWIAK Ryan | 10 - 0 | 0:57 | IPO |

Results/Résultats

| Pos | Name/Nom |
|-----|---------------------------------|
| 1 | KANE Amath, QC/Olympique |
| 2 | FRANCKOWIAK Ryan, ON/Cloverdale |
| | |

Vet M5M6 -81

Competitors/Compétiteurs

| # | Name/Nom | Grade | Club | 1 | 2 | 3 | W/G | Pts | Pos |
|---|------------------------|-------|---------------------|----|----|----|-----|-----|-----|
| 1 | HA Edward (0,00) | 3d | USA/Tech Judo | XX | | 10 | 1 | 10 | 2 |
| 2 | DICKINSON Wayne (0,00) | 5d | USA/Celtic | 10 | XX | 10 | 2 | 20 | 1 |
| 3 | ROY Andr   (0,00) | 1d | QC/Vieille Capitale | | | XX | 0 | 0 | 3 |

Matches/Matches

| Match | White/Blanc | | | Blue/Bleu | Res/R  s | Tim/Tmp | Code |
|-------|-----------------|---|---|-----------------|----------|---------|------|
| A-20 | HA Edward | 1 | 2 | DICKINSON Wayne | 0 - 10 | 0:07 | IPO |
| A-35 | HA Edward | 1 | 3 | ROY Andr   | 10 - 0 | 2:14 | IPO |
| A-50 | DICKINSON Wayne | 2 | 3 | ROY Andr   | 10 - 0 | 0:26 | IPO |

Results/R  sultats

| Pos | Name/Nom |
|-----|-----------------------------|
| 1 | DICKINSON Wayne, USA/Celtic |
| 2 | HA Edward, USA/Tech Judo |
| | |

Vet M5M8 -100

Competitors/Compétiteurs

| # | Name/Nom | Grade | Club | 1 | 2 | 3 | 4 | 5 | W/G | Pts | Pos |
|---|---------------------------|-------|----------------|----|----|----|----|----|-----|-----|-----|
| 1 | BERNAQUEZ François (0,00) | 2d | QC/Bushidokan | XX | | | 10 | 10 | 2 | 20 | 3 |
| 2 | LAVOIE Vincent (0,00) | 2d | QC/Multisports | 5 | XX | | 10 | 10 | 3 | 25 | 2 |
| 3 | SHAPORIN Igor (0,00) | 2d | RUSS/Russie | 10 | 10 | XX | 10 | 10 | 4 | 40 | 1 |
| 4 | TABAK James (0,00) | 1k | USA/Celtic | | | | XX | | 0 | 0 | 5 |
| 5 | MARSH Robert (0,00) | 1d | USA/Celtic | | | | 10 | XX | 1 | 10 | 4 |

Matches/Matches

| Match | White/Blanc | | | Blue/Bleu | Res/Rés | Tim/Tmp | Code |
|-------|--------------------|---|---|----------------|---------|---------|------|
| A-3 | TABAK James | 4 | 5 | MARSH Robert | 0 - 10 | 0:35 | WIP |
| A-4 | BERNAQUEZ François | 1 | 2 | LAVOIE Vincent | 0 - 5 | 4:16 | GSW |
| A-9 | SHAPORIN Igor | 3 | 4 | TABAK James | 10 - 0 | 0:31 | IPO |
| A-10 | BERNAQUEZ François | 1 | 5 | MARSH Robert | 10 - 0 | 1:41 | WIP |
| A-15 | LAVOIE Vincent | 2 | 3 | SHAPORIN Igor | 0 - 10 | 1:08 | IPO |
| A-16 | BERNAQUEZ François | 1 | 4 | TABAK James | 10 - 0 | 0:12 | IPO |
| A-30 | SHAPORIN Igor | 3 | 5 | MARSH Robert | 10 - 0 | 0:20 | IPO |
| A-31 | LAVOIE Vincent | 2 | 4 | TABAK James | 10 - 0 | 0:35 | WIP |
| A-45 | BERNAQUEZ François | 1 | 3 | SHAPORIN Igor | 0 - 10 | 0:41 | IPO |
| A-46 | LAVOIE Vincent | 2 | 5 | MARSH Robert | 10 - 0 | 0:00 | FUS |

Results/Résultats

| Pos | Name/Nom |
|-----|-----------------------------------|
| 1 | SHAPORIN Igor, RUSS/Russie |
| 2 | LAVOIE Vincent, QC/Multisports |
| 3 | BERNAQUEZ François, QC/Bushidokan |
| 4 | MARSH Robert, USA/Celtic |
| | |

VetM-Gr-+100

Competitors/Compétiteurs

| # | Name/Nom | Grade | Club | 1 | 2 | 1 | 2 | 1 | 2 | W/G | Pts | Pos |
|---|----------------------|-------|-------------|----|----|----|----|----|----|-----|-----|-----|
| 1 | OUIMET Maxime (0,00) | 1k | QC/Shidokan | XX | 10 | XX | 10 | XX | | 2 | 20 | 1 |
| 2 | PUDAS Issac (0,00) | 1d | QC/Kiseki | | XX | | XX | | XX | 0 | 0 | 2 |

Matches/Matches

| Match | White/Blanc | | | Blue/Bleu | Res/Rés | Tim/Tmp | Code |
|-------|----------------------|---|---|----------------------|---------|---------|------|
| A-27 | OUIMET Maxime | 1 | 2 | PUDAS Issac | 10 - 0 | 1:26 | HAN |
| A-42 | PUDAS Issac | 2 | 1 | OUIMET Maxime | 0 - 10 | 1:16 | IPO |
| A-57 | OUIMET Maxime | 1 | 2 | PUDAS Issac | | | |

Results/Résultats

| Pos | Name/Nom |
|-----|----------------------------|
| 1 | OUIMET Maxime, QC/Shidokan |
| | |