

Tensioning Solutions Inc.

In Business Since March 2011

October 2019

The Company

Mission

Offer to sign professionals a product line of aluminum extruded bars of the highest quality, designed to fabricate custom frames to stretch banner and textile material.

Addressing many applications, and which are easy to install, versatile, easily changeable and very cost effective.

Applications

Billboards



17'H x 40'W Billboard
Realized with the TS23 extrusion

Stadium Signs



Cleveland Browns Stadium
Two of eight 22'x 42' TS32 frames with mesh banners

Applications

Non-Rectangular Signs

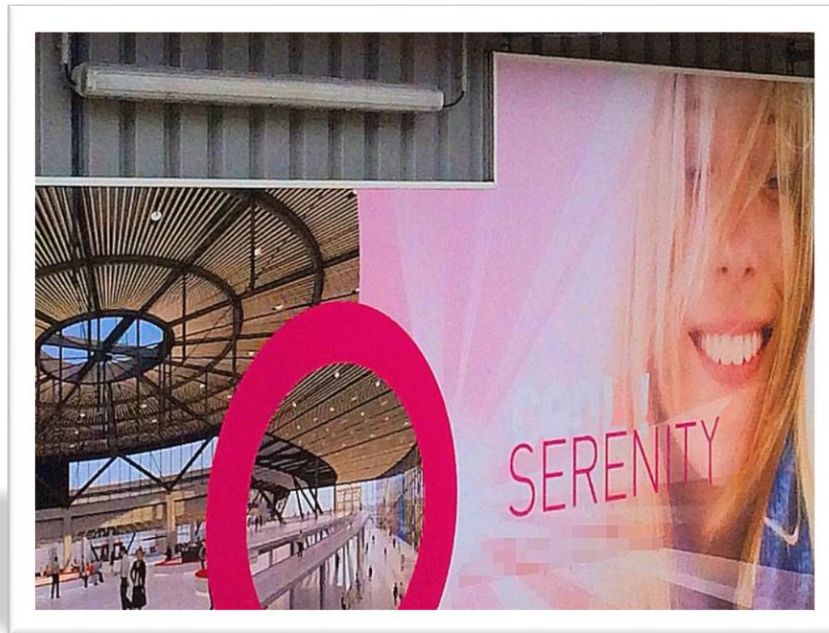

Very Large Signs

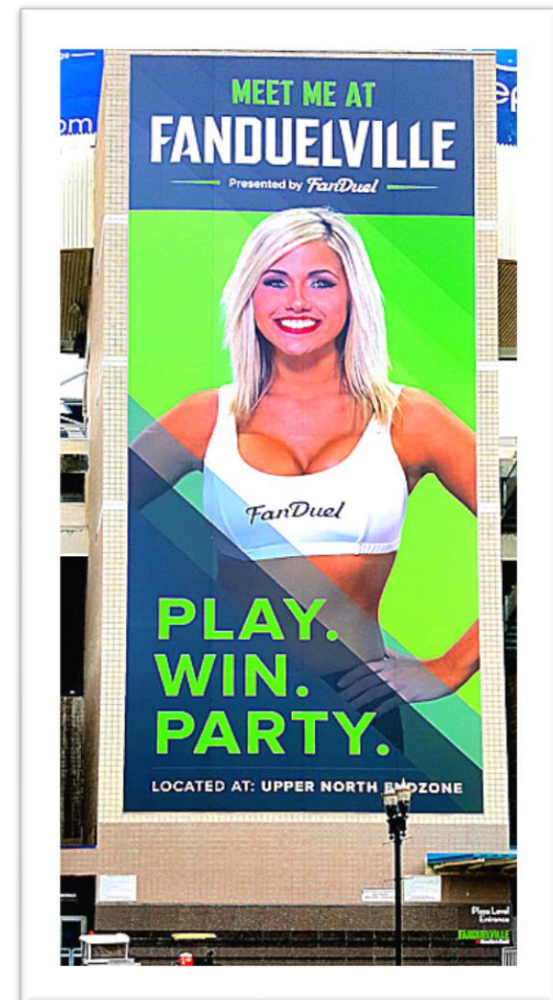

Both signs fabricated with the TS44 extrusion

95.75'H by 40'W
Jacksonville Jaguars Stadium



Applications

Trucks Graphics



Trailers Graphics



Realized with the
TS23 extrusion

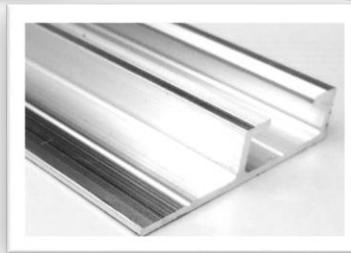

Applications

Schools / Universities



TS32 - 8ft x 17ft Frames with Arch on Top

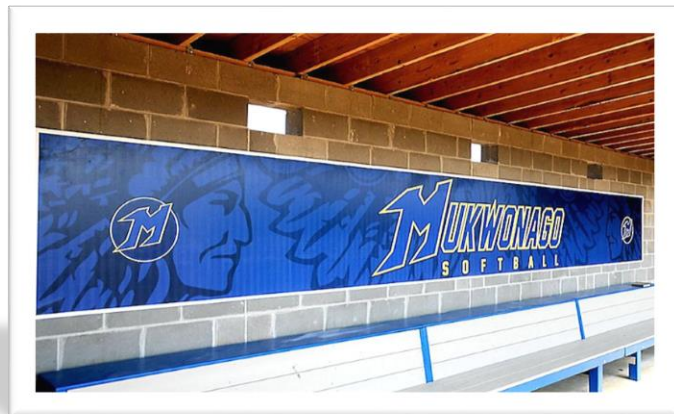

TS23- 3ft x 25ft Framed Graphic

Retail



TS23 for Flex Faces

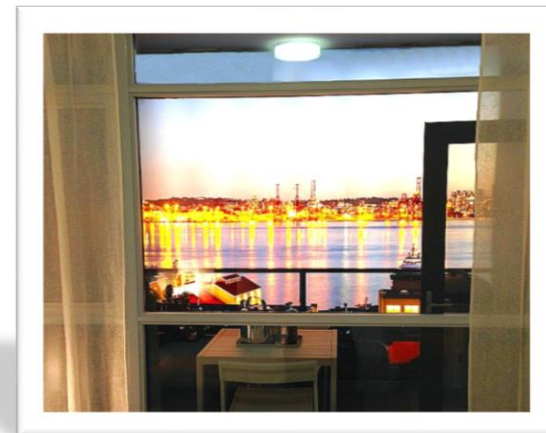

Applications

Museums Exhibits



TS23 - 16'H by 67'W – Cleveland Museum
(Dinosaurs Exhibit)

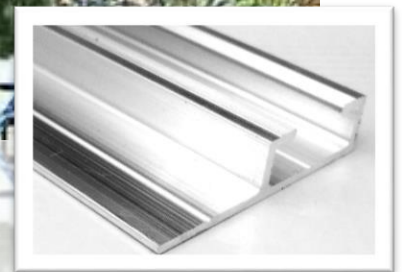

Applications

Supermarkets



3D-Structure with Stretched Banner



Both realized with the TS44 extrusion

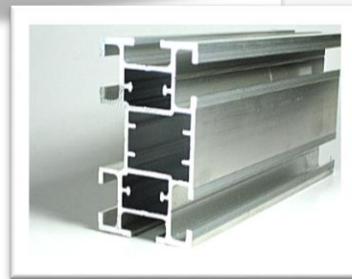

Applications

Façade banners

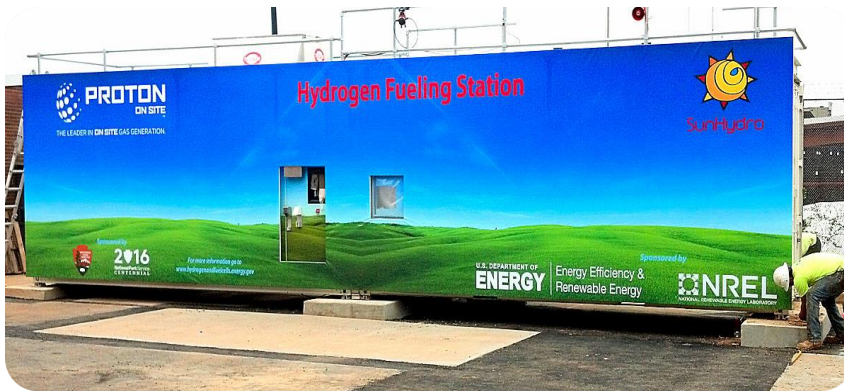

TS44 – 9.4'H by 40'W Hydrogen Pump Station Façade

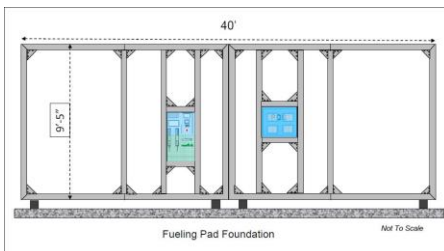

Exhibition Booths



Applications

More Structures with the TS44...

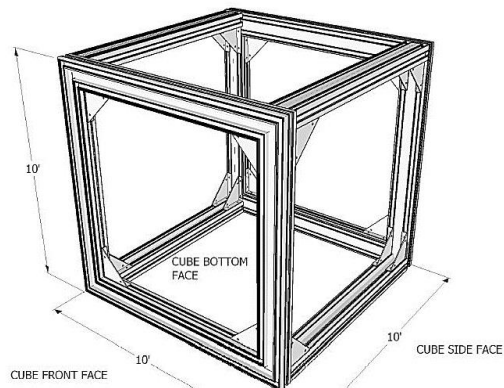

10' x 10' x 10'

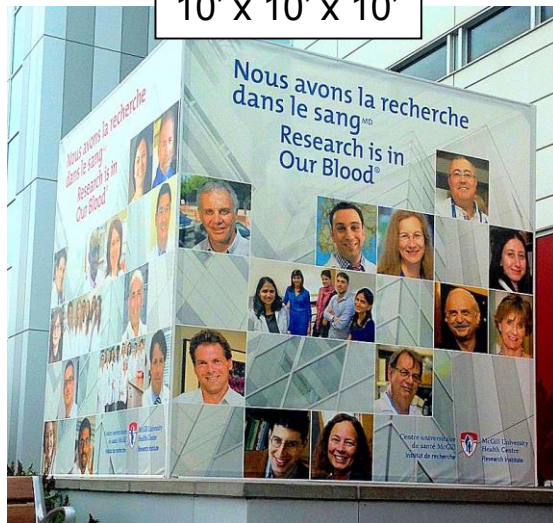

Applications

From Small to Huge Banners...



...We Have the Answer...



...with Unbeatable Prices

300' x 50' Downtown Baltimore

Product Line

Our
Extrusions
are made in
USA

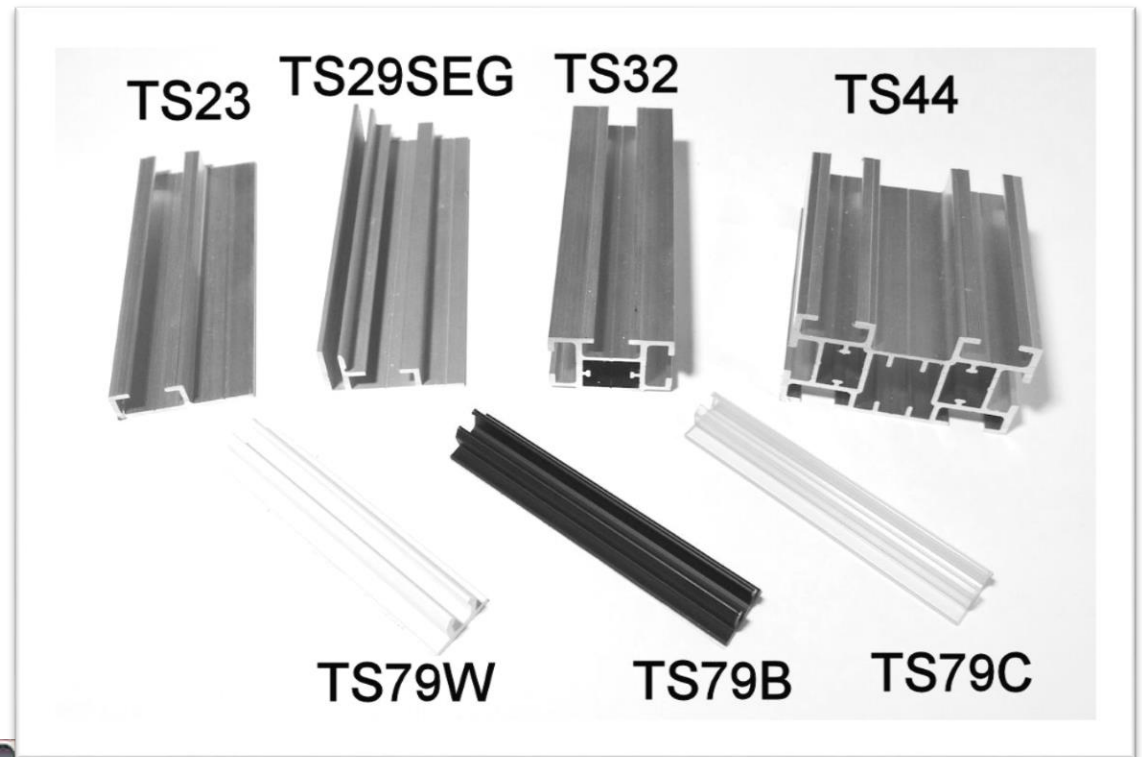

Products

TS23

- The TS23 our lightest extruded aluminum bar is suited for small, mid-size and large interior / exterior signs.
- Easy to install on a variety of supports (concrete, bricks and dry walls...),and ideal for trucks and trailers sides.

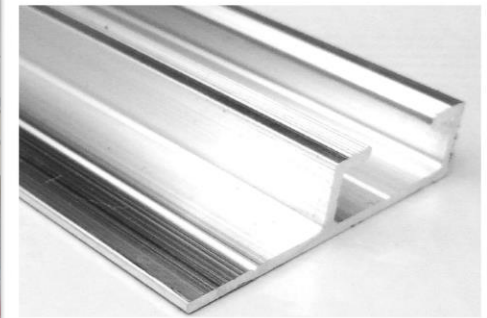

124' by 10'- Curved frame

Products

TS29SEG

- The TS29SEG extrusion is designed for small, mid-size and large interior Silicon Edge Graphics.
- **Applications**
 - Tradeshows, expositions
 - Airports, bus terminals
 - Retail stores
 - Offices, meeting rooms
 - Hotels and hospitality
 - Museums, ...

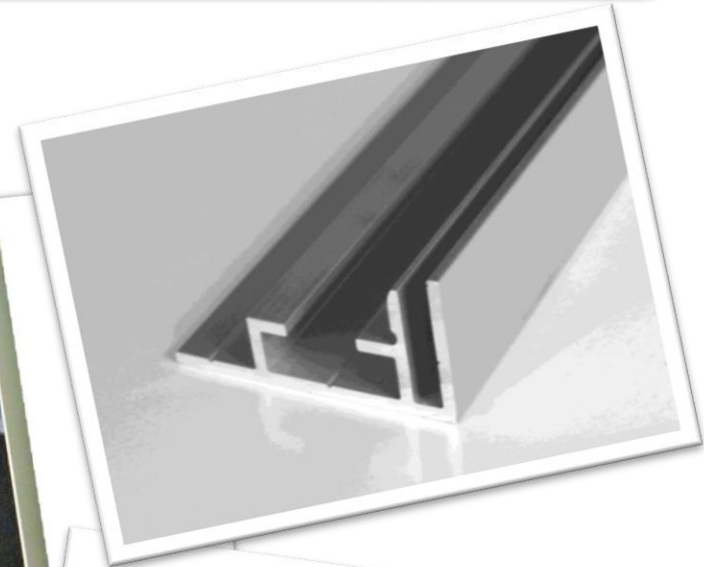
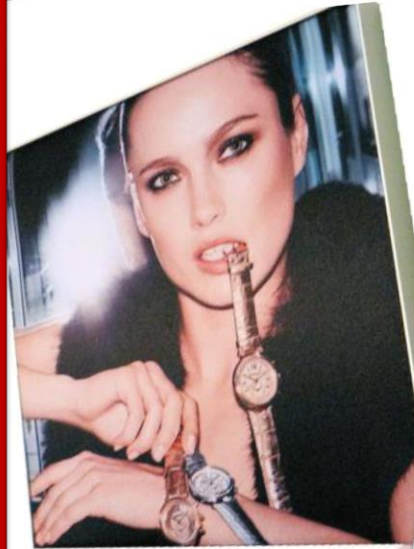

Products

TS2985

- The TS2985 is composed of a TS29SEG extrusion and a TS85 PVC extrusion.
- The TS2985 allows to stretch any textiles (Canvas, polyesters, fabric...) by only using a tensor tool.
- It has the same look and feel and same applications as SEG frames
- [See our Video](#)



Products

TS32

- This extruded aluminum bar is designed for small, mid and large sizes framed banners.
- It also can be used for building light structures.

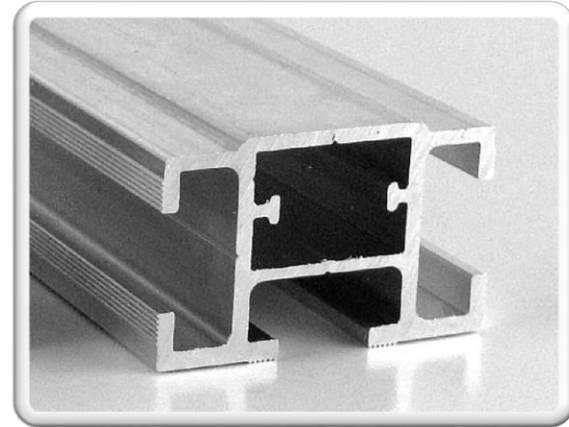

TS32 - Cleveland Browns Food Court
310'W by 13'H Vinyl Banner

Products

TS44

- Our sturdiest extruded aluminum bar is designed for medium to very large signs.
- It is also used for building structures such as exhibition booths, 3D-signs and stand-alone signs.

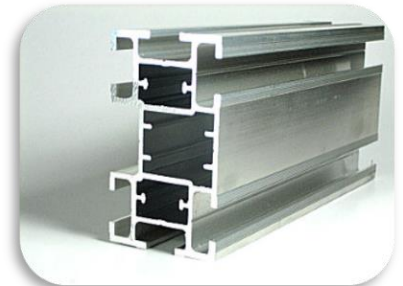
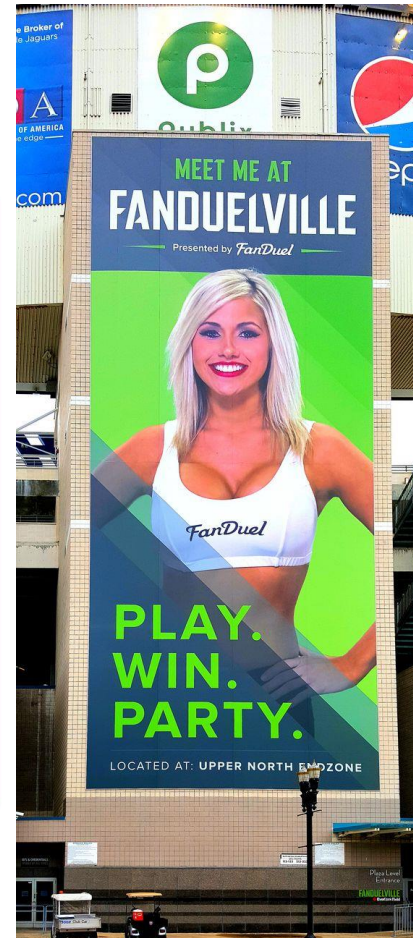

Jaguars Stadium— 96' x 40' Parking – 30' x 50'

Products

TS79x

The top is flat and thick, it has the same thickness on the center and on the sides, making it stronger to absorb hard nylon head hammers blows.

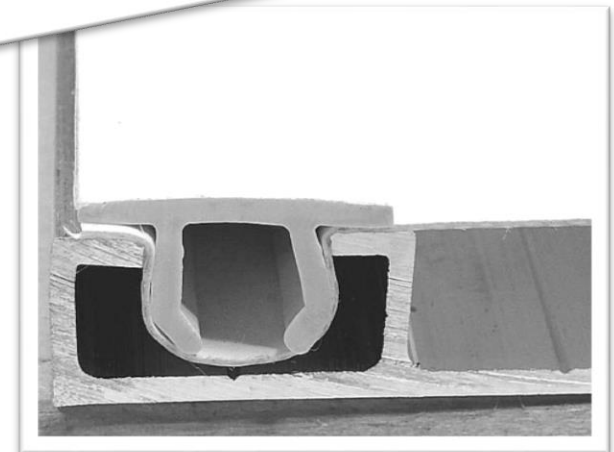

TS79W inserted in TS23

Extrusions Comparison

Products Comparison				
Features	TS23	TS32	TS44	TS29SEG
PVC Insert Model	TS79B&W	TS79B&W	TS79B&W	Not Necessary
Clipping on the front	YES	YES	YES	YES
Clipping on the side	NO	YES	YES	NO
Clipping on the rear (Wrapping)	NO	YES	YES	NO
PVC Corners TS90	NO	YES	YES	NO
PVC Joiners TS91	NO	YES	YES	NO
Applications				
Small frames (1 – 10 Sq Ft)	****	***	*	****
Medium Frames (10 – 100 Sq Ft)	***	****	**	***
Large frames (100 – 1,000 Sq Ft)	**	****	****	**
Very Large Frames (>1,000 Sq Ft)	**	***	****	*
Interior frames	****	***	***	****
Exterior frames	***	****	****	-
Structures / 3D Frames	NO	YES	YES	NO
Characteristics				
Bar Length (Ft)	11.4'	11.4'	11.4'	11.4'
Bar Weight (Lbs.)	2.17	4.56	10.54	2.14
Bar Dimensions (Inches)	3/8"x9/8"x137"	3/4"x1.3"x137"	1.5"x2.5"x137"	1.17"x0.75"x137"

Key Characteristics

Characteristics	Stretching Banners Solutions
Frame Sizes	Small / Medium / Large / Very Large
Non-Rectangular shapes	TS23 / TS32 / TS44
Type of Frames	Customized: Any Sizes
Type of Installations	Wall-mounted Frames/ ART Frames / Stand-Alone Frames / Stand-Alone Structures
Changing Graphics	Easy - TS23 / TS29SEG / TS32 / TS44
Double-Sided Graphics	TS32 / TS44
Edge-to-edge Graphics	TS29SEG / TS2985 / TS32 / TS44
Structures / 3D-Graphics	TS32 / TS44
Curved frames	TS23 / TS32 / TS44

Features and Benefits

1. Customized Frames (Any sizes, Any shapes)
2. Double-Sided Frames
3. Cost-Effective
4. Multiple Applications
5. Edge-to-Edge Graphics
6. 3D-Graphic structures
7. Aluminum extruded bars can be bent

1. Can answer many customers requests and applications
2. Frames can be hung in shops, supermarkets and malls
3. Sign professionals are competitive in their markets
4. Effective product design allows to build from framed banners to structures
5. Hiding the frame when needed
6. Goes beyond simple 2D frames
7. Allows to design curved frames or frames fitting on curved walls

Contact

TENSIONING SOLUTIONS

16517 Lake Heather Drive
Tampa, FL 33618

Cell

1 813-995-5256

Fax

1 813-527-9915

Email

info@tensols.com

Web Site

www.tensioningsolutions.com