



2021 Consolidated Price List

Effective September 1, 2021

THE BRONZE®

Fine Brass Hardware Since 1927

- Colonial Bronze
- The Tanners Craft®
- Josef Ruefelli™



PROUDLY MADE IN THE





































U.S.A.







MINIMUM 94% RECYCLED CONTENT
PRE-CONSUMER

Colonial Bronze Finish Chart

<p>19 ●  Satin Black</p>	<p>D19 ●  Distressed Black</p>	<p>M19 ●  Matte Satin Black</p>	<p>26 ■  Polished Chrome</p>	<p>26D ■  Satin Chrome</p>	<p>M26D ●  Matte Satin Chrome</p>
<p>3 ●  Polished Brass (Unlacq. Pol. Brass - 3A)</p>	<p>4 ■  Satin Brass (Unlacq. Satin Brass - 4A)</p>	<p>5 ●  Antique Brass</p>	<p>AB ●  Antique Bronze</p>	<p>AF ◆  French Gold</p>	<p>D5 ●  Distressed Antique Brass</p>
<p>M4 ●  Matte Satin Brass</p>	<p>M5 ●  Matte Antique Brass</p>	<p>11 ●  Antique Copper</p>	<p>CU ◆  Polished Copper</p>	<p>D11 ●  Distressed Antique Copper</p>	<p>M11 ●  Matte Antique Copper</p>
<p>10B ●  Oil Rubbed Bronze (Unlacq. ORB - 10BU)</p>	<p>20A ●  Dark Statuary Bronze</p>	<p>D10B ●  Distressed Oil Rubbed Bronze</p>	<p>M10B ●  Matte Oil Rubbed Bronze</p>	<p>MSCU ●  Matte Satin Copper</p>	<p>SCU ●  Satin Copper</p>
<p>M20A ●  Matte Dark Statuary Bronze</p>	<p>S10B ●  Heritage Bronze</p>	<p>10 ◆  Satin Bronze</p>	<p>20 ◆  Light Statuary Bronze</p>	<p>9 ◆  Polished Bronze</p>	<p>D20 ●  Distressed Statuary Bronze</p>
<p>14 ●  Polished Nickel</p>	<p>15 ■  Satin Nickel</p>	<p>15B ●  Pewter</p>	<p>15CC ●  Nickel Stainless</p>	<p>M10 ◆  Matte Satin Bronze</p>	<p>M20 ◆  Matte Light Statuary Bronze</p>
<p>D15B ●  Distressed Pewter</p>	<p>M15 ●  Matte Satin Nickel</p>	<p>M15B ●  Matte Pewter</p>	<p>■ Tier 1 Pricing ● Tier 2 Pricing ◆ Tier 3 Pricing</p>		
<p>Every item is available in every finish (some exceptions apply to distressed finishes)</p>					

Frost Finishes

Finish Image	Finish Code	Finish Description	Pricing Tier
	◆ 4F	Frost Brass™	Tier 3
	◆ 15F	Frost Nickel™	Tier 3
	◆ 19F	Frost Black™	Tier 3
	◆ 26F	Frost Chrome™	Tier 3
	◆ WB	Weathered Brass	Tier 3

Finishes and Colors

Finish Code	Finish Description	Pricing Tier	Finish Code	Finish Description	Pricing Tier
3	Polished Brass	2	AB	Antique Bronze	2
3A	Unlacquered Polished Brass	2	AF	French Gold	3
4	Satin Brass	1	CU	Polished Copper	3
4A	Unlacquered Satin Brass	1	SCU	Satin Copper	2
4F	Frost Brass™	3	D5	Distressed Antique Brass	2
5	Antique Satin Brass	2	D10B	Distressed Oil Rubbed Bronze	2
9	Polished Bronze	3	D11	Distressed Antique Copper	2
10	Satin Bronze	3	D15B	Distressed Pewter	2
10B	Oil Rubbed Bronze	2	D19	Distressed Black	2
10BU	Unlacquered Oil Rubbed Bronze	2	D20	Distressed Light Statuary Bronze	2
S10B	Heritage Bronze	2	M4	Matte Satin Brass	2
11	Antique Copper	2	M5	Matte Antique Brass	2
14	Polished Nickel	2	M10	Matte Satin Bronze	3
15	Satin Nickel	1	M10B	Matte Oil Rubbed Bronze	2
15F	Frost Nickel™	3	M11	Matte Antique Copper	2
15B	Pewter	2	M15	Matte Satin Nickel	2
15CC	Nickel Stainless	2	M15B	Matte Pewter	2
19	Satin Black	2	M19	Matte Satin Black	2
19F	Frost Black	3	M20	Matte Light Statuary Bronze	3
20	Light Statuary Bronze	3	M20A	Matte Dark Statuary Bronze	2
20A	Dark Statuary Bronze	2	M26D	Matte Satin Chrome	2
26	Polished Chrome	1	MSCU	Matte Satin Copper	2
26D	Satin Chrome	1	WB	Weathered Brass	3
26F	Frost Chrome™	3			



Colonial Bronze Price List Table of Contents

Finish Codes, Description and Pricing Tiers	2-3
How to Order Cabinet Hardware	5
Price List Brass Cabinet Hardware	6-48
Tanners Craft	49
How to order Tanners Craft	50
Leather Colors	51-52
Price List Tanners Craft	53-61
Josef Ruefelli	62
Josef Ruefelli Designs	63-64
Josef Ruefelli Hardware Styles	65-67
How to order Josef Ruefelli Hardware	68-69
Mounting Options and Information	70-71
Terms and Conditions	72-74

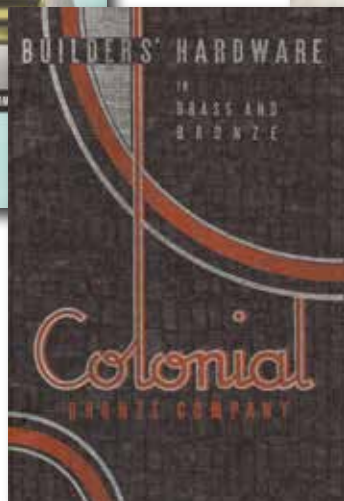

Special Ordering Instructions

EXAMPLE:

Split Finish Brass Cabinet Hardware

To order a "1335-15CC x 4" cabinet pull with two different finishes ("split finish"):

When ordering split finish (combination of two finishes) items, FINISH 1 always refers to the part of the item that touches the mounting surface and FINISH 2 always refers to the accent color.

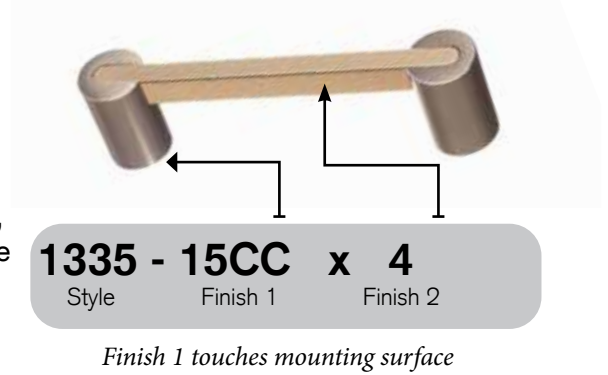

All finishes and codes are provided on page 2-3 of this price list.

EXAMPLE:

Single Finish Architecture Pulls, Bath Accessories and Towel Bars

Be sure to include the type of mounting you want - through-bolt (T), Surface mount (S) or Back to Back (BxB)

To order a "246S-10-26D 12" OA" Large Handle in a single finish:

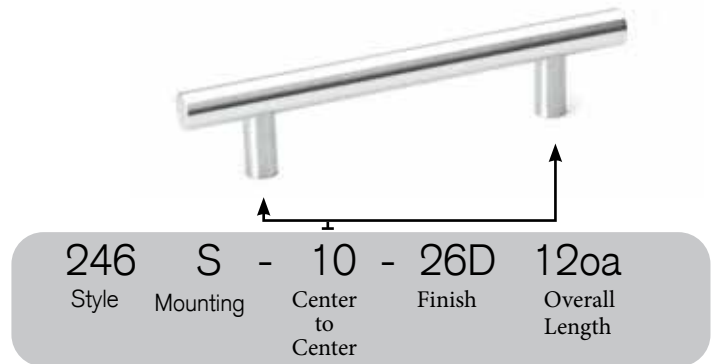

EXAMPLE:

Split Finish Architecture Pulls, Bath Accessories and Towel Bars

To order a "40T-8-M19x15 9 1/2" OA" Large Handle with two finishes ("split finish"):

When ordering split finish (combination of two finishes) items, FINISH 1 always refers to the part of the item that touches the mounting surface and FINISH 2 always refers to the accent color.

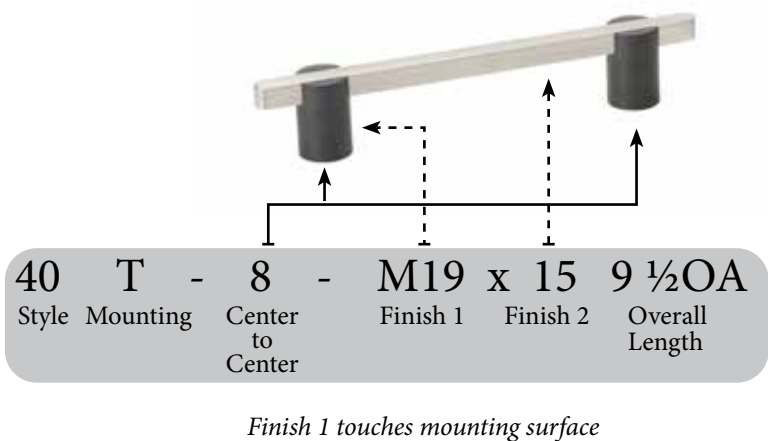

EXAMPLE:

Custom Switchplates

To order a "6001-1D3T-20" Colonial Style with (left to right) a duplex, and three toggles:



6001-1D1T1T1T-20 will be simplified to: 6001-1D3T-20

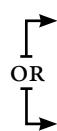

6001	-	1D	1T	1T	1T	-	20
Style		First Box	Second Box	Third Box	Fourth Box		Finish
6001	-	1D	3T			-	20

3



Not Available In Distressed Finishes

Brass Catch

Item	Dim	Proj	US4	US26D	All other finishes	Wt/30
3	3 x 3/4	7/8	\$40.48	\$48.16	\$62.70	3.0

Set screws provide an adjustable tension feature. For surface and mortise applications. Rust-proof balls and springs. Non-ferrous and non-magnetic.

3 1/2 and 4

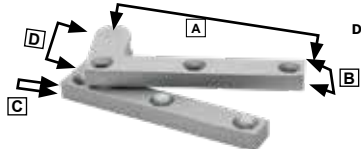

Not Available In Distressed Finishes

Fixed Pin Pivot Hinge

Item	A	B	C	D	Load	Tier 1 Finishes	Tier 2 Finishes	Tier 3 Finishes	Wt/pr
3 1/2	3 7/8	5/8	1/4	1 5/8	70 lb	\$86.36	\$105.60	\$108.06	1.0
4	4 3/8	5/8	1/4	1 7/8	70 lb	\$104.86	\$128.17	\$131.15	1.1

List price per pair. One pair of pivots per door (opening).

5 and 6

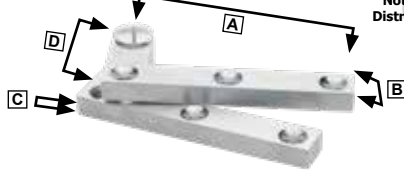

Not Available In Distressed Finishes

Removable Pin Pivot Hinge

Item	A	B	C	D	Load	Tier 1 Finishes	Tier 2 Finishes	Tier 3 Finishes	Wt/pr
5	4 3/8	5/8	1/4	1 7/8	70 lb	\$157.34	\$192.35	\$196.82	1.2
6	4 3/8	5/8	3/8	1 7/8	250 lb	\$278.8	\$340.81	\$348.73	1.6
6B*	4 3/8	5/8	3/8	1 7/8	250 lb	\$278.8	\$340.81	\$348.73	1.4

Reversible and non-handed (left or right handed). One pair of pivots per door (opening). List price is per pair.

* 6B: No. 8 pivot base can be substituted for No. 6 bottom leaf - suitable for concrete floor installations
Pin sizes: No. 5 is 5/16; No. 6 is 7/16.

5FH and 6FH

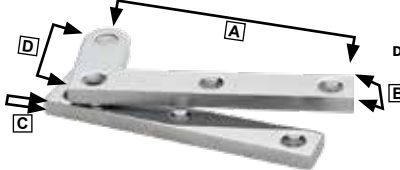

Not Available In Distressed Finishes

Removable Small Form Pin Pivot Hinge

Item	A	B	C	D	Load	Tier 1 Finishes	Tier 2 Finishes	Tier 3 Finishes	Wt/pr
5FH	4 3/8	5/8	1/4	1 7/8	70 lb	\$158.07	\$193.25	\$197.75	1.2
6FH	4 3/8	5/8	3/8	1 7/8	250 lb	\$280.09	\$342.42	\$350.37	1.6

Reversible and non-handed (left or right handed). List price is per pair. One pair of pivots per door (opening).

No. 8 pivot base can be substituted for No. 6FH bottom leaf. Pin sizes: No. 5FH is 9/16; No. 6FH is 5/8.

8



Not Available In Distressed Finishes

Pivot Base

Item	Depth	Dia	OA	Tier 1 Finishes	Tier 2 Finishes	Tier 3 Finishes	Wt/ea
8	1	3/4	1 1/4	\$29.03	\$35.52	\$36.34	0.2

Installs in floor as a base for No. 6 pivot hinge.

9LH and 9RH

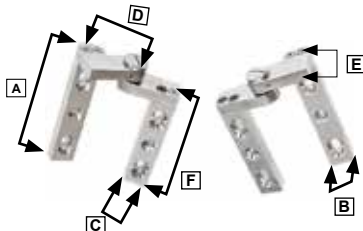

Not Available In Distressed Finishes

Removable Pin Intermediate Pivot Hinge

Item	A	B	C	D	E	F	Tier 1 Finishes	Tier 2 Finishes	Tier 3 Finishes	Wt/each
9LH	4	3/4	3/8	1 7/8	1 1/4	3 5/8	\$231.07	\$282.46	\$289.18	0.8
9RH	4	5/8	3/8	1 7/8	1 1/4	3 5/8	\$231.07	\$282.46	\$289.18	0.8

LIST PRICE is per item or as otherwise specified, in US dollars. WEIGHT is per 10 pieces or as otherwise specified, in lbs.

EMAIL ORDERS TO SALES@THEBRONZE.COM



40 Series



Handle or Towel Bar

Not Available In Distressed Finishes

Item	C-C	Proj	Overall	Post Dia	Tier 1 Finishes	Tier 2 Finishes	All Finishes	Wt/ea
40-6	6	1 1/2	8 1/2	1	N/A	N/A	\$158.50	0.6
40-8	8	1 1/2	10 1/2	1	N/A	N/A	\$198.14	0.7
40	Custom per inch - see page 73 for details						\$25.28	

Refer to page 70 and specify mounting as surface (S), through-bolt (T), or back-to-back (BxB). Extra charges apply for BxB - see page 71. Split-finish item: specify finishes as posts x bar. **8/32 screw holes.**

41 Series



Handle or Towel Bar

Not Available In Distressed Finishes

Item	C-C	Proj	Overall	Post Dia	Tier 1 Finishes	Tier 2 Finishes	All Finishes	Wt/ea
41-6	6	1 1/2	7	1	N/A	N/A	\$118.87	0.5
41-8	8	1 1/2	9	1	N/A	N/A	\$158.50	0.6
41	Custom per inch - see page 73 for details						\$25.28	

Refer to page 70 and specify mounting as surface (S), through-bolt (T), or back-to-back (BxB). Extra charges apply for BxB - see page 71. Split-finish item: specify finishes as posts x bar. **8/32 screw holes.**

Refrigerator Art™ Appliance Handle

42 Series



Handle or Towel Bar

Not Available In Distressed Finishes

Item	C-C	Proj	Overall	Post Dia	Tier 1 Finishes	Tier 2 Finishes	All Finishes	Wt/ea
42-18	18	2 1/2	20 1/2	1 1/4	N/A	N/A	\$396.24	1.2
42-24	24	2 1/2	26 1/2	1 1/4	N/A	N/A	\$515.10	1.4
42-30	30	2 1/2	32 1/2	1 1/4	N/A	N/A	\$633.99	1.7
42	Custom per inch - see page 73 for details						\$30.34	

Refer to page 70 and specify mounting as surface (S), through-bolt (T), or back-to-back (BxB). Extra charges apply for BxB - see page 71. Split-finish item: specify finishes as posts x bar. **1/4-20 screw holes.**

Refrigerator Art™ Appliance Handle

43 Series



Handle or Towel Bar

Not Available In Distressed Finishes

Item	C-C	Proj	Overall	Post Dia	Tier 1 Finishes	Tier 2 Finishes	All Finishes	Wt/ea
43-18	18	2 1/2	19 1/4	1 1/4	N/A	N/A	\$356.61	1.1
43-24	24	2 1/2	25 1/4	1 1/4	N/A	N/A	\$475.49	1.3
43-30	30	2 1/2	31 1/4	1 1/4	N/A	N/A	\$594.39	1.7
43	Custom per inch - see page 73 for details						\$30.34	

Refer to page 70 and specify mounting as surface (S), through-bolt (T), or back-to-back (BxB). Extra charges apply for BxB - see page 71. Split-finish item: specify finishes as posts x bar. **1/4-20 screw holes.**

Refrigerator Art™ Appliance Handle

44 Series



Towel Bar

Item	C-C	Proj w/ rose	Post Dia	Tier 1 Finishes	Tier 2 Finishes	All Finishes	Wt/ea	
44-18	18	3 1/2	1 1/8	N/A	N/A	\$335.64	2.6	
44-24	24	3 1/2	1 1/8	N/A	N/A	\$447.54	2.9	
44-30	30	3 1/2	1 1/8	N/A	N/A	\$559.39	3.1	
44	Custom per inch - see page 73 for details						\$30.34	

Refer to page 70 and specify mounting as surface (S), through-bolt (T), or back-to-back (BxB). Extra charges apply for BxB - see page 71. Available in split or single finish. For Split-finish, specify finishes as posts x bar. Supplied with rose. **1/4-20 screw holes.**

45 Series



Towel Bar

Item	C-C	Proj w/ rose	Post	Tier 1 Finishes	Tier 2 Finishes	All Finishes	Wt/ea	
45-18	18	3 1/2	3/4 x 1	N/A	N/A	\$335.64	2.2	
45-24	24	3 1/2	3/4 x 1	N/A	N/A	\$447.54	2.5	
45-30	30	3 1/2	3/4 x 1	N/A	N/A	\$559.39	2.8	
45	Custom per inch - see page 73 for details						\$30.34	

Refer to page 70 and specify mounting as surface (S), through-bolt (T), or back-to-back (BxB). Extra charges apply for BxB - see page 71. Available in split or single finish. For Split-finish, specify finishes as posts x bar. Supplied with rose. **1/4-20 screw holes.**

LIST PRICE is per item or as otherwise specified, in US dollars. WEIGHT is per 10 pieces or as otherwise specified, in lbs.

EMAIL ORDERS TO SALES@THEBRONZE.COM

46 Series



Towel Bar

Item	C-C	Proj w/ rose	Post	Tier 1 Finishes	Tier 2 Finishes	All Finishes	Wt/ea
46-18	18	3 1/2	1 x 1 1/4	N/A	N/A	\$348.22	3.4
46-24	24	3 1/2	1 x 1 1/4	N/A	N/A	\$464.32	3.6
46-30	30	3 1/2	1 x 1 1/4	N/A	N/A	\$580.36	3.9
46	Custom per inch - see page 73 for details					\$30.34	

Refer to page 70 and specify mounting as surface (S), through-bolt (T), or back-to-back (BxB). Extra charges apply for BxB - see page 71. Available in split or single finish. For Split-finish, specify finishes as posts x bar. Supplied with rose. 1/4-20 screw holes.

101



Shutter Holder

Item	Dia	Proj	BBRS	BCHR	Tier 3 Finishes	Wt/10
101M	9/16 Hex	1 1/4	\$16.50	\$16.50	NA	1.5
101W	9/16 Hex	1 1/4	\$13.84	\$13.84	NA	1.2

Rust-proof bullet and clip. Specify wood (W) or masonry (M) application. Two finishes: BBRS = Burnished Brass; BCHR = Burnished Chrome.

103



Door Holder

Item	Dia	Proj	Tier 1 Finishes	Tier 2 Finishes	Tier 3 Finishes	Wt/10
103M	9/16 Hex	3 1/4	\$24.51	\$32.33	\$33.10	2.9
103W	9/16 Hex	3 1/4	\$22.83	\$27.91	\$28.53	3.3

Rust-proof bullet and clip. Specify wood (W) or masonry (M) application.

104 and 105



Cabinet Knob

Item	Dia	Proj	Tier 1 Finishes	Tier 2 Finishes	Tier 3 Finishes	Wt/10
104	3/4	1	\$16.64	\$20.36	\$20.83	1.2
105	1	1 1/8	\$20.71	\$25.30	\$25.89	2.5

110 to 112



Cabinet Knob

Item	Dia	Proj	Tier 1 Finishes	Tier 2 Finishes	Tier 3 Finishes	Wt/10
110	1	1 3/16	\$14.81	\$18.12	\$18.52	1.3
111	1 1/4	1 3/16	\$17.88	\$21.85	\$22.35	1.8
112	1 1/2	1 3/16	\$20.66	\$25.26	\$25.85	2.5

114



Cabinet Knob

Item	Dia	Proj	Tier 1 Finishes	Tier 2 Finishes	Tier 3 Finishes	Wt/10
114	3/4	3/4	\$11.02	\$13.21	\$13.54	0.4

See 117 and 118 for additional sizes

115 and 116



Cabinet Knob

Item	Dia	Proj	Tier 1 Finishes	Tier 2 Finishes	Tier 3 Finishes	Wt/10
115	7/8	3/4	\$8.90	\$10.84	\$11.09	0.4
116	1 1/8	1 1/16	\$11.72	\$14.29	\$14.63	1.1



117 and 118



Cabinet Knob

Item	Dia	Proj	Tier 1 Finishes	Tier 2 Finishes	Tier 3 Finishes	Wt/10
117	1	1	\$14.47	\$16.01	\$16.38	1.1
118	1 1/4	1 3/16	\$18.74	\$21.33	\$21.82	1.9

See 114 for 3/4" size version

119



Cabinet Knob

Item	Dia	Proj	Tier 1 Finishes	Tier 2 Finishes	Tier 3 Finishes	Wt/10
119	5/8	5/8	\$7.69	\$9.36	\$9.59	0.2

See 129, 139 and 150 for additional sizes

120 to 122



Cabinet Knob

Item	Dia	Proj	Tier 1 Finishes	Tier 2 Finishes	Tier 3 Finishes	Wt/10
120	1 SQ	1 3/16	\$17.88	\$21.85	\$22.35	1.5
121	1 1/4 SQ	1 3/16	\$20.66	\$25.26	\$25.85	2.2
122	1 1/2 SQ	1 3/16	\$23.56	\$28.83	\$29.50	3.0

124



Cabinet Knob

Item	Dia	Proj	Tier 1 Finishes	Tier 2 Finishes	Tier 3 Finishes	Wt/10
124	1 1/8	1 1/8	\$10.14	\$12.43	\$12.73	1.7

See 190-193 for additional sizes

126 and 127



Cabinet Knob

Item	Dia	Proj	Tier 1 Finishes	Tier 2 Finishes	Tier 3 Finishes	Wt/10
126	1 1/4 SQ	1 3/16	\$30.29	\$36.58	\$37.42	2.1
127	1 1/2 SQ	1 3/16	\$32.05	\$38.73	\$39.64	2.9

129



Cabinet Knob

Item	Dia	Proj	Tier 1 Finishes	Tier 2 Finishes	Tier 3 Finishes	Wt/10
129	7/8	7/8	\$11.17	\$13.65	\$13.95	0.5

See 119, 139 and 150 for additional sizes

130 to 132



Cabinet Knob

Item	Dia	Proj	Tier 1 Finishes	Tier 2 Finishes	Tier 3 Finishes	Wt/10
130	1 HEX	1 3/16	\$17.88	\$21.85	\$22.35	1.3
131	1 1/4 HEX	1 3/16	\$20.66	\$25.26	\$25.85	2.0
132	1 1/2 HEX	1 3/16	\$23.56	\$28.83	\$29.5	2.7

137



Cabinet Knob

Item	Dia	Proj	Tier 1 Finishes	Tier 2 Finishes	Tier 3 Finishes	Wt/10
137	1 1/16	1	\$10.43	\$12.78	\$13.07	0.8

LIST PRICE is per item or as otherwise specified, in US dollars. WEIGHT is per 10 pieces or as otherwise specified, in lbs.

EMAIL ORDERS TO SALES@THEBRONZE.COM

138



Solid Brass Cabinet Knob

Item	Dia	Proj	Tier 1 Finishes	Tier 2 Finishes	Tier 3 Finishes	Wt/10
138	1 1/16	1	\$10.43	\$12.78	\$13.07	0.8

139



Solid Brass Cabinet Knob

Item	Dia	Proj	Tier 1 Finishes	Tier 2 Finishes	Tier 3 Finishes	Wt/10
139	1 1/8	1	\$13.81	\$16.90	\$17.28	1.2

See 119, 129 and 150 for additional sizes

140



Solid Brass Cabinet Knob

Item	Dia	Proj	Tier 1 Finishes	Tier 2 Finishes	Tier 3 Finishes	Wt/10
140	1 3/8	1 5/16	\$17.57	\$21.51	\$21.99	2.0

141 to 143



Solid Brass Cabinet Knob

Item	Dia	Proj	Tier 1 Finishes	Tier 2 Finishes	Tier 3 Finishes	Wt/10
141	1/2	1	\$13.04	\$15.94	\$16.29	0.5
142	3/4	1 1/8	\$15.99	\$19.56	\$20.00	1.3
143	1	1 1/4	\$20.00	\$24.48	\$25.05	2.5

150



Solid Brass Cabinet Knob

Item	Dia	Proj	Tier 1 Finishes	Tier 2 Finishes	Tier 3 Finishes	Wt/10
150	1 1/2	1 1/2	\$24.99	\$30.51	\$31.22	2.5

See 119, 129 and 139 for additional sizes

151 to 153



Solid Brass Cabinet Knob

Item	Dia	Proj	Tier 1 Finishes	Tier 2 Finishes	Tier 3 Finishes	Wt/10
151	1 1/16	15/16	\$10.29	\$12.55	\$12.83	0.7
152	1 1/4	1	\$13.67	\$16.69	\$17.08	1.3
153	1 3/8	1 1/16	\$16.89	\$20.65	\$21.13	1.5

160 to 162



Solid Brass Backplate

Item	Dia	Proj	Tier 1 Finishes	Tier 2 Finishes	Tier 3 Finishes	Wt/10
160	1 1/2	1/8	\$13.66	\$16.62	\$17.02	0.2
161	2 1/8	1/8	\$14.42	\$17.66	\$18.05	0.3
162	2 1/2	1/8	\$16.54	\$20.28	\$20.77	0.5

For use with 8-32 screws - custom hole sizes available

165 and 167



Solid Brass Cabinet Handle

Item	C-C	Face	Proj	Overall	Tier 1 Finishes	Tier 2 Finishes	Tier 3 Finishes	Wt/10
165	3 1/2	7/16	7/8	4	\$15.85	\$19.39	\$19.84	1.3
167	3	7/16	7/8	3 1/2	\$14.53	\$17.81	\$18.24	1.2

LIST PRICE is per item or as otherwise specified, in US dollars. WEIGHT is per 10 pieces or as otherwise specified, in lbs.

EMAIL ORDERS TO SALES@THEBRONZE.COM



170 to 172



Solid Brass Cabinet Knob

Item	Dia	Proj	Tier 1 Finishes	Tier 2 Finishes	Tier 3 Finishes	Wt/10
170	3/4	3/4	\$8.31	\$10.16	\$10.40	0.5
171	1 1/8	1	\$15.08	\$18.47	\$18.89	1.3
172	1 1/2	1 3/8	\$22.83	\$27.92	\$28.56	2.2

173 and 174



Solid Brass Cabinet Knob

Item	Dia	Proj	Tier 1 Finishes	Tier 2 Finishes	Tier 3 Finishes	Wt/10
173	1 1/8	1 1/8	\$22.99	\$28.11	\$28.75	1.6
174	1 1/4	1 1/4	\$23.36	\$30.86	\$31.58	2.0

175



Solid Brass Cabinet Knob

Not Available In Distressed Finishes

Item	Dia	Proj	Tier 1 Finishes	Tier 2 Finishes	All Finishes	Wt/10
175	1 1/4	1 1/4	N/A	N/A	\$32.26	2.0

Split finish item: specify finishes as knob x insert

180 and 181



Solid Brass Cabinet Knob

Item	Dia	Proj	Tier 1 Finishes	Tier 2 Finishes	Tier 3 Finishes	Wt/10
180	1	1 3/32	\$12.60	\$15.40	\$15.75	2.0
181	1 1/4	1 1/4	\$16.08	\$20.89	\$21.37	3.1

182 and 183



Solid Brass Cabinet Knob

Item	Dia	Proj	Tier 1 Finishes	Tier 2 Finishes	Tier 3 Finishes	Wt/10
182	1	1	\$13.45	\$16.41	\$16.79	1.8
183	1 1/4	1 1/4	\$19.27	\$23.56	\$24.10	3.0

184 and 185



Solid Brass Cabinet Knob

Item	Dia	Proj	Tier 1 Finishes	Tier 2 Finishes	Tier 3 Finishes	Wt/10
184	1	1	\$14.14	\$17.28	\$17.68	1.7
185	1 1/4	1 1/4	\$20.23	\$24.73	\$25.30	3.1

186 and 187



Solid Brass Cabinet Knob

Item	Dia	Proj	Tier 1 Finishes	Tier 2 Finishes	Tier 3 Finishes	Wt/10
186	1	1	\$16.40	\$20.08	\$20.53	2.5
187	1 1/4	1 1/4	\$22.48	\$27.45	\$28.08	4.7

LIST PRICE is per item or as otherwise specified, in US dollars. WEIGHT is per 10 pieces or as otherwise specified, in lbs.

EMAIL ORDERS TO SALES@THEBRONZE.COM

188 and 189



Solid Brass Cabinet Knob

Item	Dia	Proj	Screw	Tier 1 Finishes	Tier 2 Finishes	Tier 3 Finishes	Wt/10
188	1 1/4	1 1/4	1/4 - 20	\$22.48	\$27.45	\$28.08	4.6
189	1 1/4	1 1/4	8/32	\$22.48	\$27.45	\$28.08	4.6

190 to 193



Solid Brass Cabinet Knob

Item	Dia	Proj	Tier 1 Finishes	Tier 2 Finishes	Tier 3 Finishes	Wt/10
190	3/4	3/4	\$9.31	\$11.32	\$11.58	0.6
191	1	1	\$13.42	\$16.38	\$16.76	1.2
192	1 1/4	1 1/8	\$16.10	\$19.72	\$20.18	2.3
193	1 1/2	1 1/4	\$23.52	\$28.78	\$29.44	3.8

See 124 for an additional size

195



Solid Brass Cabinet Knob

Item	Dia	Proj	Tier 1 Finishes	Tier 2 Finishes	Tier 3 Finishes	Wt/10
195	9/16	1 1/4	\$11.59	\$14.25	\$14.55	0.6

196 and 197



Solid Brass Cabinet Knob

Item	Dia	Proj	Tier 1 Finishes	Tier 2 Finishes	Tier 3 Finishes	Wt/10
196	1	1 1/4	\$15.29	\$18.74	\$19.16	2.0
197	1 1/4	1 9/16	\$22.11	\$27.07	\$27.70	3.2

198 and 199



Solid Brass Oval Cabinet Knob

Item	Dia	Proj	Tier 1 Finishes	Tier 2 Finishes	Tier 3 Finishes	Wt/10
198	1 x 1 1/4	1 7/16	\$24.94	\$30.47	\$31.17	2.6
199	1 1/4 x 1 1/2	1 5/8	\$33.26	\$40.67	\$41.62	4

202 and 203



Solid Brass Backplate

Item	Dia	Thickness	Tier 1 Finishes	Tier 2 Finishes	Tier 3 Finishes	Wt/10
202	1 3/4	3/16	\$14.81	\$18.11	\$18.51	1.2
203	1 1/2	3/16	\$11.34	\$13.84	\$14.16	0.8

Use with 8/32 screws. For 1/4-20 screws, order item numbers 9202 and 9203.



B203



Solid Brass Backplate

Item	Dia	Thickness	Tier 1 Finishes	Tier 2 Finishes	Tier 3 Finishes	Wt/10
B203	1 1/2	3/16	\$14.53	\$15.65	\$16.02	0.8

Use with 8/32 screws. For use with 1/4-20 screws, use item number B9203.

204



Solid Brass Backplate

Item	Dia	Thickness	Tier 1 Finishes	Tier 2 Finishes	Tier 3 Finishes	Wt/10
204	1	1/8	\$7.17	\$8.72	\$8.92	0.1

Only for cabinet hardware with 8/32 screws holes.

205 Series



Solid Brass Handle or Towel Bar

Refrigerator Art™ Appliance Handle

Item	C-C	Proj	Dia	Tier 1 Finishes	Tier 2 Finishes	Tier 3 Finishes	Wt/ea
205-4	4	1 3/4	1/2	\$40.94	\$49.67	\$50.81	0.4
205-6	6	1 3/4	1/2	\$61.41	\$74.49	\$76.21	0.5
205-8	8	1 3/4	1/2	\$81.88	\$99.31	\$101.62	0.6
205	Custom per inch - see page 73 for details			\$13.05	\$15.85	\$16.24	

Refer to page 70 and specify mounting as surface (S), through-bolt (T), or back-to-back (BxB). Extra charges apply for BxB - see page 71. 8/32 screw holes. Minimum center to center is 6 inches.

206 Series



Solid Brass Large Handle

Refrigerator Art™ Appliance Handle

Item	C-C	Proj	Dia	Tier 1 Finishes	Tier 2 Finishes	Tier 3 Finishes	Wt/ea
206-6	6	1 3/4	1/2	\$46.72	\$54.68	\$55.94	0.6
206-8	8	1 3/4	1/2	\$62.28	\$72.91	\$74.58	0.7
206-10	10	1 3/4	1/2	\$77.89	\$91.09	\$93.21	0.8
206-12	12	1 3/4	1/2	\$93.45	\$109.33	\$111.85	0.9
206	Custom per inch - see page 73 for details			\$9.90	\$11.62	\$11.89	

Refer to page 70 and specify mounting as surface (S), through-bolt (T), or back-to-back (BxB). Extra charges apply for BxB - see page 71. 8/32 screw holes.

217



Solid Brass Handle or Towel Bar

Refrigerator Art™ Appliance Handle

Item	C-C	Proj	Cross-Sec.	Overall	Tier 1 Finishes	Tier 2 Finishes	Tier 3 Finishes	Wt/ea
217-8	8	2 3/8	1 square	12	\$349.12	\$426.87	\$436.80	4.2
217	Custom per inch - see page 73 for details				\$26.36	\$31.39	\$32.30	

Refer to page 70 and specify mounting as surface (S), through-bolt (T), or back-to-back (BxB). Extra charges apply for BxB - see page 71. Custom Lengths NOT available. Item priced by overall length. 1/4-20 screw holes.

220



Solid Brass Rose

Item	Dia	Thickness	Tier 1 Finishes	Tier 2 Finishes	Tier 3 Finishes	Wt/10
220	1 1/2	1/4	\$15.52	\$18.74	\$19.16	0.3

Only for Large Handles with 1/4-20 screw holes.

LIST PRICE is per item or as otherwise specified, in US dollars. WEIGHT is per 10 pieces or as otherwise specified, in lbs.

EMAIL ORDERS TO SALES@THEBRONZE.COM

222 Series



Solid Brass Large Handle , Appliance or Towel Bar



Refrigerator Art™ Appliance Handle

Companion style with low profile (1 1/8 in. clearance, 1 7/8 in. proj.) order the 822 Series - See page 32.

Item	C-C	Proj	Dia	Tier 1 Finishes	Tier 2 Finishes	Tier 3 Finishes	Wt/ea
222-6	6	2 1/2	3/4	\$56.06	\$71.75	\$73.43	1.3
222-8	8	2 1/2	3/4	\$74.77	\$95.68	\$97.90	1.5
222-10	10	2 1/2	3/4	\$93.45	\$119.59	\$122.35	1.6
222-12	12	2 1/2	3/4	\$112.15	\$143.51	\$146.85	1.8
222-18	18	2 1/2	3/4	\$168.21	\$215.25	\$220.25	2.8
222-24	24	2 1/2	3/4	\$236.28	\$287.00	\$293.69	3.6
222-30	30	2 1/2	3/4	\$280.35	\$358.75	\$367.10	4.5
222-	Custom per inch - see page 73 for details			\$11.88	\$15.27	\$15.62	

Refer to page 70 and specify mounting as surface (S), through-bolt (T), or back-to-back (BxB). Extra charges apply for BxB - see page 71. **1/4-20 screw holes.**

232 Series



Solid Brass Large Handle or Towel Bar



Refrigerator Art™ Appliance Handle

Companion style with low profile (1 1/8 in. clearance, 1 7/8 in. proj.) order the 832 Series - See page 32.

Item	C-C	Proj	Dia	Tier 1 Finishes	Tier 2 Finishes	Tier 3 Finishes	Wt/ea
232-6	6	2 1/2	3/4	\$80.11	\$95.68	\$97.90	1.3
232-8	8	2 1/2	3/4	\$106.79	\$127.58	\$130.55	1.5
232-10	10	2 1/2	3/4	\$133.47	\$159.46	\$163.15	1.7
232-12	12	2 1/2	3/4	\$160.22	\$191.35	\$195.79	2.2
232-18	18	2 1/2	3/4	\$240.28	\$287.00	\$293.69	2.8
232-24	24	2 1/2	3/4	\$320.38	\$382.67	\$391.57	3.6
232-30	30	2 1/2	3/4	\$400.49	\$478.36	\$489.48	4.5
232	Custom per inch - see page 73 for details			\$17.03	\$20.33	\$20.80	

Refer to page 70 and specify mounting as surface (S), through-bolt (T), or back-to-back (BxB). Extra charges apply for BxB - see page 71. **1/4-20 screw holes.**

236 Series



Solid Brass Large Handle or Towel Bar



Cross Section

Item	C-C	Proj	Cross Sec.	Tier 1 Finishes	Tier 2 Finishes	Tier 3 Finishes	Wt/ea
236-6	6	2	1 Half Round	\$80.03	\$95.68	\$97.90	1.1
236-8	8	2	1 Half Round	\$106.79	\$127.58	\$130.55	1.5
236-18	18	2	1 Half Round	\$240.28	\$287.00	\$293.69	3.3
236-24	24	2	1 Half Round	\$320.38	\$382.67	\$391.57	4.4
236-30	30	2	1 Half Round	\$400.49	\$478.36	\$489.48	5.5
236	Custom per inch - see page 73 for details			\$17.03	\$20.33	\$20.80	

Refer to page 70 and specify mounting as surface (S), through-bolt (T), or back-to-back (BxB). Extra charges apply for BxB - see page 71. **1/4-20 screw holes.**

240 Series



Solid Brass Door Handle

Refrigerator Art™ Appliance Handle

Item*	C-C	Proj	Cross Sec.	Overall	Tier 1 Finishes	Tier 2 Finishes	Tier 3 Finishes	Wt/ea
240-6	6	2	1 max	9	\$257.05	\$314.25	\$321.54	3.0
240-8	8	2 3/8	1 1/4 max	15	\$328.76	\$401.93	\$411.28	4.5
240-14	14	2 3/8	1 1/4 max	23	\$699.01	\$855.32	\$875.20	5.1

Refer to page 70 and specify mounting as surface (S), through-bolt (T), or back-to-back (BxB). Extra charges apply for BxB - see page 71. 240-6 uses **8/32 screws**; others use **1/4-20 screws**.

241 Series



Solid Brass Door Handle

Refrigerator Art™ Appliance Handle

Item	C-C	Proj	Cross Sec.	Overall	Tier 1 Finishes	Tier 2 Finishes	Tier 3 Finishes	Wt/ea
241-6	6	2 1/8	1 max	9	\$257.05	\$314.25	\$321.54	3.0
241-8	8	2 3/8	1 1/4 max	15	\$328.76	\$401.93	\$411.28	4.5
241-14	14	2 3/8	1 1/4 max	23	\$699.01	\$855.32	\$875.20	5.1

Refer to page 70 and specify mounting as surface (S), through-bolt (T), or back-to-back (BxB). Extra charges apply for BxB - see page 71. 241-6 uses **8/32 screws**; others use **1/4-20 screws**.

LIST PRICE is per item or as otherwise specified, in US dollars. WEIGHT is per 10 pieces or as otherwise specified, in lbs.

EMAIL ORDERS TO SALES@THEBRONZE.COM



242 Series

To order with BULLNOSE ends, specify "B" before the overall length.



Solid Brass Door Handle

Refrigerator Art™ Appliance Handle

Item	C-C	Proj	Dia.	Overall	Tier 1 Finishes	Tier 2 Finishes	Tier 3 Finishes	Wt/ea
242-8	8	2 1/4	1	12	\$173.53	\$204.99	\$209.77	3.3
242-10	10	2 1/4	1	14	\$202.46	\$239.18	\$244.76	3.6
242-12	12	2 1/4	1	16	\$231.44	\$266.16	\$279.47	
242-18	18	2 1/4	1	22	\$318.23	\$365.97	\$384.26	
242-24	24	2 1/4	1	28	\$405.02	\$477.92	\$489.06	
242	Custom per inch - see page 73 for details				\$18.44	\$21.79	\$22.32	

Refer to page 70 and specify mounting as surface (S), through-bolt (T), or back-to-back (BxB). Extra charges apply for BxB - see page 71. Add \$19.97 per pull for bullnose. Priced by overall length. 1/4-20 screws.

243 Series

To order with BULLNOSE ends, specify "B" before the overall length.



Solid Brass Door Handle

Refrigerator Art™ Appliance Handle

Item	C-C	Proj	Dia.	Overall	Tier 1 Finishes	Tier 2 Finishes	Tier 3 Finishes	Wt/ea
243-10	10	2 1/2	1 1/4	14	\$394.24	\$473.09	\$492.80	4.8
243-12	12	2 1/2	1 1/4	16	\$450.56	\$518.14	\$544.05	5.5
243-18	18	2 1/2	1 1/4	22	\$619.52	\$712.45	\$748.07	
243-24	24	2 1/2	1 1/4	28	\$788.48	\$906.75	\$952.09	
243	Custom per inch - see page 73 for details				\$35.20	\$42.24	\$44.00	

Refer to page 70 and specify mounting as surface (S), through-bolt (T), or back-to-back (BxB). Extra charges apply for BxB - see page 71. Add \$19.97 per pull for bullnose. Priced by overall length. 1/4-20 screws.

246 Series

To order with BULLNOSE ends, specify "B" before the overall length.



Solid Brass Large Handle or Towel Bar

Refrigerator Art™ Appliance Handle

Item	C-C	Proj	Dia.	Overall	Tier 1 Finishes	Tier 2 Finishes	Tier 3 Finishes	Wt/ea
246-6	6	1 7/8	3/4	10	\$94.53	\$119.59	\$122.35	1.7
246-8	8	1 7/8	3/4	12	\$113.45	\$143.51	\$146.85	1.8
246-18	18	1 7/8	3/4	22	\$208.04	\$263.09	\$269.21	5.0
246-24	24	1 7/8	3/4	28	\$264.77	\$334.84	\$342.64	6.8
246	Custom per inch - see page 73 for details				\$12.07	\$15.30	\$15.66	

Refer to page 70 and specify mounting as surface (S), through-bolt (T), or back-to-back (BxB). Extra charges apply for BxB - see page 71. Add \$19.97 per pull for bullnose. This item priced by overall length. 1/4-20 screws.

247 Series

To order with BULLNOSE ends, specify "B" before the overall length.



Solid Brass Large Handle or Towel Bar

Refrigerator Art™ Appliance Handle

Companion style with low profile (1 1/8 in. clearance, 1 3/4 in. proj.) order the 847 Series - See page 33.

Item	C-C	Proj	Dia.	Overall	Tier 1 Finishes	Tier 2 Finishes	Tier 3 Finishes	Wt/ea
247-6	6	1 7/8	5/8	10	\$91.20	\$110.25	\$112.82	1.0
247-8	8	1 7/8	5/8	12	\$109.46	\$132.29	\$135.38	1.2
247-18	18	1 7/8	5/8	22	\$200.68	\$242.53	\$248.19	1.4
247-24	24	1 7/8	5/8	28	\$237.18	\$286.62	\$293.30	1.7
247	Custom per inch - see page 73 for details				\$11.66	\$14.07	\$14.39	

Refer to page 70 and specify mounting as surface (S), through-bolt (T), or back-to-back (BxB). Extra charges apply for BxB - see page 71. Add \$19.97 per pull for bullnose. This item priced by overall length. 8/32 screws.

250 Series



Refrigerator Art™ Appliance Handle

Companion style with low profile (1 1/8 in. clearance, 1 7/8 in. proj.) order the 850 Series - See page 33.

Item	C-C	Proj	Dia.	Tier 1 Finishes	Tier 2 Finishes	Tier 3 Finishes	Wt/ea
250-6	6	2 1/2	3/4	\$122.40	\$147.84	\$151.28	1.3
250-8	8	2 1/2	3/4	\$142.16	\$171.74	\$175.74	1.5
250-10	10	2 1/2	3/4	\$157.42	\$190.19	\$194.61	1.7
250-18	18	2 1/2	3/4	\$339.85	\$403.60	\$412.98	2.3

Refer to page 70 and specify mounting as surface (S), through-bolt (T), or back-to-back (BxB). Extra charges apply for BxB - see page 71. This item priced by overall length. 1/4-20 screws.

LIST PRICE is per item or as otherwise specified, in US dollars. WEIGHT is per 10 pieces or as otherwise specified, in lbs.

EMAIL ORDERS TO SALES@THEBRONZE.COM

254 Series



Solid Brass Large Handle or Towel Bar

Refrigerator Art™ Appliance Handle

Item	C-C	Proj	Cross Sec.	Overall	Tier 1 Finishes	Tier 2 Finishes	Tier 3 Finishes	Wt/ea
254-8	8	1 3/4	3/4 x 1/2	12	\$213.08	\$257.49	\$263.48	1.3
254-10	10	1 3/4	3/4 x 1/2	14	\$248.57	\$300.40	\$307.37	1.5
254-12	12	1 3/4	3/4 x 1/2	16	\$284.08	\$343.31	\$351.29	1.7
254	Custom per inch - see page 73 for details				\$22.64	\$27.39	\$28.03	

Refer to page 70 and specify mounting as surface (S), through-bolt (T), or back-to-back (BxB). Extra charges apply for BxB - see page 71. This item priced by overall length. 1/4-20 screw holes.

256 Series



Solid Brass Large Handle or Towel Bar - rounded ends

Refrigerator Art™ Appliance Handle

Item	C-C	Proj	Cross Sec.	Overall	Tier 1 Finishes	Tier 2 Finishes	Tier 3 Finishes	Wt/ea
256-8	8	1 3/4	1 HR	12	\$166.87	\$198.19	\$202.80	1.3
256-10	10	1 3/4	1 HR	14	\$194.69	\$231.21	\$236.60	1.5
256-12	12	1 3/4	1 HR	16	\$222.50	\$264.24	\$270.40	1.7
256	Custom per inch - see page 73 for details				\$17.74	\$21.07	\$21.56	

Refer to page 70 and specify mounting as surface (S), through-bolt (T), or back-to-back (BxB). Extra charges apply for BxB - see page 71. This item priced by overall length. 1/4-20 screw holes.

257 Series



Solid Brass Large Handle or Towel Bar - squared off ends

Refrigerator Art™ Appliance Handle

Item	C-C	Proj	Cross Sec.	Overall	Tier 1 Finishes	Tier 2 Finishes	Tier 3 Finishes	Wt/ea
257-8	8	1 3/4	1 HR	12	\$166.87	\$198.19	\$202.80	1.3
257-10	10	1 3/4	1 HR	14	\$194.69	\$231.21	\$236.60	1.5
257-12	12	1 3/4	1 HR	16	\$222.50	\$264.24	\$270.40	1.7
257	Custom per inch - see page 73 for details				\$16.26	\$19.32	\$19.76	

Refer to page 70 and specify mounting as surface (S), through-bolt (T), or back-to-back (BxB). Extra charges apply for BxB - see page 71. This item priced by overall length. 1/4-20 screw holes.

258 Series



Solid Brass Handle



Refrigerator Art™ Appliance Handle
for companion style with low profile (1 1/8 in. clearance, 1 7/8 in. proj.) order the 858 Series - See page 34.

Item	C-C	Proj	Dia	Tier 1 Finishes	Tier 2 Finishes	Tier 3 Finishes	Wt/ea	
258-6	6	2 1/2	3/4	\$74.77	\$101.78	\$104.14	1.3	
258-8	8	2 1/2	3/4	\$99.67	\$135.12	\$138.27	1.5	
258	Custom per inch - see page 73 for details				\$15.90	\$21.65	\$22.15	

Refer to page 70 and specify mounting as surface (S), through-bolt (T), or back-to-back (BxB). Extra charges apply for BxB - see page 71. 1/4-20 screw holes.

259 Series



Solid Brass Large Handle or Towel Bar - rounded ends

Refrigerator Art™ Appliance Handle

Item	C-C	Proj	Cross Sec.	Overall	Tier 1 Finishes	Tier 2 Finishes	Tier 3 Finishes	Wt/ea
259-8	8	1 3/4	1 HR	12	\$166.87	\$198.19	\$202.80	1.3
259-10	10	1 3/4	1 HR	14	\$194.69	\$231.21	\$236.60	1.5
259-12	12	1 3/4	1 HR	16	\$222.50	\$264.24	\$270.40	1.7
259	Custom per inch - see page 73 for details				\$17.74	\$21.07	\$21.56	

Refer to page 70 and specify mounting as surface (S), through-bolt (T), or back-to-back (BxB). Extra charges apply for BxB - see page 71. This item priced by overall length. 1/4-20 screw holes.

260 to 262



Solid Brass Handle and Appliance Handle

Refrigerator Art™ Appliance Handle

Item	C-C	Dia	Proj	Overall	Tier 1 Finishes	Tier 2 Finishes	Tier 3 Finishes	Wt/ea
260-3	3	1/2	1 3/16	5	\$78.67	\$95.92	\$99.62	5.0 oz
260-4H	4 1/2	1/2	1 3/16	6 1/2	\$83.81	\$102.14	\$104.51	5.2 oz
261	9 1/2	3/4	1 7/16	12 1/2	\$191.61	\$233.54	\$238.96	1.2 lb
262	9 1/2	1	2	12 1/2	\$292.28	\$356.22	\$364.52	2.3 lb

Items 260 and 261: Through-bolt (T) mount only. 8-32 screw holes
Item 262: Through-bolt (T), surface (S) or back-to-back (BxB) mount. 1/4-20 screw holes.

LIST PRICE is per item or as otherwise specified, in US dollars. WEIGHT is per 10 pieces or as otherwise specified, in lbs.

EMAIL ORDERS TO SALES@THEBRONZE.COM



263



Solid Brass Knob

Item	C-C	Dia	Proj	Overall	Tier 1 Finishes	Tier 2 Finishes	Tier 3 Finishes	Wt/10
263	NA	1/2	1 3/16	1 3/4	\$30.76	\$36.52	\$37.29	1.6

266



Solid Brass Appliance Handle

Refrigerator Art™ Appliance Handle

Item	C-C	Dia	Overall	Tier 1 Finishes	Tier 2 Finishes	Tier 3 Finishes	Wt/ea
266	12	3/4	12 3/4	\$277.65	\$329.73	\$337.41	1.6

Available in through-bolt (T) mounting only. 1/4-20 screw holes.

270



Solid Brass Cabinet Handle

Item	C-C	Dia	Overall	Tier 1 Finishes	Tier 2 Finishes	Tier 3 Finishes	Wt/ea
270-3	3	3/4 x 3/8	4	\$38.07	\$45.97	\$47.06	0.4
270-6	6	3/4 x 3/8	8	\$83.71	\$101.13	\$103.49	0.9
270-10	10	3/4 x 3/8	14	\$146.52	\$176.99	\$181.15	1.3
270	Custom per inch - see page 73 for details			\$13.33	\$16.13	\$16.50	

Available in through-bolt (T) mounting only. 8/32 screw holes.

271



Solid Brass Cabinet Handle

Item	C-C	Dia	Overall	Tier 1 Finishes	Tier 2 Finishes	Tier 3 Finishes	Wt/ea
271-4	4	3/4 x 1/2	6	\$100.99	\$122.00	\$124.86	0.8
271-6	6	3/4 x 1/2	8	\$107.69	\$130.09	\$133.12	1.1
271-8	8	3/4 x 1/2	10	\$167.24	\$203.35	\$208.11	1.4
271-10	10	3/4 x 1/2	14	\$235.58	\$284.59	\$291.21	1.9
271	Custom per inch - see page 73 for details			\$21.46	\$25.93	\$26.53	

Refer to page 70 and specify mounting as surface (S), through-bolt (T), or back-to-back (BxB). Extra charges apply for BxB - see page 71. This item priced by overall length. 8/32 screw holes.

272



Solid Brass Cabinet Handle

Item	C-C	Dia	Overall	Tier 1 Finishes	Tier 2 Finishes	Tier 3 Finishes	Wt/ea
272-3	3	3/4 x 3/8	4	\$38.07	\$45.97	\$47.06	0.4
272-6	6	3/4 x 3/8	8	\$83.71	\$101.13	\$103.49	0.9
272-10	10	3/4 x 3/8	14	\$146.52	\$176.99	\$181.15	1.3
272	Custom per inch - see page 73 for details			\$13.33	\$16.13	\$16.50	

Available in through-bolt (T) mounting only. 8/32 screw holes.

273



Solid Brass Cabinet Handle

Item	C-C	Dia	Overall	Tier 1 Finishes	Tier 2 Finishes	Tier 3 Finishes	Wt/ea
273-4	4	3/4 x 1/2	6	\$100.99	\$122.00	\$124.86	0.8
273-6	6	3/4 x 1/2	8	\$107.69	\$130.09	\$133.12	1.1
273-8	8	3/4 x 1/2	10	\$167.24	\$203.35	\$208.11	1.4
273-10	10	3/4 x 1/2	14	\$235.58	\$284.59	\$291.21	1.9
273	Custom per inch - see page 73 for details			\$21.46	\$25.93	\$26.53	

Available in through-bolt (T) mounting only. 8/32 screw holes.

275



Solid Brass Refrigerator Handle

Item	C-C	Dia	Overall	Tier 1 Finishes	Tier 2 Finishes	Tier 3 Finishes	Wt/ea
275-8	8	1 1/4 x 1/2	10	\$328.76	\$401.34	\$411.28	1.9
275-12	12	1 1/4 x 1/2	16	\$361.65	\$442.12	\$452.41	2.2
275	Custom per inch - see page 73 for details			\$41.91	\$50.63	\$52.39	

Refer to page 70 and specify mounting as surface (S), through-bolt (T), or back-to-back (BxB). Extra charges apply for BxB - see page 71. This item priced by overall length. 1/4-20 screw holes.

LIST PRICE is per item or as otherwise specified, in US dollars. WEIGHT is per 10 pieces or as otherwise specified, in lbs.

EMAIL ORDERS TO SALES@THEBRONZE.COM

276



Solid Brass Refrigerator Pull

Item	C-C	Dia	Overall	Tier 1 Finishes	Tier 2 Finishes	Tier 3 Finishes	Wt/ea
276-8	8	1 1/4 x 1/2	10	\$328.76	\$401.34	\$411.28	1.9
276-12	12	1 1/4 x 1/2	16	\$361.65	\$442.12	\$452.41	2.2
276 -	Custom per inch - see page 73 for details			\$41.91	\$50.63	\$52.39	

Refer to page 70 and specify mounting as surface (S), through-bolt (T), or back-to-back (BxB). Extra charges apply for BxB - see page 71. This item priced by overall length. **8-32 screw holes.**

280 to 283



Solid Brass Handle and Appliance Handle

Refrigerator Art™ Appliance Handle



Solid Brass Knob

Item	C-C	Dia	Proj	Overall	Tier 1 Finishes	Tier 2 Finishes	Tier 3 Finishes	Wt/ea
280-3	3	1/2	1 3/16	5	\$78.67	\$95.92	\$99.62	5.0 oz
280-4H	4 1/2	1/2	1 3/16	6 1/2	\$83.81	\$102.14	\$104.51	5.2 oz

Item 280: Through-bolt (T) mount only. **8/32 screw holes.**

281	9 1/2	3/4	1 7/16	12 1/2	\$191.61	\$233.54	\$238.96	1.2 lb
282	9 1/2	1	2	12 1/2	\$292.28	\$356.22	\$364.52	2.3 lb

Item 281: Through-bolt (T) mount only. Item 282: Through-bolt (T), surface (S) or back-to-back (BxB) mount. **8-32 screw holes.**

Item	C-C	Dia	Proj	Overall	Tier 1 Finishes	Tier 2 Finishes	Tier 3 Finishes	Wt/10
283	NA	1/2	1 3/16	1 3/4	\$30.76	\$36.52	\$37.29	1.6

290



Solid Brass Cabinet Knob

Item	Dia	Proj	Tier 1 Finishes	Tier 2 Finishes	Tier 3 Finishes	Wt/10
290	5/8	1 1/8	\$27.79	\$33.54	\$34.32	1.6

291



Solid Brass Cabinet Knob

Item	Dia	Proj	Tier 1 Finishes	Tier 2 Finishes	Tier 3 Finishes	Wt/10
291	5/8	1 1/4	\$27.79	\$33.54	\$34.32	1.7

292



Solid Brass Cabinet Handle

Item	C-C	Dia	Overall	Tier 1 Finishes	Tier 2 Finishes	Tier 3 Finishes	Wt/ea
292	4	3/4	6	\$37.87	\$45.74	\$46.81	0.6

Through-bolt mount only. Custom length are available.

293



Solid Brass Cabinet Handle

Item	C-C	Dia	Overall	Tier 1 Finishes	Tier 2 Finishes	Tier 3 Finishes	Wt/ea
293	4	3/4	6	\$37.87	\$45.74	\$46.81	0.8

Through-bolt mount only. Custom length are available.

294 Series



Solid Brass Door Handle

Refrigerator Art™ Appliance Handle

Item	C-C	Proj	Cross Sec.	Overall	Tier 1 Finishes	Tier 2 Finishes	Tier 3 Finishes	Wt/ea
294-6	6	2	1 max	9	\$257.05	\$314.25	\$321.54	3.0
294-8	8	2 3/8	1 1/4 max	15	\$328.76	\$401.93	\$411.28	4.5
294-14	14	2 3/8	1 1/4 max	23	\$699.01	\$855.32	\$875.20	5.1

Refer to page 70 and specify mounting as surface (S), through-bolt (T), or back-to-back (BxB). Extra charges apply for BxB - see page 71. **8/32 screws.** Custom lengths are available



295 Series



Solid Brass Door Handle

Refrigerator Art™ Appliance Handle

Item	C-C	Proj	Cross Sec.	Overall	Tier 1 Finishes	Tier 2 Finishes	Tier 3 Finishes	Wt/ea
295-6	6	2 1/8	1 max	9	\$257.05	\$314.25	\$321.54	3.0
295-8	8	2 3/8	1 1/4 max	15	\$328.76	\$401.93	\$411.28	4.5
295-14	14	2 3/8	1 1/4 max	23	\$699.01	\$855.32	\$875.20	5.1

Refer to page 70 and specify mounting as surface (S), through-bolt (T), or back-to-back (BxB). Extra charges apply for BxB - see page 71. **8/32 screws.** Custom lengths are available.

300 Series

To order with **BULLNOSE** ends, specify "B" before the overall length.



Solid Brass Cabinet Handle

Item	C-C	Dia	Overall	Tier 1 Finishes	Tier 2 Finishes	Tier 3 Finishes	Wt/10
300-1H	1 1/2	1/2	2 1/2	\$16.69	\$19.71	\$20.17	1.3
300-2H	2 1/2	1/2	3 1/2	\$22.74	\$27.60	\$28.24	2.2
300-3	3	1/2	4	\$25.98	\$31.50	\$32.25	2.5
300-3H	3 1/2	1/2	4 1/2	\$29.24	\$35.49	\$36.30	2.8
300-6	6	1/2	8	\$52.42	\$63.04	\$64.50	3.0
300-8	8	1/2	10	\$64.98	\$78.80	\$80.65	3.2
300	Custom per inch - see page 73 for details			\$8.29	\$10.05	\$10.30	

Add \$11.98 for bullnose. Through-bolt mount only. This item is priced by overall length. **8/32 screw holes.**

304 and 305



Solid Brass Cabinet Handle

Item	C-C	Dia	Overall	Tier 1 Finishes	Tier 2 Finishes	Tier 3 Finishes	Wt/10
304	3	1/2	4	\$24.48	\$29.96	\$30.66	2.2
305	3 1/2	1/2	4 1/2	\$31.81	\$38.91	\$39.82	2.6
304	Custom per inch - see page 73 for details			\$11.86	\$14.33	\$14.65	

306 and 307



Solid Brass Cabinet Handle



Cross Section of the 306-7 pull

Item	C-C	Dia	Overall	Tier 1 Finishes	Tier 2 Finishes	Tier 3 Finishes	Wt/10
306	3	7/16 SQ	4 1/2	\$31.28	\$38.23	\$39.12	2.6
307	3 1/2	7/16 SQ	6	\$43.18	\$52.75	\$53.96	4.5
306	Custom per inch - see page 73 for details			\$10.05	\$11.18	\$11.43	

Through-bolt (T) mount only. This item is priced by overall length. **8/32 screw holes.**

308 and 309



Solid Brass Cabinet Knob

Item	Dia	Proj	Overall	Tier 1 Finishes	Tier 2 Finishes	Tier 3 Finishes and splits	Wt/10
308	3/8	1 1/4	1 1/4	\$11.94	\$14.54	\$14.89	0.6
309	3/8	1 1/4	2 1/4	\$13.17	\$16.11	\$16.50	1.0

Available in single or split finish.

310 and 311



Solid Brass Cabinet Handle

Item	C-C	Dia	Overall	Tier 1 Finishes	Tier 2 Finishes	Tier 3 Finishes and split combo	Wt/10
310	ADJ	3/8	4 3/4	\$26.33	\$32.20	\$32.95	2.2
311	ADJ	3/8	6 1/2	\$28.40	\$34.71	\$35.53	2.8
310	-Custom per inch - see page 73 for details			\$9.05	\$10.95	\$11.21	

Center-to-center is adjustable. Available in single or split finish. Sold unassembled. Custom sizes available. Custom centers recommended large quantities are available at a 15% upcharge.

LIST PRICE is per item or as otherwise specified, in US dollars. WEIGHT is per 10 pieces or as otherwise specified, in lbs.

EMAIL ORDERS TO SALES@THEBRONZE.COM

320



Solid Brass Cabinet Knob

Item	Dia	C-C	Overall	Tier 1 Finishes	Tier 2 Finishes	Tier 3 Finishes	Wt/10
320	9/16	NA	2	\$41.14	\$47.31	\$48.54	2.1

321 - 323



Solid Brass Handle

Item	Dia	C-C	Proj	Overall	Tier 1 Finishes	Tier 2 Finishes	Tier 3 Finishes	Wt/ea
321-3H	9/16	3 1/2	1 3/16	4 1/2	\$58.87	\$67.71	\$69.76	.46
321-4	9/16	4	1 3/16	6	\$64.20	\$73.82	\$75.26	.58
321 - Custom per inch - see page 73 for details					\$11.67	\$13.42	\$13.78	
322-6	3/4	6	1 3/16	8	\$129.79	\$149.26	\$153.15	.65
322 - Custom per inch - see page 73 for details					\$17.70	\$20.35	\$20.88	
323-10*	1	10	2 1/4	12	\$281.44	\$323.65	\$332.10	3.5
323-12*	1	12	2 1/4	14	\$328.35	\$377.60	\$387.44	4.1
323* Custom per inch - see page 73 for details					\$25.59	\$29.69	\$30.18	

Refer to page 70 and specify mounting as surface (S), through-bolt (T), or back-to-back (BxB). Extra charges apply for BxB - see page 71. **8/32 screws**. Custom lengths are available

340



Solid Brass Cabinet Handle

Item	C-C	Dia	Overall	Tier 1 Finishes	Tier 2 Finishes	Tier 3 Finishes	Wt/ea
340	4	3/4	6	\$37.87	\$45.74	\$46.81	0.6

Through-bolt mount only. Custom lengths are available.

341



Solid Brass Cabinet Handle

Item	C-C	Dia	Overall	Tier 1 Finishes	Tier 2 Finishes	Tier 3 Finishes	Wt/ea
341	4	3/4	6	\$37.87	\$45.80	\$46.86	0.8

Through-bolt mount only. Custom lengths are available.

376 and 377



Solid Brass Cabinet Knob

Not Available In Distressed Finishes

Item	Dia	Proj	Tier 1 Finishes	Tier 2 Finishes	All Finishes	Wt/10
376	7/8	1	N/A	N/A	\$31.46	1.0
377	1 1/4	1 1/4	N/A	N/A	\$46.01	2.1

Split finish item: specify finishes as knob x ring

378



Solid Brass Cabinet Knob

Not Available In Distressed Finishes

Item	Dia	Proj	Tier 1 Finishes	Tier 2 Finishes	All Finishes	Wt/10
378	1 1/4	1	N/A	N/A	\$30.17	1.4

Split finish item: specify finishes as knob x insert



403



Solid Brass Cabinet Handle

Item	C-C	Overall	Tier 1 Finishes	Tier 2 Finishes	Tier 3 Finishes	Wt/10
403	3 1/2	4 x 1 1/8	\$25.47	\$30.24	\$30.95	2.9

404



Solid Brass Cabinet Handle

Item	C-C	Overall	Tier 1 Finishes	Tier 2 Finishes	Tier 3 Finishes	Wt/10
404	3	3 7/16 x 1 11/16	\$33.17	\$38.31	\$39.22	2.5

405



Solid Brass Cabinet Handle

Item	C-C	Overall	Tier 1 Finishes	Tier 2 Finishes	Tier 3 Finishes	Wt/10
405	3	4 11/16 x 1 3/8	\$38.50	\$43.68	\$44.72	2.4

413 to 415



Solid Brass Cabinet and Refrigerator Pull

Item	C-C	Dia	Proj	Overall	Tier 1 Finishes	Tier 2 Finishes	Tier 3 Finishes	Wt/ea
413-6	6	1/2	1 1/4	7	\$65.09	\$76.54	\$78.76	.6
413	Custom per inch - see page 73 for details				\$13.24	\$15.71	\$16.03	
414-8	8	5/8	1 1/2	9	\$106.11	\$125.16	\$127.58	.9
414	Custom per inch - see page 73 for details				\$16.45	\$19.56	\$19.89	
415-10	10	3/4	1 3/4	11	\$124.37	\$147.20	\$150.28	1.5
415	Custom per inch - see page 73 for details				\$18.22	\$21.69	\$22.04	

420 to 455



Solid Brass Cabinet Handle
Also available in Aluminum



Profile of 400 Series

Item	C-C	Overall	Tier 1 Finishes	Tier 2 Finishes	Tier 3 Finishes	Wt/10 in brass	Anodized Aluminum	Wt/10 in alum
420	1	2	\$13.17	\$16.11	\$16.50	1.2		
425	1 1/2	2 1/2	\$13.46	\$16.42	\$16.81	1.5		
435*	2 1/2, 3	3 1/2	\$17.27	\$21.10	\$21.58	2.1	\$18.10	0.7
445	3 1/2	4 1/2	\$21.73	\$26.57	\$27.18	2.7	\$22.76	0.9
455	3 1/2	5 1/2	\$22.81	\$27.85	\$28.52	3.3		

* Item 435 in brass is tapped for both centers; in US28 (anodized aluminum) it is tapped for 2 1/2 C-C only.

*See Page 46 for backplates for use with the 420-455 series

457



Solid Brass Cabinet Handle



Profile

Item	C-C	Overall	Tier 1 Finishes	Tier 2 Finishes	Tier 3 Finishes	Wt/ea
457-6	6	8	\$52.47	\$61.94	\$63.38	3.5
457-8	8	10	\$65.59	\$77.43	\$79.23	5.0
457	Custom per inch - see page 73 for details		\$7.67	\$9.04	\$9.26	

LIST PRICE is per item or as otherwise specified, in US dollars. WEIGHT is per 10 pieces or as otherwise specified, in lbs.

EMAIL ORDERS TO SALES@THEBRONZE.COM

458



Item	C-C	Overall	Tier 1 Finishes	Tier 2 Finishes	Tier 3 Finishes	Wt/ea
458-6	6	8	\$52.47	\$61.94	\$63.38	3.5
458-8	8	10	\$65.59	\$77.43	\$79.23	5.0
458	Custom per inch - see page 73 for details		\$7.67	\$9.04	\$9.26	

460



Item	C-C	Dia	Overall	Tier 1 Finishes	Tier 2 Finishes	Tier 3 Finishes	Wt/10
460-1	1	1 1/4 x 2	2	\$31.65	\$37.54	\$38.45	1.9
460-4	4	1 1/4 x 5	5	\$38.36	\$45.54	\$46.61	5.0
460	Custom per inch - see page 73 for details			\$11.76	\$13.95	\$14.28	

Through-bolt mounting only. Priced by overall length. 6/32 screw holes.

490



Item	C-C	Dia	Overall	Tier 1 Finishes	Tier 2 Finishes	Tier 3 Finishes	Wt/10
490-1H	1 1/2	5/8 x 2	2	\$33.19	\$39.40	\$40.33	1.9
490-4	4	5/8 x 4	6	\$45.25	\$53.71	\$54.98	3.9
490	Custom per inch - see page 73 for details			\$11.76	\$13.95	\$14.28	

Through-bolt mounting only. Priced by overall length. 6/32 screw holes.

500 Series

To order with BULLNOSE ends, specify "B" before the overall length.

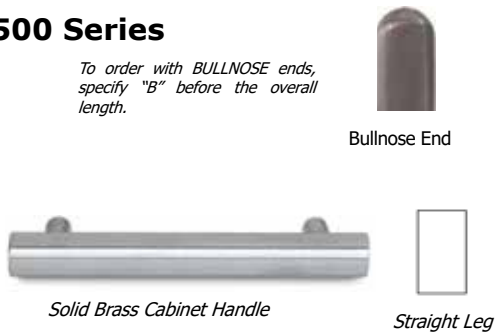

Item*	C-C	Dia	Overall	Tier 1 Finishes	Tier 2 Finishes	Tier 3 Finishes	Wt/10
500-1H	1 1/2	1/2	2 1/2	\$16.69	\$19.71	\$20.17	1.3
500-2H	2 1/2	1/2	3 1/2	\$22.74	\$27.59	\$28.23	2.2
500-3	3	1/2	4	\$25.98	\$31.50	\$32.25	2.5
500-3H	3 1/2	1/2	4 1/2	\$29.24	\$35.49	\$36.30	2.8
500-6	6	1/2	8	\$52.42	\$63.04	\$64.5	3.0
500-8	8	1/2	10	\$64.98	\$78.8	\$80.65	3.2
500	Custom per inch - see page 73 for details			\$8.29	\$10.05	\$11.33	

Add \$11.98 per pull for bullnose. Through-bolt mounting only. Priced by overall length.

504 and 505



Item	C-C	Dia	Overall	Tier 1 Finishes	Tier 2 Finishes	Tier 3 Finishes	Wt/10
504	3	1/2	4	\$24.48	\$29.96	\$30.66	2.2
505	3 1/2	1/2	4 1/2	\$31.81	\$38.91	\$39.82	2.6
504	Custom per inch - see page 73 for details			\$10.87	\$13.15	\$13.44	

506 and 507



Item	C-C	Dia	Overall	Tier 1 Finishes	Tier 2 Finishes	Tier 3 Finishes	Wt/10
506	3	7/16 SQ	4 1/2	\$31.28	\$38.23	\$39.12	2.6
507	3 1/2	7/16 SQ	6	\$43.18	\$52.78	\$54.00	4.5
506	Custom per inch - see page 73 for details			\$9.23	\$10.25	\$10.48	

Through-bolt mounting only. Priced by overall length. 8/32 screw holes.



LIST PRICE is per item or as otherwise specified, in US dollars. WEIGHT is per 10 pieces or as otherwise specified, in lbs.

EMAIL ORDERS TO SALES@THEBRONZE.COM



508 Series



Solid Brass Cabinet Handle



Straight Leg



Cross Section of the 508 pull

Item	C-C	Dia	Overall	Tier 1 Finishes	Tier 2 Finishes	Tier 3 Finishes	Wt/10
508	4	3/4 X 3/8	6	\$74.94	\$90.99	\$93.13	2.6
508	Custom per inch - see page 73 for details			\$14.63	\$17.71	\$18.14	

Through-bolt mounting only. Priced by overall length. 8/32 screw holes.

510 to 512



Solid Brass Cabinet Knob
Straight post

Item	Dia	Proj	Tier 1 Finishes	Tier 2 Finishes	Tier 3 Finishes	Wt/10
510	1	1 3/16	\$14.81	\$18.12	\$18.52	1.3
511	1 1/4	1 3/16	\$17.88	\$21.85	\$22.35	1.8
512	1 1/2	1 3/16	\$20.66	\$25.26	\$25.85	2.5

520 to 522



Solid Brass Cabinet Knob
Straight post

Item	Dia	Proj	Tier 1 Finishes	Tier 2 Finishes	Tier 3 Finishes	Wt/10
520	1 SQ	1 3/16	\$17.88	\$21.85	\$22.35	1.5
521	1 1/4 SQ	1 3/16	\$20.66	\$25.26	\$25.85	2.2
522	1 1/2 SQ	1 3/16	\$23.56	\$28.82	\$29.49	3

526 and 527



Solid Brass Cabinet Knob
Flared post

Item	Dia	Proj	Tier 1 Finishes	Tier 2 Finishes	Tier 3 Finishes	Wt/10
526	1 1/4 SQ	1 3/16	\$30.29	\$36.58	\$37.42	2.1
527	1 1/2 SQ	1 3/16	\$32.05	\$38.73	\$39.64	2.9

530 to 532



Solid Brass Cabinet Knob
Straight post

Item	Dia	Proj	Tier 1 Finishes	Tier 2 Finishes	Tier 3 Finishes	Wt/10
530	1 HEX	1 3/16	\$17.88	\$21.85	\$22.35	1.3
531	1 1/4 HEX	1 3/16	\$20.66	\$25.26	\$25.85	2
532	1 1/2 HEX	1 3/16	\$23.56	\$28.83	\$29.50	2.7

534 to 538



534 Solid Brass Cabinet Knob



535-538 Solid Brass Cabinet Handle

Item	C-C	Dia	Proj	Overall	Tier 1 Finishes	Tier 2 Finishes	Tier 3 Finishes	Wt/ea
534	NA	1/2	1 1/4	1 1/2	\$28.62	\$34.88	\$35.70	.3
535-3	3	1/2	1 1/4	4	\$32.03	\$38.03	\$39.93	.4
535-6	6	1/2	1 1/4	7	\$56.03	\$66.55	\$69.91	.5
535	Custom per inch - see page 73 for details				\$8.50	\$10.09	\$10.62	
536-8*	8	5/8	1 1/2	9 1/2	\$101.38	\$120.40	\$123.24	1.1
536	Custom per inch - see page 73 for details				\$11.64	\$13.81	\$14.52	
537-10*	10	3/4	1 7/8	12	\$126.71	\$150.49	\$154.04	2.1
537	Custom per inch - see page 73 for details				\$12.67	\$14.92	\$15.82	
538-10*	10	1	2 5/8	12 1/2	\$223.47	\$256.98	\$263.68	3.8
538	Custom per inch - see page 73 for details				\$19.98	\$22.97	\$23.56	

***536, 537 and 538 are available in several mountings.**
Refer to page 70 and specify mounting as surface (S), through-bolt (T), or back-to-back (BxB).
Extra charges apply for BxB - see page 71.

LIST PRICE is per item or as otherwise specified, in US dollars. WEIGHT is per 10 pieces or as otherwise specified, in lbs.

EMAIL ORDERS TO SALES@THEBRONZE.COM

540



Solid Brass Cabinet Knob

Item	Dia	Proj	Overall	Tier 1 Finishes	Tier 2 Finishes	Tier 3 Finishes	Wt/10
540	5/8	1 1/8	2	\$27.79	\$33.54	\$34.32	1.6

541



Solid Brass Cabinet Knob

Item	Dia	Proj	Overall	Tier 1 Finishes	Tier 2 Finishes	Tier 3 Finishes	Wt/10
541	5/8	1 1/4	2	\$27.79	\$33.54	\$34.32	1.7

545 to 547



Solid Brass Cabinet Handle
Single Knurl Banded



Single Knurl

Item	C-C	Dia	Overall	Tier 1 Finishes	Tier 2 Finishes	Tier 3 Finishes	Wt/ea
545	4	1/2	5	\$58.59	\$70.30	\$73.60	.3
545	Custom per inch - see page 73 for details			\$13.94	\$16.72	\$17.42	
546	6	5/8	7 1/2	\$86.23	\$103.47	\$107.79	.7
546	Custom per inch - see page 73 for details			\$14.66	\$17.60	\$18.34	
547*	8	3/4	10	\$124.33	\$149.19	\$155.41	1.5
547	Custom per inch - see page 73 for details			\$16.43	\$19.72	\$20.54	

*Refer to page 70 and specify mounting as surface (S), through-bolt (T), or back-to-back (BxB). Extra charges apply for BxB - see page 71. This item priced by overall length.

548 to 550



Solid Brass Cabinet Knob Single Knurl Banded



Single Knurl

Item	Dia	Proj	Tier 1 Finishes	Tier 2 Finishes	Tier 3 Finishes	Wt/10
548	3/4	1 1/4	\$22.36	\$27.01	\$27.95	1.5
549	1	1 1/4	\$26.09	\$31.53	\$32.62	2.5
550	1 1/4	1 1/4	\$31.31	\$37.80	\$39.13	2.7

551 to 553



Solid Brass Cabinet Handle Full Single Knurl



Single Knurl

Item	C-C	Dia	Overall	Tier 1 Finishes	Tier 2 Finishes	Tier 3 Finishes	Wt/ea
551	4	1/2	5	\$58.59	\$70.30	\$73.60	.3
551	Custom per inch - see page 73 for details			\$13.94	\$16.72	\$17.42	
552	6	5/8	7 1/2	\$86.23	\$103.47	\$107.79	.7
552-	Custom per inch - see page 73 for details			\$14.66	\$17.60	\$18.34	
553*	8	3/4	10	\$124.33	\$149.19	\$155.41	1.5
553-	Custom per inch - see page 73 for details			\$16.43	\$19.72	\$20.54	

*Refer to page 70 and specify mounting as surface (S), through-bolt (T), or back-to-back (BxB). Extra charges apply for BxB - see page 71. This item priced by overall length.

557 to 559



Solid Brass Cabinet Handle Diamond Knurl Banded



Diamond Knurl

Item	C-C	Dia	Overall	Tier 1 Finishes	Tier 2 Finishes	Tier 3 Finishes	Wt/ea
557	4	1/2	5	\$58.59	\$70.30	\$73.60	.3
557	Custom per inch - see page 73 for details			\$13.94	\$16.72	\$17.42	
558	6	5/8	7 1/2	\$86.23	\$103.47	\$107.79	.7
558	Custom per inch - see page 73 for details			\$14.66	\$17.60	\$18.34	
559*	8	3/4	10	\$124.33	\$149.19	\$155.41	1.5
559	Custom per inch - see page 73 for details			\$16.43	\$19.72	\$20.54	

*Refer to page 70 and specify mounting as surface (S), through-bolt (T), or back-to-back (BxB). Extra charges apply for BxB - see page 71. This item priced by overall length..



560 to 562



Diamond Knurl

Solid Brass Cabinet Knob Diamond Knurl Banded

Item	Dia	Proj	Tier 1 Finishes	Tier 2 Finishes	Tier 3 Finishes	Wt/10
560	3/4	1 1/4	\$22.36	\$27.01	\$27.95	1.3
561	1	1 1/4	\$26.09	\$31.53	\$32.62	2
562	1 1/4	1 1/4	\$31.31	\$37.80	\$39.13	2.7

563 to 565



Solid Brass Cabinet Handle Full Diamond Knurl

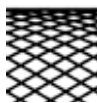

Diamond Knurl

Item	C-C	Dia	Overall	Tier 1 Finishes	Tier 2 Finishes	Tier 3 Finishes	Wt/ea
563	4	1/2	5	\$58.59	\$70.30	\$73.60	.3
563	Custom per inch - see page 73 for details			\$13.94	\$16.72	\$17.42	
564	6	5/8	7 1/2	\$86.23	\$103.47	\$107.79	.7
564	Custom per inch - see page 73 for details			\$14.66	\$17.60	\$18.34	
565*	8	3/4	10	\$124.33	\$149.19	\$155.41	1.5
565	Custom per inch - see page 73 for details			\$16.43	\$19.72	\$20.54	

*Refer to page 70 and specify mounting as surface (S), through-bolt (T), or back-to-back (BxB). Extra charges apply for BxB - see page 71. This item priced by overall length..

566



Solid Brass Appliance Handle Single Knurl Banded



Single Knurl

Item	C-C	Dia	Overall	Tier 1 Finishes	Tier 2 Finishes	Tier 3 Finishes	Wt/10
566	10	1	14	\$317.48	\$380.99	\$396.86	2.6
566	Custom per inch - see page 73 for details			\$24.74	\$29.69	\$30.93	

Refer to page 70 and specify mounting as surface (S), through-bolt (T), or back-to-back (BxB). Extra charges apply for BxB - see page 71. 1/4-20 screw holes.

567



Solid Brass Appliance Handle Full Single Knurl



Single Knurl

Item	C-C	Dia	Overall	Tier 1 Finishes	Tier 2 Finishes	Tier 3 Finishes	Wt/10
567	10	1	14	\$317.48	\$380.99	\$396.86	2.6
567	Custom per inch - see page 73 for details			\$24.74	\$29.69	\$30.93	

Refer to page 70 and specify mounting as surface (S), through-bolt (T), or back-to-back (BxB). Extra charges apply for BxB - see page 71. 1/4-20 screw holes.

568



Solid Brass Appliance Handle Diamond Knurl Banded

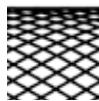

Diamond Knurl

Item	C-C	Dia	Overall	Tier 1 Finishes	Tier 2 Finishes	Tier 3 Finishes	Wt/10
568	10	1	14	\$317.48	\$380.99	\$396.86	2.6
568	Custom per inch - see page 73 for details			\$24.74	\$29.69	\$30.93	

Refer to page 70 and specify mounting as surface (S), through-bolt (T), or back-to-back (BxB). Extra charges apply for BxB - see page 71. 1/4-20 screw holes.

569



Solid Brass Appliance Handle Full Diamond Knurl



Diamond Knurl

Item	C-C	Dia	Overall	Tier 1 Finishes	Tier 2 Finishes	Tier 3 Finishes	Wt/10
569	10	1	14	\$317.48	\$380.99	\$396.86	2.6
569	Custom per inch - see page 73 for details			\$24.74	\$29.69	\$30.93	

Refer to page 70 and specify mounting as surface (S), through-bolt (T), or back-to-back (BxB). Extra charges apply for BxB - see page 71. 1/4-20 screw holes.

LIST PRICE is per item or as otherwise specified, in US dollars. WEIGHT is per 10 pieces or as otherwise specified, in lbs.

EMAIL ORDERS TO SALES@THEBRONZE.COM

570



Solid Brass Cabinet Knob



Single Knurl

Item	Dia	Proj	Overall	Tier 1 Finishes	Tier 2 Finishes	Tier 3 Finishes	Wt/10
570	1/2	1 1/4	2	\$38.62	\$44.42	\$45.58	2.4

571



Solid Brass Cabinet Knob

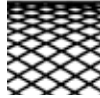

Diamond Knurl

Item	Dia	Proj	Overall	Tier 1 Finishes	Tier 2 Finishes	Tier 3 Finishes	Wt/10
571	1/2	1 1/4	2	\$38.62	\$44.42	\$45.58	2.4

591



Solid Brass Cabinet Knob



Single Knurl

Item	Dia	Proj	Tier 1 Finishes	Tier 2 Finishes	Tier 3 Finishes	Wt/10
591	1 1/4	1	\$61.71	\$70.97	\$72.82	1.5

592



Solid Brass Rosette with Exposed Screws

Item	Dia	Proj	Tier 1 Finishes	Tier 2 Finishes	Tier 3 Finishes	Wt/10
592	1 3/4	3/16	\$25.41	\$29.23	\$29.99	1.5

595



Solid Brass Cabinet Knob

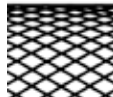

Diamond Knurl

Item	Dia	Proj	Tier 1 Finishes	Tier 2 Finishes	Tier 3 Finishes	Wt/10
595	1 1/4	1	\$61.71	\$70.97	\$72.82	1.5

600 and 601



Solid Brass Cabinet Handle

Item	C-C	Face	Overall	Tier 1 Finishes	Tier 2 Finishes	Tier 3 Finishes	Wt/10
600	3 1/2	1/2	4 5/16	\$18.38	\$22.45	\$22.97	1.7
601	3	1/2	3 13/16	\$17.72	\$21.66	\$22.17	1.5

609



Solid Brass Cabinet Knob

Item	Dia	Proj	Tier 1 Finishes	Tier 2 Finishes	Tier 3 Finishes	Wt/10
609	5/8 Half Round	1	\$11.89	\$14.53	\$14.88	0.8

610 and 611



Solid Brass Cabinet Handle

Item	C-C	Face	Overall	Tier 1 Finishes	Tier 2 Finishes	Tier 3 Finishes	Wt/10
610	3	5/8 HR	4	\$23.80	\$29.11	\$29.79	2.2
611	3 1/2	5/8 HR	4 1/2	\$25.17	\$30.76	\$31.46	2.3

LIST PRICE is per item or as otherwise specified, in US dollars. WEIGHT is per 10 pieces or as otherwise specified, in lbs.

EMAIL ORDERS TO SALES@THEBRONZE.COM



612 and 613



Solid Brass Cabinet Handle

Item	C-C	Face	Overall	Tier 1 Finishes	Tier 2 Finishes	Tier 3 Finishes	Wt/10
612	3	1/4 x 3/8	4 1/4	\$19.28	\$23.57	\$24.11	1.6
613	3 1/2	1/4 x 3/8	4 3/4	\$20.10	\$24.60	\$25.18	1.7

620 to 622



Solid Brass Cabinet Knob

Item	Dia	Proj	Tier 1 Finishes	Tier 2 Finishes	Tier 3 Finishes	Wt/10
620	1	1 3/16	\$42.92	\$49.36	\$50.66	1.3
621	1 1/4	1 3/16	\$47.19	\$54.25	\$55.67	1.8
622	1 1/2	1 3/16	\$57.10	\$65.67	\$67.38	2.5

623 to 625



Solid Brass Cabinet Knob

Item	Dia	Proj	Tier 1 Finishes	Tier 2 Finishes	Tier 3 Finishes	Wt/10
623	1 SQ	1 3/16	\$55.77	\$64.13	\$66.17	1.5
624	1 1/4 SQ	1 3/16	\$67.49	\$77.61	\$79.63	2.2
625	1 1/2 SQ	1 3/16	\$80.62	\$92.71	\$95.13	3.0

626 to 628



Solid Brass Cabinet Knob

Item	Dia	Proj	Tier 1 Finishes	Tier 2 Finishes	Tier 3 Finishes	Wt/10
626	1 HEX	1 3/16	\$55.77	\$64.13	\$66.17	1.3
627	1 1/4 HEX	1 3/16	\$67.49	\$77.61	\$79.63	2.0
628	1 1/2 HEX	1 3/16	\$80.62	\$92.71	\$95.13	2.7

632 and 633



Solid Brass Cabinet Knob

Item	Dia	Proj	Tier 1 Finishes	Tier 2 Finishes	Tier 3 Finishes	Wt/10
632	1 1/4	1 1/8	\$34.46	\$39.63	\$40.67	2.0
633	1 1/2	1 1/4	\$43.34	\$49.84	\$51.14	3.2

636 and 637



Solid Brass Cabinet Knob

Item	Dia	Proj	Tier 1 Finishes	Tier 2 Finishes	Tier 3 Finishes	Wt/10
636	1 1/4	1 1/2	\$34.46	\$39.63	\$40.67	2.6
637	1 1/2	2	\$43.34	\$49.84	\$51.14	4

655 and 657 Knob w/ 656 and 658 Rose



Solid Brass Knob



Rose

Item	Dia	Proj	Tier 1 Finishes	Tier 2 Finishes	Tier 3 Finishes	Wt/10
655 Knob	1 1/4	1 1/8	\$21.99	\$26.10	\$26.72	2.5
656 Rose	1 1/4	3/16	\$13.01	\$15.43	\$15.80	0.6
657 Knob	1 1/2	1 3/16	\$27.97	\$33.25	\$34.01	3.8
658 Rose	1 5/8	3/16	\$14.53	\$17.28	\$17.68	0.9

LIST PRICE is per item or as otherwise specified, in US dollars. WEIGHT is per 10 pieces or as otherwise specified, in lbs.

EMAIL ORDERS TO SALES@THEBRONZE.COM

661 to 663



Solid Brass Cabinet Handle

Item	C-C	Face	Overall	Tier 1 Finishes	Tier 2 Finishes	Tier 3 Finishes	Wt/10
661	3	5/16	3 3/8	\$18.47	\$22.61	\$23.12	1.2
662	3 1/2	5/16	3 7/8	\$19.88	\$24.15	\$24.72	1.3
663	4	5/16	4 3/8	\$21.08	\$25.80	\$26.38	1.5

667



Solid Brass Cabinet Handle
6-32 screws provided

Item	C-C	Face	Overall	Tier 1 Finishes	Tier 2 Finishes	Tier 3 Finishes	Wt/10
667-2	2	1/4	2 3/8	\$28.40	\$33.70	\$34.51	1.0
667-4	4	1/4	4 3/8	\$35.78	\$42.47	\$43.47	1.4
667-6	6	1/4	6 3/8	\$41.75	\$49.56	\$50.71	1.8
667	Custom per inch - see page 73 for details			\$7.40	\$8.79	\$8.99	

668



Solid Brass Cabinet Handle
6-32 screws provided

Item	C-C	Face	Leg A	Leg B	Overall	Tier 1 Finishes	Tier 2 Finishes	Tier 3 Finishes	Wt/10
668-2	2	1/4	3/8	5/8	2 1/2	\$28.40	\$33.70	\$34.51	1.0
668-4	4	1/4	3/8	1	4 1/2	\$35.78	\$42.47	\$43.47	1.6
668-6	6	1/4	3/8	1 1/2	6 1/2	\$41.75	\$49.56	\$50.71	2.4
668	Custom per inch - see page 73 for details					\$7.40	\$8.79	\$8.99	

669



Solid Brass Cabinet Handle
6-32 screws provided

Item	C-C	Face	Overall	Tier 1 Finishes	Tier 2 Finishes	Tier 3 Finishes	Wt/10
669-2	2	1/4	2 3/8	\$30.44	\$36.10	\$36.98	1.4
669-4	4	1/4	4 3/8	\$38.34	\$45.51	\$46.57	2.0
669-6	6	1/4	6 3/8	\$43.29	\$51.38	\$52.60	2.4
669	Custom per inch - see page 73 for details			\$10.45	\$12.40	\$12.72	

674 - 676



Solid Brass Knob

Item	Dia	Proj	Tier 1 Finishes	Tier 2 Finishes	Tier 3 Finishes	Wt/10
674	1 3/16	1	\$19.40	\$23.66	\$24.21	1.1
675	1 3/8	1 1/4	\$22.03	\$26.87	\$27.50	2.0
676	1 1/2	1 1/4	\$24.67	\$30.04	\$30.72	2.4

700

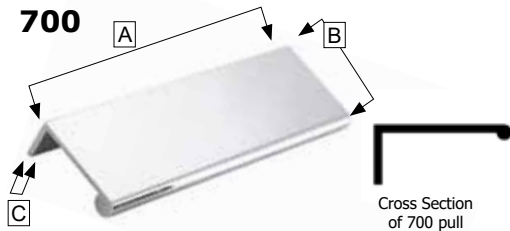

Solid Brass Cabinet Handle

Item	C-C	"A"	"B"	"C"	Tier 1 Finishes	Tier 2 Finishes	Tier 3 Finishes	Wt/10
700-1H	1 1/2	2	1 3/4	3/32	\$22.87	\$26.30	\$26.99	2.0
700-3	3	4	1 3/4	3/32	\$32.80	\$37.72	\$38.70	4.1
700-5	5	6	1 3/4	3/32	\$48.76	\$56.07	\$57.54	6.1
700-6	6	9	1 3/4	3/32	\$58.51	\$67.29	\$69.04	6.3
700-8	8	9	1 3/4	3/32	\$78.02	\$89.72	\$92.06	8.2
700-10	10	11	1 3/4	3/32	\$97.52	\$112.15	\$115.07	10.4
700	Custom per inch - see page 73 for details				\$12.47	\$14.34	\$14.72	

706 to 709

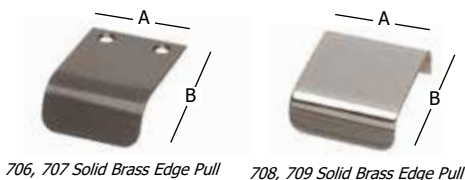

706, 707 Solid Brass Edge Pull 708, 709 Solid Brass Edge Pull

Item	C-C	"A"	"B"	Thickness	Tier 1 Finishes	Tier 2 Finishes	Tier 3 Finishes	Wt/10
706	1	1 1/2	2 1/8	0.050	\$14.53	\$17.81	\$18.24	1.0
707	2	2 1/2	2 1/8	0.050	\$21.73	\$26.57	\$27.18	1.5
708	1	1 1/2	1 5/8	0.050	\$12.85	\$15.69	\$16.06	1.0
709	2	2 1/2	1 5/8	0.050	\$18.14	\$22.20	\$22.73	1.5

LIST PRICE is per item or as otherwise specified, in US dollars. WEIGHT is per 10 pieces or as otherwise specified, in lbs.

EMAIL ORDERS TO SALES@THEBRONZE.COM

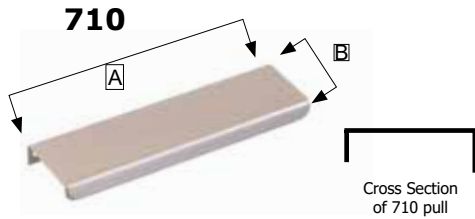

Item	C-C	"A"	"B"	Thickness	Tier 1 Finishes	Tier 2 Finishes	Tier 3 Finishes	Wt/10
710-2	2	2 1/2	1 1/2	0.050	\$18.14	\$21.54	\$22.04	0.9
710-5	5	6	1 1/2	0.050	\$22.58	\$26.79	\$27.43	2.1
710-8	8	9	1 1/2	0.050	\$35.59	\$41.99	\$43.06	3.6
710-10	10	11	1 1/2	0.050	\$46.76	\$55.17	\$56.58	4.2
710	Custom per inch - see page 73 for details				\$6.66	\$7.90	\$ 8.08	

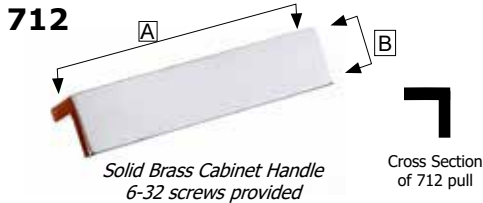

Item	C-C	Overall	"A"	"B"	Thickness	Tier 1 Finishes	Tier 2 Finishes	Tier 3 Finishes	Wt/10
712-1H	1 1/2	2 1/2	1	1	1/4	\$25.37	\$30.1	\$30.80	3.2
712-3	3	4	1	1	1/4	\$29.81	\$35.39	\$36.22	5.7
712	Custom per inch - see page 73 for details					\$11.41	\$13.53	\$13.86	

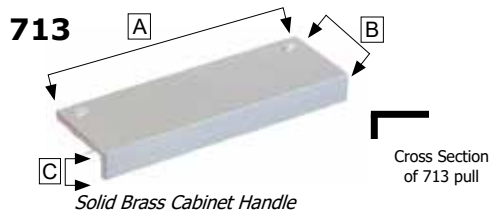

Item	C-C	"A"	"B"	"C"	Thickness	Tier 1 Finishes	Tier 2 Finishes	Tier 3 Finishes	Wt/10
713-2	2	2 1/2	1 1/2	1/2	1/8	\$26.84	\$31.85	\$32.59	1.5
713-4	4	4 1/2	1 1/2	1/2	1/8	\$31.31	\$37.16	\$38.04	3.1
713-6	6	6 1/2	1 1/2	1/2	1/8	\$36.77	\$42.29	\$44.13	4.2
713-8	8	8 1/2	1 1/2	1/2	1/8	\$42.23	\$48.57	\$50.68	4.6
713-12	12	12 1/2	1 1/2	1/2	1/8	\$51.15	\$58.83	\$61.38	8.7
713	Custom per inch - see page 73 for details					\$11.41	\$13.53	\$13.86	



Item	C-C	Overall	"A"	"B"	Tier 1 Finishes	Tier 2 Finishes	Tier 3 Finishes	Wt/10
714-3	3	4	1	1	\$32.05	\$38.04	\$38.94	5.1
714-5	5	6	1	1	\$38.02	\$45.12	\$46.19	7.6
714	Custom per inch - see page 73 for details				\$11.41	\$13.53	\$13.86	



Item	C-C	Overall	Projection	Tier 1 Finishes	Tier 2 Finishes	Tier 3 Finishes	Wt/10
715-3	3	4	1	\$33.04	\$39.24	\$40.16	2.8
715-5	5	6	1	\$38.02	\$45.12	\$46.19	4.3
715	Custom per inch - see page 73 for details			\$11.41	\$13.53	\$13.86	



Item	C-C	Overall	"A"	"B"	Tier 1 Finishes	Tier 2 Finishes	Tier 3 Finishes	Wt/10
716-3	3	4	1	1	\$32.05	\$38.04	\$38.94	5.1
716-5	5	6	1	1	\$38.02	\$45.12	\$46.19	7.6
716	Custom per inch - see page 73 for details				\$11.41	\$13.53	\$13.86	



Item	C-C	Overall	Projection	Tier 1 Finishes	Tier 2 Finishes	Tier 3 Finishes	Wt/10
717-3	3	4	1	\$33.04	\$39.24	\$40.16	2.8
717-5	5	6	1	\$38.02	\$45.12	\$46.19	4.3
717	Custom per inch - see page 73 for details			\$11.41	\$13.53	\$13.86	

LIST PRICE is per item or as otherwise specified, in US dollars. WEIGHT is per 10 pieces or as otherwise specified, in lbs.

EMAIL ORDERS TO SALES@THEBRONZE.COM

718



Solid Brass Cabinet Handle
6-32 screws provided

Item	C-C	Overall	Projection	Tier 1 Finishes	Tier 2 Finishes	Tier 3 Finishes	Wt/10
718-3	3	4	1	\$32.79	\$38.92	\$39.84	2.2
718-4	4	6	1	\$39.51	\$46.90	\$48.00	3.0
718	Custom per inch - see page 73 for details			\$11.41	\$13.53	\$13.86	

719



Solid Brass Cabinet Handle
6-32 screws provided

Item	C-C	Overall	Projection	Tier 1 Finishes	Tier 2 Finishes	Tier 3 Finishes	Wt/10
719-4	4	6	1	\$39.51	\$46.90	\$48.00	3.0
719-6	6	8	1	\$46.21	\$54.86	\$56.16	3.8
719	Custom per inch - see page 73 for details			\$11.41	\$13.53	\$13.86	

730 to 733



Solid Brass Cabinet Handle



730 style is flat on the back

Item	C-C	Face	Overall	Tier 1 Finishes	Tier 2 Finishes	Tier 3 Finishes	Wt/10
730-6	6	7/16	6 1/2	\$46.74	\$55.15	\$56.79	3.0
730-8	8	7/16	8 1/2	\$51.40	\$60.65	\$62.45	3.5
730	Custom per inch - see page 73 for details			\$8.32	\$9.88	\$10.11	
731-8	8	5/8	8 1/2	\$75.60	\$89.20	\$91.85	8.5
731	Custom per inch - see page 73 for details			\$11.22	\$13.24	\$13.64	
732-8	8	3/4	8 1/2	\$121.31	\$143.13	\$147.38	10.5
732	Custom per inch - see page 73 for details			\$15.18	\$17.91	\$18.44	
733-8	8	1	8 1/2	\$151.85	\$179.19	\$184.50	17.5
733	Custom per inch - see page 73 for details			\$23.88	\$29.25	\$29.92	

735



Solid Brass Cabinet Knob

Rectangular Base - three mounting holes standard

Item	Dia	Proj	Tier 1 Finishes	Tier 2 Finishes	Tier 3 Finishes	Wt/10
735	1 1/2 SQ	1 3/16	\$35.70	\$42.12	\$43.36	3.5

Standard center hole for retrofit applications



Permanent orientation 1/2" on center holes available - no more turning knobs

741 to 743



Solid Brass Cabinet Handle

Item	C-C	Face	Overall	Tier 1 Finishes	Tier 2 Finishes	Tier 3 Finishes	Wt/10
741	3	7/16	3 3/8	\$18.47	\$22.61	\$23.12	1.2
742	3 1/2	7/16	3 7/8	\$19.88	\$24.15	\$24.72	1.3
743	4	7/16	4 3/8	\$21.08	\$25.80	\$26.38	1.5

745



Solid Brass Cabinet Handle

Cross Section



745 is rounded on the underside of the pull

Custom per inch - see page 73 for details

Item	C-C	Face	Overall	Tier 1 Finishes	Tier 2 Finishes	Tier 3 Finishes	Wt/10
745-4	4	7/16	4 7/16	\$30.49	\$36.21	\$37.09	3.5
745-6	6	7/16	6 7/16	\$38.10	\$45.23	\$46.31	4.5
745-8	8	7/16	8 7/16	\$43.23	\$51.32	\$52.54	5.5
745-10	10	7/16	10 7/16	\$76.23	\$90.53	\$92.73	6.5
745	Custom per inch - see page 73 for details			\$9.15	\$10.87	\$11.13	

LIST PRICE is per item or as otherwise specified, in US dollars. WEIGHT is per 10 pieces or as otherwise specified, in lbs.

EMAIL ORDERS TO SALES@THEBRONZE.COM



746 Series



Cross Section



746 is rounded on the underside of the pull

Solid Brass Cabinet Handle

Item	C-C	Face	Overall	Tier 1 Finishes	Tier 2 Finishes	Tier 3 Finishes	Wt/10
746-8	8	5/8 HR	8 3/8	\$63.50	\$74.93	\$77.15	5.0
746	Custom per inch - see page 73 for details			\$11.22	\$13.24	\$13.64	

747 Series



Cross Section



747 is rounded on the underside of the pull

Solid Brass Cabinet Handle

Item	C-C	Face	Overall	Tier 1 Finishes	Tier 2 Finishes	Tier 3 Finishes	Wt/10
747-8	8	3/4 HR	8 3/8	\$103.16	\$121.73	\$125.35	7.0
747	Custom per inch - see page 73 for details			\$15.18	\$17.91	\$18.44	

748 Series



Cross Section



748 is rounded on the underside of the pull

Solid Brass Cabinet Handle

Item	C-C	Face	Overall	Tier 1 Finishes	Tier 2 Finishes	Tier 3 Finishes	Wt/10
748-6	6	5/8 x 3/8	6 3/8	\$56.62	\$66.80	\$68.79	6.0
748-8	8	5/8 x 3/8	8 3/8	\$63.50	\$74.93	\$77.15	7.0
748	Custom per inch - see page 73 for details			\$11.22	\$13.24	\$13.64	

749



Solid Brass Cabinet Knob

Rectangular Base - three mounting holes standard

Item	Dia	Proj	Tier 1 Finishes	Tier 2 Finishes	Tier 3 Finishes	Wt/10
749	1 1/2 SQ	1 3/16	\$33.52	\$39.56	\$40.73	3.5

Standard center hole for retrofit applications



Permanent orientation 1/2" on center holes available - no more turning knobs

750 to 776



Solid Brass Cabinet Handle

Item	C-C	Dia	Overall	Tier 1 Finishes	Tier 2 Finishes	Tier 3 Finishes	Wt/10
750	2 1/2	5/16	2 13/16	\$7.81	\$9.50	\$9.71	1.1
751	3	5/16	3 5/16	\$8.83	\$10.80	\$11.04	1.2
752	3 1/2	5/16	3 13/16	\$9.94	\$12.12	\$12.41	1.3
753	4	5/16	4 5/16	\$10.59	\$12.96	\$13.28	1.5
754	5	5/16	5 5/16	\$11.45	\$14.01	\$14.32	1.7
755	6	5/16	6 5/16	\$14.08	\$17.25	\$17.64	2
775	2 3/4	5/16	3 1/16	\$9.94	\$12.12	\$12.41	1.2
776	3 3/4	5/16	4 1/16	\$11.39	\$13.88	\$14.20	1.4

LIST PRICE is per item or as otherwise specified, in US dollars. WEIGHT is per 10 pieces or as otherwise specified, in lbs.

EMAIL ORDERS TO SALES@THEBRONZE.COM

777 to 778



Solid Brass Washer



Finishing Washer

Item	Dia	Tier 1 Finishes	Tier 2 Finishes	Tier 3 Finishes	Wt/100
777	5/8	\$1.60	\$1.96	\$2.00	0.3
778*	5/8	\$1.33	\$1.58	\$1.62	0.2

*Also available in Satin Aluminum \$1.08 each

800 to 802



Solid Brass Cabinet Handle

Item	C-C	Face	Overall	Tier 1 Finishes	Tier 2 Finishes	Tier 3 Finishes	Wt/10
800	3	5/8	3 5/16	\$15.88	\$19.40	\$19.86	2.0
801	3 1/2	5/8	3 13/16	\$16.79	\$20.49	\$20.98	2.3
802	4	5/8	4 5/16	\$18.44	\$22.58	\$23.10	2.5

805



Solid Brass Cabinet Handle

Item	C-C	Dia	Proj	Overall	Tier 1 Finishes	Tier 2 Finishes	Tier 3 Finishes	Wt/ea.
805-6	6	1/2	1 1/4	6 1/2	\$59.86	\$71.63	\$74.01	1.0
805-8	8	1/2	1 1/4	8 1/2	\$84.77	\$101.44	\$104.21	1.3
805	Custom per inch - see page 73 for details				\$13.68	\$16.39	\$16.83	

Refer to page 70 and specify mounting as surface (S), through-bolt (T), or back-to-back (BxB). Extra charges apply for BxB - see page 71. **8-32 screw holes.**

813



Solid Brass Handle

Item	C-C	Dia	Proj	Overall	Tier 1 Finishes	Tier 2 Finishes	Tier 3 Finishes	Wt/ea
813	6	1/2	1 3/8	6 1/2	\$91.20	\$110.25	\$112.82	.3

Available for through-bolt mounting only; Refer to page 55 for mounting information. **8/32 screw holes.**

815



Solid Brass Appliance Handle

Item	C-C	Dia	Proj	Overall	Tier 1 Finishes	Tier 2 Finishes	Tier 3 Finishes	Wt/ea
815	10	3/4	2 1/8	10 3/4	\$193.11	\$225.63	\$230.89	1.1

Available for through-bolt mounting only; Refer to page 55 for mounting information. **1/4-20 screw holes.**

Refrigerator Art™ Appliance Handle

822 Series



Solid Brass Appliance Handle

Item	C-C	Proj	Dia	Tier 1 Finishes	Tier 2 Finishes	Tier 3 Finishes	Wt/ea	
822-8	8	1 7/8	3/4	\$74.77	\$95.68	\$97.90	1.5	
822-10	10	1 7/8	3/4	\$93.45	\$119.59	\$122.35	1.6	
822-12	12	1 7/8	3/4	\$112.15	\$143.51	\$146.85	1.8	
822	Custom per inch - see page 73 for details				\$10.90	\$13.99	\$14.32	

Refer to page 70 and specify mounting as surface (S), through-bolt (T), or back-to-back (BxB). Extra charges apply for BxB - see page 71. **1/4-20 screw holes.**

Refrigerator Art™ Appliance Handle

832 Series



Solid Brass Appliance Handle

Item	C-C	Proj	Dia	Tier 1 Finishes	Tier 2 Finishes	Tier 3 Finishes	Wt/ea	
832-8	8	1 7/8	3/4	\$106.79	\$127.58	\$130.55	1.5	
832-10	10	1 7/8	3/4	\$133.47	\$159.46	\$163.15	1.7	
832-12	12	1 7/8	3/4	\$160.22	\$191.35	\$195.79	2.2	
832	Custom per inch - see page 73 for details				\$15.62	\$18.62	\$19.06	

Refer to page 70 and specify mounting as surface (S), through-bolt (T), or back-to-back (BxB). Extra charges apply for BxB - see page 71. **1/4-20 screw holes.**

Refrigerator Art™ Appliance Handle

LIST PRICE is per item or as otherwise specified, in US dollars. WEIGHT is per 10 pieces or as otherwise specified, in lbs.

EMAIL ORDERS TO SALES@THEBRONZE.COM



836 Series

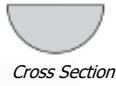

Cross Section

Refrigerator Art™ Appliance Handle

Item	C-C	Proj	Cross Sec.	Tier 1 Finishes	Tier 2 Finishes	Tier 3 Finishes	Wt/ea
836-6	6	1 1/2	1 Half Round	\$80.03	\$95.68	\$97.90	1.1
836-8	8	1 1/2	1 Half Round	\$106.79	\$127.58	\$130.55	1.5
836	Custom per inch - see page 73 for details			\$15.62	\$18.62	\$19.06	

Available for through-bolt mounting only; Refer to page 71 for mounting information. 1/4-20 screw holes. If surface or back-to-back mounting desired, please order the 236 pull on page 14.

844



844 is rounded on the underside of the pull

Solid Brass Cabinet Handle

Refrigerator Art™ Appliance Handle

Item	C-C	Face	Overall	Tier 1 Finishes	Tier 2 Finishes	Tier 3 Finishes	Wt/ea
844-8	8	1	8 1/2	\$128.93	\$157.93	\$161.67	1.3
844-10	10	1	10 1/2	\$169.71	\$207.89	\$212.80	1.4
844	Custom per inch - see page 73 for details			\$23.88	\$29.25	\$29.92	

Refer to page 70 and specify mounting as surface (S), through-bolt (T), or back-to-back (BxB). Extra charges apply for BxB - see page 71. 1/4-20 screw holes.

845



Cross Section
845 is rounded on the underside of the pull

Solid Brass Cabinet Handle

Refrigerator Art™ Appliance Handle

Item	C-C	Face	Overall	Tier 1 Finishes	Tier 2 Finishes	Tier 3 Finishes	Wt/ea
845-8	8	1	8 1/2	\$128.93	\$157.93	\$164.97	1.3
845-10	10	1	10 1/2	\$169.71	\$207.89	\$212.80	1.4
845	Custom per inch - see page 73 for details			\$23.88	\$29.25	\$29.92	

Refer to page 70 and specify mounting as surface (S), through-bolt (T), or back-to-back (BxB). Extra charges apply for BxB - see page 71. 1/4-20 screw holes.

847 Series



To order with BULLNOSE ends, specify "B" before the overall length.



Solid Brass Appliance Handle

Refrigerator Art™ Appliance Handle

Item	C-C	Proj	Dia	Overall	Tier 1 Finishes	Tier 2 Finishes	Tier 3 Finishes	Wt/ea
847-6	6	1 3/4	5/8	10	\$91.20	\$110.25	\$112.82	1.0
847-8	8	1 3/4	5/8	12	\$109.46	\$132.29	\$135.38	1.2
847-18	18	1 3/4	5/8	22	\$200.68	\$242.53	\$248.19	1.4
847	Custom per inch - see page 73 for details				\$10.69	\$12.89	\$13.19	

Refer to page 70 and specify mounting as surface (S), through-bolt (T), or back-to-back (BxB). Extra charges apply for BxB - see page 71. Add \$19.97 for bullnose. This item is priced by overall length. 8/32 screw holes.

850 Series



Solid Brass Appliance Handle

Refrigerator Art™ Appliance Handle

Item	C-C	Proj	Dia	Tier 1 Finishes	Tier 2 Finishes	Tier 3 Finishes	Wt/ea
850-6	6	1 7/8	3/4	\$122.40	\$147.84	\$151.28	1.3
850-8	8	1 7/8	3/4	\$142.16	\$171.74	\$175.74	1.5
850-10	10	1 7/8	3/4	\$157.42	\$190.19	\$194.61	1.7
850-18	18	1 7/8	3/4	\$339.85	\$403.60	\$412.98	2.3

Refer to page 70 and specify mounting as surface (S), through-bolt (T), or back-to-back (BxB). Extra charges apply for BxB - see page 71. 1/4-20 screw holes.

851 Series



Solid Brass Appliance Handle or Towel Bar

Refrigerator Art™ Appliance Handle

Item	C-C	Proj	Overall	Tier 1 Finishes	Tier 2 Finishes	Tier 3 Finishes	Wt/ea
851-6	6	1 7/8	8	\$136.85	\$153.08	\$156.65	1.3
851-8	8	1 7/8	10	\$154.47	\$181.89	\$186.11	1.5
851-10	10	1 7/8	12	\$193.11	\$225.63	\$230.89	1.6

Refer to page 70 and specify mounting as surface (S), through-bolt (T), or back-to-back (BxB). Extra charges apply for BxB - see page 71. 1/4-20 screw holes.

LIST PRICE is per item or as otherwise specified, in US dollars. WEIGHT is per 10 pieces or as otherwise specified, in lbs.

EMAIL ORDERS TO SALES@THEBRONZE.COM

852



Solid Brass Appliance Handle or Towel Bar
Refrigerator Art™ Appliance Handle

Item	C-C	Proj	Overall	Tier 1 Finishes	Tier 2 Finishes	Tier 3 Finishes	Wt/ea
852-10	10	2	12	\$199.40	\$232.73	\$238.14	2.3

Refer to page 70 and specify mounting as surface (S), through-bolt (T), or back-to-back (BxB). Extra charges apply for BxB - see page 71. **1/4-20 screw holes.**

855



Solid Brass Appliance Handle or Towel Bar
Refrigerator Art™ Appliance Handle

Item	C-C	Proj	Overall	Tier 1 Finishes	Tier 2 Finishes	Tier 3 Finishes	Wt/ea
855	16	1 7/8	18	\$427.80	\$495.28	\$506.81	2.3

Refer to page 70 and specify mounting as surface (S), through-bolt (T), or back-to-back (BxB). Extra charges apply for BxB - see page 71. **1/4-20 screw holes.**

858 Series



Solid Brass Appliance Handle
Refrigerator Art™ Appliance Handle

Item	C-C	Dia	Proj	Overall	Tier 1 Finishes	Tier 2 Finishes	Tier 3 Finishes	Wt/ea.
858-6	6	3/4	1 7/8	6 3/4	\$74.77	\$101.77	\$104.14	1.3
858-8	8	3/4	1 7/8	8 3/4	\$99.67	\$135.12	\$138.27	1.5
858	Custom per inch - see page 73 for details				\$14.56	\$19.86	\$20.32	

860



Solid Brass Cabinet Handle

Item	C-C	Dia	Proj	Overall	Tier 1 Finishes	Tier 2 Finishes	Tier 3 Finishes	Wt/ea.
860-4	4	1/2	1 1/4	4 1/2	\$40.94	\$49.67	\$50.81	0.9
860-6	6	1/2	1 1/4	6 1/2	\$59.86	\$71.63	\$74.01	1.0
860-8	8	1/2	1 1/4	8 1/2	\$84.77	\$101.44	\$104.21	1.3
860	Custom per inch - see page 73 for details				\$13.68	\$16.39	\$16.83	

Available for through-bolt mounting only; Refer to page 55 for mounting information. **8-32 screw holes.**

901 to 908



Solid Brass Surface Bolt

Not Available In Distressed Finishes

Supplied with mortise and rimstrikes

Item	Overall	Tier 1 Finishes	Tier 2 Finishes	Tier 3 Finishes	Wt/10
901	1 3/4	\$15.95	\$19.48	\$19.95	1.5
903	3	\$19.38	\$23.69	\$24.23	1.8
904	4	\$23.16	\$28.35	\$29.02	2.2
906	6	\$26.44	\$32.30	\$33.04	3.2
908	8	\$28.72	\$35.12	\$35.94	4.1

940



Solid Brass Cabinet Knob

Item	Dia.	Proj	Overall	Tier 1 Finishes	Tier 2 Finishes	All Finishes	Wt/10
940	3/8 X 3/4	1 1/8	2	\$39.51	\$45.44	\$46.62	1.5

941



Solid Brass Cabinet Handle

Item	C-C	Dia	Overall	Tier 1 Finishes	Tier 2 Finishes	All Finishes	Wt/10
941-4	4	3/8 X 3/4	6	\$93.80	\$107.88	\$110.68	5.5
941-6	6	3/8 X 3/4	8	\$113.70	\$130.76	\$134.16	7.3
941-8	8	3/8 X 3/4	10	\$142.12	\$163.44	\$166.41	9.5
941	Custom per inch - see page 73 for details			\$18.14	\$20.86	\$21.40	

LIST PRICE is per item or as otherwise specified, in US dollars. WEIGHT is per 10 pieces or as otherwise specified, in lbs.

EMAIL ORDERS TO SALES@THEBRONZE.COM



944



945 is rounded on the underside of the pull

Solid Brass Appliance Handle

Exquisite Empire Style Detail

Item	C-C	Face	Proj	Overall	Tier 1 Finishes	Tier 2 Finishes	Tier 3 Finishes	Wt/ea
944-8	8	1 x 5/8	1 5/8	8 1/2	\$193.39	\$236.90	\$242.51	1.3
944-10	10	1 x 5/8	1 5/8	10 1/2	\$254.56	\$311.83	\$319.19	1.4
944	Custom per inch - see page 73 for details				\$29.02	\$33.37	\$34.24	

Refer to page 70 and specify mounting as surface (S), through-bolt (T), or back-to-back (BxB). Extra charges apply for BxB - see page 71. 1/4-20 screw holes.

945



945 is rounded on the underside of the pull

Solid Brass Cabinet Handle

Exquisite Empire Style Detail

Item	C-C	Face	Overall	Tier 1 Finishes	Tier 2 Finishes	Tier 3 Finishes	Wt/10
945-6	6	7/16	6 7/16	\$57.16	\$65.74	\$67.44	4.5
945-8	8	7/16	8 7/16	\$64.86	\$74.58	\$76.54	5.5
945	Custom per inch - see page 73 for details			\$11.43	\$13.15	\$13.49	

1301



Not Available In Distressed Finishes

Order 1501 for straight leg version

Solid Brass Cabinet Knob

Item	Dia.	Proj	Overall	Tier 1 Finishes	Tier 2 Finishes	All Finishes	Wt/10
1301	15/32	1 1/4	2	N/A	N/A	\$19.25	1.5

Split finish item: Specify finishes as post by bar.

1302 and 1303



Not Available In Distressed Finishes

Solid Brass Cabinet Handle

Item	C-C	Dia	Overall	Tier 1 Finishes	Tier 2 Finishes	All Finishes	Wt/10
1302	3	15/32	4 1/2	N/A	N/A	\$31.78	3.2
1303	3 1/2	15/32	5	N/A	N/A	\$33.72	3.5
1302	Custom per inch - see page 73 for details			N/A	N/A	\$11.37	

Split finish item: Specify finishes as post by bar.

1304 and 1305



Not Available In Distressed Finishes

Solid Brass Cabinet Handle

Item	C-C	Dia	Overall	Tier 1 Finishes	Tier 2 Finishes	All Finishes	Wt/10
1304	3	15/32	4	N/A	N/A	\$30.93	2.2
1305	3 1/2	15/32	4 1/2	N/A	N/A	\$38.49	2.6
1304	Custom per inch - see page 73 for details			N/A	N/A	\$11.37	

Split finish item: Specify finishes as post by bar.

1307 to 1310



Solid Brass Refrigerator Pull

Refrigerator Art™ Appliance Handle

Split finish item: Specify finishes as post by bar.

Not Available In Distressed Finishes

Item	C-C	Proj	Dia	Overall	Tier 1 Finishes	Tier 2 Finishes	All Finishes	Wt/ea.
1307-4	4		15/32	5 1/2	N/A	N/A	\$57.37	.35
1307-6	6		15/32	7 1/2	N/A	N/A	\$83.45	.46
1307	Custom per inch - see page 73 for details				N/A	N/A	\$11.37	
1308-6	6	1 1/2	5/8	7 1/2	N/A	N/A	\$149.91	1.0
1308	Custom per inch - see page 73 for details				N/A	N/A	\$21.08	
1309-8*	8	1 7/8	3/4	10	N/A	N/A	\$204.15	1.5
1309	Custom per inch - see page 73 for details				N/A	N/A	\$24.92	
1310-10*	10	2	1	12	N/A	N/A	\$296.33	3.1
1310	Custom per inch - see page 73 for details				N/A	N/A	\$28.86	

*1309 and 1310 can be ordered in different mountings. Refer to page 70 and specify mounting as surface (S), through-bolt (T), or back-to-back (BxB). Extra charges apply for BxB - see page 71. 1/4-20 screw holes.

LIST PRICE is per item or as otherwise specified, in US dollars. WEIGHT is per 10 pieces or as otherwise specified, in lbs.

EMAIL ORDERS TO SALES@THEBRONZE.COM

1311 and 1312



Solid Brass Cabinet Knob

Not Available In Distressed Finishes

Item	Dia	Proj	Tier 1 Finishes	Tier 2 Finishes	All Finishes	Wt/10
1311	1 1/4	1 3/16	N/A	N/A	\$24.12	1.8
1312	1 1/2	1 3/16	N/A	N/A	\$27.38	2.5

Split finish item: Specify finishes as knob by insert.

1330



Solid Brass Cabinet Handle

Not Available In Distressed Finishes

Item	Face	Proj	Overall	Tier 1 Finishes	Tier 2 Finishes	All Finishes	Wt/10
1330	1/4	1 1/8	1 7/8	N/A	N/A	\$24.43	1.8

Split finish item: Specify finishes as post by insert

1331



Solid Brass Cabinet Handle

Not Available In Distressed Finishes

Item	Face	Proj	Overall	Tier 1 Finishes	Tier 2 Finishes	All Finishes	Wt/10
1331	3/8	1 1/8	1 7/8	N/A	N/A	\$24.43	1.8

Split finish item: Specify finishes as post by insert.

1332



Solid Brass Cabinet Handle

Not Available In Distressed Finishes

Item	C-C	Proj	Overall	Tier 1 Finishes	Tier 2 Finishes	All Finishes	Wt/10
1332	3 1/2	1 1/8	4 1/4	N/A	N/A	\$42.14	3.7
1332	Custom per inch - see page 73 for details					\$11.37	

Split finish item: Specify finishes as post by bar.

1333



Solid Brass Cabinet Handle

Not Available In Distressed Finishes

Item	C-C	Proj	Overall	Tier 1 Finishes	Tier 2 Finishes	All Finishes	Wt/10
1333	3 1/2	1 1/8	4 1/4	N/A	N/A	\$42.14	3.7
1333	Custom per inch - see page 73 for details					\$11.37	

Split finish item: Specify finishes as post by bar.

1334



Solid Brass Cabinet Handle

Not Available In Distressed Finishes

Item	C-C	Proj	Overall	Tier 1 Finishes	Tier 2 Finishes	All Finishes	Wt/10
1334	3 1/2	1 1/8	4 3/4	N/A	N/A	\$42.14	3.7
1334	Custom per inch - see page 73 for details					\$11.37	

Split finish item: Specify finishes as post by bar.

1335



Solid Brass Cabinet Handle

Not Available In Distressed Finishes

Item	C-C	Proj	Overall	Tier 1 Finishes	Tier 2 Finishes	All Finishes	Wt/10
1335	3 1/2	1 1/8	4 3/4	N/A	N/A	\$42.14	3.7
1335	Custom per inch - see page 73 for details					\$11.37	

Split finish item: Specify finishes as post by bar. Custom centers and lengths are available.

1336



Solid Brass Cabinet Handle

Not Available In Distressed Finishes

Item	C-C	Proj	Overall	Tier 1 Finishes	Tier 2 Finishes	All Finishes	Wt/10
1336	3	1 1/8	3 3/4	N/A	N/A	\$42.14	3.5
1336	Custom per inch - see page 73 for details					\$11.37	

Split finish item: Specify finishes as post by bar.

1337



Solid Brass Cabinet Handle

Not Available In Distressed Finishes

Item	C-C	Proj	Overall	Tier 1 Finishes	Tier 2 Finishes	All Finishes	Wt/10
1337	3	1 1/8	3 3/4	N/A	N/A	\$42.14	3.5
1337	Custom per inch - see page 73 for details					\$11.37	

Split finish item: Specify finishes as post by bar.

LIST PRICE is per item or as otherwise specified, in US dollars. WEIGHT is per 10 pieces or as otherwise specified, in lbs.

EMAIL ORDERS TO SALES@THEBRONZE.COM



1338



Solid Brass Cabinet Handle

Not Available In Distressed Finishes

Item	C-C	Proj	Overall	Tier 1 Finishes	Tier 2 Finishes	All Finishes	Wt/10
1338	3	1 1/8	4 1/4	N/A	N/A	\$42.14	3.5
1338	Custom per inch - see page 73 for details					\$11.37	

Split finish item: Specify finishes as post by bar.

1339



Solid Brass Cabinet Handle

Not Available In Distressed Finishes

Item	C-C	Proj	Overall	Tier 1 Finishes	Tier 2 Finishes	All Finishes	Wt/10
1339	3	1 1/8	4 1/4	N/A	N/A	\$42.14	3.5
1339	Custom per inch - see page 73 for details					\$11.37	

Split finish item: Specify finishes as post by bar.

1345 - 1347



Solid Brass Cabinet Handle

Split finish item: Specify finishes as post by bar.

1345 and 1346 are available in several mountings. Refer to page 70 and specify mounting as surface (S), through-bolt (T), or back-to-back (BxB). Extra charges apply for BxB - see page 71.

Item	Dia.	C-C	Proj	Overall	Tier 1 Finishes	Tier 2 Finishes	All Finishes	Wt/10
1345-10*	1	10	2 1/8	12	N/A	N/A	\$272.69	3.3
1345	Custom per inch - see page 73 for details				N/A	N/A	\$25.99	
1346-6*	3/4	6	1 5/8	7	N/A	N/A	\$114.00	.82
1346	Custom per inch - see page 73 for details				N/A	N/A	\$19.09	
1347-4	5/8	4	1 1/4	5	N/A	N/A	\$79.86	.41
1347-6	5/8	6	1 1/4	7	N/A	N/A	\$111.8	.53
1347	Custom per inch - see page 73 for details				N/A	N/A	\$17.42	

1384



Solid Brass Cabinet Knob

Item	Dia	Proj	Tier 1 Finishes	Tier 2 Finishes	Tier 3 Finishes	Wt/10
1384	1 1/4	1	\$25.43	\$31.14	\$31.85	1.3

1386 and 1387



Solid Brass Cabinet Knob

Not Available In Distressed Finishes

Item	Dia	Proj	Tier 1 Finishes	Tier 2 Finishes	All Finishes	Wt/10
1386	1	1	N/A	N/A	\$22.52	2.5
1387	1 1/4	1 1/4	N/A	N/A	\$29.30	4.7

Split finish item: Specify finishes as knob by bar.

1442 - 1448



Solid Brass Cabinet Handle

Split finish item: Specify finishes as post by bar.

1442 and 1446 are available in several mountings. Refer to page 70 and specify mounting as surface (S), through-bolt (T), or back-to-back (BxB). Extra charges apply for BxB - see page 71.

Item	Dia.	C-C	Proj	Overall	Tier 1 Finishes	Tier 2 Finishes	All Finishes	Wt/ez
1442-8	1	8	2 1/8	9 1/2	N/A	N/A	\$260.63	2.8
1442	Custom per inch - see page 73 for details				N/A	N/A	\$28.44	
1446-8	3/4	8	1 5/8	9	N/A	N/A	\$146.57	1.3
1446	Custom per inch - see page 73 for details				N/A	N/A	\$19.09	
1447-4	5/8	4	1 1/4	5	N/A	N/A	\$80.82	.57
1447-6	5/8	6	1 1/4	7	N/A	N/A	\$111.8	.75
1447	Custom per inch - see page 73 for details				N/A	N/A	\$17.42	
1448-6	1/2	6	1 3/16	6 3/4	N/A	N/A	\$93.17	.43
1448	Custom per inch - see page 73 for details				N/A	N/A	\$14.52	

LIST PRICE is per item or as otherwise specified, in US dollars. WEIGHT is per 10 pieces or as otherwise specified, in lbs.

EMAIL ORDERS TO SALES@THEBRONZE.COM

1920 and 1930



Solid Brass Cabinet Knob

Item	Dia	Proj	Tier 1 Finishes	Tier 2 Finishes	Tier 3 Finishes	Wt/10
1920	1 1/4	1 1/8	\$17.71	\$21.69	\$22.20	2.3
1930	1 1/2	1 1/4	\$25.87	\$31.66	\$32.38	3.8

3004



Solid Brass Robe Hook

Item	Dia	Post	Proj	Tier 1 Finishes	Tier 2 Finishes	All Finishes	Wt/ea
3004	1	1	3	N/A	N/A	\$77.04	0.5

Supplied with 1-1/2 in. rose.

3013



Solid Brass Robe Hook

Item	Post	Proj	Tier 1 Finishes	Tier 2 Finishes	All Finishes	Wt/ea
3013	3/4 X 1	3	N/A	N/A	\$105.49	0.5

Supplied with 1-1/2 x 2 in. rose.

3015



Solid Brass Paper Holder

Item	Post	Proj	Tier 1 Finishes	Tier 2 Finishes	All Finishes	Wt/ea
3015	3/4 X 1	4	N/A	N/A	\$288.83	1.9

Split finish item: Specify finishes as posts by roll. Supplied with 1-1/2 x 2 in. rose.

3016



Solid Brass Paper Holder (shown right handed)

Item	Post	Proj	Tier 1 Finishes	Tier 2 Finishes	All Finishes	Wt/ea
3016 LH	3/4 X 1	3	N/A	N/A	\$247.24	1.0
3016 RH	3/4 X 1	3	N/A	N/A	\$247.24	1.0

Split finish item: Specify finishes as posts by arm. Supplied with 1-1/2 x 2 in. rose. LH=Left-Handed, RH=Right-handed

3017



Solid Brass Paper Holder

Item	Dia	Post	Proj	Tier 1 Finishes	Tier 2 Finishes	All Finishes	Wt/ea
3017	1	1	4 1/4	N/A	N/A	\$216.66	1.9

3018



Solid Brass Paper Holder (shown right handed)

Item	Dia	Post	Proj	Tier 1 Finishes	Tier 2 Finishes	All Finishes	Wt/ea
3018 LH	1	1	3	N/A	N/A	\$187.76	1.0
3018 RH	1	1	3	N/A	N/A	\$187.76	1.0

Split finish item: Specify finishes as posts by arm. Supplied with 1-1/2 x 2 in. rose. LH=Left-Handed, RH=Right-handed

3019



Solid Brass Paper Holder

Item	Dia	Post	Proj	Tier 1 Finishes	Tier 2 Finishes	All Finishes	Wt/ea
3019	1	1	4 1/4	N/A	N/A	\$302.59	1.9

Split finish item: Specify finishes as posts by insert. Supplied with 1-1/2 in. rose.

LIST PRICE is per item or as otherwise specified, in US dollars. WEIGHT is per 10 pieces or as otherwise specified, in lbs.

EMAIL ORDERS TO SALES@THEBRONZE.COM



6001 Series Solid Brass "Square Deco" Switchplates



SAMPLE: 6001 - 1G Solid Brass "Square Deco" Switchplate

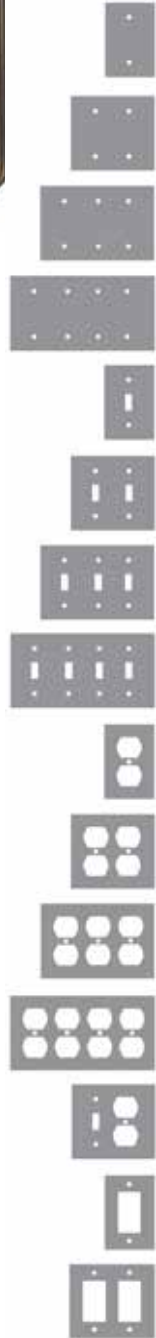

Custom Switchplates Available

Mix any of these standard configurations to create a custom switchplate up to a four-gang.

Call Customer Service for pricing

Item	Configuration	Size (W x H)	Tier 1 Finishes	Tier 2 Finishes	Tier 3 Finishes	Wt/10
6001 1B	Single Blank Cover	3 7/32 x 5 7/32	\$23.90	\$28.34	\$29.02	2.7
6001 2B	Double Blank Cover	4 15/16 x 5 3/32	\$29.24	\$34.71	\$35.51	6
6001 3B	Triple Blank Cover	6 11/32 x 4 19/32	\$50.70	\$60.21	\$61.61	7.7
6001 4B	Quad Blank Cover	8 3/16 x 4 19/32	\$64.00	\$75.98	\$77.73	12.3
6001 1T	Single Toggle	3 7/32 x 5 7/32	\$31.23	\$37.04	\$37.91	2.7
6001 2T	Double Toggle	4 15/16 x 5 3/32	\$39.56	\$46.97	\$48.07	6.4
6001 3T	Triple Toggle	6 11/32 x 4 19/32	\$50.70	\$60.21	\$61.61	7.8
6001 4T	Quad Toggle	8 3/16 x 4 19/32	\$64.00	\$75.98	\$77.73	11.7
6001 1D	Single Duplex	3 7/32 x 5 3/16	\$27.86	\$33.13	\$33.90	2.6
6001 2D	Double Duplex	4 15/16 x 5 3/32	\$36.52	\$43.35	\$44.36	4.7
6001 3D	Triple Duplex	6 11/32 x 4 19/32	\$61.34	\$72.83	\$74.54	5.2
6001 4D	Quad Duplex	8 3/16 x 4 19/32	\$69.56	\$82.62	\$84.55	5.7
6001 1T1D	Combo Toggle/Duplex	4 15/16 x 5 3/32	\$38.61	\$45.87	\$46.95	4.9
6001 1G	Single GFI/Decora	3 7/32 x 5 7/32	\$31.23	\$37.04	\$37.91	2.7
6001 2G	Double GFI/Decora	4 15/16 x 5 3/32	\$39.56	\$46.97	\$48.07	5.4

All dimensions are approximate

6001 Series Solid Brass "Square Deco" Switchplates



SAMPLE: 6001 1T
Solid Brass "Square Deco" Switchplate

**Custom
Switchplates
Available**

Mix any of these standard configurations to create a custom switchplate up to a four-gang.

Call Customer Service for pricing



Item	Configuration	Size (W x H)	Tier 1 Finishes	Tier 2 Finishes	Tier 3 Finishes	Wt/10
6001 3G	Triple GFI/Decora	6 11/32 x 4 19/32	\$50.70	\$60.21	\$61.61	5.7
6001 4G	Quad GFI/Decora	8 3/16 x 4 19/32	\$64.00	\$75.98	\$77.73	5.9
6001 1G1T	Combo GFI/Toggle	4 15/16 x 5 3/32	\$38.61	\$45.87	\$46.95	4.9
6001 1G1D	Combo GFI/Duplex	4 15/16 x 5 3/32	\$38.61	\$45.87	\$46.95	4.8
6001 1C	Cable Jack Screws: 2 3/8 in. on center	3 7/32 x 5 7/32	\$31.89	\$37.85	\$38.73	3.6
6001 1PJ	Phone Jack Screws: 2 3/8 in. on center	3 7/32 x 5 7/32	\$34.52	\$41.00	\$41.94	3.5
6001 1NC	Cable Jack Screws: 3 1/4 in. on center	3 7/32 x 5 7/32	\$31.89	\$37.85	\$38.73	3.9
6001 1NPJ	Phone Jack Screws: 3 1/4 in. on center	3 7/32 x 5 7/32	\$34.52	\$41.00	\$41.94	3.9

All dimensions are approximate

6005 Series Solid Brass "Colonial" Switchplates



SAMPLE: 6005 2T Solid Brass "Colonial" Switchplate



Item	Configuration	Size (W x H)	Tier 1 Finishes	Tier 2 Finishes	Tier 3 Finishes	Wt/10
6005 1B	Single Blank Cover	3 3/32 x 5 1/4	\$25.20	\$29.93	\$30.61	2.2
6005 2B	Double Blank Cover	4 15/16 x 5 1/4	\$30.82	\$36.56	\$37.40	6.8
6005 3B	Triple Blank Cover	6 3/8 x 5 3/16	\$44.84	\$53.22	\$54.44	7.7
6005 4B	Quad Blank Cover	8 7/32 x 5 5/32	\$56.01	\$66.52	\$68.07	10.3
6005 1T	Single Toggle	3 3/32 x 5 1/4	\$32.90	\$39.08	\$39.97	2.9

All dimensions are approximate



6005 Series Solid Brass "Colonial" Switchplates



SAMPLE: 6005 2T
Solid Brass "Colonial" Switchplate

Custom Switchplates Available

Mix any of these standard configurations to create a custom switchplate up to a four-gang.

Call Customer Service for pricing



Item	Configuration	Size (W x H)	Tier 1 Finishes	Tier 2 Finishes	Tier 3 Finishes	Wt/10
6005 2T	Double Toggle	4 15/16 x 5 1/4	\$41.71	\$49.56	\$50.70	5.1
6005 3T	Triple Toggle	6 3/8 x 5 3/16	\$51.79	\$61.49	\$62.94	7
6005 4T	Quad Toggle	8 7/32 x 5 5/32	\$58.10	\$70.43	\$72.08	12.5
6005 1D	Single Duplex	3 3/32 x 5 3/16	\$29.40	\$34.92	\$35.76	2
6005 2D	Double Duplex	4 15/16 x 5 1/4	\$38.50	\$45.73	\$46.78	6.5
6005 3D	Triple Duplex	6 3/8 x 5 3/16	\$64.69	\$76.80	\$78.58	6.6
6005 4D	Quad Duplex	8 7/32 x 5 5/32	\$73.34	\$87.09	\$89.13	6.7
6005 1T1D	Combo Toggle/Duplex	4 15/16 x 5 1/4	\$40.80	\$48.43	\$49.57	4.5
6005 1G	Single GFI/Decora	3 3/32 x 5 1/4	\$32.90	\$39.08	\$39.97	1.8
6005 2G	Double GFI/Decora	4 15/16 x 5 1/4	\$41.71	\$49.56	\$50.70	4.2
6005 3G	Triple GFI/Decora	6 3/8 x 5 3/16	\$51.79	\$61.49	\$62.94	7.7
6005 4G	Quad GFI/Decora	8 7/32 x 5 5/32	\$58.10	\$69.05	\$70.65	8.1
6005 1G1T	Combo GFI/Toggle	4 15/16 x 5 1/4	\$40.80	\$48.43	\$49.57	4.6
6005 1G1D	Combo GFI/Duplex	4 15/16 x 5 1/4	\$40.80	\$48.43	\$49.57	4.5
6005 1C	Cable Jack <i>Screws: 2 3/8 in. on center</i>	3 3/32 x 5 1/4	\$33.59	\$39.91	\$40.85	2.8
6005 1PJ	Phone Jack <i>Screws: 2 3/8 in. on center</i>	3 3/32 x 5 1/4	\$36.39	\$43.22	\$44.23	2.5
6005 1NC	Cable Jack <i>Screws: 3 1/4 in. on center</i>	3 3/32 x 5 1/4	\$33.59	\$39.91	\$40.85	2.9
6005 1NPJ	Phone Jack <i>Screws: 3 1/4 in. on center</i>	3 3/32 x 5 1/4	\$36.39	\$43.22	\$44.23	3.4

All dimensions are approximate

LIST PRICE is per item or as otherwise specified, in US dollars. WEIGHT is per 10 pieces or as otherwise specified, in lbs.

EMAIL ORDERS TO SALES@THEBRONZE.COM

6006 Series Solid Brass "Arlington" Switchplates



SAMPLE: 6006 2G
Solid Brass "Arlington" Switchplate

Item	Configuration	Size (W x H)	Tier 1 Finishes	Tier 2 Finishes	Tier 3 Finishes	Wt/10
6006 1B	Single Blank Cover	3 7/32 x 4 15/16	\$31.53	\$37.40	\$38.28	4.0
6006 2B	Double Blank Cover	5 3/32 x 5 3/32	\$38.50	\$45.73	\$46.78	6.8
6006 3B	Triple Blank Cover	6 13/16 x 5 5/32	\$56.01	\$66.52	\$68.07	10.5
6006 4B	Quad Blank Cover	8 5/8 x 5 1/8	\$69.98	\$83.15	\$85.07	17.9
6006 1T	Single Toggle	3 7/32 x 4 15/16	\$41.12	\$48.84	\$49.96	4.0
6006 2T	Double Toggle	5 3/32 x 5 3/32	\$52.14	\$61.91	\$63.35	7.0
6006 3T	Triple Toggle	6 13/16 x 5 5/32	\$64.76	\$76.90	\$78.66	9.6
6006 4T	Quad Toggle	8 5/8 x 5 1/8	\$72.67	\$86.28	\$88.30	16.6
6006 1D	Single Duplex	3 7/32 x 4 15/16	\$36.77	\$43.65	\$44.67	3.5
6006 2D	Double Duplex	5 3/32 x 5 3/32	\$48.14	\$57.15	\$58.48	5.8

All dimensions are approximate

Quality, hand-finished hardware for three generations



1940's



1950's

LIST PRICE is per item or as otherwise specified, in US dollars. WEIGHT is per 10 pieces or as otherwise specified, in lbs.

EMAIL ORDERS TO SALES@THEBRONZE.COM



6006 Series Solid Brass "Arlington" Switchplates



SAMPLE: 6006 1D 1T
Solid Brass "Arlington" Switchplate

Custom Switchplates Available

Mix any of these standard configurations to create a custom switchplate up to a four-gang.

Call Customer Service for pricing

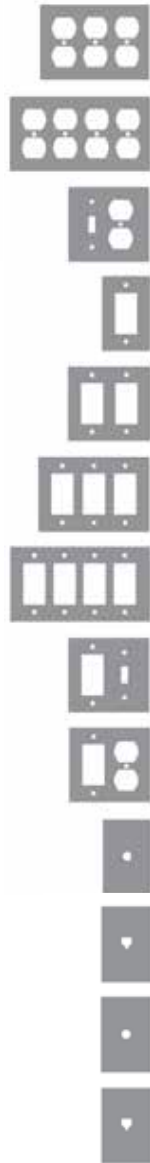

Item	Configuration	Size (W x H)	Tier 1 Finishes	Tier 2 Finishes	Tier 3 Finishes	Wt/10
6006 3D	Triple Duplex	6 ¹³ / ₁₆ X 5 ⁵ / ₃₂	\$80.84	\$96.00	\$98.24	11.1
6006 4D	Quad Duplex	8 ⁵ / ₈ X 5 ¹ / ₈	\$91.69	\$108.88	\$111.42	17.4
6006 1T1D	Combo Toggle/Duplex	5 ³ / ₃₂ X 5 ³ / ₃₂	\$51.02	\$60.59	\$61.99	8.5
6006 1G	Single GFI/Decora	3 ⁷ / ₃₂ X 4 ¹⁵ / ₁₆	\$41.12	\$48.84	\$49.96	3.2
6006 2G	Double GFI/Decora	5 ³ / ₃₂ X 5 ³ / ₃₂	\$52.14	\$61.91	\$63.35	5.0
6006 3G	Triple GFI/Decora	6 ¹³ / ₁₆ X 5 ⁵ / ₃₂	\$64.76	\$76.90	\$78.66	7.4
6006 4G	Quad GFI/Decora	8 ⁵ / ₈ X 5 ¹ / ₈	\$72.67	\$86.28	\$88.30	12.0
6006 1G1T	Combo GFI/Toggle	5 ³ / ₃₂ X 5 ³ / ₃₂	\$51.02	\$60.59	\$61.99	6.1
6006 1G1D	Combo GFI/Duplex	5 ³ / ₃₂ X 5 ³ / ₃₂	\$51.02	\$60.59	\$61.99	6.0
6006 1C	Cable Jack <i>Screws: 2 3/8 in. on center</i>	3 ⁷ / ₃₂ X 4 ¹⁵ / ₁₆	\$31.90	\$37.85	\$38.73	4.0
6006 1PJ	Phone Jack <i>Screws: 2 3/8 in. on center</i>	3 ⁷ / ₃₂ X 4 ¹⁵ / ₁₆	\$34.52	\$41.00	\$41.94	4.0
6006 1NC	Cable Jack <i>Screws: 3 1/4 in. on center</i>	3 ⁷ / ₃₂ X 4 ¹⁵ / ₁₆	\$31.90	\$37.85	\$38.73	3.7
6006 1NPJ	Phone Jack <i>Screws: 3 1/4 in. on center</i>	3 ⁷ / ₃₂ X 4 ¹⁵ / ₁₆	\$34.52	\$41.00	\$41.94	3.9

All dimensions are approximate

6008 Series Solid Brass "Square Bevel" Switchplates



SAMPLE: 6008 1G
Solid Brass "Square Bevel" Switchplate

**Custom
Switchplates
Available**

Mix any of these standard configurations to create a custom switchplate up to a four-gang.

Call Customer Service for pricing

Item	Configuration	Size (W x H)	Tier 1 Finishes	Tier 2 Finishes	Tier 3 Finishes	Wt/10
6008 1B	Single Blank Cover	2 7/8 x 4 5/8	\$21.73	\$25.81	\$26.40	2.9
6008 2B	Double Blank Cover	4 21/32 x 4 21/32	\$26.57	\$31.54	\$32.26	6.0
6008 3B	Triple Blank Cover	6 3/32 x 4 17/32	\$38.61	\$45.89	\$46.96	6.7
6008 4B	Quad Blank Cover	8 1/8 x 4 9/16	\$48.28	\$57.37	\$58.71	6.9
6008 1T	Single Toggle	2 7/8 x 4 5/8	\$28.36	\$33.68	\$34.49	2.6
6008 2T	Double Toggle	4 21/32 x 4 21/32	\$35.97	\$42.71	\$43.69	3.2
6008 3T	Triple Toggle	6 3/32 x 4 17/32	\$44.67	\$53.02	\$54.27	6.3
6008 4T	Quad Toggle	8 1/8 x 4 9/16	\$53.00	\$61.31	\$64.24	6.4
6008 1D	Single Duplex	2 7/8 x 4 5/8	\$25.33	\$30.09	\$30.78	2.4
6008 2D	Double Duplex	4 21/32 x 4 21/32	\$33.22	\$39.41	\$40.34	3.0
6008 3D	Triple Duplex	6 3/32 x 4 17/32	\$55.76	\$66.20	\$67.75	4.5
6008 4D	Quad Duplex	8 1/8 x 4 9/16	\$63.23	\$75.09	\$76.81	4.6
6008 1T1D	Combo Toggle/Duplex	4 21/32 x 4 21/32	\$37.91	\$45.00	\$46.06	3.0
6008 1G	Single GFI/Decora	2 7/8 x 4 5/8	\$28.36	\$33.68	\$34.49	2.4
6008 2G	Double GFI/Decora	4 21/32 x 4 21/32	\$38.27	\$42.71	\$43.69	2.5

All dimensions are approximate



6008 Series Solid Brass "Square Bevel" Switchplates



SAMPLE: 6008 1T
Solid Brass "Square Bevel" Switchplate

**Custom
Switchplates
Available**

Mix any of these standard configurations to create a custom switchplate up to a four-gang.

Call Customer Service for pricing



Item	Configuration	Size (W x H)	Tier 1 Finishes	Tier 2 Finishes	Tier 3 Finishes	Wt/10
6008 3G	Triple GFI/Decora	6 3/32 x 4 17/32	\$44.67	\$53.02	\$54.27	4.4
6008 4G	Quad GFI/Decora	8 1/8 x 4 9/16	\$52.88	\$62.77	\$64.24	4.8
6008 1G1T	Combo GFI/Toggle	4 21/32 x 4 21/32	\$37.91	\$45.23	\$46.27	4.8
6008 1G1D	Combo GFI/Duplex	4 21/32 x 4 21/32	\$37.91	\$45.23	\$46.27	4.7
6008 1C	Cable Jack <i>Screws: 2 3/8 in. on center</i>	2 7/8 x 4 5/8	\$24.39	\$28.99	\$29.65	2.1
6008 1PJ	Phone Jack <i>Screws: 2 3/8 in. on center</i>	2 7/8 x 4 5/8	\$26.40	\$31.38	\$32.09	2.5
6008 1NC	Cable Jack <i>Screws: 3 1/4 in. on center</i>	2 7/8 x 4 5/8	\$24.39	\$28.99	\$29.65	2.3
6008 1NPJ	Phone Jack <i>Screws: 3 1/4 in. on center</i>	2 7/8 x 4 5/8	\$26.40	\$31.38	\$32.09	2.3

All dimensions are approximate

9150 to 9156 Cap Screws



Decorative Face Cap Screw

Item	Dia	Screw Size	Tier 1 Finishes	Tier 2 Finishes	Tier 3 Finishes	Wt/10
9150	3/4	1/4-20 x 1	\$13.32	\$15.73	\$16.10	0.6
9153	1	1/4-20 x 1	\$14.81	\$16.53	\$16.92	0.8
9154	1	8/32 x 3/4	\$13.32	\$15.73	\$16.10	0.8
9155	1 1/4	1/4-20 x 1	\$15.55	\$17.34	\$17.75	1.0
9156	3/4	8/32 x 3/4	\$13.32	\$15.73	\$16.10	0.6

If different screw length is required, please specify length of screw when ordering.

9160 to B9203 Roses



9160-9167

9202-9203

B9203

Roses (backplates) for architectural pulls, towel bars and Appliance Handles

Item	Dia	Thickness	Tier 1 Finishes	Tier 2 Finishes	Tier 3 Finishes	Wt/10
9160	3/4	1/8	\$8.81	\$12.34	\$12.63	0.1
9161	1	1/8	\$12.07	\$14.54	\$14.89	0.3
9162	1 1/4	1/8	\$12.19	\$14.67	\$15.03	0.5
9163	1 1/2	1/8	\$12.94	\$15.61	\$15.97	0.7
9166	5/8	1/8	\$6.08	\$7.35	\$7.54	0.1
9167 ¹	1	1/8	\$12.07	\$14.54	\$14.89	0.3
9168 ¹	5/8	1/8	\$6.08	\$7.35	\$7.54	0.1
9202	1 3/4	1/8	\$14.81	\$18.11	\$18.51	1.2
9203	1 1/2	3/16	\$12.94	\$15.61	\$15.97	0.8
B9203	1 1/2	3/16	\$14.59	\$17.61	\$18.02	0.8

All roses are drilled for 1/4-20 screw unless otherwise specified. ¹ Drilled for 8/32 screw.

LIST PRICE is per item or as otherwise specified, in US dollars. WEIGHT is per 10 pieces or as otherwise specified, in lbs.

EMAIL ORDERS TO SALES@THEBRONZE.COM

9420 to 9455



Solid Brass Backplate
Offset holes for 420-455 series on page 21

Item	Width	C-C	Overall	Proj	Tier 1 Finishes	Tier 2 Finishes	Tier 3 Finishes	Wt/10 in brass
9420	1	1	3	1/8	\$20.69	\$23.80	\$24.42	1.2
9425	1	1 1/2	3 1/2	1/8	\$24.52	\$28.18	\$28.92	1.5
9435	1	3	4 1/2	1/8	\$27.09	\$31.16	\$31.97	2.1
9445	1	3 1/2	5 1/2	1/8	\$30.42	\$34.98	\$35.90	2.7
9455	1	3 1/2	6 1/2	1/8	\$33.67	\$38.72	\$39.73	3.3

9620 to 9622



Solid Brass Stepped Backplate

Item	Dia	Proj	Tier 1 Finishes	Tier 2 Finishes	Tier 3 Finishes	Wt/10
9620	1 1/4	3/16	\$22.48	\$25.86	\$26.52	1.3
9621	1 1/2	3/16	\$26.05	\$29.96	\$30.73	1.8
9622	1 3/4	3/16	\$29.49	\$33.90	\$34.79	2.5

9623 to 9625



Solid Brass Stepped Backplate

Item	Dia	Proj	Tier 1 Finishes	Tier 2 Finishes	Tier 3 Finishes	Wt/10
9623	1 1/4	3/16	\$30.78	\$35.41	\$36.32	1.3
9624	1 1/2	3/16	\$34.85	\$40.06	\$41.12	1.8
9625	1 3/4	3/16	\$40.34	\$46.41	\$47.62	2.5

See 9945 for 1" Square Stepped backplate

9626 to 9628



Solid Brass Stepped Backplate

Item	Dia	Proj	Tier 1 Finishes	Tier 2 Finishes	Tier 3 Finishes	Wt/10
9626	1 1/4	3/16	\$30.78	\$35.41	\$38.94	1.3
9627	1 1/2	3/16	\$34.85	\$44.07	\$48.48	1.8
9628	1 3/4	3/16	\$40.36	\$46.41	\$51.04	2.5

9844



Solid Brass Flat Backplate

Item	Width	C-C	Overall	Proj	Tier 1 Finishes	Tier 2 Finishes	Tier 3 Finishes	Wt/ea
9844-8	1 1/2	8	9	3/16	\$65.10	\$74.87	\$77.11	1.9
9844-10	1 1/2	10	11	3/16	\$85.28	\$98.08	\$101.01	2.0
9844	Custom per inch - see page 73 for details				\$10.10	\$11.62	\$11.92	

1/4-20 screw holes.

9944



Solid Brass Stepped Backplate

Item	Width	C-C	Overall	Proj	Tier 1 Finishes	Tier 2 Finishes	Tier 3 Finishes	Wt/ea
9944-8	1 1/2	8	9	3/16	\$74.87	\$86.10	\$88.68	1.9
9944-10	1 1/2	10	11	3/16	\$98.08	\$112.78	\$116.17	2.0
9944	Custom per inch - see page 73 for details				\$11.62	\$13.38	\$13.71	

1/4-20 screw holes.

LIST PRICE is per item or as otherwise specified, in US dollars. WEIGHT is per 10 pieces or as otherwise specified, in lbs.

EMAIL ORDERS TO SALES@THEBRONZE.COM



9945



Solid Brass Stepped Backplate

Item	Dia	Proj	Tier 1 Finishes	Tier 2 Finishes	Tier 3 Finishes	Wt/10
9945	1 SQ	³ / ₁₆	\$18.15	\$20.88	\$21.42	.58

See 9623-9625 for additional sizes

9946



Solid Brass Flat Backplate

Item	Width	C-C	Overall	Proj	Tier 1 Finishes	Tier 2 Finishes	Tier 3 Finishes	Wt/10
9946-4	1	4	5	¹ / ₈	\$37.81	\$43.48	\$44.63	2.9
9946-6	1	6	7	¹ / ₈	\$41.21	\$47.39	\$48.62	4.0
9946-8	1	8	9	¹ / ₈	\$44.92	\$51.67	\$53.01	5.2
9946	Custom per inch - see page 73 for details				\$9.06	\$10.43	\$10.75	

9947



Solid Brass Flat Backplate with Decorative Screws

Item	Width	C-C	Overall	Proj	Tier 1 Finishes	Tier 2 Finishes	Tier 3 Finishes	Wt/10
9947-4	1	4	6	³ / ₁₆	\$47.87	\$54.92	\$56.49	3.5
9947-6	1	6	8	³ / ₁₆	\$51.23	\$58.92	\$60.46	4.6
9947-8	1	8	10	³ / ₁₆	\$55.57	\$63.91	\$65.58	5.8
9947	Custom per inch - see page 73 for details				\$9.57	\$11.01	\$11.34	

9948



Solid Brass Stepped Backplate

Item	Width	C-C	Overall	Proj	Tier 1 Finishes	Tier 2 Finishes	Tier 3 Finishes	Wt/10
9948-4	1 ¹ / ₄	4	5	¹ / ₈	\$40.24	\$46.27	\$47.48	3.6
9948-6	1 ¹ / ₄	6	7	¹ / ₈	\$43.63	\$50.17	\$51.47	5.0
9948-8	1 ¹ / ₄	8	9	¹ / ₈	\$47.34	\$54.45	\$55.87	6.5
9948	Custom per inch - see page 73 for details				\$9.57	\$11.10	\$11.34	

9949



Solid Brass Stepped Backplate with Decorative Screws

Item	Width	C-C	Overall	Proj	Tier 1 Finishes	Tier 2 Finishes	Tier 3 Finishes	Wt/10
9949-4	1 ¹ / ₄	4	6	³ / ₁₆	\$50.29	\$57.83	\$59.33	4.3
9949-6	1 ¹ / ₄	6	8	³ / ₁₆	\$53.65	\$61.70	\$63.31	5.8
9949-8	1 ¹ / ₄	8	10	³ / ₁₆	\$57.99	\$66.68	\$68.43	7.2
9949	Custom per inch - see page 73 for details				\$10.05	\$11.56	\$11.92	

9950 to 9953



Solid Brass Flat Backplate

Item	Dia	Proj	Tier 1 Finishes	Tier 2 Finishes	Tier 3 Finishes	Wt/10
9950	1	¹ / ₈	\$17.25	\$19.83	\$20.35	1.3
9951	1 ¹ / ₄	¹ / ₈	\$21.55	\$24.78	\$25.49	1.8
9952	1 ¹ / ₂	¹ / ₈	\$25.86	\$29.74	\$30.51	2.5
9953	1 ³ / ₄	¹ / ₈	\$30.42	\$34.74	\$35.90	1.2

LIST PRICE is per item or as otherwise specified, in US dollars. WEIGHT is per 10 pieces or as otherwise specified, in lbs.

EMAIL ORDERS TO SALES@THEBRONZE.COM

ER110 and SER110



Solid Brass Contemporary Style Pull-Out Garment Rod

Mounting Flange

Item	Rod Dia	Overall	Tier 1 Finishes	Tier 2 Finishes	Tier 3 Finishes	Wt/ea
ER110	1 ⁵ / ₃₂	11	\$129.93	\$150.35	\$153.82	1.2
SER110	1 ⁵ / ₃₂	11	\$129.93	\$150.35	\$153.82	

Call the factory for pricing on custom pull-out garment rods.

ER110 1.5" diameter mounting flange

SER110 1.25" diameter mounting flange for narrower stile

MH915



Available with ball (BT) or flat tip (FT) - shown with flat top finials

Solid Brass Mortised Cabinet Hinge

Item	Size	Tip	Tier 1 Finishes	Tier 2 Finishes	Tier 3 Finishes	Wt/pr
MH915BT	2 x 1 1/2	Ball	\$30.13	\$35.78	\$36.62	0.3
MH915FT	2 x 1 1/2	Flat	\$30.13	\$35.78	\$36.62	0.3

Priced per pair.

MH917



Available with ball (BT) or flat tip (FT) - shown with flat top finials

Solid Brass Mortised Cabinet Hinge

Item	Size	Tip	Tier 1 Finishes	Tier 2 Finishes	Tier 3 Finishes	Wt/pr
MH917BT	2 1/2 x 1 3/4	Ball	\$35.31	\$41.51	\$42.48	0.4
MH917FT	2 1/2 x 1 3/4	Flat	\$35.31	\$41.51	\$42.48	0.4

Priced per pair.

MH920



Available with ball (BT) or flat tip (FT) - shown with ball top finials

Solid Brass Mortised Cabinet Hinge

Item	Size	Tip	Tier 1 Finishes	Tier 2 Finishes	Tier 3 Finishes	Wt/pr
MH920BT	2 1/2 x 2	Ball	\$41.51	\$48.72	\$49.85	0.3
MH920FT	2 1/2 x 2	Flat	\$41.51	\$48.72	\$49.85	0.3

Priced per pair.

NMH925



Available with ball (BT) or flat tip (FT) - shown with ball top finials

Solid Brass Non-Mortised Cabinet Hinge

Item	Size	Tip	Tier 1 Finishes	Tier 2 Finishes	Tier 3 Finishes	Wt/pr
NMH925BT	2 1/2 x 7/8	Ball	\$35.94	\$39.39	\$40.30	0.25
NMH925FT	2 1/2 x 7/8	Flat	\$35.94	\$39.39	\$40.30	0.25

Priced per pair.



Leather Colors and Appearance - Please note

- Leather is a natural product and variations in the appearance of the leather are both normal and to be expected.
- If your customer is concerned about color variations, we can arrange for a sample cutting for approval, or CFA, of the leather selected. If a CFA is requested, we will warrant that the leather that will be delivered will match the CFA sent to you. Please advise us as to the item and quantity to be ordered so we can insure that we hold the necessary amount of material needed for the order.
- **If a CFA is NOT requested, the leather delivered will match the current die lot that we receive from Edelman Leather. We cannot be held responsible for variations, and such variations do not constitute a defect.**

How to Order Tanner's Craft®

In order for us to create our fine hand made leather accessories to your specifications, we need the following information:

- The item number of the style you would like.
- The length and center to center dimension, where appropriate.
- The metal finish you want (see page 5).
- The leather color you want (see pages 6-7).

If, for example, an L126 beveled knob is desired in Antique Brass with a Royal Hide Flame leather insert, the item number to order would be

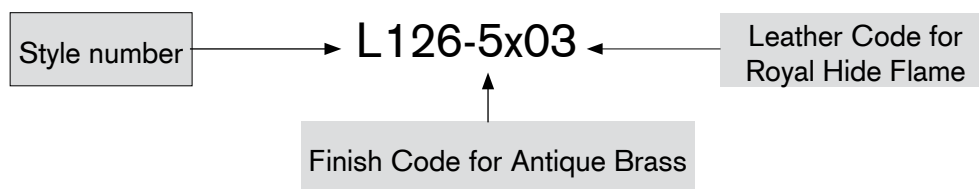

In some cases, a little more information may be required. For the following items, we will need you to tell us the type of mounting you would like - through bolt (typical) or surface mount (when you cannot access the back of the pull to screw it into place).

For example, if a surface mount is desired for the L232-8 pull, the item you would order is L232S-8; if a through bolt is desired, the item number you would order would be L232T-8.

LIST PRICE is per item or as otherwise specified, in US dollars. WEIGHT is per 10 pieces or as otherwise specified, in lbs.

EMAIL ORDERS TO SALES@THEBRONZE.COM

Below is an example of the correct ordering code for an L232 pull with through bolt mounting in polished nickel and Napoli Black Cherry leather.

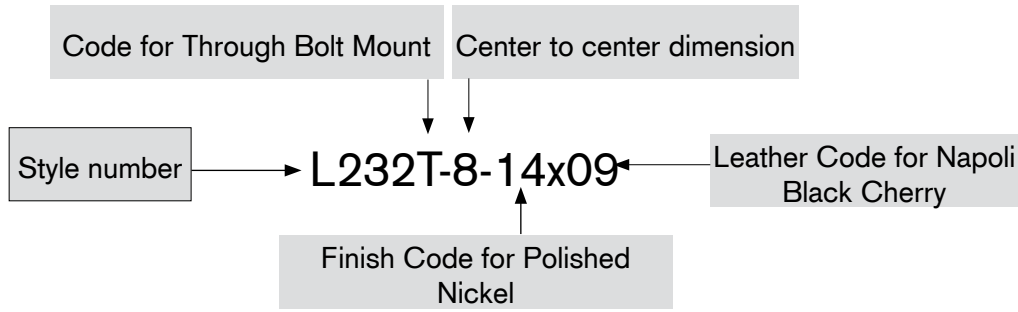

Items that can be through bolt mounted ONLY (no BxB mountings possible)

L247 series	L270 series	L271 series	L300 series	L312 series
L313 series	L460 series	L535 series	L536 series	L711 series
L827 series	L847 series	L1307 series	L1308 series	

Items that can be either through bolt or surface mounted (allows for BxB mounting)

L205 series	L232 series	L242 series	L243 series	L244 series	L246 series
L275 series	L276 series	L537 series	L538 series	L661 series	L828 series
L829 series	L842 series	L846 series	L861 series	L1309 series	L1310 series

Leather and Metal Finish Care

- Leather is not something that should be frequently cleaned. Leather will age with use and may darken over time.
- Leathers that incorporate Edelman’s patented Edge[®]  protection will have significantly greater resistance to stains and marks, without changing the true beauty of the leather.
- Leather can be cleaned with proper leather cleaner that helps preserve the hide’s natural oils as opposed to one that strips the natural oils off. While any suitable leather cleaner can be used, we recommend Edelman Leather’s Cleaner and Restorer.
- Always test the cleaner of your choice in an inconspicuous area to insure that it is compatible with your leather.
- Tanner’s Craft metal finishes are protected by Colonial Bronze’s exclusive Finishes for Life[®] guarantee. See page.
- The metal portion of any product protected by this guarantee will be free from tarnishing, flaking, or discoloration, subject to normal wear and tear, for the life of the product. If any product covered by the guarantee for these reasons, we will repair or replace it at our option.
- The Finishes for Life guarantee extends to interior use of the product only; exterior use of the product specifically is not guaranteed because of the effects of ultraviolet light.

LIST PRICE is per item or as otherwise specified, in US dollars. WEIGHT is per 10 pieces or as otherwise specified, in lbs.



*The asterisk indicates limited availability

Standard Leather Order Codes



China Black Gold 02*
(CH02)



Royal Hide Flame 03
(RH118)



Artisan Saddlebag 04
(ART04)

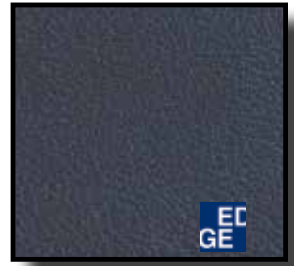

Metallic Dream Cow
Northstar 05 (MDC09)



Napoli Dark Green 06
(N04)



Napoli Black 08
(N07)



Napoli Black Cherry 09
(N15)



Napoli Pitch Brown 10
(N17)



Royal Hide Rum 11
(RH37)

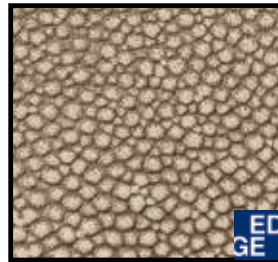

Shagreen Smokey 13
(SH94)



Wild Boar Natural 14*
(WB01)



Wild Boar Pitch Brown*
15 (WB11)



Woven Fudge 16
(WVN3)

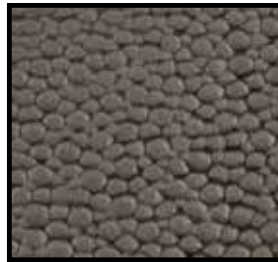

Shagreen City Lights
Smoke 19 (SH102CL)



Ostrich Grey Slate 20
(OS17)



Rattlesnake White 23
(R04)



Pinseal Seal Rock 24
(PNS03)

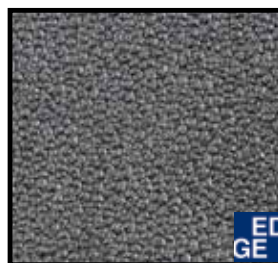

Pinseal Brushed Steel
28 (PNS04)

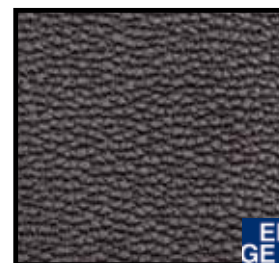

Pinseal Black Seal 31
(PNS07)

LIST PRICE is per item or as otherwise specified, in US dollars. WEIGHT is per 10 pieces or as otherwise specified, in lbs.

EMAIL ORDERS TO SALES@THEBRONZE.COM

Standard Leather Order Codes

*The asterisk indicates limited availability

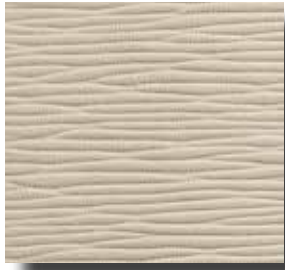

Sulky Antique White 32
(SLK27)

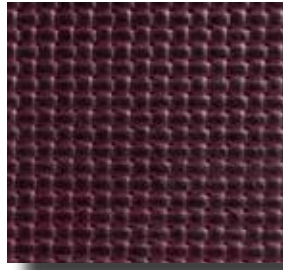

Woven Bitter Chocolate
33 (WVN6)



Royal Hide Dead White
34 (RH32)



Shagreen Gris Ligeró
36 (SH36)



Sulky Black 38
(SLK07)



Luster Leather Steel
Blue 40 (LL0010)



Shagreen Ink 43
(SH37)



Shagreen White 44
(SH17)

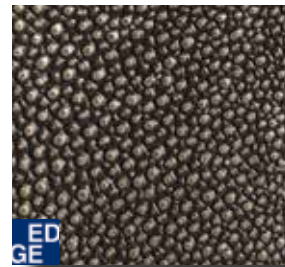

Shagreen Caviar 45
(SH04)

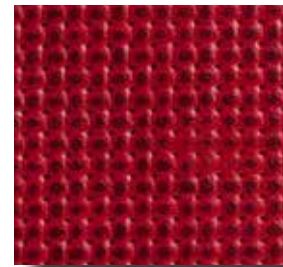

Woven Cherry
Royale 46 (WVN04)



Pinseal Pitch
Brown 47* (PNS06)



Worn Leather
Cappuccino 48 (WORN02)



Worn Leather Coal
Ash 49 (WORN03)



Luv-a-Bull Darkest
Blue 50 (LVB09)



Cashmere Calf
Dusky Pink 51
(CC82)

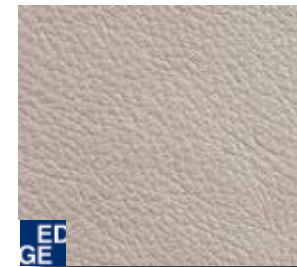

Royal Hide Mineral 52*
(RH493)



L111-L112



Item	Dia	Proj	All Leather and Finish Combinations	Wt/ea
L111	1 1/4	1 3/16	\$68.08	.15
L112	1 1/2	1 3/16	\$72.38	.21

L121-L122



Item	Dia	Proj	All Leather and Finish Combinations	Wt/ea
L121	1 1/4 SQ	1 3/16	\$72.38	.18
L122	1 1/2 SQ	1 3/16	\$76.88	.25

L126-L127



Item	Dia	Proj	All Leather and Finish Combinations	Wt/ea
L126	1 1/4 SQ	1 3/16	\$86.70	.14
L127	1 1/2 SQ	1 3/16	\$89.42	.24

L205



Item	Dia	C-C	OA	Proj	All Leather and Finish Combinations	Wt/ea
L205-6	1/2	6	6 1/2	1 3/4	\$156.75	.5
L205-8	1/2	8	8 1/2	1 3/4	\$175.32	.62
L205	Custom per inch - see page 73 for details				\$24.95	

The L205 is available in several mountings. Refer to page 70 and specify mounting as surface (S), through-bolt (T), or back-to-back (BxB). Extra charges apply for BxB - see page 71.

L232



Item	Dia	C-C	OA	Proj	All Leather and Finish Combinations	Wt/ea
L232-8	3/4	8	8 3/4	2 1/2	\$279.51	1.6
L232-10	3/4	10	10 3/4	2 1/2	\$349.39	1.8
L232	Custom per inch - see page 73 for details				\$39.78	

The L232 is available in several mountings. Refer to page 70 and specify mounting as surface (S), through-bolt (T), or back-to-back (BxB). Extra charges apply for BxB - see page 71.

L242



Item	Dia	C-C	OA	Proj	All Leather and Finish Combinations	Wt/ea
L242-8	1	8	9 1/4	2 1/8	\$374.50	1.2
L242-10	1	10	11 1/4	2 1/8	\$446.30	1.3
L242	Custom per inch - see page 73 for details				\$46.09	

The L242 is available in several mountings. Refer to page 70 and specify mounting as surface (S), through-bolt (T), or back-to-back (BxB). Extra charges apply for BxB - see page 71.

LIST PRICE is per item or as otherwise specified, in US dollars. WEIGHT is per 10 pieces or as otherwise specified, in lbs.

EMAIL ORDERS TO SALES@THEBRONZE.COM

L243



Item	Dia	C-C	OA	Proj	All Leather and Finish Combinations	Wt/ea
L243-20	1 1/4	20	24	2 1/2	\$1,187.02	5.8
L243	Custom per inch - see page 73 for details				\$64.70	



The L243 is available in several mountings. Refer to page 70 and specify mounting as surface (S), through-bolt (T), or back-to-back (BxB). Extra charges apply for BxB - see page 71.

L244



Item	Dia	C-C	OA	Proj	All Leather and Finish Combinations	Wt/ea
L244-20	1 1/4	20	24	2 1/2	\$1,236.70	4.9
L244	Custom per inch - see page 73 for details				\$65.46	

The L244 is available in several mountings. Refer to page 70 and specify mounting as surface (S), through-bolt (T), or back-to-back (BxB). Extra charges apply for BxB - see page 71.

L246



Item	Dia	C-C	OA	Proj	All Leather and Finish Combinations	Wt/ea
L246-6	3/4	6	7	1 5/8	\$244.54	.49
L246	Custom per inch - see page 73 for details				\$39.78	

The L246 is available in several mountings. Refer to page 70 and specify mounting as surface (S), through-bolt (T), or back-to-back (BxB). Extra charges apply for BxB - see page 71.

L247



Item	Dia	C-C	OA	Proj	All Leather and Finish Combinations	Wt/ea
L247-5	5/8	5	6	1 1/4	\$179.76	.32
L247	Custom per inch - see page 73 for details				\$34.09	

L270



Item	Dia	C-C	OA	Proj	All Leather and Finish Combinations	Wt/ea
L270-4	3/8" x 3/4"	4	5	1 1/4	\$98.56	.37
L270-6	3/8" x 3/4"	6	8	1 1/4	\$168.27	.51
L270	Custom per inch - see page 73 for details*				\$22.45	

Please note that custom lengths may incur a cutting die charge. See page 72 for details



L271



Item	Dia	C-C	OA	Proj	All Leather and Finish Combinations	Wt/ea
L271-6	1/2" x 3/4"	6	8	1 3/8	\$200.40	.78
L271-8	1/2" x 3/4"	8	10	1 3/8	\$273.49	.98
L271	Custom per inch - see page 73 for details				\$28.52	

Please note that custom lengths may incur a cutting die charge. See page 72 for details

L272



Item	Dia	C-C	OA	Proj	All Leather and Finish Combinations	Wt/ea
L272-4	3/8" x 3/4"	4	5	1 1/8	\$98.56	.37
L272-6	3/8" x 3/4"	6	8	1 1/8	\$168.27	.51
L272	Custom per inch - see page 73 for details				\$22.45	

Please note that custom lengths may incur a cutting die charge. See page 72 for details

L273



Item	Dia	C-C	OA	Proj	All Leather and Finish Combinations	Wt/ea
L273-6	1/2" x 3/4"	6	8	1 3/8	\$200.40	.78
L273-8	1/2" x 3/4"	8	10	1 3/8	\$273.49	.98
L273	Custom per inch - see page 73 for details				\$28.52	

Please note that custom lengths may incur a cutting die charge. See page 72 for details

L275



Item	Dia	C-C	OA	Proj	All Leather and Finish Combinations	Wt/ea
L275-10	1 1/4" x 1/2"	10	12		\$396.07	2.2
L275	Custom per inch - see page 73 for details				\$45.09	

Please note that custom lengths may incur a cutting die charge. See page 72 for details

The L275 is available in several mountings. Refer to page 70 and specify mounting as surface (S), through-bolt (T), or back-to-back (BxB). Extra charges apply for BxB - see page 71.

L276



Item	Dia	C-C	OA	Proj	All Leather and Finish Combinations	Wt/ea
L276-10	1 1/4" x 1/2"	10	12		\$396.07	
L276	Custom per inch - see page 73 for details				\$45.09	

Please note that custom lengths may incur a cutting die charge. See page 72 for details

The L276 is available in several mountings. Refer to page 70 and specify mounting as surface (S), through-bolt (T), or back-to-back (BxB). Extra charges apply for BxB - see page 71.

L300



Item	Dia	C-C	OA	Proj	All Leather and Finish Combinations	Wt/ea
L300-4	1/2"	4	4 3/4	1 3/16	\$111.33	2.2
L300-6	1/2"	6	6 3/4	1 3/16	\$148.69	2.3
L300	Custom per inch - see page 73 for details				\$25.31	

LIST PRICE is per item or as otherwise specified, in US dollars. WEIGHT is per 10 pieces or as otherwise specified, in lbs.

EMAIL ORDERS TO SALES@THEBRONZE.COM

L312 - L313



Item	Dia	C-C	OA	Proj	All Leather and Finish Combinations	Wt/ea
L312-4	7/16"	4	5	1 1/4	\$131.59	.31
L312	Custom per inch - see page 73 for details				\$32.68	
L313-6	5/8"	6	7	1 1/2	\$198.40	.74
L313	Custom per inch - see page 73 for details				\$35.19	

L378



Item	Dia	C-C	OA	Proj	All Leather and Finish Combinations	Wt/ea
L378	1 1/4"	NA	NA	1"	\$77.73	.31

L403



Item	Size	C-C	OA	Proj	All Leather and Finish Combinations	Wt/ea
L403	4" x 1 5/8"	3 1/2	4	7/8	\$117.41	.29

L404



Item	Size	C-C	OA	Proj	All Leather and Finish Combinations	Wt/ea
L404	3 7/16" x 1 11/16"	3	3 7/16	1"	\$127.53	.25

L405



Item	Size	C-C	OA	Proj	All Leather and Finish Combinations	Wt/ea
L405	4 3/4" x 1 3/8"	3	4 3/4	1	\$135.63	.24

L435 and 455



Item	Dia	C-C	OA	Proj	All Leather and Finish Combinations	Wt/ea
L435	7/8" x 3 1/2"	3	3 1/2	1	\$127.84	.21
L455	7/8" x 5 1/2"	3 1/2	5 1/2	1	\$136.41	.33

LIST PRICE is per item or as otherwise specified, in US dollars. WEIGHT is per 10 pieces or as otherwise specified, in lbs.

EMAIL ORDERS TO SALES@THEBRONZE.COM



L460



Item	Dia	C-C	OA	Proj	All Leather and Finish Combinations	Wt/ea
L460-2	1 1/4 x 3	2	3	3/4	\$102.50	.3
L460-4	1 1/4 x 5	4	5	3/4	\$149.71	.5
L460	Custom per inch - see page 73 for details				\$33.95	

The L460 Series uses a 6-32 screw

Please note that custom lengths may incur a cutting die charge. See page 72 for details

L511-L512



Item	Dia	Proj	All Leather and Finish Combinations	Wt/ea
L511	1 1/4	1 3/16	\$68.08	.17
L512	1 1/2	1 3/16	\$72.38	.2

L521 - L522



Item	Dia	Proj	All Leather and Finish Combinations	Wt/ea
L521	1 1/4 SQ	1 3/16	\$72.48	.18
L522	1 1/2 SQ	1 3/16	\$76.88	.2

L535 - L538



Item	Dia	C-C	OA	Proj	All Leather and Finish Combinations	Wt/ea
L535-4	1/2"	4	5 1/2		\$131.59	.37
L535	Custom per inch - see page 73 for details				\$29.96	
L536-6	5/8"	6	8		\$198.40	.3
L536	Custom per inch - see page 73 for details				\$34.09	
L537-8	3/4"	8	10 1/4		\$348.93	1.3
L537	Custom per inch - see page 73 for details				\$39.71	
L538-8	1	8	11		\$374.5	2.2
L538	Custom per inch - see page 73 for details				\$46.09	

The L537 and L538 are available in several mountings. Refer to page 70 and specify mounting as surface (S), through-bolt (T), or back-to-back (BxB). Extra charges apply for BxB - see page 71.

L6001-1T



Item	Dia	C-C	OA	All Leather and Finish Combinations	Wt/ea
L6001-1T	3 3/16" x 5 3/16"	NA	NA	\$80.97	

L6008-1G



Item	Dia	C-C	OA	All Leather and Finish Combinations	Wt/ea
L6008-1G	2 7/8" x 4 5/8"	NA	NA	\$76.93	.24

LIST PRICE is per item or as otherwise specified, in US dollars. WEIGHT is per 10 pieces or as otherwise specified, in lbs.

EMAIL ORDERS TO SALES@THEBRONZE.COM

L660 - L661



Item	Dia	C-C	OA	Proj	All Leather and Finish Combinations	Wt/ea
L660-6	1/2" SQ	6	6 1/2	1 1/4	\$156.40	.59
L660	Custom per inch - see page 73 for details				\$27.38	
L661-8	3/4" SQ	8	8 3/4	1 3/4	\$279.16	1.0
L661	Custom per inch - see page 73 for details				\$36.30	

The L661 is available in several mountings. Refer to page 70 and specify mounting as surface (S), through-bolt (T), or back-to-back (BxB). Extra charges apply for BxB - see page 71.

L700

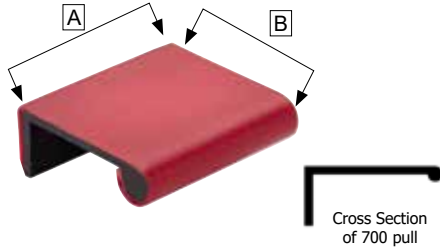

Item	C-C	"A"	"B"	All Leather and Finish Combinations	Wt/10	
L700-1H	1 1/2	2	1 3/4	\$74.13	0.9	
L700-3	3	4	1 3/4	\$137.25	2.1	
L700	Custom per inch - see page 73 for details				\$35.20	

L709



Item	Size	C-C	OA	Proj	All Leather and Finish Combinations	Wt/10
L709-2	2 1/2" x 1 5/8"	2	2 1/2	1 5/8	\$74.13	1.5

L710 series



Item	Size	C-C	OA	Proj	All Leather and Finish Combinations	Wt/10
L710-5	1 1/2" x 6"	5	6	1 1/2	\$177.89	2.1
L710	Custom per inch - see page 73 for details				\$31.49	

L711 Series



Item	Size	C-C	OA	Proj	All Leather and Finish Combinations	Wt/ea
L711-1H	5/16" x 1 x 1	1 1/2	2 1/2	1	\$96.90	.34
L711-4	5/16" x 1 x 1	4	5 3/4	1	\$222.84	.75
L711-6	5/16" x 1 x 1	6	8	1	\$310.00	1.1
L711	Custom per inch - see page 73 for details				\$44.12	

Please note that custom lengths may incur a cutting die charge. See page 72 for details



L826



Item	Dia	C-C	OA	Proj	All Leather and Finish Combinations	Wt/ea
L826	3/8" x 3/4"	NA	1 1/2	1 1/8	\$89.07	.11

L827 - L829



Item	Dia	C-C	OA	Proj	All Leather and Finish Combinations	Wt/ea
L827-5	3/8" x 3/4"	5	6	1 1/4	\$173.68	.39
L827	Custom per inch - see page 73 for details				\$32.96	
L828-6	1/2" x 3/4"	6	7	1 5/16	\$226.72	.58
L828	Custom per inch - see page 73 for details				\$36.87	
L829-10	3/4" x 1	10	12	2	\$461.53	2.4
L829	Custom per inch - see page 73 for details				\$43.78	

The L828 and L829 are available in several mountings. Refer to page 70 and specify mounting as surface (S), through-bolt (T), or back-to-back (BxB). Extra charges apply for BxB - see page 71.

L832



Item	Dia	C-C	OA	Proj	All Leather and Finish Combinations	Wt/ea
L832-6	3/4	8	8 3/4	1 7/8	\$209.64	1.1
L832-8	3/4	10	10 3/4	1 7/8	\$279.51	1.5
L832	Custom per inch - see page 73 for details				\$39.78	

The L832 is available in several mountings. Refer to page 70 and specify mounting as surface (S), through-bolt (T), or back-to-back (BxB). Extra charges apply for BxB - see page 71.

L842



Item	Dia	C-C	OA	Proj	All Leather and Finish Combinations	Wt/ea
L842-8	1	8	10	2 1/8	\$374.50	1.5
L842-10	1	10	12	2 1/8	\$446.30	1.7
L842	Custom per inch - see page 73 for details				\$46.09	

The L842 is available in several mountings. Refer to page 70 and specify mounting as surface (S), through-bolt (T), or back-to-back (BxB). Extra charges apply for BxB - see page 71.

L846 - L847



Item	Dia	C-C	OA	Proj	All Leather and Finish Combinations	Wt/ea
L846-10	3/4	10	12	1 5/8	\$437.51	1.5
L846	Custom per inch - see page 73 for details				\$39.78	

The L846 is available in several mountings. Refer to page 70 and specify mounting as surface (S), through-bolt (T), or back-to-back (BxB). Extra charges apply for BxB - see page 71.

L911 - L912



Item	Dia	Proj	All Leather and Finish Combinations	Wt/ea
L911	1 1/2"	1/4"	\$55.65	.1
L912	1 3/4"	1/4"	\$59.96	.15

LIST PRICE is per item or as otherwise specified, in US dollars. WEIGHT is per 10 pieces or as otherwise specified, in lbs.

EMAIL ORDERS TO SALES@THEBRONZE.COM

L921 -L922

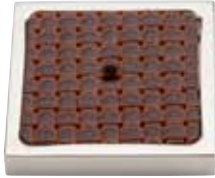

Item	Dia	Proj	All Leather and Finish Combinations	Wt/ea
L921	1 1/2" SQ.	1/4"	\$55.65	.14
L922	1 3/4" SQ.	1/4"	\$59.96	.20

L1307 - L1310



Item	Dia	C-C	OA	Proj	All Leather and Finish Combinations	Wt/ea
L1307-3H	1/2"	3 1/2"	5	1 1/4"	\$131.59	.31
L1307	Custom per inch - see page 73 for details				\$32.68	
L1308-6	5/8"	6	7 3/4"	1 1/2"	\$198.40	.81
L1308	Custom per inch - see page 73 for details				\$37.20	
L1309-8	3/4"	8	10 1/4"	1 7/8"	\$244.54	1.6
L1309	Custom per inch - see page 73 for details				\$43.38	
L1310-8	1	8	11	2 1/2"	\$358.74	3.1
L1310	Custom per inch - see page 73 for details				\$50.28	

The L1309 and L1310 are available in several mountings. Refer to page 70 and specify mounting as surface (S), through-bolt (T), or back-to-back (BxB). Extra charges apply for BxB - see page 71.

LER111



Item	Rod Dia	Overall	All Leather and Finish Combinations	Wt/ea
LER111	15/32	11	\$200.33	1.2

Call the factory for pricing on custom pull-out garment rods.



Imagine the Custom Possibilities....

Colonial's custom manufacturing capabilities are always available to our customers. That expertise, when combined with the beauty of Edelman Leather, makes for a truly creative result - door lever handle wrapped in China Black Gold; and L828 handle wrapped in customer-supplied stingray skins.



Leather wrapped lever handle



Authentic stingray shagreen leather provided by customer

LIST PRICE is per item or as otherwise specified, in US dollars. WEIGHT is per 10 pieces or as otherwise specified, in lbs.

EMAIL ORDERS TO SALES@THEBRONZE.COM



Is leather a practical choice for the kitchen?

Well, EVOO doesn't frighten our leather...
(and neither does any other kitchen oil or grease)

We rubbed our Edelman leather with olive oil, butter and other greasy kitchen condiments to test Edelman's assertion that its leather could stand up to the rigors of the kitchen, and every leather came through these tests unfazed.

Being true sceptics, however, we wanted to really see how durable Edelman leather truly is, so we conducted an experiment: We removed the standard chrome pull on our factory men's room door, and replaced it with a pull wrapped in Edelman leather. We wanted to see how Edelman leather stood up to frequent use in an environment where grease, buffing compounds, machine oils and similar soils were the norm.



We are pleased to report that even after more than two years of use, the leather remained beautiful despite the soils, grease and grime of 40 men who washed up in that room at least three times every day. The un-retouched before and after photos below speak for themselves.

DURABILITY TEST

After more than 2 years in use *before* last cleaning



Close-up of the pull (after two years of use on the men's room door) prior to the most recent cleaning with Edelman Leather Cleaner.

How hard did we work the leather?

Just the facts...

40 male employees

x

3 times every day

x

5 days every week

x

127 weeks since installation

=

76,200 duty cycles

That equates to an average family of four's usage for

17 years

After more than 2 years in use *after* a recent cleaning



Close-up of the same two-year old pull after a quick cleaning with Edelman Leather Cleaner.

Josef Ruefelli

A PASSION FOR PRECISION

Contemporary
Geometric Designs
with Exceptional
Detail



ITALIAN DESIGN | SWISS PRECISION

The Ruefelli Ordering Process - Step 1: Select your design

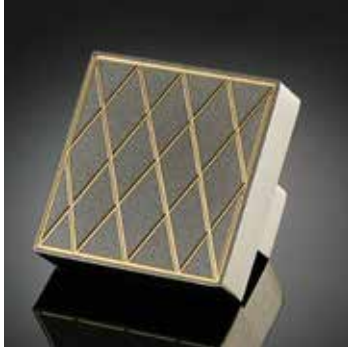

Argyle
Veneto - Design Code A1
 (Shown in Frost Nickel and Brass)
 Finish Code: 15F x 3



Basket Weave
Tessere - Design Code A2
 (Shown in Frost Nickel and Black)
 Finish Code: 15F x 19

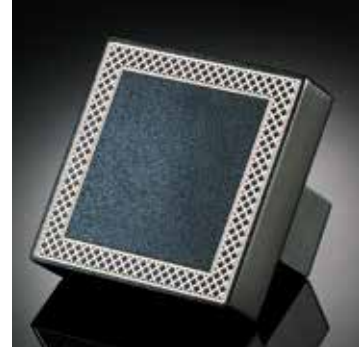

Border Diamonds
Diamante - Design Code A3
 (Shown in Frost Black and Nickel)
 Finish Code: 19F x 14



Bricks
Mattoni - Design Code A4
 (Shown in Frost Nickel and Black)
 Finish Code: 15F x 19



Bubbles
Bolle - Design Code A5
 (Shown in Polished Chrome and Chrome)
 Finish Code: 26 x 26



Chains
Catena - Design Code A6
 (Shown in Frost Black and Nickel)
 Finish Code: 19F x 14



Circles
Piccolo Gioiello - Design Code A7
 (Shown in Polished Chrome and Chrome)
 Finish Code: 26 x 26

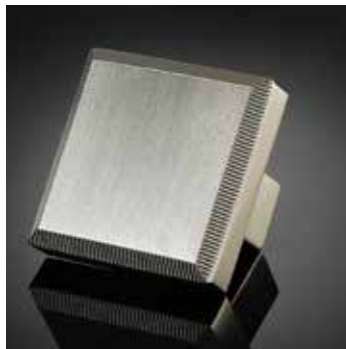

Coining
Borda Coniati - Design Code A8
 (Shown in Nickel Stainless x Nickel)
 Finish Code: 15CC x 14

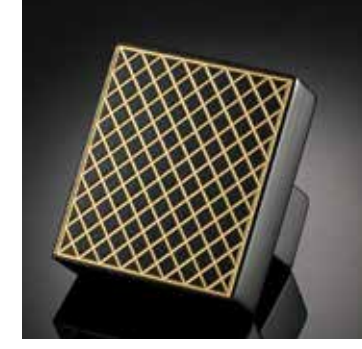

Crosshatch
Quadrettatura - Design Code A9
 (Shown in Frost Black and Brass)
 Finish Code: 19F x 3

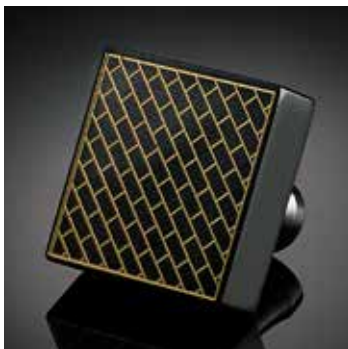

Diagonal Bricks
Mattoni Diagonale - Design Code B1
 (Shown in Frost Black and Brass)
 Finish Code: 19F x 3



Dominos
Domino - Design Code B2
 (Shown in Frost Brass and Brass)
 Finish Code: 4F x 3



Fans
Ventaglio - Design Code B3
 (Shown in Satin Nickel and Nickel)
 Finish Code: 15 x 14

LIST PRICE is per item or as otherwise specified, in US dollars. WEIGHT is per 10 pieces or as otherwise specified, in lbs.

EMAIL ORDERS TO SALES@THEBRONZE.COM

Step 1: Select your design



Scales
Lamina - Design Code B4
 (Shown in Polished Nickel and Nickel)
 Finish Code: 14 x 14



Parallel Lines
Parallele - Design Code B5
 (Shown in Polished Chrome and Chrome)
 Finish Code: 26 x 26



Jester
Giulliare - Design Code B6
 (Shown in Frost Nickel and Black)
 Finish Code: 15F x 19



Lace
Merletto - Design Code B7
 (Shown in Frost Black and Nickel)
 Finish Code: 19F x 14

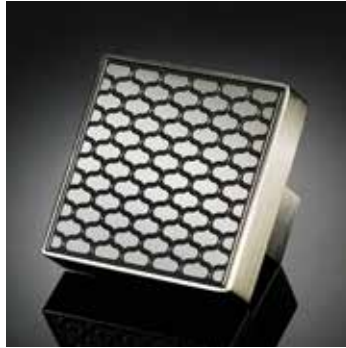

Moroccan
Marocchino - Design Code B8
 (Shown in Polished Nickel and Black)
 Finish Code: 14 x 19

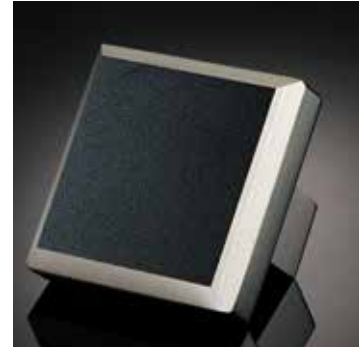

Plain Bevel
Angolo - Design Code B9
 (Shown in Frost Black and Nickel)
 Finish Code: 19F x 14

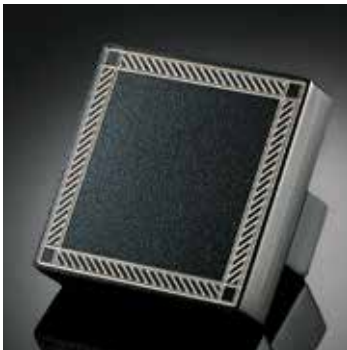

Rope
Cordata - Design Code C1
 (Shown in Frost Black and Nickel)
 Finish Code: 19F x 14



S Curve
Tuffo - Design Code C2
 (Shown in Frost Black with Brass)
 Finish Code: 19F x 3



Stars
Stelle - Design Code C3
 (Shown in Frost Black and Nickel)
 Finish Code: 19F x 14



Window Pane
Struttura - Design Code C5
 (Shown in Frost Black with Brass)
 Finish Code: 19F x 3



Fields
Terreno - Design Code C6
 (Shown in Frost Nickel and Black)
 Finish Code: 15F x 19

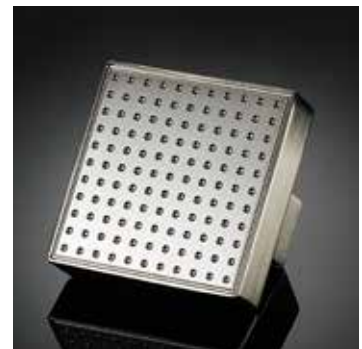

Dots
Puntino - Design Code C7
 (Shown in Polished Chrome and Chrome)
 Finish Code: 26 x 26

LIST PRICE is per item or as otherwise specified, in US dollars. WEIGHT is per 10 pieces or as otherwise specified, in lbs.

EMAIL ORDERS TO SALES@THEBRONZE.COM



Step 2: Select your hardware

Knob



Item	Size	Projection	Style
J111	1 1/4 Round	1 3/16	Flared Post
List Price	Weight/10		
\$62.92	1.8		

Knob



Item	Size	Projection	Style
J112	1 1/2 Round	1 3/16	Flared Post
List Price	Weight/10		
\$70.18	2.1		

Knob

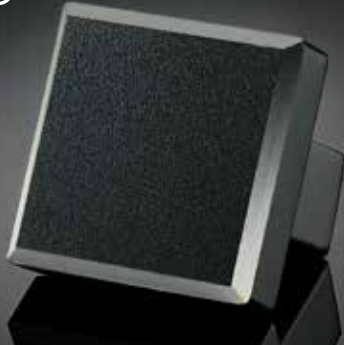

Item	Size	Projection	Style
J121	1 1/4 Square	1 3/16	Rectangular Post
List Price	Weight/10		
\$62.92	2.5		

Knob



Item	Size	Projection	Style
J122	1 1/2 Square	1 3/16	Rectangular Post
List Price	Weight/10		
\$70.18	3.5		

Knob



Item	Size	Projection	Style
J123	1 1/4 Square	1 3/16	Thin with Flared Post
List Price	Weight/10		
\$62.92	1.0		

Knob



Item	Size	Projection	Style
J124	1 1/2 Square	1 3/16	Thin with Flared Post
List Price	Weight/10		
\$70.18	1.5		

LIST PRICE is per item or as otherwise specified, in US dollars. WEIGHT is per 10 pieces or as otherwise specified, in lbs.

EMAIL ORDERS TO SALES@THEBRONZE.COM

Knob



Item	Size	Projection	Style
J125	1 1/4 Square	1 3/16	Flared Post
List Price	\$62.92	Weight/10	2.2

Knob



Item	Size	Projection	Style
J126	1 1/2 Square	1 3/16	Flared Post
List Price	\$70.18	Weight/10	2.9

Handle

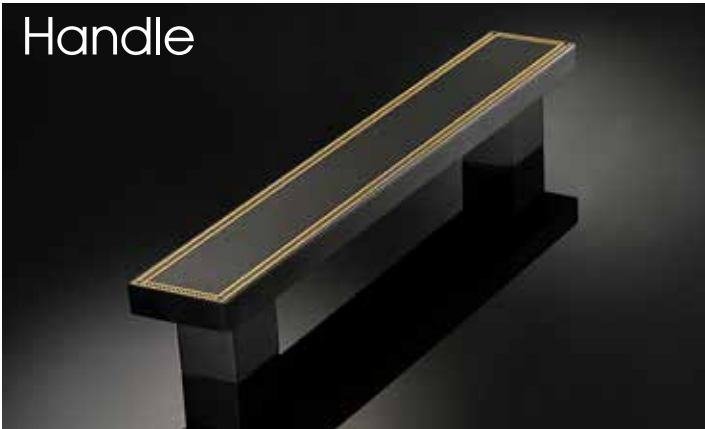

Item	Center to Center	Projection	Dimensions
J275-8	8	1 1/2	1 1/4 x 1/2 x 10
List Price	\$356.95	Weight/ea	
Price Per Inch	\$46.20	2.25	

Handle



Item	Center to Center	Projection	Dimensions
J276-8	8	1 1/2	1 1/4 x 1/2
List Price	\$356.95	Weight/ea	2.0
Price Per Inch	\$46.20	2.0	

Handle



Item	Center to Center	Projection	Dimensions
J460-1	1	7/8	1 1/4 x 2
List Price	\$87.12	Weight/10	
Price Per Inch	\$22.44	2.0	

Handle



Item	Center to Center	Projection	Dimensions
J460-4	4	7/8	1 1/4 x 5
List Price	\$102.85	Weight/10	5.0
Price Per Inch	\$22.44	5.0	

LIST PRICE is per item or as otherwise specified, in US dollars. WEIGHT is per 10 pieces or as otherwise specified, in lbs.

EMAIL ORDERS TO SALES@THEBRONZE.COM

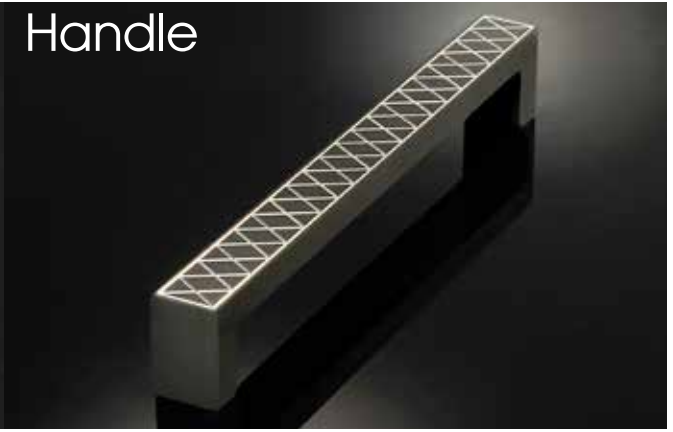

Item	Center to Center	Projection	Dimensions
J508-4	4	1 1/8	3/8 x 3/4 x 6
List Price	\$123.75	Weight/ea	
Price Per Inch	\$26.84	0.7	

Item	Center to Center	Projection	Dimensions
J509-6	6	1 1/8	3/4 x 3/8 x 6 3/4
List Price	\$123.75	Weight/ea	
Price Per Inch	\$26.84	0.5	

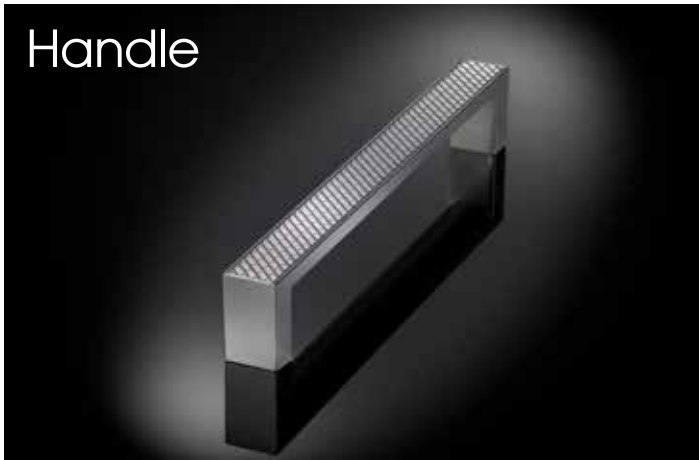

Item	Center to Center	Projection	Dimensions
J746-8	8	1 1/8	5/8 x 3/8 x 8 3/8
List Price	\$136.95	Weight/ea	
Price Per Inch	\$26.84	1.7	



J746 is rounded on the underside of the pull for a more ergonomic feel



Item	Center to Center	Projection	Dimensions
J844-18	18	1 7/8	1 x 3/4 x 18 3/4
List Price	\$772.75	Weight/ea	
Price Per Inch	\$46.20	4.2	



J844 is rounded on the underside of the pull for a more ergonomic feel



Josef Ruefelli's 1917 Swiss Passport

Italian Design - Swiss Precision - American Made

LIST PRICE is per item or as otherwise specified, in US dollars. WEIGHT is per 10 pieces or as otherwise specified, in lbs.

EMAIL ORDERS TO SALES@THEBRONZE.COM

How to order your Josef Ruffelli hardware in three easy steps

Josef Ruffelli

Step 1: Select the shape and size



Step 2: Select the design

Design	Name	Page
A1	Veneto (Argyle)	63
A2	Tessere (Basket Weave)	63
A3	Diamante (Border Diamonds)	63
A4	Mattoni (Bricks)	63
A5	Bolle (Bubbles)	63
A6	Catena (Chains)	63
A7	Piccolo Gioiello (Little Jewels)	63
A8	Borda Coniati (Coined Border)	63
A9	Quadrettatura (Crosshatch)	63
B1	Mattoni Diagonale Diagonal Bricks	63
B2	Domino (Dominos)	63
B3	Ventaglio (Fans)	63

Design	Name	Page
B4	Lamina (Scales)	64
B5	Parallele (Parallel Lines)	64
B6	Giullare (Jester)	64
B7	Merletto (Lace)	64
B8	Marocchino (Maroccan)	64
B9	Angolo (Beveled)	64
C1	Cordata (Rope)	64
C2	Tuffo (S-Curve)	64
C3	Stelle (Stars)	64
C5	Struttura (Windowpane)	64
C6	Terreno (Fields)	64
C7	Puntino (Dots)	64

A note about the designs we offer...

The designs shown and listed above are truly just the tip of the proverbial iceberg of possibilities. We can apply the skills we have gained in designing the Josef Ruffelli Collection in a variety of ways, from the common to the sublime.

For example, have a centerpoint glass tile mosaic in your project? Why not snap a photo of the design and we will integrate that pattern into the cabinet hardware, subtly reinforcing the message of the central design focus.

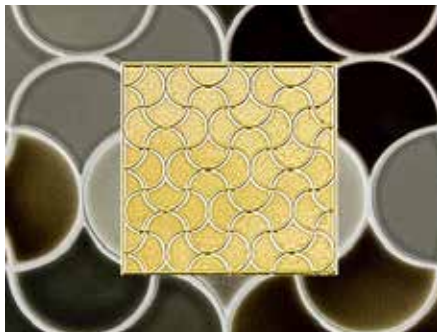

Or, need something a little more appropriate than signage engraved by a trophy house? From simple signage to distinguishing trademarks and corporate logos, we can do it all.



Step 3: Select from the available finishes *Josef Riefelli*

Single finish Riefelli items



The finishes listed below can be used for ordering a Riefelli design **when the detail and the background finish are the same.** Shown at left is an example of single finish Riefelli in polished chrome with the accents in the same finish also in polished chrome

- | | | | | | | |
|---|--|---|---|--|--|--|
| 3

Polished Brass | 10B

Oil Rubbed Bronze | 19

Satin Black | 4F

Frost Brass™ | 4

Satin Brass | M10B

Matte ORB | M19

Matte Satin Black |
| M4

Matte Satin Brass | 14

Polished Nickel | 26

Polished Chrome | 15F

Frost Nickel™ | CU

Polished Copper | 15

Satin Nickel | 26D

Satin Chrome |
| 19F

Frost Black™ | SCU

Satin Copper | 15CC

Nickel Stainless | 26F

Frost Chrome™ | M26D

Matte Satin Chrome | | |



Two finish Riefelli items



The finishes listed below can be used to accent the Riefelli design detail **when the Riefelli design finish is different than one of the finishes above.** Shown at left is an example of a dual finish Riefelli with polished nickel accents on Frost Black background

- | | | | |
|---|---|---|---|
| 3

Polished Brass | 14

Polished Nickel | 19

Satin Black | CU

Polished Copper |
|---|---|---|---|

Example of how to order a Riefelli piece:

J122 **C1** **19F x 14**
1.50" square knob Cordata (rope) Frost Black™ and Nickel



Result J122-C1-19Fx14

Mounting Option Codes: Appliance or architectural pulls with 8/32 screw holes. Refer to page 72 for pricing information

40	546	J509
41	547	J748
205	552	L205
206	553	L247
240-6	558	L271
241-6	559	L535
247	564	L536
260	565	L660
261	805	L661
271	813	L827
273	847	L828
281	860	L846
294	1309	L847
295	1346	L1307
323	1347	L1308
415	1446	L1309
536	1447	
537	J508	

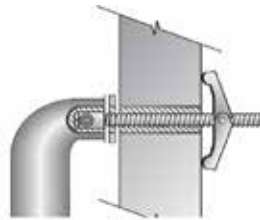

Toggle Bolt

Item no. 9020-R

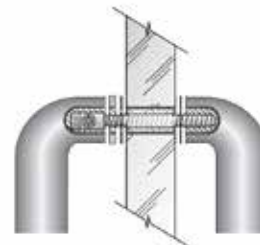

B x B
Back-to-back mount,
non-glass or glass
applications.

Item no. 9121
(glass)

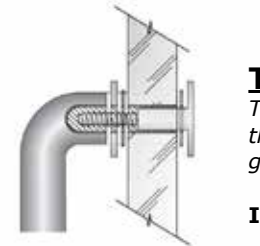

I
Through-bolt mount,
through-glass or non-
glass with cap screws.

Item no. 9154, 9156



S
Surface mount,
concealed
screw.

Item no. 9020



B x B
Back-to-back
mount,
non-glass applica-
tion.

Item no. 9120



I
Through-bolt mount.

Item no. 9070 for
Refrigerator Art™
Appliance Handles

Mounting Option Codes: Appliance or architectural pulls with 1/4-20 screw holes. Refer to page 72 for pricing information

42	262	852
43	266	855
44	275	858
45	276	944
46	282	1310
214	283	1345
215	538	1442
222	566	J275
232	567	L232
236	568	L242
240	569	L243
241	815	L244
242	822	L246
246	832	L537
250	836	L538
254	844	L829
256	845	L832
257	845	L842
258	850	L844
261	851	L1310

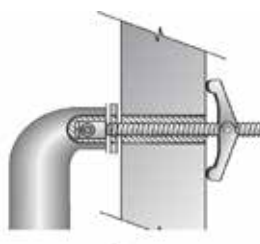

Toggle Bolt

Item no. 9010-R,
9030
(9030 for bath acces-
sories)
**(We supply Toggler®
Bolts with our
products)**

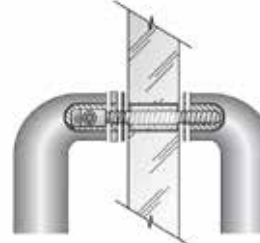

B x B
Back-to-back mount,
glass application.

Item no.
9100 (1-1/4 screws)
9100-1H (1-1/2" screws)
9180 (knobs only)



I
Through-bolt mount,
through-glass or non-
glass with cap screws.

Item no. 9150, 9153,
9155



S
Surface mount,
concealed screw.

Item no. 9010,
9030
(9030 for bath
accessories)



B x B
Back-to-back
mount,
non-glass applica-
tion.

Item no. 9110



I
Through-bolt
mount.

Item no. 9040-2Q
(two screw sizes
supplied)

Mounting Hardware Description and Pricing

9010	Surface Mounting for 1/4-20 Fastener	NO CHARGE
9010-R	Surface Mounting 1/4-20 Drywall Toggle Bolt, featuring Toggler® Bolts	NO CHARGE
9020	Surface Mounting for 8/32 Fastener	NO CHARGE
9020-R	Surface Mounting 8/32 Drywall Toggle Bolt	NO CHARGE
9030	Surface Mount for Bath Accessories	NO CHARGE
9040-2Q	Thru Bolt for 1/4-20 Fastener	NO CHARGE
9070	Thru Bolt for 8/32 Fastener	NO CHARGE
9100	Back x Back, Mounting Kit for Glass, 1/4-20 x 1-1/4" Screws	\$27.92
9100-1H	Back x Back, Mounting Kit for Glass, 1/4-20 x 1-1/2" Screws	\$27.92
9110	Back x Back Mounting Kit, Non-Glass Application, 1/4-20 x 2-3/4" Screws	\$12.55
9120	Back x Back Mounting Kit, Non-Glass Application, 8/32 x 2-1/2" Screws	\$10.01
9121	Back x Back, Mounting Kit for Glass, 8/32 x 1-1/2" Screws	\$19.99

Typical Installations	Mounting Code	Application	Item No.	Screw Size and Notes
Towel bar mounted on a wall into wood	S	wood	9010	#14 x 1-1/2" wood screw
Towel bar mounted on drywall	S	drywall	9010-R	1/4-20 x 3" Toggler® toggle bolt
Towel bar mounted on a wall into wood	T	wood	9020	#6 x 1 1/2" wood screw . Used only with the following items numbers: 205S, 206S, 247S, 847S, 271S, 40S-6, 40S-8, 41S-6, 41S-8.
Towel Bar mounted on drywall	T	drywall	9020-R	8-32 x 3" toggle bolt
Towel bar on drywall or wall into wood	T	wood or drywall	9030	#14 x 2-1/2" wood screw and 3/16 x 3" toggle bolt
Pull mounted on a large entrance door	T	1 3/4" thick wood	9040-2Q	1/4-20 x 2-1/4" machine screws
Pull mounted on a wardrobe (closet) door	T	1 1/4" thick wood	9070	8-32 x 1 3/4" machine screw . Used only with the following item numbers: 205T, 206T, 247T, 40T-6, 40T-8, 41T-6, 41T-8
Pull mounted on a glass door	T	glass 1/4 - 1/2" thick	9150	3/4" diameter brass cap screw w/ 1/4-20 x 1" stud
Pull on a glass door with cap screw on back	T	glass 1/4 - 1/2" thick	9153	1" diameter brass cap screw w/ 1/4-20 x 1" stud
Pull on a glass door with cap screw on back	T	glass 1/4 - 1/2" thick	9154	1" diameter brass cap screw w/ 8-32 x 3/4" stud
Pull on a glass door with cap screw on back	T	glass 1/4 - 1/2" thick	9155	1 1/4" diameter brass cap screw w/ 1/4-20 x 1" stud
Large Handle or cabinet pull on a glass door	T	glass 1/4 - 1/2" thick	9156	3/4" cap screw w/ 8-32 x 3/4" machine screw. Used only with the following model numbers: 205T, 206T, 247T, 40T-6, 40T-8, 41T-6, 41T-8
Pulls mounted back-to-back on wooden door	B x B	1 3/4" thick wood	9110	1/4-20 x 2-3/4" socket cap screws
Pulls mounted back-to-back on non-glass doors	B x B	1 3/4" thick wood	9120	8-32 x 2-1/4" machine screws . Used only with the following item numbers: 205, 206, 247, 40, 41, 847 and 271
Pulls mounted back-to-back on glass doors	B x B	glass 1/4 - 1/2" thick	9121	8-32 x 1-1/2" and 8-32 x 1-1/4" machine screws and mounting roses. Used only with item numbers: 205, 206, 247, 40, 41
Pulls mounted back-to-back on glass doors	B x B	glass 1/4 - 1/2" thick	9100	1/4-20 x 1-1/4" stainless steel socket head screws
Pulls mounted back-to-back on glass doors	B x B	glass 1/4 - 1/2" thick	9100-1H	1/4-20 x 1-1/2" stainless steel socket head screws
Knobs that require orientation mounted back-to-back on glass or wood doors	B x B	oriented knob	9170	1/4-20 x 1-1/4" stainless steel socket head screw and 9161 - 1" diameter mounting rose
Knobs mounted back-to-back on glass or wood doors	B x B	non-oriented knob	9180	1/4-20 x 1-1/4" headless screws

Terms and Conditions of Sale

Terms

- Net 30 days.
- Interest at a rate of 1.5% per month on invoices over 30 days may be applied.
- Past due accounts will be placed on credit hold. No orders will be processed nor shipments made until the account is brought within terms. In addition, work on existing orders on the factory floor will be suspended until such time as the account is brought within terms.

Prices

- All prices are in US Dollars.
- Subject to change without notice. Orders will be billed at price in effect when the order is received, except for written quotes specifying otherwise.
- Colonial's reputation for quality, integrity and honesty is very important to us. As part of this ongoing effort to safeguard our reputation, we have a unilateral Minimum Advertised Price (MAP) policy. If a price for any Colonial Bronze product is included in any advertisement, the price must not be less than 80% of the Suggested Retail Price then in effect. Advertising includes, but is not limited to, printed advertisements, promotional mailers, catalogs, faxes, radio, and all electronic media, including web sites.
- In the event that we are informed the minimum advertised pricing policy has been breached and upon fair and adequate proof, we will issue a written warning reminding the offending party of the policy. Any subsequent breach of the policy by the same party will result in nullification and termination of any previous authorizations and agreements, either verbal or in writing, to resell our products.

Setup Fee, Per Inch Pricing and Custom Leather Cutting Die Charges

- A \$95.00 net set-up fee applies for custom-made items manufactured in size increments other than half-inch or inch increments. The set-up fee also applies for custom projections and similar customization of the product.
- **When computing prices for custom length handles using per-inch prices, multiply the price per inch times the overall length, rounded up to the nearest whole inch.** For example, an 844 handle (page 33) is priced at \$29.25 per inch for custom lengths. If you want to order a handle that is 22" overall, the price is \$29.25 X 22, or \$643.50 LIST. On the other hand, if you want an 844 handle that is 23.5" overall, the price would be \$29.25 X 24" (23.5 rounded up to the nearest full inch), or \$702.00. Please keep in mind that custom items that are BELOW the overall length of the shortest standard length may still cost more due to the custom nature of the manufacturing process.
- For custom length L270, L271, L272, L273, L275, L276, L460 and L711's, in the event we do NOT already have a cutting die for the custom size desired, a \$100 cutting die charge will be added to the cost. The cutting die will be used to cut the leather precisely to fit your custom length handle. Customer Service will advise you whether the additional die charge is required.

Shipments

- **Ground freight will be pre-paid on all orders over \$3,000 net;** all other shipments are F.O.B. Tor-

rington, CT. Shipments to Alaska, Hawaii, and points outside the United States: Freight-prepaid shipments will be forwarded at our expense to the nearest continental port of embarkation; all other shipments are F.O.B. Torrington, CT.

- Note that drop ship and “signature required” fees will be applied to all residential shipments unless prior arrangements otherwise are made in writing.
- Purchaser assumes full risk for loss or damage in transit upon our delivery to the carrier. Claims for damage must be filed with the transportation company. Colonial Bronze retains the right to designate carriers, and will not accept any additional handling or storage charges.
- In the event that the ship-to address supplied by you is incorrect and an Address Correction Fee is imposed by the common carrier, the correction fees will be billed to you separately.

Finish Care

- To properly clean your finishes, use a soft, damp cloth. Liquid dish washing soap can be used if needed. Do not use abrasive cleansers: they will scratch the protective coating, damage its clarity and void your tarnish-free warranty. Do not use any metal polishing compounds (Flitz, etc.) - the use of such products will void your warranty.

Custom Leather Colors for Tanners Craft

- If a leather color other than our standard leather offering is desired, Edelman Leather determines the minimum amount of leather that we can purchase and will be quoted accordingly at the then-current price per square foot for the leather requested. We will use the requested leather to fabricate the custom hardware, endeavoring to be as judicious as possible in order to return as much of the remaining leather as possible in a usable form to your customer.

Expedited Manufacturing

- We have a team prepared to work additional hours beyond those normally scheduled. We can expedite your order for a 30% upcharge over the net invoice, with a minimum fee of \$100 NET. Please contact us to discuss your delivery requirements inasmuch as our ability to offer the expediting service is subject to our available resources.

Returned Goods Policy

- RGA must be requested **within sixty (60) days** of the invoice date for the product being returned.
- Upon request, a Return Goods Authorization (RGA) will be faxed or emailed to you. A printed copy of the RGA must accompany the goods being returned before credit can be issued.
- The RGA number must be written on the outside of the shipping box.
- All authorized returns, except for customer cancellations, must be sent via UPS using UPS return labels that Colonial Bronze will send you via your email address.
- Upon our receipt of item returned pursuant to an RGA, Colonial Bronze will issue you a credit. **Do not deduct credits to which you believe you are entitled from your payments of outstanding invoices. Doing so will delay proper crediting of your payments.**
- **IMPORTANT: If merchandise is damaged in return shipment due to improper repackaging, no credit will be allowed, regardless of the reason for its return.**
- For returns other than defective merchandise, the following restock fees will apply:

- Standard Colonial single finish items - 25% restocking fee will be charged;
- Split finish items - 50% restocking fee will apply;
- Tanners Craft leather - 50% restocking fee will apply.
- Josef Ruefelli collection - 50% restocking fee will apply.
- **Items manufactured to your custom dimensional specifications, including customized switchplates and bull nosed pulls, cannot be returned.**
- Orders for individual pieces or samples cannot be returned.

Cancellation Policy

- Orders for items with custom dimensional specifications, including custom switchplates, can only be cancelled within 48 hours of the time you receive confirmation of your order. Cancellations received after 48 hours will be subject to a 20% fabrication fee because the order will have been released to the factory floor.
- Orders for Tanners Craft leather items may only be cancelled within **three days** of the date we send you a confirmation of your order because all Tanner's Craft products are made specifically to your order.

Limited Lifetime Warranty Information

- All Colonial products are protected by the Finishes for Life™ protective clear coat unless otherwise noted in our catalog, or unless specifically requested otherwise. If a finish is requested to be produced without a protective clear coat, such as 3A, 4A, 10BU and WB (which is waxed only), the Lifetime Finish warranty is not applicable.
- We warrant to the original purchaser that any product protected by the Finishes for Life™ protective clear coat will be free from tarnishing, discoloration, and pitting for the life of the product, subject to normal wear and tear. Scratches or other normal signs of use are not covered by this warranty. Should any product covered by the Finishes for Life™ protective clear coat fail, we will, at our option, repair or replace it.
- The use of metal polishes (Flitz, Brasso, etc.) on clearcoated finishes will void the warranty because most metal polishes will damage the clearcoat, leaving the finish unprotected.
- These warranties apply only to interior use of Colonial Bronze products and do not extend to the use in an exterior setting (see Note 1 below). Failure to follow the Finish Care instructions above will void your warranty.

NOTE: Our obligation under this warranty extends solely to the replacement or repair or replacement of the hardware at our option, *and does not extend to any costs incurred in to remove or reinstall the product.*

¹ No agent or representative of Colonial Bronze Company has the authority to: waive, alter or supplement these warranties; make any representation or warranty not contained herein; or extend these warranties to other than the original end user of the product.

Colonial Bronze is not liable for indirect, incidental or consequential damages with the use of its products. This limitation includes, but is not limited to, the cost of removal and/or reinstallation, shipping damages, damages occurring during or after installation or removal, damages from chemical use or improper cleaning or polishing agents, and damages from careless handling.

These warranties are given expressly and in place of all other expressed or implied warranties of merchantability or fitness for a particular purpose. Please note that some states do not allow limitations on incidental or consequential damages, so the above limitation may not apply. These warranties give you specific legal rights, and you may have other rights which vary from state to state.

Sometimes it's easy to tell when a company stands out from the competition.



Only THE BRONZE can offer

- Custom manufacturing capability - we have made over 65,000 unique items for our customers
- A Lifetime Warranty in writing on all of our finishes, covering tarnishing, flaking, pitting and discoloration
- Hand-Finished, solid brass hardware made in the USA
- Hardware comprised of 93% pre-consumer recycled material - certified by Scientific Certification Systems, the leading auditor of recycled content environmental claims

For more than 90 years, Colonial Bronze has produced the finest cabinet and architectural hardware available. Unlike our competitors, we DON'T import finished hardware - we never allow anyone else to be responsible for the quality that bears the Colonial Bronze name. We control every aspect of our production and the level of quality that goes into our products.

When you select Colonial Bronze, American craftspeople will hand make the finest products available anywhere.

Three generations of American Craftsmanship

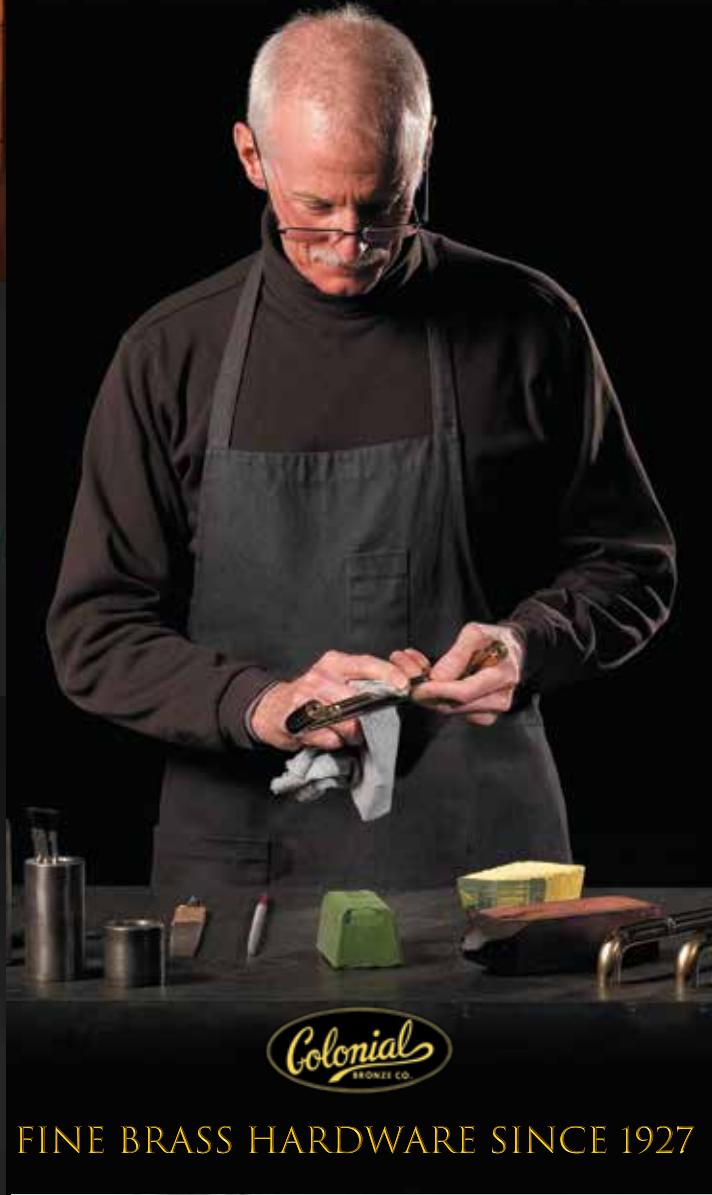
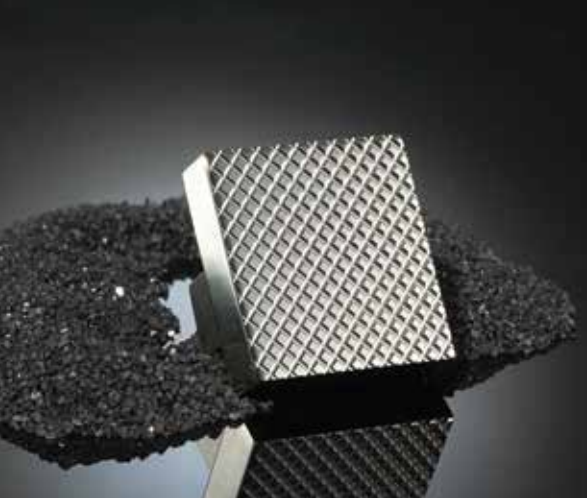

511 Winsted Road, Torrington, CT 06790
Tel (860) 489-9233 | Toll-Free (800) 355-7894
Toll-Free Fax (800) 355-7903 | Fax (860) 482-8760
Orders and Tech Support: sales@thebronze.com

www.thebronze.com

PROUDLY MADE IN THE



DPHA
Decorative Plumbing
& Hardware Association

Charter Member

© 2021 Colonial Bronze Company. All rights reserved.
All trademarks referenced herein are the property of their respective owners.