

# COTTER PINS

Zinc Plated

- One prong is extended for easy insertion.
- Use to lock clevis pins, slotted nuts, and other fasteners.

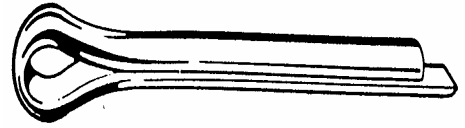

1/16 DIAMETER		
J&B #	SIZE	QTY
12330	1/16 x 1/2	100
12331	1/16 x 3/4	100
12332	1/16 x 1	100
12333	1/16 x 1-1/4	100
12334	1/16 x 1-1/2	100
12335	1/16 x 1-3/4	100
12336	1/16 x 2	100

5/64 DIAMETER		
J&B #	SIZE	QTY
12325	5/64 x 1	100
12327	5/64 x 2	100

7/64 DIAMETER		
J&B #	SIZE	QTY
12328	7/64 x 1	100
12329	7/64 x 2	100

3/32 DIAMETER		
J&B #	SIZE	QTY
12337	3/32 x 1/2	100
12338	3/32 x 3/4	100
12339	3/32 x 1	100
12340	3/32 x 1-1/4	100
12341	3/32 x 1-1/2	100
12342	3/32 x 1-3/4	100
12343	3/32 x 2	100
12345	3/32 x 2-1/2	100

5/32 DIAMETER		
J&B #	SIZE	QTY
12356	5/32 x 3/4	100
12357	5/32 x 1	100
12358	5/32 x 1-1/4	100
12359	5/32 x 1-1/2	100
12361	5/32 x 2	100
12363	5/32 x 2-1/2	100
12364	5/32 x 3	100

1/8 DIAMETER		
J&B #	SIZE	QTY
12346	1/8 x 1/2	100
12347	1/8 x 3/4	100
12348	1/8 x 1	100
12349	1/8 x 1-1/4	100
12350	1/8 x 1-1/2	100
12351	1/8 x 1-3/4	100
12352	1/8 x 2	100
12353	1/8 x 2-1/4	100
12354	1/8 x 2-1/2	100
12355	1/8 x 3	100

# COTTER PINS

Zinc Plated

- One prong is extended for easy insertion.
- Use to lock clevis pins, slotted nuts, and other fasteners.

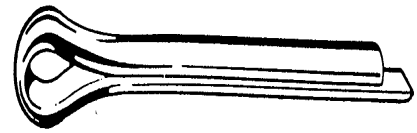

3/16 DIAMETER		
J&B #	SIZE	QTY
12365	3/16 x 3/4	100
12366	3/16 x 1	100
12367	3/16 x 1-1/4	100
12368	3/16 x 1-1/2	100
12369	3/16 x 1-3/4	100
12370	3/16 x 2	100
12371	3/16 x 2-1/4	100
12372	3/16 x 2-1/2	100
12373	3/16 x 3	100
25149	3/16 x 4	50

1/4 DIAMETER		
J&B #	SIZE	QTY
12374	1/4 x 1	50
12375	1/4 x 1-1/4	50
12376	1/4 x 1-1/2	50
12377	1/4 x 1-3/4	50
12378	1/4 x 2	50
12380	1/4 x 2-1/2	50
12381	1/4 x 3	50
12382	1/4 x 3-1/2	50
12383	1/4 x 4	50
12931	1/4 x 6	25

5/16 DIAMETER		
J&B #	SIZE	QTY
12384	5/16 x 1	50
12385	5/16 x 1-1/2	50
12386	5/16 x 2	50
12388	5/16 x 3	25
12390	5/16 x 4	25
12932	5/16 x 6	25

3/8 DIAMETER		
J&B #	SIZE	QTY
12392	3/8 x 2	25
12393	3/8 x 3	25
12394	3/8 x 3-1/2	25
12395	3/8 x 4	25
12933	3/8 x 6	25

1/2 DIAMETER		
J&B #	SIZE	QTY
12396	1/2 x 3	25
12397	1/2 x 4	25
20084	1/2 x 6	25

5/8 DIAMETER		
J&B #	SIZE	QTY
* 12399	5/8 x 6	25

\* Unplated

# SPRING LOCK PINS

Zinc Plated

- Chamfered ends for easier starting.
- Carbon steel construction for superior strength.
- Tap in and pin expands to grip tightly.



1/16 DIAMETER		
J&B #	LENGTH	QTY
12401	1/4	50
12406	3/8	50
12400	1/2	50
12402	3/4	50
12487	1	50

5/64 DIAMETER		
J&B #	LENGTH	QTY
12403	1/4	50
12405	1/2	50
12413	5/8	50
12407	3/4	50
12412	1	50

3/32 DIAMETER		
J&B #	LENGTH	QTY
12410	1/2	50
12411	3/4	50
12414	1	50
12485	1-1/2	50

1/8 DIAMETER		
J&B #	LENGTH	QTY
12415	3/8	50
12416	1/2	50
12417	5/8	50
12418	3/4	50
12420	1	50
12421	1-1/4	50
12422	1-1/2	50
25166	1-3/4	25
32086	2	25

5/32 DIAMETER		
J&B #	LENGTH	QTY
12423	1/2	50
12425	3/4	50
12426	1	50
12427	1-1/4	50
12428	1-1/2	25

3/16 DIAMETER		
J&B #	LENGTH	QTY
12429	1/2	50
12431	3/4	50
12432	1	25
12433	1-1/4	25
12434	1-1/2	25
12435	1-3/4	25
12436	2	25

# SPRING LOCK PINS

Zinc Plated

- Chamfered ends for easier starting.
- Carbon steel construction for superior strength.
- Tap in and pin expands to grip tightly.



7/32 DIAMETER		
J&B #	LENGTH	QTY
12437	3/4	25
12438	1	25
12439	1-1/4	25
12440	1-1/2	25
12484	1-3/4	50
12442	2	25

1/4 DIAMETER		
J&B #	LENGTH	QTY
25170	5/8	50
12443	3/4	50
12444	1	25
12445	1-1/4	25
12447	1-1/2	25
12446	1-3/4	25
12448	2	25
12486	2-1/4	25
12450	2-1/2	25
12452	3	25

5/16 DIAMETER		
J&B #	LENGTH	QTY
32085	3/4	25
12466	1	25
12468	1-1/2	25
12470	2	25
12472	2-1/2	20

3/8 DIAMETER		
J&B #	LENGTH	QTY
12453	1	25
12455	1-1/2	25
12457	2	25
12459	2-1/2	20
12461	3	15

7/16 DIAMETER		
J&B #	LENGTH	QTY
12481	1-1/2	20

1/2 DIAMETER		
J&B #	LENGTH	QTY
25171	1-1/4	10
12482	1-1/2	10
25172	2	10
12483	3	10
25173	4	10



# HAIRPINS

## ZINC PLATED (Pictures Actual Size)

- Easily inserted and quickly removed.
- Universal usage such as on shafts, wheels, small engines, to hold washers in place.



J&B #13264



J&B #13266



J&B #13268



J&B #13270



J&B #13272



J&B #13274



J&B #13276



J&B #13254

J&B #	DRILL HOLE SIZE	WIRE DIA.	OVERALL LENGTH	QTY
13264	1/32	.028	.600	100
13266	3/64	.042	1	100
13268	1/16	.047	1-9/16	100
13270	5/64	.062	1-9/16	100
13272	5/64	.072	1-7/8	100
13274	3/32	.080	1-9/16	100
13276	7/64	.093	1-5/8	50
13254	7/64	.093	2-5/16	50

# HAIRPINS

**ZINC PLATED**  
(Pictures Actual Size)



J&B #13278



J&B #13262



J&B #13256



J&B #13280



J&B #13282



J&B #13260

J&B #	DRILL HOLE SIZE	WIRE DIA.	OVERALL LENGTH	QTY
13278	1/8	.105	1-1/4	50
13262	9/64	.125	1-15/16	50
13256	9/64	.125	2-1/2	25
13280	9/64	.125	2-7/8	25
13282	5/32	.148	2-15/16	25
13260	3/16	.177	3-3/4	10

# WOODRUFF KEYS

- Low-carbon steel.
- Smooth finish for easy insertion.
- Ideal for machine repair.



J&B #	IND. #	T L	H	QTY
12586	# 2	3/32 x 1/2	3/16	25
12587	# 4	3/32 x 5/8	1/4	25
12588	# 3	1/8 x 1/2	3/16	25
12589	# 5	1/8 x 5/8	1/4	25
12590	# 6	5/32 x 5/8	1/4	25
12591	# 8	5/32 x 3/4	19/64	25
12592	#10	5/32 x 7/8	23/64	20
12593	# 9	3/16 x 3/4	19/64	25
12594	#11	3/16 x 7/8	23/64	20
12595	#13	3/16 x 1	27/64	20
12596	#91	1/4 x 3/4	19/64	20
12597	# A	1/4 x 7/8	23/64	20
12598	#15	1/4 x 1	15/32	15
12599	#18	1/4 x 1-1/8	27/64	10
12600	#21	1/4 x 1-1/4	17/32	10
12601	# B	5/16 x 1	27/64	10
12602	# C	5/16 x 1-1/8	15/32	10
12603	# D	5/16 x 1-1/4	17/32	10
12604	#152	3/8 x 1	27/64	10
12605	# E	3/8 x 1-1/4	17/32	10

# WIRE ROPE

## WIRE ROPE CLIPS

Zinc Plated

- Hot dip galvanized; malleable iron.
- Accurately formed wire rope channels on saddle eliminates damage to cable.



J&B #	SIZE	QTY
13223	1/8	10
13224	3/16	10
13226	1/4	10
13227	5/16	10
13228	3/8	10
13230	1/2	10
13232	5/8	5
13233	3/4	5

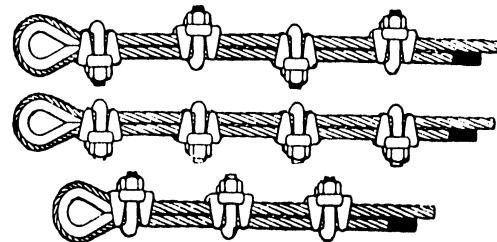

*To give adequate holding force, U-bolt clips must be spaced along the rope at equal intervals. . . usually at a distance of six wire-rope diameters. Before the rope is placed under tension, the nuts are tightened. But after the load is applied to the rope, the nuts must be tightened again.*

## THIMBLES

- Carbon steel; hot galvanized.
- Recommended for light duty service.

J&B #	SIZE (ROPE DIA.)	APPROX. LENGTH OVERALL	MIN. INSIDE WIDTH	QTY
41490	1/8	1-3/4	11/16	10
41491	3/16	1-3/4	11/16	10
41492	1/4	1-7/8	11/16	10
41493	5/16	2	13/16	10
41494	3/8	2-1/2	25/32	10
41496	1/2	3	1-1/8	10



## OVAL CABLE SLEEVES

J&B #	SIZE	QTY
V56990	1/8	50
V56991	3/16	50
56992	1/4	10



# LINKAGE HARDWARE

---

## ANCHOR SHACKLES

With Screw Pin

- Zinc plated.
- GR30.

J&B #	SIZE	PIN DIAMETER	WORKING LOAD LIMIT	QTY
41527	1/4	5/16	400 LB	5
41521	5/16		700 LB	5
41522	3/8		1000 LB	5
41523	1/2		2000 LB	5



---

## ANCHOR SHACKLES

With Clevis Pin

- Drop forged carbon steel.
- Self colored.
- Safe working load permanently shown on each shackle.

J&B #	SIZE	PIN DIAMETER	WORKING LOAD LIMIT	QTY
41435	3/8	7/16	1 TON	5



---

## SWIVEL SAFETY HASP

- Zinc plated.

J&B #	SIZE	QTY
V56985	4-1/2"	EA



# LINKAGE HARDWARE

## SNAP PINS

- Quick connect and disconnect offers thousands of applications on equipment, shafts and trailers.
- Headed shank formed of 1010 carbon steel, retainer wire formed of MB spring steel.
- Zinc plated for corrosion resistance.

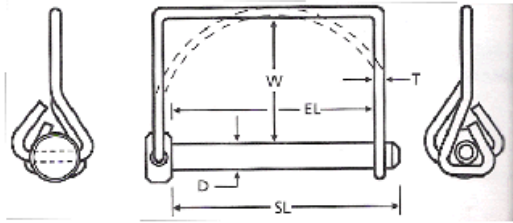

Square Handle

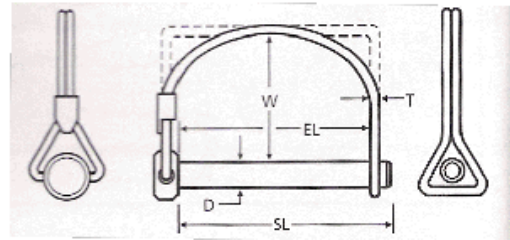

Round Handle

J&B #	NOMINAL (D)	EFFECTIVE LENGTH (EL)	SHANK LENGTH (SL)	WIRE CLEARANCE (W)	WIRE DIA. (T)	HANDLE STYLE	QTY
41055	1/4	1-3/8	1-5/8	1.625	.091	Round	5
41054	1/4	2-1/4	2-1/2	1.625	.091	Square	5
41056	5/16	2-1/4	2-1/2	1.75	.091	Square	5
41061	3/8	2-1/4	2-1/2	1.50	.091	Square	5

## HITCH PINS

- Red plastisol coated head, Heavy duty, made of high tensile strength, heat treated.
- Includes hairpin.



J&B #	SHAFT DIAMETER	USEABLE LENGTH	QTY
41483	3/8	4"	6
41484	1/2	3-5/8"	6
41485	5/8	5-1/2"	6
41486	3/4	6-1/2"	6

# LINKAGE HARDWARE

## LYNCH PINS

- Forged, gold dichromate plating.
- Quick disconnect fastener.

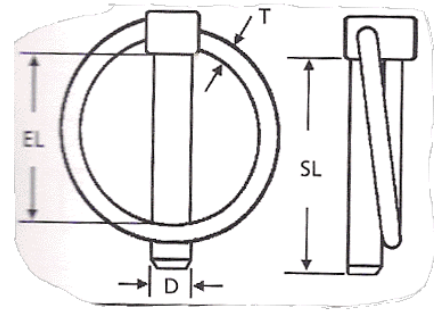

J&B #	NOMINAL (D)	EFFECTIVE LENGTH (EL)	SHANK LENGTH (SL)	WIRE DIAMETER (T)	QTY
41057	3/16	1"	1-1/4	.118	10
41062	3/16	1-1/4	1-9/16	.138	10
41063	1/4	1-1/4	1-9/16	.138	10
41059	1/4	1-5/16	1-3/4	.138	10
41066	5/16	1-1/4	1-9/16	.138	10
41064	5/16	1-3/8	1-3/4	.138	10
41060	7/16	1-5/8	1-15/16	.138	10
*41065	7/16	1-3/4	2-1/4	.177	10

\*plain

## BOLT SNAP

- Swiveling round eye. Polished solid bronze.



J&B #	SIZE	DESCRIPTION	OPENING	QTY
R51339	3-5/32	3/4 Round swivel eye	3/8	EA

## SNAP LINK

- Malleable iron with zinc finish.

J&B #	SIZE	QTY
41050	1/4	10
41051	5/16	10
41052	3/8	10
41044	7/16	10
41045	1/2	10
41047	5/8	10



# LINKAGE HARDWARE

## CLEVIS GRAB HOOKS

Grade 43



Grade 70



**WORKING LOAD LIMIT MUST NOT BE EXCEEDED**

- Forged Steel. Zinc plated finish
- Forged Steel. Yellow chromate finish
- Transport Grade

J&B #	CHAIN SIZE	WORKING LOAD LIMIT - LBS.	QTY
38710	1/4	2,600	EA
38711	5/16	3,900	EA
38712	3/8	5,400	EA
38713	1/2	9,200	EA

J&B #	CHAIN SIZE	WORKING LOAD LIMIT - LBS.	QTY
57038	1/4	3,150	EA
57039	5/16	4,700	EA
57046	3/8	6,600	EA

## CLEVIS SLIP HOOKS

Grade 43

- Forged Steel. Zinc plated finish.

J&B #	CHAIN SIZE	WORKING LOAD LIMIT - LBS.	QTY
R52058	1/4	2,600	EA
R52059	5/16	3,900	EA
R52060	3/8	5,400	EA



5/16 & 3/8 with latch



1/4 without latch



# LINKAGE HARDWARE

## UNIVERSAL CLEVIS PINS

Zinc Plated

J&B #	SIZE	QTY
13185	1/4 x 2	10
13186	5/16 x 2	10
13187	3/8 x 2	10
13188	7/16 x 2	10
13189	1/2 x 2	10
38960	5/8 x 3	5
38961	3/4 x 3	5

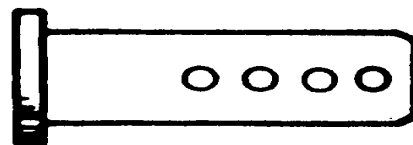

\* Length is under the head to the end of pin.

## STANDARD CLEVIS PINS

Zinc Plated

\* Length is under the head to the end of pin.

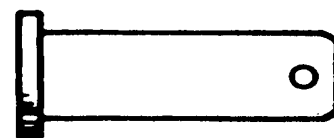

J&B #	SIZE	QTY
37480	3/16 x 1/2	10
37481	3/16 x 3/4	10
37482	3/16 x 1	10
37483	3/16 x 1-1/2	10

J&B #	SIZE	QTY
37486	1/4 x 3/4	10
37500	1/4 x 1	10
37501	1/4 x 1-1/4	10
37502	1/4 x 1-1/2	10
37450	1/4 x 1-3/4	10
37451	1/4 x 2	10

J&B #	SIZE	QTY
37506	5/16 x 1	10
37507	5/16 x 1-1/4	10
37508	5/16 x 1-1/2	10
37456	5/16 x 1-3/4	10
37457	5/16 x 2	10

J&B #	SIZE	QTY
37512	3/8 x 1	10
37513	3/8 x 1-1/4	10
37514	3/8 x 1-1/2	10
37462	3/8 x 1-3/4	10
37463	3/8 x 2	10
37464	3/8 x 2-1/4	10
37465	3/8 x 2-1/2	10

J&B #	SIZE	QTY
37490	7/16 x 1-1/4	10
37524	7/16 x 1-1/2	10
37469	7/16 x 2	10
37470	7/16 x 2-1/2	10

J&B #	SIZE	QTY
40505	1/2 x 1-1/2	10
37473	1/2 x 1-3/4	10
37474	1/2 x 2	10
37475	1/2 x 2-1/4	10
37498	1/2 x 2-1/2	10
37499	1/2 x 3	10

## BRAKE CHAMBER YOKE

J&B #	DESCRIPTION	QTY
40500	5/8-18 NF Thread 1 29/32" Length 1/2" Pin Hole	10

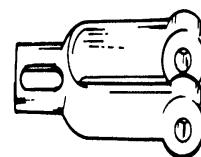

\* Use Clevis pin 40505 for brake chamber yoke

# CHAIN HARDWARE

## DOUBLE CLEVIS LINKS

- Designed for linking all popular sizes of chain to rings, end links, eye hooks, pad eyes, tractor eyebolts, etc.
- Pin can be removed with pliers or screwdriver.
- All pins alloy steel, quenched and tempered.

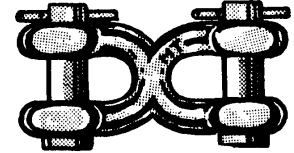
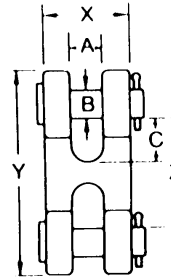

J&B #	CHAIN SIZE HIGH TEST GRADE 43	CHAIN SIZE TRANSPORT GRADE 70	A	B	C	X	Y	Z	WORK LOAD LIMIT	QTY
41502	1/4 or 5/16	1/4	13/32	3/8	7/16	1-1/8	2-5/8	1-5/16	3,900	2

## COLD SHUTS

- Zinc plated.

J&B #	SIZE OF CHAIN	WORK LOAD LIMIT	QTY
41518	1/4	800	10
41519	5/16	1,300	10
41520	3/8	1,900	10

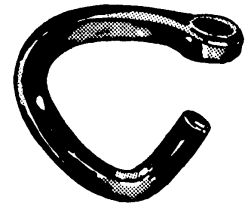

## QUICK LINK

- Beveled hex nut. Steel with zinc finish.

J&B #	SIZE	WORK LOAD LIMIT	QTY
R79101	1/8	220 LBS	EA
R52622	3/16	660 LBS	EA
R52623	1/4	880 LBS	EA
R52624	5/16	1,760 LBS	EA
R52625	3/8	2,200 LBS	EA
R52604	1/2	3,300 LBS	EA



# CHAIN

## ASA STANDARD ROLLER CHAIN

- For chain drive power transmission.
- The finest quality imported roller chain with longer wear life and higher resistance to fatigue.
- Connecting parts are made to American standard specifications.
- One connecting link furnished.

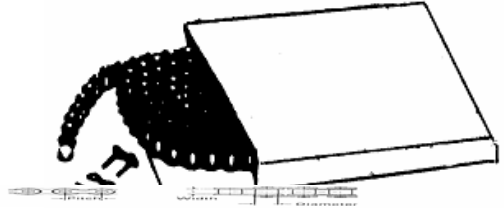

ASA NO.	J&B #	PITCH IN INCHES	ROLLER IN INCHES		TENSILE STRENGTH	QTY
			WIDTH	DIAMETER		
40	38944	1/2	5/16	.156	3700	10 FT.
50	39006	5/8	3/8	.400	6100	10 FT.
60	39007	3/4	1/2	15/16	8500	10 FT.
80	39008	1	5/8	5/8	14500	10 FT.

### CONNECTING LINKS

- Connecting links are inserted between sections (10 Ft.) of roller chain.



J&B #	INDUSTRIAL #	QTY
13478	#35	4
13480	#40	4
13479	#41	4
13481	#50	4
13482	#60	3
13491	#80	2

### OFFSET LINKS

- Offset links are used to adjust the length of the chain.



J&B #	INDUSTRIAL #	QTY
13486	#35	4
13483	#40	4
13487	#41	4
13484	#50	4
13485	#60	3
13492	#80	2

Replacement links fit specified chain size requirements for repairs on:

- Smaller farm machinery
- Small tractors, tillers
- Printing presses, conveyors
- Cement mixers, washing machines
- Motorcycles and mini-bikes
- Bicycles and Go-Carts
- Industrial Machines
- Aqua-Cats, lawn mowers

# HARDWARE

---

## COMMON NAILS

- Bright smooth shank.



J&B #	SIZE	LENGTH	QTY
46450	4D	1-1/2	1 lb
46451	6D	2"	1 lb
46452	8D	2-1/2	1 lb
46453	10D	3"	1 lb
46454	12D	3-1/4	1 lb
46455	16D	3-1/2	1 lb
46456	20D	4"	1 lb

\*Cannot break a box

---

## HEAVY OPEN S HOOKS

- Zinc plated steel.
- Do not use for overhead lifting, support of human weight, athletic or playground equipment. When safety is involved, consult the manufacturer.



J&B #	SIZE	WEIGHT LIMIT	DIAMETER	UNIT WEIGHT	QTY
46400	1"	20 lbs.	1/8	.006	50
46401	1-1/2"	40 lbs.	3/16	.021	50
46402	2"	125 lbs.	1/4	.064	25
46403	2-1/2"	140 lbs.	5/16	.108	25

---

# RIVETS

## DOMED HEAD

- Aluminum rivets have a polished and sealed finish.
- Steel mandrels are plain with a corrosion protective coating.



ALUMINUM DOME / ALUMINUM MANDREL				
RIVET DIA.	DESCRIPTION #	J&B #	GRIP RANGE	QTY
1/8	4-2	13319	1/16 to 1/8	250
1/8	4-4	13322	3/16 to 1/4	250
1/8	4-5	32091	1/4 to 5/16	250
1/8	4-6	13323	5/16 to 3/8	250
1/8	4-8	12260	3/8 to 1/2	250
5/32	5-4	13326	3/16 to 1/4	250
3/16	6-4	13330	1/8 to 1/4	250
3/16	6-6	13332	1/4 to 3/8	250
3/16	6-8	13334	3/8 to 1/2	250
3/16	6-12	32116	5/8 to 3/4	250
1/4	8-6	39015	1/4 to 3/8	100

STEEL DOME / STEEL MANDREL				
RIVET DIA.	DESCRIPTION #	J&B #	GRIP RANGE	QTY
1/8	4-2	13317	1/16 to 1/8	250
1/8	4-4	13320	3/16 to 1/4	250
1/8	4-6	12262	5/16 to 3/8	250
1/8	4-8	12263	3/8 to 1/2	250
3/16	6-2	32092	1/16 to 1/8	250
3/16	6-4	32093	3/16 to 1/4	250
3/16	6-6	32094	1/4 to 3/8	250
3/16	6-8	32095	3/8 to 1/2	250
1/4	8-6	32096	1/4 to 3/8	100
1/4	8-8	32097	3/8 to 1/2	100

## DOMED HEAD (Large Flange)



ALUMINUM DOME / ALUMINUM MANDREL				
RIVET DIA.	DESCRIPTION #	J&B #	GRIP RANGE	QTY
3/16	6-6	13337	1/4 to 3/8	250
3/16	6-8	13338	3/8 to 1/2	250
3/16	6-12	39018	5/8 to 3/4	250

STEEL DOME / STEEL MANDREL				
RIVET DIA.	DESCRIPTION #	J&B #	GRIP RANGE	QTY
3/16	6-8	12269	3/8 to 1/2	250



# RIVET CHART

(ACTUAL SIZES)

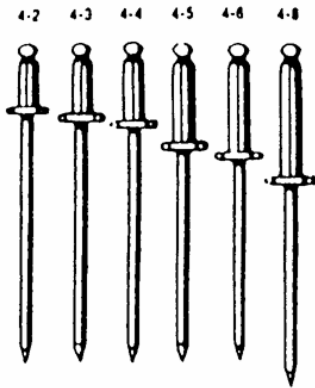

1/8 Diameter

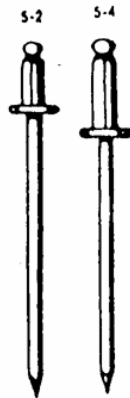

5/32 Diameter

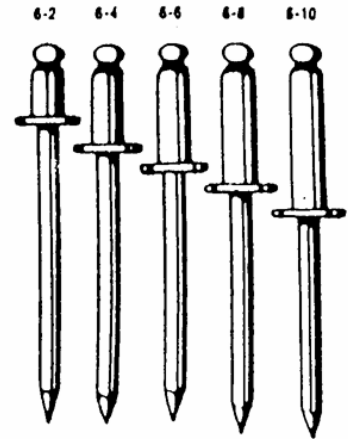

3/16 Diameter

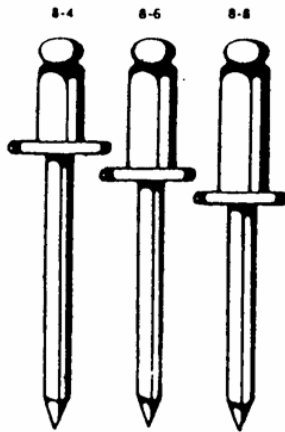

1/4 Diameter

COUNTERSUNK HEAD

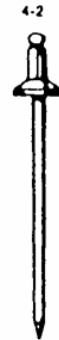

1/8 Diameter

LARGE FLANGE

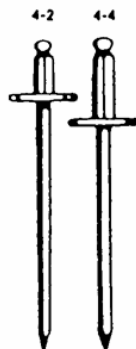

1/8 Diameter

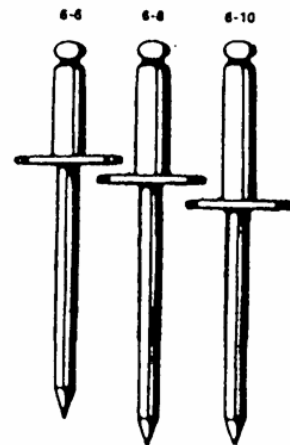

3/16 Diameter

# RIVETS

## STRUCTURAL - SELF-PLUGGING RIVETS

- **HIGH CLAMP-UP:** The T Rivet will draw sheets firmly together, even when separated by as much as 3/16".
- **NON-CRITICAL HOLE SIZE:** The T Rivet will function properly in holes as much as 1/32" oversize.
- **EXTREMELY HIGH SHEAR AND TENSILE STRENGTH:** The hardened mandrel in the T Rivet provides high tensile strength and shear values comparable to solid rivets or machine screws.

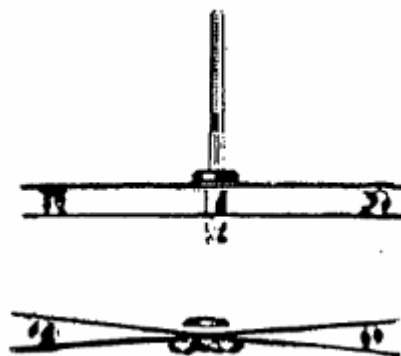

J&B #	GRIP RANGE	DESCRIPTION	QTY	
39196	.030 / .140	Window Regulator Rivet	25	
39194	090 / .115	Outside Door Handle Rivet	25	

### "PEEL TYPE" RIVET

J&B #	MAKE & YR	PANEL RANGE	HOLE DIA	QTY	
41879	GM, FORD, CHRYSLER 71-ON	1/32 – 9/64	1/4	50	
41881	GM, FORD, CHEVY 76-ON	33/64 – 19/32	1/4	25	

### "SPLIT-TYPE" RIVET

J&B #	MAKE & YR	PANEL RANGE	HOLE DIA	QTY	
45904	FORD 92' -On CHRYSLER 92 - On	3/16 - 3/8	1/4	25	

# RIVETS

## BACK UP WASHERS

- Use with domed head rivets.
- Use when fastening soft materials or to compensate for oversize holes.



J&B #	MATERIAL	HOLE SIZE	DIAMETER	QTY
39010	STEEL	1/8	3/8	250
39011	STEEL	3/16	1/2	250
39012	ALUM	1/8	3/8	250
39013	ALUM	3/16	1/2	250

## NYLON BLIND RIVET

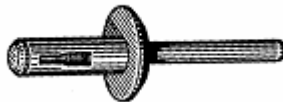

J&B #	MAKE & YR	PANEL RANGE	HOLE DIA	QTY
45830	GM, FORD	1/16 – 11/64	13/64	25
45834	GM	3/32 – 3/16	17/64	25
42098	GM	3/32 – 3/16	17/64	25
45832	GM, FORD, CHRY	5/32 – 13/32	1/4	25
41842	GM, FORD, CHRY	5/32 – 13/32	1/4	25
45836	CHRY	15/64 – 25/64	13/64	25
40914	CHRY, FORD	5/16 – 15/32	1/4	25

## ALUMINUM SPLIT-TYPE RIVET





J&B #	MAKE & YR	GRIP RANGE	DIA	QTY
45858	APV Vans 90' - On	3/64 – 11/32	3/16	25
45860	GM, FORD	5/64 – 15/64	3/16	25



# RIVETS

## ALUMINUM SPLIT-TYPE RIVET

Black

J&B #	MAKE & YR	GRIP RANGE	FLANGE DIA	DIA	QTY
59134	Ford T-Bird & Mercury cougar 89-on 	1/8 – 3/16	3/8	1/8	50
59136	Bumper Fascia & General Purpose GM 1990-on 	3/64 – 23/64	5/8	3/16	25

# RIVETS

---

## HEAVY DUTY LEVER RIVET GUN RivetKing

- Full capacity riveting tool capable of setting full range of blind rivet sizes from 1/8" (nose piece sold separately), 5/32", 3/16" and 1/4".
- The geared head design reduces operator effort and fatigue.
- Nose pieces are stored onboard for easy accessibility (5/32", 3/16" & 1/4").



J&B #	QTY
1808	EA

---

## HEAVY DUTY PISTOL RIVET GUN RivetKing

- Full capacity riveting tool capable of setting full range of blind rivet sizes up to 5/32" and 3/16" materials excluding high force or structural rivets).
- The best in manual squeeze riveting.
- Nose pieces are stored onboard for easy accessibility (3/32", 1/8", 5/32" & 3/16").

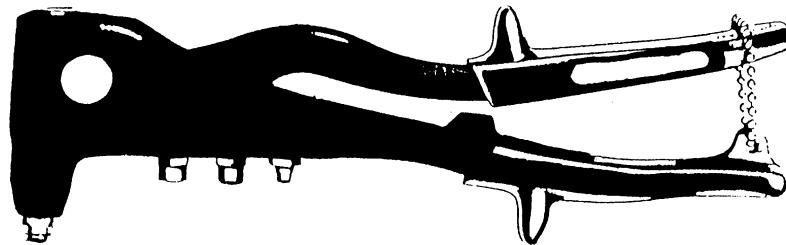

J&B #	QTY
1404	EA

# RIVETS

---

## PNEUMATIC RIVET GUN RivetKing

- Economy grade pneumatic rivet gun for use on all materials.
- For use on 3/32", 1/8", 5/32" and 3/16" rivets.
- Comes with nose pieces for all the above sizes.

J&B #	MODEL#	QTY
24235	RK-187	EA

- Max. air pressure: 90 PSI \* Traction power: 1980 lbs \*  
Stroke: .625" \* Air consumption: .017 CuFt. \* Min.  
Hose Size: 3/8" ID \* Air inlet: 1/4" NPT \* Net Weight:  
3.3 lbs.



# RUBBER 'O' RINGS

- O-Rings effectively resist petroleum-based oils, most silicone fluids, hydraulic, and nonaromatic fuels and solvents.
- Excellent working properties such as low compression set, high tensile strength, and high abrasion resistance.
- Has excellent compression set. Temperature range -65° to +275°.

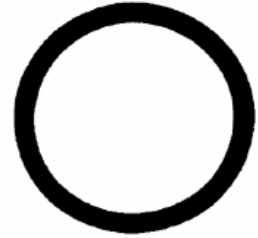

## O-RING CROSS REFERENCE

All "O" Rings are manufactured to commercial 6227 specifications for hydraulic use. The OR-number shown is an industry wide numbering system and is used in conjunction with the spec number i.e. 6227-1.

1/16" DIAMETER					
J&B #	I. D.	O. D.	NAT. #	ARP #	QTY
12606	1/8	1/4	OR-1	ARP-006	25
12607	5/32	9/32	OR-2	ARP-007	25
12608	3/16	5/16	OR-3	ARP-008	25
12609	7/32	11/32	OR-4	ARP-009	25
12610	1/4	3/8	OR-5	ARP-010	25
12611	5/16	7/16	OR-6	ARP-011	25
12612	3/8	1/2	OR-7	ARP-012	25
39900	7/16	9/16		ARP-013	15
39901	1/2	5/8		ARP-014	15
39902	9/16	11/16		ARP-015	15
39903	5/8	3/4		ARP-016	15
39904	11/16	13/16		ARP-017	15
39905	3/4	7/8		ARP-018	15
39906	13/16	15/16		ARP-019	15
39907	7/8	1		ARP-020	15
39908	15/16	1-1/16		ARP-021	15
39909	1	1-1/8		ARP-022	10
39910	1-1/8	1-1/4		ARP-024	10
39911	1-1/4	1-3/8		ARP-026	10
39912	1-3/8	1-1/2		ARP-028	10
39913	1-1/2	1-5/8		ARP-029	10
39914	1-5/8	1-3/4		ARP-030	5
39915	1-3/4	1-7/8		ARP-031	5
39916	1-7/8	2		ARP-032	5



# RUBBER 'O' RINGS

## O-RING CROSS REFERENCE

3/32" DIAMETER					
J&B #	I. D.	O. D.	NAT. #	ARP #	QTY
12613	3/8	9/16	OR- 8	ARP-110	25
12614	7/16	5/8	OR- 9	ARP-111	25
12615	1/2	11/16	OR-10	ARP-112	25
12616	9/16	3/4	OR-11	ARP-113	10
12617	5/8	13/16	OR-12	ARP-114	10
12618	11/16	7/8	OR-13	ARP-115	10
12619	3/4	15/16	OR-14	ARP-116	10
39940	13/16	1		ARP-117	10
39941	7/8	1-1/16		ARP-118	10
39942	15/16	1-1/8		ARP-119	10
39943	1	1-3/16		ARP-120	10
39944	1-1/16	1-1/4		ARP-121	10
39945	1-1/8	1-5/16		ARP-122	10
39946	1-3/16	1-3/8		ARP-123	10
39947	1-1/4	1-7/16		ARP-124	10
39948	1-3/8	1-9/16		ARP-126	5
39949	1-1/2	1-11/16		ARP-128	5
39950	1-5/8	1-13/16		ARP-130	5
39951	1-3/4	1-15/16		ARP-132	5
39952	1-7/8	2-1/16		ARP-134	5
39953	2	2-3/16		ARP-136	5

1/8" DIAMETER					
J&B #	I. D.	O. D.	NAT. #	ARP #	QTY
39986	11/16	15/16	OR-15	ARP-209	10
12620	3/4	1	OR-16	ARP-210	10
12621	13/16	1-1/16	OR-17	ARP-211	10
12622	7/8	1-1/8	OR-18	ARP-212	10
12623	15/16	1-3/16	OR-19	ARP-213	10
12624	1	1-1/4	OR-20	ARP-214	10
12625	1-1/16	1-5/16	OR-21	ARP-215	10
12626	1-1/8	1-3/8	OR-22	ARP-216	10
12627	1-3/16	1-7/16	OR-23	ARP-217	10
12628	1-1/4	1-1/2	OR-24	ARP-218	10
12629	1-5/16	1-9/16	OR-25	ARP-219	10
12630	1-3/8	1-5/8	OR-26	ARP-220	10
12631	1-7/16	1-11/16	OR-27	ARP-221	10
12632	1-1/2	1-3/4		ARP-222	10
39980	1-5/8	1-7/8		ARP-223	5
39981	1-3/4	2		ARP-224	5
39982	1-7/8	2-1/8		ARP-225	5
39983	2	2-1/4		ARP-226	5
39984	2-1/8	2-3/8		ARP-227	5
39985	2-1/4	2-1/2		ARP-228	5

# RUBBER 'O' RINGS

## O-RING CROSS REFERENCE

3/16" DIAMETER					
J&B #	I. D.	O. D.	NAT. #	ARP #	QTY
12633	1-1/2	1-7/8	OR-28	ARP-325	10
12634	1-5/8	2	OR-29	ARP-326	10
12635	1-3/4	2-1/8	OR-30	ARP-327	10
13448	1-7/8	2-1/4	OR-31	ARP-328	5
13449	2	2-3/8	OR-32	ARP-329	5
13450	2-1/8	2-1/2	OR-33	ARP-330	5
13451	2-1/4	2-5/8	OR-34	ARP-331	5
13452	2-3/8	2-3/4	OR-35	ARP-332	5
13453	2-1/2	2-7/8	OR-36	ARP-333	5
13454	2-5/8	3	OR-37	ARP-334	5
13455	2-3/4	3-1/8	OR-38	ARP-335	5
13456	2-7/8	3-1/4	OR-39	ARP-336	5
13457	3	3-3/8	OR-40	ARP-337	5

## RUBBER 'O' RINGS

1/16" WIDTH



12606	QTY. 25
1/8 ID	1/4 OD

12607	QTY. 25
5/32 ID	9/32 OD

12608	QTY. 25
3/16 ID	5/16 OD

12609	QTY. 25
7/32 ID	11/32 OD



12610	QTY. 25
1/4 ID	3/8 OD

12611	QTY. 25
5/16 ID	7/16 OD

12612	QTY. 25
3/8 ID	1/2 OD

# RUBBER 'O' RINGS

---

3/32" WIDTH



12613	QTY. 25
3/8 ID	9/16 OD

12614	QTY. 25
7/16 ID	5/8 OD

12615	QTY. 25
1/2 ID	11/16 OD

12616	QTY. 10
9/16 ID	3/4 OD



12617	QTY. 10
5/8 ID	13/16 OD

12618	QTY. 10
11/16 ID	7/8 OD

12619	QTY. 10
3/4 ID	15/16 OD

---

1/8" WIDTH



12620	QTY. 10
3/4 ID	1" OD

12621	QTY. 10
13/16 ID	1-1/16 OD

12622	QTY. 10
7/8 ID	1-1/8 OD

12623	QTY. 10
15/16 ID	1-3/16 OD

# RUBBER 'O' RINGS

---

1/8" WIDTH

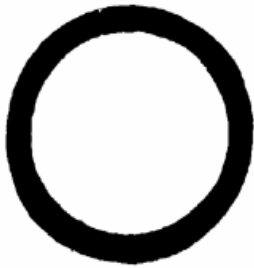

12624	QTY. 10
1" ID	1-1/4 OD



12625	QTY. 10
1-1/16 ID	1-5/16 OD

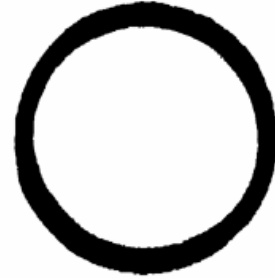

12626	QTY. 10
1-1/8 ID	1-3/8 OD

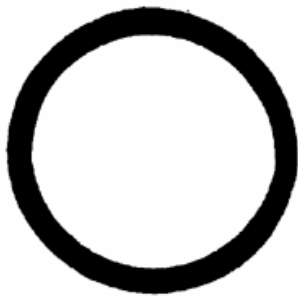

12627	QTY. 10
1-3/16 ID	1-7/16 OD

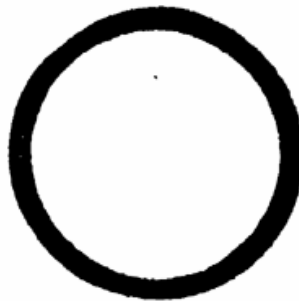

12628	QTY. 10
1-1/4 ID	1-1/2 OD

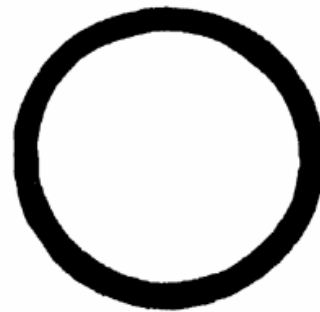

12629	QTY. 10
1-5/16 ID	1-9/16 OD



12630	QTY. 10
1-3/8 ID	1-5/8 OD



12631	QTY. 10
1-7/16 ID	1-11/16 OD

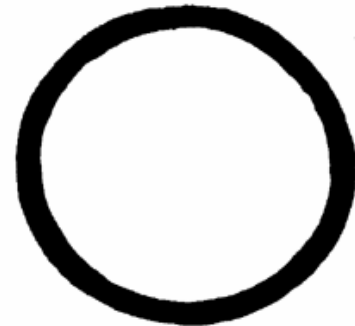

12632	QTY. 10
1-1/2 ID	1-3/4 OD



# RUBBER 'O' RINGS

3/16" WIDTH

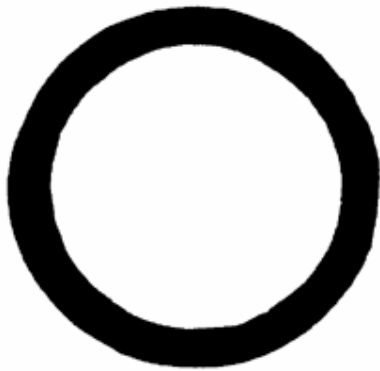

12633	QTY. 10
1-1/2 ID	1-7/8 OD

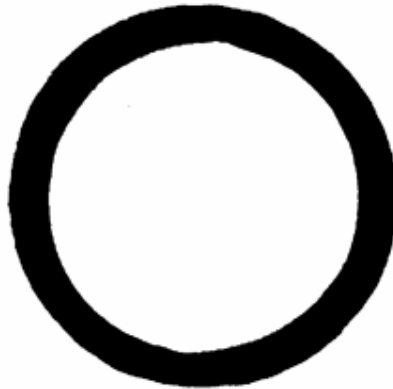

12634	QTY. 10
1-5/8 ID	2" OD

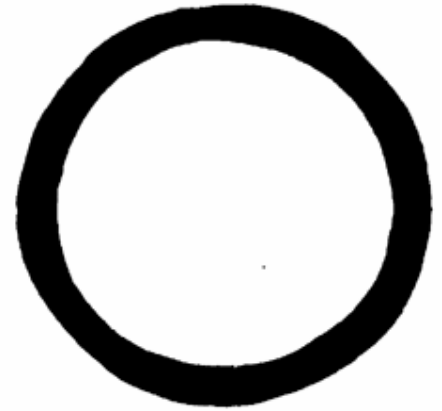

12635	QTY. 10
1-3/4 ID	2-1/8 OD

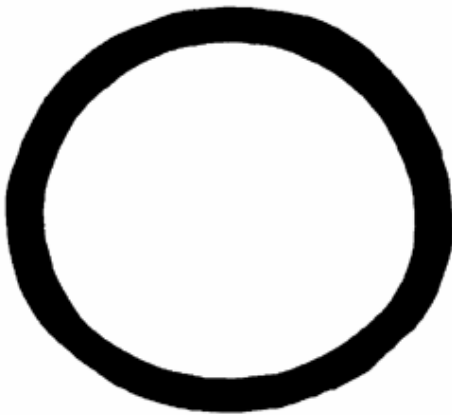

13448	QTY. 5
1-7/8 ID	2-1/4 OD

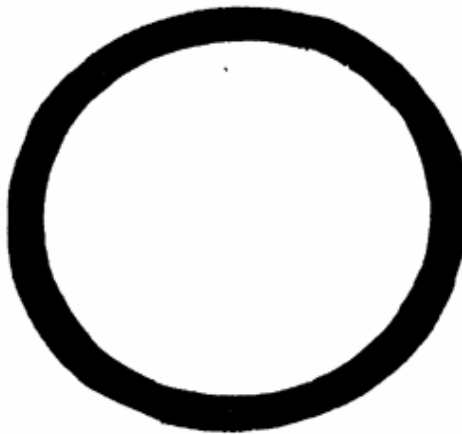

13449	QTY. 5
2" ID	2-3/8 OD

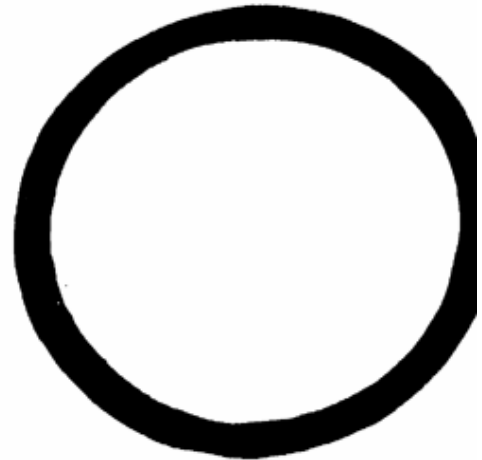

13450	QTY. 5
2-1/8 ID	2-1/2 OD

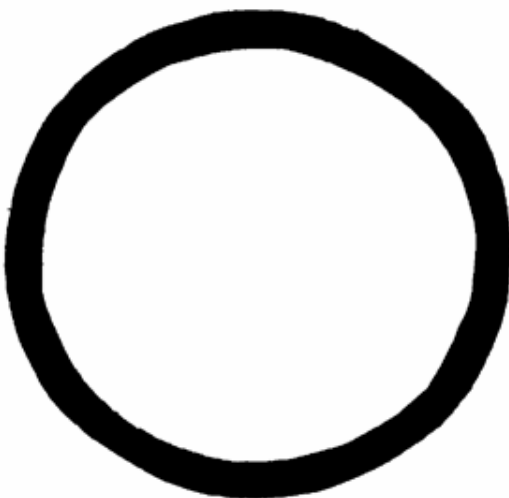

13451	QTY. 5
2-1/4 ID	2-5/8 OD

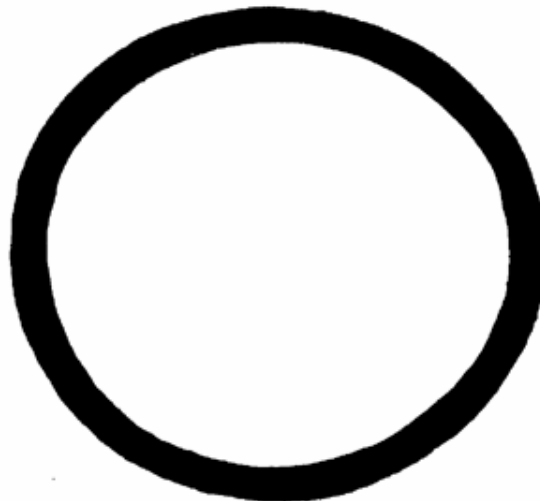

13452	QTY. 5
2-3/8 ID	2-3/4 OD



# RUBBER 'O' RINGS

---

3/16" WIDTH

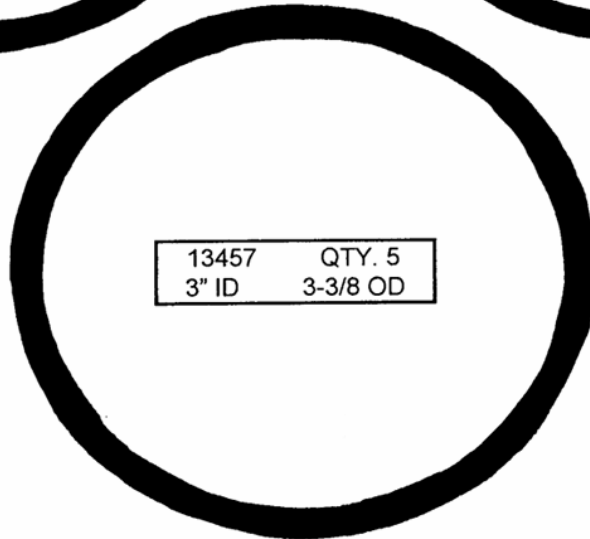
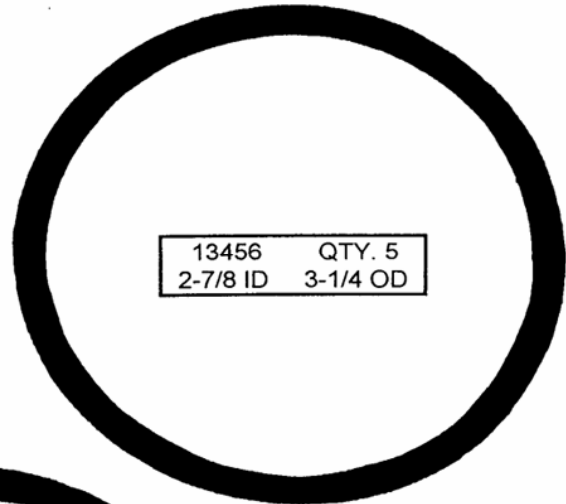
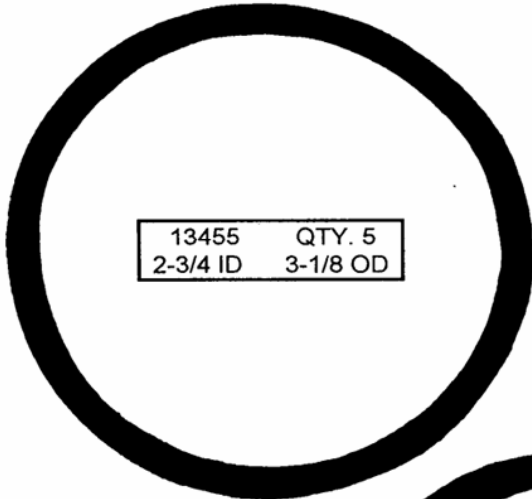
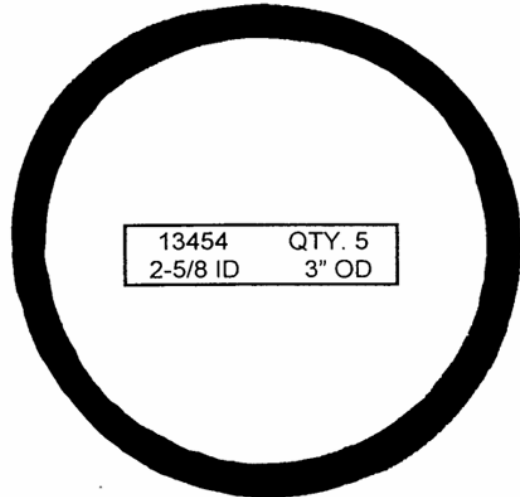
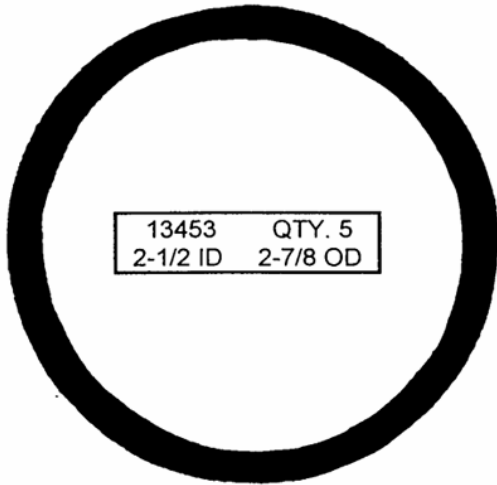

# RUBBER 'O' RINGS

## SIZING CHART

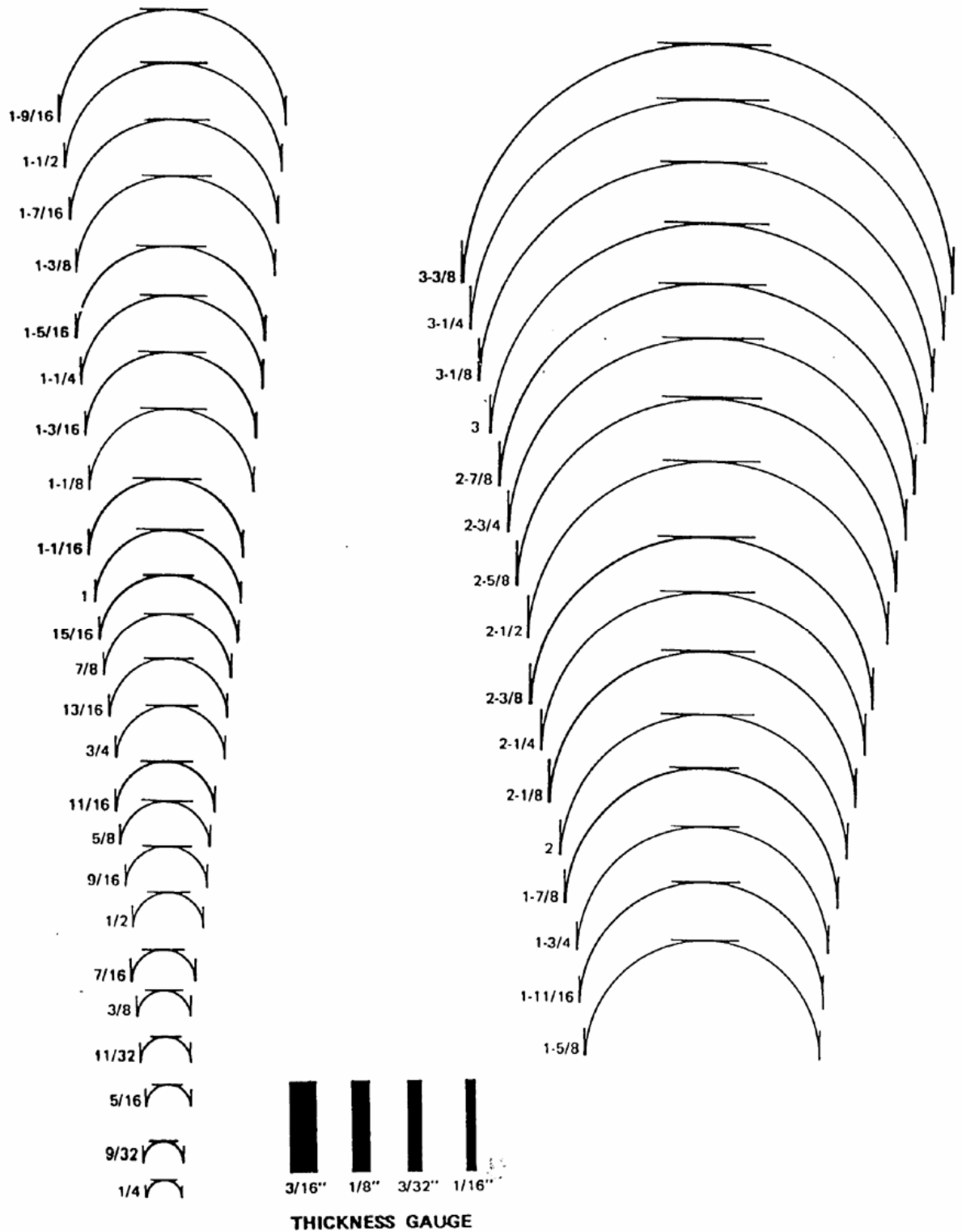

# RUBBER 'O' RINGS

## HNBR O-RING ASSORTMENT High Temperature

- 270 piece kit contains 18 popular o-ring sizes.
- Hydrogenated Nitrile Butadiene Rubber (HNBR), also known as Highly Saturated Nitrile (HSN) is a special class of nitrile rubber & is for mission critical applications.
- Temperature range of -49 F (-45 C) to 329 F (165 C).
- HNBR is classified by ASTM as DH-type polymer.
- Suitable for many hydrocarbons, fats, oils, gas, etc..
- **NOT SUITABLE FOR USE WITH BRAKE FLUIDS.**
- Good Abrasion resistance & resistant to compression.
- High Tensile strength.



I/D	Section	I/D	Section
7/32	1/16	7.8	1.9
1/4	1/16	8.8	1.9
5/16	1/16	13.9	1.9
7/16	1/16	8	2
11/16	1/16	11	2
7/16	3/32	12	2
9/16	3/32	14	2
11/16	1/8	15	2
6.8	1.9	17	2

J&B #	QTY
2283	EA

**O-RING ASSORTMENTS...  
SEE PAGES 2546 – 2549 & PAGE 2592**

**METRIC O-RINGS LOCATED ON PAGE 2549**

# RUBBER 'O' RINGS

## O-RING SPLICING KIT

- Makes any size O-ring from cord or wrong size keys.
- Eliminates delays from out-of-stock situations.
- Works with most ring materials.
- Replaces rings without machine disassembly.

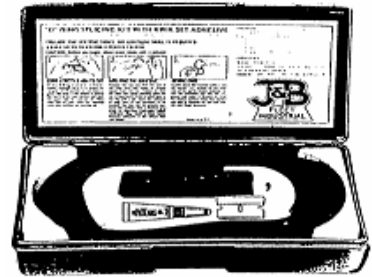

J&B #	QTY
38800	EA

## REPLACEMENT BUNA-N CORD STOCK

J&B #	DIAMETER	LENGTH	QTY
39045	3/32	3'	EA
39046	1/8	3'	EA
39047	3/16	3'	EA
39048	1/4	3'	EA



## RUBBER GROMMETS

- For protecting and insulating automotive and industrial wiring, cables, tubing, etc., installed through metal paneling.
- Used to prevent vibration, wire or tubing damage, and shorts.

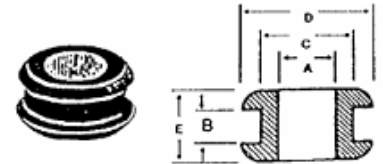

J&B #	A BORE DIAMETER	B GROOVE WIDTH	C GROOVE DIAMETER	D OUTSIDE DIAMETER	E OVERALL THICKNESS	QTY
38201	1/8	3/32	3/8	1/2	5/16	25
38172	5/32	1/16	1/4	3/8	3/16	25
38202	3/16	1/16	5/16	1/2	1/4	25
38173	3/16	1/4	5/16	7/16	3/8	25
38204	1/4	1/16	7/16	5/8	3/16	25
38205	1/4	1/16	1"	1-1/4	1/4	25
38206	5/16	1/16	9/16	13/16	5/16	25
38207	5/16	1/8	9/16	13/16	3/8	25
38208	5/16	1/4	9/16	13/16	1/2	25
38209	3/8	1/16	1/2	5/8	9/32	25
38210	3/8	1/16	1"	1-1/4	1/4	25
38213	1/2	3/32	3/4	31/32	9/32	25
38216	1/2	1/4	13/16	1-1/16	1/2	25
38217	5/8	1/8	7/8	1-1/8	3/8	25
38218	5/8	1/16	7/8	1-1/8	5/16	25
38220	3/4	1/16	1-1/16	1-3/8	3/8	25
38221	3/4	1/16	1-1/4	1-5/8	1/4	25
38222	3/4	1/4	1-1/4	1-5/8	7/16	25

# RETAINING RINGS

## INTERNAL SNAP TYPE

(Rings Actual Size)

- Internal rings fit in a groove in the housing bore.
- Unlimited universal applications: Industrial, power equipment, cars, trucks, garden equipment.



#10638 QTY. 50  
1/4" Housing



#10639 QTY. 50  
5/16" Housing



#10640 QTY. 25  
3/8" Housing



#10641 QTY. 25  
7/16" Housing



#10642 QTY. 25  
1/2" Housing



#10643 QTY. 25  
9/16" Housing



#10644 QTY. 20  
5/8" Housing



#40030 QTY. 15  
11/16" Housing



#10645 QTY. 25  
3/4" Housing



#40031 QTY. 15  
13/16" Housing



#10646 QTY. 15  
7/8" Housing

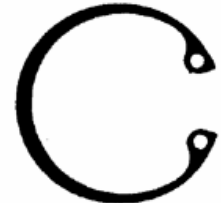

#10647 QTY. 10  
1" Housing

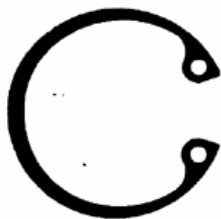

#40032 QTY. 10  
1-1/16" Housing



#10648 QTY. 10  
1-1/8" Housing

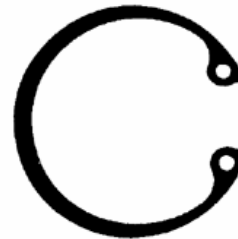

#40033 QTY. 10  
1-3/16" Housing

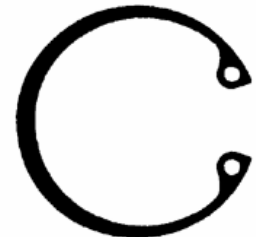

#10649 QTY. 10  
1-1/4" Housing

# RETAINING RINGS

---

## INTERNAL SNAP TYPE (Rings Actual Size)

- Internal rings fit in a groove in the housing bore.
- Unlimited universal applications: Industrial, power equipment, cars, trucks, garden equipment.

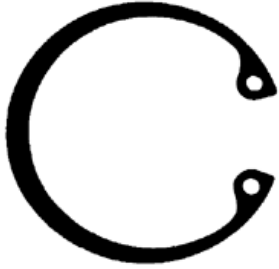

#40044 QTY. 10  
1-5/16" Housing

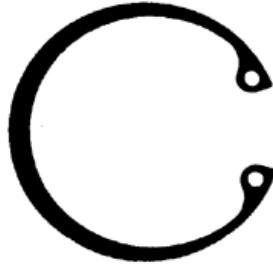

#40045 QTY. 10  
1-3/8" Housing

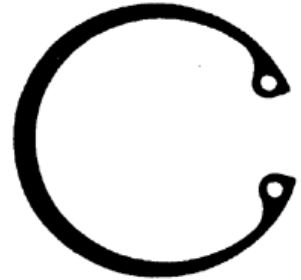

#40046 QTY. 10  
1-7/16" Housing

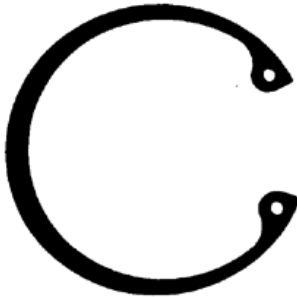

#40047 QTY. 10  
1-1/2" Housing

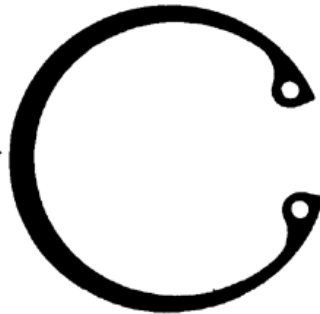

#40048 QTY. 10  
1-5/8" Housing

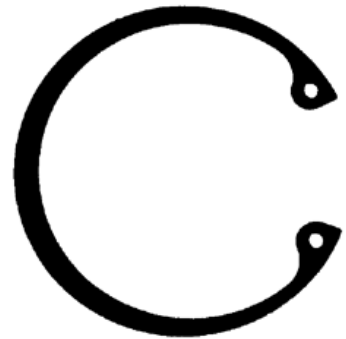

#40049 QTY. 10  
1-3/4" Housing

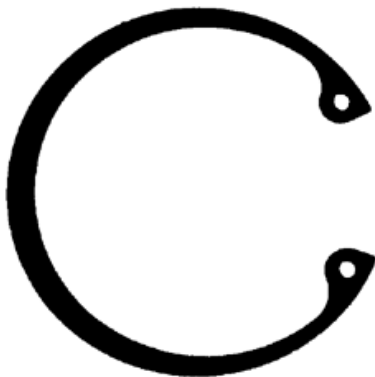

#86999 QTY. 10  
2" Housing

# RETAINING RINGS

## EXTERNAL SNAP TYPE (Rings Actual Size)

- Rings require a groove on the shaft.
- Unlimited universal applications: cars, trucks, industrial, power equipment.



#87000 QTY. 50  
1/8" Shaft



#40055 QTY. 50  
3/16" Shaft



#10650 QTY. 50  
1/4" Shaft



#40056 QTY. 50  
9/32" Shaft



#10651 QTY. 50  
5/16" Shaft



#40057 QTY. 50  
11/32" Shaft



#10652 QTY. 25  
3/8" Shaft



#87001 QTY. 25  
13/32" Shaft



#10653 QTY. 25  
7/16" Shaft



#10654 QTY. 25  
1/2" Shaft



#10655 QTY. 20  
9/16" Shaft



#10656 QTY. 20  
5/8" Shaft



#10762 QTY. 15  
11/16" Shaft



#10657 QTY. 15  
3/4" Shaft



#87002 QTY. 15  
13/16" Shaft



#10658 QTY. 15  
7/8" Shaft



# RETAINING RINGS

## EXTERNAL SNAP TYPE (Rings Actual Size)

- Rings require a groove on the shaft.
- Unlimited universal applications: cars, trucks, industrial, power equipment.



#87003 QTY. 10  
15/16" Shaft



#10659 QTY. 10  
1" Shaft



#40058 QTY. 10  
1-1/16" Shaft



#10660 QTY. 10  
1-1/8" Shaft



#40059 QTY. 10  
1-3/16" Shaft



#10661 QTY. 10  
1-1/4" Shaft



#40060 QTY. 10  
1-5/16" Shaft



#40061 QTY. 10  
1-3/8" Shaft



#40062 QTY. 10  
1-7/16" Shaft

# RETAINING RINGS

## EXTERNAL SNAP TYPE (Rings Actual Size)

- Rings require a groove on the shaft.



#40063 QTY. 10  
1-1/2" Shaft



#40064 QTY. 10  
1-5/8" Shaft



#40065 QTY. 10  
1-3/4" Shaft



#87004 QTY. 10  
1-7/8" Shaft



#40066 QTY. 10  
2" Shaft



#87005 QTY. 5  
2-1/8" Shaft



#87006 QTY. 5  
2-1/4" Shaft

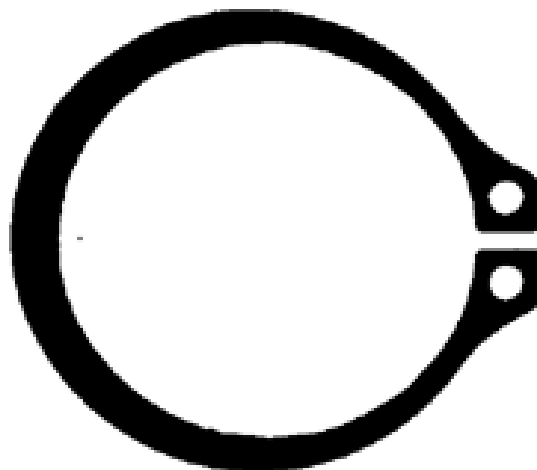

#87007 QTY. 5  
2-3/8" Shaft

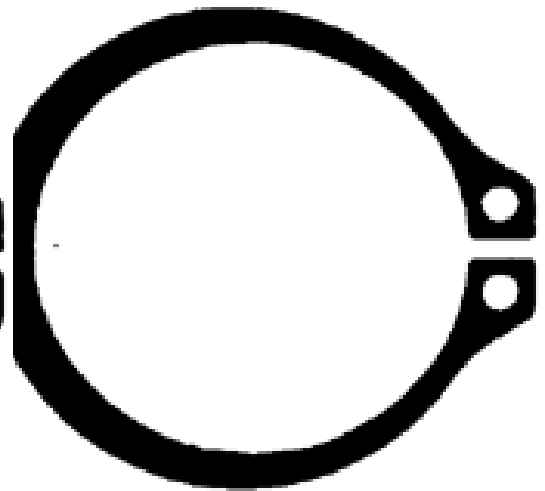

#87008 QTY. 5  
2-1/2" Shaft

# RETAINING RINGS

## E TYPE

(Rings Actual Size)

- These external rings provide three-way contact.
- Unlimited universal applications: Industrial, machinery, cars, trucks, snow plows.



#12706 QTY 100  
1/16" Shaft



#12711 QTY 100  
3/32" Shaft



#12712 QTY 100  
1/8" Shaft



#12707 QTY 100  
9/64" Shaft



#12713 QTY 100  
5/32" Shaft



#12708 QTY 100  
11/64" Shaft



#12714 QTY 100  
3/16" Shaft



#12717 QTY 100  
7/32" Shaft



#12715 QTY 50  
1/4" Shaft



#12716 QTY 50  
5/16" Shaft



#10951 QTY. 25  
3/8" Shaft



#12718 QTY. 25  
7/16" Shaft



#12719 QTY. 25  
1/2" Shaft



#12768 QTY. 25  
9/16" Shaft



#11094 QTY. 25  
5/8" Shaft

# RETAINING RINGS

---

## E TYPE (Rings Actual Size)

- These external rings provide three-way contact.
- Unlimited universal applications: Industrial, machinery, cars, trucks, snow plows.



#11095 QTY. 25  
3/4" Shaft



#11096 QTY. 20  
7/8" Shaft



#11097 QTY. 20  
1" Shaft



#12709 QTY. 20  
1-3/16" Shaft



#12710 QTY. 20  
1-3/8" Shaft



# J&B Fleet - Industrial Supply

























22428 Harrisburg-Westville Rd. Alliance, Ohio 44601 Phone: (330) 821-6342 Fax: (330) 821-0411

[www.jbfleet.com](http://www.jbfleet.com)



PART # 2021

## COTTER PINS 1/16 – 5/32

<p><b>12330</b> <sup>1</sup></p>  <p>50 <b>1/16 X 1/2</b></p>	<p><b>12331</b> <sup>2</sup></p>  <p>50 <b>1/16 X 3/4</b></p>	<p><b>12332</b> <sup>3</sup></p>  <p>50 <b>1/16 X 1</b></p>	<p><b>12333</b> <sup>4</sup></p>  <p>50 <b>1/16 X 1-1/4</b></p>	<p><b>12334</b> <sup>5</sup></p>  <p>50 <b>1/16 X 1-1/2</b></p>	<p><b>12336</b> <sup>6</sup></p>  <p>50 <b>1/16 X 2</b></p>
<p><b>12337</b> <sup>7</sup></p>  <p>50 <b>3/32 X 1/2</b></p>	<p><b>12338</b> <sup>8</sup></p>  <p>50 <b>3/32 X 3/4</b></p>	<p><b>12339</b> <sup>9</sup></p>  <p>50 <b>3/32 X 1</b></p>	<p><b>12340</b> <sup>10</sup></p>  <p>50 <b>3/32 X 1-1/4</b></p>	<p><b>12341</b> <sup>11</sup></p>  <p>50 <b>3/32 X 1-1/2</b></p>	<p><b>12343</b> <sup>12</sup></p>  <p>50 <b>3/32 X 2</b></p>
<p><b>12347</b> <sup>13</sup></p>  <p>50 <b>1/8 X 3/4</b></p>	<p><b>12348</b> <sup>14</sup></p>  <p>50 <b>1/8 X 1</b></p>	<p><b>12349</b> <sup>15</sup></p>  <p>50 <b>1/8 X 1-1/4</b></p>	<p><b>12350</b> <sup>16</sup></p>  <p>50 <b>1/8 X 1-1/2</b></p>	<p><b>12351</b> <sup>17</sup></p>  <p>50 <b>1/8 X 1-3/4</b></p>	<p><b>12352</b> <sup>18</sup></p>  <p>50 <b>1/8 X 2</b></p>
<p><b>12356</b> <sup>19</sup></p>  <p>50 <b>5/32 X 3/4</b></p>	<p><b>12357</b> <sup>20</sup></p>  <p>50 <b>5/32 X 1</b></p>	<p><b>12358</b> <sup>21</sup></p>  <p>50 <b>5/32 X 1-1/4</b></p>	<p><b>12359</b> <sup>22</sup></p>  <p>50 <b>5/32 X 1-1/2</b></p>	<p><b>12361</b> <sup>23</sup></p>  <p>50 <b>5/32 X 2</b></p>	<p><b>12363</b> <sup>24</sup></p>  <p>50 <b>5/32 X 2-1/2</b></p>





























# J&B Fleet - Industrial Supply

22428 Harrisburg-Westville Rd. Alliance, Ohio 44601 Phone: (330) 821-6342 Fax: (330) 821-0411

[www.jbfleet.com](http://www.jbfleet.com)

PART # 2095

## COTTER PINS

 <b>12330</b> <sup>1</sup> 1/16 X 1/2 50	 <b>12337</b> <sup>2</sup> 3/32 X 1/2 50	 <b>12347</b> <sup>3</sup> 1/8 X 3/4 50	 <b>12356</b> <sup>4</sup> 5/32 X 3/4 25	 <b>12365</b> <sup>5</sup> 3/16 X 3/4 20	 <b>12376</b> <sup>6</sup> 1/4 X 1-1/2 10
 <b>12332</b> <sup>7</sup> 1/16 X 1 50	 <b>12339</b> <sup>8</sup> 3/32 X 1 50	 <b>12348</b> <sup>9</sup> 1/8 X 1 50	 <b>12359</b> <sup>10</sup> 5/32 X 1-1/2 25	 <b>12368</b> <sup>11</sup> 3/16 X 1-1/2 20	 <b>12378</b> <sup>12</sup> 1/4 X 2 10
 <b>12334</b> <sup>13</sup> 1/16 X 1-1/2 50	 <b>12341</b> <sup>14</sup> 3/32 X 1-1/2 50	 <b>12350</b> <sup>15</sup> 1/8 X 1-1/2 25	 <b>12361</b> <sup>16</sup> 5/32 X 2 25	 <b>12370</b> <sup>17</sup> 3/16 X 2 10	 <b>12385</b> <sup>18</sup> 5/16 X 1-1/2 5
 <b>12336</b> <sup>19</sup> 1/16 X 2 25	 <b>12343</b> <sup>20</sup> 3/32 X 2 25	 <b>12352</b> <sup>21</sup> 1/8 X 2 25	 <b>12363</b> <sup>22</sup> 5/32 X 2-1/2 20	 <b>12374</b> <sup>23</sup> 1/4 X 1 10	 <b>12386</b> <sup>24</sup> 5/16 X 2 5



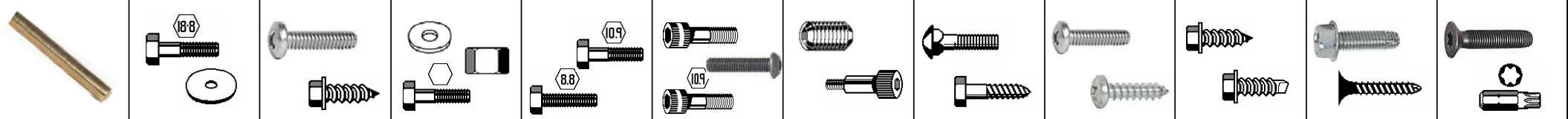

























# J&B Fleet - Industrial Supply

22428 Harrisburg-Westville Rd. Alliance, Ohio 44601 Phone: (330) 821-6342 Fax: (330) 821-0411

[www.jbfleet.com](http://www.jbfleet.com)

PART # 2020

## COTTER PINS 3/16 – 3/8

<p>12365 <sup>1</sup></p>  <p>35</p> <p>3/16 X 3/4</p>	<p>12366 <sup>2</sup></p>  <p>35</p> <p>3/16 X 1</p>	<p>12367 <sup>3</sup></p>  <p>35</p> <p>3/16 X 1-1/4</p>	<p>12368 <sup>4</sup></p>  <p>35</p> <p>3/16 X 1-1/2</p>	<p>12370 <sup>5</sup></p>  <p>35</p> <p>3/16 X 2</p>	<p>12373 <sup>6</sup></p>  <p>35</p> <p>3/16 X 3</p>
<p>12372 <sup>7</sup></p>  <p>35</p> <p>3/16 X 2-1/2</p>	<p>12374 <sup>8</sup></p>  <p>15</p> <p>1/4 X 1</p>	<p>12375 <sup>9</sup></p>  <p>15</p> <p>1/4 X 1-1/4</p>	<p>12376 <sup>10</sup></p>  <p>15</p> <p>1/4 X 1-1/2</p>	<p>12381 <sup>11</sup></p>  <p>15</p> <p>1/4 X 3</p>	<p>12384 <sup>12</sup></p>  <p>15</p> <p>1/4 X 3</p>
<p>12377 <sup>13</sup></p>  <p>15</p> <p>1/4 X 1-3/4</p>	<p>12378 <sup>14</sup></p>  <p>15</p> <p>1/4 X 2</p>	<p>12380 <sup>15</sup></p>  <p>15</p> <p>1/4 X 2-1/2</p>	<p>12384 <sup>16</sup></p>  <p>15</p> <p>5/16 X 1</p>	<p>12388 <sup>17</sup></p>  <p>10</p> <p>5/16 X 3</p>	<p>12388 <sup>18</sup></p>  <p>10</p> <p>5/16 X 3</p>
<p>12385 <sup>19</sup></p>  <p>15</p> <p>5/16 X 1-1/2</p>	<p>12386 <sup>20</sup></p>  <p>15</p> <p>5/16 X 2</p>	<p>12392 <sup>21</sup></p>  <p>10</p> <p>3/8 X 2</p>	<p>12393 <sup>22</sup></p>  <p>10</p> <p>3/8 X 3</p>	<p>12393 <sup>23</sup></p>  <p>10</p> <p>3/8 X 3</p>	<p>12393 <sup>24</sup></p>  <p>10</p> <p>3/8 X 3</p>

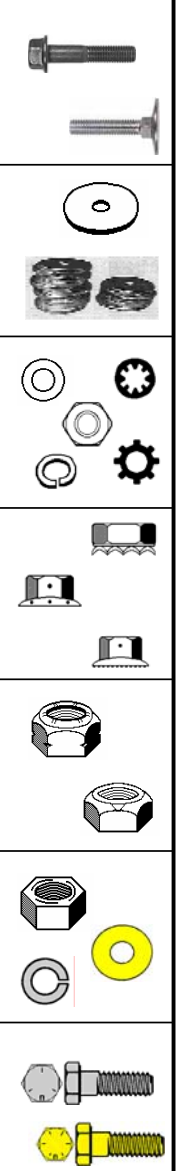































# J&B Fleet - Industrial Supply

22428 Harrisburg-Westville Rd. Alliance, Ohio 44601 Phone: (330) 821-6342 Fax: (330) 821-0411

[www.jbfleet.com](http://www.jbfleet.com)

PART # 2218

## COTTER PINS

 <b>12330</b> <sup>1</sup> 1/16 X 1/2 50	 <b>12332</b> <sup>2</sup> 1/16 X 1 50	 <b>12334</b> <sup>3</sup> 1/16 X 1-1/2 50	 <b>12336</b> <sup>4</sup> 1/16 X 2 25	 <b>12337</b> <sup>5</sup> 3/32 X 1/2 50	 <b>12339</b> <sup>6</sup> 3/32 X 1 50	 <b>12341</b> <sup>7</sup> 3/32 X 1-1/2 50	 <b>12343</b> <sup>8</sup> 3/32 X 2 25
 <b>12347</b> <sup>9</sup> 1/8 X 3/4 50	 <b>12348</b> <sup>10</sup> 1/8 X 1 50	 <b>12349</b> <sup>11</sup> 1/8 X 1-1/4 25	 <b>12350</b> <sup>12</sup> 1/8 X 1-1/2 25	 <b>12352</b> <sup>13</sup> 1/8 X 2 25	 <b>12356</b> <sup>14</sup> 5/32 X 3/4 25	 <b>12357</b> <sup>15</sup> 5/32 X 1 25	 <b>12358</b> <sup>16</sup> 5/32 X 1-1/4 25
 <b>12359</b> <sup>17</sup> 5/32 X 1-1/2 25	 <b>12361</b> <sup>18</sup> 5/32 X 2 25	 <b>12365</b> <sup>19</sup> 3/16 X 3/4 20	 <b>12366</b> <sup>20</sup> 3/16 X 1 20	 <b>12367</b> <sup>21</sup> 3/16 X 1-1/4 20	 <b>12369</b> <sup>22</sup> 3/16 X 1-1/2 10	 <b>12370</b> <sup>23</sup> 3/16 X 2 10	 <b>12374</b> <sup>24</sup> 1/4 X 1 10
 <b>12375</b> <sup>25</sup> 1/4 X 1-1/4 10	 <b>12376</b> <sup>26</sup> 1/4 X 1-1/2 10	 27	 <b>12378</b> <sup>28</sup> 1/4 X 2 10	 29	 <b>12385</b> <sup>30</sup> 5/16 X 1-1/2 5	 31	 <b>12386</b> <sup>32</sup> 5/16 X 2 5





LET US HELP YOU MAKE THE CONNECTION

PART# 3004

# COTTER PINS



J & B FLEET-INDUSTRIAL SUPPLY  
PHONE: 330-821-6342



<b>12330</b>  1/16 X 1/2  25	<b>12332</b>  1/16 X 1  25	<b>12339</b>  3/32 X 1  25	<b>12341</b>  3/32 X 1-1/2  25	<b>12348</b>  1/8 X 1  25	<b>12350</b>  1/8 X 1-1/2  10
<b>12352</b>  1/8 X 2  10	<b>12359</b>  5/32 X 1-1/2  10	<b>12361</b>  5/32 X 2  10	<b>12365</b>  3/16 X 3/4  10	<b>12368</b>  3/16 X 1-1/2  10	<b>12370</b>  3/16 X 2  5



















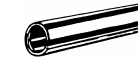







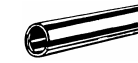
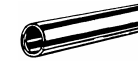

# J&B Fleet - Industrial Supply

22428 Harrisburg-Westville Rd. Alliance, Ohio 44601 Phone: (330) 821-6342 Fax: (330) 821-0411

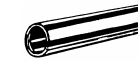
[www.jbfleet.com](http://www.jbfleet.com)

PART #2246

## SPRING PINS

 <b>12400</b> <sup>1</sup> 1/16 X 1/2 25	 <b>12402</b> <sup>2</sup> 1/16 X 3/4 25	 <b>12405</b> <sup>3</sup> 5/64 X 1/2 20	 <b>12407</b> <sup>4</sup> 5/64 X 3/4 20	 <b>12411</b> <sup>5</sup> 3/32 X 3/4 20	 <b>12414</b> <sup>6</sup> 3/32 X 1 20	 <b>12418</b> <sup>7</sup> 1/8 X 3/4 20	 <b>12420</b> <sup>8</sup> 1/8 X 1 20
 <b>12421</b> <sup>9</sup> 1/8 X 1 1/4 15	 <b>12422</b> <sup>10</sup> 1/8 X 1 1/2 15	 <b>12426</b> <sup>11</sup> 5/32 X 1 15	 <b>12428</b> <sup>12</sup> 5/32 X 1-1/2 10	 <b>12432</b> <sup>13</sup> 3/16 X 1 10	 <b>12433</b> <sup>14</sup> 3/16 X 1-1/4 10	 <b>12434</b> <sup>15</sup> 3/16 X 1-1/2 10	 <b>12436</b> <sup>16</sup> 3/16 X 2 5
 <b>12438</b> <sup>17</sup> 7/32 X 1 10	 <b>12440</b> <sup>18</sup> 7/32 X 1-1/2 5	 <b>12442</b> <sup>19</sup> 7/32 X 2 5	 <b>12444</b> <sup>20</sup> 1/4 X 1 10	 <b>12445</b> <sup>21</sup> 1/4 X 1-1/4 10	 <b>12447</b> <sup>22</sup> 1/4 X 1-1/2 5	 <b>12448</b> <sup>23</sup> 1/4 X 2 5	<b>12449</b> <sup>24</sup>
 <b>12466</b> <sup>25</sup> 5/16 X 1 5	 <b>12468</b> <sup>26</sup> 5/16 X 1-1/2 5	 <b>12470</b> <sup>27</sup> 5/16 X 2 5	<b>12471</b> <sup>28</sup>	 <b>12453</b> <sup>29</sup> 3/8 X 1 5	 <b>12455</b> <sup>30</sup> 3/8 X 1-1/2 5	 <b>12457</b> <sup>31</sup> 3/8 X 2 5	<b>12458</b> <sup>32</sup>





# J&B Fleet - Industrial Supply





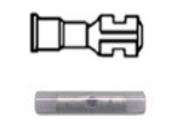

22428 Harrisburg-Westville Rd. Alliance, Ohio 44601 Phone: (330) 821-6342 Fax: (330) 821-0411

[www.jbfleet.com](http://www.jbfleet.com)

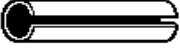
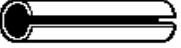
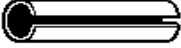
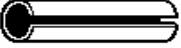
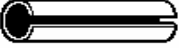
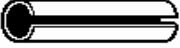
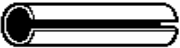
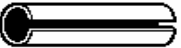
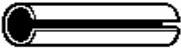
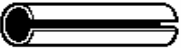
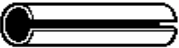
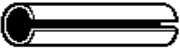
PART # 2016

## ROLL PINS 1/16 – 1/4

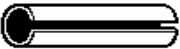
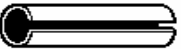
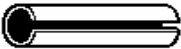
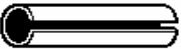
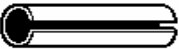
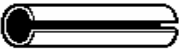

<p><b>12401</b> <sup>1</sup></p>  <p>25 <b>1/16 X 1/4</b></p>	<p><b>12400</b> <sup>2</sup></p>  <p>25 <b>1/16 X 1/2</b></p>	<p><b>12402</b> <sup>3</sup></p>  <p>25 <b>1/16 X 3/4</b></p>	<p><b>12403</b> <sup>4</sup></p>  <p>25 <b>5/64 X 1/4</b></p>	<p><b>12405</b> <sup>5</sup></p>  <p>25 <b>5/64 X 1/2</b></p>	<p><b>12407</b> <sup>6</sup></p>  <p>25 <b>5/64 X 3/4</b></p>
<p><b>12410</b> <sup>7</sup></p>  <p>25 <b>3/32 X 1/2</b></p>	<p><b>12411</b> <sup>8</sup></p>  <p>25 <b>3/32 X 3/4</b></p>	<p><b>12414</b> <sup>9</sup></p>  <p>25 <b>3/32 X 1</b></p>	<p><b>12415</b> <sup>10</sup></p>  <p>25 <b>1/8 X 3/8</b></p>	<p><b>12418</b> <sup>11</sup></p>  <p>25 <b>1/8 X 3/4</b></p>	<p><b>12422</b> <sup>12</sup></p>  <p>20 <b>1/8 X 1-1/2</b></p>
<p><b>12423</b> <sup>13</sup></p>  <p>25 <b>5/32 X 1/2</b></p>	<p><b>12426</b> <sup>14</sup></p>  <p>25 <b>5/32 X 1</b></p>	<p><b>12428</b> <sup>15</sup></p>  <p>20 <b>5/32 X 1-1/2</b></p>	<p><b>12429</b> <sup>16</sup></p>  <p>25 <b>3/16 X 1/2</b></p>	<p><b>12432</b> <sup>17</sup></p>  <p>20 <b>3/16 X 1</b></p>	<p><b>12436</b> <sup>18</sup></p>  <p>15 <b>3/16 X 2</b></p>
<p><b>12437</b> <sup>19</sup></p>  <p>25 <b>7/32 X 3/4</b></p>	<p><b>12440</b> <sup>20</sup></p>  <p>20 <b>7/32 X 1-1/2</b></p>	<p><b>12442</b> <sup>21</sup></p>  <p>15 <b>7/32 X 2</b></p>	<p><b>12444</b> <sup>22</sup></p>  <p>20 <b>1/4 X 1</b></p>	<p><b>12448</b> <sup>23</sup></p>  <p>10 <b>1/4 X 2</b></p>	<p><b>12452</b> <sup>24</sup></p>  <p>5 <b>1/4 X 3</b></p>



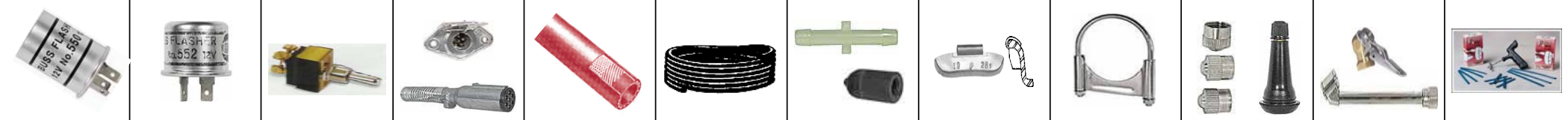











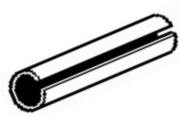



## J&B Fleet - Industrial Supply

www.jbfleet.com

22428 Harrisburg-Westville Rd. Alliance, Ohio 44601 Phone: (330) 821-6342 Fax: (330) 821-0411

PART # 2017

### ROLL PINS 5/16 – 1/2

<p><b>32085</b>      1</p>  <p>15      5/16 X 3/4</p>	<p><b>12466</b>      2</p>  <p>15      5/16 X 1</p>	<p><b>12468</b>      3</p>  <p>10      5/16 X 1-1/2</p>	<p><b>12470</b>      4</p>  <p>10      5/16 X 2</p>
<p><b>12453</b>      5</p>  <p>10      3/8 X 1</p>	<p><b>12455</b>      6</p>  <p>10      3/8 X 1-1/2</p>	<p><b>12457</b>      7</p>  <p>5      3/8 X 2</p>	<p><b>12459</b>      8</p>  <p>5      3/8 X 2-1/2</p>
<p><b>12461</b>      9</p>  <p>10      3/8 X 3</p>	<p><b>25172</b>      14</p>  <p>5      1/2 X 2</p>	<p><b>12481</b>      11</p>  <p>5      7/16 X 1-1/2</p>	<p><b>25171</b>      12</p>  <p>5      1/2 X 1-1/4</p>
<p><b>12482</b>      13</p>  <p>10      1/2 X 1-1/2</p>	<p><b>25173</b>      16</p>  <p>3      1/2 X 4</p>		





















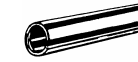







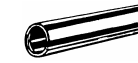
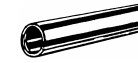

# J&B Fleet - Industrial Supply

22428 Harrisburg-Westville Rd. Alliance, Ohio 44601 Phone: (330) 821-6342 Fax: (330) 821-0411

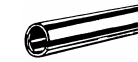
[www.jbfleet.com](http://www.jbfleet.com)

PART #2246

## SPRING PINS

 <b>12400</b> <sup>1</sup> 1/16 X 1/2 25	 <b>12402</b> <sup>2</sup> 1/16 X 3/4 25	 <b>12405</b> <sup>3</sup> 5/64 X 1/2 20	 <b>12407</b> <sup>4</sup> 5/64 X 3/4 20	 <b>12411</b> <sup>5</sup> 3/32 X 3/4 20	 <b>12414</b> <sup>6</sup> 3/32 X 1 20	 <b>12418</b> <sup>7</sup> 1/8 X 3/4 20	 <b>12420</b> <sup>8</sup> 1/8 X 1 20
 <b>12421</b> <sup>9</sup> 1/8 X 1 1/4 15	 <b>12422</b> <sup>10</sup> 1/8 X 1 1/2 15	 <b>12426</b> <sup>11</sup> 5/32 X 1 15	 <b>12428</b> <sup>12</sup> 5/32 X 1-1/2 10	 <b>12432</b> <sup>13</sup> 3/16 X 1 10	 <b>12433</b> <sup>14</sup> 3/16 X 1-1/4 10	 <b>12434</b> <sup>15</sup> 3/16 X 1-1/2 10	 <b>12436</b> <sup>16</sup> 3/16 X 2 5
 <b>12438</b> <sup>17</sup> 7/32 X 1 10	 <b>12440</b> <sup>18</sup> 7/32 X 1-1/2 5	 <b>12442</b> <sup>19</sup> 7/32 X 2 5	 <b>12444</b> <sup>20</sup> 1/4 X 1 10	 <b>12445</b> <sup>21</sup> 1/4 X 1-1/4 10	 <b>12447</b> <sup>22</sup> 1/4 X 1-1/2 5	 <b>12448</b> <sup>23</sup> 1/4 X 2 5	<b>12449</b> <sup>24</sup>
 <b>12466</b> <sup>25</sup> 5/16 X 1 5	 <b>12468</b> <sup>26</sup> 5/16 X 1-1/2 5	 <b>12470</b> <sup>27</sup> 5/16 X 2 5	<b>12471</b> <sup>28</sup>	 <b>12453</b> <sup>29</sup> 3/8 X 1 5	 <b>12455</b> <sup>30</sup> 3/8 X 1-1/2 5	 <b>12457</b> <sup>31</sup> 3/8 X 2 5	<b>12458</b> <sup>32</sup>



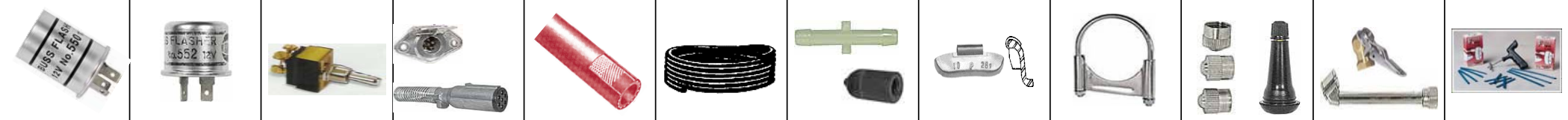



















# J&B Fleet - Industrial Supply

22428 Harrisburg-Westville Rd. Alliance, Ohio 44601 Phone: (330) 821-6342 Fax: (330) 821-0411

[www.jbfleet.com](http://www.jbfleet.com)

PART # 2137

## SPRING PINS

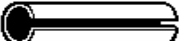
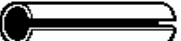
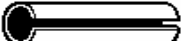
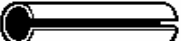
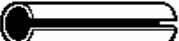
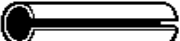
<p><b>12400</b> <sup>1</sup></p>  <p>1/16 X 1/2</p> <p>20</p>	<p><b>12402</b> <sup>2</sup></p>  <p>1/16 X 3/4</p> <p>20</p>	<p><b>12405</b> <sup>3</sup></p>  <p>5/64 X 1/2</p> <p>20</p>	<p><b>12407</b> <sup>4</sup></p>  <p>5/64 X 3/4</p> <p>20</p>	<p><b>12411</b> <sup>5</sup></p>  <p>3/32 X 3/4</p> <p>20</p>	<p><b>12452</b> <sup>6</sup></p>  <p>1/4 X 3</p> <p>5</p>
<p><b>12414</b> <sup>7</sup></p>  <p>3/32 X 1</p> <p>20</p>	<p><b>12418</b> <sup>8</sup></p>  <p>1/8 X 3/4</p> <p>20</p>	<p><b>12420</b> <sup>9</sup></p>  <p>1/8 X 1</p> <p>20</p>	<p><b>12422</b> <sup>10</sup></p>  <p>1/8 X 1-1/2</p> <p>20</p>	<p><b>12426</b> <sup>11</sup></p>  <p>5/32 X 1</p> <p>20</p>	<p><b>12457</b> <sup>12</sup></p>  <p>3/8 X 2</p> <p>5</p>
<p><b>12428</b> <sup>13</sup></p>  <p>5/32 X 1-1/2</p> <p>20</p>	<p><b>12432</b> <sup>14</sup></p>  <p>3/16 X 1</p> <p>10</p>	<p><b>12436</b> <sup>15</sup></p>  <p>3/16 X 2</p> <p>10</p>	<p><b>12440</b> <sup>16</sup></p>  <p>7/32 X 1</p> <p>10</p>	<p><b>12442</b> <sup>17</sup></p>  <p>7/32 X 2</p> <p>10</p>	<p><b>12461</b> <sup>18</sup></p>  <p>3/8 X 3</p> <p>5</p>
<p><b>12444</b> <sup>19</sup></p>  <p>1/4 X 1</p> <p>10</p>	<p><b>12448</b> <sup>20</sup></p>  <p>1/4 X 2</p> <p>10</p>	<p><b>12466</b> <sup>21</sup></p>  <p>5/16 X 1</p> <p>10</p>	<p><b>12470</b> <sup>22</sup></p>  <p>5/16 X 2</p> <p>5</p>	<p><b>12453</b> <sup>23</sup></p>  <p>3/8 X 1</p> <p>5</p>	<p><b>12483</b> <sup>24</sup></p>  <p>1/2 X 3</p> <p>5</p>



LET US HELP YOU MAKE THE CONNECTION

Part # 3005

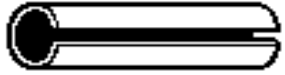

# ROLL PINS



J & B FLEET-INDUSTRIAL SUPPLY  
PHONE: 330-821-6342

<b>12402</b>  1/16 x 3/4  10	<b>12414</b>  3/32 x 1  10	<b>12420</b>  1/8 x 1  10	<b>12422</b>  1/8 x 1-1/2  10	<b>12426</b>  5/32 x 1  10	<b>12428</b>  5/32 x 1-1/2  10
<b>12432</b>  3/16 x 1  10	<b>12436</b>  3/16 x 2  10	<b>12440</b>  7/32 x 1  10	<b>12442</b>  7/32 x 2  10	<b>12444</b>  1/4 x 1  10	<b>12448</b>  1/4 x 2  10





















## J&B Fleet - Industrial Supply

www.jbfleet.com

22428 Harrisburg-Westville Rd. Alliance, Ohio 44601 Phone: (330) 821-6342 Fax: (330) 821-0411

PART # 2089

### HAIRPINS

<p>50</p> <p><b>13264</b></p>  <p><b>1/32 X 5/8</b></p>	<p>10</p> <p><b>13276</b></p>  <p><b>7/64 X 1-5/8</b></p>	<p>10</p> <p><b>13256</b></p>  <p><b>9/64 X 2-1/2</b></p>	<p>3</p>  <p><b>41055</b></p> <p>PIN DIA 1/4</p> <p><b>EFFECTIVE LENGTH 1-3/8</b></p>
<p>50</p> <p><b>13266</b></p>  <p><b>3/64 X 1"</b></p>	<p>10</p> <p><b>13254</b></p>  <p><b>7/64 X 2-5/16</b></p>	<p>10</p> <p><b>13280</b></p>  <p><b>9/64 X 2-7/8</b></p>	<p>3</p>  <p><b>41056</b></p> <p>PIN DIA 5/16</p> <p><b>EFFECTIVE LENGTH 2-1/4</b></p>
<p>25</p> <p><b>13268</b></p>  <p><b>1/16 X 1-9/16</b></p>	<p>10</p> <p><b>13278</b></p>  <p><b>1/8 X 1-1/4</b></p>	<p>5</p> <p><b>13282</b></p>  <p><b>5/32 X 2-15/16</b></p>	
<p>25</p> <p><b>13270</b></p>  <p><b>5/64 X 1-9/16</b></p>	<p>10</p> <p><b>13262</b></p>  <p><b>9/64 X 1-15/16</b></p>	<p>3</p> <p><b>13260</b></p>  <p><b>3/16 X 3-3/4</b></p>	
<p>25</p> <p><b>13272</b></p>  <p><b>5/64 X 1-7/8</b></p>			
<p>25</p> <p><b>13274</b></p>  <p><b>3/32 X 1-9/16</b></p>			





LET US HELP YOU MAKE THE CONNECTION

PART # 3008

# HAIRPINS



J & B FLEET-INDUSTRIAL SUPPLY  
PHONE: 330-821-6342



13270	13274	13254	13256	13282	13260
5/64 x 1-9/16	3/32 x 1-9/16	7/64 x 2-5/16	9/64 x 2-1/2	5/32 x 2-15/16	3/16 x 3-3/4
25	25	10	10	10	5















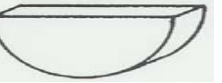
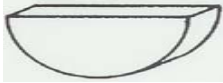
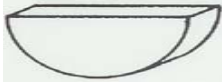
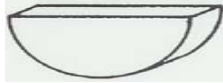
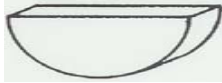
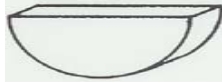

# J&B Fleet - Industrial Supply

www.jbfleet.com

22428 Harrisburg-Westville Rd. Alliance, Ohio 44601 Phone: (330) 821-6342 Fax: (330) 821-0411

PART # 2032

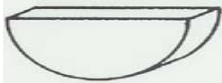
## WOODRUFF KEYS

<p>12586 <sup>1</sup></p>  <p>15 <b>3/32 X 1/2</b></p>	<p>12587 <sup>2</sup></p>  <p>15 <b>3/32 X 5/8</b></p>	<p>12588 <sup>3</sup></p>  <p>15 <b>1/8 X 1/2</b></p>	<p>12589 <sup>4</sup></p>  <p>15 <b>1/8 X 5/8</b></p>	<p>12590 <sup>5</sup></p>  <p>10 <b>5/32 X 5/8</b></p>	<p>12591 <sup>6</sup></p>  <p>10 <b>5/32 X 3/4</b></p>
<p>12592 <sup>7</sup></p>  <p>10 <b>5/32 X 7/8</b></p>	<p>12593 <sup>8</sup></p>  <p>10 <b>3/16 X 3/4</b></p>	<p>12594 <sup>9</sup></p>  <p>10 <b>3/16 X 7/8</b></p>	<p>12595 <sup>10</sup></p>  <p>10 <b>3/16 X 1</b></p>	<p>12596 <sup>11</sup></p>  <p>5 <b>1/4 X 3/4</b></p>	<p>12597 <sup>12</sup></p>  <p>5 <b>1/4 X 7/8</b></p>
<p>12598 <sup>13</sup></p>  <p>5 <b>1/4 X 1</b></p>	<p>12599 <sup>14</sup></p>  <p>5 <b>1/4 X 1-1/8</b></p>	<p>12600 <sup>15</sup></p>  <p>5 <b>1/4 X 1-1/4</b></p>	<p>12601 <sup>16</sup></p>  <p>5 <b>5/16 X 1</b></p>	<p>12602 <sup>17</sup></p>  <p>5 <b>5/16 X 1-1/8</b></p>	<p>12603 <sup>18</sup></p>  <p>5 <b>5/16 X 1-1/4</b></p>
<p>12604 <sup>19</sup></p>  <p>3 <b>3/8 X 1</b></p>	<p>12605 <sup>20</sup></p>  <p>3 <b>3/8 X 1-1/4</b></p>	<p>21</p>	<p>22</p>	<p>23</p>	<p>24</p>



LET US HELP YOU MAKE THE CONNECTION

PART # 3007

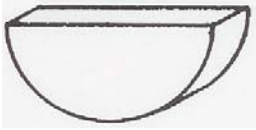

# WOODRUFF KEYS



J & B FLEET-INDUSTRIAL SUPPLY  
PHONE: 330-821-6342

<b>12586</b> 3/32 x 1/2 5	<b>12587</b> 3/32 x 5/8 5	<b>12588</b> 1/8 x 1/2 5	<b>12589</b> 1/8 x 5/8 5	<b>12590</b> 5/32 x 5/8 5	<b>12591</b> 5/32 x 3/4 5
<b>12593</b> 3/16 x 3/4 5	<b>12594</b> 3/16 x 7/8 5	<b>12595</b> 3/16 x 1 5	<b>12596</b> 1/4 x 3/4 3	<b>12597</b> 1/4 x 7/8 3	<b>12598</b> 1/4 x 1 3
<b>12600</b> 1/4 x 1-1/4 3	<b>12601</b> 5/16 x 1 2	<b>12602</b> 5/16 x 1-1/8 2	<b>12603</b> 5/16 x 1-1/4 2	<b>12604</b> 3/8 x 1 2	<b>12605</b> 3/8 x 1-1/4 2



# J&B Fleet - Industrial Supply

www.jbfleet.com

22428 Harrisburg-Westville Rd. Alliance, Ohio 44601 Phone: (330) 821-6342 Fax: (330) 821-0411

PART # 2238

## SNAP & LYNCH PINS

<p><b>41055</b> 1</p> <p>5 PIN DIA. 1/4 EFFECTIVE LENGTH 1-3/8</p>	<p><b>41057</b> 2</p> <p>5 PIN DIA. 3/16 EFFECTIVE LENGTH 1</p>	<p><b>41066</b> 3</p> <p>5 PIN DIA. 5/16 EFFECTIVE LENGTH 1-1/4</p>
<p><b>41054</b> 4</p> <p>5 PIN DIA. 1/4 EFFECTIVE LENGTH 2-1/4</p>	<p><b>41062</b> 5</p> <p>5 PIN DIA. 3/16 EFFECTIVE LENGTH 1-1/4</p>	<p><b>41064</b> 6</p> <p>5 PIN DIA. 5/16 EFFECTIVE LENGTH 1-3/8</p>
<p><b>41056</b> 7</p> <p>5 PIN DIA. 5/16 EFFECTIVE LENGTH 2-1/4</p>	<p><b>41063</b> 8</p> <p>5 PIN DIA. 1/4 EFFECTIVE LENGTH 1-1/4</p>	<p><b>41060</b> 9</p> <p>5 PIN DIA. 7/16 EFFECTIVE LENGTH 1-5/8</p>
<p><b>41061</b> 10</p> <p>5 PIN DIA. 3/8 EFFECTIVE LENGTH 2-1/4</p>	<p><b>41059</b> 11</p> <p>5 PIN DIA. 1/4 EFFECTIVE LENGTH 1-5/16</p>	<p><b>41065</b> 12</p> <p>5 PIN DIA. 7/16 EFFECTIVE LENGTH 1-3/4</p>

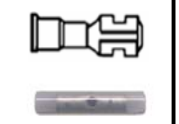

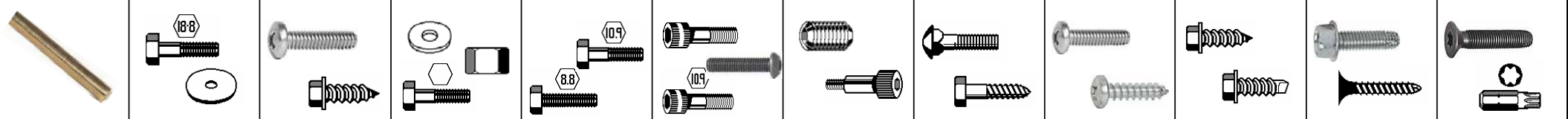







# J&B Fleet - Industrial Supply

22428 Harrisburg-Westville Rd. Alliance, Ohio 44601 Phone: (330) 821-6342 Fax: (330) 821-0411

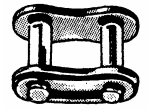
[www.jbfleet.com](http://www.jbfleet.com)

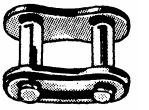
PART # 2225

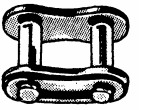
## CHAIN LINKS

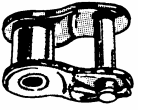
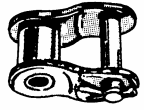
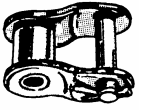
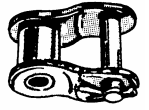
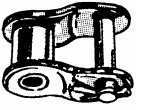
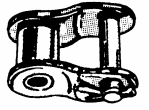
<p>13478 <sup>1</sup></p>  <p><b>#35</b> CONNECTING LINKS</p> <p>4</p>	<p>13480 <sup>2</sup></p>  <p><b>#40</b> CONNECTING LINKS</p> <p>4</p>	<p>13479 <sup>3</sup></p>  <p><b>#41</b> CONNECTING LINKS</p> <p>4</p>	<p>13481 <sup>4</sup></p>  <p><b>#50</b> CONNECTING LINKS</p> <p>4</p>	<p>13482 <sup>5</sup></p>  <p><b>#60</b> CONNECTING LINKS</p> <p>3</p>	<p>13491 <sup>6</sup></p>  <p><b>#80</b> CONNECTING LINKS</p> <p>2</p>
<p><sup>7</sup></p>	<p><sup>8</sup></p>	<p><sup>9</sup></p>	<p><sup>10</sup></p>	<p><sup>11</sup></p>	<p><sup>12</sup></p>
<p>13486 <sup>13</sup></p>  <p><b>#35</b> OFFSET LINKS</p> <p>4</p>	<p>13483 <sup>14</sup></p>  <p><b>#40</b> OFFSET LINKS</p> <p>4</p>	<p>13487 <sup>15</sup></p>  <p><b>#41</b> OFFSET LINKS</p> <p>4</p>	<p>13484 <sup>16</sup></p>  <p><b>#50</b> OFFSET LINKS</p> <p>4</p>	<p>13485 <sup>17</sup></p>  <p><b>#60</b> OFFSET LINKS</p> <p>3</p>	<p>13492 <sup>18</sup></p>  <p><b>#80</b> OFFSET LINKS</p> <p>2</p>
<p><sup>19</sup></p>	<p><sup>20</sup></p>	<p><sup>21</sup></p>	<p><sup>22</sup></p>	<p><sup>23</sup></p>	<p><sup>24</sup></p>

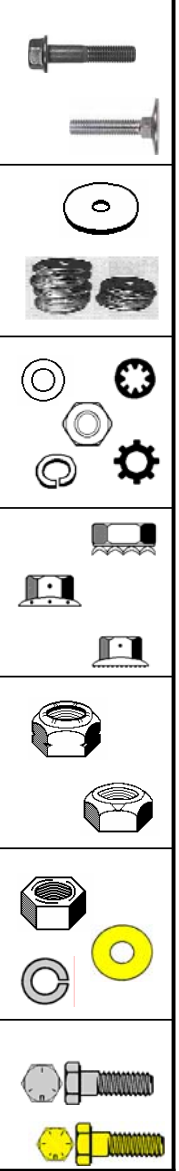

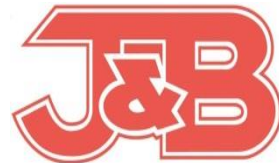











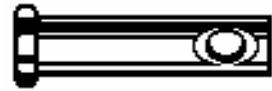
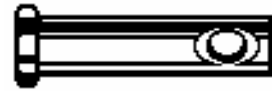



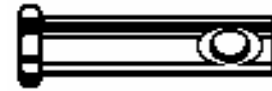







# J&B Fleet - Industrial Supply

22428 Harrisburg-Westville Rd. Alliance, Ohio 44601 Phone: (330) 821-6342 Fax: (330) 821-0411

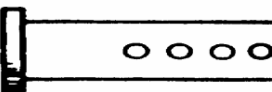
[www.jbfleet.com](http://www.jbfleet.com)

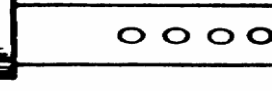
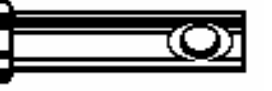
PART # 2198

## CLEVIS PINS (zinc plated)

 <b>37480</b> <sup>1</sup> 5 <b>3/16 X 1/2</b>	 <b>37481</b> <sup>2</sup> 5 <b>3/16 X 3/4</b>	 <b>37482</b> <sup>3</sup> 5 <b>3/16 X 1</b>	 <b>37483</b> <sup>4</sup> 5 <b>3/16 X 1-1/2</b>	 <b>37486</b> <sup>5</sup> 5 <b>1/4 X 3/4</b>	 <b>37499</b> <sup>6</sup> 2 <b>1/2 X 3</b>
 <b>37500</b> <sup>7</sup> 5 <b>1/4 X 1</b>	 <b>37501</b> <sup>8</sup> 5 <b>1/4 X 1-1/4</b>	 <b>37502</b> <sup>9</sup> 5 <b>1/4 X 1-1/2</b>	 <b>13185</b> <sup>10</sup> 5 <b>1/4 X 2</b>	 <b>37506</b> <sup>11</sup> 5 <b>5/16 X 1</b>	 <b>37498</b> <sup>12</sup> 2 <b>1/2 X 2-1/2</b>
 <b>37507</b> <sup>13</sup> 5 <b>5/16 X 1-1/4</b>	 <b>37508</b> <sup>14</sup> 5 <b>5/16 X 1-1/2</b>	 <b>13186</b> <sup>15</sup> 5 <b>5/16 X 2</b>	 <b>37512</b> <sup>16</sup> 5 <b>3/8 X 1</b>	 <b>37513</b> <sup>17</sup> 5 <b>3/8 X 1-1/4</b>	 <b>13189</b> <sup>18</sup> 2 <b>1/2 X 2</b>
 <b>37514</b> <sup>19</sup> 5 <b>3/8 X 1-1/2</b>	 <b>13187</b> <sup>20</sup> 5 <b>3/8 x 2</b>	 <b>37490</b> <sup>21</sup> 2 <b>7/16 x 1-1/4</b>	 <b>37524</b> <sup>22</sup> 2 <b>7/16 x 1-1/2</b>	 <b>13188</b> <sup>23</sup> 2 <b>7/16 x 2</b>	 <b>40505</b> <sup>24</sup> 2 <b>1/2 X 1-1/2</b>





















## J&B Fleet - Industrial Supply

www.jbfleet.com

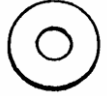
22428 Harrisburg-Westville Rd. Alliance, Ohio 44601 Phone: (330) 821-6342 Fax: (330) 821-0411

PART # 2061

# ALUMINUM BLIND RIVETS

<p><b>39012</b></p>  <p><b>1/8 BACK-UP WASHER</b></p> <p>50</p>	<p><b>13323</b></p>  <p><b>DOME HEAD 1/8 DIAMETER</b></p> <p><b>GRIP .313 - .375</b></p> <p>50</p>	<p><b>13332</b></p>  <p><b>DOME HEAD 3/16 DIAMETER</b></p> <p><b>GRIP .251 - .375</b></p> <p>50</p>	<p><b>13337</b></p>  <p><b>LARGE FLANGE</b></p> <p><b>DOME HEAD 3/16 DIAMETER</b></p> <p><b>GRIP .251 - .375</b></p> <p>25</p>
<p><b>13319</b></p>  <p><b>DOME HEAD 1/8 DIAMETER</b></p> <p><b>GRIP .065 - .125</b></p> <p>50</p>	<p><b>12260</b></p>  <p><b>DOME HEAD 1/8 DIAMETER</b></p> <p><b>GRIP .375 - .500</b></p> <p>50</p>	<p><b>13334</b></p>  <p><b>DOME HEAD 3/16 DIAMETER</b></p> <p><b>GRIP .376 - .500</b></p> <p>50</p>	<p><b>13338</b></p>  <p><b>LARGE FLANGE</b></p> <p><b>DOME HEAD 3/16 DIAMETER</b></p> <p><b>GRIP .375 - .500</b></p> <p>25</p>
<p><b>13322</b></p>  <p><b>DOME HEAD 1/8 DIAMETER</b></p> <p><b>GRIP .188 - .250</b></p> <p>50</p>	<p><b>39013</b></p>  <p><b>3/16 BACK-UP WASHER</b></p> <p>50</p>	<p><b>32116</b></p>  <p><b>DOME HEAD 3/16 DIAMETER</b></p> <p><b>GRIP .625 - .750</b></p> <p>50</p>	<p><b>13338</b></p>  <p><b>LARGE FLANGE</b></p> <p><b>DOME HEAD 3/16 DIAMETER</b></p> <p><b>GRIP .375 - .500</b></p> <p>25</p>
<p><b>32091</b></p>  <p><b>DOME HEAD 1/8 DIAMETER</b></p> <p><b>GRIP .250 - .313</b></p> <p>50</p>	<p><b>13330</b></p>  <p><b>DOME HEAD 3/16 DIAMETER</b></p> <p><b>GRIP .126 - .250</b></p> <p>50</p>	<p><b>13330</b></p>  <p><b>DOME HEAD 3/16 DIAMETER</b></p> <p><b>GRIP .126 - .250</b></p> <p>50</p>	<p><b>13338</b></p>  <p><b>LARGE FLANGE</b></p> <p><b>DOME HEAD 3/16 DIAMETER</b></p> <p><b>GRIP .375 - .500</b></p> <p>25</p>



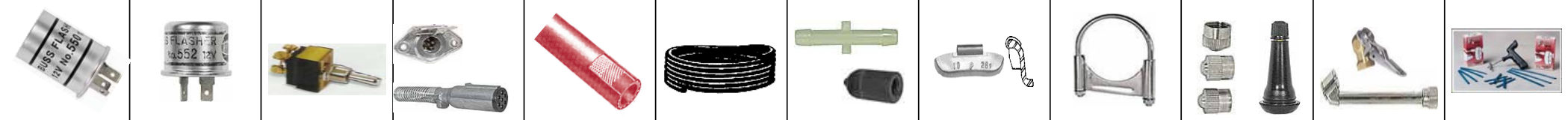











## J&B Fleet - Industrial Supply

www.jbfleet.com

22428 Harrisburg-Westville Rd. Alliance, Ohio 44601 Phone: (330) 821-6342 Fax: (330) 821-0411

PART # 2062

# STEEL BLIND RIVETS

 <p><b>13317</b> 1</p> <p>DOME HEAD 1/8 DIAMETER GRIP .065 - .125</p> <p>50</p>	 <p><b>13320</b> 2</p> <p>DOME HEAD 1/8 DIAMETER GRIP .188 - .250</p> <p>50</p>	 <p><b>12262</b> 3</p> <p>DOME HEAD 1/8 DIAMETER GRIP .313 - .375</p> <p>50</p>
 <p><b>12263</b> 4</p> <p>DOME HEAD 1/8 DIAMETER GRIP .375 - .500</p> <p>50</p>		 <p><b>39010</b> 6</p> <p>1/8 BACK-UP WASHER</p> <p>50</p>
 <p><b>32092</b> 7</p> <p>DOME HEAD 3/16 DIAMETER GRIP .188 - .150</p> <p>50</p>	 <p><b>32093</b> 8</p> <p>DOME HEAD 3/16 DIAMETER GRIP .250 - .375</p> <p>50</p>	 <p><b>32094</b> 9</p> <p>DOME HEAD 3/16 DIAMETER GRIP .375 - .500</p> <p>50</p>
 <p><b>12269</b> 10</p> <p>LARGE FLANGE DOME HEAD 3/16 DIAMETER GRIP .375 - .500</p> <p>25</p>		 <p><b>39011</b> 12</p> <p>3/16 BACK-UP WASHER</p> <p>50</p>







































# J&B Fleet - Industrial Supply

www.jbfleet.com

22428 Harrisburg-Westville Rd. Alliance, Ohio 44601 Phone: (330) 821-6342 Fax: (330) 821-0411

PART # 2076

## O-RINGS # 1

<p><b>12606</b> <sup>1</sup></p>  <p><b>006</b></p> <p>1/8 ID X 1/4 OD 15 1/16 THICK</p>	<p><b>12607</b> <sup>2</sup></p>  <p><b>007</b></p> <p>5/32 ID X 9/32 OD 15 1/16 THICK</p>	<p><b>12608</b> <sup>3</sup></p>  <p><b>008</b></p> <p>3/16 ID X 5/16 OD 15 1/16 THICK</p>	<p><b>12609</b> <sup>4</sup></p>  <p><b>009</b></p> <p>7/32 ID X 11/32 OD 15 1/16 THICK</p>	<p><b>12610</b> <sup>5</sup></p>  <p><b>010</b></p> <p>1/4 ID X 3/8 OD 15 1/16 THICK</p>	<p><b>12611</b> <sup>6</sup></p>  <p><b>011</b></p> <p>5/16 ID X 7/16 OD 15 1/16 THICK</p>	<p><b>12612</b> <sup>7</sup></p>  <p><b>012</b></p> <p>3/8 ID X 1/2 OD 15 1/16 THICK</p>	<p><b>39900</b> <sup>8</sup></p>  <p><b>013</b></p> <p>7/16 ID X 9/16 OD 10 1/16 THICK</p>
<p><b>39901</b> <sup>9</sup></p>  <p><b>014</b></p> <p>1/2 ID X 5/8 OD 10 1/16 THICK</p>	<p><b>39902</b> <sup>10</sup></p>  <p><b>015</b></p> <p>9/16 ID X 11/16 OD 10 1/16 THICK</p>	<p><b>39903</b> <sup>11</sup></p>  <p><b>016</b></p> <p>5/8 ID X 3/4 OD 10 1/16 THICK</p>	<p><b>39904</b> <sup>12</sup></p>  <p><b>017</b></p> <p>11/16 ID X 13/16 OD 10 1/16 THICK</p>	<p><b>39905</b> <sup>13</sup></p>  <p><b>018</b></p> <p>3/4 ID X 7/8 OD 10 1/16 THICK</p>	<p><b>39906</b> <sup>14</sup></p>  <p><b>019</b></p> <p>13/16 ID X 15/16 OD 10 1/16 THICK</p>	<p><b>39907</b> <sup>15</sup></p>  <p><b>020</b></p> <p>7/8 ID X 1 OD 10 1/16 THICK</p>	<p><b>39908</b> <sup>16</sup></p>  <p><b>021</b></p> <p>15/16 ID X 1-1/16 OD 10 1/16 THICK</p>
<p><b>39909</b> <sup>17</sup></p>  <p><b>022</b></p> <p>1 ID X 1-1/8 OD 5 1/16 THICK</p>	<p><b>39910</b> <sup>18</sup></p>  <p><b>024</b></p> <p>1-1/8 ID X 1-1/4 OD 5 1/16 THICK</p>	<p><b>39911</b> <sup>19</sup></p>  <p><b>026</b></p> <p>1-1/4 ID X 1-3/8 OD 5 1/16 THICK</p>	<p><b>39912</b> <sup>20</sup></p>  <p><b>028</b></p> <p>1-3/8 ID X 1-1/2 OD 5 1/16 THICK</p>	<p><b>39913</b> <sup>21</sup></p>  <p><b>029</b></p> <p>1-1/2 ID X 1-5/8 OD 5 1/16 THICK</p>	<p><b>39914</b> <sup>22</sup></p>  <p><b>030</b></p> <p>1-5/8 ID X 1-3/4 OD 3 1/16 THICK</p>	<p><b>39915</b> <sup>23</sup></p>  <p><b>031</b></p> <p>1-3/4 ID X 1-7/8 OD 3 1/16 THICK</p>	<p><b>39916</b> <sup>24</sup></p>  <p><b>032</b></p> <p>1-7/8 ID X 2 OD 3 1/16 THICK</p>
<p><b>12613</b> <sup>25</sup></p>  <p><b>110</b></p> <p>3/8 ID X 9/16 OD 15 3/32 THICK</p>	<p><b>12614</b> <sup>26</sup></p>  <p><b>111</b></p> <p>7/16 ID X 5/8 OD 15 3/32 THICK</p>	<p><b>12615</b> <sup>27</sup></p>  <p><b>112</b></p> <p>1/2 ID X 11/16 OD 15 3/32 THICK</p>	<p><b>12616</b> <sup>28</sup></p>  <p><b>113</b></p> <p>9/16 ID X 3/4 OD 5 3/32 THICK</p>	<p><b>12617</b> <sup>29</sup></p>  <p><b>114</b></p> <p>5/8 ID X 13/16 OD 5 3/32 THICK</p>	<p><b>12618</b> <sup>30</sup></p>  <p><b>115</b></p> <p>11/16 ID X 7/8 OD 5 3/32 THICK</p>	<p><b>12619</b> <sup>31</sup></p>  <p><b>116</b></p> <p>3/4 ID X 15/16 OD 5 3/32 THICK</p>	<p><b>39940</b> <sup>32</sup></p>  <p><b>117</b></p> <p>13/16 ID X 1 OD 5 3/32 THICK</p>



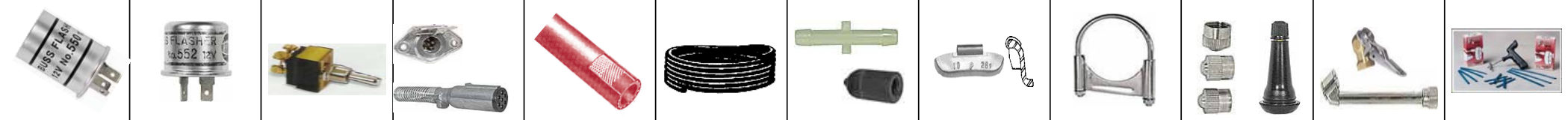

































## J&B Fleet - Industrial Supply

www.jbfleet.com

22428 Harrisburg-Westville Rd. Alliance, Ohio 44601 Phone: (330) 821-6342 Fax: (330) 821-0411

PART # 2077

### O-RINGS #2

 <b>39941</b> <sup>1</sup> 118 7/8 ID X 1-1/16OD 10 3/32 THICK	 <b>39942</b> <sup>2</sup> 119 15/16 ID X 1-1/8OD 10 3/32 THICK	 <b>39943</b> <sup>3</sup> 120 1 ID X 1-3/16 OD 10 3/32 THICK	 <b>39944</b> <sup>4</sup> 121 1-1/16ID X 1-1/4OD 10 3/32 THICK	 <b>39945</b> <sup>5</sup> 122 1-1/8ID X 1-5/16OD 10 3/32 THICK	 <b>39946</b> <sup>6</sup> 123 1-3/16ID X 1-3/8O 10 3/32 THICK	 <b>39947</b> <sup>7</sup> 124 1-1/4ID X 1-7/16OD 10 3/32 THICK	 <b>39948</b> <sup>8</sup> 126 1-3/8ID X 1-9/16OD 5 3/32 THICK
 <b>39949</b> <sup>9</sup> 128 1-1/2ID X 1-11/16O 5 3/32 THICK	 <b>39950</b> <sup>10</sup> 130 1-5/8ID X 1-13/16O 5 3/32 THICK	 <b>39951</b> <sup>11</sup> 132 1-3/4ID X 1-15/16O 3 3/32 THICK	 <b>39952</b> <sup>12</sup> 134 1-7/8ID X 2-1/16O 3 3/32 THICK	 <b>39953</b> <sup>13</sup> 146 2ID X 2-3/16OD 3 3/32 THICK	 <b>39986</b> <sup>14</sup> 209 11/16 ID X 15/16O 10 1/8 THICK	 <b>12620</b> <sup>15</sup> 210 3/4 ID X 1 OD 10 1/8 THICK	 <b>12621</b> <sup>16</sup> 211 13/16ID X 1-1/16OD 10 1/8 THICK
 <b>12622</b> <sup>17</sup> 212 7/8 ID X 1-1/8OD 5 1/8 THICK	 <b>12623</b> <sup>18</sup> 213 15/16 ID X 1-3/16O 5 1/8 THICK	 <b>12624</b> <sup>19</sup> 214 1 ID X 1-1/4 OD 5 1/8 THICK	 <b>12625</b> <sup>20</sup> 215 1-1/16ID X 1-5/16O 5 1/8 THICK	 <b>12626</b> <sup>21</sup> 216 1-1/8ID X 1-3/8O 5 1/8 THICK	 <b>12627</b> <sup>22</sup> 217 1-3/16ID X 1-7/16O 5 1/8 THICK	 <b>12628</b> <sup>23</sup> 218 1-1/4ID X 1-1/2OD 5 1/8 THICK	 <b>12629</b> <sup>24</sup> 219 1-5/16ID X 1-9/16O 5 1/8 THICK
 <b>12630</b> <sup>25</sup> 220 1-3/8ID X 1-5/8OD 5 1/8 THICK	 <b>12631</b> <sup>26</sup> 221 1-7/16ID X 1-11/16O 5 1/8 THICK	 <b>12632</b> <sup>27</sup> 222 1-1/2ID X 1-3/4OD 5 1/8 THICK	 <b>39980</b> <sup>28</sup> 223 1-5/8ID X 1-7/8OD 5 1/8 THICK	 <b>39981</b> <sup>29</sup> 224 1-3/4 ID X 2 OD 5 1/8 THICK	 <b>39982</b> <sup>30</sup> 225 1-7/8ID X 2-1/8OD 3 1/8 THICK	 <b>39983</b> <sup>31</sup> 226 2 ID X 2-1/4 OD 3 1/8 THICK	 <b>39984</b> <sup>32</sup> 227 2-1/8ID X 2-3/8OD 3 1/8 THICK



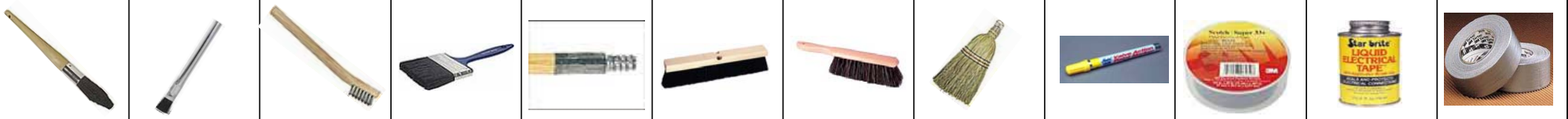















# J&B Fleet - Industrial Supply

22428 Harrisburg-Westville Rd. Alliance, Ohio 44601 Phone: (330) 821-6342 Fax: (330) 821-0411

[www.jbfleet.com](http://www.jbfleet.com)

PART # 2078

## O-RINGS # 3

 <b>39985</b> 1 228 2-1/4 ID X 2-1/2 OD 1/8 THICK 3	 <b>12633</b> 2 325 1-1/2 ID X 1-7/8 OD 3/16 THICK 5	 <b>12634</b> 3 326 1-5/8 ID X 2 OD 3/16 THICK 5	 <b>12635</b> 4 327 1-3/4 ID X 2-1/8 OD 3/16 THICK 5
 <b>13448</b> 5 328 1-7/8 ID X 2-1/4 OD 3/16 THICK 5	 <b>13449</b> 6 329 2 ID X 2-3/8 OD 3/16 THICK 5	 <b>13450</b> 7 330 2-1/8 ID X 2-1/2 OD 3/16 THICK 5	 <b>13451</b> 8 331 2-1/4 ID X 2-5/8 OD 3/16 THICK 5
 <b>13452</b> 9 332 2-3/8 ID X 2-3/4 OD 3/16 THICK 3	 <b>13453</b> 10 333 2-1/2 ID X 2-7/8 OD 3/16 THICK 3	 <b>13454</b> 11 334 2-5/8 ID X 3 OD 3/16 THICK 3	 <b>13455</b> 12 335 2-3/4 ID X 3-1/8 OD 3/16 THICK 3
 <b>13456</b> 13 336 2-7/8 ID X 3-1/4 OD 3/16 THICK 3	 <b>13457</b> 14 337 3 ID X 3-3/8 OD 3/16 THICK 3	15	16





# J&B Fleet - Industrial Supply

































22428 Harrisburg-Westville Rd. Alliance, Ohio 44601 Phone: (330) 821-6342 Fax: (330) 821-0411

[www.jbfleet.com](http://www.jbfleet.com)

PART # 2030

## O-RINGS #4

pictures not actual size

<p><b>12606</b> <sup>1</sup></p>  <p><b>006</b></p> <p>1/8 ID X 1/4 OD 15 1/16 THICK</p>	<p><b>12607</b> <sup>2</sup></p>  <p><b>007</b></p> <p>5/32 ID X 9/32 OD 15 1/16 THICK</p>	<p><b>12608</b> <sup>3</sup></p>  <p><b>008</b></p> <p>3/16 ID X 5/16 OD 15 1/16 THICK</p>	<p><b>12609</b> <sup>4</sup></p>  <p><b>009</b></p> <p>7/32 ID X 11/32 OD 15 1/16 THICK</p>	<p><b>12610</b> <sup>5</sup></p>  <p><b>010</b></p> <p>1/4 ID X 3/8 OD 15 1/16 THICK</p>	<p><b>12611</b> <sup>6</sup></p>  <p><b>011</b></p> <p>5/16 ID X 7/16 OD 15 1/16 THICK</p>	<p><b>12612</b> <sup>7</sup></p>  <p><b>012</b></p> <p>3/8 ID X 1/2 OD 15 1/16 THICK</p>	<p><b>39900</b> <sup>8</sup></p>  <p><b>013</b></p> <p>7/16 ID X 9/16 OD 15 1/16 THICK</p>
<p><b>39901</b> <sup>9</sup></p>  <p><b>014</b></p> <p>1/2 ID X 5/8 OD 10 1/16 THICK</p>	<p><b>39902</b> <sup>10</sup></p>  <p><b>015</b></p> <p>9/16 ID X 11/16 OD 10 1/16 THICK</p>	<p><b>12613</b> <sup>11</sup></p>  <p><b>110</b></p> <p>3/8 ID X 9/16 OD 10 3/32 THICK</p>	<p><b>12614</b> <sup>12</sup></p>  <p><b>111</b></p> <p>7/16 ID X 5/8 OD 10 3/32 THICK</p>	<p><b>12615</b> <sup>13</sup></p>  <p><b>112</b></p> <p>1/2 ID X 11/16 OD 10 3/32 THICK</p>	<p><b>12616</b> <sup>14</sup></p>  <p><b>113</b></p> <p>9/16 ID X 3/4 OD 10 3/32 THICK</p>	<p><b>12617</b> <sup>15</sup></p>  <p><b>114</b></p> <p>5/8 ID X 13/16 OD 10 3/32 THICK</p>	<p><b>39940</b> <sup>16</sup></p>  <p><b>115</b></p> <p>11/16 ID X 7/8 OD 5 3/32 THICK</p>
<p><b>12618</b> <sup>17</sup></p>  <p><b>115</b></p> <p>11/16 ID X 7/8 OD 5 3/32 THICK</p>	<p><b>12619</b> <sup>18</sup></p>  <p><b>116</b></p> <p>3/4 ID X 15/16 OD 5 3/32 THICK</p>	<p><b>39941</b> <sup>19</sup></p>  <p><b>117</b></p> <p>13/16 ID X 1 OD 5 3/32 THICK</p>	<p><b>39942</b> <sup>20</sup></p>  <p><b>118</b></p> <p>7/8 ID X 1-1/16 OD 5 3/32 THICK</p>	<p><b>39943</b> <sup>21</sup></p>  <p><b>119</b></p> <p>15/16 ID X 1-1/8 OD 5 3/32 THICK</p>	<p><b>39944</b> <sup>22</sup></p>  <p><b>120</b></p> <p>1 ID X 1-3/16 OD 5 3/32 THICK</p>	<p><b>39944</b> <sup>23</sup></p>  <p><b>121</b></p> <p>1-1/16 ID X 1-1/4 OD 5 3/32 THICK</p>	<p><b>39944</b> <sup>24</sup></p>  <p><b>122</b></p> <p>1 ID X 1-3/16 OD 5 3/32 THICK</p>
<p><b>39986</b> <sup>25</sup></p>  <p><b>209</b></p> <p>11/16 ID X 15/16 OD 5 1/8 THICK</p>	<p><b>12620</b> <sup>26</sup></p>  <p><b>210</b></p> <p>3/4 ID X 1 OD 5 1/8 THICK</p>	<p><b>12621</b> <sup>27</sup></p>  <p><b>211</b></p> <p>13/16 ID X 1-1/16 OD 5 1/8 THICK</p>	<p><b>12622</b> <sup>28</sup></p>  <p><b>212</b></p> <p>7/8 ID X 1-1/8 OD 5 1/8 THICK</p>	<p><b>12623</b> <sup>29</sup></p>  <p><b>213</b></p> <p>15/16 ID X 1-3/16 OD 5 1/8 THICK</p>	<p><b>12624</b> <sup>30</sup></p>  <p><b>214</b></p> <p>1 ID X 1-1/4 OD 5 1/8 THICK</p>	<p><b>12625</b> <sup>31</sup></p>  <p><b>215</b></p> <p>1-1/16 ID X 1-5/16 OD 5 1/8 THICK</p>	<p><b>12626</b> <sup>32</sup></p>  <p><b>216</b></p> <p>1-1/8 ID X 1-3/8 OD 5 1/8 THICK</p>





























# J&B Fleet - Industrial Supply

22428 Harrisburg-Westville Rd. Alliance, Ohio 44601 Phone: (330) 821-6342 Fax: (330) 821-0411

www.jbfleet.com

PART # 2031

## O-RINGS #5

<p>12627 <sup>1</sup></p>  <p><b>217</b></p> <p>1-3/16 ID X 1-7/16 OD</p> <p>5 1/8 THICK</p>	<p>12628 <sup>2</sup></p>  <p><b>218</b></p> <p>1-1/4 ID X 1-1/2 OD</p> <p>5 1/8 THICK</p>	<p>12629 <sup>3</sup></p>  <p><b>219</b></p> <p>1-5/16 ID X 1-9/16 OD</p> <p>5 1/8 THICK</p>	<p>12630 <sup>4</sup></p>  <p><b>220</b></p> <p>1-3/8 ID X 1-5/8 OD</p> <p>5 1/8 THICK</p>	<p>12631 <sup>5</sup></p>  <p><b>221</b></p> <p>1-7/16 ID X 1-11/16 OD</p> <p>5 1/8 THICK</p>	<p>13453 <sup>6</sup></p>  <p><b>333</b></p> <p>2-1/2 ID X 2-7/8 OD</p> <p>3 3/16 THICK</p>
<p>12632 <sup>7</sup></p>  <p><b>222</b></p> <p>1-1/2 ID X 1-3/4 OD</p> <p>5 1/8 THICK</p>	<p>39980 <sup>8</sup></p>  <p><b>223</b></p> <p>1-5/8 ID X 1-7/8 OD</p> <p>5 1/8 THICK</p>	<p>39981 <sup>9</sup></p>  <p><b>224</b></p> <p>1-3/4 ID X 2 OD</p> <p>5 1/8 THICK</p>	<p>39982 <sup>10</sup></p>  <p><b>225</b></p> <p>1-7/8 ID X 2-1/8 OD</p> <p>5 1/8 THICK</p>	<p>39983 <sup>11</sup></p>  <p><b>226</b></p> <p>2 ID X 2-1/4 OD</p> <p>3 1/8 THICK</p>	<p>13454 <sup>12</sup></p>  <p><b>334</b></p> <p>2-5/8 ID X 3 OD</p> <p>3 3/16 THICK</p>
<p>39984 <sup>13</sup></p>  <p><b>227</b></p> <p>2-1/8 ID X 2-3/8 OD</p> <p>3 1/8 THICK</p>	<p>39985 <sup>14</sup></p>  <p><b>228</b></p> <p>2-1/4 ID X 2-1/2 OD</p> <p>3 1/8 THICK</p>	<p>12633 <sup>15</sup></p>  <p><b>325</b></p> <p>1-1/2 ID X 1-7/8 OD</p> <p>5 3/16 THICK</p>	<p>12634 <sup>16</sup></p>  <p><b>326</b></p> <p>1-5/8 ID X 2 OD</p> <p>5 3/16 THICK</p>	<p>12635 <sup>17</sup></p>  <p><b>327</b></p> <p>1-3/4 ID X 2-1/8 OD</p> <p>5 3/16 THICK</p>	<p>13455 <sup>18</sup></p>  <p><b>335</b></p> <p>2-3/4 ID X 3-1/8 OD</p> <p>3 3/16 THICK</p>
<p>13448 <sup>19</sup></p>  <p><b>328</b></p> <p>1-7/8 ID X 2-1/4 OD</p> <p>5 3/16 THICK</p>	<p>13449 <sup>20</sup></p>  <p><b>329</b></p> <p>2 ID X 2-3/8 OD</p> <p>5 3/16 THICK</p>	<p>13450 <sup>21</sup></p>  <p><b>330</b></p> <p>2-1/8 ID X 2-1/2 OD</p> <p>5 3/16 THICK</p>	<p>13451 <sup>22</sup></p>  <p><b>331</b></p> <p>2-1/4 ID X 2-5/8 OD</p> <p>3 3/16 THICK</p>	<p>13452 <sup>23</sup></p>  <p><b>332</b></p> <p>2-3/8 ID X 2-3/4 OD</p> <p>3 3/16 THICK</p>	<p>24</p>

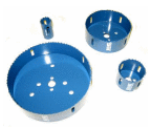
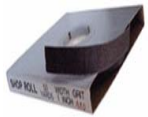

LET US HELP YOU MAKE THE CONNECTION

PART # 3017



# O-RINGS



J & B FLEET-INDUSTRIAL SUPPLY  
PHONE: 330-821-6342

<b>12607</b> 9/32 OD 1/16 THICK 25	<b>12608</b> 5/16 OD 1/16 THICK 25	<b>12609</b> 11/32 OD 1/16 THICK 25	<b>12610</b> 3/8 OD 1/16 THICK 25	<b>12611</b> 7/16 OD 1/16 THICK 25	<b>12612</b> 1/2 OD 1/16 THICK 25
<b>12613</b> 9/16 OD 3/32 THICK 25	<b>12614</b> 5/8 OD 3/32 THICK 25	<b>12615</b> 11/16 OD 3/32 THICK 25	<b>12616</b> 3/4 OD 3/32 THICK 10	<b>12617</b> 13/16 OD 3/32 THICK 10	<b>12618</b> 7/8 OD 3/32 THICK 10
<b>12619</b> 15/16 OD 3/32 THICK 10	<b>12620</b> 1" OD 1/8 THICK 10	<b>12621</b> 1-1/16 OD 1/8 THICK 10	<b>12622</b> 1-1/8 OD 1/8 THICK 10	<b>12623</b> 1-3/16 OD 1/8 THICK 10	<b>12624</b> 1-1/4 OD 1/8 THICK 10

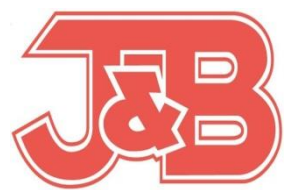
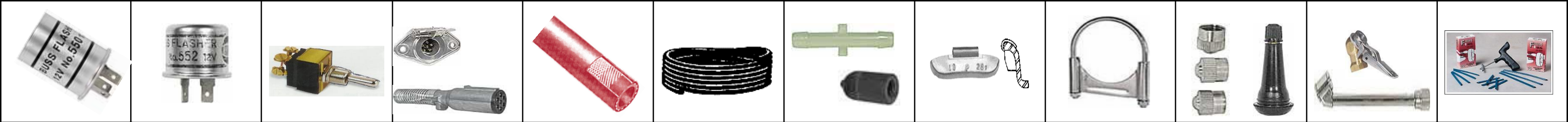









# J&B Fleet - Industrial Supply

22428 Harrisburg-Westville Rd. Alliance, Ohio 44601 Phone: (330) 821-6342 Fax: (330) 821-0411

[www.jbfleet.com](http://www.jbfleet.com)

## O-RING FACE SEAL O-RING 90 DUROMETER NITRILE

**PART # 2810**

<p><b>56230</b></p>  <p><b>-4</b> <b>1/4" END SIZE</b></p> <p>10</p>	<p><b>56233</b></p>  <p><b>-10</b> <b>5/8" END SIZE</b></p> <p>10</p>	<p><b>56236</b></p>  <p><b>-16</b> <b>1" END SIZE</b></p> <p>5</p>	
<p><b>56231</b></p>  <p><b>-6</b> <b>3/8" END SIZE</b></p> <p>10</p>	<p><b>56234</b></p>  <p><b>-12</b> <b>3/4" END SIZE</b></p> <p>5</p>	<p><b>56237</b></p>  <p><b>-20</b> <b>1-1/4" END SIZE</b></p> <p>5</p>	
<p><b>56232</b></p>  <p><b>-8</b> <b>1/2" END SIZE</b></p> <p>10</p>	<p><b>56235</b></p>  <p><b>-14</b> <b>7/8" END SIZE</b></p> <p>5</p>	<p><b>56238</b></p>  <p><b>-24</b> <b>1-1/2" END SIZE</b></p> <p>5</p>	



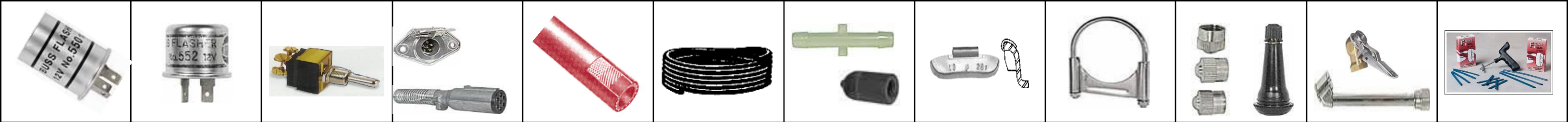









**J&B Fleet - Industrial Supply**

22428 Harrisburg-Westville Rd. Alliance, Ohio 44601 Phone: (330) 821-6342 Fax: (330) 821-0411

[www.jbfleet.com](http://www.jbfleet.com)

**SAE STRAIGHT THREAD PORT O-RINGS  
90 DUROMETER NITRILE**

**PART # 2811**

<p>56260</p>  <p>-4 1/4" END SIZE</p> <p>20</p>	<p>56266</p>  <p>-8 1/2" END SIZE</p> <p>15</p>	<p>56272</p>  <p>-16 1" END SIZE</p> <p>10</p>	
<p>56262</p>  <p>-5 5/16" END SIZE</p> <p>20</p>	<p>56268</p>  <p>-10 5/8" END SIZE</p> <p>10</p>	<p>56274</p>  <p>-20 1-1/4" END SIZE</p> <p>5</p>	
<p>56264</p>  <p>-6 3/8" END SIZE</p> <p>20</p>	<p>56270</p>  <p>-12 3/4" END SIZE</p> <p>10</p>		

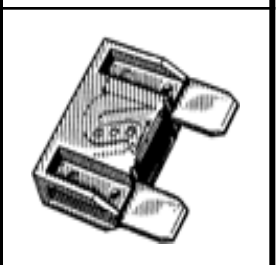



# O-RING ASSORTMENTS

## METRIC

- Convenient re-sealable plastic case.
- 419 o-rings. 32 sizes.

I/D	Section	I/D	Section
3	1.5mm	20	3.5mm
4.4	2.0mm	22	3.5mm
5	2.0mm	23.5	3.5mm
7	1.5mm	25	3.5mm
10	1.5mm	26.5	3.5mm
13	1.5mm	28	3.5mm
10	2.5mm	30	3.5mm
11	2.5mm	31	3.5mm
13	2.5mm	33	3.5mm
14	2.5mm	34.5	3.5mm
16	2.5mm	36	3.5mm
18	2.5mm	38	3.5mm
19	2.5mm	41	3.5mm
21	2.5mm	44	3.5mm
22	2.5mm	47	3.5mm
18	3.5mm	50	3.5mm



**J&B #**

**2072**

## STANDARD

- Convenient re-sealable plastic case.
- 382 o-rings. 30 sizes.

I/D	Section	I/D	Section
1/8	1/16	13/16	1/8
5/32	1/16	7/8	1/8
3/16	1/16	15/16	1/8
7/32	1/16	1"	1/8
1/4	1/16	1-1/16	1/8
5/16	1/16	1-1/8	1/8
3/8	1/16	1-3/16	1/8
3/8	3/32	1-1/4	1/8
7/16	3/32	1-5/16	1/8
1/2	3/32	1-3/8	1/8
9/16	3/32	1-7/16	1/8
5/8	3/32	1-1/2	1/8
11/16	3/32	1-1/2	3/16
3/4	3/32	1-5/8	3/16
3/4	1/8	1-3/4	3/16



**J&B #**

**2071**

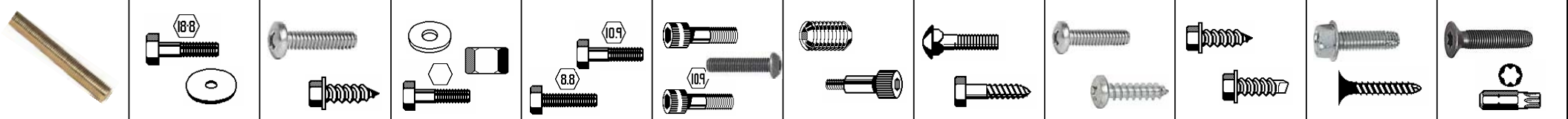

























# J&B Fleet - Industrial Supply

22428 Harrisburg-Westville Rd. Alliance, Ohio 44601 Phone: (330) 821-6342 Fax: (330) 821-0411

[www.jbfleet.com](http://www.jbfleet.com)

PART # 2220

## RUBBER GROMMETS

<p><b>38201</b> <sup>1</sup></p>  <p>1/8 BORE 3/32 GROOVE 1/2 OD 5/16 THICKNESS</p> <p>5</p>	<p><b>38172</b> <sup>2</sup></p>  <p>5/32 BORE 1/16 GROOVE 3/8 OD 3/16 THICKNESS</p> <p>5</p>	<p><b>38202</b> <sup>3</sup></p>  <p>3/16 BORE 1/16 GROOVE 1/2 OD 1/4 THICKNESS</p> <p>5</p>	<p><b>38173</b> <sup>4</sup></p>  <p>3/16 BORE 1/4 GROOVE 7/16 OD 3/8 THICKNESS</p> <p>5</p>	<p><b>38204</b> <sup>5</sup></p>  <p>1/4 BORE 1/4 GROOVE 5/8 OD 3/16 THICKNESS</p> <p>5</p>	<p><b>38205</b> <sup>6</sup></p>  <p>1/4 BORE 1/4 GROOVE 1-1/4 OD 1/4 THICKNESS</p> <p>5</p>
<p><b>38206</b> <sup>7</sup></p>  <p>5/16 BORE 1/16 GROOVE 13/16 OD 5/16 THICKNESS</p> <p>5</p>	<p><b>38207</b> <sup>8</sup></p>  <p>5/16 BORE 1/8 GROOVE 13/16 OD 3/8 THICKNESS</p> <p>5</p>	<p><b>38208</b> <sup>9</sup></p>  <p>5/16 BORE 1/4 GROOVE 13/16 OD 1/2 THICKNESS</p> <p>5</p>	<p><b>38209</b> <sup>10</sup></p>  <p>3/8 BORE 1/16 GROOVE 5/8 OD 9/32 THICKNESS</p> <p>5</p>	<p><b>38210</b> <sup>11</sup></p>  <p>3/8 BORE 1/16 GROOVE 1-1/4 OD 1/4 THICKNESS</p> <p>5</p>	<p><b>38211</b> <sup>12</sup></p>  <p></p>
<p><b>38213</b> <sup>13</sup></p>  <p>1/2 BORE 3/32 GROOVE 31/32 OD 9/32 THICKNESS</p> <p>5</p>	<p><b>38216</b> <sup>14</sup></p>  <p>1/2 BORE 1/4 GROOVE 1-1/16 OD 1/2 THICKNESS</p> <p>5</p>	<p><b>38217</b> <sup>15</sup></p>  <p>5/8 BORE 1/8 GROOVE 1-1/8 OD 3/8 THICKNESS</p> <p>5</p>	<p><b>38218</b> <sup>16</sup></p>  <p>5/8 BORE 1/16 GROOVE 1-1/8 OD 5/16 THICKNESS</p> <p>5</p>	<p><b>38219</b> <sup>17</sup></p>  <p></p>	<p><b>38220</b> <sup>18</sup></p>  <p></p>
<p><b>38220</b> <sup>19</sup></p>  <p>3/4 BORE 1/16 GROOVE 1-3/8 OD 3/8 THICKNESS</p> <p>5</p>	<p><b>38221</b> <sup>20</sup></p>  <p></p>	<p><b>38221</b> <sup>21</sup></p>  <p>3/4 BORE 1/16 GROOVE 1-5/8 OD 1/4 THICKNESS</p> <p>5</p>	<p><b>38222</b> <sup>22</sup></p>  <p></p>	<p><b>38222</b> <sup>23</sup></p>  <p>3/4 BORE 1/4 GROOVE 1-5/8 OD 7/16 THICKNESS</p> <p>5</p>	<p><b>38223</b> <sup>24</sup></p>  <p></p>

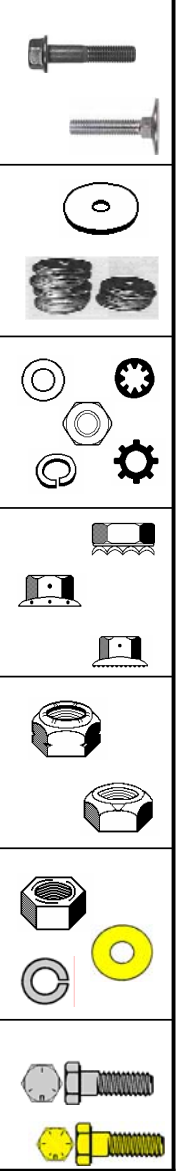

LET US HELP YOU MAKE THE CONNECTION

PART # 3035



# GROMMETS



J & B FLEET-INDUSTRIAL SUPPLY  
PHONE: 330-821-6342

<p><b>38201</b></p> <p>1/8 BORE 3/32 GROOVE 1/2 OD 5/16 THICKNESS</p> <p>5</p>	<p><b>38172</b></p> <p>5/32 BORE 1/16 GROOVE 3/8 OD 3/16 THICKNESS</p> <p>5</p>	<p><b>38202</b></p> <p>3/16 BORE 1/16 GROOVE 1/2 OD 1/4 THICKNESS</p> <p>5</p>	<p><b>38173</b></p> <p>3/16 BORE 1/4 GROOVE 7/16 OD 3/8 THICKNESS</p> <p>5</p>	<p><b>38204</b></p> <p>1/4 BORE 1/4 GROOVE 7/16 OD 3/16 THICKNESS</p> <p>5</p>	<p><b>38205</b></p> <p>1/4 BORE 1/4 GROOVE 1-1/4 OD 1/4 THICKNESS</p> <p>5</p>
<p><b>38206</b></p> <p>5/16 BORE 1/16 GROOVE 13/16 OD 5/16 THICKNESS</p> <p>5</p>	<p><b>38207</b></p> <p>5/16 BORE 1/8 GROOVE 13/16 OD 3/8 THICKNESS</p> <p>5</p>	<p><b>38208</b></p> <p>5/16 BORE 1/4 GROOVE 13/16 OD 1/2 THICKNESS</p> <p>5</p>	<p><b>38209</b></p> <p>3/8 BORE 1/16 GROOVE 5/8 OD 9/32 THICKNESS</p> <p>5</p>	<p><b>38213</b></p> <p>1/2 BORE 3/32 GROOVE 31/32 OD 9/32 THICKNESS</p> <p>5</p>	

























# J&B Fleet - Industrial Supply

22428 Harrisburg-Westville Rd. Alliance, Ohio 44601 Phone: (330) 821-6342 Fax: (330) 821-0411

[www.jbfleet.com](http://www.jbfleet.com)

PART # 2068

## INTERNAL RETAINING RINGS

 <b>10638</b> 1 10 1/4	 <b>10642</b> 2 10 1/2	 <b>10645</b> 3 15 3/4	 <b>40032</b> 4 5 1-1/16	 <b>40046</b> 6 2 1-7/16
 <b>10639</b> 7 10 5/16	 <b>10643</b> 8 10 9/16	 <b>40031</b> 9 10 13/16	 <b>10648</b> 10 5 1-1/8	 <b>40047</b> 12 2 1-1/2
 <b>10640</b> 13 10 3/8	 <b>10644</b> 14 10 5/8	 <b>10646</b> 15 10 7/8	 <b>40033</b> 16 5 1-3/16	 <b>40044</b> 17 2 1-5/16
 <b>10641</b> 19 10 7/16	 <b>40030</b> 20 10 11/16	 <b>10647</b> 21 10 1"	 <b>10649</b> 22 5 1-1/4	 <b>40045</b> 23 2 1-3/8
				 <b>40048</b> 18 2 1-5/8
				 <b>40049</b> 24 2 1-3/4





































# J&B Fleet - Industrial Supply

22428 Harrisburg-Westville Rd. Alliance, Ohio 44601 Phone: (330) 821-6342 Fax: (330) 821-0411

[www.jbfleet.com](http://www.jbfleet.com)

PART # 2036

## RETAINING RINGS

<p><b>10638</b> <sup>1</sup></p>  <p>20 1/4</p>	<p><b>10639</b> <sup>2</sup></p>  <p>20 5/16</p>	<p><b>10640</b> <sup>3</sup></p>  <p>20 3/8</p>	<p><b>10641</b> <sup>4</sup></p>  <p>15 7/16</p>	<p><b>10642</b> <sup>5</sup></p>  <p>15 1/2</p>	<p><b>10643</b> <sup>6</sup></p>  <p>10 9/16</p>	<p><b>10644</b> <sup>7</sup></p>  <p>10 5/8</p>	<p><b>10645</b> <sup>8</sup></p>  <p>5 3/4</p>
<p><b>10646</b> <sup>9</sup></p>  <p>5 7/8</p>	<p><b>10647</b> <sup>10</sup></p>  <p>5 1</p>	<p><b>10648</b> <sup>11</sup></p>  <p>3 1-1/8</p>	<p><b>10649</b> <sup>12</sup></p>  <p>3 1-1/4</p>	<p><b>40044</b> <sup>13</sup></p>  <p>3 1-5/16</p>	<p><b>40045</b> <sup>14</sup></p>  <p>3 1-3/8</p>	<p><b>40047</b> <sup>15</sup></p>  <p>3 1-1/2</p>	<p><b>40049</b> <sup>16</sup></p>  <p>2 1-3/4</p>
<p><b>10650</b> <sup>17</sup></p>  <p>20 1/4</p>	<p><b>10651</b> <sup>18</sup></p>  <p>20 5/16</p>	<p><b>10652</b> <sup>19</sup></p>  <p>20 3/8</p>	<p><b>10653</b> <sup>20</sup></p>  <p>15 7/16</p>	<p><b>10654</b> <sup>21</sup></p>  <p>15 1/2</p>	<p><b>10655</b> <sup>22</sup></p>  <p>10 9/16</p>	<p><b>10656</b> <sup>23</sup></p>  <p>10 5/8</p>	<p><b>10657</b> <sup>24</sup></p>  <p>5 3/4</p>
<p><b>10658</b> <sup>25</sup></p>  <p>5 7/8</p>	<p><b>10659</b> <sup>26</sup></p>  <p>5 1</p>	<p><b>10660</b> <sup>27</sup></p>  <p>3 1-1/8</p>	<p><b>10661</b> <sup>28</sup></p>  <p>3 1-1/4</p>	<p><b>40060</b> <sup>29</sup></p>  <p>3 1-5/16</p>	<p><b>40061</b> <sup>30</sup></p>  <p>3 1-3/8</p>	<p><b>40063</b> <sup>31</sup></p>  <p>3 1-1/2</p>	<p><b>40065</b> <sup>32</sup></p>  <p>2 1-3/4</p>



LET US HELP YOU MAKE THE CONNECTION

PART # 3013



# INTERNAL SNAP RINGS



J & B FLEET-INDUSTRIAL SUPPLY  
PHONE: 330-821-6342

<b>10638</b> <b>1/4"</b> 10	<b>10639</b> <b>5/16"</b> 10	<b>10640</b> <b>3/8"</b> 10	<b>10641</b> <b>7/16"</b> 5	<b>10642</b> <b>1/2"</b> 5	<b>10643</b> <b>9/16"</b> 4
<b>10644</b> <b>5/8"</b> 4	<b>40030</b> <b>11/16"</b> 4	<b>10645</b> <b>3/4"</b> 4	<b>40031</b> <b>13/16"</b> 4	<b>10646</b> <b>7/8"</b> 4	<b>10647</b> <b>1"</b> 4
<b>40032</b> <b>1-1/16"</b> 2	<b>10648</b> <b>1-1/8"</b> 2	<b>40033</b> <b>1-3/16"</b> 2	<b>10649</b> <b>1-1/4"</b> 2	<b>40044</b> <b>1-5/16"</b> 2	<b>40045</b> <b>1-3/8"</b> 2



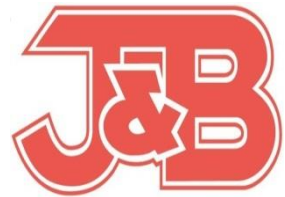

































# J&B Fleet - Industrial Supply

www.jbfleet.com

22428 Harrisburg-Westville Rd. Alliance, Ohio 44601 Phone: (330) 821-6342 Fax: (330) 821-0411

## EXTERNAL RETAINING RINGS

PART # 2066

 <b>87000</b> 1 10 <b>1/8"</b>	 <b>10651</b> 2 10 <b>5/16"</b>	 <b>10653</b> 3 10 <b>7/16"</b>	 <b>10762</b> 4 5 <b>11/16"</b>	 <b>87003</b> 5 5 <b>15/16"</b>	 <b>40059</b> 6 3 <b>1-3/16"</b>	 <b>40062</b> 7 3 <b>1-7/16"</b>	 <b>87004</b> 8 2 <b>1-7/8"</b>
 <b>40055</b> 9 10 <b>3/16"</b>	 <b>40057</b> 10 10 <b>11/32"</b>	 <b>10654</b> 11 10 <b>1/2"</b>	 <b>10657</b> 12 10 <b>3/4"</b>	 <b>10659</b> 13 5 <b>1"</b>	 <b>10661</b> 14 3 <b>1-1/4"</b>	 <b>40063</b> 15 2 <b>1-1/2"</b>	 <b>40066</b> 16 2 <b>2"</b>
 <b>10650</b> 17 20 <b>1/4"</b>	 <b>10652</b> 18 10 <b>3/8"</b>	 <b>10655</b> 19 10 <b>9/16"</b>	 <b>87002</b> 20 5 <b>13/16"</b>	 <b>40058</b> 21 5 <b>1-1/16"</b>	 <b>40060</b> 22 3 <b>1-5/16"</b>	 <b>40064</b> 23 2 <b>1-5/8"</b>	 <b>87006</b> 24 2 <b>2-1/4"</b>
 <b>40056</b> 25 10 <b>9/32"</b>	 <b>87001</b> 26 10 <b>13/32"</b>	 <b>10656</b> 27 10 <b>5/8"</b>	 <b>10658</b> 28 5 <b>7/8"</b>	 <b>10660</b> 29 5 <b>1-1/8"</b>	 <b>40061</b> 30 3 <b>1-3/8"</b>	 <b>40065</b> 31 2 <b>1-3/4"</b>	 <b>87008</b> 32 2 <b>2-1/2"</b>

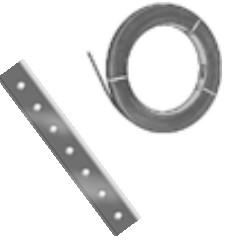

LET US HELP YOU MAKE THE CONNECTION

PART # 3009



# RETAINING RINGS



J & B FLEET-INDUSTRIAL SUPPLY  
PHONE: 330-821-6342

<b>10650</b> 1/4" External 10	<b>10651</b> 5/16" External 10	<b>10652</b> 3/8" External 10	<b>10653</b> 7/16" External 5	<b>10654</b> 1/2" External 5	<b>10655</b> 9/16" External 4
<b>10656</b> 5/8" External 4	<b>10657</b> 3/4" External 4	<b>10659</b> 1" External 4	<b>10638</b> 1/4" Internal 10	<b>10639</b> 5/16" Internal 10	<b>10640</b> 3/8" Internal 10
<b>10641</b> 7/16" Internal 5	<b>10642</b> 1/2" Internal 5	<b>10643</b> 9/16" Internal 4	<b>10644</b> 5/8" Internal 4	<b>10645</b> 3/4" Internal 4	<b>10647</b> 1" Internal 4



LET US HELP YOU MAKE THE CONNECTION

PART # 3011



# EXTERNAL SNAP RINGS



J & B FLEET-INDUSTRIAL SUPPLY  
PHONE: 330-821-6342

<b>10650</b>  1/4"  10	<b>40056</b>  9/32"  10	<b>10651</b>  5/16"  10	<b>40057</b>  11/32"  5	<b>10652</b>  3/8"  5	<b>10653</b>  7/16"  4
<b>10654</b>  1/2"  4	<b>10655</b>  9/16"  4	<b>10656</b>  5/8"  4	<b>10657</b>  3/4"  4	<b>10658</b>  7/8"  4	<b>10659</b>  1"  4
<b>40058</b>  1-1/16"  2	<b>10660</b>  1-1/8"  2	<b>40059</b>  1-3/16"  2	<b>10661</b>  1-1/4"  2	<b>40060</b>  1-5/16"  2	<b>40061</b>  1-3/8"  2

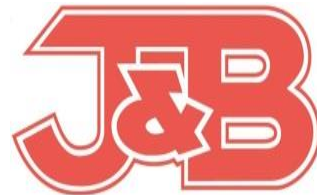





















# J&B Fleet - Industrial Supply

22428 Harrisburg-Westville Rd. Alliance, Ohio 44601 Phone: (330) 821-6342 Fax: (330) 821-0411

[www.jbfleet.com](http://www.jbfleet.com)

**PART # 2039**

## RETAINING RINGS

<p><b>12706</b> <sup>1</sup></p>  <p>25 <b>1/16"</b></p>	<p><b>12711</b> <sup>2</sup></p>  <p>25 <b>3/32"</b></p>	<p><b>12712</b> <sup>3</sup></p>  <p>25 <b>1/8"</b></p>	<p><b>12707</b> <sup>4</sup></p>  <p>25 <b>9/64"</b></p>	<p><b>12713</b> <sup>5</sup></p>  <p>25 <b>5/32"</b></p>	<p><b>12708</b> <sup>6</sup></p>  <p>25 <b>11/64"</b></p>	<p><b>12714</b> <sup>7</sup></p>  <p>25 <b>3/16"</b></p>	<p><b>12717</b> <sup>8</sup></p>  <p>25 <b>7/32"</b></p>
<p><b>12715</b> <sup>9</sup></p>  <p>25 <b>1/4"</b></p>	<p><b>12716</b> <sup>10</sup></p>  <p>25 <b>5/16"</b></p>	<p><b>10951</b> <sup>11</sup></p>  <p>25 <b>3/8"</b></p>	<p><b>12718</b> <sup>12</sup></p>  <p>25 <b>7/16"</b></p>	<p><b>12719</b> <sup>13</sup></p>  <p>25 <b>1/2"</b></p>	<p><b>12768</b> <sup>14</sup></p>  <p>25 <b>9/16"</b></p>	<p><b>11094</b> <sup>15</sup></p>  <p>25 <b>5/8"</b></p>	<p><b>11095</b> <sup>16</sup></p>  <p>25 <b>3/4"</b></p>
<p><b>11096</b> <sup>17</sup></p>  <p>20 <b>7/8"</b></p>	<p><b>11097</b> <sup>18</sup></p>  <p>20 <b>1"</b></p>	<p><b>12709</b> <sup>19</sup></p>  <p>20 <b>1-3/16"</b></p>	<p><b>12710</b> <sup>20</sup></p>  <p>20 <b>1-3/8"</b></p>	<p><sup>21</sup></p>	<p><sup>22</sup></p>	<p><sup>23</sup></p>	<p><sup>24</sup></p>
<p><sup>25</sup></p>	<p><sup>26</sup></p>	<p><sup>27</sup></p>	<p><sup>28</sup></p>	<p><sup>29</sup></p>	<p><sup>30</sup></p>	<p><sup>31</sup></p>	<p><sup>32</sup></p>

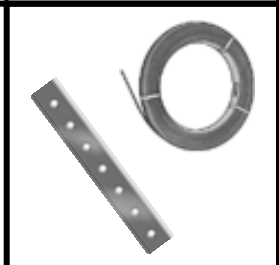

LET US HELP YOU MAKE THE CONNECTION

**PART # 3015**



# E - RINGS



J & B FLEET-INDUSTRIAL SUPPLY  
PHONE: 330-821-6342

<b>12706</b> <b>1/16"</b> 20	<b>12711</b> <b>3/32"</b> 20	<b>12712</b> <b>1/8"</b> 20	<b>12707</b> <b>9/64"</b> 20	<b>12713</b> <b>5/32"</b> 20	<b>12708</b> <b>11/64"</b> 15
<b>12714</b> <b>3/16"</b> 15	<b>12717</b> <b>7/32"</b> 15	<b>12715</b> <b>1/4"</b> 15	<b>12716</b> <b>5/16"</b> 10	<b>10951</b> <b>3/8"</b> 10	<b>12718</b> <b>7/16"</b> 10
<b>12719</b> <b>1/2"</b> 10	<b>12768</b> <b>9/16"</b> 5	<b>11094</b> <b>5/8"</b> 5	<b>11095</b> <b>3/4"</b> 5	<b>11096</b> <b>7/8"</b> 5	<b>11097</b> <b>1"</b> 5