

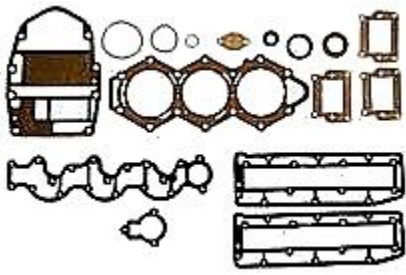

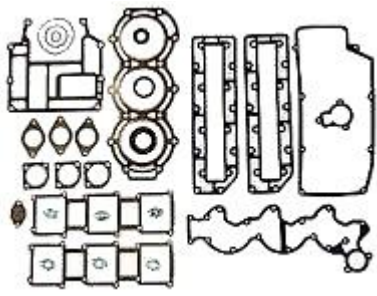

NISSAN / TOHATSU

DESCRIPTION	OEM NO.	OUR PART NO.	DISTRIBUTOR	DEALER
All descriptions are for reference only.				
Gasket kits contain a seal kit.				
Power Head Kits				
40/50 Hp Complete Kit		10-7480K		
60/70 Complete Kit	3F3871210M	10-7280K		
90 Hp Complete Kit Pre-1999	3B7-87121-1	10-7380K		
Head Gaskets				
60/70 Head Gasket	3F3-01005-0	10-7200		
90 HP Head Gasket	3B7-01005-0	10-7300		
40/50 Head Gasket	3C8-010053	10-7400		

PART No. 10-7480K	PART No. 10-7280K OEM No. 3F3871210M	PART No. 10-7380K OEM No. 3B7-87121-1
		
40/50 Hp Complete Kit	60/70 Complete Kit	90 Hp Complete Kit Pre-1999





PART No. 10-7200 OEM No. 3F3-01005-0	PART No. 10-7300 OEM No. 3B7-01005-0	PART No. 10-7400 OEM No. 3C8-010053
		
60/70 Head Gasket	90 HP Head Gasket	40/50 Head Gasket

NISSAN / TOHATSU

DESCRIPTION	OEM NO.	OUR PART NO.	DISTRIBUTOR	DEALER
Oil Seal Kits				
40/50 Hp Oil Seal Kit		10-7470K		
60/70 Hp Oil Seal Kit		10-7270K		
90 HP Oil Seal Kit		10-7370K		
Individual Oil Seals				
Upper Crank Oil Seal 60/70 Hp	353-00121	10-7272		
Lower Crank Oil Seal 60/70 Hp	126-00121	10-7274		
Lower Crank Oil Seal 60/70 Hp	3F3-01215	10-7276		
Lower Crank Oil Seal 90 Hp	3B7-00121	10-7372		
Lower Crank Oil Seal 90 Hp Pre-1999	3B701215	10-7374		
Lower Crank Oil Seal 90 Hp 1999+	3C7-01215	10-7375		
Oil Seal	334-00122	10-7472		
Oil Seal	3C8-01215	10-7474		
Oil Seal	3C8-00121	10-7476		

PART No. 10-7470K	PART No. 10-7270K	PART No. 10-7370K
		
40/50 Hp Oil Seal Kit	60/70 Hp Oil Seal Kit	90 HP Oil Seal Kit

PART No. 10-7272 OEM No. 353-00121	PART No. 10-7274 OEM No. 126-00121	PART No. 10-7276 OEM No. 3F3-01215	PART No. 10-7372 OEM No. 3B7-00121	PART No. 10-7374 OEM No. 3B701215
				
Upper Crank Oil Seal 60/70 Hp	Lower Crank Oil Seal 60/70 Hp	Lower Crank Oil Seal 60/70 Hp	Lower Crank Oil Seal 90 Hp	Lower Crank Oil Seal 90 Hp Pre-1999

PART No. 10-7375 OEM No. 3C7-01215	PART No. 10-7472 OEM No. 334-00122	PART No. 10-7474 OEM No. 3C8-01215	PART No. 10-7476 OEM No. 3C8-00121
			
Lower Crank Oil Seal 90 Hp 1999+	Oil Seal	Oil Seal	Oil Seal

NISSAN / TOHATSU

DESCRIPTION	OEM NO.	OUR PART NO.	DISTRIBUTOR	DEALER
O-ring Kits				
40/50 Hp Upper/Lower O-ring Kit		10-7475K		
Individual O-rings				
60/70 Hp Upper O-ring	353-00108	10-7277		
60/70 Hp Lower O-ring	151-00053	10-7278		
90 Hp Upper O-ring	353-00108	10-7377		
90 Hp Lower O-ring	171-00053	10-7378		
90 HP Oil Pump	3B7-09002	10-7379		
40/50 Hp Upper O-ring	3C8-00108	10-7477		
40/50 Hp Lower O-ring	346-01216	10-7478		

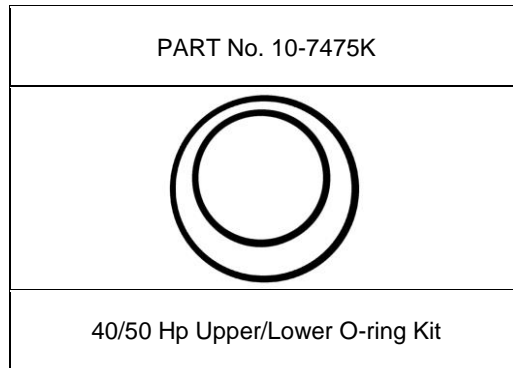

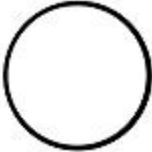
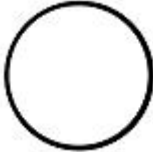
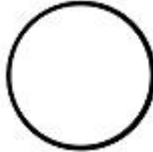
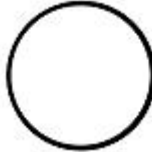

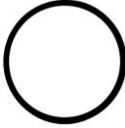
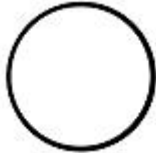



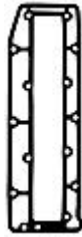

PART No. 10-7277 OEM No. 353-00108	PART No. 10-7278 OEM No. 151-00053	PART No. 10-7377 OEM No. 353-00108	PART No. 10-7378 OEM No. 171-00053
			
60/70 Hp Upper O-ring	60/70 Hp Lower O-ring	90 Hp Upper O-ring	90 Hp Lower O-ring

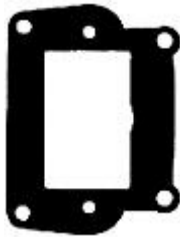
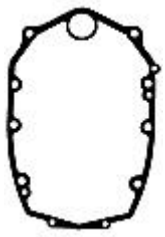
PART No. 10-7379 OEM No. 3B7-09002	PART No. 10-7477 OEM No. 3C8-00108	PART No. 10-7478 OEM No. 346-01216
		
90 HP Oil Pump	40/50 Hp Upper O-ring	40/50 Hp Lower O-ring











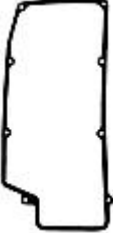
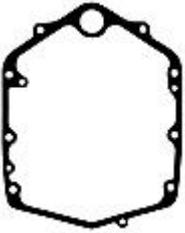
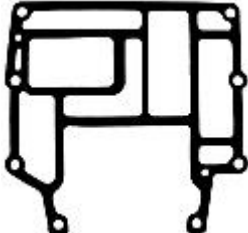

NISSAN / TOHATSU

DESCRIPTION	OEM NO.	OUR PART NO.	DISTRIBUTOR	DEALER
Individual Niss/Tohatsu Gaskets				
60/70 Head Cover	3F3-01024-0	10-7210		
60/70 Exhaust Cover	3F3-023051-0	10-7215		
Thermostat (use 10-7320)	353-01032-0	10-7225		
Intake Manifold	3F3-02104-0	10-7230		
Drive Housing	3F3-61012-0	10-7235		
Base	3F3-01303-0	10-7240		
Exhaust	3F3-02312-0	10-7245		
Exhaust Housing	3F3-61181-0	10-7250		
90 Hp Head Cover	3B7-01024-0	10-7305		
90 Hp Exhaust Cover	3B7-02305-0	10-7310		
Blind Plate (Use 10-7415)	3B7-09082-0	10-7315		
Thermostat (Use 10-7225)	353-02104-0	10-7320		
90 Hp. Intake Gasket	3B7-02104-0	10-7325		
90 Hp Carb Base	346-02011-0	10-7330		
Arrestor	346-02414-0	10-7335		
Silencer	3B7-02418-0	10-7340		
Drive Housing	3B7-61012-0	10-7345		
90 HP Base	3B7-01303-0	10-7350		
Exhaust	3B7-02312-0	10-7355		
Exhaust Housing	3B7-61181-0	10-7360		
Head Cover	3C8-01024-0	10-7405		
Exhaust Cover	3C8-02305-0	10-7410		
Blind Plate (Use 10-7315)	3C8-09082-0	10-7415		
Manifold	3C8-02104-0	10-7420		
Drive Housing	3C8-61012-0	10-7425		
Base Gasket	3C8-013030-0	10-7430		
Exhaust	3C8-02312-0	10-7435		
Exhaust Housing	3C8-61181-0	10-7440		
Check Valve Gasket	3C7-001153-0	10-7445A		
Check Valve Gasket	3C7-001154-0	10-7445B		

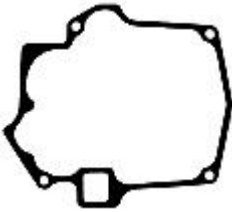
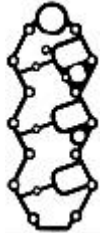
PART No. 10-7210 OEM No. 3F3-01024-0	PART No. 10-7215 OEM No. 3F3-023051-0	PART No. 10-7225 OEM No. 353-01032-0	PART No. 10-7230 OEM No. 3F3-02104-0	PART No. 10-7235 OEM No. 3F3-61012-0
				
60/70 Head Cover	60/70 Exhaust Cover	Thermostat (use 10-7320)	Intake Manifold	Drive Housing

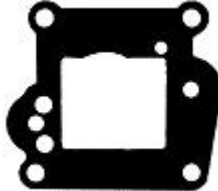
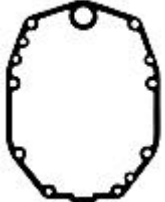
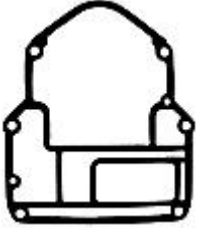
PART No. 10-7240 OEM No. 3F3-01303-0	PART No. 10-7245 OEM No. 3F3-02312-0	PART No. 10-7250 OEM No. 3F3-61181-0	PART No. 10-7305 OEM No. 3B7-01024-0	PART No. 10-7310 OEM No. 3B7-02305-0
				
Base	Exhaust	Exhaust Housing	90 Hp Head Cover	90 Hp Exhaust Cover

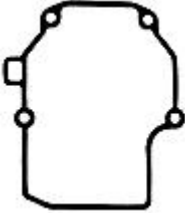
NISSAN / TOHATSU

PART No. 10-7315 OEM No. 3B7-09082-0	PART No. 10-7320 OEM No. 353-02104-0	PART No. 10-7325 OEM No. 3B7-02104-0	PART No. 10-7330 OEM No. 346-02011-0	PART No. 10-7335 OEM No. 346-02414-0
				
Blind Plate (Use 10-7415)	Thermostat (Use 10-7225)	90 Hp. Intake Gasket	90 Hp Carb Base	Arrestor
PART No. 10-7340 OEM No. 3B7-02418-0	PART No. 10-7345 OEM No. 3B7-61012-0	PART No. 10-7350 OEM No. 3B7-01303-0	PART No. 10-7355 OEM No. 3B7-02312-0	PART No. 10-7360 OEM No. 3B7-61181-0
				
Silencer	Drive Housing	90 HP Base	Exhaust	Exhaust Housing
PART No. 10-7405 OEM No. 3C8-01024-0	PART No. 10-7410 OEM No. 3C8-02305-0	PART No. 10-7415 OEM No. 3C8-09082-0	PART No. 10-7420 OEM No. 3C8-02104-0	PART No. 10-7425 OEM No. 3C8-61012-0
				
Head Cover	Exhaust Cover	Blind Plate (Use 10-7315)	Manifold	Drive Housing
PART No. 10-7430 OEM No. 3C8-013030-0	PART No. 10-7435 OEM No. 3C8-02312-0	PART No. 10-7440 OEM No. 3C8-61181-0	PART No. 10-7445A OEM No. 3C7-001153-0	PART No. 10-7445B OEM No. 3C7-001154-0
				
Base Gasket	Exhaust	Exhaust Housing	Check Valve Gasket	Check Valve Gasket