



HONEYCOMB

SHADES

Effective April 9, 2018

design simplified™

TABLE OF CONTENTS

Product Overview

• What's New for 2018	2
• Features & Benefits	2
• Pattern Information	3
• Fabric and Rail Color Charts	4-8

Pricing for Standard Rectangular, Options, RemoteLift 2.0, Simplicity Surcharges

• Price Groups 1-12 Honeycomb Fabrics	9-20
• Price Group 13: – 2" Hybrid Pleat – Semi-Opaque	21
• Price Group 14 – 2" Hybrid Pleat – Blackout	22
• Motorization Surcharges and Options.	23

Product Configuration Specifications

• Standard Cordlock	24
• Two-on-One Headrail	25
• Top-Down or Top-Down/Bottom-Up	26
• Two-Fabric Combination	27
• Cut-Outs	27
• Cordless Lift	28
• Cordless Lift & Lock	29
• Continuous Cord Loop	30-31

Versatile Innovations™

TriLight Shades®

• Features & Benefits	32
• Selecting a TriLight Shade	32
• Sheer Pleated Color Chart	33
• Pricing Groups and Options	34
• Configuration Specifications	35-37
• Stacking Information	35-37

Product Configuration Specifications

• RemoteLift™ 2.0 Motorization	38-42
• Simplicity and PowerWand™	43-47
• Vertical Application	48-51
• Classic Skylight & Skylight with Simplicity Motorization	52-55
• Arches	56-57
• Specialty Shapes	58-59
• Size Standards Summary	60-63
• Product Components Diagrams.	64-75

Oversize Common Carrier Delivery

All orders with any quantity of shades or blinds or any continuous valance 96" or more in width (or Vertical Applications over 96" in height) are considered oversize. Therefore, a net shipping charge of \$95.00 per order will be assessed.

Oversized orders that require expedited shipping will be quoted and charged accordingly.

Please see General Information for additional freight and shipping charge information.

WHAT'S NEW FOR 2018

- Two new motorization options:
 - Simplicity Rechargeable: the ease of Simplicity motorization with the convenience of a rechargeable battery. The rechargeable battery fits neatly in the headrail eliminating the need for an external battery wand or DC Power Supply
 - > Simplicity Rechargeable is also available as a 2-on-1 headrail, covering expanses up to 144" wide.
 - > Also available with a solar panel option that continually charges the battery
 - PowerWand™: the ease of Simplicity motorization with the convenience of remote free operation. Lift and lower the shade with the touch of a button on the pendant that hangs from the front of the headrail. The rechargeable battery is recharged using the charging port in pendant.
 - > To suit your customer's needs the black or white colored wand is available in one foot increments from one to five feet and can be placed on either the left or right

FEATURES & BENEFITS



- Their distinctive cellular construction helps insulate homes and reduce heating and cooling bills.
- Their superior sound absorption helps make surroundings quieter and more comfortable.
- 100% stain-resistant polyester fabric is wrinkle-resistant and easy to clean and maintain – most fabric styles are completely washable.
- Color choices include over 200 options from neutrals and bold colors to exclusive prints and solids.
- Multiple cell size choices, including 2" Hybrid Pleat, cover small- to large-scale windows, plus sliding glass doors.
- Fabric opacities range from sheer and semi-sheer to blackout, offering privacy and light control versatility. FR fabrics are also available.
- The neutral white backing on most fabric styles provides a consistent appearance to the outside of the home.
- Offered with a wide selection of control options, including top-down/bottom-up, continuous loop, cordless lift, vertical application and motorized control, to fit any need.
- Cordless lift, cordless lift & lock, continuous cord loop, RemoteLift 2.0 shades, and Simplicity shades are available with Fabric Covered rails for a surcharge.
- Optional color-coordinated rails are available at no additional cost.
- Features Versatile Innovations™ TriLight Shades® for enhanced versatility.
- Limited lifetime warranty ensures your customers' satisfaction.

PATTERN INFORMATION

MOST PATTERNS ARE MADE FROM UNIQUE, DURABLE, POLYESTER FABRICS THAT REPEL DIRT, RESIST STAINS AND CLEAN EASILY.

Pattern Name	# of Cells	Price Group (Standard)	Winter R-Values	Summer Solar Heat Gain Coefficient	Care Code	Light Control	Hardware Restrictions	Hardware Options	
3/8" Marcella	H44	Single	2	4.92	0.41	1, 2 & 3	C	Cordless Lift & Lock, Two-Fabric Combo, Vertical Application, TriLight	<ul style="list-style-type: none"> • Standard Cordlock • Continuous Cord Loop System • Continuous Cord Loop Top-Down/Bottom-Up • Cordless Lift System • Cordless Lift & Lock • Two-Fabric Combination • Top-Down • Top-Down/Bottom-Up • Two-On-One Headrail • Vertical Application • Classic Skylight • Arches • Angles • Specialty Shapes • Battery Operated Motorization • TriLight
3/8" Opulence	H40	Single	3	4.45	0.35	1, 2 & 3	C	Cordless Lift & Lock, Two-Fabric Combo, Vertical Application, TriLight	
3/8" Opulence Blackout	H41	Single	10	5.89	0.21	1, 2 & 3	E	Cordless, Cordless Lift & Lock, Two-Fabric Combo, Vertical App, TriLight	
3/4" Cardiff	H91	Single	6	4.49	0.36	1, 2 & 3	C	–	
3/4" Glimmer	HS3	Single	6	5.00	0.41	1, 2 & 3	C	–	
3/4" Linen	H27	Single	6	4.49	0.36	1, 2 & 3	C	–	
3/4" Marcella	H45	Single	4	5.00	0.41	1, 2 & 3	C	–	
3/4" Marcella Blackout	H46	Single	9	5.88	0.20	1, 2 & 3	E	–	
3/4" Melodic	HX6	Single	6	4.49	0.36	1, 2 & 3	C	–	
3/4" Mirada	H92	Single	6	4.49	0.36	1, 2 & 3	C	–	
3/4" Opulence	H28	Single	6	4.49	0.36	1, 2 & 3	C	–	
3/4" Opulence Blackout	H29	Single	11	4.87	0.25	1, 2 & 3	E	–	
3/4" Peaceful	H96	Single	12	4.49	0.36	1, 2 & 3	C	Arches	
3/4" Radiance	HF6	Single	1	4.49	0.36	1, 2 & 3	C	–	
3/4" Radiance Blackout	HF7	Single	7	5.88	0.20	1, 2 & 3	E	–	
3/4" Serene FR*	H62	Single	6	5.16	0.36	1, 2 & 3	C	–	
3/4" Serene FR Blackout*	H60	Single	11	5.74	0.25	1, 2 & 3	E	–	
3/4" Tiffany Sheer	H25	Single	11	3.72	0.22	1, 2 & 3	A	TriLight	
3/4" Tranquility Semi-Sheer	H24	Single	11	4.07	0.41	1, 2 & 3	B	TriLight, Vertical Application	
1/2" Marcella Double Cell	H47	Double	5	5.26	0.30	1, 2 & 3	C	Cordless Two-Fabric Combo, Vertical App	
1/2" Opulence Double Cell	H39	Double	8	4.78	0.30	1, 2 & 3	C	Cordless Two-Fabric Combo, Vertical App	
3/8" Tricella Triple Cell	H58	Triple	11	5.78	0.20	1, 2 & 3	C	Cordless, Cordless Lift & Lock, Cordless TDBU, Cordless Two-Fabric Combo, Vertical App, Skylight, Top-Down Arch, Motorization, TriLight	
2" Hybrid Pleat – Semi-Opaque	HPF	Single	13	4.53	N/A	1, 2 & 3	C	Standard Cordlock, Two-Fabric Combo, Skylight, Arches, Angles, Specialty Shapes, PowerWand	
2" Hybrid Pleat – Blackout	HPR	Single	14	4.78	N/A	1, 2 & 3	E	Standard Cordlock, Two-Fabric Combo, Skylight, Arches, Angles, Specialty Shapes, PowerWand	

* Flame Resistant – Passes Flame Test NFPA 701

Winter R-Values

R-Value measures resistance to heat loss. The higher the R-Value, the more insulation the product provides. In winter, higher insulation means less heat loss and a warmer room. (Double glaze window.)

Summer Solar Heat Gain Coefficient

Coefficient measures the products ability to reduce heat gain from the sun. The lower the number, the less solar energy it transmits. In summer, less heat transmitted means a cooler room. (Double glaze window.)

Care Method 1

Dusting with a feather, or synthetic, non-abrasive, material duster is recommended for all Honeycomb Shade surfaces which are lightly soiled.

Care Method 2

Wiping with a soft, damp sponge or cloth, of non-abrasive material, with lukewarm water is recommended for all Honeycomb Shade surfaces which need spot cleaning.

Care Method 3

Vacuuming with a soft bristle vacuum cleaner brush attachment is recommended for all Honeycomb Shade surfaces which are heavily soiled.



A. Glare Reducing

Softly filters light and reduces glare. Images, shapes and people can be seen clearly. Provides the least amount of light and shape screening.



B. Filtering

Filters strong light. Images, shapes and people can be seen with some clarity. Provides a modest degree of light and shape screening.



C. Shading

Significantly reduces light. Images, shapes and people cannot be seen clearly. Provides a moderate to strong degree of light and shape screening. Darker colored materials tend to provide stronger screening than lighter colored materials in this category.



D. Blocking

Dramatically reduces light. Images, shapes and people are not distinguishable. Provides privacy against most all direct light and shape screening (except minimal light that may seep through closed or overlapping opaque/blackout slats and vanes).



E. Blackout

Blocks out virtually all light (except light that may enter on the sides of the shade) for maximum privacy and darkness.

FABRIC AND RAIL COLOR CHART

3/8" Single Cell Fabrics (Semi-Opaque & Blackout)

FABRIC			HARDWARE	
Code	Color #	Color Name	STD	VA
MARCELLA Semi-Opaque (Price Group 2)				
H44	807	Almond Glaze	630	N/A
H44	808	Brown Sugar	083	
H44	804	Crepe Souffle	882	
H44	803	Jasmine Wisp	674	
H44	802	Mountain Mist	862	
H44	801	Sugar Cane	661	

FABRIC			HARDWARE	
Code	Color #	Color Name	STD	VA
OPULENCE Semi-Opaque (Price Group 3)				
H40	606	Biscuit	882	N/A
H40	636	Chocolate Bliss	083	
H40	608	Cocoa	810	
H40	603	Doe	862	
H40	604	Fallen Snow	882	
H40	612	Gentle White	661	
H40	615	Sagebrush	621	
H40	629	Soft Linen	862	
H40	601	Soft White	661	
H40	617	Sunbeam	862	
H40	632	Tranquil Tea	954	
H40	637	Warm Cocoa	361	

FABRIC			HARDWARE	
Code	Color #	Color Name	STD	VA
OPULENCE Blackout (Price Group 10)				
H41	628	Cloud Puff	661	N/A
H41	703	Doe	862	
H41	702	Soft White	785	
H41	632	Tranquil Tea	954	

CODE KEY: HEADRAIL
STD = Standard Cordlock (Cordless Lift, Continuous Cord Loop, Simplicity and RemoteLift shades with coordinated rail.)
VA = Vertical Application shades

FABRIC AND RAIL COLOR CHART

3/4" Single Cell Fabrics (Semi-Opaque, Semi-Sheer & Sheer)

FABRIC			HARDWARE	
Code	Color #	Color Name	STD	VA
CARDIFF Semi-Opaque (Price Group 6)				
H91	3002	Distant Range	320	862
H91	3003	Haystack	954	661
H91	3006	Riverfront	810	810
H91	3005	Skipping Stones	765	276
H91	3001	Star Gazing	785	785
H91	3004	Winter Forest	083	083
GLIMMER Semi-Opaque (Price Group 6)				
HS3	854	Copper Blaze	960	083
HS3	668	Copper Radiance	954	083
HS3	911	Copper Sage	958	785
HS3	989	Gold Brilliance	882	882
HS3	468	Gold Leaf	630	862
HS3	955	Gold Shimmer	862	862
HS3	682	Silver Birch	862	810
HS3	829	Silver River	765	661
HS3	686	Silver Truffle	810	810
LINEN Semi-Opaque (Price Group 6)				
H27	454	Dried Sage	621	862
H27	451	French Vanilla	882	882
H27	452	Harvest	630	841
H27	453	Khaki	630	841
MARCELLA Semi-Opaque (Price Group 4)				
H45	807	Almond Glaze	630	862
H45	808	Brown Sugar	083	083
H45	804	Crepe Souffle	882	882
H45	805	Fresh Toffee	952	082
H45	822	Grey Linen	765	276
H45	803	Jasmine Wisp	674	862
H45	8701	Mocha Brownie	810	810
H45	802	Mountain Mist	862	862
H45	821	Pearly Beige	862	862
H45	8703	Serious Gray	405	276
H45	8700	Spanish Olive	621	862
H45	801	Sugar Cane	661	661
MELODIC Semi-Opaque (Price Group 6)				
HX6	1053	Ballet	862	862
HX6	1051	Bravado	661	661
HX6	1089	Charango	862	862
HX6	1018	Ginger	320	862
HX6	1465	Jade	135	785
HX6	1469	Jave	849	810
HX6	1084	Meseno	810	810
HX6	1016	Padoanna	450	661
HX6	1055	Timbre	810	810
MIRADA Semi-Opaque (Price Group 6)				
H92	3021	Bungalow Brown	361	810
H92	3022	Lazy Day	785	785
H92	3025	Marina Gray	765	276
H92	3024	North Star	661	661
H92	3023	Relaxing Rain	405	276
H92	3026	Sonora Dunes	862	862

****IMPORTANT NOTE:****

3/4" Serene FR Semi-opaque (H62) and 3/4" Serene FR Blackout (H60) fabrics do not meet the NFPA 701 flammability requirements when used in a Vertical Application.

CODE KEY: HEADRAIL

STD = Standard Cordlock (Cordless Lift, Cordless Lift & Lock, Continuous Cord Loop, TriLight, Simplicity and RemoteLift shades with coordinated rail.)
VA = Vertical Application shades

FABRIC			HARDWARE	
Code	Color #	Color Name	STD	VA
OPULENCE Semi-Opaque (Price Group 6)				
H28	651	Accent Grey	765	276
H28	606	Biscuit	882	882
H28	636	Chocolate Bliss	083	083
H28	608	Cocoa	810	810
H28	622	Country Road	621	862
H28	603	Doe	862	862
H28	604	Fallen Snow	882	882
H28	635	Fudge Truffle	954	082
H28	621	Gentle White	661	661
H28	653	Golden Sage	630	841
H28	652	Grey Stone	765	276
H28	5021	Nantucket Gray	405	276
H28	5022	Newport Gray	405	276
H28	631	Pristine Beach	954	082
H28	5020	Regal Taupe	810	810
H28	634	Renaissance Clay	956	862
H28	615	Sagebrush	621	785
H28	629	Soft Linen	862	862
H28	601	Soft White	661	661
H28	617	Sunbeam	862	862
H28	607	Taupe	127	862
H28	632	Tranquil Tea	954	082
H28	637	Warm Cocoa	361	810
H28	618	White Azalea	661	661
PEACEFUL Semi-Opaque (Price Group 12)				
H96	2222	Barely Beige	862	862
H96	2228	Blue Skies	450	661
H96	2225	Canyon Walls	954	082
H96	2229	Casting Pond	450	661
H96	2224	Country Crossing	882	882
H96	2223	Desert Dunes	862	862
H96	2221	Drop of Sun	785	785
H96	2226	Fair Oaks	810	810
H96	2227	Fallen Leaves	862	862
H96	2230	Mountain Meadow	135	785
H96	2220	Zephyr	661	661
RADIANCE Semi-Opaque (Price Group 1)				
HF6	445	Aged Brass	621	785
HF6	444	Aged Leather	083	083
HF6	439	Golden	630	862
HF6	458	Pewter	765	661
HF6	416	Primrose	630	862
HF6	448	Rosemary	958	785
HF6	454	Twilight	450	661
HF6	400	Vintage Lace	785	785

FABRIC			HARDWARE	
Code	Color #	Color Name	STD	VA
SERENE FR Semi-Opaque (Price Group 6)				
H62	263	Blanched Almond	862	862
H62	261	Lemon Chiffon	785	785
H62	262	Pearl Shell	882	882
H62	260	Snow White	661	661

FABRIC			HARDWARE	
Code	Color #	Color Name	STD	VA
TIFFANY Sheer (Price Group 11)				
H25	102	Almond Veil	882	882
H25	103	Soft Sand	862	862
H25	100	White Veil	661	661
TRANQUILITY Semi-Sheer (Price Group 11)				
H24	273	Desert Sand	882	N/A
H24	272	Pale Rose	320	
H24	274	Soft Buttercup	674	
H24	271	White Linen	661	

FABRIC AND RAIL COLOR CHART

3/4" Single Cell Fabrics (Blackout)

FABRIC			HARDWARE	
Code	Color #	Color Name	STD	VA
MARCELLA Blackout (Price Group 9)				
H46	807	Almond Glaze	630	862
H46	808	Brown Sugar	954	083
H46	804	Crepe Souffle	882	882
H46	822	Grey Linen	765	276
H46	803	Jasmine Wisp	674	862
H46	802	Mountain Mist	862	862
H46	821	Pearly Beige	862	862
H46	801	Sugar Cane	661	661
OPULENCE Blackout (Price Group 11)				
H29	606	Biscuit	882	882
H29	628	Cloud Puff	661	661
H29	652	Deep Slate	450	661
H29	603	Doe	862	862
H29	690	Grey Stone	765	276
H29	5021	Nantucket Gray	405	276
H29	601	Soft White	785	785
H29	617	Sunbeam	862	862
H29	607	Taupe	127	862
H29	632	Tranquil Tea	954	082
H29	637	Warm Cocoa	849	810
H29	618	White Azalea	885	661

FABRIC			HARDWARE	
Code	Color #	Color Name	STD	VA
RADIANCE Blackout (Price Group 7)				
HF7	445	Aged Brass	621	785
HF7	444	Aged Leather	083	083
HF7	439	Golden	630	862
HF7	458	Pewter	765	661
HF7	416	Primrose	630	862
HF7	448	Rosemary	958	785
HF7	454	Twilight	450	661
HF7	400	Vintage Lace	785	785
SERENE FR Blackout (Price Group 11)				
H60	163	Blanched Almond	862	785
H60	160	Cool White	661	661
H60	161	Lemon Chiffon	785	785
H60	162	Pearl Shell	882	882

****IMPORTANT NOTE:****

3/4" Serene FR Semi-opaque (H62) and 3/4" Serene FR Blackout (H60) fabrics do not meet the NFPA 701 flammability requirements when used in a Vertical Application.

CODE KEY: HEADRAIL

STD = Standard Cordlock (Cordless Lift, Cordless Lift & Lock, Continuous Cord Loop, TriLight, Simplicity and RemoteLift shades with coordinated rail.)

VA = Vertical Application shades

FABRIC AND RAIL COLOR CHART

1/2" Double Cell & 3/8" Triple Cell Fabrics

FABRIC			HARDWARE	
Code	Color #	Color Name	STD	VA
MARCELLA Double Cell (Price Group 5)				
H47	807	Almond Glaze	630	N/A
H47	808	Brown Sugar	083	
H47	804	Crepe Souffle	882	
H47	822	Grey Linen	765	
H47	803	Jasmine Wisp	674	
H47	802	Mountain Mist	862	
H47	821	Pearly Beige	862	
H47	801	Sugar Cane	661	

FABRIC			HARDWARE	
Code	Color #	Color Name	STD	VA
OPULENCE Double Cell (Price Group 8)				
H39	651	Accent Grey	765	N/A
H39	606	Biscuit	882	
H39	636	Chocolate Bliss	083	
H39	608	Cocoa	810	
H39	603	Doe	862	
H39	604	Fallen Snow	882	
H39	635	Fudge Truffle	954	
H39	652	Grey Stone	765	
H39	615	Sagebrush	621	
H39	629	Soft Linen	862	
H39	601	Soft White	661	
H39	617	Sunbeam	862	
H39	632	Tranquil Tea	954	
H39	637	Warm Cocoa	361	

FABRIC			HARDWARE	
Code	Color #	Color Name	STD	VA
TRICELLA Triple Cell (Price Group 11)				
H58	100	Cotton Bloom	661	N/A
H58	108	Dreamy Sunset	952	
H58	110	Foxy Gray	765	
H58	106	Malibu Coast	630	
H58	104	Sand Castle	862	
H58	102	Sun Glow	862	

CODE KEY: HEADRAIL
STD = Standard Cordlock (Cordless Lift, Cordless Lift & Lock, Continuous Cord Loop, TriLight, Simplicity and RemoteLift shades with coordinated rail.)
VA = Vertical Application shades

FABRIC AND RAIL COLOR CHART

2" Hybrid Pleat (Semi-Opaque & Blackout)

FABRIC			HARDWARE	
Code	Color #	Color Name	OPTION	VA
2" HYBRID PLEAT - Semi-Opaque (Price Group 13)				
<i>Coordinates with Opulence colors of the same name</i>				
HPF	851	Accent Gray	765	276
HPF	808	Cocoa	810	810
HPF	803	Doe	862	862
HPF	852	Grey Stone	765	276
HPF	801	Soft White	661	661
HPF	817	Sunbeam	862	862

FABRIC			HARDWARE	
Code	Color #	Color Name	OPTION	VA
2" HYBRID PLEAT - Blackout (Price Group 14)				
<i>Coordinates with Opulence colors of the same name</i>				
HPR	828	Cloud Puff	661	661
HPR	812	Deep Slate	450	661
HPR	803	Doe	862	862
HPR	807	Taupe	127	862
HPR	832	Tranquil Tea	954	082
HPR	837	Warm Cocoa	361	810

CODE KEY: HEADRAIL	
OPTION	= Cordless Lift, Cordless Lift & Lock, Continuous Cord Loop, TriLight, Simplicity and RemoteLift shades with coordinated rail.
VA	= Vertical Application shades

GROUP 1 (Standard Rectangular)

• 3/4" Radiance (HF6)

WIDTH TO:	24"	30"	36"	42"	48"	54"	60"	66"	72"	84"	96"	108"	120"
HEIGHT TO:													
36"	\$129	146	163	185	204	221	240	257	277	317	357	399	439
42"	138	156	179	204	221	241	263	285	304	350	394	440	486
48"	148	171	192	216	240	263	286	310	333	382	434	480	533
54"	155	181	207	234	257	283	309	335	361	415	470	525	579
60"	166	190	221	247	275	303	330	360	390	448	505	567	623
66"	177	204	236	264	294	325	355	386	416	480	544	606	673
72"	185	214	247	280	315	346	378	412	444	513	581	649	720
78"	192	225	261	293	332	365	402	438	474	543	618	691	766
84"	201	237	273	310	348	382	419	457	495	571	650	725	808
90"	209	246	286	325	365	405	443	485	525	606	688	769	853
96"	216	256	300	340	382	420	466	505	546	632	721	808	895
108"	237	278	324	369	417	459	506	556	603	696	788	883	981
120"	251	301	354	402	454	502	554	605	653	754	861	964	1059

NOTE: SEE "PRODUCT CONFIGURATION SPECIFICATION" CHARTS ON PAGES 24-31 FOR ANY FABRIC AND SIZE RESTRICTIONS.

OPTIONS: NO EXTRA CHARGE

- Color-Coordinated Rails
- Cordless Lift & Lock
- Cordless Lift & Lock Two-On-One Headrail – price as 2 separate shades and add together
- Cordless Lift & Lock Three-On-One Headrail – price as 3 separate shades and add together
- Control Positions – left or right side of the shade (Exception: for Two-on-One Headrail, cords must be on opposite ends of the headrail)
- 3" Extension Bracket and 1/2" Spacer Blocks – maximum of 3 spacer blocks per bracket
- Hold Down Brackets
- Cut-Outs – up to 3" wide (see page 27 for details)
- Special Cord Lengths – standard cord is approximately 3/4 the height of the shade unless otherwise specified

OPTIONS: EXTRA CHARGE

- See "SIZE STANDARDS" for complete option details.
- Fabric-Wrapped Rail Optionadd \$15
 - Top-Down & Top-Down/Bottom-Upadd \$67
 - Continuous Cord Loop*add \$49
 - Top-Down/Bottom-Up*add \$115
 - Cordless Lift System*add \$72
 - Two-On-One Headrail* price as 2 separate shades and add \$143 (not available in Top-Down/Bottom-Up or Two-Fabric Combination)
 - Three-On-One Headrail* price as 3 separate shades and add \$214 (not available in Top-Down/Bottom-Up or Two-Fabric Combination)
 - Top-Down/Bottom-Up*add \$138
 - Cordless Lift & Lock
 - Top-Down/Bottom-Up*add \$67
 - Premium Headrail Upgrade*add \$15 (Premium Headrail not available with Top-Down/Bottom-Up or TriLight)
 - Cordless Extension Pole #40-0036-000\$39
 - Rectangular Shade and Arch – price as 2 separate shades; One Arch and One Rectangular
 - TriLight Shades – see pages 32-37
 - Angle Cutadd \$129

*NOTE: FABRIC-WRAPPED RAILS ARE OPTIONAL FOR A SURCHARGE ON CONTINUOUS CORD LOOP, CORDLESS LIFT, CORDLESS LIFT & LOCK, AND MOTORIZED SHADES. COLOR-COORDINATED RAILS ARE AVAILABLE AT NO ADDITIONAL CHARGE.

See page 23 for motorization surcharges

GROUP 2 (Standard Rectangular)

• 3/8" Marcella (H44)

WIDTH TO:	24"	30"	36"	42"	48"	54"	60"	66"	72"	84"	96"	108"	120"	132"	144"	174"
HEIGHT TO:																
36"	\$129	146	163	185	204	221	240	257	277	317	357	399	439	480	517	618
42"	138	156	179	204	221	241	263	285	304	350	394	440	486	532	574	688
48"	148	171	192	216	240	263	286	310	333	382	434	480	533	581	630	754
54"	155	181	207	234	257	283	309	335	361	415	470	525	579	636	689	822
60"	166	190	221	247	275	303	330	360	390	448	505	567	623	685	741	891
66"	177	204	236	264	294	325	355	386	416	480	544	606	673	736	800	958
72"	185	214	247	280	315	346	378	412	444	513	581	649	720	785	855	1026
78"	192	225	261	293	332	365	402	438	474	543	618	691	766	838	911	
84"	201	237	273	310	348	382	419	457	495	571	650	725	808	883	962	
90"	209	246	286	325	365	405	443	485	525	606	688	769	853	935	1017	
96"	216	256	300	340	382	420	466	505	546	632	721	808	895	980		
108"	237	278	324	369	417	459	506	556	603	696	788	883	981			
120"	251	301	354	402	454	502	554	605	653	754	861	964				
132"	269	322	376	432	488	541	598	651	705	817	932					
144"	285	342	404	459	524	580	639	698	755	877						

NOTE: SEE "PRODUCT CONFIGURATION SPECIFICATION" CHARTS ON PAGES 24-31 FOR ANY FABRIC AND SIZE RESTRICTIONS. CONTINUOUS CORD LOOP SYSTEM "REQUIRED" FOR SIZES WITHIN THE THICK BLACK LINE.

OPTIONS: NO EXTRA CHARGE

- **Color-Coordinated Rails**
- **Control Positions** – left or right side of the shade (Exception: for Two-on-One Headrail, cords must be on opposite ends of the headrail)
- **3" Extension Bracket and 1/2" Spacer Blocks** – maximum of 3 spacer blocks per bracket
- **Hold Down Brackets**
- **Cut-Outs** – up to 3" wide (see page 27 for details)
- **Special Cord Lengths** – standard cord is approximately 3/4 the height of the shade unless otherwise specified

OPTIONS: EXTRA CHARGE

- See "SIZE STANDARDS" for complete option details.
- **Fabric-Wrapped Rail Option**add \$15
 - **Top-Down & Top-Down/Bottom-Up**add \$67
 - **Continuous Cord Loop***add \$49
 - **Top-Down/Bottom-Up***add \$115
 - **Cordless Lift System***add \$72
 - **Two-On-One Headrail*** price as 2 separate shades and add \$143 (not available in Top-Down/Bottom-Up or Two-Fabric Combination)
 - **Three-On-One Headrail*** price as 3 separate shades and add \$214 (not available in Top-Down/Bottom-Up or Two-Fabric Combination)
 - **Top-Down/Bottom-Up***add \$138
 - **Cordless Extension Pole #40-0036-000**\$39
 - **Rectangular Shade and Arch** – price as 2 separate shades; One Arch and One Rectangular
 - **Angle Cut**add \$129

*NOTE: FABRIC-WRAPPED RAILS ARE OPTIONAL FOR A SURCHARGE ON CONTINUOUS CORD LOOP, CORDLESS LIFT, CORDLESS LIFT & LOCK, AND MOTORIZED SHADES. COLOR-COORDINATED RAILS ARE AVAILABLE AT NO ADDITIONAL CHARGE.

See page 23 for motorization surcharges

GROUP 3 (Standard Rectangular)

• 3/8" Opulence (H40)

WIDTH TO:	24"	30"	36"	42"	48"	54"	60"	66"	72"	84"	96"	108"	120"	132"	144"	174"
HEIGHT TO:																
36"	\$136	154	174	195	216	234	254	273	293	335	378	423	465	510	549	657
42"	145	166	190	215	234	256	280	301	323	370	417	466	515	563	608	730
48"	156	179	204	228	254	280	302	329	354	405	458	511	565	619	670	801
54"	165	190	220	247	273	300	327	356	384	441	497	556	616	674	731	872
60"	175	201	234	261	291	322	351	381	412	475	536	602	663	729	787	946
66"	187	216	249	282	314	346	376	409	441	510	580	643	714	782	849	1019
72"	195	225	261	298	333	366	402	438	472	545	619	690	764	837	908	1089
78"	204	238	277	312	353	387	427	464	503	579	657	735	813	891	967	
84"	213	251	290	329	369	405	446	487	526	605	691	771	857	938	1022	
90"	222	261	303	346	387	429	471	514	557	642	730	816	904	994	1081	
96"	228	272	317	362	405	447	493	536	583	673	766	856	949	1040		
108"	251	294	343	393	442	489	540	588	638	738	839	938	1042			
120"	265	318	373	427	482	532	587	641	694	801	912	1024				
132"	284	340	399	457	519	576	634	692	748	869	989					
144"	301	364	428	489	554	618	677	741	805	933						

NOTE: SEE "PRODUCT CONFIGURATION SPECIFICATION" CHARTS ON PAGES 24-31 FOR ANY FABRIC AND SIZE RESTRICTIONS. CONTINUOUS CORD LOOP SYSTEM "REQUIRED" FOR SIZES WITHIN THE THICK BLACK LINE.

OPTIONS: NO EXTRA CHARGE	
<ul style="list-style-type: none"> • Color-Coordinated Rails • Control Positions – left or right side of the shade (Exception: for Two-on-One Headrail, cords must be on opposite ends of the headrail) • 3" Extension Bracket and 1/2" Spacer Blocks – maximum of 3 spacer blocks per bracket 	<ul style="list-style-type: none"> • Hold Down Brackets • Cut-Outs – up to 3" wide (see page 27 for details) • Special Cord Lengths – standard cord is approximately 3/4 the height of the shade unless otherwise specified

OPTIONS: EXTRA CHARGE	
<p>See "SIZE STANDARDS" for complete option details.</p> <ul style="list-style-type: none"> • Fabric-Wrapped Rail Optionadd \$15 • Top-Down & Top-Down/Bottom-Upadd \$67 • Continuous Cord Loop*add \$49 <ul style="list-style-type: none"> – Top-Down/Bottom-Up*add \$115 • Cordless Lift System*add \$72 <ul style="list-style-type: none"> – Two-On-One Headrail* price as 2 separate shades and add \$143 (not available in Top-Down/Bottom-Up or Two-Fabric Combination) – Three-On-One Headrail* price as 3 separate shades and add \$214 (not available in Top-Down/Bottom-Up or Two-Fabric Combination) – Top-Down/Bottom-Up*add \$138 	<ul style="list-style-type: none"> • Cordless Extension Pole #40-0036-000\$39 • Rectangular Shade and Arch – price as 2 separate shades; One Arch and One Rectangular • Angle Cutadd \$129

*NOTE: FABRIC-WRAPPED RAILS ARE OPTIONAL FOR A SURCHARGE ON CONTINUOUS CORD LOOP, CORDLESS LIFT, CORDLESS LIFT & LOCK, AND MOTORIZED SHADES. COLOR-COORDINATED RAILS ARE AVAILABLE AT NO ADDITIONAL CHARGE.

See page 23 for motorization surcharges

GROUP 4 (Standard Rectangular)

*3/4" Marcella (H45)

WIDTH TO:	24"	30"	36"	42"	48"	54"	60"	66"	72"	84"	96"	108"	120"	132"	144"	174"
HEIGHT TO:																
36"	\$136	152	174	192	213	229	247	270	287	327	370	410	450	490	530	632
42"	146	166	187	213	234	256	277	301	323	368	413	458	506	554	600	710
48"	153	178	204	228	251	273	300	323	350	399	449	499	551	604	651	778
54"	160	186	214	241	270	293	322	347	374	426	485	538	599	649	705	842
60"	175	201	232	259	288	318	346	377	407	467	527	587	650	708	770	917
66"	185	215	246	278	311	345	376	408	441	505	573	638	705	771	837	1001
72"	197	223	259	293	329	361	396	432	467	535	607	680	747	818	886	1064
78"	207	241	279	317	356	390	427	467	505	580	659	736	815	893	967	1159
84"	216	253	293	334	376	413	454	494	535	615	698	780	866	944	1027	1232
90"	225	268	310	354	399	439	480	525	568	654	740	829	917	1005	1092	1310
96"	236	278	323	369	416	457	504	550	598	689	783	873	967	1060	1151	1329
108"	253	301	354	402	454	502	550	604	653	752	854	957	1060	1159	1262	1515
120"	278	329	387	443	501	556	610	666	722	832	946	1060	1174	1284	1399	1679
132"	300	360	419	483	545	606	666	729	788	914	1039	1164	1292	1410	1539	
144"	316	382	449	517	581	647	710	779	847	980	1112	1245	1381	1513	1643	
156"	335	409	485	554	629	699										
168"	358	436	517	592	673											
174"	376	459	546	630	710											

NOTE: SEE "PRODUCT CONFIGURATION SPECIFICATION" CHARTS ON PAGES 24-31 FOR ANY FABRIC AND SIZE RESTRICTIONS. CONTINUOUS CORD LOOP SYSTEM "REQUIRED" FOR SIZES WITHIN THE THICK BLACK LINE.

OPTIONS: NO EXTRA CHARGE	
<ul style="list-style-type: none"> • Color-Coordinated Rails • Cordless Lift & Lock • Cordless Lift & Lock Two-On-One Headrail – price as 2 separate shades and add together • Cordless Lift & Lock Three-On-One Headrail – price as 3 separate shades and add together • Control Positions – left or right side of the shade (Exception: for Two-on-One Headrail, cords must be on opposite ends of the headrail) 	<ul style="list-style-type: none"> • 3" Extension Bracket and 1/2" Spacer Blocks – maximum of 3 spacer blocks per bracket • Hold Down Brackets • Cut-Outs – up to 3" wide (see page 27 for details) • Special Cord Lengths – standard cord is approximately 3/4 the height of the shade unless otherwise specified

OPTIONS: EXTRA CHARGE	
<p>See "SIZE STANDARDS" for complete option details.</p> <ul style="list-style-type: none"> • Fabric-Wrapped Rail Optionadd \$15 • Top-Down & Top-Down/Bottom-Upadd \$67 • Continuous Cord Loop*add \$49 <ul style="list-style-type: none"> – Top-Down/Bottom-Up*add \$115 • Cordless Lift System*add \$72 <ul style="list-style-type: none"> – Two-On-One Headrail* price as 2 separate shades and add \$143 (not available in Top-Down/Bottom-Up or Two-Fabric Combination) – Three-On-One Headrail* price as 3 separate shades and add \$214 (not available in Top-Down/Bottom-Up or Two-Fabric Combination) – Top-Down/Bottom-Up*add \$138 	<ul style="list-style-type: none"> • Cordless Lift & Lock <ul style="list-style-type: none"> – Top-Down/Bottom-Up*add \$67 – Premium Headrail Upgrade*add \$15 (Premium Headrail not available with Top-Down/Bottom-Up or TriLight) • Cordless Extension Pole #40-0036-000\$39 • Rectangular Shade and Arch – price as 2 separate shades; One Arch and One Rectangular • TriLight Shades – see pages 32-37 • Angle Cutadd \$129

*NOTE: FABRIC-WRAPPED RAILS ARE OPTIONAL FOR A SURCHARGE ON CONTINUOUS CORD LOOP, CORDLESS LIFT, CORDLESS LIFT & LOCK, AND MOTORIZED SHADES. COLOR-COORDINATED RAILS ARE AVAILABLE AT NO ADDITIONAL CHARGE.

See page 23 for motorization surcharges

GROUP 5 (Standard Rectangular)

• 1/2" MARCELLA (H47)

WIDTH TO:	24"	30"	36"	42"	48"	54"	60"	66"	72"	84"	96"	108"	120"	132"	144"	174"
HEIGHT TO:																
36"	\$143	159	182	205	225	243	263	285	304	348	393	435	479	520	561	670
42"	154	176	198	225	246	271	292	318	341	388	440	487	537	585	637	753
48"	161	189	215	241	268	290	317	342	370	420	477	530	584	639	689	826
54"	171	197	228	256	285	312	340	368	396	452	514	572	632	686	746	894
60"	185	213	245	275	306	337	366	400	432	494	559	622	688	749	815	974
66"	195	229	261	293	329	363	399	434	467	536	607	675	746	816	889	1061
72"	207	238	275	312	350	384	419	456	494	567	645	720	793	868	939	1128
78"	218	256	295	335	377	413	454	494	536	615	699	779	864	946	1026	1229
84"	230	270	312	355	399	440	482	525	567	652	740	829	917	1001	1090	1307
90"	239	282	327	374	420	464	509	557	603	694	784	876	974	1066	1158	1390
96"	248	293	342	392	442	486	535	583	631	730	830	926	1026	1122	1219	1407
108"	270	318	374	425	482	533	583	639	692	798	904	1013	1122	1229	1339	1606
120"	293	350	410	470	530	587	647	706	767	883	1002	1122	1245	1363	1482	1783
132"	317	380	446	513	579	643	707	772	837	969	1103	1234	1368	1496	1630	
144"	334	405	477	545	616	685	753	827	899	1037	1177	1321	1464	1605	1743	

NOTE: SEE "PRODUCT CONFIGURATION SPECIFICATION" CHARTS ON PAGES 24-31 FOR ANY FABRIC AND SIZE RESTRICTIONS. CONTINUOUS CORD LOOP SYSTEM "REQUIRED" FOR SIZES WITHIN THE THICK BLACK LINE.

OPTIONS: NO EXTRA CHARGE

- Color-Coordinated Rails
- Cordless Lift & Lock
- Cordless Lift & Lock Two-On-One Headrail – price as 2 separate shades and add together
- Cordless Lift & Lock Three-On-One Headrail – price as 3 separate shades and add together
- Control Positions – left or right side of the shade (Exception: for Two-on-One Headrail, cords must be on opposite ends of the headrail)
- 3" Extension Bracket and 1/2" Spacer Blocks – maximum of 3 spacer blocks per bracket
- Hold Down Brackets
- Cut-Outs – up to 3" wide (see page 27 for details)
- Special Cord Lengths – standard cord is approximately 3/4 the height of the shade unless otherwise specified

OPTIONS: EXTRA CHARGE

- See "SIZE STANDARDS" for complete option details.
- Fabric-Wrapped Rail Optionadd \$15
 - Top-Down & Top-Down/Bottom-Upadd \$67
 - Continuous Cord Loop*add \$49
 - Top-Down/Bottom-Up*add \$115
 - Cordless Lift System*add \$72
 - Two-On-One Headrail* price as 2 separate shades and add \$143 (not available in Top-Down/Bottom-Up or Two-Fabric Combination)
 - Three-On-One Headrail* price as 3 separate shades and add \$214 (not available in Top-Down/Bottom-Up or Two-Fabric Combination)
 - Top-Down/Bottom-Up*add \$138
 - Cordless Lift & Lock
 - Top-Down/Bottom-Up*add \$67
 - Premium Headrail Upgrade*add \$15 (Premium Headrail not available with Top-Down/Bottom-Up or TriLight)
 - Cordless Extension Pole #40-0036-000\$39
 - Rectangular Shade and Arch – price as 2 separate shades; One Arch and One Rectangular
 - TriLight Shades – see pages 32-37
 - Angle Cutadd \$129

*NOTE: FABRIC-WRAPPED RAILS ARE OPTIONAL FOR A SURCHARGE ON CONTINUOUS CORD LOOP, CORDLESS LIFT, CORDLESS LIFT & LOCK, AND MOTORIZED SHADES. COLOR-COORDINATED RAILS ARE AVAILABLE AT NO ADDITIONAL CHARGE.

See page 23 for motorization surcharges

- 3/4" CARDIFF (H91)
- 3/4" MELODIC (HX6)
- 3/4" SERENE FR (H62)
- 3/4" GLIMMER (HS3)
- 3/4" MIRADA (H92)
- 3/4" LINEN (H27)
- 3/4" OPULENCE (H28)

GROUP 6 (Standard Rectangular)

WIDTH TO:	24"	30"	36"	42"	48"	54"	60"	66"	72"	84"	96"	108"	120"	132"	144"	174"
HEIGHT TO:																
36"	\$156	177	202	225	248	269	291	316	337	385	436	481	530	576	621	744
42"	171	193	218	248	273	300	324	353	378	432	486	540	597	650	705	836
48"	179	208	238	268	294	321	351	379	410	468	527	585	649	708	766	915
54"	189	217	249	283	316	346	377	408	440	502	569	632	702	763	829	990
60"	205	236	272	303	339	372	407	443	478	546	619	690	764	832	903	1078
66"	216	251	288	325	365	404	441	479	517	593	673	748	829	904	985	1175
72"	230	262	303	346	386	424	466	505	546	628	713	797	878	962	1041	1248
78"	243	283	327	371	417	457	503	546	593	683	776	864	957	1048	1137	1363
84"	252	298	346	393	441	486	534	580	628	723	819	917	1018	1110	1206	1449
90"	263	312	363	413	467	514	565	616	666	770	870	974	1078	1181	1283	1541
96"	276	325	379	435	488	538	592	647	700	809	919	1027	1137	1244	1353	1560
108"	298	353	413	473	534	589	647	708	769	885	1003	1125	1244	1363	1486	1783
120"	325	386	454	520	587	651	715	782	848	979	1111	1244	1380	1511	1643	1974
132"	351	420	494	568	644	710	783	856	928	1074	1222	1368	1518	1660	1807	
144"	370	448	527	606	684	760	836	916	995	1151	1307	1464	1625	1781	1933	
156"	394	480	569	650	740	822										
168"	419	511	607	697	790											
174"	442	541	645	741	836											

NOTE: SEE "PRODUCT CONFIGURATION SPECIFICATION" CHARTS ON PAGES 24-31 FOR ANY FABRIC AND SIZE RESTRICTIONS. CONTINUOUS CORD LOOP SYSTEM "REQUIRED" FOR SIZES WITHIN THE THICK BLACK LINE.

OPTIONS: NO EXTRA CHARGE

- Color-Coordinated Rails
- Cordless Lift & Lock
- Cordless Lift & Lock Two-On-One Headrail – price as 2 separate shades and add together
- Cordless Lift & Lock Three-On-One Headrail – price as 3 separate shades and add together
- Control Positions – left or right side of the shade (Exception: for Two-on-One Headrail, cords must be on opposite ends of the headrail)
- 3" Extension Bracket and 1/2" Spacer Blocks – maximum of 3 spacer blocks per bracket
- Hold Down Brackets
- Cut-Outs – up to 3" wide (see page 27 for details)
- Special Cord Lengths – standard cord is approximately 3/4 the height of the shade unless otherwise specified

OPTIONS: EXTRA CHARGE

- See "SIZE STANDARDS" for complete option details.
- Fabric-Wrapped Rail Optionadd \$15
 - Top-Down & Top-Down/Bottom-Upadd \$67
 - Continuous Cord Loop*add \$49
 - Top-Down/Bottom-Up*add \$115
 - Cordless Lift System*add \$72
 - Two-On-One Headrail* price as 2 separate shades and add \$143 (not available in Top-Down/Bottom-Up or Two-Fabric Combination)
 - Three-On-One Headrail* price as 3 separate shades and add \$214 (not available in Top-Down/Bottom-Up or Two-Fabric Combination)
 - Top-Down/Bottom-Up*add \$138
 - Cordless Lift & Lock
 - Top-Down/Bottom-Up*add \$67
 - Premium Headrail Upgrade*add \$15 (Premium Headrail not available with Top-Down/Bottom-Up or TriLight)
 - Cordless Extension Pole #40-0036-000\$39
 - Rectangular Shade and Arch – price as 2 separate shades; One Arch and One Rectangular
 - TriLight Shades – see pages 32-37
 - Angle Cutadd \$129

*NOTE: FABRIC-WRAPPED RAILS ARE OPTIONAL FOR A SURCHARGE ON CONTINUOUS CORD LOOP, CORDLESS LIFT, CORDLESS LIFT & LOCK, AND MOTORIZED SHADES. COLOR-COORDINATED RAILS ARE AVAILABLE AT NO ADDITIONAL CHARGE.

See page 23 for motorization surcharges

GROUP 7 (Standard Rectangular)

• 3/4" RADIANCE BLACKOUT (HF7)

WIDTH TO:	24"	30"	36"	42"	48"	54"	60"	66"	72"	84"	96"	108"	120"
HEIGHT TO:													
36"	\$168	187	215	240	264	285	310	334	358	409	459	510	564
42"	181	206	232	264	290	318	345	372	402	456	517	573	631
48"	191	221	251	283	315	340	371	404	436	497	559	621	688
54"	201	231	268	301	334	366	401	434	466	533	604	670	744
60"	217	248	288	322	360	395	432	471	505	580	657	733	809
66"	230	269	308	346	387	427	467	506	546	629	713	795	877
72"	244	278	322	366	410	450	494	536	580	666	755	846	934
78"	257	301	348	394	443	486	534	580	629	724	823	916	1016
84"	270	317	366	416	467	517	567	616	666	768	870	974	1079
90"	279	332	386	440	495	544	599	654	707	815	923	1033	1144
96"	292	346	404	458	519	572	628	686	743	857	977	1090	1205
108"	317	372	440	501	567	624	686	751	814	939	1065	1193	1320
120"	346	410	482	551	622	690	760	830	900	1037	1177	1320	1464

NOTE: SEE "PRODUCT CONFIGURATION SPECIFICATION" CHARTS ON PAGES 24-31 FOR ANY FABRIC AND SIZE RESTRICTIONS.

OPTIONS: NO EXTRA CHARGE	
<ul style="list-style-type: none"> • Color-Coordinated Rails • Cordless Lift & Lock • Cordless Lift & Lock Two-On-One Headrail – price as 2 separate shades and add together • Cordless Lift & Lock Three-On-One Headrail – price as 3 separate shades and add together • Control Positions – left or right side of the shade (Exception: for Two-on-One Headrail, cords must be on opposite ends of the headrail) 	<ul style="list-style-type: none"> • 3" Extension Bracket and 1/2" Spacer Blocks – maximum of 3 spacer blocks per bracket • Hold Down Brackets • Cut-Outs – up to 3" wide (see page 27 for details) • Special Cord Lengths – standard cord is approximately 3/4 the height of the shade unless otherwise specified

OPTIONS: EXTRA CHARGE	
<p>See "SIZE STANDARDS" for complete option details.</p> <ul style="list-style-type: none"> • Fabric-Wrapped Rail Optionadd \$15 • Top-Down & Top-Down/Bottom-Upadd \$67 • Continuous Cord Loop*add \$49 <ul style="list-style-type: none"> – Top-Down/Bottom-Up*add \$115 • Cordless Lift System*add \$72 <ul style="list-style-type: none"> – Two-On-One Headrail* price as 2 separate shades and add \$143 (not available in Top-Down/Bottom-Up or Two-Fabric Combination) – Three-On-One Headrail* price as 3 separate shades and add \$214 (not available in Top-Down/Bottom-Up or Two-Fabric Combination) – Top-Down/Bottom-Up*add \$138 	<ul style="list-style-type: none"> • Cordless Lift & Lock – Top-Down/Bottom-Up*add \$67 – Premium Headrail Upgrade*add \$15 (Premium Headrail not available with Top-Down/Bottom-Up or TriLight) • Cordless Extension Pole #40-0036-000\$39 • Rectangular Shade and Arch – price as 2 separate shades; One Arch and One Rectangular • TriLight Shades – see pages 32-37 • Angle Cutadd \$129

*NOTE: FABRIC-WRAPPED RAILS ARE OPTIONAL FOR A SURCHARGE ON CONTINUOUS CORD LOOP, CORDLESS LIFT, CORDLESS LIFT & LOCK, AND MOTORIZED SHADES. COLOR-COORDINATED RAILS ARE AVAILABLE AT NO ADDITIONAL CHARGE.

See page 23 for motorization surcharges

GROUP 8 (Standard Rectangular)

• 1/2" OPULENCE (H39)

WIDTH TO:	24"	30"	36"	42"	48"	54"	60"	66"	72"	84"	96"	108"	120"	132"	144"	174"
HEIGHT TO:																
36"	\$168	187	215	240	264	285	310	334	358	409	459	510	564	613	659	787
42"	181	206	232	264	290	318	345	372	402	456	517	573	631	689	747	887
48"	191	221	251	283	315	340	371	404	436	497	559	621	688	751	810	971
54"	201	231	268	301	334	366	401	434	466	533	604	670	744	808	877	1050
60"	217	248	288	322	360	395	432	471	505	580	657	733	809	883	958	1144
66"	230	269	308	346	387	427	467	506	546	629	713	795	877	959	1043	1246
72"	244	278	322	366	410	450	494	536	580	666	755	846	934	1020	1105	1324
78"	257	301	348	394	443	486	534	580	629	724	823	916	1016	1111	1205	1445
84"	270	317	366	416	467	517	567	616	666	768	870	974	1079	1176	1279	1537
90"	279	332	386	440	495	544	599	654	707	815	923	1033	1144	1252	1362	1634
96"	292	346	404	458	519	572	628	686	743	857	977	1090	1205	1320	1433	1657
108"	317	372	440	501	567	624	686	751	814	939	1065	1193	1320	1445	1574	1888
120"	346	410	482	551	622	690	760	830	900	1037	1177	1320	1464	1602	1743	2094
132"	371	448	525	603	683	753	831	907	985	1138	1295	1451	1610	1759	1917	
144"	393	477	559	644	725	807	887	973	1057	1221	1386	1552	1722	1887	2051	

NOTE: SEE "PRODUCT CONFIGURATION SPECIFICATION" CHARTS ON PAGES 24-31 FOR ANY FABRIC AND SIZE RESTRICTIONS. CONTINUOUS CORD LOOP SYSTEM "REQUIRED" FOR SIZES WITHIN THE THICK BLACK LINE.

OPTIONS: NO EXTRA CHARGE

- Color-Coordinated Rails
- Cordless Lift & Lock
- Cordless Lift & Lock Two-On-One Headrail – price as 2 separate shades and add together
- Cordless Lift & Lock Three-On-One Headrail – price as 3 separate shades and add together
- Control Positions – left or right side of the shade (Exception: for Two-on-One Headrail, cords must be on opposite ends of the headrail)
- 3" Extension Bracket and 1/2" Spacer Blocks – maximum of 3 spacer blocks per bracket
- Hold Down Brackets
- Cut-Outs – up to 3" wide (see page 27 for details)
- Special Cord Lengths – standard cord is approximately 3/4 the height of the shade unless otherwise specified

OPTIONS: EXTRA CHARGE

- See "SIZE STANDARDS" for complete option details.
- Fabric-Wrapped Rail Optionadd \$15
 - Top-Down & Top-Down/Bottom-Upadd \$67
 - Continuous Cord Loop*add \$49
 - Top-Down/Bottom-Up*add \$115
 - Cordless Lift System*add \$72
 - Two-On-One Headrail* price as 2 separate shades and add \$143 (not available in Top-Down/Bottom-Up or Two-Fabric Combination)
 - Three-On-One Headrail* price as 3 separate shades and add \$214 (not available in Top-Down/Bottom-Up or Two-Fabric Combination)
 - Top-Down/Bottom-Up*add \$138
 - Cordless Lift & Lock
 - Top-Down/Bottom-Up*add \$67
 - Premium Headrail Upgrade*add \$15 (Premium Headrail not available with Top-Down/Bottom-Up or TriLight)
 - Cordless Extension Pole #40-0036-000\$39
 - Rectangular Shade and Arch – price as 2 separate shades; One Arch and One Rectangular
 - TriLight Shades – see pages 32-37
 - Angle Cutadd \$129

*NOTE: FABRIC-WRAPPED RAILS ARE OPTIONAL FOR A SURCHARGE ON CONTINUOUS CORD LOOP, CORDLESS LIFT, CORDLESS LIFT & LOCK, AND MOTORIZED SHADES. COLOR-COORDINATED RAILS ARE AVAILABLE AT NO ADDITIONAL CHARGE.

See page 23 for motorization surcharges

GROUP 9 (Standard Rectangular)

• 3/4" MARCELLA BLACKOUT (H46)

WIDTH TO:	24"	30"	36"	42"	48"	54"	60"	66"	72"	84"	96"	108"	120"	132"	144"	174"
HEIGHT TO:																
36"	\$173	192	217	241	268	291	316	340	365	416	473	525	579	630	682	817
42"	185	208	237	264	292	323	347	376	405	466	525	583	646	705	766	915
48"	201	229	262	293	324	357	387	420	454	521	590	659	732	797	866	1039
54"	214	243	279	317	353	386	419	457	494	569	645	721	797	871	947	1135
60"	234	259	300	340	376	415	450	494	535	615	698	779	863	947	1026	1235
66"	243	275	318	360	404	444	485	530	573	659	749	841	932	1017	1107	1331
72"	259	294	342	388	436	480	525	575	619	716	817	912	1012	1110	1205	1454
78"	272	310	360	410	459	510	558	611	659	764	869	973	1079	1181	1286	1551
84"	283	325	379	436	486	537	587	646	698	810	918	1031	1144	1255	1367	1650
90"	300	346	405	458	517	574	628	689	747	866	983	1105	1227	1344	1466	1768
96"	310	360	420	481	542	603	659	724	784	908	1037	1164	1293	1422	1547	1868
108"	334	392	459	528	598	662	725	797	864	1002	1143	1283	1427	1568	1710	2062
120"	360	425	499	573	655	720	793	870	943	1095	1247	1403	1560	1718	1892	2290
132"	388	459	543	624	725	785	868	950	1033	1199	1369	1540	1712	1884	2082	
144"	412	494	580	668	785	848	935	1024	1112	1292	1474	1660	1833	2022	2226	
156"	446	533	628	725	852	917										
168"	475	569	670	778	911											
174"	502	602	710	822	964											

NOTE: SEE "PRODUCT CONFIGURATION SPECIFICATION" CHARTS ON PAGES 24-31 FOR ANY FABRIC AND SIZE RESTRICTIONS. CONTINUOUS CORD LOOP SYSTEM "REQUIRED" FOR SIZES WITHIN THE THICK BLACK LINE.

OPTIONS: NO EXTRA CHARGE

- Color-Coordinated Rails
- Cordless Lift & Lock
- Cordless Lift & Lock Two-On-One Headrail – price as 2 separate shades and add together
- Cordless Lift & Lock Three-On-One Headrail – price as 3 separate shades and add together
- Control Positions – left or right side of the shade (Exception: for Two-on-One Headrail, cords must be on opposite ends of the headrail)
- 3" Extension Bracket and 1/2" Spacer Blocks – maximum of 3 spacer blocks per bracket
- Hold Down Brackets
- Cut-Outs – up to 3" wide (see page 27 for details)
- Special Cord Lengths – standard cord is approximately 3/4 the height of the shade unless otherwise specified

OPTIONS: EXTRA CHARGE

- See "SIZE STANDARDS" for complete option details.
- Fabric-Wrapped Rail Optionadd \$15
 - Top-Down & Top-Down/Bottom-Upadd \$67
 - Continuous Cord Loop*add \$49
 - Top-Down/Bottom-Up*add \$115
 - Cordless Lift System*add \$72
 - Two-On-One Headrail* price as 2 separate shades and add \$143 (not available in Top-Down/Bottom-Up or Two-Fabric Combination)
 - Three-On-One Headrail* price as 3 separate shades and add \$214 (not available in Top-Down/Bottom-Up or Two-Fabric Combination)
 - Top-Down/Bottom-Up*add \$138
 - Cordless Lift & Lock
 - Top-Down/Bottom-Up*add \$67
 - Premium Headrail Upgrade*add \$15 (Premium Headrail not available with Top-Down/Bottom-Up or TriLight)
 - Cordless Extension Pole #40-0036-000\$39
 - Rectangular Shade and Arch – price as 2 separate shades; One Arch and One Rectangular
 - TriLight Shades – see pages 32-37
 - Angle Cutadd \$129

*NOTE: FABRIC-WRAPPED RAILS ARE OPTIONAL FOR A SURCHARGE ON CONTINUOUS CORD LOOP, CORDLESS LIFT, CORDLESS LIFT & LOCK, AND MOTORIZED SHADES. COLOR-COORDINATED RAILS ARE AVAILABLE AT NO ADDITIONAL CHARGE.

See page 23 for motorization surcharges

GROUP 10 (Standard Rectangular)

• 3/8" OPULENCE BLACKOUT (H41)

WIDTH TO:	24"	30"	36"	42"	48"	54"	60"	66"	72"	84"	96"	108"	120"	132"	144"	174"
HEIGHT TO:																
36"	\$193	216	244	272	301	329	355	385	411	470	534	592	655	713	770	924
42"	208	234	267	300	331	363	392	424	457	524	592	660	728	797	864	1034
48"	226	259	296	332	365	402	436	475	513	589	668	746	826	901	979	1174
54"	240	273	315	357	396	435	474	518	557	642	727	815	901	986	1069	1283
60"	263	292	338	385	425	468	510	558	604	696	788	880	974	1069	1159	1396
66"	273	309	358	405	456	502	548	597	646	746	848	950	1052	1150	1252	1505
72"	292	333	387	438	490	543	592	649	700	811	924	1032	1145	1254	1364	1643
78"	307	349	405	463	520	576	629	689	746	862	982	1099	1221	1336	1454	1754
84"	319	368	428	490	549	606	663	728	788	915	1039	1164	1293	1418	1546	1863
90"	338	390	457	519	584	647	710	779	844	979	1112	1248	1386	1520	1658	2002
96"	349	405	475	544	614	680	746	818	887	1027	1172	1315	1461	1606	1750	2112
108"	378	441	520	596	674	748	821	901	977	1131	1292	1450	1612	1771	1933	2332
120"	404	480	563	646	751	814	896	985	1066	1237	1410	1587	1766	1940	2140	2588
132"	438	520	615	707	821	889	981	1074	1167	1355	1548	1738	1937	2130	2353	
144"	466	557	657	755	889	958	1058	1156	1256	1459	1668	1877	2074	2286	2518	
156"	503	600	710	819	961	1036										
168"	536	642	758	879	1029											
174"	566	678	802	928	1090											

NOTE: SEE "PRODUCT CONFIGURATION SPECIFICATION" CHARTS ON PAGES 24-31 FOR ANY FABRIC AND SIZE RESTRICTIONS. CONTINUOUS CORD LOOP SYSTEM "REQUIRED" FOR SIZES WITHIN THE THICK BLACK LINE.

OPTIONS: NO EXTRA CHARGE	
<ul style="list-style-type: none"> • Color-Coordinated Rails • Control Positions – left or right side of the shade (Exception: for Two-on-One Headrail, cords must be on opposite ends of the headrail) • 3" Extension Bracket and 1/2" Spacer Blocks – maximum of 3 spacer blocks per bracket 	<ul style="list-style-type: none"> • Hold Down Brackets • Cut-Outs – up to 3" wide (see page 27 for details) • Special Cord Lengths – standard cord is approximately 3/4 the height of the shade unless otherwise specified

OPTIONS: EXTRA CHARGE	
<p>See "SIZE STANDARDS" for complete option details.</p> <ul style="list-style-type: none"> • Fabric-Wrapped Rail Optionadd \$15 • Top-Down & Top-Down/Bottom-Upadd \$67 • Continuous Cord Loop*add \$49 – Top-Down/Bottom-Up*add \$115 	<ul style="list-style-type: none"> • Rectangular Shade and Arch – price as 2 separate shades; One Arch and One Rectangular • TriLight Shades – see pages 32-37 • Angle Cutadd \$129

*NOTE: FABRIC-WRAPPED RAILS ARE OPTIONAL FOR A SURCHARGE ON CONTINUOUS CORD LOOP, CORDLESS LIFT, CORDLESS LIFT & LOCK, AND MOTORIZED SHADES. COLOR-COORDINATED RAILS ARE AVAILABLE AT NO ADDITIONAL CHARGE.

See page 23 for motorization surcharges

GROUP 11

- 3/8" TRICELLA (H58)
- 3/4" TIFFANY (H25)
- 3/4" TRANQUILITY (H24)
- 3/4" OPULENCE BLACKOUT (H29)
- 3/4" SERENE FR BLACKOUT (H60)

WIDTH TO:	24"	30"	36"	42"	48"	54"	60"	66"	72"	84"	96"	108"	120"	132"	144"	174"
HEIGHT TO:																
36"	\$201	225	253	283	312	341	369	400	427	488	556	616	682	741	801	961
42"	216	244	277	311	345	378	408	441	475	544	616	686	756	829	899	1075
48"	236	269	308	346	380	418	454	495	534	613	694	776	860	936	1018	1221
54"	249	285	327	371	412	452	494	538	579	667	755	847	936	1025	1112	1334
60"	273	303	351	400	442	487	530	580	628	723	819	916	1013	1112	1205	1453
66"	285	322	372	421	474	521	569	621	673	776	883	988	1095	1196	1302	1565
72"	303	347	402	455	510	565	616	675	728	844	961	1073	1191	1305	1419	1708
78"	319	363	421	481	541	599	654	716	776	896	1021	1143	1270	1390	1512	1824
84"	332	382	446	510	571	630	690	756	819	951	1080	1211	1345	1474	1607	1938
90"	351	407	475	540	607	674	739	810	877	1018	1157	1299	1441	1581	1724	2082
96"	363	421	495	566	638	707	776	852	923	1068	1219	1368	1519	1671	1820	2197
108"	393	458	541	620	700	778	854	936	1016	1176	1344	1509	1676	1843	2010	2425
120"	420	499	585	673	780	846	932	1024	1108	1286	1466	1650	1837	2018	2226	2691
132"	455	541	639	736	854	925	1020	1117	1214	1409	1610	1808	2015	2215	2447	
144"	485	579	683	785	925	996	1100	1201	1307	1518	1735	1952	2157	2378	2619	
156"	524	624	739	853	998	1078										
168"	558	667	787	915	1071											
174"	589	706	834	965	1134											

NOTE: SEE "PRODUCT CONFIGURATION SPECIFICATION" CHARTS ON PAGES 24-31 FOR ANY FABRIC AND SIZE RESTRICTIONS. CONTINUOUS CORD LOOP SYSTEM "REQUIRED" FOR 3/4" SHEER, SEMI-SHEER AND TRIPLE CELL FABRIC SIZES WITHIN THE THICK BLACK LINE.

OPTIONS: NO EXTRA CHARGE	
<ul style="list-style-type: none"> • Color-Coordinated Rails • Cordless Lift & Lock (not available on 3/8" Tricella) • Cordless Lift & Lock Two-On-One Headrail – price as 2 separate shades and add together (not available on 3/8" Tricella) • Cordless Lift & Lock Three-On-One Headrail – price as 3 separate shades and add together (not available on 3/8" Tricella) • Control Positions – left or right side of the shade (Exception: for Two-on-One Headrail, cords must be on opposite ends of the headrail) 	<ul style="list-style-type: none"> • 3" Extension Bracket and 1/2" Spacer Blocks – maximum of 3 spacer blocks per bracket • Hold Down Brackets • Cut-Outs – up to 3" wide (see page 27 for details) • Special Cord Lengths – standard cord is approximately 3/4 the height of the shade unless otherwise specified

OPTIONS: EXTRA CHARGE	
See "SIZE STANDARDS" for complete option details.	
<ul style="list-style-type: none"> • Fabric-Wrapped Rail Optionadd \$15 • Top-Down & Top-Down/Bottom-Upadd \$67 • Continuous Cord Loop*add \$49 <ul style="list-style-type: none"> – Top-Down/Bottom-Up*add \$115 • Cordless Lift System*add \$72 <ul style="list-style-type: none"> – Two-On-One Headrail* price as 2 separate shades and add \$143 (not available in Top-Down/Bottom-Up or Two-Fabric Combination) – Three-On-One Headrail* price as 3 separate shades and add \$214 (not available in Top-Down/Bottom-Up or Two-Fabric Combination) – Top-Down/Bottom-Up*add \$138 	<ul style="list-style-type: none"> • Cordless Lift & Lock <ul style="list-style-type: none"> – Top-Down/Bottom-Up*add \$67 – Premium Headrail Upgrade*add \$15 (Premium Headrail not available with Top-Down/Bottom-Up or TriLight) • Cordless Extension Pole #40-0036-000\$39 • Rectangular Shade and Arch – price as 2 separate shades; One Arch and One Rectangular • TriLight Shades – see pages 32-37 • Angle Cutadd \$129

*NOTE: FABRIC-WRAPPED RAILS ARE OPTIONAL FOR A SURCHARGE ON CONTINUOUS CORD LOOP, CORDLESS LIFT, CORDLESS LIFT & LOCK, AND MOTORIZED SHADES. COLOR-COORDINATED RAILS ARE AVAILABLE AT NO ADDITIONAL CHARGE.

See page 23 for motorization surcharges

GROUP 12 (Standard Rectangular)

• 3/4" PEACEFUL (H96)

WIDTH TO:	24"	30"	36"	42"	48"	54"	60"	66"	72"	84"	96"	108"	120"	132"	144"	174"
HEIGHT TO:																
36"	\$240	270	302	338	373	408	441	478	511	583	663	737	816	887	958	1149
42"	259	291	332	372	412	451	487	527	569	651	737	821	904	992	1074	1285
48"	282	321	369	413	455	501	543	591	639	732	830	927	1028	1120	1216	1461
54"	299	341	390	443	493	542	590	644	692	798	903	1013	1120	1225	1330	1597
60"	327	363	420	478	528	582	634	693	751	864	980	1096	1212	1330	1441	1738
66"	341	385	446	504	568	623	681	743	803	927	1056	1181	1309	1431	1557	1872
72"	363	415	481	544	610	676	737	808	870	1009	1149	1283	1425	1559	1697	2043
78"	381	434	504	575	647	716	783	856	927	1072	1222	1367	1519	1661	1809	2182
84"	397	457	534	610	683	754	825	904	980	1137	1292	1448	1609	1762	1923	2319
90"	420	486	569	645	727	806	885	969	1049	1216	1383	1554	1723	1891	2062	2491
96"	434	504	591	677	763	846	927	1019	1103	1277	1457	1636	1817	1997	2175	2628
108"	470	548	647	741	837	931	1021	1120	1214	1407	1607	1805	2004	2204	2403	2901
120"	503	597	700	803	933	1011	1114	1224	1326	1539	1753	1973	2197	2413	2663	3219
132"	544	647	764	880	1021	1106	1221	1336	1451	1685	1925	2163	2409	2649	2926	
144"	580	692	817	939	1106	1191	1316	1437	1564	1815	2074	2333	2579	2844	3132	
156"	626	747	885	1020	1195	1290										
168"	667	798	941	1094	1281											
174"	705	845	997	1154	1356											

NOTE: SEE "PRODUCT CONFIGURATION SPECIFICATION" CHARTS ON PAGES 24-31 FOR ANY FABRIC AND SIZE RESTRICTIONS. CONTINUOUS CORD LOOP SYSTEM "REQUIRED" FOR FABRIC SIZES WITHIN THE THICK BLACK LINE.

OPTIONS: NO EXTRA CHARGE

- Color-Coordinated Rails
- Cordless Lift & Lock
- Cordless Lift & Lock Two-On-One Headrail – price as 2 separate shades and add together
- Cordless Lift & Lock Three-On-One Headrail – price as 3 separate shades and add together
- Control Positions – left or right side of the shade (Exception: for Two-on-One Headrail, cords must be on opposite ends of the headrail)
- 3" Extension Bracket and 1/2" Spacer Blocks – maximum of 3 spacer blocks per bracket
- Hold Down Brackets
- Cut-Outs – up to 3" wide (see page 27 for details)
- Special Cord Lengths – standard cord is approximately 3/4 the height of the shade unless otherwise specified

OPTIONS: EXTRA CHARGE

- See "SIZE STANDARDS" for complete option details.
- Fabric-Wrapped Rail Optionadd \$15
 - Top-Down & Top-Down/Bottom-Upadd \$67
 - Continuous Cord Loop*add \$49
 - Top-Down/Bottom-Up*add \$115
 - Cordless Lift System*add \$72
 - Two-On-One Headrail* price as 2 separate shades and add \$143 (not available in Top-Down/Bottom-Up or Two-Fabric Combination)
 - Three-On-One Headrail* price as 3 separate shades and add \$214 (not available in Top-Down/Bottom-Up or Two-Fabric Combination)
 - Top-Down/Bottom-Up*add \$138
 - Cordless Lift & Lock
 - Top-Down/Bottom-Up*add \$67
 - Premium Headrail Upgrade*add \$15 (Premium Headrail not available with Top-Down/Bottom-Up or TriLight)
 - Cordless Extension Pole #40-0036-000\$39
 - TriLight Shades – see pages 32-37
 - Angle Cutadd \$129

*NOTE: FABRIC-WRAPPED RAILS ARE OPTIONAL FOR A SURCHARGE ON CONTINUOUS CORD LOOP, CORDLESS LIFT, CORDLESS LIFT & LOCK, AND MOTORIZED SHADES. COLOR-COORDINATED RAILS ARE AVAILABLE AT NO ADDITIONAL CHARGE.

See page 23 for motorization surcharges

GROUP 13 – 2" HYBRID (Standard Rectangular)

NOTE: A control option must be selected.

• 2" Hybrid Pleat – Semi-Opaque (HPF)

WIDTH TO:	18"	24"	28"	32"	36"	42"	48"	54"	60"	66"	72"	78"	84"	90"	96"	108"	120"
HEIGHT TO:																	
30"	\$161	167	183	191	199	222	236	253	265	319	337	357	374	389	408	487	568
36"	167	170	190	199	209	232	249	268	285	340	360	381	399	417	436	520	606
42"	170	185	198	206	220	243	261	282	299	361	381	405	423	443	464	554	646
48"	176	191	204	216	229	255	291	298	316	379	404	428	449	470	490	590	684
54"	179	199	210	223	237	264	298	309	332	401	424	451	473	498	520	620	721
61"	183	205	221	236	248	278	316	329	346	423	447	480	505	532	553	657	763
66"	199	220	238	253	264	290	318	338	363	443	466	499	524	553	579	689	800
73"	200	226	244	260	272	301	325	356	381	464	490	527	556	587	608	724	
78"	232	262	282	302	324	353	382	418	449	480	510	544	574	607	636	756	
84"	238	269	291	310	332	364	399	436	466	499	533	568	599	634	666		
90"	244	278	299	324	342	378	411	450	486	519	554	593	626	661	693		
96"	249	286	308	332	355	389	426	467	503	540	575	615	650	686			
108"	271	315	341	370	399	441	486	533	575	618	662	709					
120"	292	341	377	409	442	490	542	597	647	698	748						

NOTE: SEE "PRODUCT CONFIGURATION SPECIFICATION" CHARTS ON PAGES 24-31 FOR ANY FABRIC AND SIZE RESTRICTIONS.

OPTIONS: NO EXTRA CHARGE	
<ul style="list-style-type: none"> • Color-Coordinated Rails • Cordless Lift & Lock • Cordless Lift & Lock Two-On-One Headrail – price as 2 separate shades and add together • Cordless Lift & Lock Three-On-One Headrail – price as 3 separate shades and add together • Control Positions – left or right side of the shade (Exception: for Two-on-One Headrail, cords must be on opposite ends of the headrail) 	<ul style="list-style-type: none"> • 3" Extension Bracket and 1/2" Spacer Blocks – maximum of 3 spacer blocks per bracket • Hold Down Brackets • Special Cord Lengths – standard cord is approximately 3/4 the height of the shade unless otherwise specified

OPTIONS: EXTRA CHARGE	
See "SIZE STANDARDS" for complete option details.	
<ul style="list-style-type: none"> • Fabric-Wrapped Rail Optionadd \$15 • Top-Down & Top-Down/Bottom-Upadd \$67 • Continuous Cord Loop*add \$49 <ul style="list-style-type: none"> – Top-Down/Bottom-Up*add \$115 • Cordless Lift System*add \$72 <ul style="list-style-type: none"> – Two-On-One Headrail* price as 2 separate shades and add \$143 (not available in Top-Down/Bottom-Up or Two-Fabric Combination) – Three-On-One Headrail* price as 3 separate shades and add \$214 (not available in Top-Down/Bottom-Up or Two-Fabric Combination) – Top-Down/Bottom-Up*add \$138 	<ul style="list-style-type: none"> • Cordless Lift & Lock <ul style="list-style-type: none"> – Top-Down/Bottom-Up*add \$67 – Premium Headrail Upgrade*add \$15 (Premium Headrail not available with Top-Down/Bottom-Up or TriLight) • Cordless Extension Pole #40-0036-000\$39 • TriLight Shades – see pages 32-37

*NOTE: FABRIC-WRAPPED RAILS ARE OPTIONAL FOR A SURCHARGE ON CONTINUOUS CORD LOOP, CORDLESS LIFT, CORDLESS LIFT & LOCK, AND MOTORIZED SHADES. COLOR-COORDINATED RAILS ARE AVAILABLE AT NO ADDITIONAL CHARGE.

See page 23 for motorization surcharges
 Note: 2" Hybrid Pleat is Not Available with PowerWand Motorization

GROUP 14 – 2" HYBRID (Standard Rectangular)

NOTE: A control option must be selected.

• 2" Hybrid Pleat – Blackout (HPR)

WIDTH TO:	18"	24"	28"	32"	36"	42"	48"	54"	60"	66"	72"	78"	84"	90"	96"	108"	120"
HEIGHT TO:																	
30"	\$202	217	230	239	251	278	294	319	335	401	424	449	471	491	510	611	714
36"	208	225	238	249	263	292	311	337	356	428	450	478	501	525	546	655	766
42"	214	233	246	262	275	306	326	355	378	452	477	509	532	559	583	699	813
48"	218	239	259	270	285	319	342	374	396	477	505	537	564	593	619	740	861
54"	225	248	268	280	300	333	360	389	417	503	532	568	596	627	655	782	908
61"	230	260	277	294	309	349	378	411	432	532	563	603	634	667	693	827	958
66"	248	275	301	317	332	362	389	427	456	553	590	627	660	694	728	868	1005
73"	255	282	307	326	341	378	408	447	477	583	616	663	698	737	767	912	
78"	292	330	355	380	408	443	481	527	564	603	641	686	724	762	801	950	
84"	311	356	386	417	446	491	535	590	634	678	724	775	817	864	909		
90"	342	392	425	457	491	538	592	646	696	744	799	849	901	950	1001		
96"	366	429	472	513	553	618	681	753	813	878	942	1010	1073	1137			
108"	425	511	564	619	677	758	844	934	1016	1098	1186	1273					
120"	468	572	637	706	776	878	981	1090	1190	1289	1396						

NOTE: SEE "PRODUCT CONFIGURATION SPECIFICATION" CHARTS ON PAGES 24-31 FOR ANY FABRIC AND SIZE RESTRICTIONS.

OPTIONS: NO EXTRA CHARGE	
<ul style="list-style-type: none"> • Color-Coordinated Rails • Cordless Lift & Lock • Cordless Lift & Lock Two-On-One Headrail – price as 2 separate shades and add together • Cordless Lift & Lock Three-On-One Headrail – price as 3 separate shades and add together • Control Positions – left or right side of the shade (Exception: for Two-on-One Headrail, cords must be on opposite ends of the headrail) 	<ul style="list-style-type: none"> • 3" Extension Bracket and 1/2" Spacer Blocks – maximum of 3 spacer blocks per bracket • Hold Down Brackets • Special Cord Lengths – standard cord is approximately 3/4 the height of the shade unless otherwise specified

OPTIONS: EXTRA CHARGE	
<p>See "SIZE STANDARDS" for complete option details.</p> <ul style="list-style-type: none"> • Fabric-Wrapped Rail Optionadd \$15 • Top-Down & Top-Down/Bottom-Upadd \$67 • Continuous Cord Loop*add \$49 <ul style="list-style-type: none"> – Top-Down/Bottom-Up*add \$115 • Cordless Lift System*add \$72 <ul style="list-style-type: none"> – Two-On-One Headrail* price as 2 separate shades and add \$143 (not available in Top-Down/Bottom-Up or Two-Fabric Combination) – Three-On-One Headrail* price as 3 separate shades and add \$214 (not available in Top-Down/Bottom-Up or Two-Fabric Combination) – Top-Down/Bottom-Up*add \$138 	<ul style="list-style-type: none"> • Cordless Lift & Lock <ul style="list-style-type: none"> – Top-Down/Bottom-Up*add \$67 – Premium Headrail Upgrade*add \$15 (Premium Headrail not available with Top-Down/Bottom-Up or TriLight) • Cordless Extension Pole #40-0036-000\$39 • TriLight Shades – see pages 32-37

*NOTE: FABRIC-WRAPPED RAILS ARE OPTIONAL FOR A SURCHARGE ON CONTINUOUS CORD LOOP, CORDLESS LIFT, CORDLESS LIFT & LOCK, AND MOTORIZED SHADES. COLOR-COORDINATED RAILS ARE AVAILABLE AT NO ADDITIONAL CHARGE.

See page 23 for motorization surcharges
 Note: 2" Hybrid Pleat is Not Available with PowerWand Motorization

SIMPLICITY SURCHARGE AND OPTIONS
EXTRA CHARGE – SPECIFY ON ORDER
 USE APPROPRIATE HONEYCOMB SHADE GRID FOR SHADE PRICE, THEN ADD EXTRA CHARGE(S) BELOW.

- **Standard Simplicity Motorization** (Battery wand included in the price)add \$277 per shade
 - 5 Channel Remote Control (Black Part #CS5138 or White Part #CS5138W)add \$46 each
 - 48" Extension Wire (Part #CS5133Z)add \$9 each
 - DC Power Supply (Part #CS5151).....add \$38 each

- **Simplicity Rechargeable Motor**add \$277 per shade
 - 2-on-1 Headrailprice as 2 separate shades
 - 5 Channel Remote Control (Black Part #CS5138 or White Part #CS5138W)add \$46 each
 - 48" Extension Wire (Part #CS5133Z)add \$9 each
 - Solar Panel (Part #CS52096)add \$168 each
 - Plug-In Charger (Part #CS5199).....add \$35 each

- **PowerWand™**add \$127 per shade
 - PowerWand™ Options (must be specified): **No Charge**
 - 1) Control Side (Left or Right)
 - 2) Wand Color (Black or White)
 - 3) Wand Length:
 - 1 foot (12")
 - 2 feet (24")
 - 3 feet (36")
 - 4 feet (48")
 - 5 feet (60")
 - Plug-In Charger (Part #CS5199).....add \$35 each

Note: 2" Hybrid Pleat is Not Available with PowerWand™ Motorization

REMOTELIFT 2.0 SURCHARGE AND OPTIONS

- **RemoteLift 2.0**add \$319
- **Remote Control #2984495100**add \$60
- **Wireless Wall Switch #2986350100**add \$83
- **RemoteLift Top-Down***add \$50
- **Satellite Battery Pack #KIT2520** – select with wire length below:
 - **Satellite Battery Pack (15" Wire) #2989899000**add \$70
 - **Satellite Battery Pack (4' Wire) #2989900000**add \$76
 - **Satellite Battery Pack (10' Wire) #2989901000**add \$89
 - **Satellite Battery Pack (20' Wire) #2989902000**add \$98
- **18V DC Power Supply #7806000000** – select with wire length below:
 - **DC Power Supply (15" Wire) #2989899000**add \$103
 - **DC Power Supply (4' Wire) #2989900000**add \$105
 - **DC Power Supply (10' Wire) #2989901000**add \$109
 - **DC Power Supply (20' Wire) #2989902000**add \$113
- **Daisy Chain cable option requires DC Power Supply**
 - Daisy Chain Adapter** (Select with wire length below) #2989875000
 - (with 15" cable) #2989899000add \$51
 - (with 4' cable) #2989900000add \$58
 - (with 10' cable) #2989901000add \$62
 - (with 20' cable) #2989902000add \$68
- **Momenta** (must be submitted as part order)
 - **Momenta App Bridge Kit #2920072100** add \$128 NET Cost
 - **Momenta Extender Kit #2920075100**add \$47 NET Cost

REMOTELIFT 2.0 SPECIFICATIONS HAVE BEEN UPDATED. PLEASE VERIFY SIZE RESTRICTIONS ON PAGE 40 PRIOR TO ORDERING.

RECTANGULAR CONFIGURATION SPECIFICATIONS

NOTE: Use metal tape measure for all measurements. Measures to 1/8 inch.

STANDARD CORDLOCK

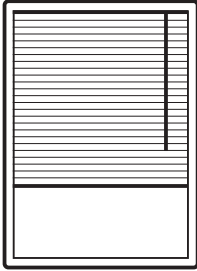

- Features snap-in bracket
- Headrail Color – color coordinated with fabric.
- End mount brackets also available

2" Hybrid Pleat is not available with standard cordlock.

STANDARD RECTANGULAR – SIZE STANDARDS							
	Honeycomb						
	All 3/8" Semi-Opaque Fabrics	All 3/8" Blackout Fabrics	All 3/4" Sheer and Semi-Sheer Fabrics	All 3/4" Semi-Opaque Fabrics*	All 3/4" Blackout Fabrics*	All 1/2" Double Cell Fabrics	All 3/8" Triple Cell Fabrics
Min. Width (net)*	8"	8"	8"	8"	8"	8"	8"
Max. Width	174"	174"	174"	174"	174"	174"	142"
Max. Width-End Mount	36"	36"	36"	36"	36"	36"	36"
Min. Height	6"	6"	6"	6"	6"	6"	6"
Max. Height*	144"	144"	144"	174"	174"	144"	120"
Max. Area (sq. ft.)	60	40	60	60	40	40	40

* For shades under 12" widths, the maximum height is 80"

* Radiance Semi-Opaque & Blackout => Max Width 120"

FINISHED DIMENSIONS

Adjustments are taken from ordered dimensions.

Inside (IB) Mount	
Headrail unit	- 3/16"
Shade height	ordered height
Fabric width	- 3/8"
Outside (OB) Mount	
Headrail unit	ordered width
Shade height	ordered height
Fabric width	- 3/16"
End (EB) Mount	
Headrail unit	- 3/16"
Shade height	ordered height
Fabric width	- 3/8"
2 on 1 Headrail	
Gap between panels	- 1/4"

NOTE: Measurements may vary ± 1/8"

MOUNTING REQUIREMENTS

Use a metal tape measure for all measurements.

Inside (IB) Mount		3/8" Single Cell
Minimum mounting depth:		
Standard installation bracket		1"
Swivel bracket		1/2"
Minimum mounting depth, flush mount:		
Standard installation bracket		1-1/2"
Swivel bracket		1-1/8"
End mount bracket		1-1/8"
Outside (OB) Mount		3/8" Single Cell
Minimum flat vertical surface		
		5/8"
Inside (IB) Mount		3/4" Single, 1/2" Double, 3/8" Triple
Minimum mounting depth:		
Standard installation bracket		1-1/4"
Swivel bracket		1/2"
Minimum mounting depth, flush mount:		
Standard installation bracket		2-1/4"
Swivel bracket		2"
End mount bracket		2"
Outside (OB) Mount		3/4" Single, 1/2" Double, 3/8" Triple
Minimum flat vertical surface		
		1"

RECTANGULAR CONFIGURATION SPECIFICATIONS

NOTE: Use metal tape measure for all measurements. Measures to 1/8 inch.

STANDARD CORDLOCK – 2-ON-1 HEADRAIL (PRICE AS 2 SEPARATE SHADES)

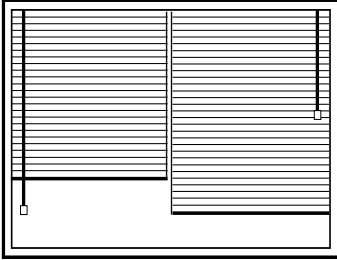

Cover patio doors and other large expanses by placing two independently operated shades side-by-side on the same headrail. Note: there will be a 1/4" minimum to a 1/2" maximum light gap between the two shades.

Finished Dimensions & Mounting Requirements:

see "Standard Rectangle" or "Continuous Cord" section.

NOTE: Measurements may vary $\pm 1/8$ "

STANDARD TWO-ON-ONE – SIZE STANDARDS							
	Honeycomb						
	All 3/8" Semi-Opaque Fabrics	All 3/8" Blackout Fabrics	All 3/4" Sheer and Semi-Sheer Fabrics	All 3/4" Semi-Opaque Fabrics*	All 3/4" Blackout Fabrics*	All 1/2" Double Cell Fabrics	All 3/8" Triple Cell Fabrics
Min. Width (per panel)	8"	8"	8"	8"	8"	8"	8"
Min. Width (overall)	16"	16"	16"	16"	16"	16"	16"
Max. Width (per panel)	162"	162"	162"	162"	162"	162"	142"
Max. Width (overall)	192"	192"	192"	192"	192"	192"	184"
Max. Width (end mount)	36"	36"	36"	36"	36"	36"	36"
Min. Height	6"	6"	6"	6"	6"	6"	6"
Max. Height	144"	144"	144"	174"	174"	144"	120"
Max. Area (sq. ft.)	60	40	60	60	40	40	60

* Radiance Semi-Opaque & Blackout => Max Width 120"

Controls must be on opposite ends of the headrail.

RECTANGULAR CONFIGURATION SPECIFICATIONS

NOTE: Use metal tape measure for all measurements. Measures to 1/8 inch.

STANDARD CORDLOCK – TOP-DOWN OR TOP-DOWN/BOTTOM-UP

(2-cell fabric insert)

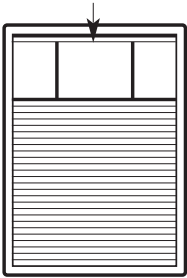

(2-cell fabric insert)

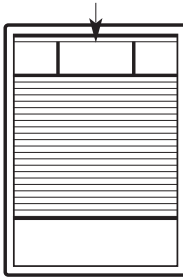

Conveniently open shades from the top down or from both top and bottom.

Top-Down/Bottom-Up features one Break-Away tassel per cordlock.

Finished Dimensions & Mounting Requirements:

- See "Standard Rectangle" or "Cordless Lift" section.
- End mount brackets also available.

NOTE: Measurements may vary $\pm 1/8"$

NOTES:

- The standard control positions for TD/BU are:
RIGHT operates the center moving rail and LEFT operates the bottomrail. REVERSE CONTROLS also are available (operate opposite as described above). Specify REVERSE CONTROLS when ordering.
- On top-down/bottom-up shades a fabric insert is standard. This is an extra two-cell fabric gasket attached to the top headrail and acts as a seal to eliminate light leakage between the headrail and center rail when the shade is closed.

TOP-DOWN – SIZE STANDARDS

	Honeycomb						
	All 3/8" Semi-Opaque Fabrics	All 3/8" Blackout Fabrics	All 3/4" Sheer and Semi-Sheer Fabrics	All 3/4" Semi-Opaque Fabrics	All 3/4" Blackout Fabrics	All 1/2" Double Cell Fabrics	All 3/8" Triple Cell Fabrics
Min. Width (net)*	10"	10"	10"	10"	10"	10"	10"
Max. Width	60"	60"	60"	60"	60"	60"	60"
Max. Width-End Mount	36"	36"	36"	36"	36"	36"	36"
Min. Height	6"	6"	6"	6"	6"	6"	6"
Max. Height*	144"	144"	144"	174"	174"	144"	120"
Max. Area (sq. ft.)	60	40	60	60	40	40	60

* For shades under 12" widths, the maximum height is 80"

TOP-DOWN/BOTTOM-UP – SIZE STANDARDS

	Honeycomb						
	All 3/4" Semi-Opaque Fabrics	All 3/8" Blackout Fabrics	All 3/4" Sheer and Semi-Sheer Fabrics	All 3/4" Semi-Opaque Fabrics	All 3/4" Blackout Fabrics	All 1/2" Double Cell Fabrics	All 3/8" Triple Cell Fabrics
Min. Width (net)*	10"	10"	10"	10"	10"	10"	10"
Max. Width	72"	72"	72"	72"	72"	72"	72"
Max. Width-End Mount	36"	36"	36"	36"	36"	36"	36"
Min. Height	6"	6"	6"	6"	6"	6"	6"
Max. Height*	108"	108"	108"	108"	108"	108"	108"
Max. Area (sq. ft.)	48	40	48	48	40	40	48

* For shades under 12" widths, the maximum height is 80"

Cut-outs are not available on Top-Down or Top-Down/Bottom-Up shades.

RECTANGULAR CONFIGURATION SPECIFICATIONS

NOTE: Use metal tape measure for all measurements. Measures to 1/8 inch.

STANDARD CORDLOCK – TWO-FABRIC COMBINATION (PRICE AS 2 SEPARATE SHADES)

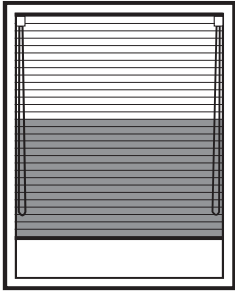

Headrail, Middle Rail, and Bottomrail will coordinate with the bottom fabric unless otherwise specified.

Combines two fabrics in the same shade for function, beauty and total versatility. Consider a sheer shade to filter light, combined with a blackout shade for maximum darkness. Easily adjust shade to cover the window with one fabric or with some of each fabric.

Shade features one Break-Away tassel per cordlock.

Finished Dimensions & Mounting Requirements:

- See "Standard Rectangle" or "Cordless Lift" section.
- End mount brackets also available.

NOTE: Measurements may vary \pm 1/8"

TWO-FABRIC COMBO – SIZE STANDARDS

	Honeycomb					
	All 3/4" Semi-Opaque Fabrics	All 3/4" Sheer and Semi-Sheer Fabrics	All 3/4" Semi-Opaque Fabrics	All 3/4" Blackout Fabrics	All 1/2" Double Cell Fabrics	All 3/8" Triple Cell Fabrics
Min. Width (net)*	10"	10"	10"	10"	10"	10"
Max. Width	72"	72"	72"	72"	60"	60"
Max. Width-End Mount	36"	36"	36"	36"	36"	36"
Min. Height	6"	6"	6"	6"	6"	6"
Max. Height*	96"	96"	96"	96"	90"	90"
Max. Area (sq. ft.)	48	48	48	40	40	40

* For shades under 12" widths, the maximum height is 80"

Not available with 3/8" single cell fabrics, SoftStyle or 2" Hybrid Pleat fabrics.

CUT-OUTS

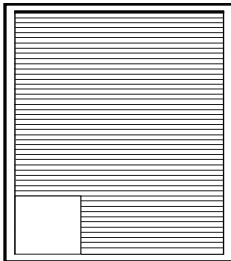

The portion of the shade above the cut-out will not stack tightly when the shade is raised.

Available on standard cordlock, continuous cord loop and RemoteLift bottom-up shades only.

Not available on 2" Hybrid Pleat shades.

CUT-OUTS - SIZE STANDARDS

Min. Cut-out Width	1/8"
Max. Cut-out Width	3"
Min. Shade Width	12"
Max. Shade Width	120"
Min. Shade Height	12"
Max. Shade Height	120"

RECTANGULAR CONFIGURATION SPECIFICATIONS

NOTE: Use metal tape measure for all measurements. Measures to 1/8 inch.

CORDLESS LIFT SYSTEM

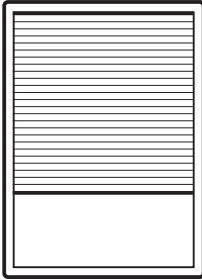

Cordless Lift System easily lifts and lowers from color-coordinated bottomrail. No lift cord is necessary.



- All Cordless shades can be ordered with the fabric covered headrail and bottomrail **for a surcharge**, or with the color coordinated non-wrapped rails at **no additional charge**. Must be specified when order is placed.
- Cordless honeycomb shades come with a color-coordinated textured handle pre-inserted, a clear textured handle or clear plastic insert are optional.
Shades over 42" in width will have 2 handles.
- Cut-outs are not available on Cordless Lift shades.
- Top Down Bottom Up shades are now available with white striker plates and magnet caps when shades are ordered with fabric-wrapped rails. Zinc striker plates and magnets comes standard on shades ordered with color-coordinated rails.
Striker plate & magnet placement:
Shades under 42" Wide – one magnet on each end of the shade
Shades 42" - 78" wide – one magnet on each end of the shade and one offset 3" from the center cord
Shades 78" - 96" wide – one magnet on each end of the shade and one in the center of the shade.
Shades over 96" wide – one magnet on each end of the shade and one at 3" to the left and right of the center routes.

CORDLESS LIFT – SIZE STANDARDS		
	Honeycomb	2" Hybrid Pleat
	All Honeycomb Fabrics *	All Fabrics
Min. Width (net)	16"	16"
Max. Width	120"	120"
Max. Width – End Mount	48"	42"
Min. Height	12"	12"
Max. Height	84"	84"
Max Area (sq. ft.)	70	60

* Cordless Lift not available with any 3/8" blackout or triple cell fabrics

CORDLESS LIFT TOP-DOWN/BOTTOM-UP – SIZE STANDARDS		
	Honeycomb	2" Hybrid Pleat
	All Honeycomb Fabrics *	All Fabrics
Min. Width (net)	16"	16"
Max. Width	120"	120"
Max. Width – End Mount	48"	42"
Min. Height	12"	12"
Max. Height	84"	84"
Max Area (sq. ft.)	70	60

* Cordless Lift Top-Down/Bottom-Up is not available with any 3/8" blackout or triple cell fabrics

CORDLESS LIFT TWO-FABRIC COMBO – SIZE STANDARDS	
	All Honeycomb Fabrics *
Min. Width (net)	16"
Max. Width	84"
Max. Width – End Mount	36"
Min. Height	12"
Max. Height	84"
Max Area (sq. ft.)	42

* Cordless Lift Two-Fabric Combination is not available with any 3/8", 3/8" blackout, 1/2" double cell, triple cell, or 2" Hybrid Pleat fabrics

Note: Cut-outs are not available on Cordless Lift shades.

CORDLESS TWO-ON-ONE – SIZE STANDARDS		
	Honeycomb	2" Hybrid Pleat
	All Honeycomb Fabrics *	All Fabrics
Min Width (per panel)	16"	16"
Min Width (overall)	32"	32"
Max Width (per panel)	120"	100"
Max Width (overall)	174"	120"
Min Height	12"	12"
Max Height	84"	84"
Max Area (per panel) (Sq/Ft)	70	60

* Two-On-One Headrail is not available in Top-Down/Bottom-Up, Two-Fabric Combo, 3/8" blackout or triple cell fabrics

Note: End mount not available.

CORDLESS THREE-ON-ONE – SIZE STANDARDS		
	Honeycomb	2" Hybrid Pleat
	All Honeycomb Fabrics *	All Fabrics
Min Width (per panel)	16"	16"
Min Width (overall)	48"	48"
Max Width (per panel)	120"	120"
Max Width (overall)	174"	174"
Min Height	12"	12"
Max Height	84"	84"
Max Area (per panel) (Sq/Ft)	70	60

* Three-On-One Headrail is not available in Top-Down/Bottom-Up, Two-Fabric Combo, 3/8" blackout or triple cell fabrics

Note: End mount not available.

FINISHED DIMENSIONS

Adjustments are taken from ordered dimensions.

	Honeycomb	2" Hybrid Pleat
Inside (IB) Mounts		
Headrail unit	- 1/4"	- 1/4"
Shade height	ordered height	ordered height
Fabric width	- 3/8"	- 3/8"
End (EB) Mounts		
Headrail unit	- 1/2"	- 1/2"
Shade height	ordered height	ordered height
Fabric width	- 5/8"	- 5/8"
Outside (OB) Mount		
Headrail unit	ordered width	ordered width
Shade height	ordered height	ordered height
Fabric width	- 1/8"	- 1/8"
2-on-1 & 3-on-1 Headrail		
Gap between panels	-1/4"	-1/4"

NOTE: Measurements may vary ± 1/8"

MOUNTING REQUIREMENTS

Use a metal tape measure for all measurements.

	Honeycomb	2" Hybrid Pleat
Inside (IB) & End (EB) Mounts		
Minimum mounting depth	3/4"	3/4"
Minimum mounting depth, flush mount:	2-1/8"	2-1/8"
Outside (OB) Mount		
Minimum flat vertical surface	1-1/2"	1-1/2"

NOTE: Inside mount with hold down brackets deductions:
Headrail -1/2"
Fabric -5/8"
Bottomrail -1/2"

RECTANGULAR CONFIGURATION SPECIFICATIONS

NOTE: Use metal tape measure for all measurements. Measures to 1/8 inch.

CORDLESS LIFT & LOCK

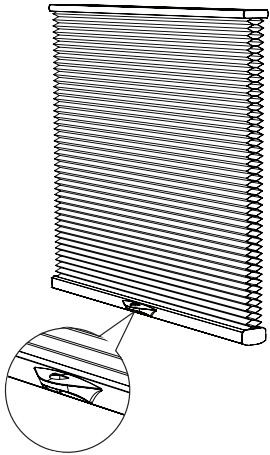

Press a button on the bottomrail to lift and lower the shade. Release the button to securely lock the shade into place.

No exposed cords on bottom up shades. Lift cords on Top-Down/Bottom-Up are on the far sides of the shade. Child-safe option.

All Cordless Lift & Lock shades can be ordered with the fabric covered headrail and bottomrail for a surcharge, or with the color coordinated non-wrapped rails at no additional charge. Must be specified when order is placed.

CORDLESS LIFT & LOCK – SIZE STANDARDS			
	Honeycomb		2" Hybrid Pleat
	Sheer, Semi-Sheer & Semi-Opaque Honeycomb Fabrics*	All Blackout Honeycomb Fabrics*	All Fabrics
Min. Width (net)	9-1/2"	9-1/2"	9-1/2"
Max. Width	84"	84"	84"
Max. Width – End Mount	48"	48"	48"
Min. Height	12"	12"	12"
Max. Height	84"	84"	84"
Max Area (sq. ft.)	49	49	49

* Cordless Lift & Lock is not available with any 3/8" or triple cell fabrics

CORDLESS LIFT & LOCK TOP-DOWN/BOTTOM-UP – SIZE STANDARDS			
	Honeycomb		2" Hybrid Pleat
	All Sheer, Semi-Sheer & Semi-Opaque Honeycomb Fabrics*	All Blackout Honeycomb Fabrics*	All Fabrics
Min. Width (net)	16"	16"	16"
Max. Width	84"	84"	84"
Max. Width – End Mount	48"	48"	42"
Min. Height	12"	12"	12"
Max. Height	84"	84"	84"
Max Area (sq. ft.)	49	49	49

* Cordless Lift & Lock is not available with any 3/8" or triple cell fabrics

Top-Down/bottom-Up Lift & Lock shades under 42" will have one magnet in the middle.

Shades over 42" will have one magnet in the middle, and one approximately 3" from each end to provide better closure between the middle rail and top rail.

Cordless Lift & Lock shades can be ordered with the Premium headrail for a surcharge. Premium headrail option is not available with Top-Down/Bottom-Up or TriLight.

CORDLESS LIFT & LOCK TWO-ON-ONE & THREE-ON-ONE – SIZE STANDARDS			
	All Sheer, Semi-Sheer & Semi-Opaque Honeycomb Fabrics*	All Blackout Honeycomb Fabrics*	2" Hybrid Pleat
Two-on-One			
Min. Width (net - per panel)	9.5"	9.5"	9.5"
Max. Width (per panel)	84"	84"	84"
Max. Width (overall)	168"	168"	168"
Three-on-One			
Min. Width (net - per panel)	9.5"	9.5"	9.5"
Max. Width (per panel)	84"	84"	84"
Max. Width (overall)	168"	168"	168"
Min. Height	12"	12"	12"
Max. Height	84"	84"	84"
Max Area (per panel) (sq. ft.)	49	49	49

* Cordless Lift & Lock not available with any 3/8" or triple cell fabrics.

Note: End mount not available with 2-on-1 or 3-on-1

FINISHED DIMENSIONS – STANDARD

Adjustments are taken from ordered dimensions.

	Honeycomb	2" Hybrid Pleat
Inside (IB) Mounts		
Headrail unit (includes end caps)	- 1/4"	- 1/4"
Shade height	ordered height	ordered height
Fabric width	- 3/8"	- 3/8"
End (EB) Mounts		
Headrail unit (includes end caps)	- 1/2"	- 1/2"
Shade height	ordered height	ordered height
Fabric width	- 5/8"	- 5/8"
Outside (OB) Mount		
Headrail unit (includes end caps)	ordered width	ordered width
Shade height	ordered height	ordered height
Fabric width	- 1/8"	- 1/8"
2-on-1 & 3-on-1 Headrail		
Gap between panels	-1/4"	-1/4"

NOTE: Measurements may vary ± 1/8"

MOUNTING REQUIREMENTS

Use a metal tape measure for all measurements.

	Honeycomb	2" Hybrid Pleat
Standard Headrail		
Inside (IB) Mount		
Minimum mounting depth	1-1/4"	1-1/4"
Minimum mounting depth, flush mount:	2-1/4"	2-1/4"
End (EB) Mount		
Minimum flat vertical surface	2"	2"
Outside (OB) Mount		
Minimum flat vertical surface	1"	1"

NOTE: Inside mount with hold down brackets deductions:
 Headrail -1/2"
 Fabric -5/8"
 Bottomrail -1/2"

Use a metal tape measure for all measurements.

	Honeycomb	2" Hybrid Pleat
with Premium Rail option		
Inside (IB) Mounts		
Minimum mounting depth	3/4"	3/4"
Minimum mounting depth, flush mount:	2-1/8"	2-1/8"
Outside (OB) Mount		
Minimum flat vertical surface	1-1/2"	1-1/2"

RECTANGULAR CONFIGURATION SPECIFICATIONS

NOTE: Use metal tape measure for all measurements. Measures to 1/8 inch.

CONTINUOUS CORD LOOP SYSTEM

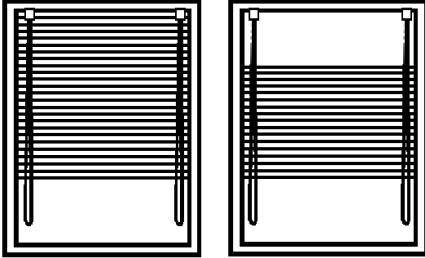

Continuous cord loop easily lifts any shade – even large or hard-to-reach – and stops the shade exactly where you want. No more tangled cords!

- All continuous cord loop shades can be ordered with the fabric covered headrail and bottomrail **for a surcharge**, or with the color coordinated non-wrapped rails at **no additional charge. Must be specified** when order is placed.
- On top-down/bottom-up shades a fabric insert is standard. This is an extra two-cell fabric gasket attached to the top headrail and acts as a seal to eliminate light leakage between the headrail and center rail when the shade is closed.

CONTINUOUS CORD LOOP – SIZE STANDARDS								
	Honeycomb							2" Hybrid Pleat
	All 3/8" Semi-Opaque Fabrics	All 3/8" Blackout Fabrics	All 3/4" Sheer and Semi-Sheer Fabrics	All 3/4" Semi-Opaque Fabrics*	All 3/4" Blackout Fabrics*	All 1/2" Double Cell Fabrics	All 3/8" Triple Cell Fabrics	All Fabrics
Min. Width (net)*	18"	18"	18"	18"	18"	18"	18"	18"
Max. Width	144"	144"	174"	174"	144"	144"	142"	120"
Max. Width – End Mount	48"	48"	48"	48"	48"	48"	48"	42"
Min. Height	6"	6"	6"	6"	6"	6"	6"	12"
Max. Height*	96"	96"	144"	144"	144"	144"	120"	120"
Max. Area (sq. ft.)	90	80	150	150	100	80	80	60

* Radiance Semi-Opaque & Blackout => Max Width 120"

CONTINUOUS CORD LOOP TWO-ON-ONE – SIZE STANDARDS								
	Honeycomb							2" Hybrid Pleat
	All 3/8" Semi-Opaque Fabrics	All 3/8" Blackout Fabrics	All 3/4" Sheer and Semi-Sheer Fabrics	All 3/4" Semi-Opaque Fabrics*	All 3/4" Blackout Fabrics*	All 1/2" Double Cell Fabrics	All 3/8" Triple Cell Fabrics	2" Hybrid Pleat
Min. Width (per panel)	18"	18"	18"	18"	18"	18"	18"	18"
Min. Width (overall)	36"	36"	36"	36"	36"	36"	36"	36"
Max. Width (per panel)	144"	144"	144"	144"	144"	144"	142"	102"
Max. Width (overall)	174"	174"	174"	174"	174"	174"	174"	120"
Min. Height	6"	6"	6"	6"	6"	6"	6"	12"
Max. Height	96"	96"	144"	144"	144"	144"	120"	120"
Max. Area (sq. ft.)	90	80	150	150	100	80	80	60

Note: End mount not available.

* Radiance Semi-Opaque & Blackout => Max Width 120"

CONTINUOUS CORD LOOP TOP-DOWN/BOTTOM-UP – SIZE STANDARDS								
	Honeycomb							2" Hybrid Pleat
	All 3/8" Semi-Opaque Fabrics	All 3/8" Blackout Fabrics	All 3/4" Sheer and Semi-Sheer Fabrics	All 3/4" Semi-Opaque Fabrics*	All 3/4" Blackout Fabrics*	All 1/2" Double Cell Fabrics	All 3/8" Triple Cell Fabrics	2" Hybrid Pleat
Min. Width (net)*	24"	24"	24"	24"	24"	24"	24"	24"
Max. Width	144"	144"	144"	144"	144"	144"	142"	120"
Max. Width – End Mount	48"	48"	48"	48"	48"	48"	48"	42"
Min. Height	8"	8"	8"	8"	8"	8"	8"	12"
Max. Height*	96"	96"	144"	144"	144"	144"	120"	120"
Max. Area (sq. ft.)	90	80	150	150	100	80	80	60

* Radiance Semi-Opaque & Blackout => Max Width 120"

Right control operates the center moving rail; left control operates the bottomrail. Reverse controls are available.

NOTE: Inside mount with hold down brackets deductions:
 Headrail -1/2"
 Fabric -5/8"
 Bottomrail -1/2"

RECTANGULAR CONFIGURATION SPECIFICATIONS

NOTE: Use metal tape measure for all measurements. Measures to 1/8 inch.

CONTINUOUS CORD LOOP SYSTEM

FINISHED DIMENSIONS

Adjustments are taken from ordered dimensions.

Honeycomb 2" Hybrid
Pleat*

Inside (IB) Mount		
Headrail unit	- 1/4"	- 1/4"
Shade height	ordered height	ordered height
Fabric width	- 3/8"	- 5/8"
End (EB) Mounts		
Headrail unit	- 1/2"	- 1/2"
Shade height	ordered height	ordered height
Fabric width	- 5/8"	- 7/8"
Outside (OB) Mount		
Headrail unit	ordered width	ordered width
Shade height	ordered height	ordered height
Fabric width	- 1/8"	- 3/8"

*An extra 1/4" deduction will be taken from the fabric with the Top-Down/ Bottom-Up option for Hybrid Pleat

NOTE: Measurements may vary ± 1/8"

FINISHED DIMENSIONS – 2 ON 1

Adjustments are taken from ordered dimensions.

Honeycomb 2" Hybrid
Pleat

Inside (IB) Mount		
Headrail unit	- 1/4"	- 1/4"
Shade height	ordered height	ordered height
Fabric width (includes gap deduction)	- 5/8"	- 7/8"
Outside (OB) Mount		
Headrail unit	ordered width	ordered width
Shade height	ordered height	ordered height
Fabric width	- 1/8"	- 3/8"
2 on 1 Headrail		
Gap between panels	- 1/4"	- 1/4"

CORD LOOP DROP

SHADE HEIGHT	CORD LOOP DROP
up to 18"	18" loop
18" to 42"	24" loop
42-1/8" - 54"	36" loop
54-1/8" - 72"	48" loop
72-1/8" - 90"	60" loop
90-1/8" - 110"	72" loop
110-1/8" - 130"	96" loop
130-1/8" - 144"	120" loop

MOUNTING REQUIREMENTS

Use a metal tape measure for all measurements.

Honeycomb 2" Hybrid
Pleat

Inside (IB) Mounts		
Minimum mounting depth	3/4"	3/4"
Minimum mounting depth, flush mount:	2-1/8"	2-1/8"
Outside (OB) Mount		
Minimum flat vertical surface	1-1/2"	1-1/2"

NOTE: Inside mount with hold down brackets deductions:

Headrail -1/2"

Fabric -5/8"

Bottomrail -1/2"

FEATURES & BENEFITS



- The beautiful combination of a sheer pleated shade on top and honeycomb or 2" Hybrid Pleat shade on the bottom provides maximum versatility in a single window covering.
- Wide array of color options from whites, neutrals, and muted tones to bold colors and exclusive prints.
- Four sheer pleated styles in multiple colors to meet most decorating tastes.
- Semi-opaque and blackout fabrics are available in multiple sizes, providing a choice for every window size and desired light and privacy control.
- Honeycomb fabric provides superior insulation for reduced heating and cooling bills. It also absorbs sound, making rooms more comfortable.
- The continuous cord loop option lifts any shade – even large or hard-to-reach – and positions it exactly where you want without any dangling cords.
- The Cordless and Cordless Lift & Lock option provide safe, simple operation by raising and lowering the shade using handles instead of cords. Ideal in homes with children and pets.

SELECTING A TRILIGHT SHADE

1. Choose a fabric, cell size and color for the bottom shade. Note: TriLight Shades are not available with 3/8" single cell, 3/4" sheer/semi-sheer or triple cell fabrics.
2. Choose a sheer pleated fabric for the top shade. See Sheer Pleated Color Chart.
3. Refer to the honeycomb and 2" Hybrid Pleat price grids on pages 9-22 to determine your bottom shade price.
4. Refer to the sheer pleated grids on page 33 to find your top shade price. Add the bottom shade, sheer pleated and control option prices together to determine your final price.
 - TriLight Shades are available as standard rectangle only.
 - Continuous cord loop system – right operates the middle rail; left operates the bottomrail. Reverse controls are available; grouped controls are NOT available.

SHEER PLEATED COLOR CHART

Sheer Pleated Price Group A		
Style Name	Color #	Color Name
Nova Sheer	P33-824	Blush
Nova Sheer	P33-820	Bridal White
Nova Sheer	P33-823	Crème
Nova Sheer	P33-821	Glacier White
Nova Sheer	P33-822	Light Lemon
Nova Sheer	P33-825	Tea

Sheer Pleated Price Group B		
Style Name	Color #	Color Name
Carousel Sheer	P32-804	Blush
Carousel Sheer	P32-800	Bridal White
Carousel Sheer	P32-803	Crème
Carousel Sheer	P32-801	Glacier White
Carousel Sheer	P32-802	Light Lemon
Carousel Sheer	P32-805	Tea

Sheer Pleated Price Group A		
Style Name	Color #	Color Name
Willa Sheer	P05-506	Bisque
Willa Sheer	P05-508	Chocolate
Willa Sheer	P05-504	Crystal
Willa Sheer	P05-502	Heirloom
Willa Sheer	P05-501	Ice
Willa Sheer	P05-507	Latte
Willa Sheer	P05-505	Light Taupe
Willa Sheer	P05-500	Snow White
Willa Sheer	P05-503	Soft Ivory
Willa Sheer	P05-509	Twilight

Sheer Pleated Price Group B		
Style Name	Color #	Color Name
Lyssa Sheer	P04-405	Blush
Lyssa Sheer	P04-400	Bridal White
Lyssa Sheer	P04-402	Crème
Lyssa Sheer	P04-401	Glacier White
Lyssa Sheer	P04-403	Light Lemon
Lyssa Sheer	P04-407	Tea

SHEER PLEATED MAXIMUM WIDTHS		% UV BLOCKAGE
Carousel	96"	60
Lyssa	96"	50
Nova	96"	60
Willa	83"	60

Determine the top shade price by using the charts below. Add the sheer pleated, bottom shade, and control option prices together to determine your final price.

GROUP A (Sheer Pleated)

- Nova Sheer (96")
- Willa Sheer (83")

WIDTH TO:	24"	30"	36"	42"	48"	54"	60"	66"	72"	84"	96"
HEIGHT TO:											
36"	\$50	56	61	69	77	84	90	96	104	119	132
42"	53	60	67	77	84	90	98	107	114	130	147
48"	57	64	73	82	90	98	107	116	124	144	161
54"	60	67	78	88	96	106	116	124	136	154	176
60"	62	72	84	92	103	114	123	134	146	168	189
66"	66	77	89	98	112	121	131	145	155	178	204
72"	69	81	92	106	119	129	142	153	166	190	216
78"	73	85	98	111	124	137	150	162	177	204	230
84"	76	89	101	116	130	144	156	171	184	212	241
90"	80	92	107	121	137	151	166	181	197	226	256
96"	82	96	113	127	144	156	174	189	205	236	268

GROUP B (Sheer Pleated)

- Carousel Sheer (96")
- Lyssa Sheer (96")

WIDTH TO:	24"	30"	36"	42"	48"	54"	60"	66"	72"	84"	96"
HEIGHT TO:											
36"	\$59	66	76	84	92	100	109	116	126	143	161
42"	62	70	82	92	100	109	120	129	138	158	178
48"	67	77	88	98	109	120	129	140	151	174	197
54"	70	82	93	106	116	128	140	152	162	187	213
60"	76	87	100	113	123	138	150	162	176	202	229
66"	81	92	107	120	134	147	160	175	187	216	246
72"	84	97	113	127	143	156	171	186	201	232	263
78"	88	101	117	132	151	166	182	198	214	246	279
84"	91	107	123	140	156	174	190	207	223	257	293
90"	96	113	129	147	166	183	200	218	237	273	309
96"	98	116	136	154	174	190	209	229	247	286	325

OPTIONS: NO EXTRA CHARGE

- Extension Brackets
- Spacer Blocks
- End Mount Brackets
- Special Cord Loop Length
- Hold Down Brackets
- Color-Coordinated Rails

CONTROL OPTIONS

A CONTROL OPTION MUST BE SELECTED.

- Cordless Lift & Lock System.....No Charge
- Continuous Cord Loopadd \$49
- Cordless Lift System.....add \$72
- Fabric-Wrapped Rail optionadd \$15

TRILIGHT CONFIGURATION SPECIFICATIONS



TRILIGHT – CONTINUOUS CORD LOOP

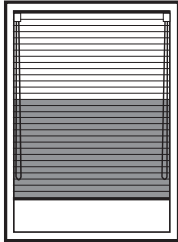

Features same headrail as continuous cord loop system.

Options:

- Color-Coordinated painted rails - no extra charge
 - rails, end caps, cord loops, and cord tensioner will color-coordinate to the bottom (honeycomb) fabric
- Fabric wrapped rails - surcharge applies
 - fabric wrap, end caps, cord loops, and cord tensioner will color-coordinate to the bottom (honeycomb) fabric
- Headrail can be fabric wrapped to match the top (sheer) fabric - surcharge applies
 - Bottomrail, end caps, cord loops, and cord tensioner will color-coordinate to the bottom (honeycomb) fabric

NOTES:

- TriLight Shades with the Continuous Cord Loop option feature a hidden middle rail.
- Right loop control operates the middle rail, left loop control operates the bottomrail.
- TriLight is not available with 3/8" single cell, 3/4" Sheer, 3/4" Semi-Sheer, or Triple Cell fabrics

Cut-outs are not available on TriLight Shades.

CONTINUOUS CORD LOOP SIZE STANDARDS				
	Honeycomb			2" Hybrid Pleat
	All 3/4" Semi-Opaque Fabrics	All 3/4" Blackout Fabrics	All 1/2" Double Cell Fabrics	All Fabrics
Min. Width (net)	24"	24"	24"	24"
Max. Width*	83" - 96"	83" - 96"	83" - 96"	83" - 96"
Max. Width-End Mount	48"	48"	48"	42"
Min. Height	12"	12"	12"	12"
Max. Height	96"	96"	96"	96"
Max. Area (sq. ft.)	64	50	50	60

* The bottom panel fabric width can be reduced by the ordered sheer fabric (top panel), if the sheer max width is less than the bottom panel max width.

FINISHED DIMENSIONS

Adjustments are taken from ordered dimensions.
Measurements may vary +/- 1/8".

	Honeycomb	2" Hybrid Pleat
Inside (IB) Mounts		
Headrail unit	- 1/4"	- 1/4"
Shade height	ordered height	ordered height
Fabric width	- 3/8"	- 7/8"
End (EB) Mounts		
Headrail unit	- 1/2"	- 1/2"
Shade height	ordered height	ordered height
Fabric width	- 5/8"	- 1-1/8"
Outside (OB) Mount		
Headrail unit	ordered width	ordered width
Shade height	ordered height	ordered height
Fabric width	- 1/8"	- 5/8"

MOUNTING REQUIREMENTS

Use a metal tape measure for all measurements.

	Honeycomb	2" Hybrid Pleat
Inside (IB) & End (EB) Mounts		
Minimum mounting depth	3/4"	3/4"
Minimum mounting depth, flush mount:	2-1/8"	2-1/8"
Outside (OB) Mount		
Minimum flat vertical surface	1-1/2"	1-1/2"

NOTE: Inside mount with hold down brackets deductions:
Headrail -1/2"
Fabric -5/8"
Bottomrail -1/2"

FABRIC AND HARDWARE STACKING

- **HONEYCOMB CONTINUOUS CORD LOOP TRILIGHT:** Take 2" for headrail/bottomrail, plus 1/8" for each 12" of honeycomb shade height, plus 1/8" for each 12" of pleated shade height.
- **2" HYBRID PLEAT CONTINUOUS CORD LOOP TRILIGHT:** Take 2" for headrail/bottomrail, plus 1/4" for each 12" of shade height, plus 1/8" for each 12" of pleated shade height. Allow 1-1/2" for fabric fold over.

TRILIGHT CONFIGURATION SPECIFICATIONS



TRILIGHT – CORDLESS

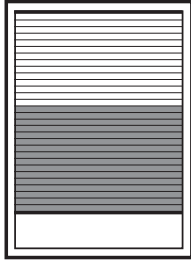

Sheer pleated lifts and lowers from the middle rail. Honeycomb and 2" Hybrid Pleat lift and lower from the bottomrail. No lift cords are necessary.

Options:

- Color-Coordinated painted rails - no extra charge
– Headrail, bottomrail, and middle rail, end caps, cord loops, and handles will color-coordinate to the bottom (honeycomb) fabric
- Fabric wrapped rails - surcharge applies
– fabric wrapped headrail, bottomrail, and middle rail, end caps, cord loops, and handles will coordinate to the bottom (honeycomb) fabric
- Headrail can be fabric wrapped to match the top (sheer) fabric - surcharge applies
– Bottomrail, end caps, cord loops, and handles will color-coordinate to the bottom (honeycomb) fabric



NOTES:

- Shades over 42" will have two handles in the middle rail and two handles in the bottomrail.

Cut-outs are not available on TriLight Shades.

CORDLESS LIFT SIZE STANDARDS		
	Honeycomb	2" Hybrid Pleat
	All Fabrics*	All Fabrics
Min. Width (net)	16"	16"
Max. Width**	84" - 96"	84" - 96"
Max. Width – End Mount	48"	42"
Min. Height	12"	12"
Max. Height	84"	84"
Max Area (sq. ft.)	70	60

* 3/8" single, sheer/semi-sheer and triple cell fabrics are not available with TriLight.

**The bottom panel max. width can be reduced by the ordered sheer fabric (top panel), if the sheer max. width is less than the bottom panel max. width. Willa Sheer maximum width is 83".

See sheer pleated maximum width limitations.

FINISHED DIMENSIONS

Adjustments are taken from ordered dimensions.
Measurements may vary +/- 1/8".

	Honeycomb	2" Hybrid Pleat
Inside (IB) Mounts		
Headrail unit	- 1/4"	- 1/4"
Shade height	ordered height	ordered height
Fabric width	- 3/8"	- 3/8"
End (EB) Mounts		
Headrail unit	- 1/2"	- 1/2"
Shade height	ordered height	ordered height
Fabric width	- 5/8"	- 5/8"
Outside (OB) Mount		
Headrail unit	ordered width	ordered width
Shade height	ordered height	ordered height
Fabric width	- 1/8"	- 1/8"

MOUNTING REQUIREMENTS

Use a metal tape measure for all measurements.

	Honeycomb	2" Hybrid Pleat
Inside (IB) & End (EB) Mounts		
Minimum mounting depth	3/4"	3/4"
Minimum mounting depth, flush mount:	2-1/8"	2-1/8"
Outside (OB) Mount		
Minimum flat vertical surface	1-1/2"	1-1/2"

NOTE: Inside mount with hold down brackets deductions:
Headrail -1/2"
Fabric -5/8"
Bottomrail -1/2"

FABRIC AND HARDWARE STACKING

- **HONEYCOMB CORDLESS TRILIGHT:** Take 2" for headrail/bottomrail, plus 1/8" for each 12" of honeycomb shade height, plus 1/8" for each 12" of pleated shade height.
- **2" HYBRID PLEAT CORDLESS TRILIGHT:** Take 2" for headrail/bottomrail, plus 1/4" for each 12" of shade height, plus 1/8" for each 12" of pleated shade height. Allow 1-1/2" for fabric fold over.

TRILIGHT CONFIGURATION SPECIFICATIONS



TRILIGHT – CORDLESS LIFT & LOCK

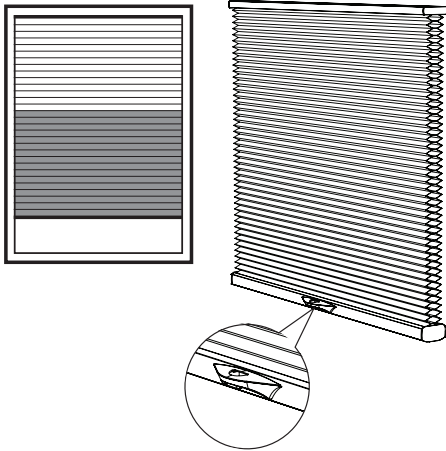

CORDLESS LIFT & LOCK SIZE STANDARDS				
	Honeycomb			2" Hybrid Pleat
	All 3/4" Semi-Opaque Fabrics	All 3/4" Blackout Fabrics	All 1/2" Double Cell Fabrics	All Fabrics
Min. Width (net)	12"	12"	12"	12"
Max. Width	84"	84"	84"	84"
Max. Width - End Mount	48"	48"	48"	42"
Min. Height	12"	12"	12"	12"
Max. Height	84"	84"	84"	84"
Max. Area (sq. ft.)	49	49	49	49

* 3/8" single, 3/4" sheer/semi-sheer and triple cell fabrics are not available with TriLight.
 ** Willa Sheer max. width is 83".

Options:

- Color-Coordinated painted rails - no extra charge
 – Headrail, bottomrail, and middle rail, end caps, cord loops, and handles will color-coordinate to the bottom (honeycomb) fabric
- Fabric wrapped rails - surcharge applies
 – fabric wrapped headrail, bottomrail, and middle rail, end caps, cord loops, and handles will coordinate to the bottom (honeycomb) fabric

Must be specified when order is placed.

FINISHED DIMENSIONS

Adjustments are taken from ordered dimensions.
 Measurements may vary +/- 1/8".

	Honeycomb	2" Hybrid Pleat
Inside (IB) Mounts		
Headrail unit	-1/4"	-1/4"
Shade height	Ordered Height	Ordered Height
Fabric width	-3/8"	-3/8"
End (EB) Mounts		
Headrail unit	-1/2"	-1/2"
Shade height	Ordered Height	Ordered Height
Fabric width	-5/8"	-5/8"
Outside (OB) Mount		
Headrail unit	Ordered Width	Ordered Width
Shade height	Ordered Height	Ordered Height
Fabric width	-1/8"	-1/8"

MOUNTING REQUIREMENTS

Use a metal tape measure for all measurements.

	Honeycomb	2" Hybrid Pleat
Inside (IB) & End (EB) Mounts		
Minimum mounting depth	1-1/4"	1-1/4"
Minimum mounting depth, flush mount:	2-1/4"	2-1/4"
End (OB) Mount		
Minimum flat vertical surface	2"	2"
Outside (OB) Mount		
Minimum flat vertical surface	1"	1"

**Note: Inside mount with hold down brackets deductions:
 Headrail - 1/2", Fabric - 5/8", Bottomrail - 1/2"**

FABRIC AND HARDWARE STACKING

- **HONEYCOMB CORDLESS LIFT & LOCK TRILIGHT:** Take 2-1/4" for bottomrail and intermediate rail, plus 5/8" for headrail, plus 1/8" for each 12" of honeycomb shade height, plus 1/8" for each 12" of pleated shade height.
- **2" HYBRID PLEAT CORDLESS LIFT & LOCK TRILIGHT:** Take 2-1/4" for bottomrail and intermediate rail, plus 5/8" for headrail, plus 1/4" for each 12" of shade height, plus 1/8" for each 12" of pleated shade height. Allow 1-1/2" for fabric fold over.

MOTORIZATION CONFIGURATION SPECIFICATIONS

NOTE: Use metal tape measure for all measurements. Measures to 1/8 inch.

REMOTELIFT™ 2.0 BATTERY-OPERATED MOTORIZATION

- Fits rectangular window openings
- Remote control battery-operated operation
- Two stacking options: 1) standard bottom-up 2) top-down
- Features the same headrail and bottomrail as Cordless Lift, Continuous Cord Loop, and Simplicity. Fabric wrapped rails are available **for a surcharge**. Color-coordinated rails are available **at no additional charge**. Must be specified when ordering.

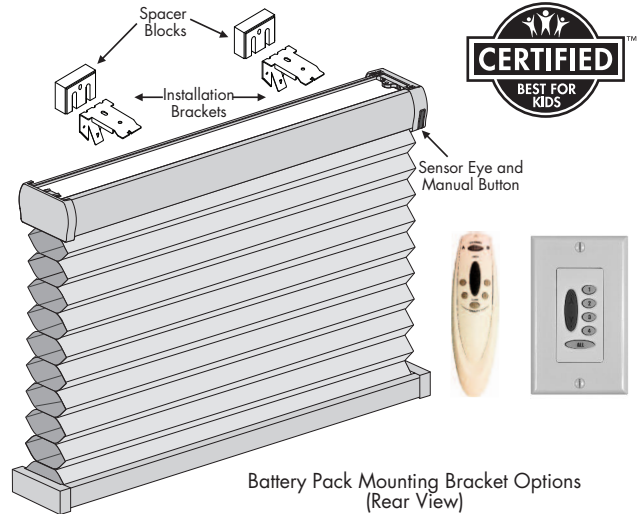

REMOTELIFT 2.0 – SIZE STANDARDS		
	All Honeycomb Fabrics *	2" Hybrid Pleat
Minimum Width	18"	18"
Maximum Width	Refer to chart on page 40	
Max. Width, End Mount	36"	48"
Minimum Height	12"	12"
Maximum Height	Refer to chart on page 40	

* RemoteLift not available with 3/8" triple cell fabrics

** Max square footage for 2" Hybrid Pleat is 60 sq. feet

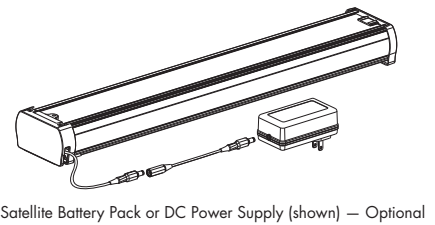
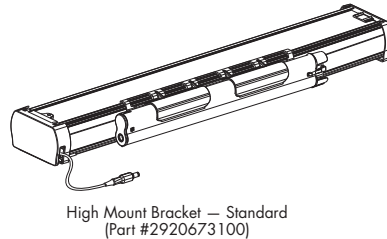
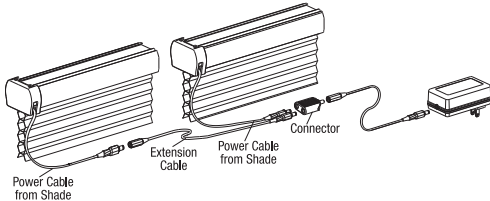

FINISHED DIMENSIONS

Adjustments are taken from ordered dimensions.

	Honeycomb	2" Hybrid Pleat
Inside (IB) Mounts		
Headrail unit	- 1/4"	- 1/4"
Shade height	ordered height	ordered height
Fabric width	- 3/8"	- 3/8"
End (EB) Mounts		
Headrail unit	- 1/2"	- 1/2"
Shade height	ordered height	ordered height
Fabric width	- 5/8"	- 5/8"
Outside (OB) Mount		
Headrail unit	ordered width	ordered width
Shade height	ordered height	ordered height
Fabric width	- 1/8"	- 1/8"

NOTE: Measurements may vary ± 1/8"

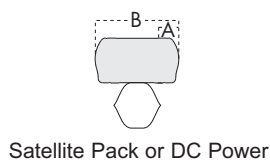
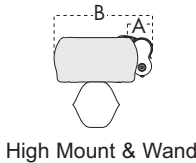

MOUNTING REQUIREMENTS

Use a metal tape measure for all measurements.

	Honeycomb	2" Hybrid Pleat
Inside (IB) & End (EB) Mounts		
Minimum mounting depth	1-1/2"	1-1/2"
Minimum mounting depth, flush mount:	2-7/8"	2-7/8"
Outside (OB) Mount		
Minimum flat vertical surface	1-1/2"	1-1/2"

With (Optional) Satellite Battery Pack or DC Power Supply

Inside (IB) & End (EB) Mounts		
Minimum mounting depth	3/4"	3/4"
Minimum mounting depth, flush mount:	2-1/8"	2-1/8"
Outside (OB) Mount		
Minimum flat vertical surface	1-1/2"	1-1/2"

Inside mount with Hold-Down Bracket deductions: Headrail -1/2"
Fabric -5/8"
Bottomrail -1/2"

REMOTELIFT 2.0 ORDERING NOTES

- Hardware colors will complement the fabric. Refer to the Hardware Color Guide for colors and more information.
- Specify left-side or right-side placement for sensor eye.
- Remote controls are ordered separately. Specify the number of remotes you desire.
- To operate multiple shades independently in Radio Frequency, additional remotes will need to be ordered if you have more than 4 shades.
- If ordering a satellite battery pack, specify wire length – 15", 4', 10' or 20'.
- If ordering the DC power supply, specify wire length – 15", 4', 10' or 20'.
- Daisy-Chain requires the DC power supply and you must specify which wire length (15", 4', 10' or 20') at the time the order is placed. You can Daisy-Chain up to 3 blinds per DC power supply.
- Specify "Channel 2" operation for independent operation of adjacent shades.

MOTORIZATION CONFIGURATION SPECIFICATIONS

REMOTELIFT™ 2.0 SYSTEM OPTIONS

BATTERY WAND

Battery wands are the standard power source whether inside (IB), outside (OB) or end (EB) mount, if applicable. Battery wands are mounted on the rear of the headrail. The redesigned battery wand will allow for batteries to be changed without removing the window covering from the window.

- 12 AA 1.5V alkaline batteries.
- Battery life is approximately one year, depending on usage.
- Replace batteries when the window covering(s) begin to operate slowly.



18V Battery Wand
(Part #7520062000)

SATELLITE BATTERY PACK

The satellite battery pack is an optional power source. The battery pack connects to the same side of the headrail where the receiver eye or satellite eye is located. The satellite battery pack is the best choice when the window covering is mounted in a high window, restricting access to a battery wand.

- 18V satellite battery pack:
 - Available in 15", 4', 10' and 20' wire lengths.
 - 12 AA 1.5V alkaline batteries.
- Battery life is approximately one year, depending on usage.
- Replace batteries when the window covering(s) begin to operate slowly.
- Mounting options: top of headrail, next to molding or under the sill.
- Satellite battery pack cover can be painted.



18V Satellite Battery Pack
(Part #KIT2520)

Wire Part #'s:
15" (Part #2989899000)
4ft (Part #2989900000)
10ft (Part #2989901000)
20ft (Part #2989902000)

DC POWER SUPPLY

The DC power supply is an optional power source. The DC power supply plugs into any standard household outlet.

- 18V DC power supply:
 - Available in 15", 4', 10' and 20' wire lengths.
- Eliminates need to change batteries.

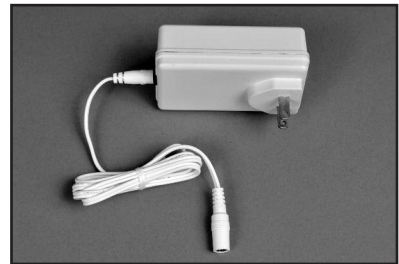

18V DC Power Supply
(Part #7806000000)

DAISY CHAIN

The optional Daisy Chain Adapter allows up to 3 shades to run off of one DC power supply. You must specify the cable wire length when order is placed.

Note: Keep in mind which side the sensor eye is positioned on each side when determining daisy-chain length.



Daisy-Chain Adapter/Connector
(Part #2989875000)

SIZE STANDARDS – REMOTELIFT™ 2.0 MOTORIZATION

REMOTELIFT 2.0 MAXIMUM HEIGHTS – STANDARD AND TOP-DOWN																			
CODE	SHADE WIDTH TO:	24"	30"	36"	42"	48"	54"	60"	66"	72"	78"	84"	90"	96"	108"	120"	132"	144"	
	Max Square Footage:	90 Square Feet														70 Square Feet			
H44	3/8" MARCELLA	108"	108"	108"	108"	108"	108"	108"	108"	108"	108"	108"	108"	108"	108"	108"	76"	70"	
	Max Square Footage:	80 Square Feet														70 Square Feet		50 Square Feet	
H40	3/8" OPULENCE	108"	108"	108"	108"	108"	108"	108"	108"	108"	108"	108"	108"	108"	92"	84"	54"	50"	
	Max Square Footage:	50 Square Feet														30 Square Feet			
H41	3/8" OPULENCE BLACKOUT	108"	108"	108"	108"	108"	108"	108"	108"	100"	90"	84"	80"	74"	40"	36"	n/a		
	Max Square Footage:	50 Square Feet														30 Square Feet			
H91	3/4" CARDIFF SEMI-OPAQUE	108"	108"	108"	108"	108"	108"	108"	108"	100"	90"	84"	80"	74"	40"	36"	n/a		
	Max Square Footage:	80 Square Feet														65 Square Feet		40 Square Feet	
HS3	3/4" GLIMMER SEMI OPAQUE	108"	108"	108"	108"	108"	108"	108"	108"	108"	108"	108"	108"	108"	86"	78"	42"	40"	
	Max Square Footage:	80 Square Feet														60 Square Feet		40 Square Feet	
H27	3/4" LINEN	108"	108"	108"	108"	108"	108"	108"	108"	108"	108"	108"	108"	108"	80"	72"	42"	40"	
	Max Square Footage:	80 Square Feet														75 Square Feet		45 Square Feet	
H45	3/4" MARCELLA	108"	108"	108"	108"	108"	108"	108"	108"	108"	108"	108"	108"	108"	100"	90"	48"	44"	
	Max Square Footage:	80 Square Feet														75 Square Feet		45 Square Feet	
HX6	3/4" Melodic Semi-Opaque	108"	108"	108"	108"	108"	108"	108"	108"	108"	108"	108"	108"	108"	100"	90"	48"	44"	
	Max Square Footage:	80 Square Feet														75 Square Feet		45 Square Feet	
H92	3/4" Mirada Semi-Opaque	108"	108"	108"	108"	108"	108"	108"	108"	108"	108"	108"	108"	108"	100"	90"	48"	44"	
	Max Square Footage:	80 Square Feet														60 Square Feet		40 Square Feet	
H28	3/4" OPULENCE	108"	108"	108"	108"	108"	108"	108"	108"	108"	108"	108"	108"	108"	80"	72"	42"	40"	
	Max Square Footage:	80 Square Feet														60 Square Feet		40 Square Feet	
H96	3/4" PEACEFUL SEMI-OPAQUE	108"	108"	108"	108"	108"	108"	108"	108"	108"	108"	108"	108"	108"	80"	72"	42"	40"	
	Max Square Footage:	80 Square Feet														60 Square Feet		40 Square Feet	
HF6	3/4" RADIANCE SEMI-OPAQUE	108"	108"	108"	108"	108"	108"	108"	108"	108"	108"	108"	108"	108"	80"	72"	42"	40"	
	Max Square Footage:	30 Square Feet																	
H62	3/4" SERENE FR	108"	108"	108"	102"	90"	80"	72"	64"	60"	54"	50"	48"	44"	n/a				
	Max Square Footage:	35 Square Feet																	
H46	3/4" MARCELLA BLACKOUT	108"	108"	108"	108"	104"	92"	84"	76"	70"	64"	60"	56"	52"	n/a				
	Max Square Footage:	35 Square Feet																	
H29	3/4" OPULENCE BLACKOUT	108"	108"	108"	108"	104"	92"	84"	76"	70"	64"	60"	56"	52"	n/a				
	Max Square Footage:	35 Square Feet																	
HF7	3/4" RADIANCE BLACKOUT	108"	108"	108"	108"	104"	92"	84"	76"	70"	64"	60"	56"	52"	n/a				
	Max Square Footage:	30 Square Feet																	
H60	3/4" SERENE FR BLACKOUT	108"	108"	108"	102"	90"	80"	72"	64"	60"	54"	50"	48"	44"	n/a				
	Max Square Footage:	90 Square Feet														55 Square Feet			
H25	3/4" TIFFANY SHEER	108"	108"	108"	108"	108"	108"	108"	108"	108"	108"	108"	108"	108"	108"	108"	60"	54"	
	Max Square Footage:	50 Square Feet														35 Square Feet			
H24	3/4" TRANQUILITY SEMI-SHEER	108"	108"	108"	108"	108"	108"	108"	108"	100"	90"	84"	80"	74"	46"	42"	n/a		
	Max Square Footage:	45 Square Feet														30 Square Feet			
H47	1/2" MARCELLA DOUBLE CELL	108"	108"	108"	108"	108"	108"	108"	98"	90"	82"	76"	72"	68"	40"	36"	n/a		
	Max Square Footage:	40 Square Feet														25 Square Feet			
H39	1/2" OPULENCE DOUBLE CELL	108"	108"	108"	108"	108"	106"	96"	86"	80"	72"	68"	64"	60"	32"	30"	n/a		
	Max Square Footage:	35 Square Feet																	
HPF	2" HYBRID PLEAT - SEMI-OPAQUE	108"	108"	108"	108"	104"	92"	84"	76"	70"	64"	60"	56"	52"	n/a				
	Max Square Footage:	30 Square Feet																	
HPR	2" HYBRID PLEAT - BLACKOUT	108"	108"	108"	102"	90"	80"	72"	64"	60"	54"	50"	48"	44"	n/a				

NOTE: TRIPLE CELL FABRICS NOT AVAILABLE WITH REMOTELIFT 2.0.

NOTE: SPECIFICATIONS HAVE BEEN UPDATED. PLEASE REVIEW WHEN ORDERING.

REMOTELIFT 2.0

RemoteLift 2.0 uses a combination of two different types of wireless signals to control window coverings: radio waves and an infrared signal.

By combining these two signal methods, RemoteLift 2.0 gives consumers the best features and control in the industry. Whether opening a single window covering or partially closing a roomful of coverings at the same time, RemoteLift 2.0 provides the ultimate in control.

WHAT IS RADIO FREQUENCY?

Radio frequency (RF) in today's world simply refers to the use of radio waves of a given frequency to wirelessly send data from a transmitter to a receiver. RemoteLift 2.0 uses radio waves in the 2.4GHz (pronounced "gigahertz") frequency range to send commands from the remote or to the receiver at the window covering.

Radio waves, due to their nature, pass through solid objects and radiate in every direction. That means a remote sending an RF signal does not need to be pointed at a window covering in order to control it. The remote does not have to be in the same room as the window covering it operates nor does the satellite eye need to be visible.

People use products that send radio frequency signals every day. From cell phones and keyless car FOBs, to baby monitors and even garage door openers. Each device sends out RF signals (radio waves) to a receiver on the other end. If the receiver on the other end doesn't "hear" the signal being sent, nothing happens (or a cell phone call gets dropped).

Operational Distance of Radio Waves

Range of operation may vary due to common household construction, layout and other wireless devices in the home. Much like reception with a cell phone, there may be better locations within a home to use radio frequency than others.

WHAT IS INFRARED?

An infrared (IR) signal uses an invisible beam of energy to send commands from a limited distance (usually less than 30 feet) to an electronic device. Similar to a flashlight, a clear line of sight between the device sending the signal and the device receiving the signal is necessary. Likewise, an infrared beam reflects off solid surfaces, bouncing around a room, which could activate a window covering unintentionally.

Products that use an infrared signal as a means of communication are so common, people seldom think about it. The most common device that uses an infrared signal sent from a remote in today's world is the television. By pointing the TV remote at the television and pressing a button, the television responds by changing channels, changing the volume level or powering off.

Operational Distance of Infrared Signals

The maximum operational distance an infrared signal can travel is 30 feet or less in a straight line. There cannot be any physical obstructions (like a drapery, top-treatment or cornice) between the remote and the receiver eye.

Also, an infrared signal can be compromised by direct sunlight or bright interior light. Keep all infrared receivers out of direct sunlight for better operation.

REMOTELIFT™ 2.0 MOTORIZATION: OVERVIEW

REMOTELIFT 2.0

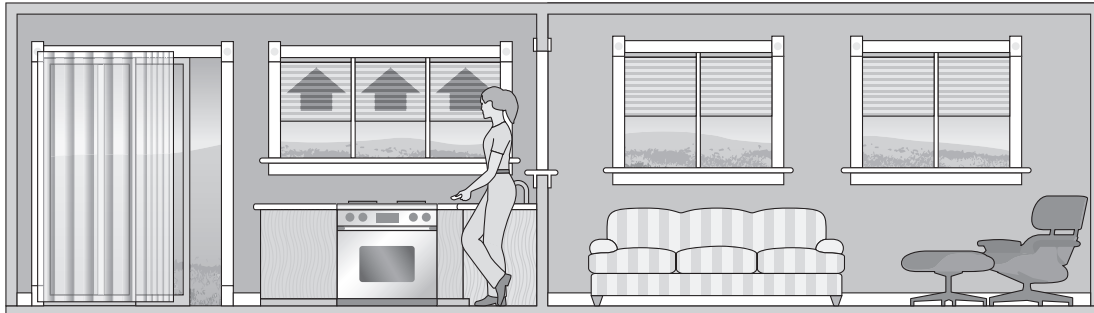

Operation of a group of window coverings using radio frequency.

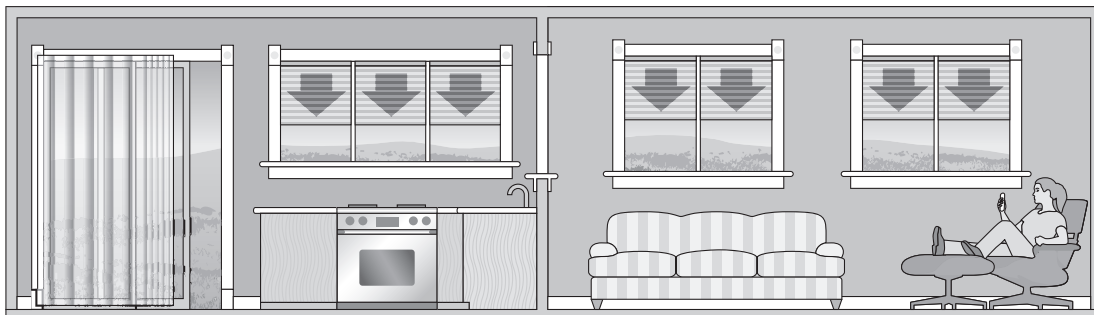

Operation of multiple groups of window coverings using radio frequency.

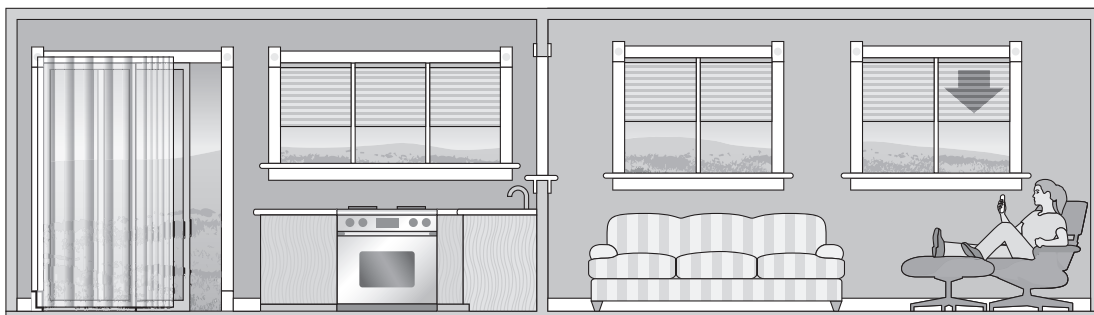

Operation of a single window covering using infrared or radio frequency.

SIMPLICITY MOTORIZATION SPECIFICATIONS POWERWAND™ MOTORIZATION SPECIFICATIONS

SIMPLICITY AND POWERWAND MOTORIZATION



- Features the same headrail and bottomrail as Cordless Lift, Continuous Cord Loop, and RemoteLift 2.0. Fabric wrapped rails are available for a **surcharge**. Color-coordinated rails are available at **no additional charge**. Must be specified when ordering.

SIMPLICITY & POWERWAND - SIZE STANDARDS		
	All Honeycomb Fabrics *	2" Hybrid Pleat **
Minimum Width	18"	18"
Maximum Width	96"	96"
Maximum Width, End Mount	36"	36"
Minimum Height	12"	12"
Maximum Height	96"	96"

* **Simplicity not available with 3/8" triple cell fabrics**

** **PowerWand not available with 3/8" triple cell or 2" Hybrid Pleat fabrics**

NOTE: Size Standards are the same for standard Simplicity, Rechargeable Simplicity, and PowerWand

NOTE: Max height varies by width and fabric type. Refer to chart on page 47

SIMPLICITY 2-on-1 HEADRAIL - SIZE STANDARDS		
	All Honeycomb Fabrics *	2" Hybrid Pleat **
Minimum Width (per panel)	20"	20"
Minimum Width (overall)	40"	40"
Maximum Width (per panel)	96"	96"
Maximum Width (overall)	144"	144"
Maximum Width, End Mount (per panel)	36"	36"
Minimum Height	12"	12"
Maximum Height	96"	96"

* **Simplicity not available with 3/8" triple cell fabrics**

NOTE: Simplicity 2-on-1 ONLY available with Rechargeable battery. Not available with either standard Simplicity or PowerWand

FINISHED DIMENSIONS

Adjustments are taken from ordered dimensions.

	Honeycomb	Hybrid Pleat
Inside (IB) Mounts		
Headrail unit	- 1/4"	- 1/4"
Shade height	ordered height	ordered height
Fabric width	- 3/8"	- 3/8"
Outside (OB) Mount		
Headrail unit	ordered width	ordered width
Shade height	ordered height	ordered height
Fabric width	- 1/8"	- 1/8"
End (EB) Mount		
Headrail unit	- 1/2"	ordered width
Shade height	ordered height	ordered height
Fabric width	- 5/8"	- 1/8"

Simplicity Rechargeable ONLY

2-on-1 Headrail		
Gap between panels	-1/4"	-1/4"

NOTE: Measurements may vary ± 1/8"

MOUNTING REQUIREMENTS

Use a metal tape measure for all measurements.

Honeycomb & Hybrid Pleat	
Inside (IB) Mount	
Minimum mounting depth	3/4"
Minimum mounting depth, flush mount:	2-1/8"
Outside (OB) Mount	
Minimum flat vertical surface	1-1/2"

STANDARD SIMPLICITY MOTORIZATION: OVERVIEW

Standard Simplicity Motorization

- Standard Simplicity Motorization features either a battery powered motor utilizing a single battery wand or plug-in DC transformer. Simplicity motors are compact and use a radio controlled remote to raise or lower the shades.
- Either batteries or 12 Volt DC power supply/transformer is available. The battery wand can be clipped to the headrail or wall or ceiling mounted utilizing battery wand clips. The 12 volt battery wand measures 17", and comes with eight AA alkaline batteries, and is white in color. The battery wire is 10" long. The DC power supply is white and comes with a 80" wire, must be plugged into a standard outlet to power the motor and can power a single shade.
- A 48" extension wire is available (Part #CS5133Z).



SIMPLICITY RECHARGEABLE MOTORIZATION: OVERVIEW

Simplicity Rechargeable

- The Rechargeable Simplicity motor program features an integrated rechargeable lithium ion battery in the motor casing and is fully concealed by the inner tube.
- Rechargeable battery is included with the motor. The average battery charge will last 6-12 months based on an average sized shade raised and lowered once per day. The life of the battery charge will vary based on the type of window covering selected, the size and weight of the window covering and the number of times the shade is operated on a daily basis. The battery can be recharged up to 500 times. It takes approximately 5 hours to recharge the motor when fully depleted.

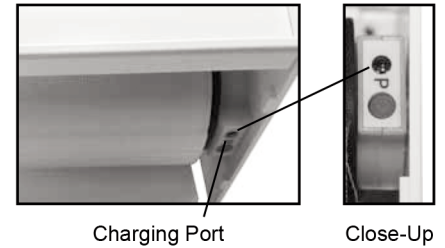

Battery Charger

- An 8.4 Volt charger requires a standard power outlet to recharge the battery. The charger must be specified when ordering Simplicity Rechargeable Motorized shade option. The charger plugs into the charging port of the motor. The charger is black and comes with a 156" wire. The dimensions are 1" wide x 2-1/2" length x 1-3/4" deep. Sold separately.



(Part #CS5199)

Solar Panel Recharge Option

- Plugs in to any Simplicity Rechargeable motorized shading (does not work with PowerWand™). Provides constant trickle charge to 7.4v Li-ION Rechargeable battery packs. Does not require direct sunlight, but performs best in regular direct sunlight applications. Will prolong the life of the charge of the 7.4v rechargeable battery packs, and in some applications will maintain charge indefinitely.
- Life of charge is subject to application variables such as, size and weight of shade, frequency of use, amount of direct sunlight exposure, etc.



(Part #CS52096)
Dimensions of panel
18½" x 1½"

5 Channel Remote

- The remote can operate up to five shadings simultaneously, individually or in groups. Remotes and holders are available in white or black. The remote comes with a holder which can be mounted to a wall for easy storage. The range of the remote is approximately 80 feet.



White
(Part #CS5138W)

Black
(Part #CS5138)

Please Note:

- Not all motors run at the same rate of speed.
- Simplicity motors have a "Favorites" position setting. To set a "Favorites" position, follow instructions provided in the installation instructions.

POWERWAND™ MOTORIZATION: OVERVIEW

PowerWand™ Motorization

- Honeycomb Shades can be fabricated with the PowerWand™ Rechargeable Push Button Control option. The PowerWand™ Rechargeable option is an easy, cord free motorized operation for the budget savvy homeowner. PowerWand™ Rechargeable uses Simplicity motors and components.

PowerWand™ Rechargeable Shades Operation

- Press the up or down button on the pendant to raise or lower the shading to your desired position. No programming is required with PowerWand™ as upper and lower limits are set at the factory. If desired, upper and lower limits can be adjusted in the field.
- Please refer to the installation instructions for instructions on resetting the upper and lower limits and setting a favorites position can be programmed on-site.

PowerWand™ Appearance

- The PowerWand™ Rechargeable wand and pendant is attached to the head rail and requires no additional mounting.
- The wand and pendant hangs down the front of the shades from the head rail.
- Pendant is 2-1/2" long.
- The pendant does not need to be mounted to the wall to operate the shade.



PowerWand™ Options

- Wand is available in Black or White (there is no default)
- Wand is available in 1 foot increments from 1 to 5 feet (there is no default)
- Wand is available on either the right or left side of the shade (there is no default)

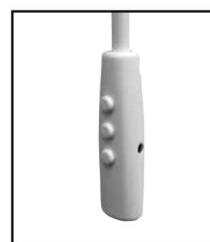

White



Black Shown with Plug-In Charger

PowerWand™ Battery Life

- The battery life will vary based on the type of window covering selected, the size and weight of the window covering and the number of times you operate the blind on a daily basis.

Battery Charger

- 8.4 Volt charger requires a standard power outlet to recharge the battery. The charger must be specified when ordering the PowerWand™ motorization option. The charger plugs into the charger port on the side of the pendant. The charger is black and comes with a 156" wire. The dimensions are 1" wide x 2-1/2" length x 1-3/4" deep.



(Part #CS5199)

SIZE STANDARDS – SIMPLICITY MOTORIZATION

SIMPLICITY MOTORIZATION & POWERWAND MAXIMUM HEIGHTS				
CODE	SHADE WIDTH TO:	18" – 72" *	84"	96"
H44	3/8" Marcella Semi-Opaque	96"	96"	96"
H40	3/8" Opulence Semi-Opaque	96"	96"	96"
H41	3/8" Opulence Blackout	96"	96"	96"
H91	3/4" Cardiff Semi-Opaque	96"	90"	72"
HS3	3/4" Glimmer Semi Opaque	96"	96"	96"
H27	3/4" Linen Semi-Opaque	96"	96"	96"
H45	3/4" Marcella Semi-Opaque	96"	96"	96"
HX6	3/4" Melodic Semi-Opaque	96"	90"	72"
H92	3/4" Mirada Semi-Opaque	96"	90"	72"
H28	3/4" Opulence Semi-Opaque	96"	90"	72"
H96	3/4" Peaceful Semi-Opaque	96"	90"	72"
HF6	3/4" Radiance Semi-Opaque	96"	90"	72"
H60	3/4" Serene FR Semi-Opaque	96"	90"	72"
H46	3/4" Marcella Blackout	96"	90"	72"
H29	3/4" Opulence Blackout	96"	90"	72"
HF7	3/4" Radiance Blackout	96"	90"	72"
H62	3/4" Serene FR Blackout	96"	90"	72"
H25	3/4" Tiffany Sheer	96"	96"	96"
H24	3/4" Tranquility Semi-Sheer	96"	90"	72"
H39	Opulence 1/2" Double Cell	96"	90"	72"
H47	1/2" Marcella Double Cell	96"	96"	96"
HPF	2" Hybrid Pleat Semi-Opaque**	96"	96"	96"
HPR	2" Hybrid Pleat - Blackout**	96"	90"	72"

* 2-on-1 Minimum Panel Width 20" (available with Simplicity Rechargeable ONLY)

****2" Hybrid Pleat is Not Available with PowerWand Motorization**

NOTE: Triple Cell fabric is not Available with motorization

HONEYCOMB VERTICAL APPLICATION A

• 3/4" Marcella (H45) • 3/4" Radiance (HF6)

WIDTH TO:	24"	30"	36"	42"	48"	54"	60"	66"	72"	78"	84"	96"	108"	120"	132"	144"	156"	168"
HEIGHT TO:																		
36"	\$374	404	441	473	504	536	569	600	634	667	694	755	813	868	916	971	1026	1086
42"	399	436	474	512	546	584	623	658	692	730	762	822	878	944	997	1064	1126	1200
48"	425	465	509	550	588	628	668	715	747	784	824	888	948	1034	1081	1152	1206	1286
54"	446	497	542	589	629	667	709	751	790	826	868	934	1009	1084	1154	1222	1300	1378
60"	473	525	576	627	667	709	754	797	840	883	922	1003	1082	1164	1234	1316	1398	1488
66"	501	554	607	666	713	754	800	849	891	941	982	1072	1157	1244	1321	1415	1501	1610
72"	528	585	645	705	752	795	841	903	946	994	1044	1141	1227	1323	1409	1509	1606	1719
78"	556	615	681	736	787	830	883	944	988	1045	1092	1197	1289	1390	1482	1585	1691	1809
84"	584	646	714	772	829	878	933	995	1043	1104	1154	1264	1368	1470	1565	1681	1789	1919
90"	606	678	745	807	866	922	979	1047	1100	1161	1217	1334	1443	1554	1658	1773	1893	2024
96"	634	707	772	838	899	957	1018	1090	1145	1212	1266	1392	1501	1622	1736	1849	1977	2108
102"	660	735	807	871	933	1001	1071	1137	1204	1266	1324	1458	1580	1699	1817	1944	2080	2225
108"	686	764	839	908	975	1041	1118	1195	1258	1329	1390	1528	1654	1783	1908	2039	2184	2337
114"	714	793	870	946	1013	1083	1164	1243	1314	1385	1448	1602	1734	1866	2002	2129	2290	2437
120"	736	824	933	1010	1081	1156	1240	1324	1396	1473	1531	1690	1828	1969	2106	2243	2402	2556

- 3/4" Cardiff (H91)
- 3/4" Glimmer (HS3)
- 3/4" Linen (H27)
- 3/4" Marcella Blackout (H46)
- 3/4" Melodic (HX6)
- 3/4" Mirada (H92)
- 3/4" Opulence (H28)
- 3/4" Radiance Blackout (HF7)
- 3/4" Serene (H62)

HONEYCOMB VERTICAL APPLICATION B

WIDTH TO:	24"	30"	36"	42"	48"	54"	60"	66"	72"	78"	84"	96"	108"	120"	132"	144"	156"	168"
HEIGHT TO:																		
36"	\$439	474	519	557	591	629	669	707	746	784	817	887	956	1018	1075	1139	1204	1278
42"	468	511	558	602	643	684	729	772	814	858	895	965	1034	1108	1172	1251	1323	1411
48"	498	544	598	646	689	738	786	840	877	922	967	1045	1113	1213	1270	1354	1418	1511
54"	525	583	635	691	740	784	832	883	927	971	1018	1098	1186	1277	1356	1438	1527	1619
60"	556	615	678	736	784	832	887	935	987	1037	1083	1176	1273	1368	1451	1547	1643	1750
66"	589	650	715	783	837	887	941	1001	1048	1105	1157	1260	1360	1462	1552	1662	1766	1892
72"	621	686	756	829	884	933	989	1061	1110	1168	1227	1341	1442	1554	1657	1773	1888	2023
78"	652	722	798	864	925	975	1037	1108	1162	1229	1283	1406	1515	1634	1740	1863	1988	2127
84"	684	759	839	909	973	1034	1096	1169	1225	1297	1356	1487	1609	1730	1841	1976	2105	2258
90"	714	795	875	948	1017	1082	1152	1231	1293	1364	1430	1570	1697	1827	1948	2083	2226	2381
96"	745	830	908	983	1055	1127	1198	1279	1347	1425	1489	1636	1767	1909	2039	2176	2324	2478
102"	775	864	948	1022	1097	1174	1256	1337	1416	1490	1556	1714	1857	1997	2137	2285	2445	2615
108"	807	899	986	1067	1145	1223	1316	1403	1480	1562	1634	1797	1945	2096	2244	2399	2567	2746
114"	838	932	1020	1110	1191	1275	1368	1461	1544	1629	1701	1879	2036	2194	2356	2507	2693	2865
120"	864	967	1096	1186	1270	1359	1457	1555	1642	1734	1799	1987	2150	2314	2477	2636	2823	3007

IMPORTANT NOTE:

3/4" Serene FR Semi-opaque (H62) and 3/4" Serene FR Blackout (H60) fabrics do not meet the NFPA 701 flammability requirements when used in a Vertical Application.

OPTIONS: NO EXTRA CHARGE
• Vertical Application – Left or Right stack location

VERTICAL APPLICATION STACK DESIGN SURCHARGES
• Center Opening – Price as two separate shades.
• Center Stackingadd \$60 each

HONEYCOMB VERTICAL APPLICATION C

- 3/4" Opulence Blackout (H29)
- 3/4" Serene Blackout (H60)

WIDTH TO:	24"	30"	36"	42"	48"	54"	60"	66"	72"	78"	84"	96"	108"	120"	132"	144"	156"	168"
HEIGHT TO:																		
36"	\$510	563	623	676	720	753	799	845	888	933	974	1057	1165	1255	1345	1442	1534	1598
42"	554	615	681	729	778	822	871	922	973	1018	1068	1157	1275	1375	1480	1588	1691	1767
48"	599	658	722	778	830	877	932	989	1044	1095	1150	1251	1377	1490	1606	1721	1836	1921
54"	639	707	775	839	893	953	1012	1075	1134	1196	1253	1363	1504	1629	1755	1888	2011	2110
60"	683	747	825	893	955	1016	1080	1152	1217	1283	1347	1463	1617	1754	1892	2035	2169	2283
66"	721	788	876	954	1016	1082	1146	1228	1295	1370	1439	1567	1734	1879	2028	2183	2330	2450
72"	762	831	923	1010	1076	1146	1222	1305	1375	1458	1532	1673	1851	2010	2167	2337	2496	2628
78"	800	872	975	1065	1137	1215	1297	1383	1461	1550	1630	1774	1962	2136	2309	2485	2656	2800
84"	837	915	1020	1115	1191	1274	1364	1455	1540	1634	1718	1876	2075	2260	2441	2631	2814	2970
90"	875	957	1072	1170	1250	1340	1439	1531	1622	1723	1810	1979	2190	2385	2579	2783	2976	3143
96"	912	1001	1117	1228	1307	1407	1510	1612	1706	1812	1907	2083	2311	2515	2722	2933	3139	3318
102"	950	1044	1167	1277	1361	1474	1581	1688	1784	1899	1993	2176	2408	2625	2842	3063	3283	3474
108"	988	1086	1214	1330	1411	1542	1650	1765	1860	1978	2078	2275	2519	2748	2977	3211	3438	3640
114"	1021	1135	1261	1385	1468	1607	1721	1839	1944	2062	2164	2376	2634	2871	3116	3358	3602	3812
120"	1097	1221	1352	1485	1567	1710	1830	1955	2062	2187	2290	2516	2783	3035	3287	3541	3795	4020

IMPORTANT NOTE:
 3/4" Serene FR Semi-opaque (H62) and 3/4" Serene FR Blackout (H60) fabrics do not meet the NFPA 701 flammability requirements when used in a Vertical Application.

HONEYCOMB VERTICAL APPLICATION D

- 3/4" Peaceful (H96)

WIDTH TO:	24"	30"	36"	42"	48"	54"	60"	66"	72"	78"	84"	96"	108"	120"	132"	144"	156"	168"
HEIGHT TO:																		
36"	\$576	636	705	764	814	850	902	955	1004	1055	1100	1195	1316	1418	1519	1629	1734	1806
42"	627	696	769	824	879	928	985	1041	1099	1150	1207	1307	1440	1554	1673	1794	1911	1996
48"	677	743	816	879	938	990	1053	1118	1180	1237	1299	1414	1556	1684	1815	1945	2074	2171
54"	722	799	876	948	1009	1076	1144	1215	1281	1351	1416	1540	1699	1841	1984	2134	2273	2384
60"	771	845	932	1009	1079	1147	1220	1302	1376	1449	1523	1653	1827	1983	2137	2300	2452	2580
66"	815	891	989	1078	1147	1223	1295	1387	1464	1548	1626	1771	1958	2124	2292	2467	2633	2769
72"	861	939	1043	1141	1216	1295	1380	1474	1554	1648	1731	1891	2091	2272	2449	2641	2821	2970
78"	904	986	1103	1204	1285	1373	1465	1563	1650	1752	1843	2004	2216	2414	2610	2808	3001	3164
84"	946	1034	1153	1260	1346	1439	1542	1644	1739	1846	1941	2120	2345	2554	2759	2972	3180	3357
90"	988	1081	1211	1323	1412	1515	1626	1729	1833	1947	2046	2236	2475	2695	2914	3144	3362	3552
96"	1031	1130	1261	1387	1477	1589	1706	1822	1927	2047	2155	2354	2611	2842	3076	3314	3547	3749
102"	1074	1180	1318	1443	1537	1666	1786	1907	2016	2145	2252	2460	2721	2965	3211	3461	3710	3926
108"	1117	1227	1372	1503	1595	1743	1864	1994	2102	2235	2347	2571	2846	3104	3363	3628	3885	4112
114"	1154	1283	1425	1565	1658	1816	1945	2078	2196	2330	2445	2684	2976	3244	3521	3795	4070	4307
120"	1239	1379	1527	1677	1771	1932	2067	2210	2330	2471	2587	2843	3144	3430	3713	4001	4288	4543

IMPORTANT NOTE:
 3/4" Serene FR Semi-opaque (H62) and 3/4" Serene FR Blackout (H60) fabrics do not meet the NFPA 701 flammability requirements when used in a Vertical Application.

OPTIONS: NO EXTRA CHARGE
<ul style="list-style-type: none"> • Vertical Application – Left or Right stack location

VERTICAL APPLICATION STACK DESIGN SURCHARGES
<ul style="list-style-type: none"> • Center Opening – Price as two separate shades. • Center Stackingadd \$60 each

2" HYBRID PLEAT VERTICAL APPLICATION G

• 2" HYBRID PLEAT – SEMI-OPAQUE (HPF)

WIDTH TO:	24"	30"	36"	42"	48"	54"	60"	66"	72"	84"	96"	108"	120"	132"	144"	156"	168"
HEIGHT TO:																	
36"	\$380	454	455	481	498	532	551	644	669	716	751	875	986	1084	1182	1289	1384
42"	429	462	472	495	519	545	571	666	692	745	778	896	1014	1115	1216	1325	1425
48"	450	477	485	524	571	577	597	710	728	784	825	946	1084	1193	1301	1418	1524
54"	467	505	509	545	592	596	619	733	758	810	849	981	1108	1220	1330	1449	1557
60"	470	520	521	571	615	618	641	755	780	844	888	1025	1158	1274	1388	1513	1627
66"	505	551	553	584	615	630	653	780	801	861	917	1056	1193	1313	1431	1559	1676
72"	517	575	575	610	627	661	685	823	839	917	971	1108	1255	1380	1504	1641	1763
78"	597	653	663	692	717	752	780	819	842	912	975	1120	1263	1391	1516	1651	1776
84"	614	670	683	714	745	780	809	849	878	949	1019	1169	1313	1443	1574	1716	1844
90"	636	696	698	729	759	802	838	878	909	981	1057	1212	1362	1497	1633	1779	1913
96"	649	714	717	748	778	827	860	900	936	1012	1086	1245	1406	1547	1684	1838	1974
108"	717	800	802	841	883	933	989	1035	1080	1174	1269	1450	1630	1793	1955	2129	2290
120"	770	866	899	946	993	1053	1111	1173	1225	1329	1440	1643	1839	2023	2205	2403	2584

2" HYBRID PLEAT VERTICAL APPLICATION H

• 2" HYBRID PLEAT – BLACKOUT (HPR)

WIDTH TO:	24"	30"	36"	42"	48"	54"	60"	66"	72"	84"	96"	108"	120"	132"	144"	156"	168"
HEIGHT TO:																	
36"	\$432	460	465	491	509	543	563	659	682	732	764	893	1005	1105	1205	1313	1411
42"	441	473	480	505	528	558	580	684	707	759	793	916	1037	1141	1244	1355	1457
48"	458	488	495	530	593	599	607	724	743	800	841	963	1106	1217	1325	1446	1554
54"	474	518	517	559	611	607	628	748	772	827	868	1004	1133	1246	1359	1480	1590
60"	480	528	530	580	647	634	652	771	798	861	902	1043	1177	1295	1411	1540	1654
66"	512	564	564	595	651	646	668	800	817	881	933	1076	1215	1337	1457	1587	1706
72"	528	587	588	619	661	673	697	839	855	934	987	1130	1278	1406	1532	1671	1796
78"	611	666	675	705	732	769	797	836	861	931	994	1142	1285	1414	1541	1680	1806
84"	662	727	741	776	813	855	891	934	969	1053	1130	1294	1453	1598	1740	1899	2040
90"	728	801	808	846	883	932	972	1021	1058	1146	1234	1416	1591	1751	1908	2080	2236
96"	799	896	912	962	1010	1076	1128	1190	1242	1354	1462	1671	1880	2069	2255	2457	2642
108"	870	994	1014	1080	1142	1217	1301	1369	1437	1576	1718	1955	2190	2410	2626	2862	3077
120"	923	1072	1135	1214	1286	1379	1466	1555	1637	1789	1958	2227	2480	2728	2975	3242	3485

OPTIONS: NO EXTRA CHARGE

- Vertical Application – Left or Right stack location

VERTICAL APPLICATION STACK DESIGN SURCHARGES

- Center Opening – Price as two separate shades.
- Center Stackingadd \$60 each

VERTICAL APPLICATION CONFIGURATION SPECIFICATIONS

NOTE: Use metal tape measure for all measurements. Measures to 1/8 inch.

VERTICAL APPLICATION

- Fits rectangular window and door openings
- Opens and closes from side to side; ideal for sliding glass doors & French doors

• Four fabric stacking options:

- 1) left stack
- 2) right stack
- 3) center opening ("split stack")
- 4) center stack

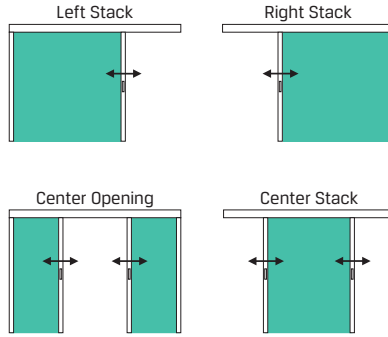

Top Rail Dimensions

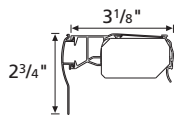

VERTICAL APPLICATION – SIZE STANDARDS				
	Honeycomb			2" Hybrid Pleat
	Sheer Fabric	All Other 3/4" Fabrics	All 3/4" Blackout Fabrics	All Fabrics
Min. Width	12"	12"	12"	12"
Max. Width Side Stack	120"	168"	168"	168"
Max. Width Split Stack	168"	190"	190"	190"
Min. Height	24"	24"	24"	24"
Max. Height	120"	120"	120"	120"
Max Sq. ft. Side Stack	100	140	120	100
Max Sq. ft. Split Stack	100	140	140	120

Vertical Application not available with any 3/8", 3/8" blackout, 3/4" semi sheer, 1/2" double cell, or 3/8" triple cell fabrics

NOTE: Stack is 6-1/2" space per side when fully opened, regardless of shade width.

FINISHED DIMENSIONS

Adjustments are taken from ordered dimensions.

	Honeycomb	2" Hybrid Pleat
Inside (IB) Mount		
Headrail unit	– 3/16"	– 3/16"
Shade height	– 1/2"	– 1/2"
Valance width (non-flush)	+ 1-1/4"	+ 1-1/4"
Valance width (flush)	– 1/8"	– 1/8"
Outside (OB) Mount		
Headrail unit	– 3/16"	– 3/16"
Shade height	ordered height	ordered height
Valance width	+ 1"	+ 1"
Standard Returns		
Outside Mount	3-1/8"	4-1/4"
Inside Non Flush Mount *	1-1/2"	1-1/2"

NOTE: Measurements may vary ± 1/8"

MOUNTING REQUIREMENTS

Use a metal tape measure for all measurements.

	Honeycomb	2" Hybrid Pleat
Inside (IB) Mount		
Minimum mounting depth	15/16"	15/16"
Minimum mounting depth, flush mount:	3-5/8"	4-1/2"
Outside (OB) Mount		
Minimum flat vertical surface	5/8"	5/8"

*For each spacer block, 1/2" will be added to the length of the valance returns. For extension brackets, 2" will be added unless otherwise specified.

HARDWARE COLOR

- Hardware colors are currently limited to 10. Refer to the Hardware Color Guide for colors and more information.

EXCLUSIONS

- All 3/8" styles, 3/4" Semi Sheer, Double Cell, or Triple Cell honeycomb styles.

VERTICAL APPLICATION ORDERING NOTES

- Specify inside (IB), outside (OB), inside non flush mount or flush mount.
- Specify stacking configuration – left stack, right stack, center opening, or center stack. On split stack shades, both panels will be of equal width, unless otherwise specified. Center stacks are a surcharge option.
- Inside non flush mount valance returns are 1-1/2" if returns are selected*
- Standard handle height is 40" to 50" from bottom of moving rail; specify any desired variation from this standard.
- Standard installation hardware (brackets) provided.

- Specify no-charge installation hardware:
 - Spacer blocks
 - Extension brackets
 - Shims (OB)
- Also refer to vertical application measuring in "General Information" section.

NOTE: Cut-outs can be done on movable and stationary rail. 1" is the only cut-out width available for Vertical Application shades. 6" is the maximum cut-out height and the height is measured from the floor to the top of the desired cut-out location.

Cut-outs are not available on 2" Hybrid Pleat.

HONEYCOMB CLASSIC SKYLIGHT A

• 3/8" Marcella (H44) • 3/4" Marcella (H45) • 3/4" Radiance (HF6)

WIDTH TO:	24"	30"	36"	42"	48"	54"	60"	66"	72"
HEIGHT TO:									
36"	\$238	270	301	340	366	405	436	471	499
42"	249	287	326	363	401	438	474	503	535
48"	263	308	345	386	436	471	514	551	580
54"	282	327	370	413	470	497	551	588	624
60"	291	347	395	441	505	540	590	641	
66"	309	366	417	471	534	572	620		
72"	322	385	441	495	558	600	659		

Prices in the 66" and 72" columns apply to side stack

↖ Skylight with Simplicity Motorization Maximum Width: 48"

HONEYCOMB CLASSIC SKYLIGHT B

- 3/8" Opulence (H40)
- 3/4" Cardiff (H91)
- 3/4" Glimmer (HS3)
- 3/4" Linen (H27)
- 3/4" Melodic (HX6)
- 3/4" Mirada (H92)
- 3/4" Opulence (H28)
- 3/4" Serene FR (H62)
- 1/2" Marcella (H47)

WIDTH TO:	24"	30"	36"	42"	48"	54"	60"	66"	72"
HEIGHT TO:									
36"	\$279	317	354	399	428	475	511	554	585
42"	293	335	384	426	471	513	557	590	628
48"	310	360	405	452	511	551	603	649	684
54"	332	385	436	485	550	583	649	692	736
60"	342	408	460	518	593	632	694	749	
66"	362	428	490	554	624	670	730		
72"	378	450	518	581	654	704	775		

Prices in the 66" and 72" columns apply to side stack

↖ Skylight with Simplicity Motorization Maximum Width: 48"

OPTIONS: EXTRA CHARGE	
• Classic Skylight Extension Pole (extends 5' to 10')	\$39

SIMPLICITY SURCHARGE AND OPTIONS	
• Simplicity Motorization	add \$277
• 5 Channel Remote Control (White or Black)	add \$46
• 48" Extension Wire	add \$9
• DC Power Supply	add \$38

// Classic Skylight
 // Skylight with Simplicity Motorization



**HONEYCOMB
 CLASSIC SKYLIGHT C**

- 1/2" Opulence (H39)
- 3/4" Marcella Blackout (H46)
- 3/4" Radiance Blackout (HF7)

WIDTH TO:	24"	30"	36"	42"	48"	54"	60"	66"	72"
HEIGHT TO:									
36"	\$292	335	376	417	456	502	541	579	613
42"	312	355	404	450	501	543	588	629	667
48"	325	382	432	482	540	583	637	682	722
54"	353	408	464	514	587	615	686	735	779
60"	365	434	489	546	626	673	738	787	
66"	385	452	515	581	662	712	783		
72"	405	481	544	615	700	752	822		

Prices in the 66" and 72" columns apply to side stack

Skylight with Simplicity Motorization Maximum Width: 48"

**HONEYCOMB
 CLASSIC SKYLIGHT D**

- 3/8" Opulence Blackout (H41)
- 3/4" Serene FR Blackout (H60)
- 3/4" Opulence Blackout (H29)
- 3/4" Tiffany (H25)
- 3/4" Peaceful (H96)
- 3/4" Tranquility (H24)

WIDTH TO:	24"	30"	36"	42"	48"	54"	60"	66"	72"
HEIGHT TO:									
36"	\$341	392	439	485	528	580	626	669	712
42"	365	416	470	525	580	629	682	732	776
48"	384	443	502	558	622	670	735	784	833
54"	405	471	540	597	674	722	787	844	899
60"	420	497	567	631	721	774	842	904	
66"	448	527	607	681	763	827	905		
72"	471	550	636	710	798	869	967		

Prices in the 66" and 72" columns apply to side stack

Skylight with Simplicity Motorization Maximum Width: 48"

OPTIONS: EXTRA CHARGE

- Classic Skylight Extension Pole (extends 5' to 10')\$39

SIMPLICITY SURCHARGE AND OPTIONS

- Simplicity Motorizationadd \$277
- 48" Extension Wireadd \$9
- 5 Channel Remote Control (White or Black)add \$46
- DC Power Supplyadd \$38

CLASSIC SKYLIGHT CONFIGURATION SPECIFICATIONS

NOTE: Use metal tape measure for all measurements. Measures to 1/8 inch.

CLASSIC SKYLIGHT

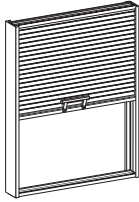

This easy to operate system holds shades in place. Perfect for skylights and other windows beyond reach.

- Hardware color: White
- Manually operated with handle
- Ends of headrail, moving rail and anchor rail are enclosed by side tracks
- Features a two-cell fabric gasket attached to the headrail; eliminates light leakage when shade is closed
- 5' adjustable extension pole – extends to 10'

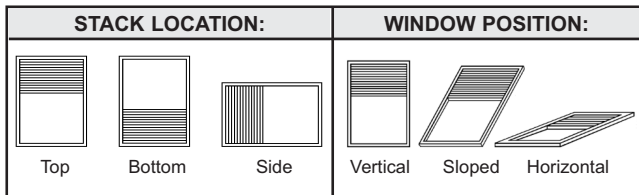

Note: Pleats will have a vertical orientation when side stack is ordered.

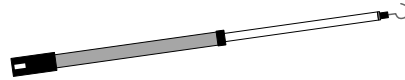

Optional Extension Pole
Extends 5' to 10'
(Part #400036-81511)

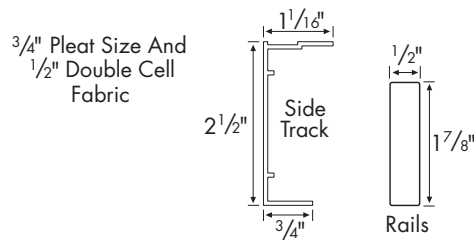
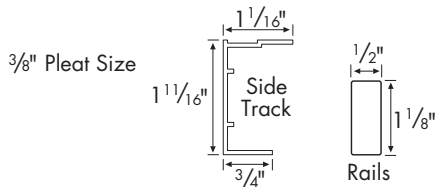

CLASSIC SKYLIGHT – SIZE STANDARDS	
	Honeycomb
	All Fabrics *
Min. Width	18"
Max. Width	60"
Min. Height	6"
Max. Height	72"
Max Area (sq. ft.)	25

* Classic Skylight not available with any 3/8" triple cell or 2" Hybrid Pleat fabrics

NOTE: Shades over 30" wide require support cords.
Rail stiffener is required when shade is over 42" wide.

CLASSIC SKYLIGHT SIDE STACK – SIZE STANDARDS	
	Honeycomb
	All Fabrics *
Min. Width	6"
Max. Width	72"
Min. Height	18"
Max. Height	60"
Max Area (sq. ft.)	25

* Classic Skylight not available with any 3/8" triple cell or 2" Hybrid Pleat fabrics

FINISHED DIMENSIONS

Adjustments are taken from ordered dimensions.

Inside (IB) Mount	
Headrail unit	- 3/16"
Shade height	ordered height
Fabric width	- 3/4"
Outside (OB) Mount	
Headrail unit	+ 3/4"
Shade height	ordered height
Fabric width	ordered width

NOTE: All finished dimensions include side tracks.

NOTE: Measurements may vary ± 1/8"

MOUNTING REQUIREMENTS

Use a metal tape measure for all measurements.

Inside (IB) Mounts	3/8" Single
Minimum mounting depth IB:	1"
Minimum mounting depth, flush mount:	1-11/16"
Outside (OB) Mount	3/8" Single
Minimum flat vertical surface	5/8"
Inside (IB) Mounts	3/4" Single and 1/2" Double
Minimum mounting depth IB:	1-1/4"
Minimum mounting depth, flush mount:	2-1/2"
Outside (OB) Mount	3/4" Single and 1/2" Double
Minimum flat vertical surface	1"

SKYLIGHT WITH SIMPLICITY MOTORIZATION CONFIGURATION SPECIFICATIONS

NOTE: Use metal tape measure for all measurements. Measures to 1/8 inch.

SKYLIGHT WITH SIMPLICITY MOTORIZATION

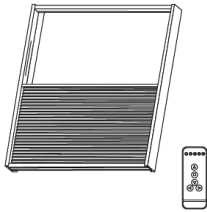

NOTE:

This is a different Skylight system than the Classic Skylight. Key differences include:

- Headrail and Bottomrail are identical and are the same rail used on standard shades with Simplicity Motorization
- Only available with fabric stack at the bottom of the window



SKYLIGHT SIMPLICITY - SIZE STANDARDS	
	All Honeycomb Fabrics *
Minimum Width	18"
Maximum Width	48"
Minimum Height	12"
Maximum Height	72"

* Skylight with Simplicity not available with 3/8" triple cell fabrics or 2" Hybrid Pleat

Features

- Inside Mount only
- White aluminum head and bottom rails. White vinyl side rails
- Use radio frequency controlled Simplicity motors
- The Simplicity wireless remote control operates individual or groups of shades

Operation & Installation Tips

- Shades installed into windows with metal casings may have a reduced radio frequency range, or may not operate at all
- Do not let the antenna on the motor touch any metal objects. This may interfere with signals from the remote control.
- Make sure to leave the top of the headrail open (motor exposed), do not cover; especially with metal materials. This could result in a reduced radio frequency range for the remote control or the shade may not operate at all.
- Skylights with Simplicity Motorization will NOT operate properly if installed in a completely horizontal application. The minimum recommended slope is 5%.

FINISHED DIMENSIONS

Adjustments are taken from ordered dimensions.

Inside (IB) Mount	
Headrail unit	- 3/16"
Shade height	ordered height
Fabric width	- 1-1/4"

NOTE: Measurements may vary $\pm 1/8$ "

HEADRAIL & BOTTOMRAIL DIMENSIONS

Depth of Rail	2"
Depth of Rail & Bracket	2-1/4"
Depth of Rail, Side Tracks & Bracket	2-1/2"
Height of Rail	1-1/2"

MOUNTING REQUIREMENTS

Use a metal tape measure for all measurements.

Inside (IB) Mounts	
Minimum mounting depth IB:	2-1/2"

- Should not be more than 1/2" out of square to perform as intended
- The widest width of the window cannot exceed the narrowest width of the window by more than 3/8"
- The shade must be mounted with the fabric stack at the bottom or the lowest point in the window

HONEYCOMB ARCH A

• 3/8" Marcella (H44) • 3/4" Marcella (H45) • 3/4" Radiance (HF6)

WIDTH TO:	24"	30"	36"	42"	48"	54"	60"	66"	72"	78"	84"
Stationary	\$98	114	129	151	175	199	229	261	294	334	378
Movable*	145	166	189	215	246	283	319	362	405	466	534

*Specify Fan-Fold or Top-Down Movable Arch when ordering

ALL 3/8" FAN-FOLD ARCHES
N/A IN THESE SIZES

- 3/8" Opulence (H40)
- 3/4" Cardiff (H91)
- 3/4" Glimmer (HS3)
- 3/4" Linen (H27)
- 3/4" Melodic (HX6)
- 3/4" Mirada (H92)
- 3/4" Opulence (H28)
- 3/4" Serene FR (H62)
- 1/2" Marcella (H47)

HONEYCOMB ARCH B

WIDTH TO:	24"	30"	36"	42"	48"	54"	60"	66"	72"	78"	84"
Stationary	\$116	131	151	177	204	234	269	306	346	393	443
Movable*	168	193	220	251	288	332	374	425	477	545	626

*Specify Fan-Fold or Top-Down Movable Arch when ordering

ALL 3/8" FAN-FOLD ARCHES
N/A IN THESE SIZES

HONEYCOMB ARCH C

- 1/2" Opulence (H39)
- 3/4" Marcella Blackout (H46)
- 3/4" Radiance Blackout (HF7)

WIDTH TO:	24"	30"	36"	42"	48"	54"	60"	66"	72"	78"	84"
Stationary	\$136	155	177	206	239	275	315	358	407	460	520
Movable*	197	228	259	295	339	390	441	499	559	643	737

*Specify Fan-Fold or Top-Down Movable Arch when ordering

HONEYCOMB ARCH D

- 3/8" Opulence Blackout (H41)
- 3/4" Opulence Blackout (H29)
- 3/4" Serene FR Blackout (H60)
- 3/4" Tiffany (H25)
- 3/4" Tranquility (H24)

WIDTH TO:	24"	30"	36"	42"	48"	54"	60"	66"	72"	78"	84"
Stationary	\$156	181	206	241	279	322	369	420	478	542	610
Movable*	230	268	303	347	396	456	517	584	654	751	866

*Specify Fan-Fold or Top-Down Movable Arch when ordering

ALL 3/8" FAN-FOLD ARCHES
N/A IN THESE SIZES

NOTE: TRIPLE CELL FABRIC NOT AVAILABLE AS A TOP-DOWN ARCH
2" HYBRID AND 3/4" PEACEFUL ARE NOT AVAILABLE AS ARCHES

OPTIONS: EXTRA CHARGE

- Top-Down Movable Arch Extension Pole (extends 5' to 10')\$39
- Arch and Elliptical Arch – price using width on Arch price charts for fabric desired.
- Rectangular Shade and Arch – price as 2 separate shades; One Arch and One Rectangular.

SPECIALTY SIZE STANDARDS & MEASURING INFORMATION

NOTE: Use metal tape measure for all measurements. Measures to 1/8 inch.

ARCHES

Refer to "Extra Charge Options" for Surcharge and Price Information

INSIDE MOUNT

Locate shape below.
Width: Measure exact width(s)
Height: Measure exact height(s)

OUTSIDE MOUNT

Locate shape below.
Width: Measure desired width(s)
Height: Measure desired height(s)

FAN-FOLD ARCHES

NON-MOVABLE ARCH (PERFECT ARCH = EXACT 1/2 CIRCLE, TEMPLATE NOT REQUIRED)

FAN-FOLD STATIONARY PERFECT ARCH

Must be perfect arch.



Come standard with arch disc

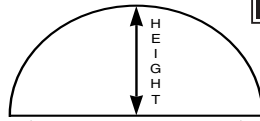

Width (Diameter)



	SIZE STANDARDS		
	Honeycomb		
	All 3/8" and 3/8" Blackout Fabrics	All 3/4" and 3/4" Blackout Fabrics	All 1/2" Double Cell and 3/8" Triple Cell Fabrics
Min. Width	12"	12"	12"
Max. Width	72"	84"	84"
Min. Height	6"	6"	6"
Max. Height	36"	42"	42"

Not available with 2" Hybrid Pleat or 3/4" Peaceful fabrics

MOVABLE ARCH (PERFECT ARCH = EXACT 1/2 CIRCLE, TEMPLATE NOT REQUIRED)

FAN-FOLD OPERABLE PERFECT ARCH

Must be perfect arch. Specify L or R arch orientation when ordering.

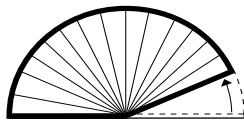

Shown Here – Fan Fold Left

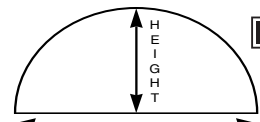

Width (Diameter)



	SIZE STANDARDS		
	Honeycomb		
	All 3/8" and 3/8" Blackout Fabrics	All 3/4" and 3/4" Blackout Fabrics	All 1/2" Double Cell and 3/8" Triple Cell Fabrics
Min. Width	12"	12"	12"
Max. Width	72"	84"	84"
Min. Height	6"	6"	6"
Max. Height	36"	42"	42"

Not available with 2" Hybrid Pleat or 3/4" Peaceful fabrics

Note: all fan-fold arches require the use of small, clear clips to be installed around the outer edge, which holds the fabric in place. The fabric must be slid out of the clips before the arch can be operated.

NON-MOVABLE ELLIPTICAL ARCH (TEMPLATE REQUIRED)

FAN-FOLD STATIONARY ELLIPTICAL ARCH

Non-perfect arch.



Come standard with arch disc

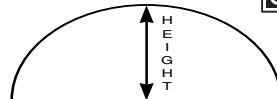

Width (Diameter)



	SIZE STANDARDS		
	Honeycomb		
	All 3/8" and 3/8" Blackout Fabrics	All 3/4" and 3/4" Blackout Fabrics	All 1/2" Double Cell and 3/8" Triple Cell Fabrics
Min. Width	12"	12"	12"
Max. Width	72"	84"	84"
Min. Height	1/4 width	1/4 width	1/4 width
Max. Height	1/2 width	1/2 width	1/2 width

Not available with 2" Hybrid Pleat or 3/4" Peaceful fabrics

TOP-DOWN MOVABLE ARCH (TEMPLATE REQUIRED)

TOP-DOWN OPERABLE PERFECT ARCH

Must be perfect arch. (Template required)

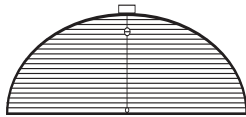

Fabric Pleats Oriented Horizontally.

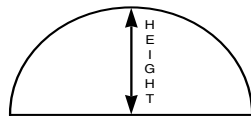

Width (Diameter)

	SIZE STANDARDS		
	Honeycomb		
	All 3/8" and 3/8" Blackout Fabrics	All 3/4" and 3/4" Blackout Fabrics	All 1/2" Double Cell Fabrics
Min. Width	18"	18"	18"
Max. Width	84"	84"	84"
Min. Height	6"	6"	6"
Max. Height	48"	48"	48"

Top-Down Movable Arch is not available with 3/8" triple cell, 2" Hybrid Pleat, or 3/4" Peaceful fabrics

Straight Side Specifications

- * 3/8" & 3/4": if arch width wider than 66", the max height=48"
- * 1/2": if arch width wider than 66", the max height=60"
- * 1/2": if arch width wider than 72", the max height=48"
- * Non-perfect arch: heights must be at least 25% of total width



Optional Top-Down Movable Arch
Extension Pole
Extends 5' to 10' (Part #400037-0007)

Available as Inside (IB) Mount ONLY

Specify arch trim at order entry:
661 Tiara White
320 Rich Cream

NOTE: Top-Down Arch not available in Triple Cell fabrics

TOP-DOWN OPERABLE ELLIPTICAL ARCH

Non-perfect arch. (Template required)

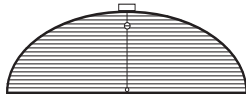

Fabric Pleats Oriented Horizontally.

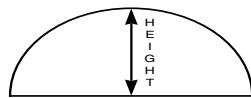

Width (Diameter)

	SIZE STANDARDS		
	Honeycomb		
	All 3/8" and 3/8" Blackout Fabrics	All 3/4" and 3/4" Blackout Fabrics	All 1/2" Double Cell Fabrics
Min. Width	18"	18"	18"
Max. Width	84"	84"	84"
Min. Arch Height	1/4 width	1/4 width	1/4 width
Max. Height	48"	48"	48"

Top-Down Movable Arch is not available with 3/8" triple cell, 2" Hybrid Pleat, or 3/4" Peaceful fabrics

Top-down arches will have a "flared" look to them when lowered. This is a natural characteristic of this product.

Arch trim kit included with Top-Down arches – available in White Tiara (661) & Rich Cream (320) – See the hardware guides for color example.

SPECIALTY SIZE STANDARDS & MEASURING INFORMATION

NOTE: Use metal tape measure for all measurements. Measures to 1/8 inch.

CIRCLES, QUARTER CIRCLES & ANGLE CUTS (TEMPLATE REQUIRED)

Refer to "Extra Charge Options" for Surcharge and Price Information

INSIDE MOUNT

Locate shape of window.
 Width: Measure exact width(s)
 Height: Measure exact height(s)
 Diagonal: Measure height of diagonal(s) (for Angle Cuts)

OUTSIDE MOUNT

Locate shape of window.
 Width: Measure desired width(s)
 Height: Measure desired height(s)
 Diagonal: Measure length of diagonal(s) (for Angle Cuts)

CIRCLES & QUARTER CIRCLE (TEMPLATE REQUIRED)

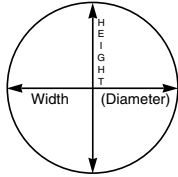

	All 3/8" & 3/4" Semi-Opaque Fabrics & All 1/2" Double Cell	3/8" Blackout	All Other
Min. Width	12"	12"	12"
Max. Width	48"	68"	60"
NON-OPERABLE			

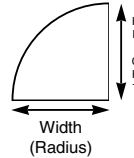

	All 3/8" Semi-Opaque Fabrics	All Other
Min. Width	12"	12"
Max. Width	30"	42"
NON-OPERABLE		

ANGLE CUTS (TEMPLATE REQUIRED)

ANGLED TOP (TEMPLATE REQUIRED)

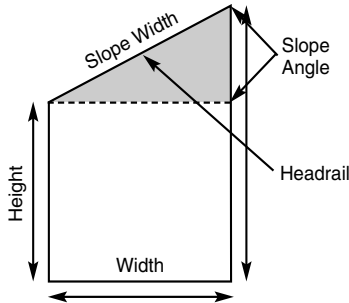

- Shades will raise to the shaded area indicated.
- Cordlock must always be at the lower end of the headrail

	All 3/8" Semi-Opaque Fabrics	All 3/4" Sheer, Semi-Sheer, Semi-Opaque Fabrics	All 3/8" & 3/4" Blackout Fabrics	All 1/2" Double Cell, 3/8" Triple Cell Fabrics
Maximum Height	84	84	72	84
Maximum Area (sq ft)	60	60	40	30
MINIMUM SLOPE WIDTH				
0 - 30 Angle	12	12	12	12
30 - 45 Angle	14	14	14	14
45 - 60 Angle	17	N/A	17	N/A
MAXIMUM SLOPE WIDTH				
0 - 30 Angle	83	55	83	60
30 - 45 Angle	84	67	84	60
45 - 60 Angle	84	N/A	84	N/A
Minimum Width	12	12	12	12
Maximum width	* up to 45 angle only			
0 - 30 Angle	70	48	70	48
30 - 45 Angle	60	48	60	48
45 - 60 Angle	42	N/A	42	N/A

* 1/2" Up to 45 angle only

HEXAGON & OCTAGON (TEMPLATE REQUIRED)

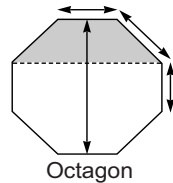
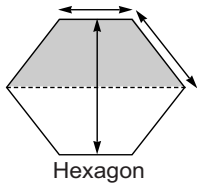

- Minimum width and minimum height – 8"
- Maximum width and maximum height – 30"
- Operate from bottom to top or top to bottom
- Inside mounts will raise to the shaded area indicated above

TRAPEZOID (ALL PATTERNS) (TEMPLATE REQUIRED)

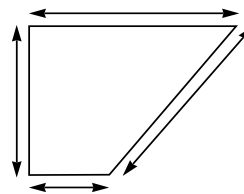

- Minimum width – 8"
- Maximum width of long rail – 72"
- Maximum reduction for short rail – 9" per side
- Maximum height – 96"
- Maximum area (sq. ft.) – 40
- Opens in the direction of the longest rail (Top-Down or Bottom-Up)

OPTIONS: EXTRA CHARGE

- **Angle Cut**add \$129
 (includes Angle Top, Hexagon, Octagon & Trapezoid)
- **Circle** – price as (width price x 1.3) using the Stationary Arch price chart for the fabric desired. Use exact width desired when ordering. (Template required.)
- **Quarter Circle** – price as (width price x 1.3) using the Stationary Arch price chart for the fabric desired. Use exact width desired when ordering.

SPECIALTY SIZE STANDARDS & MEASURING INFORMATION

NOTE: Use metal tape measure for all measurements. Measures to 1/8 inch.

ARCHES & QUARTER CIRCLES

FINISHED DIMENSIONS

Adjustments are taken from ordered dimensions.

Inside (IB) Mount	
Rail unit	- 3/16"
Arch height	ordered height
Fabric width	- 3/8"
Outside (OB) Mount	
Rail unit	+ 3/16"
Arch height	ordered height
Fabric width	ordered width

Max width for end mount is 36"

NOTE: Measurements may vary $\pm 1/8$ "

MOUNTING REQUIREMENTS

Use a metal tape measure for all measurements.

Inside (IB) Mount		3/8" Single
Minimum mounting depth:		
Standard installation bracket		1"
Swivel bracket		1/2"
Minimum mounting depth, flush mount:		
Standard installation bracket		1-1/2"
Swivel bracket		1-1/8"
End mount bracket		1-1/8"
Outside (OB) Mount		3/8" Single
Minimum flat vertical surface		
		5/8"
Inside (IB) Mount		3/4" Single, 1/2" Double, 3/8" Triple
Minimum mounting depth:		
Standard installation bracket		1-1/4"
Swivel bracket		1/2"
Minimum mounting depth, flush mount:		
Standard installation bracket		2-1/4"
Swivel bracket		2"
End mount bracket		2"
Outside (OB) Mount		3/4" Single, 1/2" Double, 3/8" Triple
Minimum flat vertical surface		
		1"

CIRCLES

FINISHED DIMENSIONS

Adjustments are taken from ordered dimensions.

Inside (IB) Mount	
Rail unit	- 1/16"
Arch height	- 3/32"
Fabric width	- 3/8"
Outside (OB) Mount	
Rail unit	+ 3/32"
Arch height	+ 1/32"
Fabric width	ordered width

NOTE: Measurements may vary $\pm 1/8$ "

MOUNTING REQUIREMENTS

Use a metal tape measure for all measurements.

Inside (IB) Mount		3/8" Single
Minimum mounting depth		
		1-1/8"
Inside (IB) Mount		3/4" Single, 1/2" Double, 3/8" Triple
Minimum mounting depth		
		1-7/8"
Outside (OB) Mount		3/4" Single, 1/2" Double, 3/8" Triple
Minimum flat vertical surface		
		5/8"

ANGLES

FINISHED DIMENSIONS

Finished dimensions vary depending on the degree of the angle.

NOTE: Measurements may vary $\pm 1/8$ "

MOUNTING REQUIREMENTS

SAME AS ARCHES & QUARTER CIRCLES

SPECIALTY SHAPES

FINISHED DIMENSIONS

Adjustments are taken from ordered dimensions.

Inside (IB) Mount	
Rail unit	- 3/16"
Arch height	ordered height
Fabric width	- 3/8"
Outside (OB) Mount	
Rail unit	+ 3/16"
Arch height	ordered height
Fabric width	ordered width

NOTE: Measurements may vary $\pm 1/8$ "

MOUNTING REQUIREMENTS

SAME AS ARCHES & QUARTER CIRCLES

SIZE STANDARDS SUMMARY BY CONFIGURATION & FABRIC

HONEYCOMB							2" HYBRID PLEAT
3/8" Single Cell - Semi-Opaque	3/8" Single Cell - Blackout	3/4" Single Cell - Sheer and Semi-Sheer	3/4" Single Cell - Semi-Opaque	3/4" Single Cell - Blackout	1/2" Double Cell - Semi-Opaque	3/8" Triple Cell - Semi-Opaque	All Fabrics

Standard Cordlock

Min Width (net) *	8"	8"	8"	8"	8"	8"	8"	N/A
Max Width	174"	174"	174"	174"	174"	174"	142"	
Max Width - End Mount	36"	36"	36"	36"	36"	36"	36"	
Min Height	6"	6"	6"	6"	6"	6"	6"	
Max Height	144"	144"	144"	174"	174"	144"	120"	
Max Area (Sq/Ft)	60	40	60	60	40	40	40	

* If width < 12", max height = 80"

Standard Cordlock - Top-Down

Min Width (net) *	10"	10"	10"	10"	10"	10"	10"	N/A
Max Width	60"	60"	60"	60"	60"	60"	60"	
Max Width - End Mount	36"	36"	36"	36"	36"	36"	36"	
Min Height	6"	6"	6"	6"	6"	6"	6"	
Max Height	144"	144"	144"	174"	174"	144"	120"	
Max Area (Sq/Ft)	60	40	60	60	40	40	60	

* If width < 12", max height = 80"

Standard Cordlock - Top-Down/ Bottom-Up

Min Width (net) *	10"	10"	10"	10"	10"	10"	10"	N/A
Max Width	72"	72"	72"	72"	72"	72"	72"	
Max Width - End Mount	36"	36"	36"	36"	36"	36"	36"	
Min Height	6"	6"	6"	6"	6"	6"	6"	
Max Height	108"	108"	108"	108"	108"	108"	108"	
Max Area (Sq/Ft)	48	40	48	48	40	40	48	

* If width < 12", max height = 80"

Standard Cordlock - Two-Fabric Combo

Min Width (net) *	N/A	N/A	10"	10"	10"	10"	10"	N/A
Max Width	N/A	N/A	72"	72"	72"	60"	60"	
Max Width - End Mount	N/A	N/A	36"	36"	36"	36"	36"	
Min Height	N/A	N/A	6"	6"	6"	6"	6"	
Max Height	N/A	N/A	96"	96"	96"	90"	90"	
Max Area (Sq/Ft)	N/A	N/A	48	48	40	40	40	

* If width < 12", max height = 80"

Standard Cordlock - Two-On-One Headrail

Min Width (per panel) (net) *	8"	8"	8"	8"	8"	8"	8"	N/A
Min Width (overall)	16"	16"	16"	16"	16"	16"	16"	
Max Width (per panel)	162"	162"	162"	162"	162"	162"	142"	
Max Width (overall)	192"	192"	192"	192"	192"	192"	184"	
Max Width - End Mount	36"	36"	36"	36"	36"	36"	36"	
Min Height	6"	6"	6"	6"	6"	6"	6"	
Max Height	144"	144"	144"	174"	174"	144"	120"	
Max Area (Sq/Ft)	60	40	60	60	40	40	60	

* If width < 12", max height = 80"

Continuous Cord Loop

Min Width (net)	18"	18"	18"	18"	18"	18"	18"	18"
Max Width	144"	144"	174"	174"	144"	144"	142"	120"
Max Width - End Mount	48"	48"	48"	48"	48"	48"	48"	42"
Min Height	6"	6"	6"	6"	6"	6"	6"	12"
Max Height	96"	96"	144"	144"	144"	144"	120"	120"
Max Area (Sq/Ft)	90	80	150	150	100	80	80	60

Continuous Cord Loop - Top-Down/Bottom-Up

Min Width (net)	24"	24"	24"	24"	24"	24"	24"	24"
Max Width	144"	144"	144"	144"	144"	144"	142"	120"
Max Width - End Mount	48"	48"	48"	48"	48"	48"	48"	42"
Min Height	8"	8"	8"	8"	8"	8"	8"	12"
Max Height	96"	96"	144"	144"	144"	144"	120"	120"
Max Area (Sq/Ft)	90	80	150	150	100	80	80	60

Continuous Cord Loop - Two-On-One Headrail

Min Width (per panel) (net)	18"	18"	18"	18"	18"	18"	18"	18"
Min Width (overall)	36"	36"	36"	36"	36"	36"	36"	36"
Max Width (per panel)	144"	144"	144"	144"	144"	144"	142"	102"
Max Width (overall)	174"	174"	174"	174"	174"	174"	174"	120"
Min Height	6"	6"	6"	6"	6"	6"	6"	12"
Max Height	96"	96"	144"	144"	144"	144"	120"	120"
Max Area (Sq/Ft)	90	80	150	150	100	80	80	60

SIZE STANDARDS SUMMARY BY CONFIGURATION & FABRIC

HONEYCOMB							2" HYBRID PLEAT
3/8" Single Cell - Semi-Opaque	3/8" Single Cell - Blackout	3/4" Single Cell - Sheer and Semi-Sheer	3/4" Single Cell - Semi-Opaque	3/4" Single Cell - Blackout	1/2" Double Cell - Semi-Opaque	3/8" Triple Cell - Semi-Opaque	All Fabrics

Cordless Lift System

Min Width (net)	16"	N/A	16"	16"	16"	16"	N/A	16"	
Max Width	120"		120"	120"	120"	120"		120"	120"
Max Width - End Mount	48"		48"	48"	48"	48"		48"	42"
Min Height	12"		12"	12"	12"	12"		12"	12"
Max Height	84"		84"	84"	84"	84"		84"	84"
Max Area (Sq/Ft)	70		70	70	70	70		70	60

Cordless Lift - Two-On-One Headrail

Min Width (per panel) (net)	16"	N/A	16"	16"	16"	16"	N/A	16"	
Min Width (overall)	32"		32"	32"	32"	32"		32"	32"
Max Width (per panel)	120"		120"	120"	120"	120"		120"	100"
Max Width (overall)	174"		174"	174"	174"	174"		174"	120"
Min Height	12"		12"	12"	12"	12"		12"	12"
Max Height	84"		84"	84"	84"	84"		84"	84"
Max Area (per panel) (Sq/Ft)	70		70	70	70	70		70	60

Cordless Lift - Three-On-One Headrail

Min Width (per panel) (net)	16"	N/A	16"	16"	16"	16"	N/A	16"	
Min Width (overall)	32"		48"	48"	48"	48"		48"	48"
Max Width (per panel)	120"		120"	120"	120"	120"		120"	104"
Max Width (overall)	174"		174"	174"	174"	174"		174"	120"
Min Height	12"		12"	12"	12"	12"		12"	12"
Max Height	84"		84"	84"	84"	84"		84"	84"
Max Area (per panel) (Sq/Ft)	70		70	70	70	70		70	60

Cordless Lift System - Top-Down/ Bottom-Up

Min Width (net)	16"	N/A	16"	16"	16"	16"	N/A	16"	
Max Width	120"		120"	120"	120"	120"		120"	120"
Max Width - End Mount	48"		48"	48"	48"	48"		48"	42"
Min Height	12"		12"	12"	12"	12"		12"	12"
Max Height	84"		84"	84"	84"	84"		84"	84"
Max Area (Sq/Ft)	70		70	70	70	70		70	60

Cordless Lift System - Two Fabric Combo

Min Width (net)	N/A	N/A	16"	16"	16"	N/A	N/A	N/A
Max Width			84"	84"	84"	N/A		
Max Width - End Mount			36"	36"	36"	N/A		
Min Height			12"	12"	12"	N/A		
Max Height			84"	84"	84"	N/A		
Max Area (Sq/Ft)			42	42	42	N/A		

Cordless Lift & Lock

Min Width (net)	N/A	N/A	9.5"	9.5"	9.5"	9.5"	N/A	9.5"
Max Width			84"	84"	84"	84"		84"
Max Width - End Mount			48"	48"	48"	48"		48"
Min Height			12"	12"	12"	12"		12"
Max Height			84"	84"	84"	84"		84"
Max Area (Sq/Ft)			49	49	49	49		49

Cordless Lift & Lock - Two-On-One Headrail

Min Width (per panel) (net)	N/A	N/A	9.5"	9.5"	9.5"	9.5"	N/A	9.5"
Min Width (overall)			20"	20"	20"	20"		20"
Max Width (per panel)			84"	84"	84"	84"		84"
Max Width (overall)			168"	168"	168"	168"		168"
Min Height			12"	12"	12"	12"		12"
Max Height			84"	84"	84"	84"		84"
Max Area (per panel) (Sq/Ft)			49	49	49	49		49

Cordless Lift & Lock - Three-On-One Headrail

Min Width (per panel) (net)	N/A	N/A	9.5"	9.5"	9.5"	9.5"	N/A	9.5"
Min Width (overall)			30"	30"	30"	30"		30"
Max Width (per panel)			84"	84"	84"	84"		84"
Max Width (overall)			168"	168"	168"	168"		168"
Min Height			12"	12"	12"	12"		12"
Max Height			84"	84"	84"	84"		84"
Max Area (per panel) (Sq/Ft)			49	49	49	49		49

Cordless Lift & Lock - Top-Down/ Bottom-Up

Min Width (net)	N/A	N/A	16"	16"	16"	16"	N/A	16"
Max Width			84"	84"	84"	84"		84"
Max Width - End Mount			48"	48"	48"	48"		48"
Min Height			12"	12"	12"	12"		12"
Max Height			84"	84"	84"	84"		84"
Max Area Overall (Sq/Ft)			49	49	49	49		49

SIZE STANDARDS SUMMARY BY CONFIGURATION & FABRIC

HONEYCOMB							2" HYBRID PLEAT
3/8" Single Cell - Semi-Opaque	3/8" Single Cell - Blackout	3/4" Single Cell - Sheer and Semi-Sheer	3/4" Single Cell - Semi-Opaque	3/4" Single Cell - Blackout	1/2" Double Cell - Semi-Opaque	3/8" Triple Cell - Semi-Opaque	All Fabrics

TriLight Shades - Continuous Cord Loop

Min Width (net)	N/A	N/A	N/A	24"	24"	24"	N/A	24"
Max Width				83" - 96"	83" - 96"	83" - 96"		83" - 96"
Max Width - End Mount				48"	48"	48"		42"
Min Height				12"	12"	12"		12"
Max Height				96"	96"	96"		96"
Max Area (Sq/Ft)				64	50	50		60

* The HC fabric (bottom panel) max width can be reduced by the ordered PLE fabric (top panel), if PLE max width < HC max width.

** Willa Sheer maximum width is 83"

TriLight Shades - Cordless

Min Width (net)	N/A	N/A	N/A	16"	16"	16"	N/A	16"
Max Width				83" - 96"	83" - 96"	83" - 96"		83" - 96"
Max Width - End Mount				48"	48"	48"		42"
Min Height				12"	12"	12"		12"
Max Height				84"	84"	84"		84"
Max Area (Sq/Ft)				70	70	70		60

* The HC fabric (bottom panel) max width can be reduced by the ordered PLE fabric (top panel), if PLE max width < HC max width.

** Willa Sheer maximum width is 83"

TriLight Shades - Cordless Lift & Lock

Min Width (net)	N/A	N/A	N/A	12"	12"	12"	N/A	12"
Max Width				84"	84"	84"		84"
Max Width - End Mount				48"	48"	48"		42"
Min Height				12"	12"	12"		12"
Max Height				84"	84"	84"		84"
Max Area (Sq/Ft)				49	49	49		49

* The HC fabric (bottom panel) max width can be reduced by the ordered PLE fabric (top panel), if PLE max width < HC max width.

** Willa Sheer maximum width is 83"

Vertical Application

Min Width	N/A	N/A	12"	12"	12"	N/A	N/A	12"
Max Width Side Stack			120"	168"	168"			168"
Max Width Split Stack			168"	190"	190"			190"
Min Height			24"	24"	24"			24"
Max Height			120"	120"	120"			120"
Max Area Side Stack			100	140	120			100
Max Area Split Stack			100	140	140			120

Note: Sheer only, not available on Semi-Sheer.

SIZE STANDARDS SUMMARY BY CONFIGURATION & FABRIC

HONEYCOMB							2" HYBRID PLEAT
3/8" Single Cell - Semi-Opaque	3/8" Single Cell - Blackout	3/4" Single Cell - Sheer and Semi-Sheer	3/4" Single Cell - Semi-Opaque	3/4" Single Cell - Blackout	1/2" Double Cell - Semi-Opaque	3/8" Triple Cell - Semi-Opaque	All Fabrics

Classic Skylight

Min Width	18"	18"	18"	18"	18"	18"	N/A	N/A
Max Width	60"	60"	60"	60"	60"	60"		
Min Height	6"	6"	6"	6"	6"	6"		
Max Height	72"	72"	72"	72"	72"	72"		
Max Area (Sq/Ft)	25	25	25	25	25	25		

Classic Skylight – Side Stack

Min Width	6"	6"	6"	6"	6"	6"	N/A	N/A
Max Width	72"	72"	72"	72"	72"	72"		
Min Height	18"	18"	18"	18"	18"	18"		
Max Height	60"	60"	60"	60"	60"	60"		
Max Area (Sq/Ft)	25	25	25	25	25	25		

Skylight with Simplicity Motorization

Min Width	18"	18"	18"	18"	18"	18"	N/A	N/A
Max Width	48"	48"	48"	48"	48"	48"		
Min Height	12"	12"	12"	12"	12"	12"		
Max Height	72"	72"	72"	72"	72"	72"		
Max Area (Sq/Ft)	N/A	N/A	N/A	N/A	N/A	N/A		

Non-Movable Perfect Arch (Fan-Fold)

Min Width	12"	12"	12"	12"	12"	12"	12"	N/A
Max Width	72"	72"	84"	84"	84"	84"	84"	
Min Height	6"	6"	6"	6"	6"	6"	6"	
Max Height	36"	36"	42"	42"	42"	42"	42"	

Movable Perfect Arch (Fan-Fold)

Min Width	12"	12"	12"	12"	12"	12"	12"	N/A
Max Width	72"	72"	84"	84"	84"	84"	84"	
Min Height	6"	6"	6"	6"	6"	6"	6"	
Max Height	36"	36"	42"	42"	42"	42"	42"	

Non-Movable Elliptical Arch (Fan-Fold)

Min Width	12"	12"	12"	12"	12"	12"	12"	N/A
Max Width	72"	72"	84"	84"	84"	84"	84"	
Min Height	1/4 width	1/4 width	1/4 width	1/4 width	1/4 width	1/4 width	1/4 width	
Max Height	36"	36"	42"	42"	42"	42"	42"	

Top-Down Movable Perfect Arch

Min Width	18"	18"	18"	18"	18"	18"	N/A	N/A
Max Width	84"	84"	84"	84"	84"	84"		
Min Height	6"	6"	6"	6"	6"	6"		
Max Height	48"	48"	48"	48"	48"	48"		

Top-Down Movable Elliptical Arch

Min Width	18"	18"	18"	18"	18"	18"	N/A	N/A
Max Width	84"	84"	84"	84"	84"	84"		
Min Height	1/4 width	1/4 width	1/4 width	1/4 width	1/4 width	1/4 width		
Max Height	48"	48"	48"	48"	48"	48"		

Angle

Min Width	12"	12"	12"	12"	12"	12"	12"	N/A
Max Width	angle chart	angle chart	angle chart	angle chart	angle chart	angle chart	angle chart	
Max Height	angle chart	angle chart	angle chart	angle chart	angle chart	angle chart	angle chart	
Max Area (Sq/Ft)	60	40	60	60	40	30	30	

PRODUCT COMPONENTS – STANDARD RECTANGULAR

3/8" End Mount Bracket (Part #2980038000) – Not Shown
 3/4" End Mount Bracket (Part #2980050000) – Not Shown

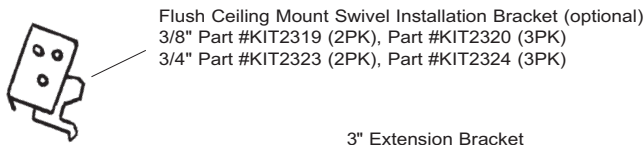

Flush Ceiling Mount Swivel Installation Bracket (optional)
 3/8" Part #KIT2319 (2PK), Part #KIT2320 (3PK)
 3/4" Part #KIT2323 (2PK), Part #KIT2324 (3PK)

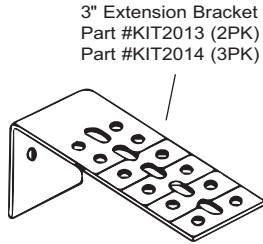

3" Extension Bracket
 Part #KIT2013 (2PK)
 Part #KIT2014 (3PK)

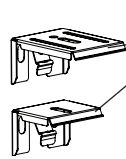

Standard Installation Bracket
 3/8" Part #KIT-38HC-STD (2PK), Part #KIT-38HC-STD-3PK (3PK)
 3/4" Part #KIT-34HC-STD (2PK), Part #KIT-34HC-STD-3PK (3PK)

1/2" Spacer Block
 Part #KIT2011 = 2 Spacers per kit
 Part #KIT2012 = 3 Spacers per kit

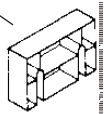

Hold Down Bracket
 (3/8" Part #KIT2009)
 (3/4" Part #KIT2010)

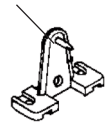

Color Coordinated Aluminum Headrail

Cordlock Cover
 (3/8" RH Part #2950075-COLOR)
 (3/8" LH Part #2950085-COLOR)
 Cordlock Mechanism Only
 (3/8" RH Part #2950094000)
 (3/8" LH Part #2950095000)
 Cordlock Cover
 (3/4" RH Part #2970070-COLOR)
 (3/4" LH Part #2970080-COLOR)
 Cordlock Mechanism Only
 (3/4" RH Part #2970094000)
 (3/4" LH Part #2970095000)

Color Coordinated End Cap
 (3/4" Part #2986504-COLOR)
 (3/8" Part #2980020-COLOR)

Cellular Fabric
 Color Coordinated Multiple Cords

Cord Equalizer (Part #700425-COLOR)
 Adjuster Plate (Part #90-179B-0000)

Single Color Coordinated Cord

Tassel Cover – Color Coordinated
 (Part #700425-COLOR)

Shade Adjust (Part #12-128A Spool,
 12-129A Base)

Shade Adjust (Part #12-128A Spool,
 12-129A Base)

Color Coordinated
 Aluminum Bottomrail

Arch Trim – White (Part #2280364661)
 – Rich Cream (Part #2280364320)

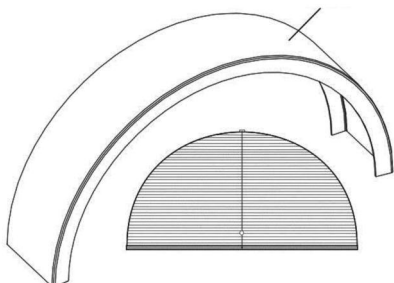

Top-Down/Bottom-Up
 Break-away Safety Tassel
 (Part #2932623-COLOR)



Child Safety Kit (Cord Cleat)
 (Part #KIT2728)

PRODUCT COMPONENTS – SIMPLICITY RECHARGEABLE MOTORIZATION

End Mount Bracket
(Part #40-0026-159)
Used with installation bracket

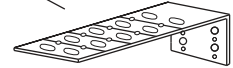

1/2" Spacer Block
Part #KIT2011 (2PK)
Part #KIT2012 (3PK)

Extension Bracket
Part #KIT2013 (2PK)

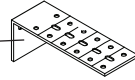

Installation Bracket
Part #KIT-CCCLHC-2PK

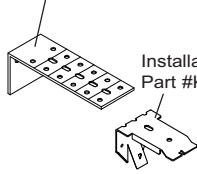

Black Washer

Lock Washer

Motor

Spool Cover
(Part #5241301)

Lift Station Support – RH
(Part #6281301)

Headrail End Cap
(Part #4024954-COLOR)

1/2" Spacer Block
Part #KIT2011 (2PK)
Part #KIT2012 (3PK)

3 Conductor Wire to PCB Pigtail

3 Conductor Extension Wire

Polycarb Lift Spool
(Part #2781211001)

Cable Twist Tie

Cable Tie

Cable Tie Mounting Base

Charging Wire

Battery Pack

Spool Cover
(Part #5241301)

Lift Station Support – LH
(Part #6281303)

Lift Rod V Shaft
(Part #50-0069-000)

Cordless Headrail

Cradle Support
(Part #19-179)

Headrail Filler Strip
(Part #2974000000)

End Cap – 3/8" (Part #UEC-COLOR)
3/4" (Part #19-183-COLOR)

Hold Down Bracket (Part #XCS1101)

3/8" Rail (Part #UR-COLOR-16)
3/4" Rail (Part #ZUR-COLOR-16)

Shade Adjust
Spool (Part #12-128A)
Base (Part #12-129A)

Rail Weight – 5" With Tape (Part #40-0013-000)

Filler Strip – 3/8" Rail (Part #2954000000)
3/4" Rail (Part #2974000000)

Shade Adjust
Spool (Part #12-128A)
Base (Part #12-129A)

End Cap – 3/8" (Part #UEC-COLOR)
3/4" (Part #19-183-COLOR)

Hold Down Bracket (Part #XCS1101)

Remote
White (Part #CS5138W)
Black (Part #CS5138)

Plug-in Charger
(Part #CS5199)

PRODUCT COMPONENTS – POWERWAND™ MOTORIZATION

End Mount Bracket
(Part #40-0026-159)
Used with installation bracket

1/2" Spacer Block
Part #KIT2011 (2PK)
Part #KIT2012 (3PK)

Extension Bracket
Part #KIT2013 (2PK)

Installation Bracket
Part #KIT-CCCLHC-2PK

Black Washer
Lock Washer
Motor

Spool Cover
(Part #5241301)

Lift Station Support – RH
(Part #6281301)

Headrail End Cap
(Part #4024954-COLOR)

1/2" Spacer Block
Part #KIT2011 (2PK)
Part #KIT2012 (3PK)

Cable Tie

Cable Twist Tie

Polycarb Lift Spool
(Part #2781211001)

Cordless Headrail

Battery Pack

2 Conductor Wire
to PCB Pigtail

Spool Cover
(Part #5241301)

Lift Rod V Shaft
(Part #50-0069-000)

Hanger

Cradle Support
(Part #19-179)

Lift Station Support – LH
(Part #6281303)

Internal Hanger

Cable Tie

Pendant

Headrail Filler Strip
(Part #2974000000)

End Cap – 3/8" (Part #UEC-COLOR)
3/4" (Part #19-183-COLOR)

Hold Down Bracket (Part #XCS1101)

3/8" Rail (Part #UR-COLOR-16)
3/4" Rail (Part #ZUR-COLOR-16)

Shade Adjust
Spool (Part #12-128A)
Base (Part #12-129A)

Rail Weight – 5" With Tape (Part #40-0013-000)

Filler Strip – 3/8" Rail (Part #2954000000)
3/4" Rail (Part #2974000000)

Shade Adjust
Spool (Part #12-128A)
Base (Part #12-129A)

End Cap – 3/8" (Part #UEC-COLOR)
3/4" (Part #19-183-COLOR)

Hold Down Bracket (Part #XCS1101)

Plug-in Charger
(Part #CS5199)

PRODUCT COMPONENTS – CORDLESS

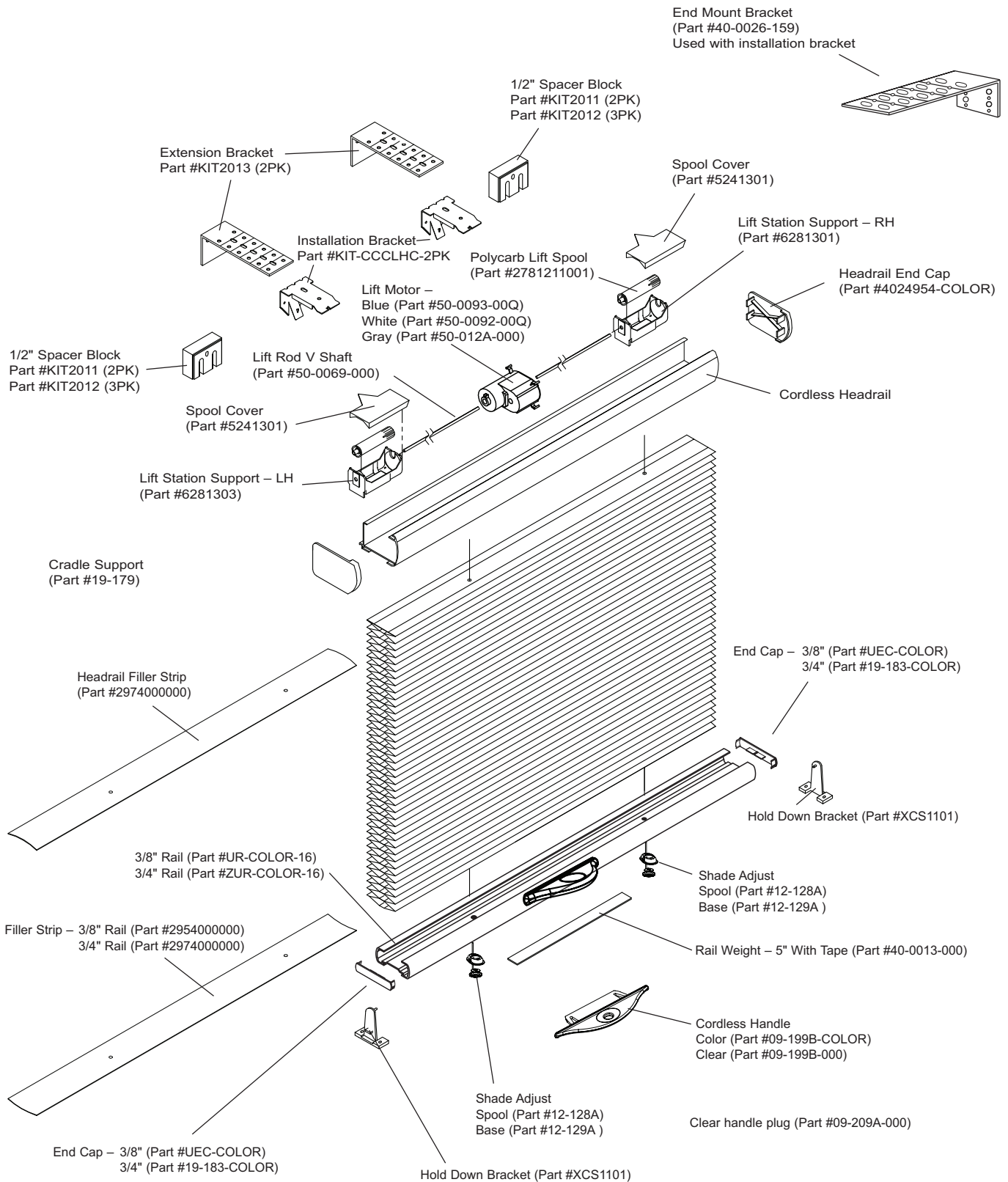

CORDLESS TOP-DOWN/BOTTOM-UP

Striker Plate:
Zinc: Part #CS5476PL-TDBU (Painted rails)
White: Part #CS5467PL-TDBU-W (Fabric covered rails)

Magnet:
Zinc: Part #CS5467 (Painted rails)
Magnet Cover - White: Part #CS5467CV-W (Fabric covered rails)
Magnet Lock: Part #CS5471
Magnet Screw: Part #CS5474

PRODUCT COMPONENTS – CORDLESS LIFT & LOCK

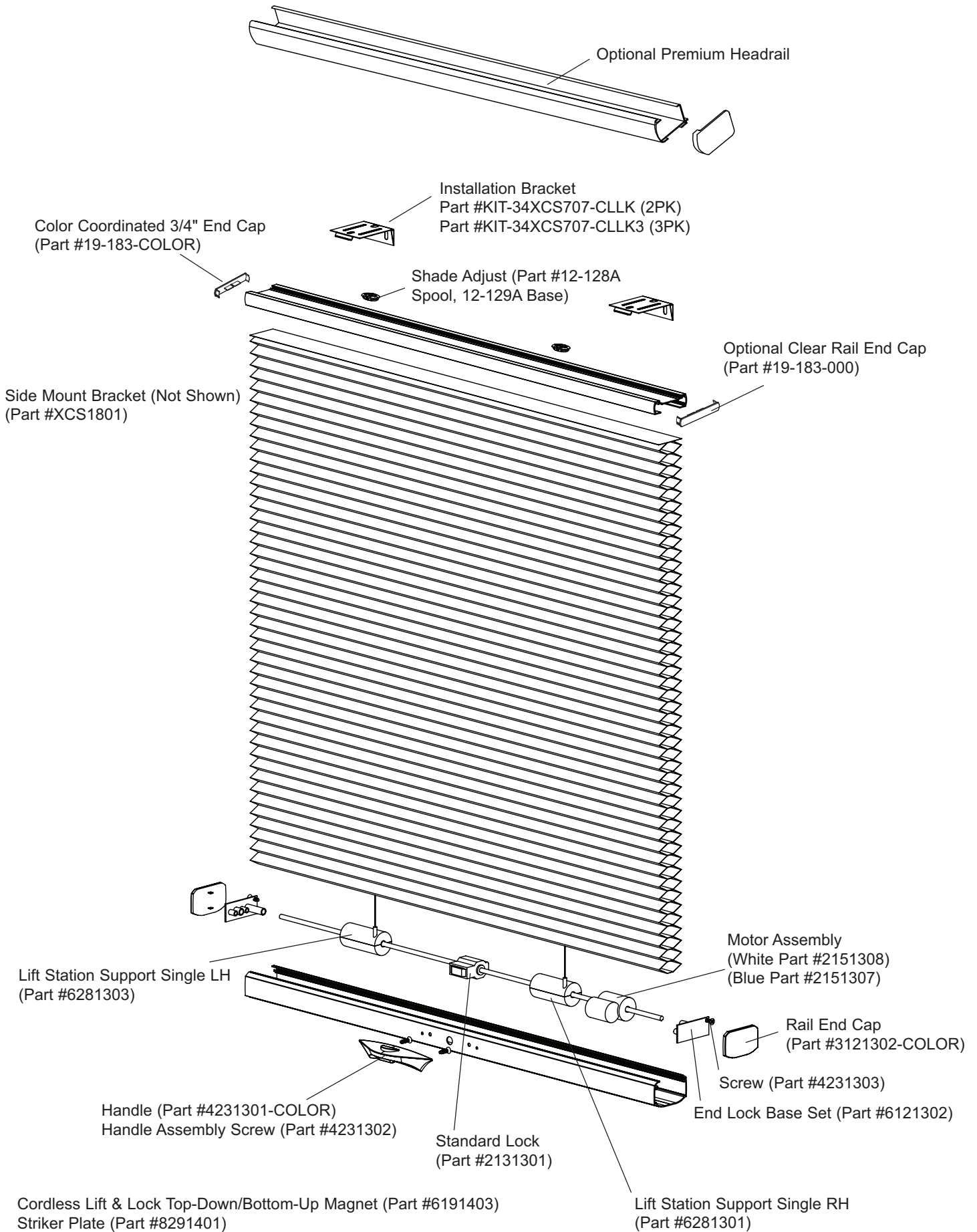

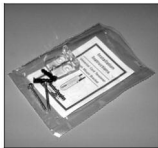
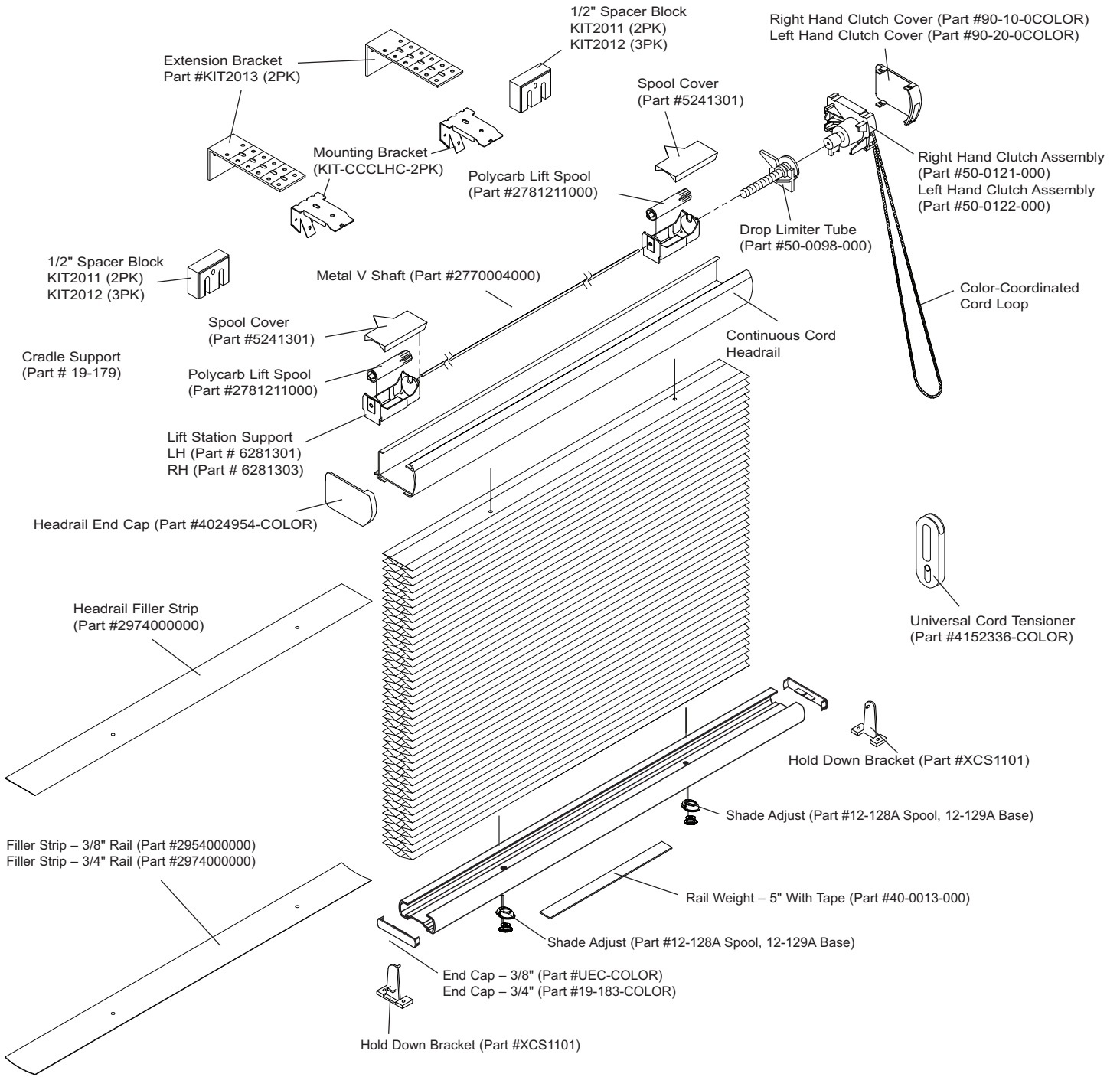

PRODUCT COMPONENTS – CONTINUOUS CORD

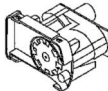

Universal Cord Tensioner Mounting Kit (Part #KIT2350)

Continuous Cord Top-Down/Bottom-Up Components

 LH Rear Clutch Assembly (Part #CS4317)
 Dual Bottom Limiter (Part #CS4318)

TRILIGHT PRODUCT COMPONENTS – CORDLESS & CONTINUOUS CORD LOOP

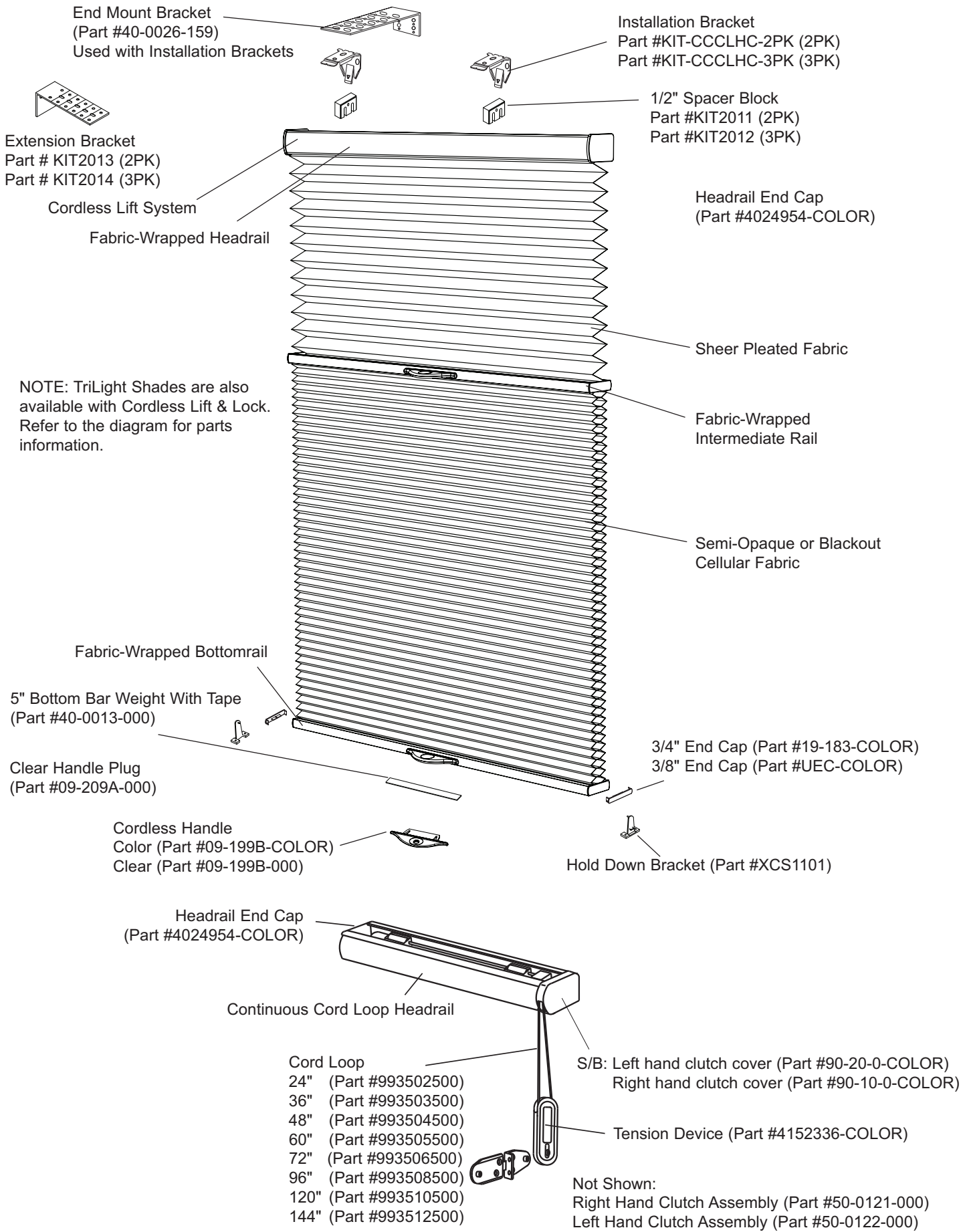

PRODUCT COMPONENTS – VERTICAL APPLICATION

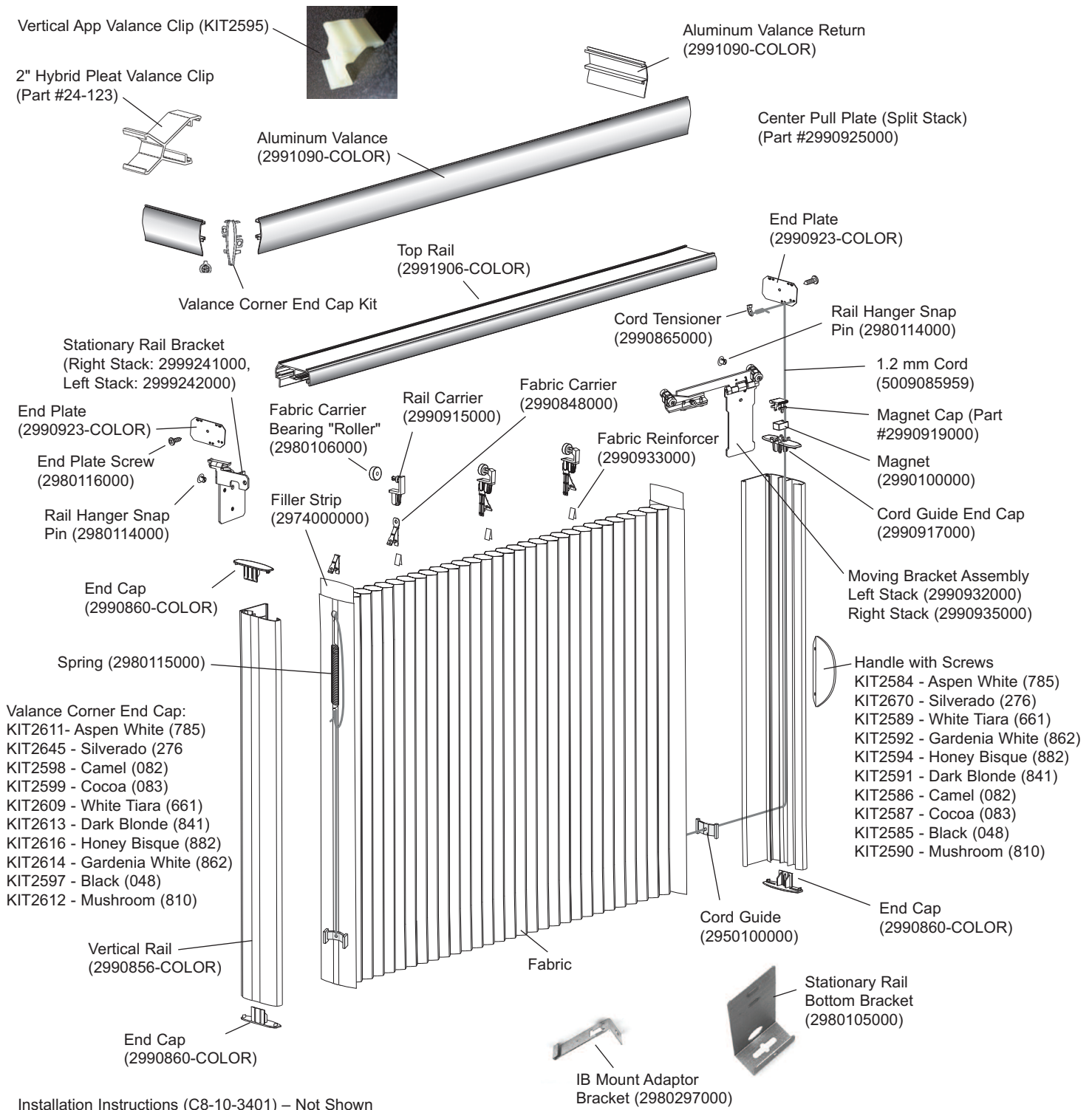

Installation Instructions (C8-10-3401) – Not Shown

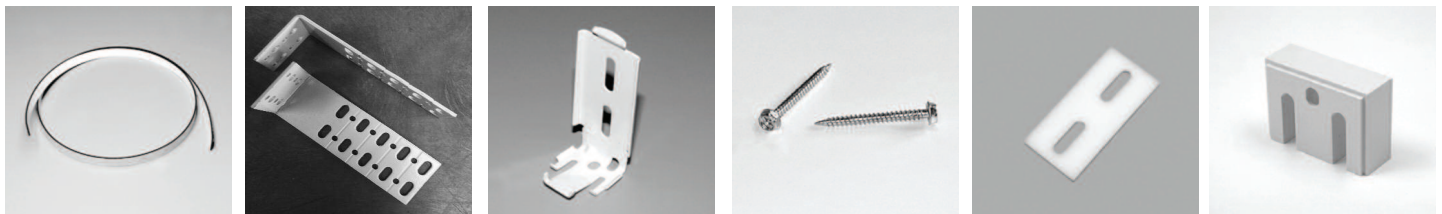

White Magnetic Strip (split stack) (2990133000)

Extension Bracket (40-0026-159)

Installation Bracket with Screws (2990934000)

Mounting Screws #6 x 1.5 (2980153000)

Shim (2990938785)

1/2" Spacer Block
KIT2011 = 2 Spacers/kit
KIT2012 = 3 Spacers/kit

PRODUCT COMPONENTS – 2" HYBRID PLEAT

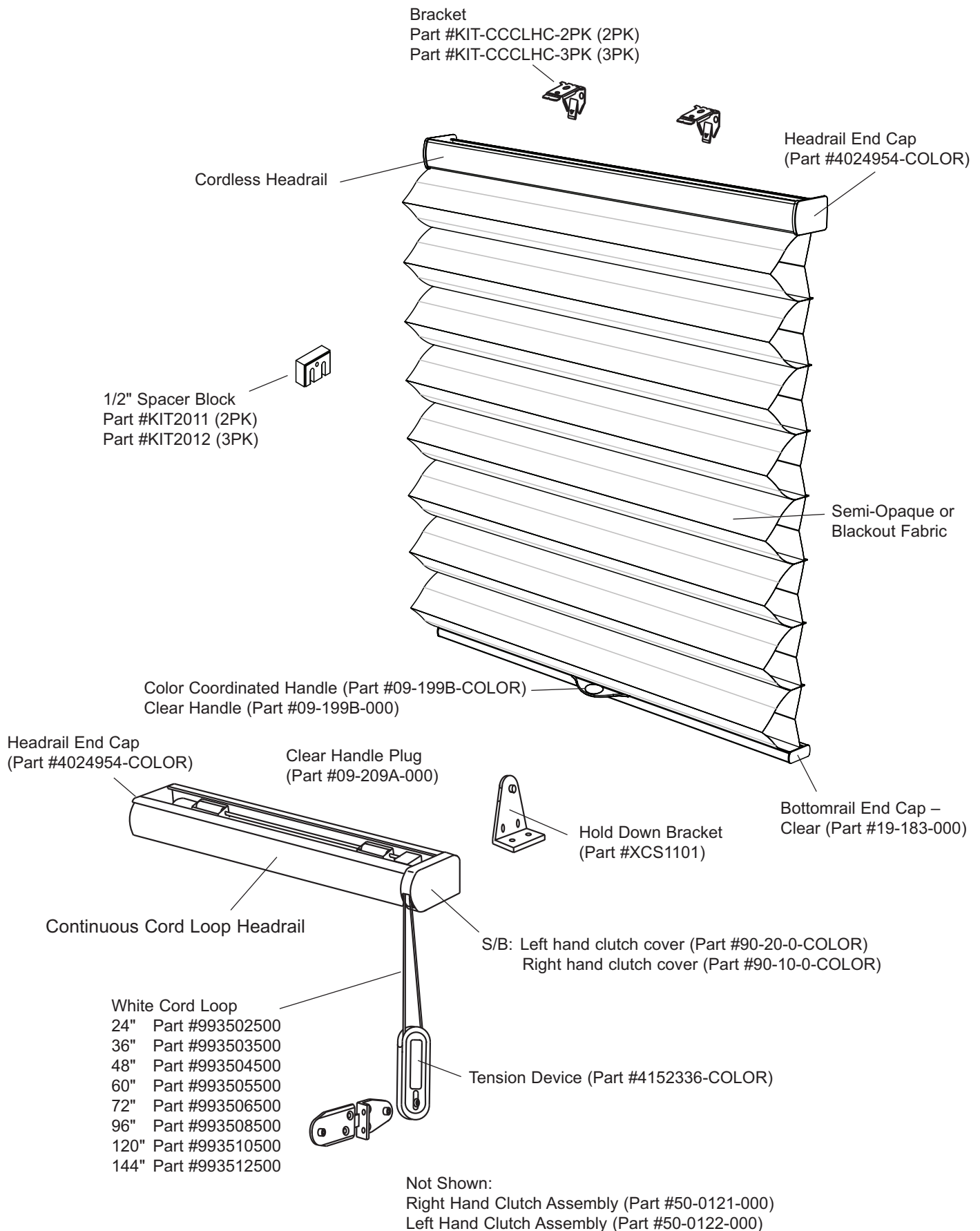

PRODUCT COMPONENTS – 2" HYBRID PLEAT TRILIGHT

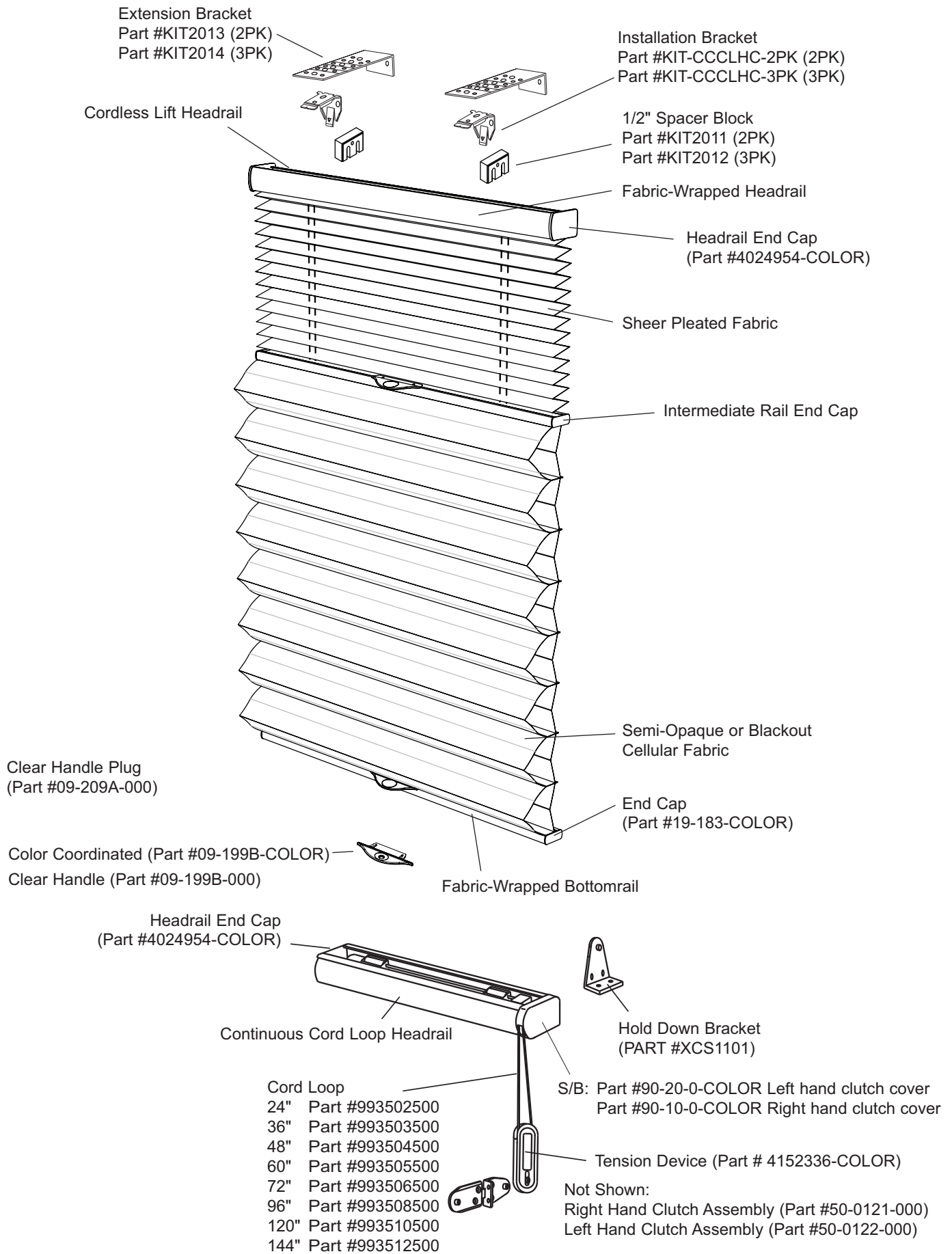

PRODUCT COMPONENTS – SKYLIGHT

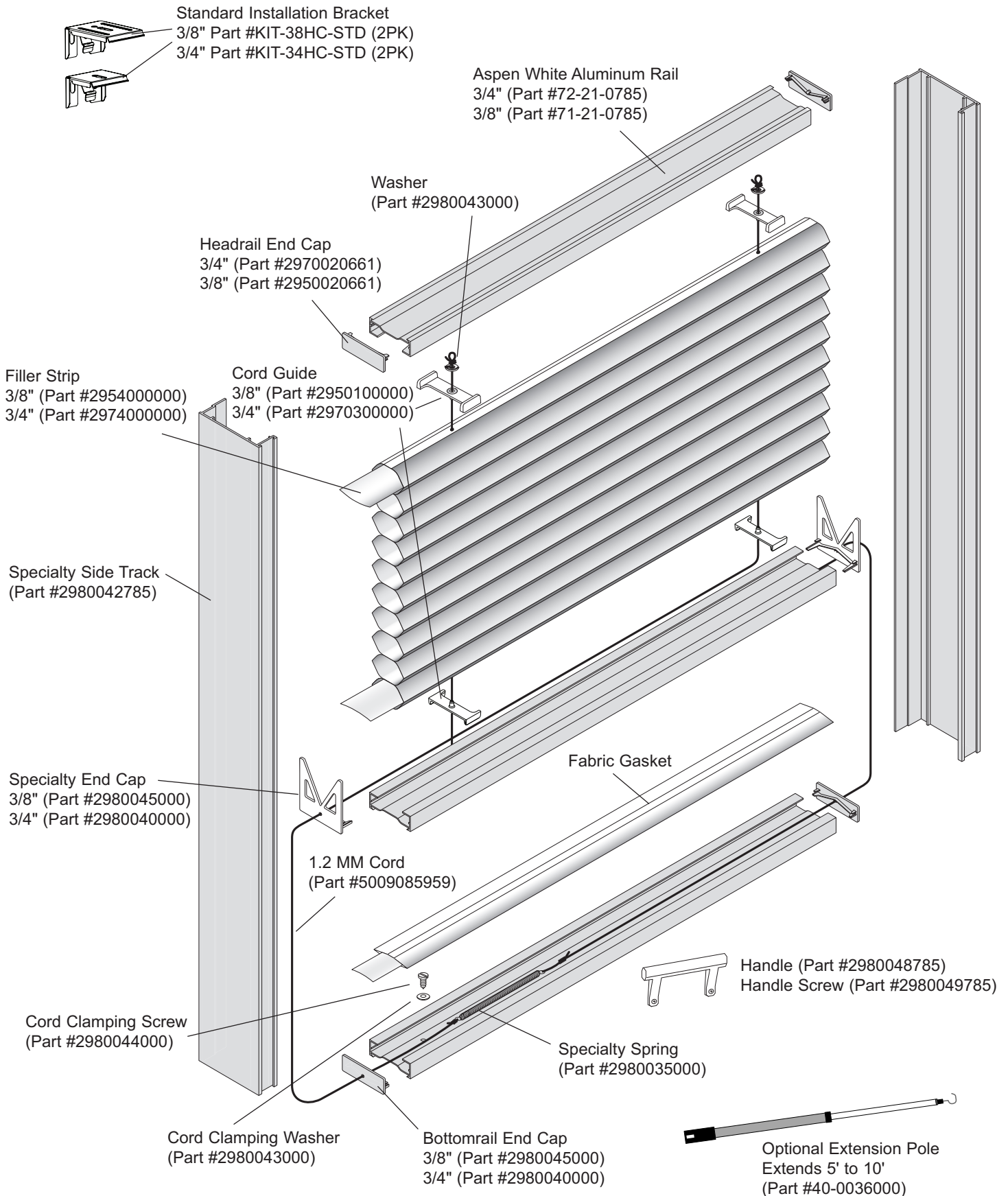

PRODUCT COMPONENTS – SIMPLICITY SKYLIGHT

