

POLY #2 AIR COOLED CABINET

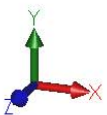

FRONT

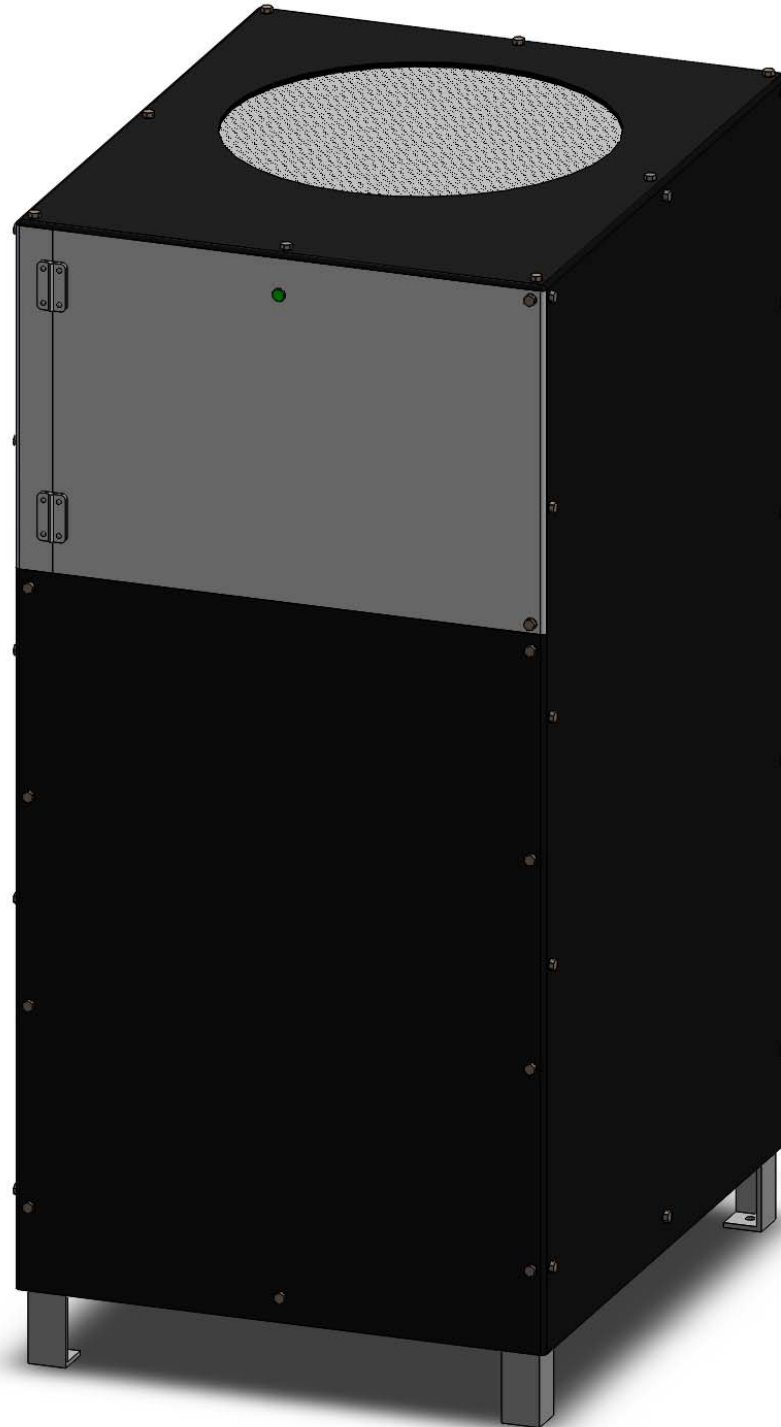
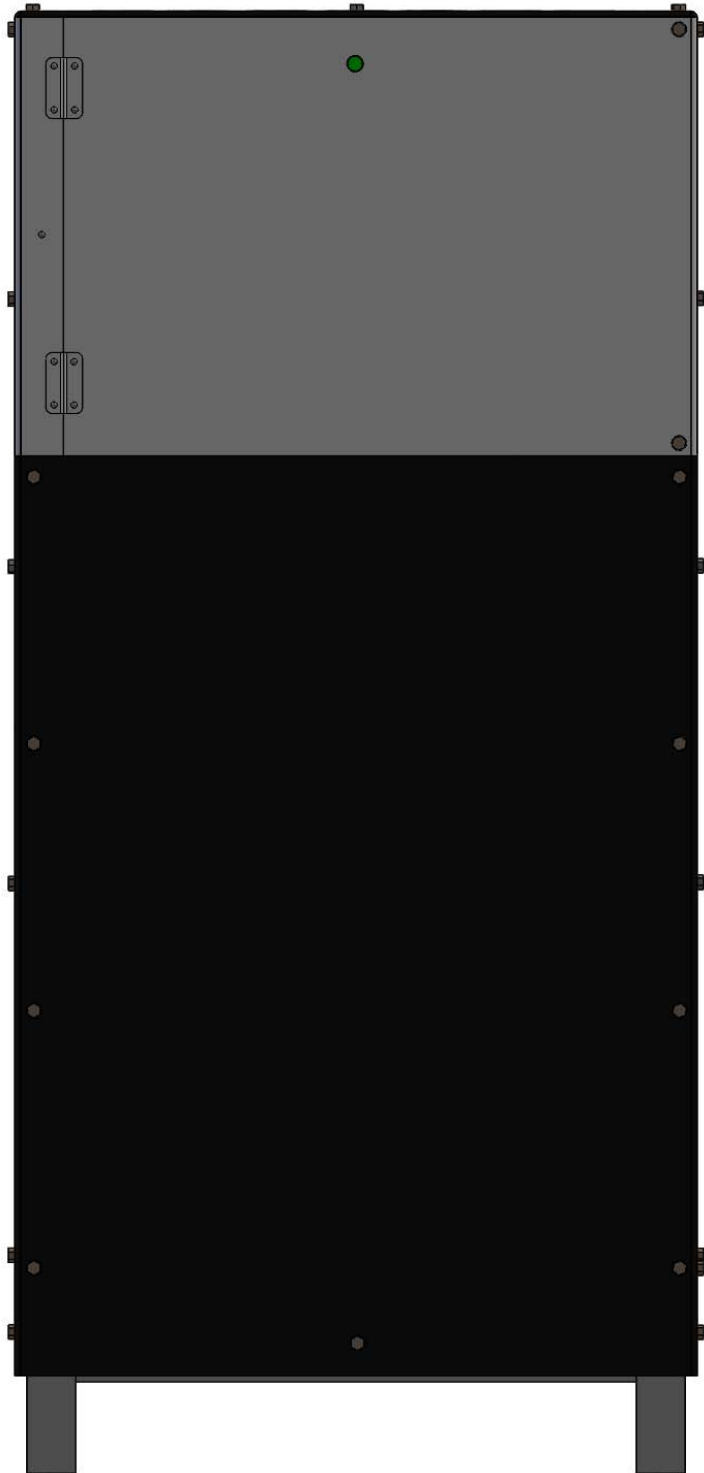

RIGHT

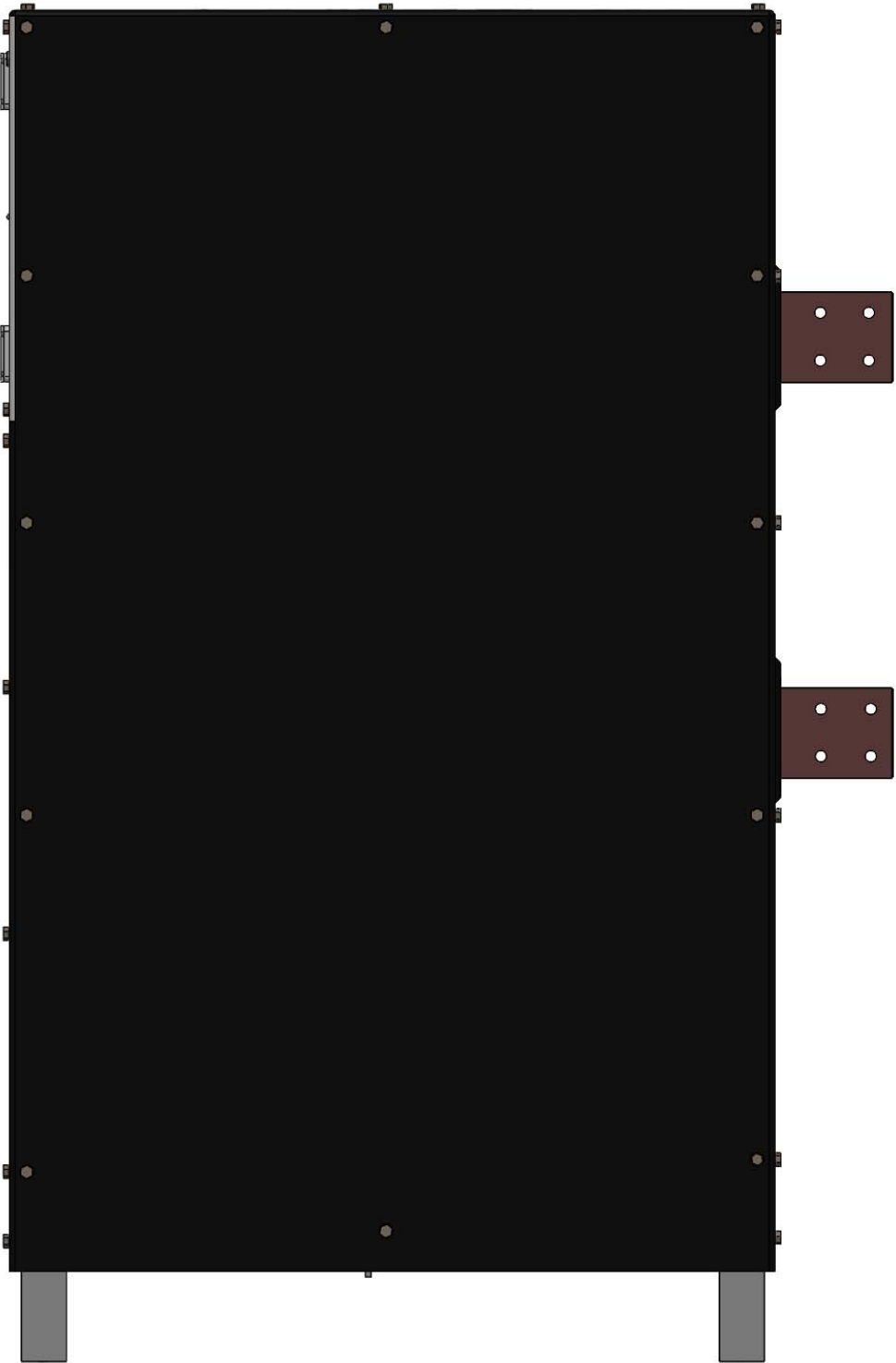

BACK

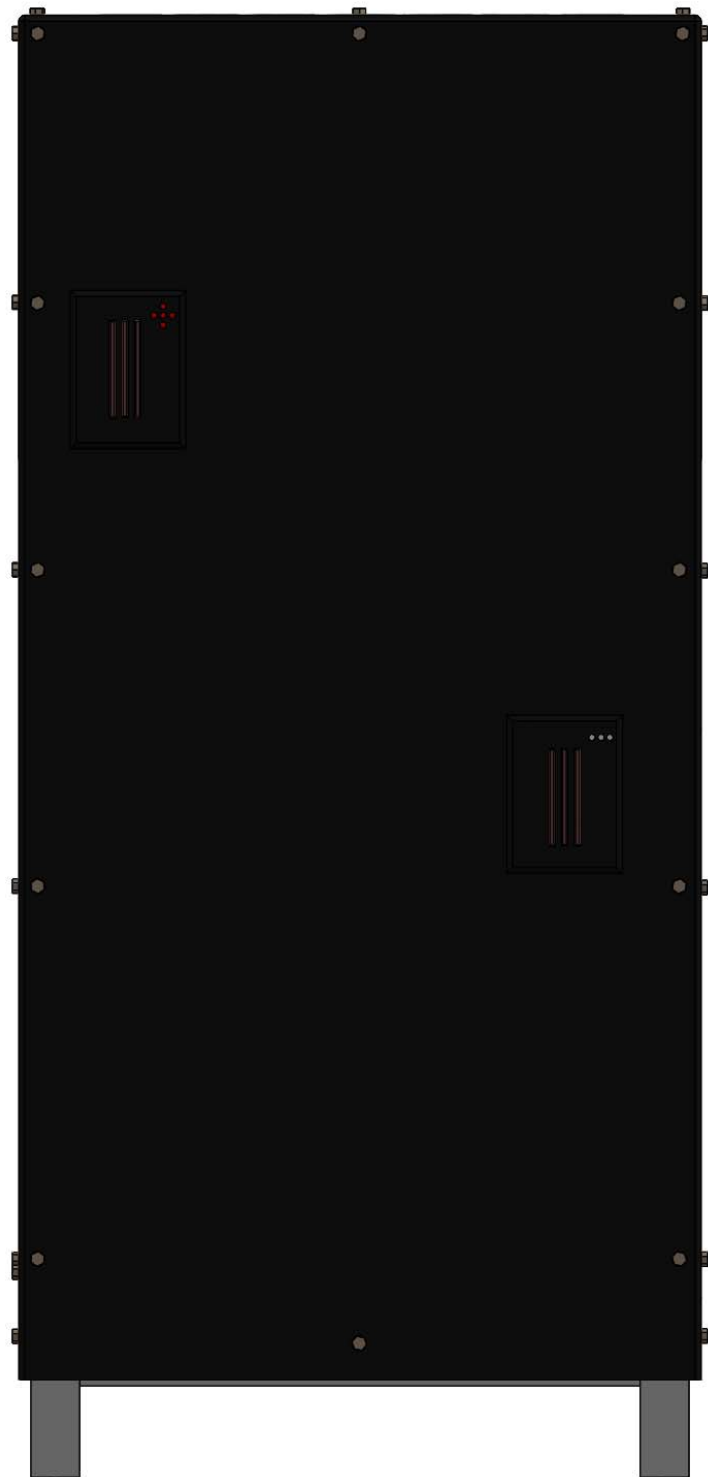

LEFT

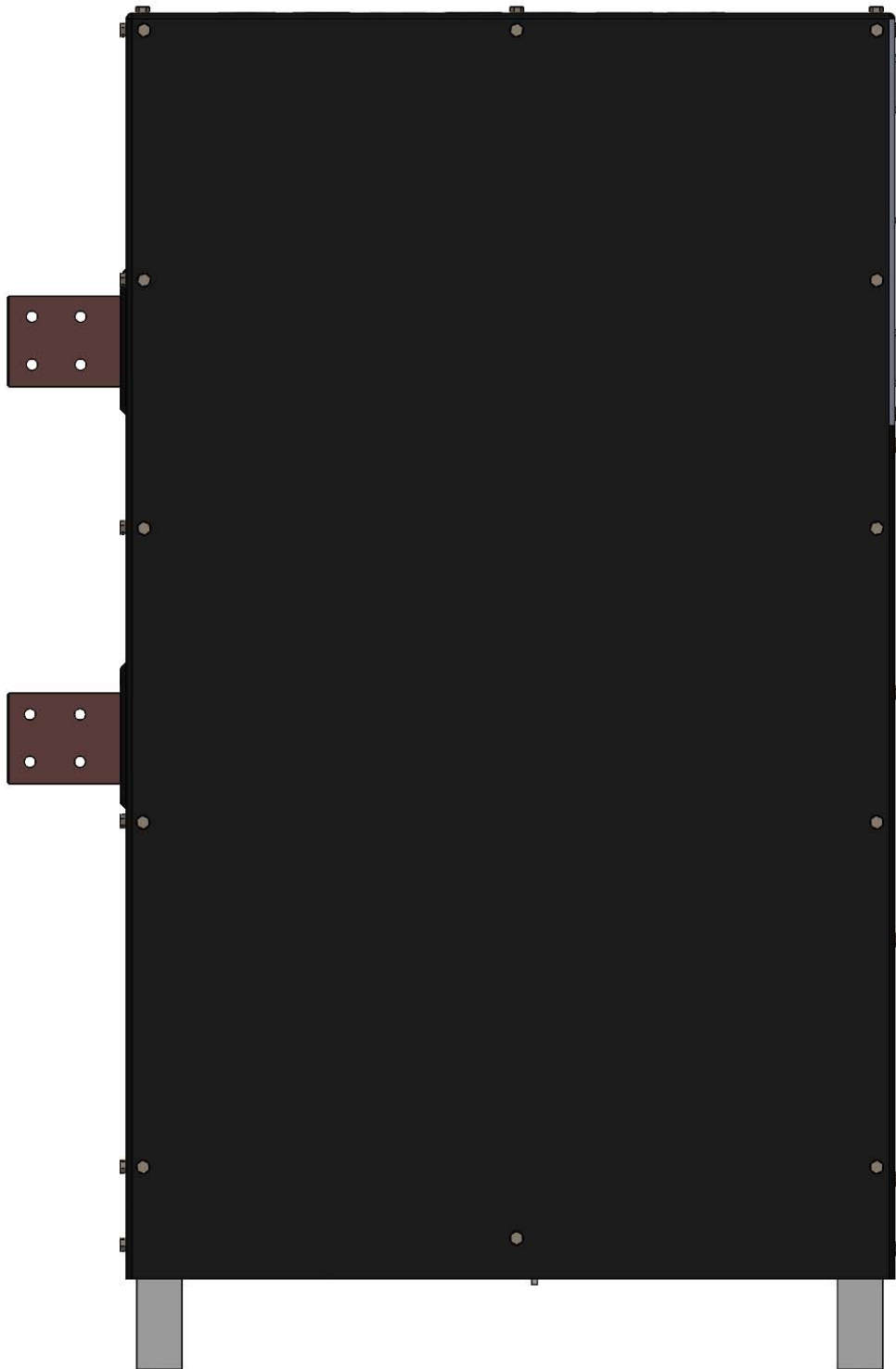

TOP

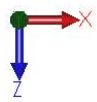
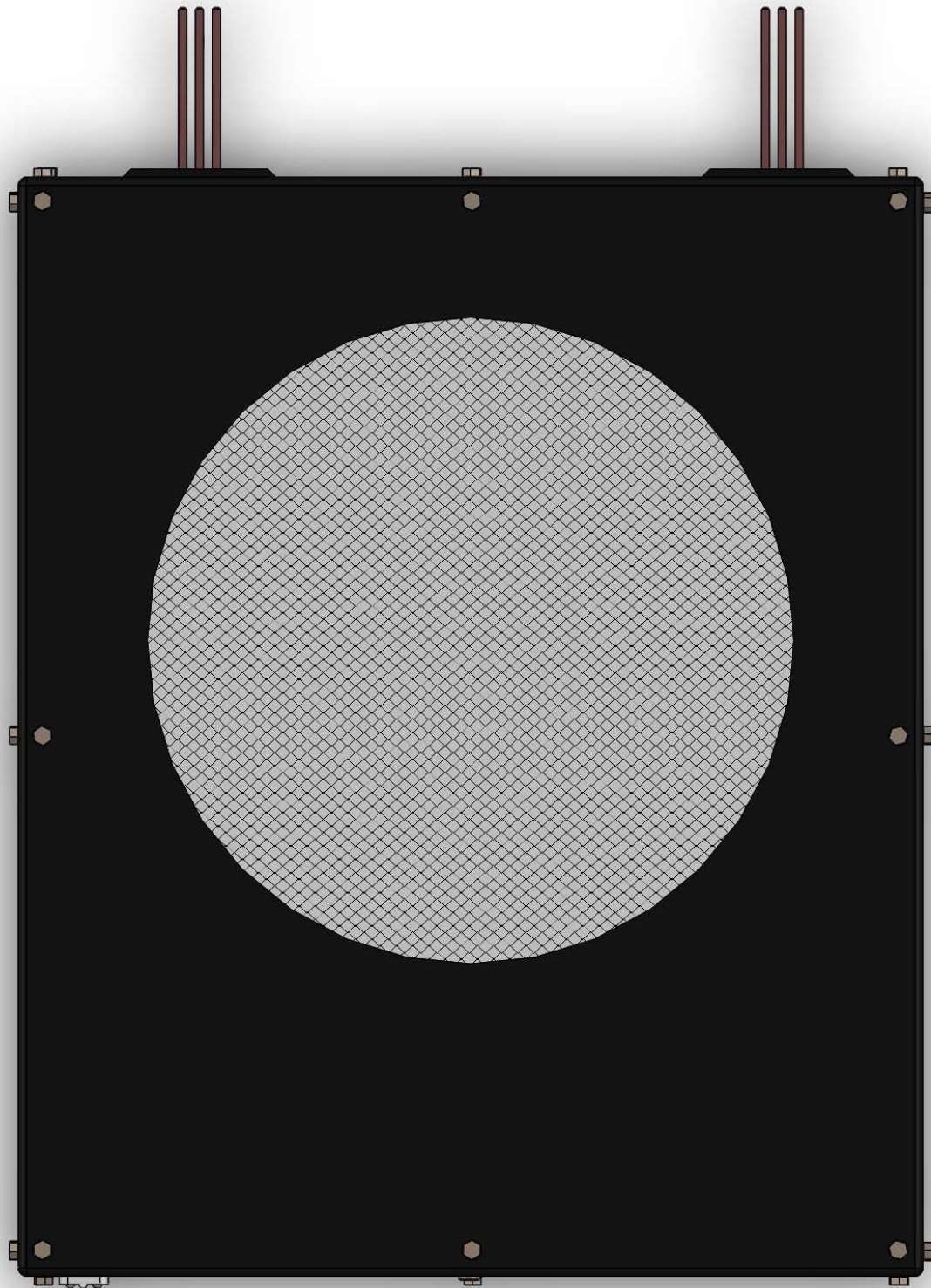

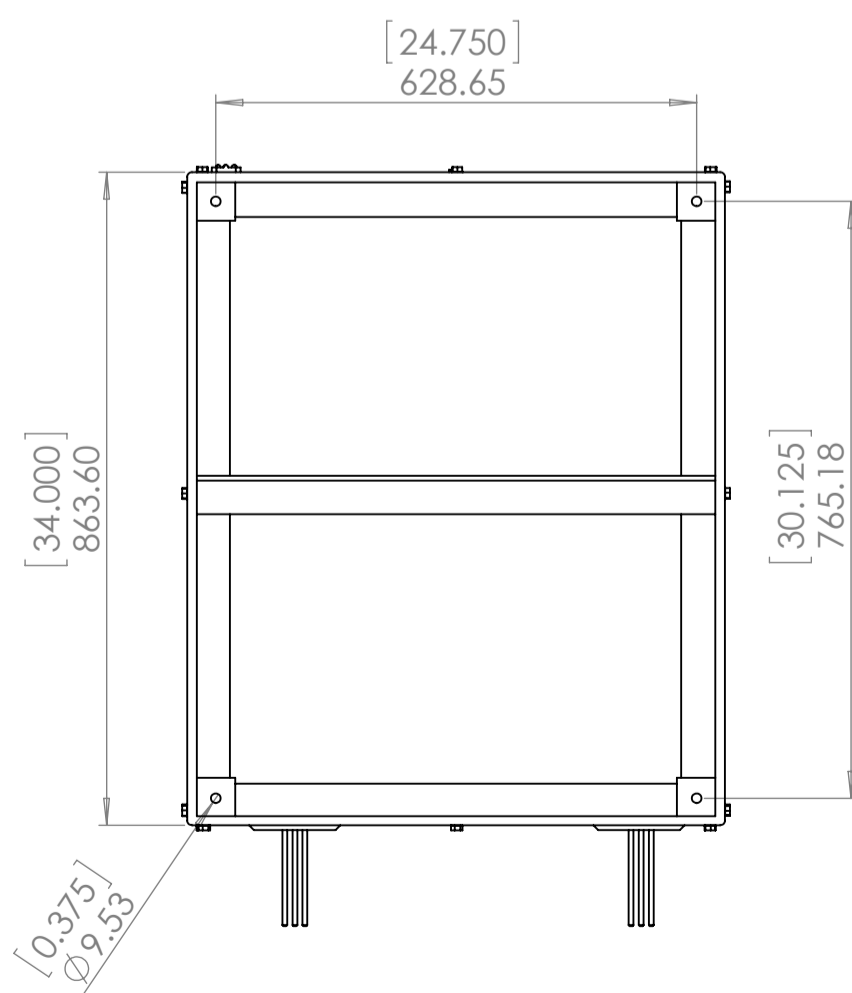
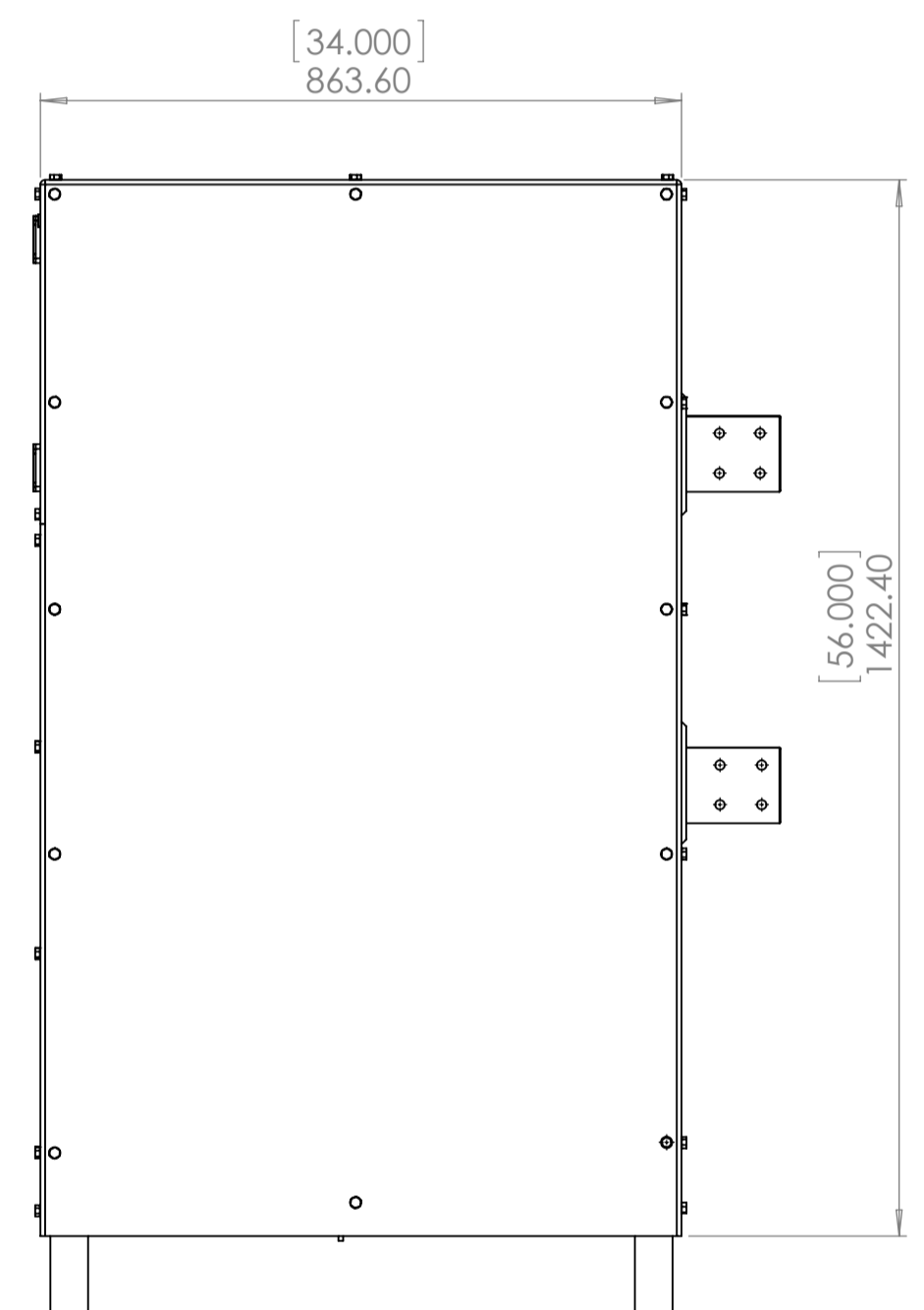
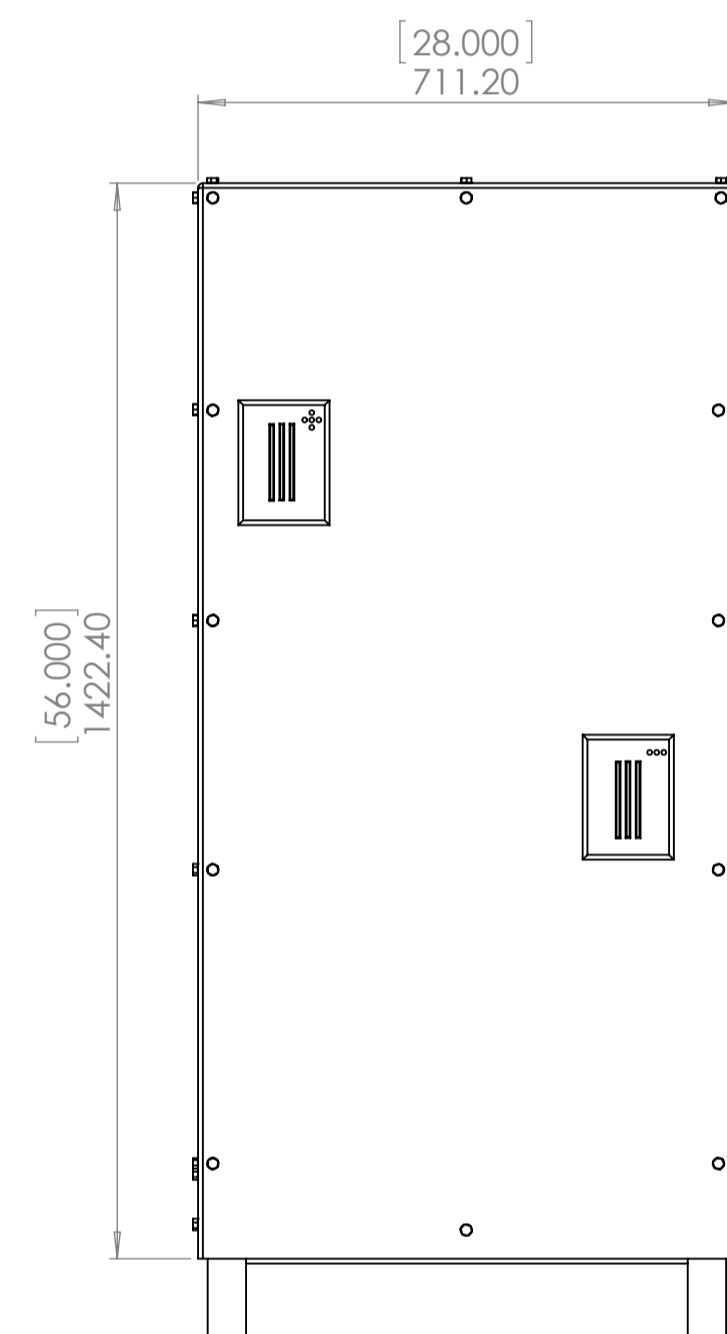
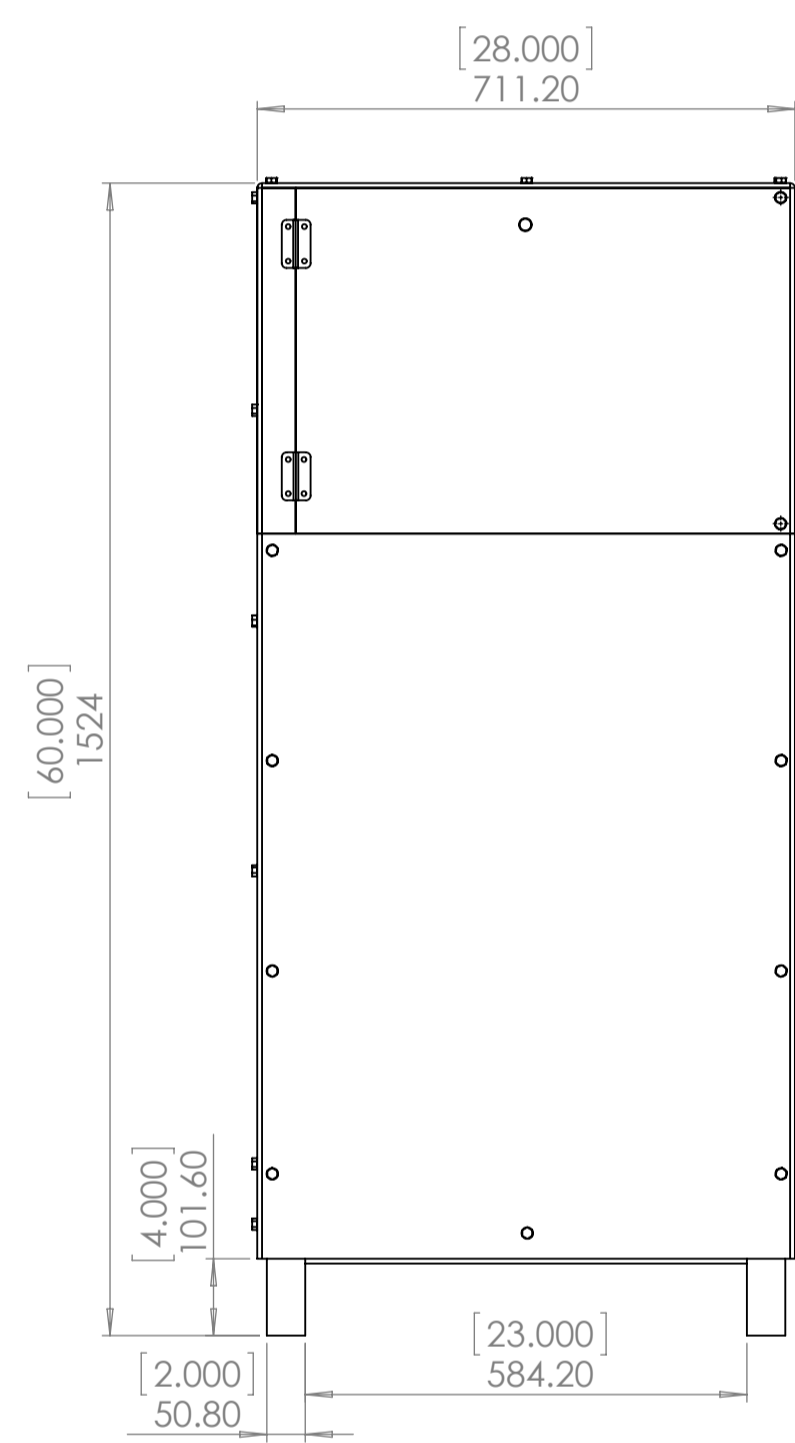
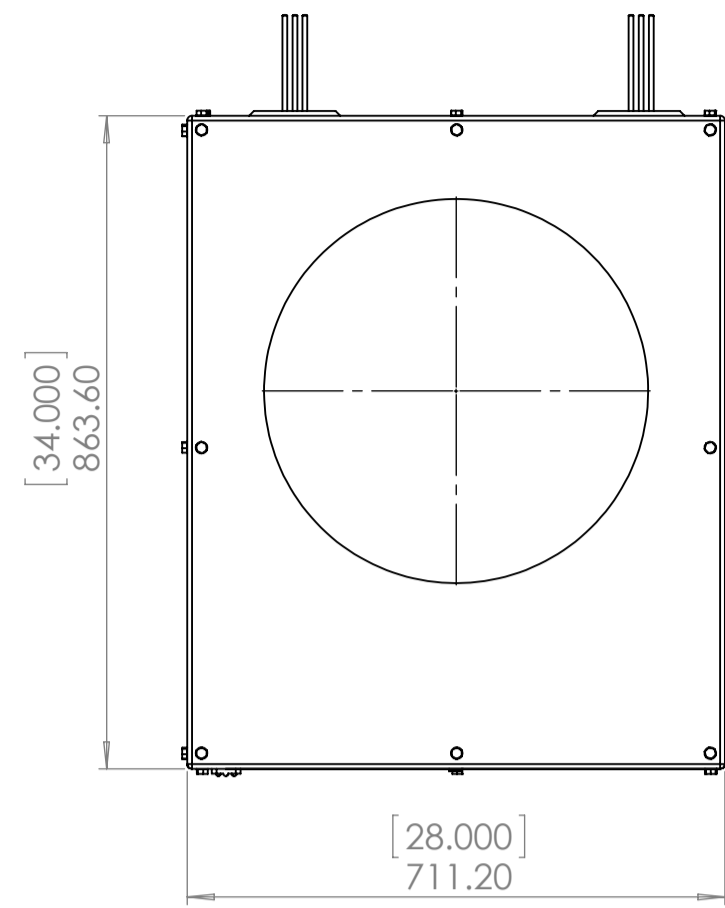
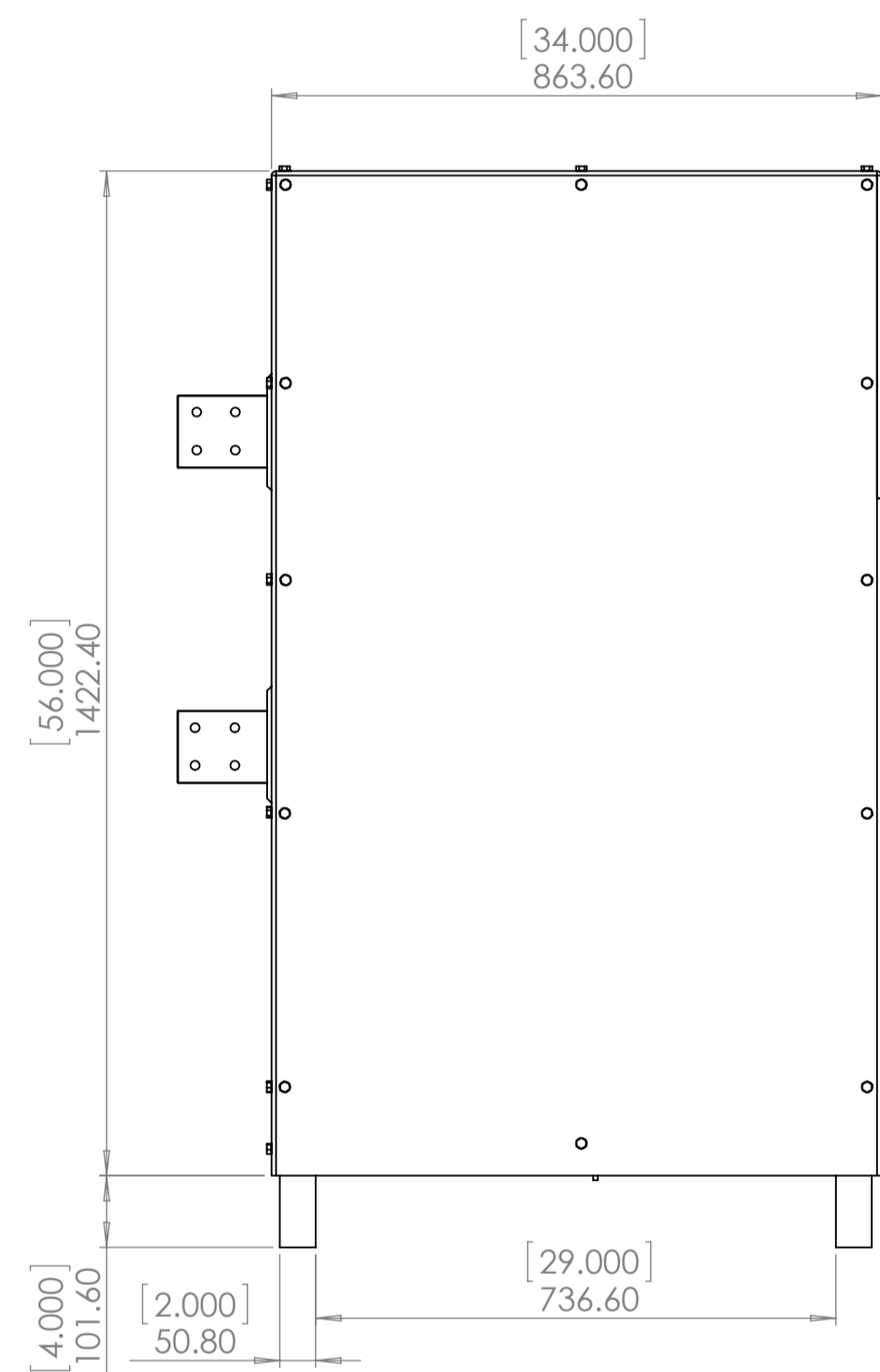

UNLESS OTHERWISE SPECIFIED: DIMENSIONS ARE IN MILLIMETERS			FINISH:	DESIR AND BREAK SHARP EDGES	DO NOT SCALE DRAWING	REVISION:
SURFACE FINISH:					ALDONEX, INC.	
TOLERANCES:					TITLE: ENCLOSURE	
LINEAR:						
ANGULAR:						
DRAWN	SO		SIGNATURE	DATE		
CHK'D	SO			6-12-19		
APP'VD:				6-12-19		
MPG						
Q.A.					MATERIAL: POLY	
					WEIGHT:	
					DWG NO. P-2A CABINET	A1
					SCALE: 1:10	SHEET 1 OF 1