



NATURAL WOVEN SHADES

Effective February 3, 2020

design simplified™

NATURAL WOVEN SHADES – TABLE OF CONTENTS

• Features & Benefits	3
• Color Charts	4-6
Pricing and Options	
• Woven Woods – Groups 1-5	7-11
• Decorative Wovens – Groups 6-9	12-15
• Privacy Linings	16
• Simplicity Rechargeable & RemoteLift™ Motorization	17
Shade Specifications	
• Standard Shade Diagram	18
• Cord Loop Shade Diagram	19
• Cordless Breeze Shade Diagram	20
• Cordless Lift Shade Diagram	21
• Configuration Options	22-23
• Faux Silk Binding and Valance Upgrades	24
• Twill Edge-Binding and Valance Upgrades	25
• Binding Features and Fabric Lists	26
• Operable and Fixed Privacy Lining Options	27
• Product Specifications	28
• Size Specifications	29-38
• Finished Dimensions and Mounting Requirements	39-40
TriLight Shades®	41-45
Tandem™ Shades	46-48
• Simplicity Rechargeable Motorization	49
• RemoteLift™ Motorization	50-51
• Product Components	52-55

Oversize Common Carrier Delivery

All orders with any quantity of shades or blinds or any continuous valance 96" or more in width are considered oversize. Therefore, a net shipping charge of \$45 per oversized unit will be assessed.

Oversized orders that require expedited shipping will be quoted and charged accordingly.

Please see General Information for additional freight and shipping charge information.

FEATURES & BENEFITS



- Woven Wood shades are offered in a wide selection of natural material styles featuring unique patterns and rich tones.
- Decorative Woven shades feature two collections. Select Weave shades are woven out of natural fibers and exotic yarns. Grass Weave shades provide a natural look, yet are constructed of unique man-made fibers for a consistent appearance.
- Durable Wood Headrail System comes pre-routed for easy installation.
- Standard swivel multi-cord lock and guided pulley system ensures smooth, long-lasting operation.
- Matching valance available in customized lengths, conceals the operating system. Woven Wood shades feature a built-in stabilizer on outside mounts.
- Antique brass finish and brackets complements the shade's natural appearance.
- Available with upgraded operating systems including top-down/bottom-up, continuous loop, cordless, and motorization for enhanced control convenience.
- Unique light and privacy controls such as TriLight Shades and Tandem provide versatile operating flexibility.
- Optional operable privacy liners or optional fixed privacy liners provide additional light control features including light filtering, room darkening and a neutral outside appearance.
- Optional twill edge-bindings and faux silk bindings frame the shade and valance using a high-quality process, and add a finishing touch.
- Limited Lifetime Warranty ensures your customers' satisfaction.

WOVEN WOODS COLOR CHART

FABRIC CODE	COLOR CODE	COLOR NAME	DOWEL SIZE	TWILL EDGE BINDING	PANEL TRACK
-------------	------------	------------	------------	--------------------	-------------

FABRIC CODE	COLOR CODE	COLOR NAME	DOWEL SIZE	TWILL EDGE BINDING	PANEL TRACK
-------------	------------	------------	------------	--------------------	-------------

PRICE GROUP 1					
CUL	2108	Bimini	1/2"	Yes	No
TER	2002	Ensenada Terra	3/4"	Yes	No
TER	2004	Jolo	1/2"	Yes	No
TER	2076	Kota	1/2"	Yes	No
TER	2078	Ensenada Tranquil	3/4"	Yes	No
TER	2110	Kano Greywood	3/4"	Yes	No
TER	2111	Kano Mahogany	3/4"	Yes	No
TER	2208	Hi-Lo Espresso	3/4"	Yes	No

PRICE GROUP 4					
CUL	2060	Saba Sunset	3/4"	Yes	No
CUL	2061	Saba Dusk	3/4"	Yes	No
CUL	2072	Hunan	3/4"	Yes	Yes
CUL	2155	Katni Intrigue	3/4"	Yes	No
CUL	2223	Mesa Mocha	3/4"	Yes	No
EXO	2052	Serengeti Sunrise	3/4"	Yes	Yes
EXO	2053	Serengeti Cocoa	3/4"	Yes	Yes
EXO	2150	Sumatra Surprise	3/4"	Yes	Yes
EXO	2232	Taos	3/4"	Yes	Yes

PRICE GROUP 2					
CUL	2099	Tortuga Coral	3/4"	Yes	No
CUL	2100	Tortuga Cocoa	3/4"	Yes	No
ELI	2049	Katmandu	1/2"	Yes	No
ELI	2059	Veracruz Earth	1/2"	Yes	No
ELI	2080	Veracruz Mocha	1/2"	Yes	No
ELI	2083	Honduras Timbre	1/2"	Yes	No
ELI	2084	Honduras Rust	1/2"	Yes	No
TER	2003	Kauai	1/2"	Yes	No
TER	2011	Sonora Desert	3/4"	Yes	Yes
TER	2057	Ensenada Negro	1/2"	Yes	No
TER	2210	Hi-Lo White	3/4"	Yes	No
TER	2211	Hi-Lo Tan	3/4"	Yes	No
TER	2212	Hi-Lo Gray	3/4"	Yes	No

PRICE GROUP 5					
CUL	2070	Tobago	3/4"	Yes	Yes
CUL	2085	Antigua Maze	1/2"	Yes	Yes
CUL	2086	Antigua Surf	1/2"	Yes	Yes
ELI	2153	Sakura Etude	3/4"	Yes	Yes
EXO	2054	Indo Chic	3/4"	Yes	Yes
EXO	2068	Kiribati Jungle	3/4"	Yes	Yes
EXO	2069	Kiribati Rainforest	3/4"	Yes	Yes
EXO	2096	Zulu	3/4"	Yes	Yes

PRICE GROUP 3					
CUL	2157	Banjar Artisan	3/4"	Yes	No
CUL	2204	Kyoto Ebony	3/4"	Yes	No
ELI	2104	Nagoya Harvest	3/4"	Yes	Yes
EXO	2151	Mandalay Mystique	3/4"	Yes	No
EXO	2230	Kyoto Sunset	3/4"	Yes	No
TER	2234	Zee Gray	3/4"	Yes	No
TER	2236	Zee Tan	3/4"	Yes	No
TER	2237	Zee White	3/4"	Yes	No

- No wood dowel under edge-binding and/or cordless lift operation
- Seam option is not available with Woven Wood Shades due to the characteristic of the material.
- A surcharge will be added for shade/valance ordered with edge binding

IMPORTANT NOTE ABOUT NATURAL WOVEN MATERIALS:

Our Woven Wood shades are uniquely constructed from natural bamboo, reeds, jutes, rattan, grasses and woods. Many materials, such as natural grasses, are hand tied and braided with expert care. Each shade is one of a kind. **Slight cracks, imperfections and variations in color are all inherent in natural products and are not considered flaws.**

Shade material may stretch slightly over time and with use depending on the material style. The average stretching amount is approximately 1/2" for every 3 feet of shade length plus or minus 1/4".

Hold-downs are not available with shades made without wood dowel bottom rail (ex. cordless lift shade, shade with edge binding, and shade under Select Weave Collection).

The irreplaceable feature and beauty of the Natural Woven Shades is it's unique variation in the material.

DECORATIVE WOVENS COLOR CHART

GRASS WEAVES (GRW) COLOR CHART						
COLOR CODE	COLOR NAME	DOWEL SIZE/ HEM BAR	FAUX SILK/ TWILL ** EDGE BINDING	TWILL EDGE BINDING*** DEFAULT COLOR	SEAM/ CUSTOM SEAM PLACEMENT	PANEL TRACK
PRICE GROUP 3						
9474	Celebes* Cornsilk	Hem Bar	Yes	Not Required	No	Yes
9475	Celebes* Seashell	Hem Bar	Yes	Not Required	No	Yes
9476	Celebes* Ivory	Hem Bar	Yes	Not Required	No	Yes
PRICE GROUP 6						
2337	Singapore Bisque	3/4"	Yes	Not Required	Yes	Yes
2338	Singapore Talc	3/4"	Yes	Not Required	Yes	Yes
2339	Singapore Cotton	3/4"	Yes	Not Required	Yes	Yes
9450	Singapore Gray	3/4"	Yes	Not Required	Yes	Yes
PRICE GROUP 7						
2304	Caracas Tortoise	3/4"	Yes	CT408 Beige	Yes	Yes
2305	Coban Parchment	3/4"	Yes	CT400 White	Yes	Yes
2310	Granada Cinnamon	3/4"	Yes	Not Required	Yes	Yes
2311	Granada Ginger	3/4"	Yes	Not Required	Yes	Yes
2312	Granada Nutmeg	3/4"	Yes	Not Required	Yes	Yes
2323	Luzon Whisper	3/4"	Yes	CT400 White	Yes	Yes
2324	Luzon Cornsilk	3/4"	Yes	CT403 Duck	Yes	Yes
2325	Luzon Greige	3/4"	Yes	CT420 Silver	Yes	Yes
2331	Nassau Pewter	3/4"	Yes	CT404 Latte	Yes	Yes
2340	St. Lucia Sand	3/4"	Yes	Not Required	Yes	Yes
2343	St. Lucia Storm	3/4"	Yes	Not Required	Yes	Yes
2345	Zaire Camel	3/4"	Yes	Not Required	NA	Yes
9410	Coban Gray	3/4"	Yes	CT420 Silver	Yes	Yes
9420	Granada Bark	3/4"	Yes	Not Required	Yes	Yes
9440	Nassau Cocoa	3/4"	Yes	CT418 Chocolate	Yes	Yes
PRICE GROUP 8						
9400	St. Kitts Dune	3/4"	Yes	CT403 Duck	Yes	Yes
9401	St. Kitts Greywood	3/4"	Yes	CT420 Silver	Yes	Yes
9460	Aruba Summer	3/4"	Yes	CT400 White	Yes	Yes
9461	Aruba Straw	3/4"	Yes	CT403 Duck	Yes	Yes
9462	Aruba Sand Dune	3/4"	Yes	CT408 Beige	Yes	Yes
9463	Aruba Driftwood	3/4"	Yes	CT420 Silver	Yes	Yes
9464	Aruba Café	3/4"	Yes	CT419 Espresso	Yes	Yes
9470	Martinique White Wash	3/4"	Yes	CT400 White	Yes	Yes
9471	Martinique Sea Grass	3/4"	Yes	CT403 Duck	Yes	Yes
9472	Martinique Surf	3/4"	Yes	CT420 Silver	Yes	Yes
9473	Martinique Coral	3/4"	Yes	CT409 Jute	Yes	Yes

* Not available under motorization and head rail can't be wrapped.

** No wood dowel with twill edge-binding

*** A surcharge must be added for all patterns that require twill edge binding or shade/valance ordered with edge

NOTE:

- Hold-downs are not available with shades made without wood dowel bottom rail (ex. cordless, shades with edge binding, and Select Weaves)
- The irreplaceable feature and beauty of the Natural Woven Shades is it's unique variation in the material.

DECORATIVE WOVENS COLOR CHART

SELECT WEAVES (SLW) COLOR CHART						
COLOR CODE	COLOR NAME	HEM BAR	FAUX SILK/ TWILL EDGE BINDING	TWILL EDGE BINDING** DEFAULT COLOR	SEAM/ CUSTOM SEAM PLACEMENT	PANEL TRACK
PRICE GROUP 8						
2420	Macau	Yes	Yes	Not Required	NA	Yes
2423	Mali Tan	Yes	Yes	Not Required	NA	Yes
2438	Suva	Yes	Yes	Not Required	NA	Yes
2526	Salvador Driftwood	Yes	Yes	Not Required	Yes	Yes
2527	Cancun Light Gray	Yes	Yes	CT403 Duck	NA	Yes
2528	Cancun Off White	Yes	Yes	CT402 Natural	NA	Yes
2529	Cano Cream	Yes	Yes	Not Required	NA	Yes
2530	Madeira Green	Yes	Yes	Not Required	NA	Yes
2531	Rio Gray	Yes	Yes	Not Required	NA	Yes
PRICE GROUP 9						
2411	Jaipur Natural	Yes	Yes	Not Required	NA	Yes
2417	Lagos	Yes	Yes	Not Required	NA	Yes
2419	Lomaloma	Yes	Yes	Not Required	NA	Yes
2431	Santos Natural	Yes	Yes	Not Required	NA	Yes
2433	Sintra Dust	Yes	Yes	Not Required	NA	Yes
2441	Tunisia	Yes	Yes	Not Required	NA	Yes

** A surcharge must be added for all patterns that require twill edge binding or shade/valance ordered with edge

NOTE:

- Hold-downs are not available with shades made without wood dowel bottom rail (ex. cordless, shades with edge binding, and Select Weaves)
- The irreplaceable feature and beauty of the Natural Woven Shades is it's unique variation in the material.

CUL
2108 Bimini

TER
2002 Ensenada Terra
2004 Jolo
2076 Kota
2078 Ensenada Tranquil
2110 Kano Greywood
2111 Kano Mahogany
2208 Hi-Lo Espresso

GROUP 1

WIDTH TO:	24"	30"	36"	42"	48"	54"	60"	66"	72"	78"	84"	90"	96"
HEIGHT TO:													
36"	\$121	155	163	190	199	218	234	271	294	323	354	382	414
42"	150	158	168	196	203	228	245	285	310	354	369	401	435
48"	153	163	172	203	207	237	253	294	323	371	388	423	458
54"	157	167	175	207	217	244	263	307	336	386	406	441	476
61"	160	178	195	219	245	253	274	321	348	406	419	459	498
66"	166	182	202	225	254	260	284	331	363	417	436	472	519
72"	169	188	209	233	260	270	293	344	375	438	453	493	533
78"	190	211	234	262	285	306	331	366	401	467	486	528	576
84"	200	225	247	278	301	325	354	405	429	502	518	566	621
90"	210	238	262	292	320	346	376	432	458	533	558	611	645
96"	223	251	278	313	337	370	401	459	489	572	598	639	672
108"	240	270	302	337	370	406	436	507	538	633	643	673	708

RemoteLift Shades: Single battery wand size recommendation limit is 16 sq.ft., dual battery wand or transformer is RECOMMENDED for shade greater than 16 sq.ft.

INDIVIDUAL VALANCE PRICING (AND OVER 12" HEIGHT SHADE VALANCE PRICING)

- ① Use this grid to price your INDIVIDUAL valance.
- ② Use this grid to price your extra high (above 12") SHADE valance as follows: For SHADE valance heights over 12", ADD extra height from this grid to your SHADE price from grid above. Example: For a 16" high SHADE valance, ADD the 4" price below to your SHADE price above.

WIDTH TO:	24"	30"	36"	42"	48"	54"	60"	66"	72"	78"	84"	90"	96"
HEIGHT TO:													
4"	\$45	48	51	53	58	66	72	80	84	91	99	106	112
6"	47	50	55	58	67	73	81	88	97	102	109	117	125
8"	49	56	59	66	72	81	89	97	106	115	121	129	141
10"	51	62	70	70	80	89	97	106	116	124	134	139	148
12"	52	68	71	76	87	97	111	116	125	136	137	144	150
16"	81	96	112	127	145	160	177	194	209	225	242	260	274
18"	84	100	117	134	151	168	185	202	221	238	253	270	289
20"	88	104	123	141	157	176	194	211	229	247	264	284	301
22"	91	107	127	146	165	185	202	222	240	258	278	294	313
24"	97	113	131	151	171	190	210	229	249	269	289	309	326

Note: Individual valances are built on the large 2-1/2" depth headrail unless specified. Returns are standard on outside mounts.

PRIVACY LINING PRICING (ALL PRICE GROUPS) SEE PAGE 16.

MOTORIZATION PRICING (ALL PRICE GROUPS) SEE PAGE 17.

TRILIGHT SHADES OPTION (SEE PAGES 35-39)

TANDEM SHADES OPTION (SEE PAGES 40-42)

OPTIONS: NO CHARGE
<ul style="list-style-type: none"> • Valance Returns for Inside Mounts • Valance Custom Heights to 12" • Control Positions (R or L) • Extension Brackets • Hold Down Brackets • Cord Cleats (standard on Top-Down and Top-Down/Bottom-Up shades) • Cut-outs – maximum size 3" x 8" on bottom of shade (left or right side)

OPTIONS: EXTRA CHARGE
<ul style="list-style-type: none"> • 2 On 1 Headrail.....Price as 2 separate shades and add \$62 • 3 On 1 Headrail.....Price as 3 separate shades and add \$76 • Top-Down add \$54 • Top-Down/Bottom-Up add \$61 • Continuous Cord Loop add \$80 • Cordless Breeze add \$95 • Cordless Lift..... add \$110 • Operable Lining – add to grid size liner pricing..... add \$104 • Twill Edge-Binding – Shade & Valance (ETO, TSVB, TS) ... add \$101 – Shade Only (TSB, TSO) add \$64 – Valance Only (TVSB, TVSO)..... add \$38

CUL	ELI	TER
2099 Tortuga Coral	2049 Katmandu	2003 Kauai
2100 Tortuga Cocoa	2059 Veracruz Earth	2011 Sonora Desert
	2080 Veracruz Mocha	2057 Ensenada Negro
	2083 Honduras Timbre	2210 Hi-Lo White
	2084 Honduras Rust	2211 Hi-Lo Tan
		2212 Hi-Lo Gray

GROUP 2

WIDTH TO:	24"	30"	36"	42"	48"	54"	60"	66"	72"	78"	84"	90"	96"
HEIGHT TO:													
36"	\$140	203	223	247	259	286	305	336	370	408	449	487	511
42"	189	210	232	257	269	298	322	356	389	449	468	512	538
48"	198	218	240	268	274	311	331	373	409	477	496	540	566
54"	204	226	247	277	290	326	337	389	428	496	523	574	599
61"	209	234	258	287	309	338	364	407	449	518	544	603	631
66"	218	242	269	297	319	349	383	423	466	538	573	621	650
72"	222	251	273	306	326	363	395	441	485	561	588	651	682
78"	235	263	295	332	358	392	424	476	523	607	643	706	738
84"	251	281	318	355	388	425	455	508	560	658	665	730	764
90"	265	302	336	380	416	453	490	544	603	685	697	761	802
96"	279	319	360	405	442	485	528	583	634	714	714	761	802
108"	306	350	392	449	485	530	583	624	669	764	764	806	859

RemoteLift Shades: Single battery wand size recommendation limit is 16 sq.ft., dual battery wand or transformer is RECOMMENDED for shade greater than 16 sq.ft.

INDIVIDUAL VALANCE PRICING (AND OVER 12" HEIGHT SHADE VALANCE PRICING)

- Use this grid to price your INDIVIDUAL valance.
- Use this grid to price your extra high (above 12") SHADE valance as follows: For SHADE valance heights over 12", ADD extra height from this grid to your SHADE price from grid above. Example: For a 16" high SHADE valance, ADD the 4" price below to your SHADE price above.

WIDTH TO:	24"	30"	36"	42"	48"	54"	60"	66"	72"	78"	84"	90"	96"
HEIGHT TO:													
4"	\$49	53	58	63	66	71	80	87	93	102	108	116	124
6"	51	58	62	67	72	84	91	100	106	116	124	132	141
8"	53	61	71	72	84	92	102	111	120	131	139	150	157
10"	54	67	75	84	92	103	112	124	133	143	155	164	175
12"	55	74	78	89	93	111	120	132	139	152	156	178	206
16"	89	108	128	148	164	183	202	220	238	258	274	295	313
18"	95	114	134	155	174	193	213	234	251	273	291	310	331
20"	100	120	142	162	184	203	223	246	265	287	305	328	348
22"	104	128	150	172	193	213	235	257	278	300	322	344	364
24"	108	132	155	177	202	222	246	269	291	313	335	358	381

Note: Individual valances are built on the large 2-1/2" depth headrail unless specified. Returns are standard on outside mounts.

PRIVACY LINING PRICING (ALL PRICE GROUPS) SEE PAGE 16.

MOTORIZATION PRICING (ALL PRICE GROUPS) SEE PAGE 17.

TRILIGHT SHADES OPTION (SEE PAGES 35-39)

TANDEM SHADES OPTION (SEE PAGES 40-42)

OPTIONS: NO CHARGE
• Valance Returns for Inside Mounts
• Valance Custom Heights to 12"
• Control Positions (R or L)
• Extension Brackets
• Hold Down Brackets
• Cord Cleats (standard on Top-Down and Top-Down/Bottom-Up shades)
• Cut-outs – maximum size 3" x 8" on bottom of shade (left or right side)

OPTIONS: EXTRA CHARGE
• 2 On 1 Headrail.....Price as 2 separate shades and add \$62
• 3 On 1 Headrail.....Price as 3 separate shades and add \$76
• Top-Down add \$54
• Top-Down/Bottom-Up add \$61
• Continuous Cord Loop add \$80
• Cordless Breeze add \$95
• Cordless Lift..... add \$110
• Operable Lining – add to grid size liner pricing..... add \$104
• Twill Edge-Binding – Shade & Valance (ETO, TSVB, TS) ... add \$101
– Shade Only (TSB, TSO) add \$64
– Valance Only (TVSB, TVSO)..... add \$38

CUL 2157 Banjar Artisan 2204 Kyoto Ebony	ELI 2104 Nagoya Harvest	EXO 2151 Mandalay Mystique 2230 Kyoto Sunset	GRW 9474 Celebes Cornsilk 9475 Celebes Seashell 9476 Celebes Ivory	TER 2234 Zee Gray 2236 Zee Tan 2237 Zee White
-------------------------------------------------------	-----------------------------------	-----------------------------------------------------------	------------------------------------------------------------------------------------	---------------------------------------------------------------

GROUP 3

WIDTH TO:	24"	30"	36"	42"	48"	54"	60"	66"	72"	78"	84"	90"	96"
HEIGHT TO:													
36"	\$194	230	251	282	296	329	357	397	440	484	530	578	605
42"	215	240	262	297	304	354	381	422	466	533	564	618	652
48"	223	251	272	309	313	371	403	442	489	563	600	656	692
54"	230	262	278	322	338	389	411	467	517	603	635	697	726
61"	238	273	300	335	370	408	440	491	547	634	665	736	777
66"	250	281	316	357	392	423	463	516	576	665	697	771	811
72"	255	291	328	371	407	448	485	543	595	688	733	814	856
78"	274	313	354	398	436	481	523	579	645	750	804	841	895
84"	294	333	380	426	472	520	560	624	705	811	833	886	938
90"	313	358	404	463	510	558	607	682	758	840	872	928	970
96"	336	384	436	492	549	604	654	733	793	875	906	960	1004
108"	365	424	482	552	611	672	727	799	849	952	972	1042	1095

RemoteLift Shades: Single battery wand size recommendation limit is 16 sq.ft (Woven Woods) or 65 sq.ft. (Grass Weaves); dual battery wand or transformer is RECOMMENDED for shade exceed the limit.

INDIVIDUAL VALANCE PRICING (AND OVER 12" HEIGHT SHADE VALANCE PRICING)

- 1 Use this grid to price your INDIVIDUAL valance.
- 2 Use this grid to price your extra high (above 12") SHADE valance as follows: For SHADE valance heights over 12", ADD extra height from this grid to your SHADE price from grid above. Example: For a 16" high SHADE valance, ADD the 4" price below to your SHADE price above.

WIDTH TO:	24"	30"	36"	42"	48"	54"	60"	66"	72"	78"	84"	90"	96"
HEIGHT TO:													
4"	\$51	61	64	72	80	85	95	111	115	125	140	157	183
6"	58	63	71	80	84	93	110	114	124	139	153	168	196
8"	61	70	78	83	91	108	112	124	138	151	164	192	210
10"	62	75	81	89	100	111	121	135	147	159	177	200	213
12"	67	75	82	93	106	116	126	141	150	162	187	211	216
16"	106	131	151	174	198	218	240	262	284	306	329	350	375
18"	114	139	160	185	209	232	257	279	303	328	350	375	398
20"	121	149	172	198	223	247	273	297	322	348	373	397	424
22"	129	155	181	207	235	261	289	313	340	369	395	422	449
24"	134	163	189	219	247	273	303	332	358	388	417	442	472

Note: Individual valances are built on the large 2-1/2" depth headrail unless specified. Returns are standard on outside mounts.

PRIVACY LINING PRICING (ALL PRICE GROUPS) SEE PAGE 16.

MOTORIZATION PRICING (ALL PRICE GROUPS) SEE PAGE 17.

TRILIGHT SHADES OPTION (SEE PAGES 35-39)

TANDEM SHADES OPTION (SEE PAGES 40-42)

OPTIONS: NO CHARGE
• Valance Returns for Inside Mounts
• Valance Custom Heights to 12"
• Control Positions (R or L)
• Extension Brackets
• Hold Down Brackets
• Cord Cleats (standard on Top-Down and Top-Down/Bottom-Up shades)
• Cut-outs – maximum size 3" x 8" on bottom of shade (left or right side)

OPTIONS: EXTRA CHARGE
• 2 On 1 Headrail.....Price as 2 separate shades and add \$62
• 3 On 1 Headrail.....Price as 3 separate shades and add \$76
• Top-Down add \$54
• Top-Down/Bottom-Up add \$61
• Continuous Cord Loop add \$80
• Cordless Breeze..... add \$95
• Cordless Lift..... add \$110
• Operable Lining – add to grid size liner pricing add \$104
• Faux Silk Binding Option – Default - All add \$156
– Custom Placement..... add \$103
– Valance Only add \$52
• Twill Edge-Binding Option – Shade & Valance add \$101
– Shade Only add \$64
– Valance Only add \$38

- | | |
|---------------------|------------------------|
| CUL | EXO |
| 2060 Saba Sunset | 2052 Serengeti Sunrise |
| 2061 Saba Dusk | 2053 Serengeti Cocoa |
| 2072 Hunan | 2150 Sumatra Surprise |
| 2155 Katni Intrigue | 2232 Taos |
| 2223 Mesa Mocha | |

GROUP 4

WIDTH TO:	24"	30"	36"	42"	48"	54"	60"	66"	72"	78"	84"	90"	96"
HEIGHT TO:													
36"	\$212	251	279	311	341	369	403	445	491	547	603	658	695
42"	234	262	294	331	360	397	428	472	524	604	641	705	740
48"	246	274	309	349	378	414	451	503	555	641	681	753	792
54"	254	291	320	365	397	440	477	537	589	683	726	799	832
61"	265	302	347	384	432	461	503	561	624	719	767	849	890
66"	273	318	362	404	452	487	533	589	656	750	806	895	936
72"	284	329	372	422	462	511	555	621	685	797	850	936	990
78"	305	354	400	456	507	551	603	677	749	868	922	979	1034
84"	331	383	433	489	548	599	654	733	814	947	972	1033	1092
90"	354	408	464	525	583	643	705	789	887	986	1017	1078	1137
96"	377	440	502	572	636	702	761	862	929	1025	1058	1117	1189
108"	422	492	558	639	708	782	852	934	1004	1110	1148	1215	1295

RemoteLift Shades: Single battery wand size recommendation limit is 16 sq.ft., dual battery wand or transformer is RECOMMENDED for shade greater than 16 sq.ft.

INDIVIDUAL VALANCE PRICING (AND OVER 12" HEIGHT SHADE VALANCE PRICING)

- Use this grid to price your INDIVIDUAL valance.
- Use this grid to price your extra high (above 12") SHADE valance as follows: For SHADE valance heights over 12", ADD extra height from this grid to your SHADE price from grid above. Example: For a 16" high SHADE valance, ADD the 4" price below to your SHADE price above.

WIDTH TO:	24"	30"	36"	42"	48"	54"	60"	66"	72"	78"	84"	90"	96"
HEIGHT TO:													
4"	\$53	54	62	71	80	88	97	105	116	124	133	142	151
6"	58	63	75	85	95	106	117	128	139	150	160	172	181
8"	62	75	87	100	111	124	136	150	162	175	177	181	195
10"	68	84	89	105	113	129	142	157	166	176	182	198	203
12"	70	84	92	109	115	132	146	159	170	181	185	203	207
16"	121	148	172	198	222	247	271	295	324	348	373	397	423
18"	131	155	184	210	238	265	291	318	346	373	400	426	452
20"	139	168	195	226	254	282	311	338	370	398	426	455	485
22"	149	177	207	240	271	302	332	361	392	424	453	485	515
24"	155	186	219	254	286	318	349	381	417	449	481	512	544

Note: Individual valances are built on the large 2-1/2" depth headrail unless specified. Returns are standard on outside mounts.

PRIVACY LINING PRICING (ALL PRICE GROUPS) SEE PAGE 16.

MOTORIZATION PRICING (ALL PRICE GROUPS) SEE PAGE 17.

TRILIGHT SHADES OPTION (SEE PAGES 35-39)

TANDEM SHADES OPTION (SEE PAGES 40-42)

OPTIONS: NO CHARGE
• Valance Returns for Inside Mounts
• Valance Custom Heights to 12"
• Control Positions (R or L)
• Extension Brackets
• Hold Down Brackets
• Cord Cleats (standard on Top-Down and Top-Down/Bottom-Up shades)
• Cut-outs – maximum size 3" x 8" on bottom of shade (left or right side)

OPTIONS: EXTRA CHARGE
• 2 On 1 Headrail.....Price as 2 separate shades and add \$62
• 3 On 1 Headrail.....Price as 3 separate shades and add \$76
• Top-Down add \$54
• Top-Down/Bottom-Up add \$61
• Continuous Cord Loop add \$80
• Cordless Breeze..... add \$95
• Cordless Lift..... add \$110
• Operable Lining – add to grid size liner pricing..... add \$104
• Twill Edge-Binding – Shade & Valance (ETO, TSVB, TS) ... add \$101
– Shade Only (TSB, TSO) add \$64
– Valance Only (TVSB, TVSO)..... add \$38

CUL	ELI	EXO
2070 Tobago	2153 Sakura Etude	2054 Indo Chic
2085 Antigua Maze		2068 Kiribati Jungle
2086 Antigua Surf		2069 Kiribati Rainforest
		2096 Zulu

GROUP 5

WIDTH TO:	24"	30"	36"	42"	48"	54"	60"	66"	72"	78"	84"	90"	96"
HEIGHT TO:													
36"	\$229	270	303	340	374	405	443	492	545	610	667	732	772
42"	250	287	324	366	400	433	472	528	586	670	718	789	832
48"	266	303	342	388	427	467	509	570	632	718	770	845	892
54"	275	322	362	408	441	496	538	607	670	770	823	910	957
61"	292	335	386	432	482	523	571	640	709	821	878	963	1027
66"	303	354	403	454	511	554	607	674	751	859	928	1015	1080
72"	314	370	419	478	520	585	635	716	802	916	978	1081	1143
78"	342	396	454	516	572	632	692	782	865	992	1074	1136	1209
84"	366	428	490	558	617	687	755	841	944	1097	1130	1188	1264
90"	394	463	531	604	669	744	819	919	1028	1149	1181	1261	1337
96"	427	498	577	648	728	797	882	999	1073	1199	1238	1313	1401
108"	476	554	639	736	820	908	1004	1074	1163	1291	1350	1423	1507

RemoteLift Shades: Single battery wand size recommendation limit is 16 sq.ft., dual battery wand or transformer is RECOMMENDED for shade greater than 16 sq.ft.

INDIVIDUAL VALANCE PRICING (AND OVER 12" HEIGHT SHADE VALANCE PRICING)

- Use this grid to price your INDIVIDUAL valance.
- Use this grid to price your extra high (above 12") SHADE valance as follows: For SHADE valance heights over 12", ADD extra height from this grid to your SHADE price from grid above. Example: For a 16" high SHADE valance, ADD the 4" price below to your SHADE price above.

WIDTH TO:	24"	30"	36"	42"	48"	54"	60"	66"	72"	78"	84"	90"	96"
HEIGHT TO:													
4"	\$61	62	67	75	85	97	105	116	124	133	143	153	163
6"	64	67	83	93	106	118	129	142	153	166	177	189	181
8"	67	70	89	102	112	128	141	159	165	182	189	193	198
10"	71	72	91	108	119	137	148	164	172	185	193	202	210
12"	73	88	93	112	121	141	152	167	176	188	196	212	220
16"	137	165	193	221	249	276	307	335	363	391	420	448	476
18"	148	177	207	240	270	300	331	362	392	423	453	485	514
20"	159	192	224	257	290	324	356	389	421	453	489	519	551
22"	170	204	240	273	309	344	379	416	450	485	520	555	589
24"	178	216	251	292	328	365	404	440	477	514	554	589	626

Note: Individual valances are built on the large 2-1/2" depth headrail unless specified. Returns are standard on outside mounts.

PRIVACY LINING PRICING (ALL PRICE GROUPS) SEE PAGE 16.

MOTORIZATION PRICING (ALL PRICE GROUPS) SEE PAGE 17.

TRILIGHT SHADES OPTION (SEE PAGES 35-39)

TANDEM SHADES OPTION (SEE PAGES 40-42)

OPTIONS: NO CHARGE
• Valance Returns for Inside Mounts
• Valance Custom Heights to 12"
• Control Positions (R or L)
• Extension Brackets
• Hold Down Brackets
• Cord Cleats (standard on Top-Down and Top-Down/Bottom-Up shades)
• Cut-outs – maximum size 3" x 8" on bottom of shade (left or right side)

OPTIONS: EXTRA CHARGE
• 2 On 1 Headrail.....Price as 2 separate shades and add \$62
• 3 On 1 Headrail.....Price as 3 separate shades and add \$76
• Top-Down add \$54
• Top-Down/Bottom-Up add \$61
• Continuous Cord Loop add \$80
• Cordless Breeze add \$95
• Cordless Lift..... add \$110
• Operable Lining – add to grid size liner pricing..... add \$104
• Twill Edge-Binding – Shade & Valance (ETO, TSVB, TS) ... add \$101
– Shade Only (TSB, TSO) add \$64
– Valance Only (TVSB, TVSO)..... add \$38

Grass Weave*
2337 Singapore Bisque
2338 Singapore Talc
2339 Singapore Cotton
9450 Singapore Gray

GROUP 6

* Most Grass Weave shades are available up to 72" widths without a seam.

WIDTH TO:	24"	30"	36"	42"	48"	54"	60"	66"	72"	78"	84"	90"	96"	108"	120"
HEIGHT TO:															
36"	\$267	301	331	371	405	432	472	528	587	648	714	782	819	868	920
42"	278	313	348	391	430	464	504	559	624	718	762	840	886	940	996
48"	291	328	366	413	448	490	535	588	655	760	812	894	941	997	1057
54"	301	344	379	428	470	515	558	626	695	815	859	949	987	1047	1110
61"	311	356	398	453	495	542	584	657	734	856	901	1004	1063	1128	1194
66"	326	370	414	472	523	560	617	691	773	902	944	1056	1112	1178	1249
72"	335	381	431	492	541	593	644	728	803	935	996	1114	1176	1247	1321
78"	361	413	466	529	581	639	698	780	873	1024	1101	1152	1230	1304	1383
84"	384	442	506	568	632	697	752	846	960	1117	1144	1213	1286	1364	1447
90"	414	476	540	621	687	751	819	925	1040	1154	1198	1274	1331	1410	1495
96"	448	513	586	665	741	817	891	1003	1088	1203	1242	1320	1379	1462	1550
108"	493	570	650	750	831	915	993	1094	1165	1312	1335	1437	1510	1601	1697
120"	521	604	689	794	882	970	1050	1160	1233	1390	1415	1523	1601	1696	1797

RemoteLift Shades: Single battery wand size recommendation limit is 65 sq.ft., dual battery wand or transformer is RECOMMENDED for shade greater than 65 sq.ft.

Shades over 96" are available in most styles with a center seam. See size specifications section for details.

INDIVIDUAL VALANCE PRICING (AND OVER 12" HEIGHT SHADE VALANCE PRICING)

- 1 Use this grid to price your INDIVIDUAL valance.
- 2 Use this grid to price your extra high (above 12") SHADE valance as follows: For SHADE valance heights over 12", ADD extra height from this grid to your SHADE price from grid above. Example: For a 16" high SHADE valance, ADD the 4" price below to your SHADE price above.

WIDTH TO:	24"	30"	36"	42"	48"	54"	60"	66"	72"	78"	84"	90"	96"	108"	120"
HEIGHT TO:															
4"	\$52	57	62	66	70	76	84	91	97	106	115	120	127	135	143
6"	55	58	64	73	82	90	100	107	116	124	134	143	150	159	168
8"	57	63	71	84	93	103	115	124	134	145	155	165	174	185	194
10"	61	71	83	93	106	118	128	140	152	163	175	186	199	210	221
12"	67	79	91	104	117	130	143	155	168	181	194	207	220	233	245
16"	105	124	145	166	185	207	225	245	265	286	307	326	345	366	386
18"	113	133	155	177	198	220	241	262	284	305	327	348	370	392	414
20"	119	141	163	187	210	233	255	278	302	324	348	370	392	414	440
22"	124	149	172	199	221	247	271	294	318	343	369	392	415	441	467
24"	132	156	181	208	233	259	285	309	337	361	388	413	437	463	490

Note: Individual valances are built on the large 2-1/2" depth headrail unless specified. Returns are standard on outside mounts.

Shades over 96" are available in most styles with a center seam. See size specifications section for details.

PRIVACY LINING PRICING (ALL PRICE GROUPS) SEE PAGE 16.

MOTORIZATION PRICING (ALL PRICE GROUPS) SEE PAGE 17.

TRILIGHT SHADES OPTION (SEE PAGES 35-39)

TANDEM SHADES OPTION (SEE PAGES 40-42)

OPTIONS: NO CHARGE
• Valance Returns for Inside Mounts
• Valance Custom Heights to 12"
• Control Positions (R or L)
• Extension Brackets
• Hold Down Brackets
• Cord Cleats (standard on Top-Down and Top-Down/Bottom-Up shades)
• Cut-outs – maximum size 3" x 8" on bottom of shade (left or right side)

OPTIONS: EXTRA CHARGE
• 2 On 1 Headrail.....Price as 2 separate shades and add \$62
• 3 On 1 Headrail.....Price as 3 separate shades and add \$76
• Top-Down add \$54
• Top-Down/Bottom-Up..... add \$61
• Continuous Cord Loop add \$80
• Cordless Breeze..... add \$95
• Cordless Lift..... add \$110
• Operable Lining – add to grid size liner pricing add \$104
• Faux Silk Binding Option – Default - All add \$156
(Grass Weaves Only) – Custom Placement..... add \$103
– Valance Only..... add \$52
• Twill Edge-Binding Option – Shade & Valance add \$101
– Shade Only add \$64
– Valance Only add \$38

Grass Weave*

- 2304 Caracas Tortoise
- 2305 Coban Parchment
- 2310 Granada Cinnamon
- 2311 Granada Ginger
- 2312 Granada Nutmeg
- 2323 Luzon Whisper
- 2324 Luzon Cornsilk
- 2325 Luzon Greige

Grass Weave*

- 2331 Nassau Pewter
- 2340 St. Lucia Sand
- 2343 St. Lucia Storm
- 2345 Zaire Camel
- 9410 Coban Gray
- 9420 Granada Bark
- 9440 Nassau Cocoa

GROUP 7

* Most Grass Weave shades are available up to 72" widths without a seam.

WIDTH TO:	24"	30"	36"	42"	48"	54"	60"	66"	72"	78"	84"	90"	96"	108"	120"
HEIGHT TO:															
36"	\$276	309	357	400	432	475	520	574	640	714	793	872	919	975	1030
42"	296	335	371	423	458	510	551	612	683	793	844	935	983	1043	1101
48"	312	350	383	440	460	533	582	652	726	844	895	1000	1052	1116	1180
54"	324	371	383	455	477	567	616	699	773	903	959	1061	1106	1172	1238
61"	337	386	408	489	521	597	650	732	821	952	1016	1132	1189	1262	1333
66"	348	406	461	523	576	631	692	771	863	991	1070	1198	1249	1322	1400
72"	362	422	475	542	599	663	722	814	903	1053	1128	1251	1322	1404	1482
78"	394	453	516	595	654	717	787	888	988	1158	1236	1313	1385	1468	1553
84"	426	495	564	638	716	786	862	969	1082	1272	1300	1387	1467	1556	1643
90"	455	532	607	688	767	845	930	1049	1188	1326	1364	1448	1528	1619	1711
96"	491	575	658	753	840	928	1009	1154	1246	1379	1417	1498	1599	1696	1793
108"	550	650	736	849	942	1043	1136	1251	1350	1496	1545	1637	1744	1850	1955
120"	582	688	781	900	999	1106	1203	1326	1431	1586	1638	1735	1850	1960	2072

RemoteLift Shades: Single battery wand size recommendation limit is 65 sq.ft., dual battery wand or transformer is RECOMMENDED for shade greater than 65 sq.ft.

Shades over 96" are available in most styles with a center seam. See size specifications section for details.

INDIVIDUAL VALANCE PRICING (AND OVER 12" HEIGHT SHADE VALANCE PRICING)

- 1 Use this grid to price your INDIVIDUAL valance.
- 2 Use this grid to price your extra high (above 12") SHADE valance as follows: For SHADE valance heights over 12", ADD extra height from this grid to your SHADE price from grid above. Example: For a 16" high SHADE valance, ADD the 4" price below to your SHADE price above.

WIDTH TO:	24"	30"	36"	42"	48"	54"	60"	66"	72"	78"	84"	90"	96"	108"	120"
HEIGHT TO:															
4"	\$51	55	58	67	74	84	90	99	106	115	122	132	139	148	155
6"	58	62	71	81	90	100	111	119	131	140	150	159	170	179	188
8"	61	71	84	93	106	118	130	141	152	163	176	186	199	210	222
10"	69	83	95	110	121	135	150	162	175	188	203	215	228	243	257
12"	75	90	106	120	136	152	166	181	196	211	226	242	257	273	288
16"	119	141	163	186	209	235	257	278	303	326	349	371	395	419	443
18"	128	152	176	202	225	251	275	299	326	350	375	399	425	450	476
20"	136	162	187	215	242	269	295	322	348	374	401	428	455	482	510
22"	143	173	201	229	257	287	313	341	371	399	428	455	485	515	543
24"	152	181	210	242	271	303	331	361	392	423	453	483	514	545	576

Note: Individual valances are built on the large 2-1/2" depth headrail unless specified. Returns are standard on outside mounts.

Shades over 96" are available in most styles with a center seam. See size specifications section for details.

PRIVACY LINING PRICING (ALL PRICE GROUPS) SEE PAGE 16.

MOTORIZATION PRICING (ALL PRICE GROUPS) SEE PAGE 17.

TRILIGHT SHADES OPTION (SEE PAGES 35-39)

TANDEM SHADES OPTION (SEE PAGES 40-42)

OPTIONS: NO CHARGE
• Valance Returns for Inside Mounts
• Valance Custom Heights to 12"
• Control Positions (R or L)
• Extension Brackets
• Hold Down Brackets
• Cord Cleats (standard on Top-Down and Top-Down/Bottom-Up shades)
• Cut-outs – maximum size 3" x 8" on bottom of shade (left or right side)

OPTIONS: EXTRA CHARGE
• 2 On 1 Headrail.....Price as 2 separate shades and add \$62
• 3 On 1 Headrail.....Price as 3 separate shades and add \$76
• Top-Down add \$54
• Top-Down/Bottom-Up..... add \$61
• Continuous Cord Loop add \$80
• Cordless Breeze..... add \$95
• Cordless Lift..... add \$110
• Operable Lining – add to grid size liner pricing add \$104
• Faux Silk Binding Option – Default - All add \$156
(Grass Weaves Only) – Custom Placement..... add \$103
– Valance Only add \$52
• Twill Edge-Binding Option – Shade & Valance add \$101
– Shade Only add \$64
– Valance Only add \$38

Grass Weave*	Grass Weave*	Select Weave	Select Weave
9400 St. Kitts Dune	9464 Aruba Café	2420 Macau	2527 Cancun Light Gray
9401 St. Kitts Greywood	9470 Martinique White Wash	2423 Mali Tan	2528 Cancun Off White
9460 Aruba Summer	9471 Martinique Sea Grass	2438 Suva	2529 Cano Cream
9461 Aruba Straw	9472 Martinique Surf	2526 Salvador Driftwood	2530 Madeira Green
9462 Aruba Sand Dune	9473 Martinique Coral		2531 Rio Gray
9463 Aruba Driftwood			

GROUP 8

* Most Grass Weave shades are available up to 72" widths without a seam.

WIDTH TO:	24"	30"	36"	42"	48"	54"	60"	66"	72"	78"	84"	90"	96"	108"	120"
HEIGHT TO:															
36"	\$310	357	399	445	465	537	592	654	731	824	908	1000	1055	1118	1185
42"	328	378	425	486	518	577	631	709	792	910	976	1081	1141	1211	1283
48"	346	400	451	515	527	622	664	763	852	976	1049	1160	1226	1300	1379
54"	362	424	458	542	538	665	677	819	908	1049	1125	1252	1318	1398	1481
61"	384	443	507	576	637	701	763	863	961	1123	1203	1329	1418	1502	1593
66"	400	469	533	606	677	741	817	910	1019	1173	1273	1402	1493	1581	1677
72"	417	490	560	640	706	786	851	969	1091	1260	1345	1497	1584	1678	1779
78"	454	528	608	692	773	850	938	1064	1185	1370	1486	1575	1677	1778	1885
84"	489	576	655	753	833	930	1027	1150	1303	1528	1565	1647	1756	1862	1973
90"	529	622	717	819	910	1015	1119	1264	1425	1599	1640	1753	1860	1970	2088
96"	576	678	784	886	996	1092	1211	1383	1489	1674	1721	1828	1952	2069	2193
108"	648	755	875	1012	1132	1255	1394	1489	1620	1801	1883	1982	2105	2231	2365
120"	685	800	927	1073	1199	1330	1476	1577	1717	1909	1997	2100	2230	2364	2506

RemoteLift Shades: Single battery wand size recommendation limit is 65 sq.ft (Grass Weaves) or 28 sq.ft. (Select Weaves); dual battery wand or transformer is RECOMMENDED for shade exceed the limit.

Shades over 96" are available in most styles with a center seam. See size specifications section for details.

INDIVIDUAL VALANCE PRICING (AND OVER 12" HEIGHT SHADE VALANCE PRICING)

- 1 Use this grid to price your INDIVIDUAL valance.
- 2 Use this grid to price your extra high (above 12") SHADE valance as follows: For SHADE valance heights over 12", ADD extra height from this grid to your SHADE price from grid above. Example: For a 16" high SHADE valance, ADD the 4" price below to your SHADE price above.

WIDTH TO:	24"	30"	36"	42"	48"	54"	60"	66"	72"	78"	84"	90"	96"	108"	120"
HEIGHT TO:															
4"	\$61	62	67	73	85	97	104	117	124	133	141	153	165	175	185
6"	58	69	81	90	102	114	124	136	151	157	164	172	178	189	201
8"	69	83	85	108	115	131	140	156	163	172	179	186	194	207	219
10"	74	87	89	112	119	140	148	161	173	182	190	202	211	224	238
12"	84	90	93	115	121	147	152	171	176	188	196	208	220	233	246
16"	135	162	187	215	242	269	295	322	348	375	401	428	454	482	511
18"	146	175	204	233	261	290	319	348	375	405	433	463	492	520	552
20"	156	187	218	250	280	311	342	374	404	436	466	498	529	560	594
22"	167	202	235	268	300	335	366	400	432	466	498	533	566	600	636
24"	176	212	246	283	318	355	389	425	460	496	530	567	602	638	675

Note: Individual valances are built on the large 2-1/2" depth headrail unless specified. Returns are standard on outside mounts.

Shades over 96" are available in most styles with a center seam. See size specifications section for details.

PRIVACY LINING PRICING (ALL PRICE GROUPS) SEE PAGE 16.

MOTORIZATION PRICING (ALL PRICE GROUPS) SEE PAGE 17.

TRILIGHT SHADES OPTION (SEE PAGES 35-39)

TANDEM SHADES OPTION (SEE PAGES 40-42)

OPTIONS: NO CHARGE
• Valance Returns for Inside Mounts
• Valance Custom Heights to 12"
• Control Positions (R or L)
• Extension Brackets
• Hold Down Brackets
• Cord Cleats (standard on Top-Down and Top-Down/Bottom-Up shades)
• Cut-outs – maximum size 3" x 8" on bottom of shade (left or right side)

OPTIONS: EXTRA CHARGE
• 2 On 1 Headrail.....Price as 2 separate shades and add \$62
• 3 On 1 Headrail.....Price as 3 separate shades and add \$76
• Top-Down add \$54
• Top-Down/Bottom-Up..... add \$61
• Continuous Cord Loop add \$80
• Cordless Breeze..... add \$95
• Cordless Lift..... add \$110
• Operable Lining – add to grid size liner pricing add \$104
• Faux Silk Binding Option – Default - All add \$156
(Grass Weaves Only) – Custom Placement..... add \$103
– Valance Only add \$52
• Twill Edge-Binding Option – Shade & Valance add \$101
– Shade Only add \$64
– Valance Only add \$38

Select Weave
2411 Jaipur Natural
2417 Lagos
2419 Lomaloma
2431 Santos Natural
2433 Sintra Dust
2441 Tunisia

GROUP 9

WIDTH TO:	24"	30"	36"	42"	48"	54"	60"	66"	72"	78"	84"	90"	96"
HEIGHT TO:													
36"	\$380	436	497	566	639	704	772	859	934	1004	1105	1183	1273
42"	407	469	542	618	692	766	854	939	1033	1149	1209	1313	1411
48"	437	512	593	673	700	842	930	1031	1130	1251	1320	1432	1542
54"	466	551	656	726	880	918	1010	1122	1223	1368	1465	1586	1715
61"	498	591	682	784	888	995	1097	1225	1339	1489	1594	1727	1841
66"	530	637	729	840	953	1058	1182	1318	1454	1621	1743	1885	2005
72"	563	679	784	908	1031	1150	1279	1413	1564	1765	1871	2044	2200
78"	605	721	842	966	1110	1239	1388	1526	1697	1888	2009	2205	2383
84"	641	764	894	1031	1181	1316	1471	1648	1807	2050	2174	2344	2538
90"	682	806	952	1113	1265	1409	1578	1755	1941	2183	2311	2554	2705
96"	720	863	1012	1171	1339	1514	1682	1885	2061	2361	2508	2658	2839
108"	787	943	1107	1300	1490	1698	1882	2094	2315	2621	2736	2924	3103
120"	834	998	1175	1379	1580	1799	1995	2221	2453	2779	2900	3098	3290

RemoteLift Shades: Single battery wand size recommendation limit is 28 sq.ft., dual battery wand or transformer RECOMMENDED for shade greater than 28 sq.ft.

INDIVIDUAL VALANCE PRICING (AND OVER 12" HEIGHT SHADE VALANCE PRICING)

- ① Use this grid to price your INDIVIDUAL valance.
- ② Use this grid to price your extra high (above 12") SHADE valance as follows: For SHADE valance heights over 12", ADD extra height from this grid to your SHADE price from grid above. Example: For a 16" high SHADE valance, ADD the 4" price below to your SHADE price above.

WIDTH TO:	24"	30"	36"	42"	48"	54"	60"	66"	72"	78"	84"	90"	96"
HEIGHT TO:													
4"	\$82	88	97	109	118	129	139	155	161	177	188	196	209
6"	87	97	108	118	132	140	149	171	177	190	206	220	236
8"	95	106	118	132	146	160	176	192	207	222	238	253	269
10"	106	129	132	152	170	186	205	223	241	259	276	295	312
12"	126	131	150	170	189	210	230	251	272	292	312	333	354
16"	207	212	233	269	307	342	379	416	454	490	528	566	602
18"	225	232	255	295	335	375	416	456	494	534	577	619	660
20"	245	249	274	319	362	406	450	493	536	582	624	671	714
22"	265	268	298	344	392	439	486	532	580	626	674	724	771
24"	279	281	315	366	419	468	519	569	620	671	722	775	824

Note: Individual valances are built on the large 2-1/2" depth headrail unless specified. Returns are standard on outside mounts.

PRIVACY LINING PRICING (ALL PRICE GROUPS) SEE PAGE 16.

MOTORIZATION PRICING (ALL PRICE GROUPS) SEE PAGE 17.

TRILIGHT SHADES OPTION (SEE PAGES 35-39)

TANDEM SHADES OPTION (SEE PAGES 40-42)

OPTIONS: NO CHARGE
<ul style="list-style-type: none"> • Valance Returns for Inside Mounts • Valance Custom Heights to 12" • Control Positions (R or L) • Extension Brackets • Hold Down Brackets • Cord Cleats (standard on Top-Down and Top-Down/Bottom-Up shades) • Cut-outs – maximum size 3" x 8" on bottom of shade (left or right side)

OPTIONS: EXTRA CHARGE
<ul style="list-style-type: none"> • 2 On 1 Headrail.....Price as 2 separate shades and add \$62 • 3 On 1 Headrail.....Price as 3 separate shades and add \$76 • Top-Down add \$54 • Top-Down/Bottom-Up add \$61 • Continuous Cord Loop add \$80 • Cordless Breeze add \$95 • Cordless Lift..... add \$110 • Operable Lining – add to grid size liner pricing add \$104 • Faux Silk Binding Option – Default - All add \$156 (Grass Weaves Only) – Custom Placement..... add \$103 – Valance Only add \$52 • Twill Edge-Binding Option – Shade & Valance add \$101 – Shade Only add \$64 – Valance Only add \$38

GROUPS 1-9 (PRIVACY LINING PRICING IS THE SAME FOR ALL PRICE GROUPS)

Fixed Privacy Lining – Translucent (LF-# White, Ivory and Khaki)

Operable Privacy Lining – Light Filtering (OLF-# White, Cream, Café and Mink)

Add the price below to your shade price. For operable liners, also add the operable surcharge.

Lining is applied so the white side faces out and the colored side faces inside the room.

WIDTH TO:	24"	30"	36"	42"	48"	54"	60"	66"	72"	78"	84"	90"	96"	108"	120"
HEIGHT TO:															
36"	\$40	48	55	62	65	71	75	88	97	105	108	112	116	126	137
42"	44	53	62	65	71	76	83	97	108	115	118	124	128	139	153
48"	47	55	65	72	80	88	92	106	116	122	128	136	141	155	169
54"	51	62	71	80	88	93	103	115	126	135	141	150	156	169	185
61"	53	64	75	85	92	103	109	124	137	147	153	159	169	185	201
66"	55	71	81	89	97	108	116	133	149	156	163	173	181	198	216
72"	59	72	88	97	106	115	124	141	156	165	176	184	196	215	233
78"	63	76	91	103	110	122	133	150	165	177	185	199	208	227	249
84"	65	81	97	108	118	130	141	159	176	185	199	210	221	240	261
90"	65	85	103	112	124	137	150	167	184	199	210	221	235	256	279
96"	71	89	106	118	133	147	157	177	196	208	221	235	247	269	292
108"	83	105	122	138	155	169	183	207	229	243	260	274	287	313	341

Note: Khaki Fixed Privacy Lining over 54" wide AND 54" high will be spliced together vertically, the maximum height is limited to 106", creating a seam. This applies to the lining ONLY and not the actual woven shade. Privacy Lining is attached to the back of the shade. Small slits are made in the lining at the ring cord-guide attachment locations. When Faux Silk or Twill Edge-Bindings are also ordered, the privacy lining will be sewn under the binding.

GROUPS 1-9 (PRIVACY LINING PRICING IS THE SAME FOR ALL PRICE GROUPS)

Fixed Privacy Lining – Room Darkening (RD-# White, Ivory, Khaki, Brown, Black, Beige-Deluxe, and Taupe-Deluxe)

Operable Privacy Lining – Room Darkening (OBO-# White, Cream, Café and Black)

Add the price below to your shade price. For operable liners, also add the operable surcharge.

Lining is applied so the white side faces out and the colored side faces inside the room.

WIDTH TO:	24"	30"	36"	42"	48"	54"	60"	66"	72"	78"	84"	90"	96"	108"	120"
HEIGHT TO:															
36"	\$50	62	72	80	88	92	100	115	127	135	141	149	155	168	184
42"	55	69	80	89	93	105	110	126	141	150	156	163	172	186	203
48"	62	74	88	97	106	115	122	138	155	161	172	181	187	203	222
54"	65	80	92	105	112	122	133	152	167	177	185	198	207	226	247
61"	71	88	100	110	122	135	142	161	181	190	203	215	224	245	267
66"	72	89	106	117	128	141	155	173	193	207	218	229	242	264	287
72"	76	97	112	126	138	153	165	185	207	219	234	246	259	283	308
78"	81	103	118	135	149	161	176	199	219	235	247	264	275	299	327
84"	88	106	126	141	156	172	185	210	234	247	264	278	293	320	348
90"	89	110	133	150	165	181	198	221	243	264	278	295	311	340	370
96"	93	117	138	157	176	190	208	234	259	275	293	313	329	359	391
108"	109	136	161	183	204	221	243	272	299	321	343	363	382	417	453

Note: Khaki, Brown and Black Fixed Privacy Lining over 54" wide AND 54" high will be spliced together and the maximum height will be reduced to 106", creating a seam. Beige-Deluxe and Taupe-Deluxe Privacy Lining over 60" wide AND 60" high will be spliced together and the maximum height will be reduced to 118" creating a seam. This applies to the lining ONLY and not the actual woven shade. Privacy Lining is attached to the back of the shade. Small slits are made in the lining at the ring cord-guide attachment locations. When Faux Silk or Twill Edge-Bindings are also ordered, are also ordered, the privacy lining will be sewn under the binding.

Use appropriate grid for shade price, then add extra charge(s) below.

Motorization consists of a **motor, power source, and controller**. Be sure all of these elements are included when determining final price.

SIMPLICITY RECHARGEABLE OPTIONS: EXTRA CHARGE – SPECIFY ON ORDER	
NOTE: CHARGER OR SOLAR PANEL IS REQUIRED TO CHARGE THE SHADES	
• Simplicity Rechargeable Motor	add \$360 per motor
– 5 Channel Remote Control (Black Part #CS5138 or White Part #CS5138W)	add \$55 each
– Plug-in Charger	Part #CS5199..... add \$40 each
– Solar Panel (Part #CS52096 Solar Panel & mounting brackets) (Part #02-70-9021 Mounting bracket screws)	add \$195 each

REMOTELIFT™ OPTIONS: EXTRA CHARGE – SPECIFY ON ORDER (Must select power source when ordering)	
• RF RemoteLift Motorization Upgrade	add \$417 per shade
• RF Remote Control – 1 Channel	Part #RC445069 add \$131 each
• RF Remote Control – 5 Channel	Part #RC445079 add \$168 each
• RF Wireless Wall Switch – 1 Channel	Part #RC445135 add \$333 each
• RF Wireless Wall Switch – 5 Channel	Part #RC445136 add \$333 each
• RF Programmable Timer – 1 Channel	Part #1805237A add \$530 each
• RTS-Smoove 1 RTS	add \$172 each
• RTS-myLink RTS interface	add \$494 each
• RF Reloadable Single Battery Wand	Part #KITRWR..... add \$178 each
• RF Reloadable Dual Battery Wand.....	Part #KITRDWR..... add \$360 each
• RF Transformer	Part #1822192..... add \$179 each
• RF Battery Wand Extension Wire – 10"	Part #9013282..... add \$13 each
• RF Battery Wand Extension Wire – 48"	Part #9013279..... add \$18 each
• RF Battery Wand Extension Wire – 96"	Part #9013277..... add \$24 each
• RF 8 AA Lithium Batteries (Reload-Wand)	Part #9014834..... add \$59 each

RemoteLift Shades: Single battery wand size recommendation limit is 16 sq.ft (Woven Wood), 65 sq.ft (Grass Weaves) or 28 sq.ft. (Select Weaves); dual battery wand or transformer RECOMMENDED for shade exceed the limit.

SHADE CONFIGURATION DIAGRAM

Shades and Individual Valances Are Built on 1 of 3 Headrail Depths:

- 1-1/2" Headrail Depth: Standard Rectangular, Waterfall Style, Top-Down, Top-Down/Bottom-Up & Turned Headrail
- 2-1/2" Headrail Depth: RemoteLift, Continuous Cord Loop, Operable Liner, 2 or 3 on 1 Headrail & Individual Valances
- 3/4" Headrail Depth: For narrow mounts

OUTSIDE MOUNT (& CEILING MOUNT) VALANCE WIDTH ADDITIONS FOR:

Standard, Top-Down, Top-Down/Bottom-Up & RemoteLift Shades (see next pages for Cord Loop and Cordless Lift Shades)
 A small width addition is made to the valance to create a "cornice style" box for approved appearance & shade operation/stacking.
 Valance Width ADDITION = +1/2" "PER SIDE = +1" Total

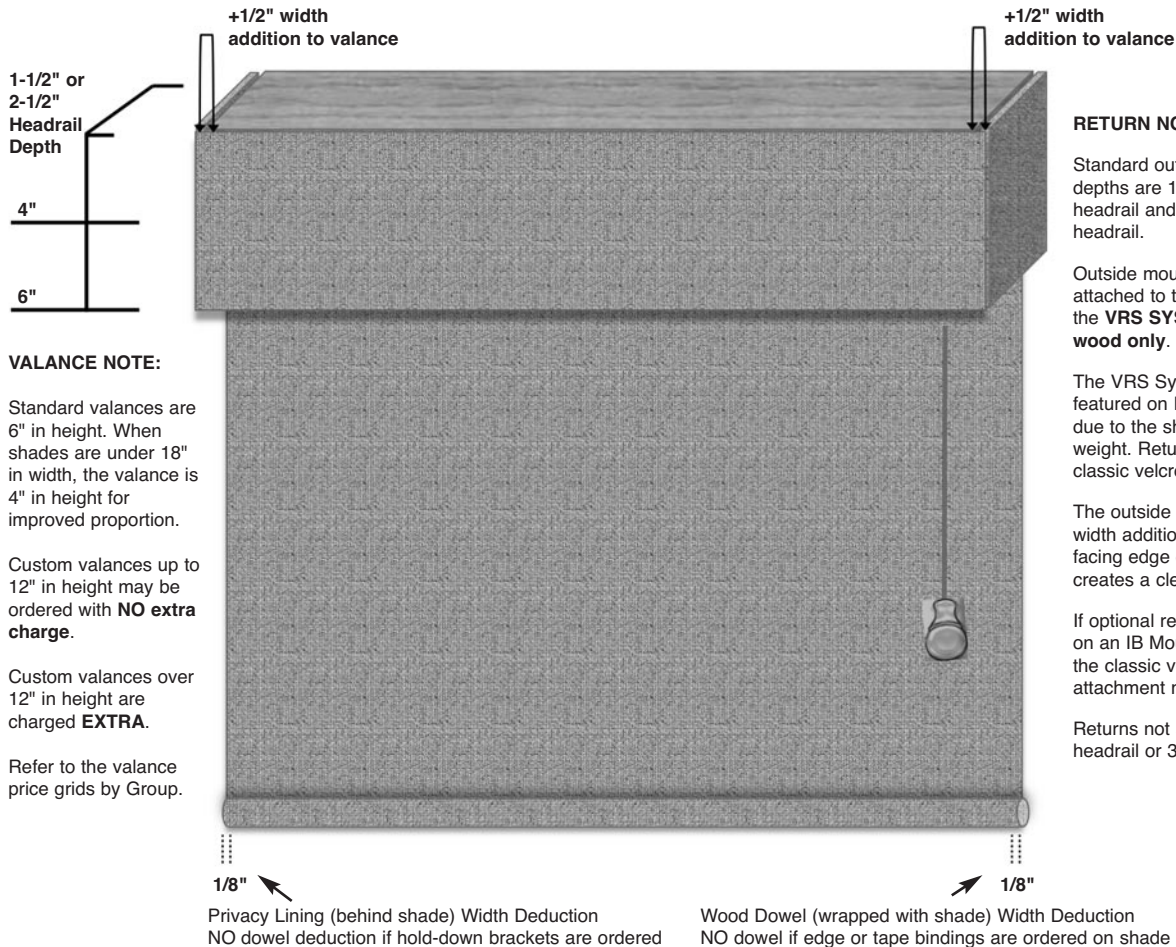

VALANCE NOTE:

Standard valances are 6" in height. When shades are under 18" in width, the valance is 4" in height for improved proportion.

Custom valances up to 12" in height may be ordered with **NO extra charge**.

Custom valances over 12" in height are charged **EXTRA**.

Refer to the valance price grids by Group.

RETURN NOTES:

Standard outside mount return depths are 1-3/4" for the small headrail and 2-3/4" for the large headrail.

Outside mount returns are attached to the valance using the **VRS SYSTEM on woven wood only**.

The VRS System is **NOT** featured on Decorative Wovens due to the sheerness and fabric weight. Returns will use the classic velcro for attachment.

The outside mount valance width addition covers the front facing edge of the return and creates a clean corner.

If optional returns are ordered on an IB Mount, they will use the classic velcro "dog ear" attachment method (not VRS).

Returns not available on turned headrail or 3/4" headrail shades.

VALANCE RETURN STABILIZER (VRS) SYSTEM



Outside mount shade valances come with the innovative Valance Return Stabilizers (VRS) System. The VRS System includes clear corner pieces and are attached to the valance and returns, keeping them stable and in perfect alignment. The valance also covers the front edge of the returns. A tiny spring mechanism in each VRS keeps the valance hanging straight down off the headrail, while also allowing you to raise the valance for installing the shade and for periodic dusting/cleaning underneath.

Not Available on Decorative Wovens. Returns with velcro are available under Decorative Wovens.

LIMITED LENGTH ADJUSTER



Woven Wood shade configurations that have a bottom dowel will include a Limited Length Adjuster. Shades that have an edge-binding or tape-binding on the bottom will **NOT** include the adjuster. The Limited Length Adjuster allows up to a 1" shade height reduction (depending upon the dowel size and woven material). It works by simply **SLIDING UP** the Adjuster on each side of the shade which in turn rolls the dowel up. This is an innovative solution to adjust for some woven shade stretching, which may occur to some extent over time with all woven wood materials.

Not Available on Decorative Wovens

CORD LOOP SHADE DIAGRAM

INSIDE MOUNT WIDTH DEDUCTIONS FOR: Cord Loop Shades

Minor adjustments are made to the standard IB width deductions for cord loop shades to improve the cord loop operation. These adjustments allow the loop control, cord loop and safety tensioner to be shifted toward the outside edge of the shade.

Headrail & Valance Width DEDUCTION = $-1/4"$ (STANDARD) IB WIDTH DEDUCTION ON BOTH SIDES = $-1/2"$ Total

Shade Panel Width DEDUCTION = $-1/4"$ (ADJUSTED) IB WIDTH DEDUCTION ON BOTH SIDES = $-1/2"$ Total

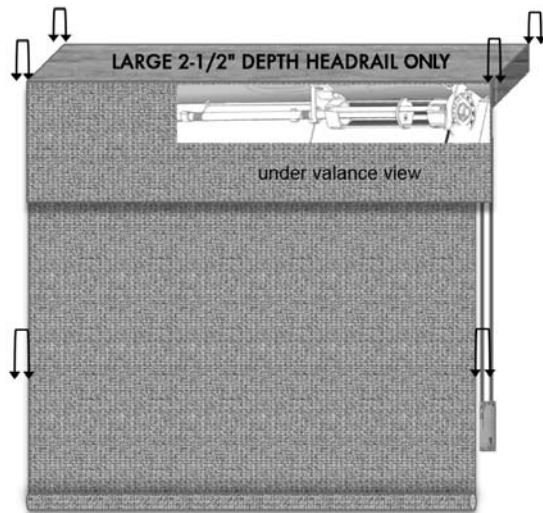

standard $-1/4"$ IB width deduction to headrail, fabric and valance ON BOTH SIDES

OUTSIDE MOUNT (& CEILING MOUNT) WIDTH ADDITIONS FOR: Cord Loop Shades

Minor adjustments are made to the standard OB width additions for cord loop shades to improve the cord loop operation. These adjustments allow the loop control, cord loop and safety tensioner to be shifted toward the outside edge of the shade.

Headrail Width ADDITION = $+1/4"$ ON BOTH SIDES = $+1/2"$ Total

Valance Width ADDITION = $+3/4"$ ON BOTH SIDES = $+1-1/2"$ Total

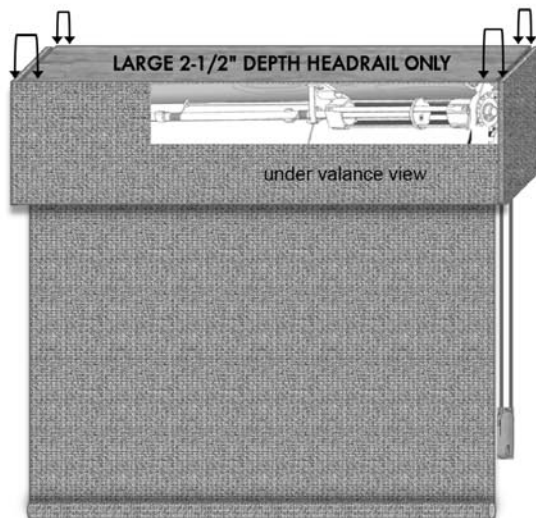

adjusted $+1/4"$ OB width addition to headrail ON BOTH SIDES

adjusted $+3/4"$ OB width addition to valance ON BOTH SIDES

NOTE: The adjusted OB width additions to the headrail ($+1/4"$ on each side) allow clearance for the cord loop and safety tensioner.

Valance and returns attach with the VRS system (Woven Woods only) which then adds the (standard) $+1/2"$ beyond the headrail width on each side.

CONTINUOUS CORD LOOP SYSTEM - MOUNTING AND WIDTH ADJUSTMENTS NOTES

Continuous Cord Loop Systems offer manually operated clutch mechanisms for raising and lowering shades. By simply putting on one side of the cord loop, shades can be quickly and precisely positioned. Left or Right side control positions may be specified.

Cord Loop shades are installed with special L-shaped (small roller shade cassette headrail style) mounting brackets, which snap into a flat, custom fit connector pre-attached to the headrail. This cord loop bracket system allows the cord loop mechanism to be shifted to the very edge of the headrail so that the cord loop is shifted toward the edge of the shade, rather than hanging in front of the shade. The width adjustments made on the cord loop control side allow the cord loop to hang straight down to the required, mounted safety tensioner and clear the edge of the woven material.

NOTE: There is a likelihood where cord will rub against the edge of the shade. Hence, edge binding is highly recommended.

CORDLESS BREEZE SHADE DIAGRAM

Cordless Breeze shades can be built on small 1-1/2" and/or large 2-1/2" depth headrail depending on shade material and size.

INSIDE MOUNT WIDTH DEDUCTIONS FOR: CORDLESS BREEZE

Headrail & Valance Width DEDUCTION = -1/4" (STANDARD) IB WIDTH DEDUCTION ON BOTH SIDES = -1/2" Total

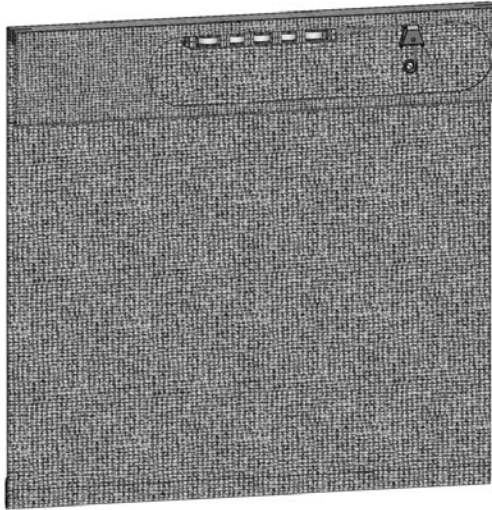

standard -1/4" IB width deduction to headrail, fabric and valance ON BOTH SIDES

OUTSIDE MOUNT AND CEILING MOUNT WIDTH ADDITIONS FOR: CORDLESS BREEZE

Headrail Width ADDITION = +1/4" ON BOTH SIDES = +1/2" Total
Valance Width ADDITION = +3/4" ON BOTH SIDES = +1-1/2" Total

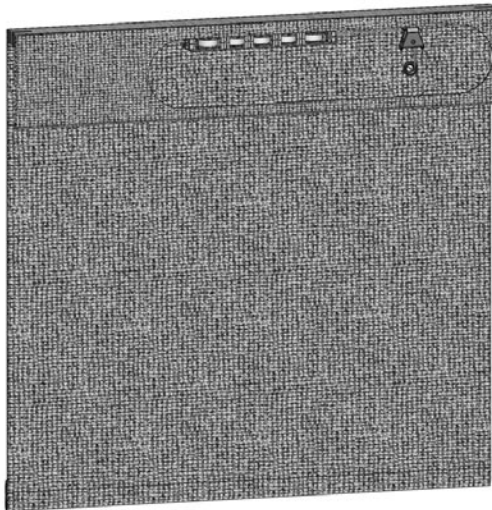

adjusted +1/4" OB width addition to headrail ON BOTH SIDES

adjusted +3/4" OB width addition to valance ON BOTH SIDES

NOTE: The adjusted OB width additions to the headrail (+1/4" on each side).

Valance and returns attach with the VRS system (Woven Woods only) which then adds the (standard) +1/2" beyond the headrail width on each side.

LIMITED LENGTH ADJUSTER

Woven Wood cordless lift shade without edge-binding will have a limited length adjuster. Insert a phillips screwdriver into the adjuster. Turn left to shorten and right to lengthen.

This is a solution to allow limited adjustment for some woven shade stretching, which may occur to some extent over time with all woven wood materials.



CORDLESS LIFT SHADE DIAGRAM

INSIDE MOUNT WIDTH DEDUCTIONS FOR: CORDLESS LIFT

Headrail & Valance Width DEDUCTION = $-1/4"$ (STANDARD) IB WIDTH DEDUCTION ON BOTH SIDES = $-1/2"$ Total
Shade Panel Width DEDUCTION = $-1/4"$ (ADJUSTED) IB WIDTH DEDUCTION ON BOTH SIDES = $-1/2"$ Total

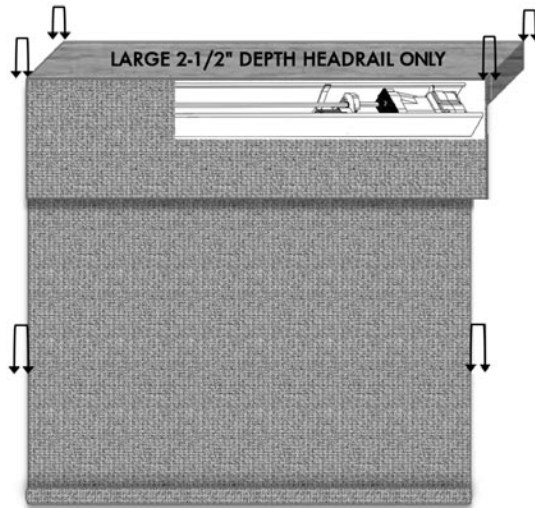

standard $-1/4"$ IB width deduction to headrail, fabric and valance ON BOTH SIDES

OUTSIDE MOUNT AND CEILING MOUNT WIDTH ADDITIONS FOR: CORDLESS LIFT

Headrail Width ADDITION = $+1/4"$ ON BOTH SIDES = $+1/2"$ Total
Valance Width ADDITION = $+3/4"$ ON BOTH SIDES = $+1-1/2"$ Total

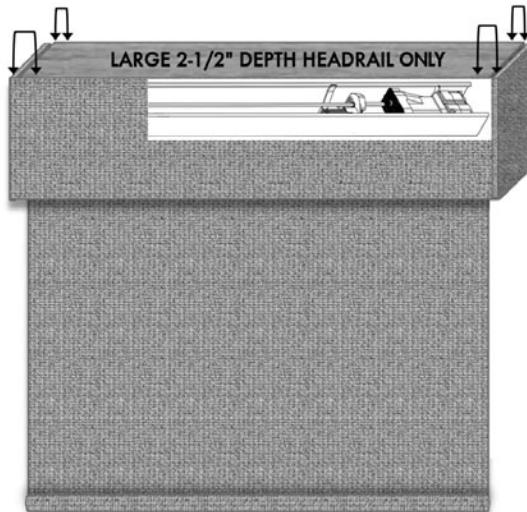

adjusted $+1/4"$ OB width addition to headrail ON BOTH SIDES

adjusted $+3/4"$ OB width addition to valance ON BOTH SIDES

NOTE: The adjusted OB width additions to the headrail ($+1/4"$ on each side).

Valance and returns attach with the VRS system (Woven Woods only) which then adds the (standard) $+1/2"$ beyond the headrail width on each side.

CORDLESS LIFT SYSTEM – MOUNTING AND WIDTH ADJUSTMENT NOTES

Cordless Lift shades are installed with special L-shaped (small roller shade cassette headrail style) mounting brackets, which snap into a flat, custom fit connector pre-attached to the headrail. Cordless Lift shades do not install with the standard woven wood screw-post brackets through routes in the headrail.

LIMITED LENGTH ADJUSTER

Woven Wood cordless lift shade without edge-binding will have a limited length adjuster. Insert a phillips screwdriver into the adjuster. Turn left to shorten and right to lengthen.

This is a solution to allow limited adjustment for some woven shade stretching, which may occur to some extent over time with all woven wood materials.



SHADE CONFIGURATION OPTIONS

STANDARD RECTANGULAR

- Returns standard on outside mount
- Returns for inside mount available upon request
- Valance is 6" long (4" for shades under 18" wide)
- Built on 1-1/2" depth headrail (unless specified)
- Available with Simplicity and RemoteLift Motorization (on 2-1/2" headrails)
- Shade Size over 72 Sq.ft. must be made as 2 or 3 on 1 whether it's bottom up, top down, or top down bottom up.

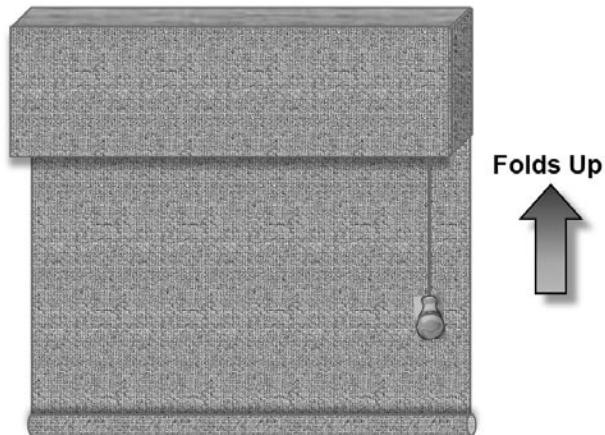

WATERFALL STYLE (FRONT-SIDE SHADE)

- Returns standard on outside mount
- Backside valance includes liner when ordered on shade
- Backside valance included on inside mount
- Front-side cord grommet (unless specified)
- Built on 1-1/2" depth headrail unless specified
- Available with Simplicity and RemoteLift Motorization (on 2-1/2" headrails)

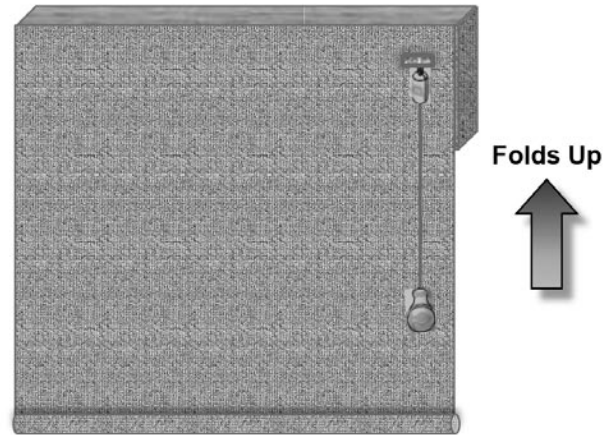

3/4" HEADRAIL (FOR NARROW DEPTH MOUNTS ONLY)

- Available with standard or waterfall style only
- Returns are not available
- No valance width addition for outside mount
- Shade mounts with screws only, not brackets
- Mounting holes pre-drilled in headrail
- Not available as 2 or 3 on 1 headrail

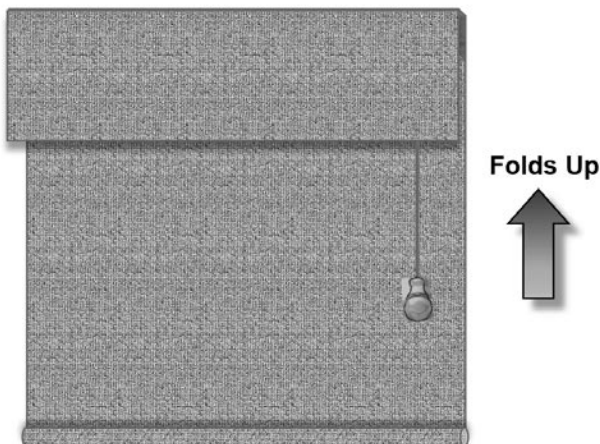

2 OR 3 ON 1 HEADRAIL

- Standard, waterfall & top-down/bottom-up
- Cord loop, cordless, and Simplicity motorization are available under bottom-up in 2 on 1 only.
- Valance split at shade gap if over 96" wide
- Built on 1-1/2" and 2-1/2" depth headrails (see configurations)
- For 2 on 1 or 3 on 1 TDBU shade that is larger than 96" in width are build on 2-1/2" headrail

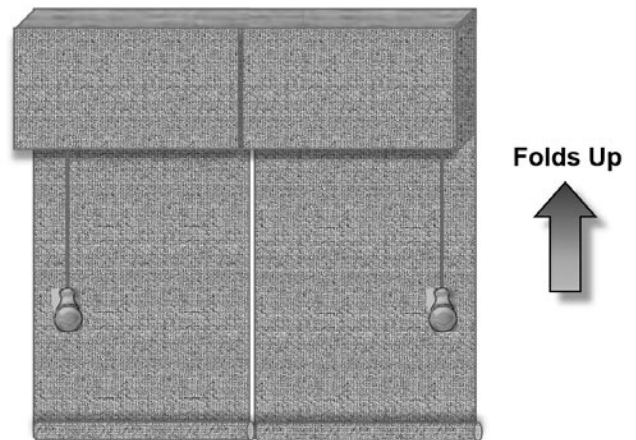

Note: We cannot guarantee fabric alignment on side-by-side shades.

SHADE CONFIGURATION OPTIONS

TOP-DOWN

- Returns standard on outside mount
- Backside valance included on inside mount
- Front & back valances include liner when ordered on shade
- Built on 1-1/2" depth headrail, unless specified
- Not available with motorized or cordless shade
- Not available with waterfall style

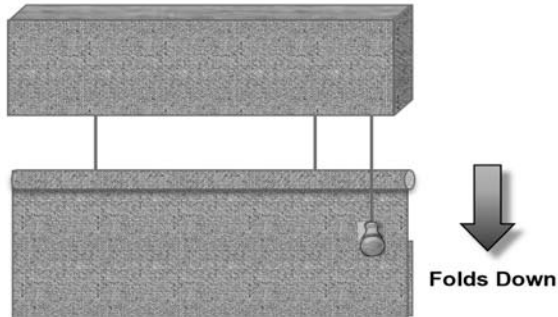

TOP-DOWN/BOTTOM-UP

- Returns standard on outside mount
- Backside valance included on inside mount
- Front & back valances include liner when ordered on shade
- Top-Down/Bottom-Up shades are built on 1-1/2" depth headrail
- For 2 in 1 or 3 in 1 shade that is larger than 96" in width are built on 2-1/2" headrail
- Not available with Waterfall style

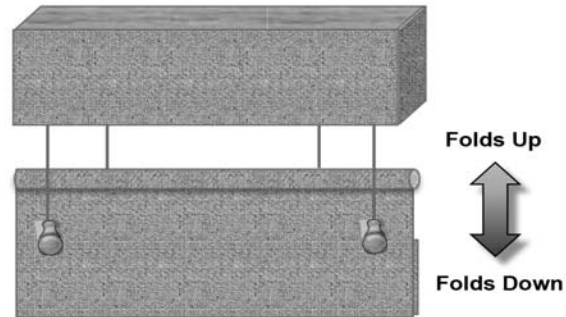

CONTINUOUS CORD LOOP

- Built on 2-1/2" depth headrail only
- Available as 2 on 1 headrail (not 3 on 1 headrail)
- Available with waterfall shades;
- If waterfall, loop cord is behind shade
- Not available with top-down or top-down/bottom-up
- Note: inside and outside mount width adjustments
- Cord may rub against side of the shade during operation. Edge binding is highly recommended.
- Shade Size over 72 Sq.ft. must be made as 2 or 3 on 1.

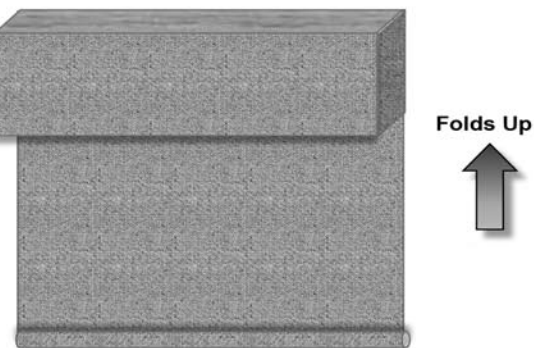
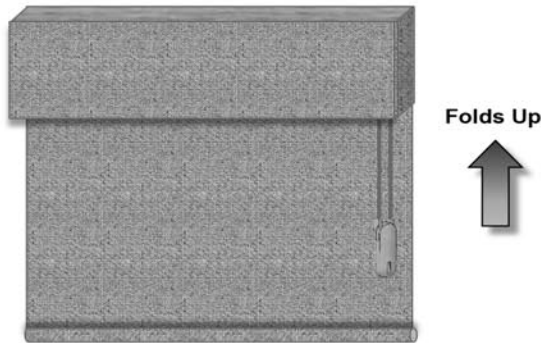

SIMPLICITY RECHARGEABLE & REMOTELIFT MOTORIZATION

- Automated control options available
- Built on 2-1/2" depth headrail only
- Available with waterfall style
- Not available with top-down or top-down/bottom-up or 3 on 1 headrail
- When ordering multiple motorized shades/remotes, please provide programming instructions, otherwise, all shades will be programmed to one remote

CORDLESS BREEZE & CORDLESS LIFT

- Cordless Breeze can be built on 1-1/2" and/or 2-1/2" depth headrail depending on shade material and size.
- Cordless Lift built on 2-1/2" depth headrail only
- Enclosed aluminum hem bar
- Available in standard rectangular style & waterfall
- Available as 2 on 1 headrail (not 3 on 1 headrail)
- Available with fixed liners
- Available with twill edge and faux silk bindings – valance sides & shade sides only

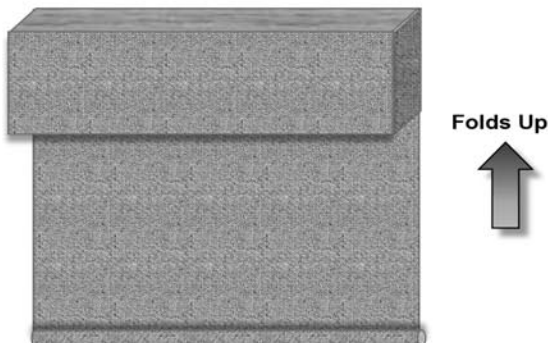

FAUX SILK BINDING SHADE & VALANCE UPGRADES

AVAILABLE ON DECORATIVE WOVEN PATTERNS

FAUX SILK BINDING OPTION (EFO)

Shade and valance sides and bottom available in all configurations

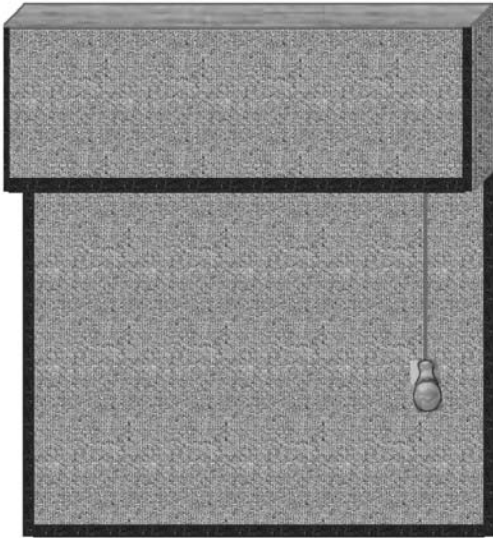

ESVB

Faux silk sides + bottom + valance sides

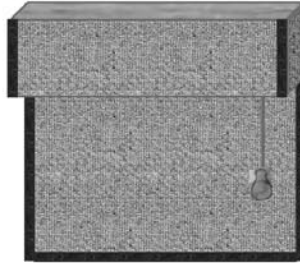

ES

Faux silk sides + valance sides

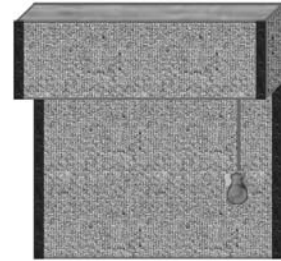

On materials that require binding, only ESVB & ES binding options are available.

ESB

Faux silk sides + bottom

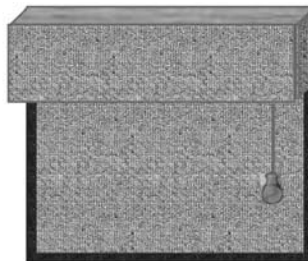

ESO

Faux silk sides only

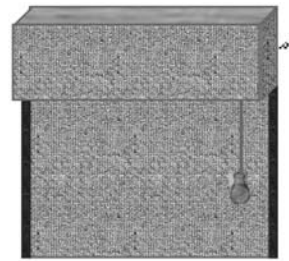

NOTE: Valance returns do not include bindings. They are comprised of Decorative Woven Material only.

NOTE: Corners on shades with faux silk bindings on the side and bottom are mitered, providing a high-end drapery workroom look.

INDIVIDUAL VALANCE

Large 2-1/2" depth headrail

Returns standard on outside mount only

Valance without headrail uses velcro

EVSB

Faux silk VALANCE sides + bottom (binding not on returns)



EVSO

Faux silk valance sides only (binding not on returns)



FAUX SILK ORDER ABBREVIATION TABLE

EFO	- option (default = all sides & bottom)
ESVB	- sides + bottom + valance sides
ES	- sides + valance sides
ESB	- sides + bottom
ESO	- sides only
EVSB	- valance sides + bottom
EVSO	- valance sides only

NOTE:

On outside mounts, the valance widths are adjusted 1/2" wider on each side to create a "Cornice Style" box and to cover the front edge of the returns creating a clean corner.

Due to the valance width addition, trim on the valance sides will also extend out slightly as compared to the trim on the shade sides.

Only EVSB & ES are available for materials that require binding.

NOTE: Some styles require faux silk or twill edge-bindings. See color chart for detail. See "Options: Extra Charge" on each Price Group page for appropriate surcharge.

TWILL EDGE-BINDING SHADE & VALANCE UPGRADES

AVAILABLE ON WOVEN WOOD AND DECORATIVE WOVEN PATTERNS

EDGE-TAPE OPTION (ETO)

Shade and valance sides and bottom available in all configurations

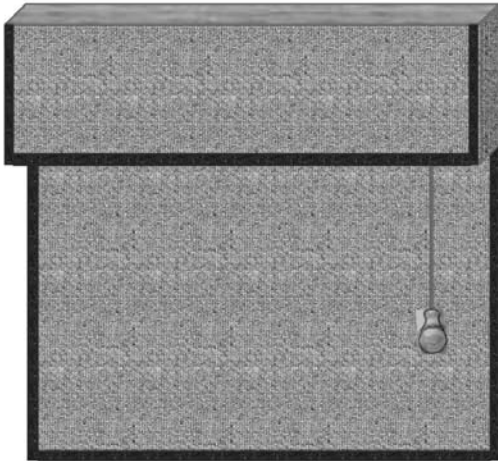

TSVB

Tape sides + bottom + valance sides

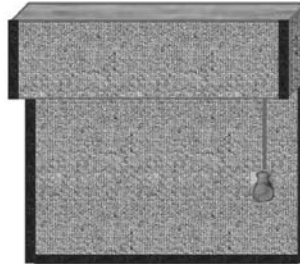

TS

Tape sides + valance sides

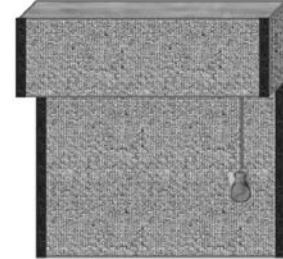

On materials that require binding, only TSVB & TS binding options are available.

TSB

Tape sides + bottom

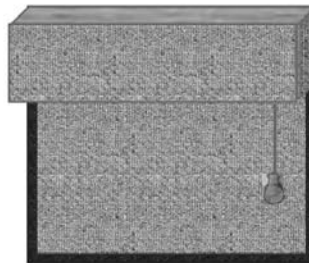

TSO

Tape sides only

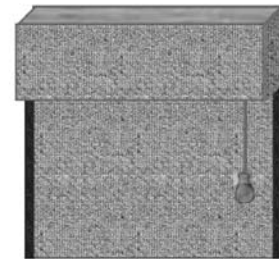

NOTE: Valance returns do not include bindings. They are comprised of woven material only.

NOTE: Corners on shades with twill edge-bindings are NOT mitered.

INDIVIDUAL VALANCE

Large 2 1/2" depth headrail
Returns standard on outside mount only
Valance without headrail uses velcro



TVSB

Tape valance sides + bottom
(binding not on returns)



TVSO

Tape valance sides only
(binding not on returns)



TWILL EDGE-BINDING ORDER ABBREVIATION TABLE

ETO	- edge tape option (default + all sides & bottom)
TSVB	- tape sides + bottom + valance sides
TS	- tape sides + valance sides
TSB	- tape sides + bottom
TSO	- tape sides only

TVSB	- tape valance sides + bottom
TVSO	- tape valance sides only

NOTE:

On outside mounts, the valance widths are adjusted 1/2" wider on each side to create a "Cornice Style" box and to cover the front edge of the returns creating a clean corner. See Shade Configuration Diagram. OB Valances and returns are attached using the "Valance Return Stabilizer" or VRS System. [Woven Wood patterns only].

Due to the valance width addition, edge-tape on the valance sides will also extend out slightly as compared to the edge-tape on the shade sides

Only TSVB & TS are available for materials that require binding.

NOTE: Some styles require faux silk or twill edge-bindings. See color chart for detail. See "Options: Extra Charge" on each Price Group page for appropriate surcharge.

BINDING FEATURES AND FABRIC LISTS

- Bindings come standard on shade and valance sides and bottom, front and back unless one of the custom placement options is specified.
- Bindings are sewn to the woven material for durability, structure, a cleaner appearance, and to protect the shade edges.
- Cordless only available with faux silk binding and twill edge-bindings.
- Not available on all woven materials – see color charts for availability.
- Available on all woven shade configurations.
- On materials require binding, valance will also have binding on the sides.



Faux Silk Bindings



Twill Edge-Bindings

TWILL EDGE-BINDING FABRIC LIST

Available on Woven Woods & Decorative Wovens

Color #	5/8" Folded	1-1/2" Folded
White	CT400	NA
Natural	CT402	CT802
Duck	CT403	NA
Latte	CT404	NA
Dusk	CT405	CT805
Sand	CT406	CT806
Beige	CT408	CT808
Jute	CT409	CT809
Camel	CT410	CT810
Desert	CT412	CT812
Mocha	CT417	CT817
Chocolate	CT418	CT818
Espresso	CT419	CT819
Silver	CT420	NA
Steel	CT421	CT821
Black	CT424	CT824

FAUX SILK BINDING FABRIC LIST (1" WIDTH)

Available on Decorative Wovens ONLY

Color #	Color Name
FT550	Optic
FT551	Cashmere
FT552	Crystal
FT554	Bubbly
FT555	Angora
FT557	Natural
FT562	Sand

Color #	Color Name
FT565	Jute
FT566	Chipmunk
FT568	Tiramisu
FT572	Granite
FT573	Oyster
FT574	Smoke

- Corners are mitered for a custom workroom look

OPERABLE PRIVACY LINING OPTIONS

Features

- Operable privacy liners may be raised and lowered independently of the front woven shade using a separate lift cord & cordlock.
- Operable liners allow for the most versatile woven shade light control.
- Available on all woven materials.
- Available on Standard & Waterfall-Style shade configurations ONLY.
- Operable liners are neutral white to the outside, are NOT reversible, and include spaced horizontal "tabs" on the back-side for the lift cords.
- Operable liner safety cord shrouds are WHITE-ONLY. The lift cords are color-coordinated to the woven material and match the shade lift cords.
- Valances DO NOT include operable liners (or same-color fixed liners).
- Cut-outs not available.

Front View



Back View



FIXED PRIVACY LINING OPTIONS

Features

- Fixed (traditional) privacy liners are physically attached to the back of the woven shade and operate in unison WITH them.
- Available on all woven materials.
- Available on ALL woven shade configurations.
- Fixed liners are neutral to the outside. Reversed liners (i.e. colored to the outside and white to the inside) must be specified when ordering.
- Light filtering liners are similar in color on both sides. Room darkening liners have a neutral back to the street and the color to the shade. Room darkening liners may be requested reversed, with the neutral backing to the shade and the liner color to the street.
- Front & back valances on Top-Down/Bottom-Up shades DO include liners.
- Back valances on Waterfall-Style shades DO include liners.
- Fixed liners are sewn UNDER faux silk, twill edge-binding when those options are ordered.
- Allows for traditional style woven wood shade light control.

Front & Back View



Back View with Binding



OPERABLE PRIVACY LINING

Family	Color #	Color Name
Light Filtering	OLF-4001	White
Light Filtering	OLF-4004	Cream
Light Filtering	OLF-4005	Café
Light Filtering	OLF-4007	Mink
Room Darkening	OBO-5001	White
Room Darkening	OBO-5004	Cream
Room Darkening	OBO-5005	Café
Room Darkening	OBO-5006	Black

Operable privacy liners are made of 100% Polyester.

FIXED PRIVACY LINING

Family	Color #	Color Name
Translucent	LF-1001	White
Translucent	LF-1002	Ivory
Translucent	LF-1003	Khaki
Room Darkening	RD-2001	White
Room Darkening	RD-2002	Ivory
Room Darkening	RD-2003	Khaki
Room Darkening	RD-2004	Brown
Room Darkening	RD-2006	Black
Room Darkening	RD-3008	Beige-Deluxe
Room Darkening	RD-3009	Taupe-Deluxe

Translucent fixed privacy liners are made of 100% Cotton.

Room Darkening fixed privacy liners are made of 30% Cotton and 70% Polyester.

Note: Khaki, Brown and Black Fixed Privacy Lining over 54" wide and 54" high will be spliced together and the maximum height will be reduced to 106", creating a seam. Beige-Deluxe and Taupe-Deluxe Privacy Lining over 60" wide and 60" high will be spliced together and the maximum height will be reduced to 118" creating a seam. This applies to the lining ONLY and not the actual woven shade. Privacy Lining is attached to the back of the shade. Small slits are made in the lining at the ring cord-guide attachment locations. When Faux Silk or Twill Edge-Bindings are also ordered, the privacy lining will be sewn under the binding.

PRODUCT SPECIFICATIONS

WOVEN WOODS, SELECT WEAVES, AND GRASS WEAVES

Shade Features		Footnotes
Number of Styles		92
Headrail Depth	(1)	3/4", 1-1/2" or 2-1/2"
Bracket Style (for each headrail size above)	(2)	L-Shaped
Swivel Multi Cord Lock & Pulley		Yes
Woven Valance	(3)	Yes
Valance Returns (Standard on OB)	(4)	Yes
Color-Coordinated Lift Cords		Yes
Color-Coordinated Decorative Wood Tassel		Yes
Color-Coordinated Cord Connector		Yes
Color-Coordinated Cord Tensioner		Yes
Wood Dowel Bottomrail	(5)	3/4"
Warranty		Lifetime Limited

Continuous Cord Loop Chart	
Shade Height	Cord Loop Length
12" to 18"	12"
18-1/8" to 26"	18"
26-1/8" to 38"	24"
38-1/8" to 50"	36"
50-1/8" to 62"	48"
62-1/8" to 74"	60"
74-1/8" to 86"	72"
86-1/8" to 98"	84"
98-1/8" to 120"	96"
special request, long cord loop	120"
special request, long cord loop	144"

Shade Configuration Options	
Faux Silk Bindings (not available on all patterns)	Yes
Translucent/Light Filtering Privacy Linings (Fixed or Operable)	Yes
Room Darkening Privacy Linings (Fixed or Operable)	Yes
Continuous Cord Loop System	(6) Yes
Cordless Breeze Shade	Yes
Cordless Lift Shades	Yes
Top-Down or Top-Down/Bottom-Up (TDBU)	(7) Yes
Top-Down/Bottom-Up Continuous Cord	No
Waterfall Style	(8) Yes
Simplicity, Automate & RemoteLift Motorization	Yes
2 or 3 On 1 Headrail	(9) Yes
3/4" Headrail (for extra shallow mounts)	Yes
Custom Valance Heights & Return Depths	(10) Yes

Stacking Chart	
Shade Height	Stack Height
24"	6" - 7"
36"	6" - 8"
48"	8" - 9"
60"	8" - 10"
72"	8" - 10"
84"	9" - 12"
96"	9" - 12"
108"	10" - 13"
120"	10" - 13"

NOTE: These are stacking averages for standard shades. Actual heights may vary + or - 1". Stacking heights for continuous cord and bindings add approximately 1" more (each).

Other Options	
Individual Valances	(3) Yes
Cut-Outs (max size 3"x8" on L or R shade bottom)	(10) Yes
Specialty Shapes	No
Control Positions	L or R
Ceiling Mount (Flat) Brackets	(2) Yes
Hold Down Brackets	Yes
Spacer Blocks; 3/4"	Yes
Extension Brackets; 2-1/2" and 4-1/2"	Yes
Cord Cleats (Standard with TD & TDBU)	(8) Yes

Please Note: fabric alignment on side-by-side shades cannot be guaranteed.

FEATURE & OPTION NOTES:
<ol style="list-style-type: none"> Continuous Cord Loop shades, Cordless Lift Shades, RemoteLift shades and Individual Valances are made with the larger 2-1/2" depth headrail. Wider shades may also come with ceiling mount bracket(s) used to support the center headrail area. Flat (T-Style) brackets may also be ordered by request. Custom shade valance heights may be specified to 12" at NO extra charge. Over 12" valance is charged EXTRA. Returns standard on OB shades and valance orders ONLY, unless specified. Return widths are 1-3/4" (for small HR) and 2-3/4" (for large HR). Either of 2 size wood dowel bottomrails are wrapped with the selected woven material. Dowel size used depends on material style - see dowel size detail under color chart. Cord may rub against Continuous Cordloop shade, edge binding is highly recommended. Top-Down and TDBU shades require an EXTRA LONG lift cord and come with a CORD CLEAT to wrap excess cord. These shades are built on 1-1/2" depth headrail. For 2 on 1 and 3 on 1 TDBU shades over 96" are built on a 2-1/2" headrail. Waterfall-Style shades may be motorized. They are not available in Top-Down or Top-Down/Bottom-Up. Widths over 96" will always receive a spliced valance split at the shade gap. There is a 1/2" gap between individual shades. Cord Loop, Cordless Breeze, Cordless Lift, Motorized shades are not available with 3 on 1 headrail. 2 on 1 Cordless Breeze is only available with 2-1/2" depth headrail. Cut-Out maximum size is 3" x 8" and only available on the Left or Right bottom corner of the shade. Cut-Outs are NOT available when Edge-Binding, Twill Edge-Binding or Faux Silk Binding is ordered, or on operable liners or Cordless Breeze shades.

SIZE SPECIFICATIONS: WOVEN WOODS

Standard, Waterfall Style, Top-Down & Top-Down/Bottom-Up Shades	
MINIMUM WIDTH	10" (per panel)
MAXIMUM WIDTH	96"
MINIMUM HEIGHT	12"
MAXIMUM HEIGHT	108"

- All Standard Rectangular, Top-Down and Top-Down/Bottom-Up shades are built on a 1-1/2" depth headrail as standard, unless specified.
- For 2 on 1 or 3 on 1 TDBU shade that is larger than 96" in width are built on a 2-1/2" headrail.
- Waterfall Style shades come with a front-side oval grommet for easy cord access & control. They may also be ordered with "rear cord access", so no grommet, if desired.
- The turned headrail and 3/4" headrail options for narrow depth mounting is only available for Standard and Waterfall shades.

Continuous Cord Loop Shades	LARGE Headrail
MINIMUM WIDTH	22" NET
MAXIMUM WIDTH	96"
MINIMUM HEIGHT	12"
MAXIMUM HEIGHT	96" */108"

- Continuous Cord Loop shades are only built on the large 2-1/2" depth headrail.
- Cord Loop shades may be ordered as Waterfall Style, but only with "rear cord access". The loop control will be BEHIND the shade, not through a front-side grommet.
- * Kota, Kyoto Sunset, Kyoto Ebony, Zee Gray, Zee Tan, and Zee White can only go up to 96" in height.

2 or 3 on 1 Headrail Shades (Standard/Continuous Cord Loop)	2 on 1 Headrail	3 on 1 Headrail
MINIMUM WIDTH	10" / 22" (per panel)	10" (per panel) / NA
MAXIMUM WIDTH	144"	144"
MINIMUM HEIGHT	12"	12"
MAXIMUM HEIGHT	108"	108"

- Continuous Cord Loop shades are NOT available as 3 on 1 headrail.
- The 2 or 3 on 1 valance is continuous up to 96" wide. Over 96" require valance to be spliced at the shade gap between the individual panels.
- Woven vertical "thread patterns" on the valance may not align to thread patterns on multiple shades on 1 headrail.
- Individual shade panel widths are restricted to the standard width maximums.

Cordless Breeze Shades	
MINIMUM WIDTH	20" NET
MAXIMUM WIDTH	72"*/84"
MINIMUM HEIGHT	20"
MAXIMUM HEIGHT	72"*/84"

- Cordless Breeze shades can be built on small 1-1/2" and/or large 2-1/2" depth headrail depending on shade material and size.
- * The width of **Taos** can only go up to 72".
- ** Certain woven woods are limited to max height of 72", refer to "Cordless Specifications: Headrail & Size" section for details

2 on 1 Headrail Shades (Cordless Breeze)	
MINIMUM WIDTH	20" (per panel) / 40-1/2" (overall)
MAXIMUM WIDTH	72"*/84" (per panel) / 120" (overall)
MINIMUM HEIGHT	20"
MAXIMUM HEIGHT	84"

- Cordless Breeze shades are NOT available as 3 on 1 headrail and can only built on 2-1/2" depth headrail with 2 on 1.
- * The width of **Taos** can only go up to 72" per panel.
- Woven vertical "thread patterns" on the valance may not align to thread patterns on multiple shades on 1 headrail.

Cordless Lift Shades	LARGE Headrail
MINIMUM WIDTH	20" NET
MAXIMUM WIDTH	84"
MINIMUM HEIGHT	20"
MAXIMUM HEIGHT	84"

- Cordless Lift shades are only built on the large 2-1/2" depth headrail.

2 on 1 Headrail Shades (Cordless Lift)	
MINIMUM WIDTH	20" (per panel) / 40-1/2" (overall)
MAXIMUM WIDTH	84" (per panel) / 120" (overall)
MINIMUM HEIGHT	20"
MAXIMUM HEIGHT	84"

- Cordless Lift shades are NOT available as 3 on 1 headrail.
- Woven vertical "thread patterns" on the valance may not align to thread patterns on multiple shades on 1 headrail.

SIZE SPECIFICATIONS: WOVEN WOODS

Simplicity Rechargeable Motorization	RF System
MINIMUM WIDTH	24" Net (single shade), 48-1/2" Net (2 on 1 shade**)
MAXIMUM WIDTH - within max area limit	96" (single shade), 120" (2 on 1 shade**)
MINIMUM HEIGHT	12"
MAXIMUM HEIGHT - within max area limit	96"
MAXIMUM AREA (SQUARE FEET)	Varies***

- Simplicity motorized shades are built on 2-1/2" depth headrail ONLY without exception.
- Simplicity motorized shades can be ordered as Waterfall
- ** 2 on 1 shade requires two motors (see "Motorization" section for surcharge information).
- *** Refer to Maximum Motorization Area under Size Specification section for details

RemoteLift Motorization – Radio Frequency (RF)	RF System
MINIMUM WIDTH	19" Net (single shade), 38-1/2" Net (2 on 1 shade**)
MAXIMUM WIDTH - within max area limit	96" (single shade), 120" (2 on 1 shade**)
MINIMUM HEIGHT	12"
MAXIMUM HEIGHT - within max area limit	96"
MAXIMUM AREA (SQUARE FEET)	Varies***

- All RemoteLift motorized shades are built on LARGE 2-1/2" depth headrail ONLY without exception.
- Single battery wand size recommendation limit is 65 sq.ft., dual battery wand or transformer mandatory for shade equal or greater than 65 sq.ft.
- RemoteLift shades may be ordered as Waterfall Style.
- ** 2 on 1 shade requires two motors (see "Motorization" section for surcharge information).
- *** Refer to Maximum Motorization Area under Size Specification section for details

Operable Privacy Lining

- Shades ordered with Operable Lining follow the same size specifications as the **configurations** listed above, for Standard and Waterfall Style shades ONLY.
- Operable liners are available on Standard and Waterfall Style shades ONLY.
- Waterfall Style shades ordered with operable privacy lining DO NOT include lining on the back-side valance.
- Cut-outs are not available on operable liner shades.

Fixed Privacy Lining

- Shades ordered with Privacy Lining follow the same size specifications as the **configurations** listed above.
- Top-Down and TDBU shades ordered with privacy lining DO include lining on the front valance.
- Waterfall Style shades ordered with privacy lining DO include lining on the back-side valance.
- Khaki Translucent Privacy Lining over 54" wide AND 54" high will be spliced together and the maximum height will be reduced to 106".
- Khaki, Brown and Black Room Darkening Privacy Lining over 54" width and 54" height will be SPLICED and the maximum height will be reduced to 106".
- Beige/Deluxe & Taupe/Deluxe Room Darkening Privacy Lining over 60" width and 60" height will be SPLICED and the maximum height will be reduced to 118".

SIZE SPECIFICATIONS: DECORATIVE WOVENS – GRASS WEAVES

	Standard, Waterfall, Operable Liner	Top-Down	Top-Down/Bottom-Up
MINIMUM WIDTH	12" (per panel)	12" (per panel)	12" (per panel)
MAXIMUM WIDTH	72" * / 96"	72" * / 96"	48"
MINIMUM HEIGHT	12"	12"	12"
MAXIMUM HEIGHT	108"	108"	108"

* Most patterns are available up to 96" with a center seam. Shades over 72" wide will come standard at no charge with 1 seam placed in the center of the shade except

Zaire collection can only go up to 72" in width, seam not available

Celebes collection can only go up to 96" in width, seam not available

- Custom seam placement is available on most patterns at a 15% surcharge, see detail under section "Color Chart". Allows up to 2 seams per shade. Minimum seam placement from the side edges of the shade is 5".
- All Standard Rectangular, Top-Down, Top-Down/Bottom-Up shades are built on a 1-1/2" depth headrail as standard. The 2-1/2" headrail must be specified. For 2 on 1 or 3 on 1 Top-Down/Bottom-Up shades that are larger than 96" in width are built on a 2-1/2" headrail.
- Waterfall shades come with a front-side oval grommet for easy cord access & control. They may also be ordered with "rear cord access", so no grommet, if desired.
- The 3/4" Headrail option for narrow depth mounting is only available for Standard and Waterfall shades.

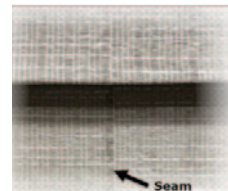

Continuous Cord Loop Shades	2 1/2" Headrail
MINIMUM WIDTH	22" NET
MAXIMUM WIDTH	72" / 96" / 120" *
MINIMUM HEIGHT	12"
MAXIMUM HEIGHT	108"

* Patterns with Continuous Cord Loop control option are available in widths up to 120" with a seam. Shades over 72" wide will come standard at no charge with 1 seam placed in the center of the shade except:

Zaire collection can only go up to 72" in width, seam not available

Celebes collection can only go up to 96" in width, seam not available

- Custom seam placement is available on most patterns at a 15% surcharge, see detail under color chart section. Allows up to 2 seams per shade. Minimum seam placement from the side edges of the shade is 5".
- Shades are only built on the 2-1/2" depth headrail.
- Shades may be ordered as Waterfall, but only with "rear cord access". The loop control will be BEHIND the shade, not through a front-side grommet.

2 or 3 on 1 Headrail Shades (Standard / Continuous Cord)	2 on 1 Headrail	3 on 1 Headrail
MINIMUM WIDTH	12" / 22" (per panel)	12" (per panel) / NA
MAXIMUM WIDTH	144"	144"
MINIMUM HEIGHT	12"	12"
MAXIMUM HEIGHT	108"	108"

- Continuous Cord Loop shades are NOT available as 3 on 1 headrail.
- The 2 or 3 on 1 valance is continuous up to 72" wide and 96" with seam on most patterns. Over 96" require valance to be spliced at the shade gap between the individual panels.
- Woven vertical "thread patterns" on the valance may not align to thread patterns on multiple shades on 1 headrail.
- Individual shade panel widths are restricted to the standard width maximums.

SIZE SPECIFICATIONS: DECORATIVE WOVENS – GRASS WEAVES

Cordless Breeze Shades	
MINIMUM WIDTH	20" (per panel)
MAXIMUM WIDTH	72"
MINIMUM HEIGHT	20"
MAXIMUM HEIGHT	84"

- Cordless Breeze shades can be built on small 1-1/2" and/or large 2-1/2" depth headrail depending on shade material and size.

2 on 1 Headrail Shades (Cordless Breeze)	2 on 1 Headrail
MINIMUM WIDTH	20" (per panel) / 40-1/2" (overall)
MAXIMUM WIDTH	72" (per panel) / 120" (overall)
MINIMUM HEIGHT	20"
MAXIMUM HEIGHT	84"

- Cordless Breeze shades are NOT available as 3 on 1 headrail and can only built on 2-1/2" depth headrail with 2 on 1.
- Woven vertical "thread patterns" on the valance may not align to thread patterns on multiple shades on 1 headrail.

Cordless Lift Shades	2 1/2" Headrail
MINIMUM WIDTH	20" (per panel)
MAXIMUM WIDTH	72" * / 84"
MINIMUM HEIGHT	20"
MAXIMUM HEIGHT	84"

- * The following patterns with Cordless Lift control are only available up to 72" in width: **Zaire Camel**
- Shades are only built on the 2-1/2" depth headrail.

2 on 1 Headrail Shades (Cordless Lift)	2 on 1 Headrail
MINIMUM WIDTH	20" (per panel) / 40-1/2" (overall)
MAXIMUM WIDTH	72" or 84" (per panel) / 120" (overall)
MINIMUM HEIGHT	20"
MAXIMUM HEIGHT	84"

- * The following patterns with Cordless Lift control are only available up to 72" in width: **Zaire Camel**
- Cordless shades are NOT available as 3 on 1 headrail.
- Woven vertical "thread patterns" on the valance may not align to thread patterns on multiple shades on 1 headrail.

Simplicity Rechargeable Motorization	RF System
MINIMUM WIDTH	24" Net (single shade), 48-1/2" Net (2 on 1 shade**)
MAXIMUM WIDTH - within max area limit	72"/96" (single shade), 120" (2 on 1 shade**)
MINIMUM HEIGHT	12"
MAXIMUM HEIGHT - within max area limit	96"
MAXIMUM AREA (SQUARE FEET)	Varies***

- * These patterns are only up to 72" in width: **Zaire Camel**
- ** 2 on 1 shade requires two motors (see "Motorization" section for surcharge information).
- *** Refer to Maximum Motorization Area under Size Specification section for details
- Simplicity motorized shades are built on 2-1/2" depth headrail ONLY without exception.
- Simplicity motorized shades can be ordered as Waterfall
- Due to the material construction, **Celebes** collection can't be motorized.

RemoteLift Motorization – Radio Frequency (RF)	RF System
MINIMUM WIDTH	19" Net (single shade), 38-1/2" Net (2 on 1 shade**)
MAXIMUM WIDTH - within max area limit	72"/96" (single shade), 120" (2 on 1 shade**)
MINIMUM HEIGHT	12"
MAXIMUM HEIGHT - within max area limit	96"
MAXIMUM AREA (SQUARE FEET)	Varies***

- * These patterns are only up to 72" in width: **Zaire Camel**
- ** 2 on 1 shade requires two motors (see "Motorization" section for surcharge information).
- *** Refer to Maximum Motorization Area under Size Specification section for details
- All battery-operated motorized shades are built on 2-1/2" depth headrail ONLY without exception.
- Single battery wand size recommendation limit is 65 sq.ft., dual battery wand or transformer mandatory for shade equal or greater than 65 sq.ft.
- Motorized shades may be ordered as Waterfall.
- Due to the material construction, **Celebes** collection can't be motorized.

SIZE SPECIFICATIONS: SELECT WEAVES

	Standard, Waterfall, Operable Liner	Top-Down	Top-Down/Bottom-Up
MINIMUM WIDTH	12" (per panel)	12" (per panel)	12" (per panel)
MAXIMUM WIDTH	96" / 120" *	96"	72"
MINIMUM HEIGHT	12"	12"	12"
MAXIMUM HEIGHT	120"	72"	72"

- * Salvador Dritwood is available in widths up to 120" with a seam. Shades over 96" will come standard at no charge with 1 seam placed in the center of the shade.
- Custom seam placement is available only on above patterns at a 15% surcharge. Allows up to 2 seams per shade. Minimum seam placement from the side edges of the shade is 5".
- All Standard Rectangular, Top-Down, Top-Down/Bottom-Up shades are built on a 1-1/2" depth headrail as standard. The 2-1/2" headrail must be specified.
For 2 on 1 or 3 on 1 Top-Down/Bottom-Up shades that are larger than 96" in width are built on a 2-1/2" headrail
- Waterfall shades come with a front-side oval grommet for easy cord access & control. They may also be ordered with "rear cord access", so no grommet, if desired.
- The 3/4" Headrail option for narrow depth mounting is only available for Standard and Waterfall shades.

Continuous Cord Loop Shades	2 1/2" Headrail
MINIMUM WIDTH	22" NET
MAXIMUM WIDTH	96" / 120" *
MINIMUM HEIGHT	12"
MAXIMUM HEIGHT	96" * / 120"

- * The following pattern available only up to 96" in height: Macau
- * Salvador Dritwood is available in widths up to 120" with a seam. Shades over 96" will come standard at no charge with 1 seam placed in the center of the shade.
- Custom seam placement is available only on above patterns at a 15% surcharge. Allows up to 2 seams per shade. Minimum seam placement from the side edges of the shade is 5".
- Shades are only built on the 2-1/2" depth headrail.
- Shades may be ordered as Waterfall Style, but only with "rear cord access". The loop control will be BEHIND the shade, not through a front-side grommet.

2 or 3 on 1 Headrail Shades (Standard/Continuous Cord)	2 on 1 Headrail	3 on 1 Headrail
MINIMUM WIDTH	12" / 22" (per panel)	12" (per panel) / NA
MAXIMUM WIDTH	144"	144"
MINIMUM HEIGHT	12"	12"
MAXIMUM HEIGHT	120"	120"

- Continuous Cord Loop shades are NOT available as 3 on 1 headrail.
- The 2 or 3 on 1 valance is continuous up to 96" wide. Over 96" require valance to be spliced at the shade gap between the individual panels.
- Woven vertical "thread patterns" on the valance may not align to thread patterns on multiple shades on 1 headrail.
- Individual shade panel widths are restricted to the standard width maximums.

Cordless Breeze Shades	
MINIMUM WIDTH	20" (per panel)
MAXIMUM WIDTH	72"
MINIMUM HEIGHT	20"
MAXIMUM HEIGHT	84"

- Cordless Breeze shades can be built on small 1-1/2" and/or large 2-1/2" depth headrail depending on shade material and size.

2 on 1 Headrail Shades (Cordless Breeze)	2 on 1 Headrail
MINIMUM WIDTH	20" (per panel) / 40-1/2" (overall)
MAXIMUM WIDTH	72" (per panel) / 120" (overall)
MINIMUM HEIGHT	20"
MAXIMUM HEIGHT	84"

- Cordless Breeze shades are NOT available as 3 on 1 headrail and can only built on 2-1/2" depth headrail with 2 on 1.
- Woven vertical "thread patterns" on the valance may not align to thread patterns on multiple shades on 1 headrail.

SIZE SPECIFICATIONS: SELECT WEAVES

Cordless Lift Shades		2 1/2" Headrail
MINIMUM WIDTH		20" (per panel)
MAXIMUM WIDTH		84"
MINIMUM HEIGHT		20"
MAXIMUM HEIGHT		84"

- Shades are only built on the 2-1/2" depth headrail.

2 on 1 Headrail Shades (Cordless Lift)		2 on 1 Headrail
MINIMUM WIDTH		20" (per panel) / 40-1/2" (overall)
MAXIMUM WIDTH		84" (per panel) / 120" (overall)
MINIMUM HEIGHT		20"
MAXIMUM HEIGHT		84"

- Cordless shades are NOT available as 3 on 1 headrail.
- Woven vertical "thread patterns" on the valance may not align to thread patterns on multiple shades on 1 headrail.

Simplicity Rechargeable Motorization		RF System
MINIMUM WIDTH		24" Net (single shade), 48-1/2" Net (2 on 1 shade**)
MAXIMUM WIDTH - within max area limit		96" (Single shade), 120" (2 on 1 shade**)
MINIMUM HEIGHT		12"
MAXIMUM HEIGHT - within max area limit		96"
MAXIMUM AREA (SQUARE FEET)		Varies**

- ** 2 on 1 shade requires two motors (see "Simplicity Rechargeable Motorization Options" for surcharge information).
- *** Refer to Maximum Motorization Area under Size Specification section for details
- Simplicity motorized shades are built on 2-1/2" depth headrail ONLY without exception.
- Simplicity motorized shades can be ordered as Waterfall

RemoteLift Motorization – Radio Frequency (RF)		RF System
MINIMUM WIDTH		19" Net (single shade), 38-1/2" Net (2 on 1 shade**)
MAXIMUM WIDTH - within max area limit		96" (Single shade), 120" (2 on 1 shade**)
MINIMUM HEIGHT		12"
MAXIMUM HEIGHT - within max area limit		120"
MAXIMUM AREA (SQUARE FEET)		Varies**

- ** 2 on 1 shade requires two motors (see "Motorization" section for surcharge information).
- *** Refer to Maximum Motorization Area under Size Specification section for details
- All battery-operated motorized shades are built on 2-1/2" depth headrail ONLY without exception.
- Single battery wand size recommendation limit is 28 sq.ft., dual battery wand or transformer mandatory for shade equal or greater than 28 sq.ft.
- Motorized shades may be ordered as Waterfall

CORDLESS SPECIFICATIONS: HEADRAIL & SIZE

- See charts below on the headrail depth default
- 1-1/2" depth headrail is available with Cordless Breeze under most of the materials when order width is 32" or less, see charts below for detail.
- Cordless Lift shade only available under 2-1/2" depth headrail

WOVEN WOODS:		CORDLESS BREEZE							CORDLESS LIFT					
Code	Color Name	1-1/2" Small Headrail (Order Width ≤ 32")	2-1/2" Large Headrail	Min. Width (single)	Min. Width (2 on 1)	Max. Width	Min. Height	Max. Height	2-1/2" Large Headrail	Min. Width (single)	Min. Width (2 on 1)	Max. Width	Min. Height	Max. Height
CUL-2085	Antigua Maze	N/A	Default	20"	40.5"	84" per panel 120" (2 on 1)	20"	84"	Default	20"	40.5"	84" per panel 120" overall width	20"	84"
CUL-2086	Antigua Surf	N/A	Default	20"	40.5"	84" per panel 120" (2 on 1)	20"	84"	Default	20"	40.5"	84" per panel 120" overall width	20"	84"
CUL-2157	Banjar Artisan	N/A	Default	20"	40.5"	84" per panel 120" (2 on 1)	20"	84"	Default	20"	40.5"	84" per panel 120" overall width	20"	84"
CUL-2108	Bimini	N/A	Default	20"	40.5"	84" per panel 120" (2 on 1)	20"	84"	Default	20"	40.5"	84" per panel 120" overall width	20"	84"
TER-2057	Ensenada Negro	N/A	Default	20"	40.5"	84" per panel 120" (2 on 1)	20"	72"	Default	20"	40.5"	84" per panel 120" overall width	20"	84"
TER-2002	Ensenada Terra	N/A	Default	20"	40.5"	84" per panel 120" (2 on 1)	20"	72"	Default	20"	40.5"	84" per panel 120" overall width	20"	84"
TER-2078	Ensenada Tranquil	N/A	Default	20"	40.5"	84" per panel 120" (2 on 1)	20"	72"	Default	20"	40.5"	84" per panel 120" overall width	20"	84"
TER-2208	Hi-Lo Espresso	Default	Optional	20"	40.5"	84" per panel 120" (2 on 1)	20"	84"	Default	20"	40.5"	84" per panel 120" overall width	20"	84"
TER-2212	Hi-Lo Gray	Default	Optional	20"	40.5"	84" per panel 120" (2 on 1)	20"	84"	Default	20"	40.5"	84" per panel 120" overall width	20"	84"
TER-2211	Hi-Lo Tan	Default	Optional	20"	40.5"	84" per panel 120" (2 on 1)	20"	84"	Default	20"	40.5"	84" per panel 120" overall width	20"	84"
TER-2210	Hi-Lo White	Default	Optional	20"	40.5"	84" per panel 120" (2 on 1)	20"	84"	Default	20"	40.5"	84" per panel 120" overall width	20"	84"
ELI-2084	Honduras Rust	N/A	Default	20"	40.5"	84" per panel 120" (2 on 1)	20"	72"	Default	20"	40.5"	84" per panel 120" overall width	20"	84"
ELI-2083	Honduras Timbre	N/A	Default	20"	40.5"	84" per panel 120" (2 on 1)	20"	72"	Default	20"	40.5"	84" per panel 120" overall width	20"	84"
CUL-2072	Hunan	Default	Optional	20"	40.5"	84" per panel 120" (2 on 1)	20"	84"	Default	20"	40.5"	84" per panel 120" overall width	20"	84"
EXO-2054	Indo Chic	Default	Optional	20"	40.5"	84" per panel 120" (2 on 1)	20"	84"	Default	20"	40.5"	84" per panel 120" overall width	20"	84"
TER-2004	Jolo	N/A	Default	20"	40.5"	84" per panel 120" (2 on 1)	20"	72"	Default	20"	40.5"	84" per panel 120" overall width	20"	84"
TER-2110	Kano Greywood	N/A	Default	20"	40.5"	84" per panel 120" (2 on 1)	20"	84"	Default	20"	40.5"	84" per panel 120" overall width	20"	84"
TER-2111	Kano Mahogany	Default	Optional	20"	40.5"	84" per panel 120" (2 on 1)	20"	84"	Default	20"	40.5"	84" per panel 120" overall width	20"	84"
ELI-2049	Katmandu	N/A	Default	20"	40.5"	84" per panel 120" (2 on 1)	20"	72"	Default	20"	40.5"	84" per panel 120" overall width	20"	84"
CUL-2155	Katni Intrigue	N/A	Default	20"	40.5"	84" per panel 120" (2 on 1)	20"	84"	Default	20"	40.5"	84" per panel 120" overall width	20"	84"
TER-2003	Kaui	N/A	Default	20"	40.5"	84" per panel 120" (2 on 1)	20"	72"	Default	20"	40.5"	84" per panel 120" overall width	20"	84"
EXO-2068	Kiribati Jungle	Default	Optional	20"	40.5"	84" per panel 120" (2 on 1)	20"	84"	Default	20"	40.5"	84" per panel 120" overall width	20"	84"
EXO-2069	Kiribati Rainforest	Default	Optional	20"	40.5"	84" per panel 120" (2 on 1)	20"	84"	Default	20"	40.5"	84" per panel 120" overall width	20"	84"
TER-2076	Kota	N/A	Default	20"	40.5"	84" per panel 120" (2 on 1)	20"	72"	Default	20"	40.5"	84" per panel 120" overall width	20"	84"
CUL-2204	Kyoto Ebony	N/A	Default	20"	40.5"	84" per panel 120" (2 on 1)	20"	84"	Default	20"	40.5"	84" per panel 120" overall width	20"	84"
EXO-2230	Kyoto Sunset	Default	Optional	20"	40.5"	84" per panel 120" (2 on 1)	20"	84"	Default	20"	40.5"	84" per panel 120" overall width	20"	84"
EXO-2151	Mandalay Mystique	N/A	Default	20"	40.5"	84" per panel 120" (2 on 1)	20"	84"	Default	20"	40.5"	84" per panel 120" overall width	20"	84"
CUL-2223	Mesa Mocha	N/A	Default	20"	40.5"	84" per panel 120" (2 on 1)	20"	72"	Default	20"	40.5"	84" per panel 120" overall width	20"	84"
ELI-2104	Nagoya Harvest	Default	Optional	20"	40.5"	84" per panel 120" (2 on 1)	20"	84"	Default	20"	40.5"	84" per panel 120" overall width	20"	84"
CUL-2061	Saba Dusk	N/A	Default	20"	40.5"	84" per panel 120" (2 on 1)	20"	72"	Default	20"	40.5"	84" per panel 120" overall width	20"	84"
CUL-2060	Saba Sunset	N/A	Default	20"	40.5"	84" per panel 120" (2 on 1)	20"	72"	Default	20"	40.5"	84" per panel 120" overall width	20"	84"
ELI-2153	Sakura Etude	Default	Optional	20"	40.5"	84" per panel 120" (2 on 1)	20"	84"	Default	20"	40.5"	84" per panel 120" overall width	20"	84"
EXO-2053	Serengeti Cocoa	Default	Optional	20"	40.5"	84" per panel 120" (2 on 1)	20"	84"	Default	20"	40.5"	84" per panel 120" overall width	20"	84"
EXO-2052	Serengeti Sunrise	Default	Optional	20"	40.5"	84" per panel 120" (2 on 1)	20"	84"	Default	20"	40.5"	84" per panel 120" overall width	20"	84"
TER-2011	Sonora Desert	N/A	Default	20"	40.5"	84" per panel 120" (2 on 1)	20"	84"	Default	20"	40.5"	84" per panel 120" overall width	20"	84"
EXO-2150	Sumatra Surprise	Default	Optional	20"	40.5"	84" per panel 120" (2 on 1)	20"	84"	Default	20"	40.5"	84" per panel 120" overall width	20"	84"
EXO-2232	Taos	Default	Optional	20"	40.5"	72" per panel 120" (2 on 1)	20"	84"	Default	20"	40.5"	84" per panel 120" overall width	20"	84"
CUL-2070	Tobago	N/A	Default	20"	40.5"	84" per panel 120" (2 on 1)	20"	84"	Default	20"	40.5"	84" per panel 120" overall width	20"	84"
CUL-2100	Tortuga Cocoa	N/A	Default	20"	40.5"	84" per panel 120" (2 on 1)	20"	72"	Default	20"	40.5"	84" per panel 120" overall width	20"	84"
CUL-2099	Tortuga Coral	N/A	Default	20"	40.5"	84" per panel 120" (2 on 1)	20"	72"	Default	20"	40.5"	84" per panel 120" overall width	20"	84"
ELI-2059	Veracruz Earth	N/A	Default	20"	40.5"	84" per panel 120" (2 on 1)	20"	72"	Default	20"	40.5"	84" per panel 120" overall width	20"	84"
ELI-2080	Veracruz Mocha	N/A	Default	20"	40.5"	84" per panel 120" (2 on 1)	20"	72"	Default	20"	40.5"	84" per panel 120" overall width	20"	84"
TER-2234	Zee Gray	N/A	Default	20"	40.5"	84" per panel 120" (2 on 1)	20"	72"	Default	20"	40.5"	84" per panel 120" overall width	20"	84"
TER-2236	Zee Tan	N/A	Default	20"	40.5"	84" per panel 120" (2 on 1)	20"	72"	Default	20"	40.5"	84" per panel 120" overall width	20"	84"
TER-2237	Zee White	N/A	Default	20"	40.5"	84" per panel 120" (2 on 1)	20"	72"	Default	20"	40.5"	84" per panel 120" overall width	20"	84"
EXO-2096	Zulu	N/A	Default	20"	40.5"	84" per panel 120" (2 on 1)	20"	84"	Default	20"	40.5"	84" per panel 120" overall width	20"	84"

CORDLESS SPECIFICATIONS: HEADRAIL & SIZE

- See charts below on the headrail depth default
- 1-1/2" depth headrail is available with Cordless Breeze under most of the materials when order width is 32" or less, see charts below for detail.
- Cordless Lift shade only available under 2-1/2" depth headrail

SELECT WEAVES:		CORDLESS BREEZE							CORDLESS LIFT					
Code	Color Name	1-1/2" Small Headrail (Order Width ≤ 32")	2-1/2" Large Headrail	Min. Width (single)	Min. Width (2 on 1')	Max. Width	Min. Height	Max. Height	2-1/2" Large Headrail	Min. Width (single)	Min. Width (2 on 1')	Max. Width	Min. Height	Max. Height
SLW-2527	Cancun Light Gray	Default	Optional	20"	40.5"	72" per panel 120" (2 on 1)	20"	84"	Default	20"	40.5"	84" per panel 120" overall width	20"	84"
SLW-2528	Cancun Off White	Default	Optional	20"	40.5"	72" per panel 120" (2 on 1)	20"	84"	Default	20"	40.5"	84" per panel 120" overall width	20"	84"
SLW-2529	Cano Cream	Default	Optional	20"	40.5"	72" per panel 120" (2 on 1)	20"	84"	Default	20"	40.5"	84" per panel 120" overall width	20"	84"
SLW-2411	Jaipur Natural	Default	Optional	20"	40.5"	72" per panel 120" (2 on 1)	20"	84"	Default	20"	40.5"	84" per panel 120" overall width	20"	84"
SLW-2417	Lagos	Default	Optional	20"	40.5"	72" per panel 120" (2 on 1)	20"	84"	Default	20"	40.5"	84" per panel 120" overall width	20"	84"
SLW-2419	Lomaloma	Default	Optional	20"	40.5"	72" per panel 120" (2 on 1)	20"	84"	Default	20"	40.5"	84" per panel 120" overall width	20"	84"
SLW-2420	Macau	Default	Optional	20"	40.5"	72" per panel 120" (2 on 1)	20"	84"	Default	20"	40.5"	84" per panel 120" overall width	20"	84"
SLW-2530	Madeira Green	Default	Optional	20"	40.5"	72" per panel 120" (2 on 1)	20"	84"	Default	20"	40.5"	84" per panel 120" overall width	20"	84"
SLW-2423	Mali Tan	Default	Optional	20"	40.5"	72" per panel 120" (2 on 1)	20"	84"	Default	20"	40.5"	84" per panel 120" overall width	20"	84"
SLW-2531	Rio Gray	Default	Optional	20"	40.5"	72" per panel 120" (2 on 1)	20"	84"	Default	20"	40.5"	84" per panel 120" overall width	20"	84"
SLW-2526	Salvador Driftwood	Default	Optional	20"	40.5"	72" per panel 120" (2 on 1)	20"	84"	Default	20"	40.5"	84" per panel 120" overall width	20"	84"
SLW-2431	Santos Natural	Default	Optional	20"	40.5"	72" per panel 120" (2 on 1)	20"	84"	Default	20"	40.5"	84" per panel 120" overall width	20"	84"
SLW-2433	Sintra Dust	Default	Optional	20"	40.5"	72" per panel 120" (2 on 1)	20"	84"	Default	20"	40.5"	84" per panel 120" overall width	20"	84"
SLW-2438	Suva	Default	Optional	20"	40.5"	72" per panel 120" (2 on 1)	20"	84"	Default	20"	40.5"	84" per panel 120" overall width	20"	84"
SLW-2441	Tunisia	Default	Optional	20"	40.5"	72" per panel 120" (2 on 1)	20"	84"	Default	20"	40.5"	84" per panel 120" overall width	20"	84"

GRASS WEAVES:		CORDLESS BREEZE							CORDLESS LIFT					
Code	Color Name	1-1/2" Small Headrail (Order Width ≤ 32")	2-1/2" Large Headrail	Min. Width (single)	Min. Width (2 on 1')	Max. Width	Min. Height	Max. Height	2-1/2" Large Headrail	Min. Width (single)	Min. Width (2 on 1')	Max. Width	Min. Height	Max. Height
GRW-9464	Aruba Café	Default	Optional	20"	40.5"	72" per panel 120" (2 on 1)	20"	84"	Default	20"	40.5"	84" per panel 120" overall width	20"	84"
GRW-9463	Aruba Driftwood	Default	Optional	20"	40.5"	72" per panel 120" (2 on 1)	20"	84"	Default	20"	40.5"	84" per panel 120" overall width	20"	84"
GRW-9462	Aruba Sand Dune	Default	Optional	20"	40.5"	72" per panel 120" (2 on 1)	20"	84"	Default	20"	40.5"	84" per panel 120" overall width	20"	84"
GRW-9461	Aruba Straw	Default	Optional	20"	40.5"	72" per panel 120" (2 on 1)	20"	84"	Default	20"	40.5"	84" per panel 120" overall width	20"	84"
GRW-9460	Aruba Summer	Default	Optional	20"	40.5"	72" per panel 120" (2 on 1)	20"	84"	Default	20"	40.5"	84" per panel 120" overall width	20"	84"
GRW-2304	Caracas Tortoise	Default	Optional	20"	40.5"	72" per panel 120" (2 on 1)	20"	84"	Default	20"	40.5"	84" per panel 120" overall width	20"	84"
GRW-9474	Celebes Cornsilk	Default	Optional	20"	40.5"	72" per panel 120" (2 on 1)	20"	84"	Default	20"	40.5"	84" per panel 120" overall width	20"	84"
GRW-9476	Celebes Ivory	Default	Optional	20"	40.5"	72" per panel 120" (2 on 1)	20"	84"	Default	20"	40.5"	84" per panel 120" overall width	20"	84"
GRW-9475	Celebes Seashell	Default	Optional	20"	40.5"	72" per panel 120" (2 on 1)	20"	84"	Default	20"	40.5"	84" per panel 120" overall width	20"	84"
GRW-9410	Coban Gray	Default	Optional	20"	40.5"	72" per panel 120" (2 on 1)	20"	84"	Default	20"	40.5"	84" per panel 120" overall width	20"	84"
GRW-2305	Coban Parchment	Default	Optional	20"	40.5"	72" per panel 120" (2 on 1)	20"	84"	Default	20"	40.5"	84" per panel 120" overall width	20"	84"
GRW-9420	Granada Bark	Default	Optional	20"	40.5"	72" per panel 120" (2 on 1)	20"	84"	Default	20"	40.5"	84" per panel 120" overall width	20"	84"
GRW-2310	Granada Cinnamon	Default	Optional	20"	40.5"	72" per panel 120" (2 on 1)	20"	84"	Default	20"	40.5"	84" per panel 120" overall width	20"	84"
GRW-2311	Granada Ginger	Default	Optional	20"	40.5"	72" per panel 120" (2 on 1)	20"	84"	Default	20"	40.5"	84" per panel 120" overall width	20"	84"
GRW-2312	Granada Nutmeg	Default	Optional	20"	40.5"	72" per panel 120" (2 on 1)	20"	84"	Default	20"	40.5"	84" per panel 120" overall width	20"	84"
GRW-2324	Luzon Cornsilk	Default	Optional	20"	40.5"	72" per panel 120" (2 on 1)	20"	84"	Default	20"	40.5"	84" per panel 120" overall width	20"	84"
GRW-2325	Luzon Greige	Default	Optional	20"	40.5"	72" per panel 120" (2 on 1)	20"	84"	Default	20"	40.5"	84" per panel 120" overall width	20"	84"
GRW-2323	Luzon Whisper	Default	Optional	20"	40.5"	72" per panel 120" (2 on 1)	20"	84"	Default	20"	40.5"	84" per panel 120" overall width	20"	84"
GRW-9473	Martinique Coral	Default	Optional	20"	40.5"	72" per panel 120" (2 on 1)	20"	84"	Default	20"	40.5"	84" per panel 120" overall width	20"	84"
GRW-9471	Martinique Sea Grass	Default	Optional	20"	40.5"	72" per panel 120" (2 on 1)	20"	84"	Default	20"	40.5"	84" per panel 120" overall width	20"	84"
GRW-9472	Martinique Surf	Default	Optional	20"	40.5"	72" per panel 120" (2 on 1)	20"	84"	Default	20"	40.5"	84" per panel 120" overall width	20"	84"
GRW-9470	Martinique White Wash	Default	Optional	20"	40.5"	72" per panel 120" (2 on 1)	20"	84"	Default	20"	40.5"	84" per panel 120" overall width	20"	84"
GRW-9440	Nassau Cocoa	Default	Optional	20"	40.5"	72" per panel 120" (2 on 1)	20"	84"	Default	20"	40.5"	84" per panel 120" overall width	20"	84"
GRW-2331	Nassau Pewter	Default	Optional	20"	40.5"	72" per panel 120" (2 on 1)	20"	84"	Default	20"	40.5"	84" per panel 120" overall width	20"	84"
GRW-2337	Singapore Bisque	Default	Optional	20"	40.5"	72" per panel 120" (2 on 1)	20"	84"	Default	20"	40.5"	84" per panel 120" overall width	20"	84"
GRW-2339	Singapore Cotton	Default	Optional	20"	40.5"	72" per panel 120" (2 on 1)	20"	84"	Default	20"	40.5"	84" per panel 120" overall width	20"	84"
GRW-9450	Singapore Gray	Default	Optional	20"	40.5"	72" per panel 120" (2 on 1)	20"	84"	Default	20"	40.5"	84" per panel 120" overall width	20"	84"
GRW-2338	Singapore Talc	Default	Optional	20"	40.5"	72" per panel 120" (2 on 1)	20"	84"	Default	20"	40.5"	84" per panel 120" overall width	20"	84"
GRW-9400	St. Kitts Dune	Default	Optional	20"	40.5"	72" per panel 120" (2 on 1)	20"	84"	Default	20"	40.5"	84" per panel 120" overall width	20"	84"
GRW-9401	St. Kitts Greywood	Default	Optional	20"	40.5"	72" per panel 120" (2 on 1)	20"	84"	Default	20"	40.5"	84" per panel 120" overall width	20"	84"
GRW-2340	St. Lucia Sand	Default	Optional	20"	40.5"	72" per panel 120" (2 on 1)	20"	84"	Default	20"	40.5"	84" per panel 120" overall width	20"	84"
GRW-2343	St. Lucia Storm	Default	Optional	20"	40.5"	72" per panel 120" (2 on 1)	20"	84"	Default	20"	40.5"	84" per panel 120" overall width	20"	84"
GRW-2345	Zaire Camel	Default	Optional	20"	40.5"	72" per panel 120" (2 on 1)	20"	84"	Default	20"	40.5"	84" per panel 120" overall width	20"	84"

SIZE SPECIFICATIONS: MAXIMUM MOTORIZATION AREA

Collection	Code	Color Name	Maximum Shade Size Without Liner	Maximum Shade Size with Liner
Woven Wood	CUL-2085	Antigua Maze	30 SQF	20 SQF
Woven Wood	CUL-2086	Antigua Surf	30 SQF	20 SQF
Woven Wood	CUL-2157	Banjar Artisan	30 SQF	20 SQF
Woven Wood	CUL-2108	Bimini	20 SQF	15 SQF
Woven Wood	TER-2057	Ensenada Negro	15 SQF	10 SQF
Woven Wood	TER-2002	Ensenada Terra	15 SQF	10 SQF
Woven Wood	TER-2078	Ensenada Tranquil	15 SQF	10 SQF
Woven Wood	TER-2208	Hi-Lo Espresso	35 SQF	20 SQF
Woven Wood	TER-2212	Hi-Lo Gray	35 SQF	20 SQF
Woven Wood	TER-2211	Hi-Lo Tan	35 SQF	20 SQF
Woven Wood	TER-2210	Hi-Lo White	35 SQF	20 SQF
Woven Wood	ELI-2084	Honduras Rust	15 SQF	10 SQF
Woven Wood	ELI-2083	Honduras Timbre	15 SQF	10 SQF
Woven Wood	CUL-2072	Hunan	25 SQF	15 SQF
Woven Wood	EXO-2054	Indo Chic	35 SQF	20 SQF
Woven Wood	TER-2004	Jolo	15 SQF	10 SQF
Woven Wood	TER-2110	Kano Greywood	30 SQF	20 SQF
Woven Wood	TER-2111	Kano Mahogany	30 SQF	20 SQF
Woven Wood	ELI-2049	Katmandu	20 SQF	10 SQF
Woven Wood	CUL-2155	Katni Intrigue	25 SQF	15 SQF
Woven Wood	TER-2003	Kaui	15 SQF	10 SQF
Woven Wood	EXO-2068	Kiribati Jungle	40 SQF	30 SQF
Woven Wood	EXO-2069	Kiribati Rainforest	60 SQF	40 SQF
Woven Wood	TER-2076	Kota	15 SQF	10 SQF
Woven Wood	CUL-2204	Kyoto Ebony	25 SQF	15 SQF
Woven Wood	EXO-2230	Kyoto Sunset	25 SQF	15 SQF
Woven Wood	EXO-2151	Mandalay Mystique	30 SQF	20 SQF
Woven Wood	CUL-2223	Mesa Mocha	20 SQF	10 SQF
Woven Wood	ELI-2104	Nagoya Harvest	50 SQF	35 SQF
Woven Wood	CUL-2061	Saba Dusk	20 SQF	10 SQF
Woven Wood	CUL-2060	Saba Sunset	15 SQF	10 SQF
Woven Wood	ELI-2153	Sakura Etude	40 SQF	25 SQF
Woven Wood	EXO-2053	Serengeti Cocoa	40 SQF	30 SQF
Woven Wood	EXO-2052	Serengeti Sunrise	40 SQF	30 SQF
Woven Wood	TER-2011	Sonora Desert	25 SQF	15 SQF
Woven Wood	EXO-2150	Sumatra Surprise	50 SQF	35 SQF
Woven Wood	EXO-2232	Taos	40 SQF	25 SQF
Woven Wood	CUL-2070	Tobago	25 SQF	15 SQF
Woven Wood	CUL-2100	Tortuga Cocoa	20 SQF	15 SQF
Woven Wood	CUL-2099	Tortuga Coral	20 SQF	15 SQF
Woven Wood	ELI-2059	Veracruz Earth	15 SQF	10 SQF
Woven Wood	ELI-2059	Veracruz Earth	15 SQF	10 SQF
Woven Wood	ELI-2080	Veracruz Mocha	15 SQF	10 SQF
Woven Wood	TER-2234	Zee Gray	20 SQF	10 SQF
Woven Wood	TER-2236	Zee Tan	20 SQF	10 SQF
Woven Wood	TER-2237	Zee White	20 SQF	10 SQF
Woven Wood	EXO-2096	Zulu	35 SQF	25 SQF

Collection	Code	Color Name	Maximum Shade Size Without Liner	Maximum Shade Size with Liner
Select Weave	SLW-2527	Cancun Light Gray	50 SQF	30 SQF
Select Weave	SLW-2528	Cancun Off White	50 SQF	30 SQF
Select Weave	SLW-2529	Cano Cream	50 SQF	35 SQF
Select Weave	SLW-2411	Jaipur Natural	60 SQF	60 SQF
Select Weave	SLW-2417	Lagos	60 SQF	50 SQF
Select Weave	SLW-2419	Lomaloma	60 SQF	60 SQF
Select Weave	SLW-2420	Macau	40 SQF	30 SQF
Select Weave	SLW-2530	Madeira Green	60 SQF	40 SQF
Select Weave	SLW-2423	Mali Tan	50 SQF	35 SQF
Select Weave	SLW-2531	Rio Gray	60 SQF	40 SQF
Select Weave	SLW-2526	Salvador Driftwood	60 SQF	40 SQF
Select Weave	SLW-2431	Santos Natural	60 SQF	60 SQF
Select Weave	SLW-2433	Sintra Dust	60 SQF	40 SQF
Select Weave	SLW-2438	Suva	40 SQF	30 SQF
Select Weave	SLW-2441	Tunisia	60 SQF	60 SQF

Collection	Code	Color Name	Maximum Shade Size Without Liner	Maximum Shade Size with Liner
Grass Weave	GRW-9464	Aruba Café	60 SQF	60 SQF
Grass Weave	GRW-9463	Aruba Driftwood	60 SQF	60 SQF
Grass Weave	GRW-9462	Aruba Sand Dune	60 SQF	60 SQF
Grass Weave	GRW-9461	Aruba Straw	60 SQF	60 SQF
Grass Weave	GRW-9460	Aruba Summer	60 SQF	60 SQF
Grass Weave	GRW-2304	Caracas Tortoise	60 SQF	60 SQF
Grass Weave	GRW-9410	Coban Gray	60 SQF	60 SQF
Grass Weave	GRW-2305	Coban Parchment	60 SQF	60 SQF
Grass Weave	GRW-9420	Granada Bark	60 SQF	60 SQF
Grass Weave	GRW-2310	Granada Cinnamon	60 SQF	60 SQF
Grass Weave	GRW-2311	Granada Ginger	60 SQF	60 SQF
Grass Weave	GRW-2312	Granada Nutmeg	60 SQF	60 SQF
Grass Weave	GRW-2324	Luzon Cornsilk	60 SQF	60 SQF
Grass Weave	GRW-2325	Luzon Greige	60 SQF	60 SQF
Grass Weave	GRW-2323	Luzon Whisper	60 SQF	60 SQF
Grass Weave	GRW-9473	Martinique Coral	60 SQF	60 SQF
Grass Weave	GRW-9471	Martinique Sea Grass	60 SQF	60 SQF
Grass Weave	GRW-9472	Martinique Surf	60 SQF	60 SQF
Grass Weave	GRW-9470	Martinique White Wash	60 SQF	60 SQF
Grass Weave	GRW-9440	Nassau Cocoa	60 SQF	60 SQF
Grass Weave	GRW-2331	Nassau Pewter	60 SQF	60 SQF
Grass Weave	GRW-2337	Singapore Bisque	60 SQF	60 SQF
Grass Weave	GRW-2339	Singapore Cotton	60 SQF	60 SQF
Grass Weave	GRW-9450	Singapore Gray	60 SQF	60 SQF
Grass Weave	GRW-2338	Singapore Talc	60 SQF	60 SQF
Grass Weave	GRW-9400	St. Kitts Dune	60 SQF	60 SQF
Grass Weave	GRW-9401	St. Kitts Greywood	60 SQF	60 SQF
Grass Weave	GRW-2340	St. Lucia Sand	60 SQF	60 SQF
Grass Weave	GRW-2343	St. Lucia Storm	60 SQF	60 SQF
Grass Weave	GRW-2345	Zaire Camel	60 SQF	60 SQF

SIZE SPECIFICATIONS: WOVEN WOODS, SELECT WEAVES, AND GRASS WEAVES

Headrail Sizes	Headrail SIZE	Headrail DEPTH
Standard, Waterfall Style and Top-Down Shades	Small	1-1/2"
2 or 3 on 1 Headrail Shades (for Standard, Waterfall & Top-Down Shades)	Small	1-1/2"
3/4" Headrail Shades (Standard and Waterfall Shades ONLY) (Valance returns not available)	3/4"	3/4"
Top-Down / Bottom-Up Shades*	Small/Large	1-1/2" / 2-1/2"
Continuous Cord Loop Shades** (all shade sizes)	Large	2-1/2"
Cordless Breeze Shades***	Small/Large	1-1/2" / 2-1/2"
Cordless Lift Shades** (all shade sizes)	Large	2-1/2"
Simplicity Rechargeable & RemoteLift Motorized Shades	Large	2 1/2"
2 on 1 Headrail Shades (Continuous Cord, Cordless & Simplicity Motorization)	Large	2 1/2"
2 on 1 or 3 on 1 Headrail Shades (TDBU)*	Small/Large	1-1/2" / 2-1/2"
Individual Valances – Standard	Narrow (IB) / Large	3/4" / 2-1/2"
Individual Valances – Optional	Small	1-1/2"

- All Standard Rectangular shades are built on SMALL 1-1/2" depth headrail unless the LARGE 2-1/2" depth headrail is specified on the order.
- * Top-Down/Bottom-Up shades are built on 1-1/2" depth headrail. For 2 on 1 or 3 on 1 TDBU shades that are larger than 96" in width are built on a 2-1/2" headrail
- ** Continuous Cord Loop, Cordless and Simplicity Motorization shades are only built on the large 2-1/2" depth headrail and not available on 3 on 1.
- *** Cordless Breeze shades can be built on small 1-1/2" and/or large 2-1/2" depth headrail depending on shade material and size. Cordless Breeze shades are NOT available as 3 on 1 headrail, and can only be built on 2-1/2" depth headrail with 2 on 1.

Twill Edge-Binding and Faux Silk Binding

- Shades ordered with Twill Edge-Binding or Faux Silk Binding follow the same size specifications as listed on the preceding pages.
- **On Cordless, binding can only go onto shade sides and/or valance sides (ES or ESO and TS or TSO) if ordered.**

SHADE Valances	Shade Height	Valance Height
ALL Shades	Under 18"	4"
ALL Shades	18" and Over	6"
MAXIMUM Custom Valance Height - With NO Extra Charge	any	Up to 12"
MAXIMUM Valance Height - With EXTRA Charge	any	Over 12", up to 24"

- Valance heights may vary by + or - 3/4" due to the variations in woven materials.
- Custom valance heights up to 12" are free of charge. For extra charge on custom valance height over 12", refer to valance price grid.
- OB valances will include the Valance Return Stabilizer (VRS) System (Woven Wood patterns only).

SHADE Valance returns depth for standard cordlock				
Headrail Size	Mount Type	Standard	Minimum	Maximum
1-1/2" (Small)	Inside Mount - default no returns	1-1/2"	1-1/2"	2"
	Outside Mount	1-3/4" / 1-1/2" (waterfall)	1-1/2"	2"
2-1/2" (Large)	Inside Mount - default no returns	2-1/2"	1-1/2"	3"
	Outside Mount	2-3/4" / 2-1/2" (waterfall)	1-1/2"	3"

SHADE Valance returns depth for cordless breeze				
Headrail Size	Mount Type	Standard	Minimum	Maximum
1-1/2" (Small)	Inside Mount - default no returns	1-1/2"	1-1/2"	2"
	Outside Mount	1-3/4"	1-1/2"	2"
2-1/2" (Large)	Inside Mount - default no returns	2-1/2"	1-1/2"	3"
	Outside Mount	2-3/4"	1-1/2"	3"

SHADE Valance returns depth for continuous cord loop & cordless lift				
Headrail Size	Mount Type	Standard	Minimum	Maximum
2-1/2" (Large)	Inside Mount - default no returns	2-1/2"	1-1/2"	3"
	Outside Mount	3-1/8"	1-1/2"	3-1/8"

SHADE Valance returns depth for remotelift & simplicity motorization				
Headrail Size	Mount Type	Standard	Minimum	Maximum
2-1/2" (Large)	Inside Mount - default no returns	2-1/2"	1-1/2"	3"
	Outside Mount	2-3/4" / 2-1/2" (waterfall)	1-1/2"	3"

INDIVIDUAL Valances	Standard
MINIMUM WIDTH	10"
MAXIMUM WIDTH*	72" / 96" (without seam)
MINIMUM HEIGHT	4"
MAXIMUM HEIGHT	24"

- Valance heights may vary by + or - 3/4" due to the variations in woven materials. Individual valances are built on the 2-1/2" depth headrail unless specified.
- OB valances will include the Valance Return Stabilizer (VRS) System if ordered on a headrail (Woven Wood patterns only).
- * Maximum width can go up to 120" with seam for Salvador Driftwood as well as most grass weave patterns except Zaire Camel.

INDIVIDUAL Valance returns depth				
Headrail Size	Mount Type	Standard	Minimum	Maximum
3/4" (Narrow)	Inside Mount - default no returns	N/A	N/A	N/A
	Outside Mount	N/A	N/A	N/A
1-1/2" (Small)	Inside Mount - default no returns	1-1/2"	1-1/2"	2"
	Outside Mount	1-3/4"	1-1/2"	2"
2-1/2" (Large)	Inside Mount - default no returns	2-1/2"	1-1/2"	3"
	Outside Mount	2-3/4"	1-1/2"	3"

To order Woven material only in linear widths, contact customer service.

PRODUCT SPECIFICATIONS: NATURAL WOVEN SHADES

FINISHED DIMENSIONS

Adjustments are taken from ordered dimensions and may vary slightly.

TRADITIONAL, TOP-DOWN, TOP-DOWN/BOTTOM-UP

Inside (IB/IS) Mount	
Headrail, Valance & Fabric Width	- 1/2"
Shade Height	ordered height
Outside (OB/OS) & Ceiling Mount	
Headrail Width	ordered width
Valance Width*	+ 1"
Fabric Width	ordered width
Shade Height	ordered height

2 on 1 (and 3 on 1) Headrail	
Gap Between Panels	- 1/2"

MOUNTING REQUIREMENTS

Use a metal tape measure for all measurements.

1 1/2" Headrail Clearance Requirement

Inside (IB/IS) Mount	
Minimum Mounting Depth	1 1/2"
Minimum Mounting Depth, Flush Mount **	2 1/4"
Outside (OB/OS) Mount	
Minimum Flat Vertical Surface	1"

2 1/2" Headrail Clearance Requirement

Inside (IB/IS) Mount	
Minimum Mounting Depth	1 1/2"
Minimum Mounting Depth, Flush Mount **	3 1/4"
Outside (OB/OS) Mount	
Minimum Flat Vertical Surface	1"

CONTINUOUS CORD LOOP, CORDLESS BREEZE & CORDLESS LIFT (Bottom Up Only)

Inside (IB/IS) Mount	
Headrail, Valance & Fabric Width	- 1/2"
Shade Height	ordered height
Outside (OB/OS) & Ceiling Mount	
Headrail Width	+ 1/2"
Valance Width*	+ 1 1/2"
Fabric Width	ordered width
Shade Height	ordered height

2 on 1 Headrail	
Gap Between Panels	- 1/2"

Note: Cord Loop Shades have adjusted Inside mount width deductions and outside mount width additions to allow operational clearance for the cord loop and safety tensioner.

2 1/2" Headrail Clearance Requirement

Inside (IB/IS) Mount	
Minimum Mounting Depth	1 1/2"
Minimum Mounting Depth, Flush Mount **	3 1/4"
Outside (OB/OS) Mount	
Minimum Flat Vertical Surface	1"

1 1/2" Headrail Clearance Requirement *(Cordless Breeze* only)*

Inside (IB/IS) Mount	
Minimum Mounting Depth	1/2"
Minimum Mounting Depth, Flush Mount **	2 1/4"
Outside (OB/OS) Mount	
Minimum Flat Vertical Surface	1"

* Depending on the material and shade size, cordless breeze shade can be built on 1-1/2" and/or 2-1/2" headrail (See **Cordless Specifications: Headrail & Size** section for detail).

FINISHED DIMENSION & MOUNTING NOTES

Note: Ceiling mount shades are OB/OS by default and have the same finished dimensions. IB/IS shades may also be "TOP" mounted using the standard L-style brackets or using the optional Flat brackets.

** The flush mount depth requirements indicated above include space for the woven material attached to the front (valance) and back (shade) sides of the headrail. These are AVERAGE depths as the different woven wood materials have varying degrees of thickness. Verify your individual shade's depth before mounting, then position brackets accordingly for an EXACT flush mount.

* OB/OS Valances and returns are attached using a Valance Return Stabilizer. The OB/OS valance width additions indicated above create a "cornice style" box for improved appearance and operation.

Note: Add an extra + 1/2" to the mounting depths for Traditional (standard) and Old Style (waterfall) shades with operable liner.

PRODUCT SPECIFICATIONS: NATURAL WOVEN SHADES

FINISHED DIMENSIONS

Adjustments are taken from ordered dimensions and may vary slightly.

MOUNTING REQUIREMENTS

Use a metal tape measure for all measurements.

SIMPLICITY & REMOTELIFT MOTORIZATION (Bottom Up Only)

2 1/2" Headrail (Standard Fold)	
Inside (IB/IS) Mount	
Headrail, Valance & Fabric Width	- 1/2"
Shade Height	ordered height
Outside (OB/OS) & Ceiling Mount	
Headrail Width	order width
Valance Width*	+1"
Fabric Width	ordered width
Shade Height	ordered height

2 1/2" Headrail (Standard Fold) Clearance Requirement	
Inside (IB/IS) Mount	
Minimum Mounting Depth	1 1/2"
Minimum Mounting Depth, Flush Mount **	3 1/4"
Outside (OB/OS) Mount	
Minimum Flat Vertical Surface	1"

2 1/2" Headrail (Waterfall)	
Inside (IB/IS) Mount	
Headrail & Fabric Width	- 1/2"
Shade Height	ordered height
Outside (OB/OS) & Ceiling Mount	
Headrail & Fabric Width	ordered width
Shade Height	ordered height

2 1/2" Headrail (Waterfall) Clearance Requirement	
Inside (IB/IS) Mount	
Minimum Mounting Depth	1 1/2"
Minimum Mounting Depth, Flush Mount **	3"
Outside (OB/OS) Mount	
Minimum Flat Vertical Surface	1"

Waterfall Style (Front Side Shade, No Valance) - VALANCE IN BACK OF SHADE

Inside (IB/IS) Mount	
Headrail & Fabric Width	- 1/2"
Shade Height	ordered height
Outside (OB/OS) & Ceiling Mount	
Headrail & Fabric Width	ordered width
Shade Height	ordered height

1 1/2" Headrail Clearance Requirement	
Inside (IB/IS) Mount	
Minimum Mounting Depth	1 1/2"
Minimum Mounting Depth, Flush Mount **	2"
Outside (OB/OS) Mount	
Minimum Flat Vertical Surface	1"

2 on 1 (and 3 on 1) Headrail	
Gap Between Panels	- 1/2"

2 1/2" Headrail Clearance Requirement	
Inside (IB/IS) Mount	
Minimum Mounting Depth	1 1/2"
Minimum Mounting Depth, Flush Mount **	3"
Outside (OB/OS) Mount	
Minimum Flat Vertical Surface	1"

Note: A backside valance is provided on IB/IS mounts to hide the components under the headrail from outside view.

3/4" HEADRAIL SHADES (For Narrow-Depth Mounts)

Inside (IB/IS) Mount	
Headrail & Fabric Width	- 1/2"
Shade Height	ordered height
Outside (OB/OS) & Ceiling Mount	
Headrail, Fabric & Valance Width	ordered width
Shade Height	ordered height

3/4" Headrail Clearance Requirement	
Inside (IB/IS) Mount	
Minimum Mounting Depth	3/4"
Minimum Mounting Depth, Flush Mount **	1 1/4"
Outside (OB/OS) Mount	
Minimum Flat Vertical Surface	1/2"

2 on 1 (and 3 on 1) Headrail	
Gap Between Panels	- 1/2"

Note: Valance returns are NOT included with narrow headrail shades.

FINISHED DIMENSION & MOUNTING NOTES

Note: Ceiling mount shades are OB/OS by default and have the same finished dimensions. IB/IS shades may also be "TOP" mounted using the standard L-style brackets or using the optional Flat brackets.

** The flush mount depth requirements indicated above include space for the woven material attached to the front (valance) and back (shade) sides of the headrail. These are AVERAGE depths as the different woven wood materials have varying degrees of thickness. Verify your individual shade's depth before mounting, then position brackets accordingly for an EXACT flush mount.

* OB/OS Valances and returns are attached using a Valance Return Stabilizer. The OB/OS valance width additions indicated above create a "cornice style" box for improved appearance and operation.

Note: Add an extra + 1/2" to the mounting depths for Traditional (standard) and Old Style (waterfall) shades with operable liner.

SMART FACTS



POSITIONED AS ALL SHEER



POSITIONED HOWEVER YOU DESIRE



POSITIONED AS FULL SHADE

- The beautiful combination of a sheer pleated shade on top and woven shade on the bottom provides maximum versatility in a single window covering.
- Performs like a top-down/bottom-up shade, but the sheer pleated shade offers more benefits: diffuses harsh light entering the room; offers moderate privacy during the day; protects furnishings from harmful UV rays.
- Four sheer pleated styles are available in multiple colors to meet most decorating tastes.
- Shade is built on the large 2-1/2" depth stained wood headrail for durability and easy installation.
- The hardware system uses the same quality components as the top-down/bottom-up woven shade.
- The standard cordlock lifts and lowers the shade with ease. The right cord operates the middle rail and the left cord operates the bottomrail.
- The headrail and operating system is hidden by a 6" valance on the front and back side of the shade for a clean interior and exterior appearance. Included on both inside (IB) and outside (OB) mounts. Custom valance heights to 12" at no extra charge.
- The woven panel is available with a fixed privacy lining. When shade is ordered with the optional fixed liner, the valances will also include a liner.

SELECTING A TRILIGHT SHADE

1. Choose a woven style and color for the bottom shade.
 2. Choose a sheer pleated fabric for the top shade. See Color Chart.
 3. Refer to the woven price grids on pages 7-15 to determine your woven wood shade price.
 4. Refer to the sheer pleated grids A on page 37 to find your top shade price. Then simply add the prices (by shade size) of the sheer pleated fabric and woven material together to determine your final price.
- > TriLight Shades are available as a standard rectangle only.
 - > Standard control system—right operates the intermediate rail; left operates the bottomrail. (Note: grouped controls not available.)
 - > Fixed liners are available for the bottom woven shade.

COLOR CHART

TriLight Pleated Sheer (TOP Panel)	
SKU #	PATTERN NAME
P05-500	Snow White
P05-501	Ice
P05-502	Heirloom
P05-503	Soft Ivory
P05-504	Crystal
P05-505	Light Taupe
P05-506	Bisque
P05-507	Latte
P05-508	Chocolate
P05-509	Twilight

TriLight NOT AVAILABLE in following Patterns	
SKU #	PATTERN NAME
GRW-2304	Caracas Tortoise
GRW-2305	Coban Parchment
GRW-2323	Luzon Whisper
GRW-2324	Luzon Comsilk
GRW-2325	Luzon Greige
GRW-2331	Nassau Pewter
GRW-9400	St. Kitts Dune
GRW-9401	St. Kitts Greywood
GRW-9410	Coban Gray
GRW-9440	Nassau Cocoa
GRW-9460	Aruba Summer
GRW-9461	Aruba Straw
GRW-9462	Aruba Sand Dune
GRW-9463	Aruba Driftwood
GRW-9464	Aruba Café
GRW-9470	Martinique White Wash
GRW-9471	Martinique Sea Grass
GRW-9472	Martinique Surf
GRW-9473	Martinique Coral
SLW-2528	Cancun Off White
SLW-2527	Cancun Light Gray

SHEER PLEATED MAXIMUM WIDTHS	% UV BLOCKAGE
Whisper 83"	60

Determine the top shade price by using the charts below.
Add the sheer pleated and woven shade prices together to determine your final price.

GROUP A (Sheer Pleated Rectangular)

• WHISPER SHEER (83")

WIDTH TO:	24"	30"	36"	42"	48"	54"	60"	66"	72"	78"	83"
HEIGHT TO:											
36"	\$63	71	80	89	100	105	116	123	134	139	152
42"	69	75	87	100	105	116	126	135	145	156	167
48"	71	82	95	104	116	126	135	148	158	170	182
54"	75	87	101	111	123	134	148	158	172	185	199
61"	81	93	105	119	133	145	157	170	185	199	212
66"	86	100	112	126	139	155	167	185	199	212	228
72"	89	103	119	134	152	165	179	198	210	226	242
78"	95	107	126	139	158	175	191	207	225	242	256
84"	98	112	131	148	167	182	199	216	233	252	269
90"	101	119	135	155	175	192	210	232	251	269	287
96"	104	123	143	163	182	199	221	239	260	278	300

TRILIGHT OPTIONS & CONFIGURATION SPECIFICATIONS

OPTIONS: NO EXTRA CHARGE

- **Extension Brackets**
- **Spacer Blocks**
- **Special Cord Length** – Standard length is approximately 40% the height of the shade

TRILIGHT – STANDARD

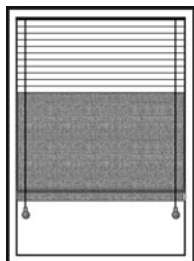

Shade is built on the large 2-1/2" depth wood headrail.
Standard operating controls: Right operates the intermediate rail; left operates the bottomrail. Grouped controls are not available.

TriLight Shades	LARGE Headrail
MINIMUM WIDTH	22"
MAXIMUM WIDTH	84"
MINIMUM HEIGHT	12"
MAXIMUM HEIGHT	96"
MAXIMUM AREA (SQ/FT)	48 to 72 sq/ft*

- TriLight shades are built on the large 2-1/2" depth headrail.
- TriLight shades are NOT available as 2 or 3 on 1 headrail.
- TriLight shades are not available with twill edge-binding, faux silk binding or operable privacy liners. TriLight shades ARE available with fixed liners on the woven panel.
- TriLight shades maximum width is dependent on the maximum width of the ordered Pleated TOP panel fabric which is 84" wide.
- TriLight shades are only available with SPLIT controls (grouped controls are not available).
- Cut-outs are not available on TriLight shades.

* TriLight shades maximum area (sq/ft) is dependent on the ordered woven material. Heavier materials are limited to 48 sq/ft, medium to 60 sq/ft and light to 72 sq/ft.

FINISHED DIMENSIONS

Adjustments are taken from ordered dimensions and may vary slightly.
Measurements may vary +/- 1/8".

Inside (IB) Mount	
Headrail & Valance Width *	- 1/2"
Fabric Width	- 1/2"
Shade Height	ordered height
Outside (OB) & Ceiling Mount	
Headrail Width	ordered width
Valance Width *	+ 1"
Fabric Width	ordered width
Shade Height	ordered height
2 on 1 (and 3 on 1) Headrail	
NOT AVAILABLE WITH TRILIGHT	N/A

Note: A backside valance is provided on both IB and OB mounts to hide the additional components under the headrail from outside view.

MOUNTING REQUIREMENTS

Use a metal tape measure for all measurements.

Inside (IB) Mount	Large, 2-1/2" Headrail
Minimum Mounting Depth	1-1/2"
Minimum Mounting Depth, Flush Mount **	3-1/4"
Outside (OB) Mount	Large, 2-1/2" Headrail
Minimum Flat Vertical Surface	1"

TriLight Stacking	
Shade Height	Stack Height
24"	7"
48"	9"
72"	11"
96"	13"
108"	15"

FINISHED DIMENSION & MOUNTING NOTES

Note: Ceiling mount shades are OB by default and have the same finished dimensions. IB shades may also be "TOP" mounted using the standard L-style brackets or using the optional Flat brackets.

** The flush mount depth requirements indicated above include space for the woven material attached to the front (valance) and back (shade) sides of the headrail. These are AVERAGE depths as the different woven wood materials have varying degrees of thickness. Verify your individual shade's depth before mounting, then position brackets accordingly for an EXACT flush mount.

* OB Valances and returns are attached using the Valance Return Stabilizer (VRS) System for woven wood only. The OB valance width additions indicated above create a "cornice style" box for improved appearance and operation.

TRILIGHT STACKING INFORMATION

TriLight Stacking Chart	
Shade Height	Stack Height
24"	7"
48"	9"
72"	11"
96"	13"
108"	15"

NOTE: These are stacking averages for standard shades.
Actual heights may vary + or - 1".

TRILIGHT – STANDARD RECTANGULAR

TRILIGHT

- Returns standard on outside mount
- Backside valance included on inside and outside mounts
- Front & back valances include liner when ordered on shade
- Built on 2 1/2" depth headrail
- Split controls only (grouped controls not available)

The following options are not available on trilight:

- Waterfall style, continuous cord loop, cordless, remotelift
- Twill edge-binding, faux silk binding, operable liners
- 2 or 3 on 1 headrail, cut-outs

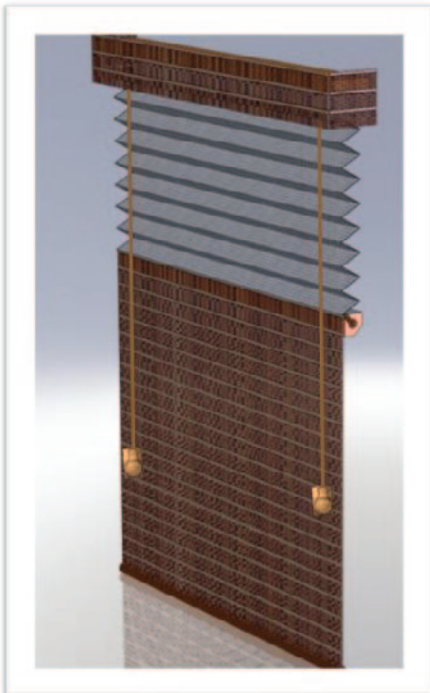

Folds Up

 Folds Down

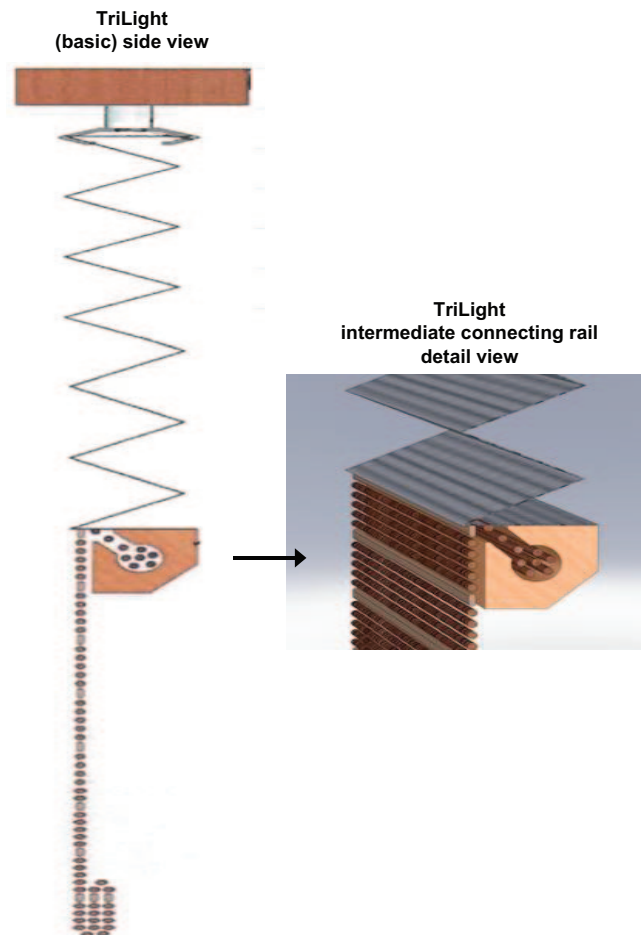

SMART FACTS



- Innovative design allows choice of woven shade fabric for the front shade to achieve just the right style and color desired.
- The back liner roller shade offers total flexibility when controlling light and privacy.
- The back liner also provides an extra layer of insulation to help reduce energy costs.
- Liners are available in light-filtering, blackout and screen styles to fit varying needs.
- Optional side seals eliminate light leaks from the sides of shades. They fit neatly inside the window frame and are hidden behind the front shade so they don't detract from the beauty of the shade.
- Optional side seals provide additional energy efficiency. Together with the back liner, they form a complete barrier between the window and the room — keeping rooms cooler in summer and warmer in winter.

SELECTING A TANDEM SHADE

1. Choose a woven style and color.
 2. Choose a liner (back roller shade) style and color. See Color Chart.
 3. Refer to the woven price grids on pages 7-15 to determine your woven shade price. Add in the Tandem option pricing found on the next page to determine the final shade price.
- Tandem woven is available as a single rectangular shade with standard controls only
 - Right cordlock operates the front shade; cord loop operates the back liner. Shades operate independently of each other.
 - Reverse controls available; no grouped controls
 - Side seals available as a surcharge option
Note: Available colors 973 Oyster and 661 White

COLOR CHART

OPACITY	MAX. WIDTH	COLOR #	COLOR NAME
Light Filtering	72"	R7201	White
Light Filtering	72"	R7202	Oyster
Blackout	72"	R4001	White
Blackout	72"	R4004	Black
Blackout	72"	R4006	Oyster
Blackout	72"	R4014	Golden Leather
Blackout	72"	R4016	Milk Chocolate
Blackout	72"	R4018	Mocha

Tandem not available in following Patterns			
SKU #	PATTERN NAME	SKU #	PATTERN NAME
GRW-2304	Caracas Tortoise	GRW-9460	Aruba Summer
GRW-2305	Coban Parchment	GRW-9461	Aruba Straw
GRW-2323	Luzon Whisper	GRW-9462	Aruba Sand Dune
GRW-2324	Luzon Cornsilk	GRW-9463	Aruba Driftwood
GRW-2325	Luzon Greige	GRW-9464	Aruba Café
GRW-2331	Nassau Pewter	GRW-9470	Martinique White Wash
GRW-9400	St. Kitts Dune	GRW-9471	Martinique Sea Grass
GRW-9401	St. Kitts Greywood	GRW-9472	Martinique Surf
GRW-9410	Coban Gray	GRW-9473	Martinique Coral
GRW-9440	Nassau Cocoa	SLW-2528	Cancun Off White
		SLW-2527	Cancun Light Gray

TANDEM OPTION PRICING

Find your shade width on the price grids below. Add the surcharge to the price of each shade(s). If ordering optional side seals, include the additional **\$49 surcharge** to the price of each shade(s).

Light Filtering and Blackout (Max. Width 72")

WIDTH TO:	24"	30"	36"	42"	48"	54"	60"	66"	72"
	\$102	119	139	156	171	186	201	225	250

Optional Side Seals: Add \$49

Available colors 973 Oyster and 661 White.

PRODUCT CONFIGURATION SPECIFICATIONS

SIZE STANDARDS	
Minimum Width	
All liners	12"
Maximum Width	
Light Filtering	72"
Blackout	72"
Minimum Height	
All liners	12"
Maximum Height	
Light Filtering	84"
Blackout	82"
MOUNTING REQUIREMENTS	
Inside Mount, IB	
Minimum Mounting Depth	1-5/8"
Mounting Depth, Flush	3" (includes valance; dependent upon fabric thickness)
Outside Mount, OB	
Minimum Mounting Height	2"

FINISHED DIMENSIONS	
Headrail Unit (including mounting rail)	
Inside Mount	Ordered width less 1/8"
Outside Mount	Ordered width
Finished Height	
Inside Mount	Ordered height
Outside Mount	Ordered height
Front Shade Fabric Width	
Inside Mount	Ordered width less 1"
Outside Mount	Ordered width less 7/8"
Valance Width	
Inside Mount	Ordered width less 1/8"
Outside Mount	Ordered width plus 1"
Back Shade Fabric Width	
Inside Mount	Ordered width less 1 3/8"
Outside Mount	Ordered width less 1 1/4"

Valance included on all shades. 6" drop only.

Outside mount valances come standard with returns and feature the Valance Return Stabilizer (VRS) system (Woven Wood patterns only).

Inside mount valances do not come with returns.

WOVEN WOOD STACKING CHART

Shade Height	Stack Height
21"	5"
42"	7"
63"	9"
84"	11"

Note: These are stacking averages for standard shades. Actual height may vary approximately + or -1". Stack height does not include the headrail size: 2 1/4".

LOOP SPECIFICATIONS

The cord loop operates the back liner.

Shade Height	Cord Loop Drop	Loop Color
Up to 38"	24" loop	Color Coordinated
38 1/8" to 50"	36" loop	Color Coordinated
50 1/8" to 62"	48" loop	Color Coordinated
62 1/8" to 84"	60" loop	Color Coordinated
Special Request	84" loop	Color Coordinated

SIMPLICITY RECHARGEABLE MOTORIZATION: OVERVIEW

Simplicity Rechargeable

- The Rechargeable Simplicity motor program features an integrated rechargeable lithium ion battery in the motor casing and is fully concealed by the inner tube.
- Rechargeable battery is included with the motor. The average battery charge will last 6-12 months based on an average sized shade raised and lowered once per day. The life of the battery charge will vary based on the type of window covering selected, the size and weight of the window covering and the number of times the shade is operated on a daily basis. The battery can be recharged up to 500 times. It takes approximately 5 hours to recharge the motor when fully depleted.

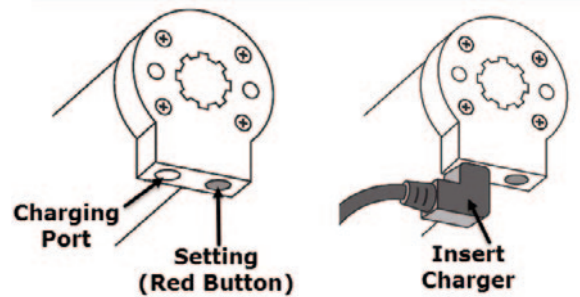

Battery Charger

- An 8.4 Volt charger requires a standard power outlet to recharge the battery. The charger must be specified when ordering Simplicity Rechargeable Motorized shade option. The charger plugs into the charging port of the motor. The charger is black and comes with a 156" wire. The dimensions are 1" wide x 2-1/2" length x 1-3/4" deep. Sold separately.



Solar Panel Recharge Option

- Plugs in to any Simplicity Rechargeable motorized shading. Provides constant trickle charge to 7.4v Li-ION Rechargeable battery packs. Does not require direct sunlight, but performs best in regular direct sunlight applications. Will prolong the life of the charge of the 7.4v rechargeable battery packs, and in some applications will maintain charge indefinitely.
- Life of charge is subject to application variables such as, size and weight of shade, frequency of use, amount of direct sunlight exposure, etc.



5 Channel Remote

- The remote can operate up to five shadings simultaneously, individually or in groups. Remotes and holders are available in white or black. The remote comes with a holder which can be mounted to a wall for easy storage. The range of the remote is approximately 80 feet.

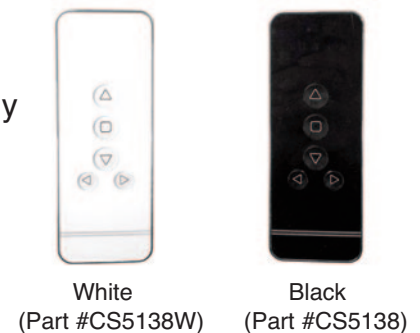

Please Note:

- Not all motors run at the same rate of speed.
- Simplicity motors have a "Favorites" position setting. To set a "Favorites" position, follow instructions provided in the installation instructions.

REMOTELIFT™ MOTORIZATION: OVERVIEW

With our RemoteLift™ motorized shades, tasks such as adjusting those hard-to-reach window coverings, controlling glare or protecting valuable furnishings from the sun are now simplified. At the touch of a button, window coverings can be instantly adjusted to changing activities or the varying sun conditions.



Glare can be annoying while trying to watch your favorite television show, surf the web or read the morning paper. An ideal solution is to manage glare with a RemoteLift™ hand-held remote control. At the simple touch of a button, shades and blinds will open or close to adjust to the changing sunlight in a room.



RemoteLift motorized shades provide ultra-quiet operation. The RF system enables shades to be operated from virtually anywhere in the house without direct line of sight. Similar to how a garage door opener operates, radio signals travel through walls and make it possible to control multiple coverings throughout the home alone or as a group. The RF system is available in both a 1-channel and a 5-channel version to allow for independent control of individual shades and/or group control.

The RemoteLift motorization system provides many benefits, such as improving energy efficiency, providing easily controllable privacy and also enhancing home security.

Many homeowners too often experience the damaging effects of the sun's UV rays on floor coverings, furniture, wall coverings and artwork. Programming shades to raise or lower at certain times of the day helps to manage heat gain in summer months and heat loss during winter - reducing monthly energy bills.



The RemoteLift RF timer allows users to program specific times of the day to automatically adjust shades in different areas of the house, protecting interiors from the fading effects of direct sunlight. This feature provides added security to an unoccupied home by creating a lived in look even while homeowners are away on vacation.



The battery powered RemoteLift RF wireless wall switch allows shades to be controlled when entering or exiting a room, just like the lights. The switch may be seamlessly installed without wiring next to any light switch or stand alone, and is never misplaced. This one touch privacy helps create the ideal environment whether preparing for a bath, relaxing in bed or enjoying time with the family at home.

Our RemoteLift motorized shades are powered by Somfy, the industry leader in automated window coverings. All motorized products are backed by a 5-year warranty.



REMOTELIFT™ MOTORIZATION: FEATURES & OPTIONS













RADIO FREQUENCY (RF) MOTORIZATION FEATURES:

- Highest quality patent protected design by Somfy
- Advanced motor, capable of lifting shadings up to 12 LBS.
- Quiet operation
- Installs with standard installation hardware
- RF motor is programmable

Note: The power source must be selected when ordering. The options are: reloadable single battery wand, reloadable dual wand, and the plug-in transformer.



 <p>Radio Frequency (RF) Remote Lift Motor Motor (Part #1240292) Crown (Part #9018475) Drive (Part #9018477)</p>	<ul style="list-style-type: none"> • Fully concealed motor unit • Flexible and programmable operation • 12 Volt System
 <p>Radio Frequency (RF) Remote Control (must order separately) Color: 2 tone white and gray 2 Types: programmable 1-channel and programmable 5-channel (1-Channel: Part #RC445069) (5-Channel: Part #RC445079)</p>	<ul style="list-style-type: none"> • Controls shade operation • Programmable features • Easy shade positioning up to 90 feet away • 5-channel remote allows for multiple and independent shade operation
 <p>Single Battery Wand (reloadable) and Installation Clips Wand (Part #RC445268) Clips (Part #9013263) 8 AA Lithium Batteries (not shown) (Part #9014834)</p>	<ul style="list-style-type: none"> • On initial shade orders, the reloadable wand comes with 8 AA lithium batteries • Comes with mounting installation clips • For parts ordering the reloadable wand INCLUDING 8 AA lithium batteries, order both part #s • Replacement 8 AA lithium batteries may also be ordered separately
 <p>Optional, Dual Battery Wand (reloadable) and Installation Clips (Kit: Part #KITRDWR) (Clips: Part #9013263) (Y-Harness: Part #9015580) (Y-Harness Ext. Cable: Part #9016736)</p>	<ul style="list-style-type: none"> • On initial shade orders, the reloadable wands come with 16 AA lithium batteries • Combines (reloadable) Single Battery Wands for added lifting capacity and/or extended life • Comes with mounting installation clips
 <p>Transformer (Part #1822445)</p>	<ul style="list-style-type: none"> • Plug-in operation, no batteries required • Works in standard wall outlet (includes 10' long wire)
 <p>Battery Wand Extension Cables Color: White (10" Cable: Part #9018686A) (48" Cable: Part #9016736) (96" Cable: Part #9018624)</p>	<ul style="list-style-type: none"> • Available in 10", 48" and 96" • Allows battery wand installation away from headrail
 <p>Wireless Wall Switch Color: white 2 Types: programmable 1-channel and 5-channel (1 Channel: Part #RC445135) (5 Channel: Part #RC445136)</p>	<ul style="list-style-type: none"> • Control wireless operation from the wall up to 90 feet away • Works like turning a light on/off
 <p>Programmable Timer 1 Type: programmable 1-channel (Part #1805237A)</p>	<ul style="list-style-type: none"> • Program operation based on pre-set times • Excellent home security feature
 <p>Smoove 1 RTS – single channel surface mount control Color: Pure (Part #1811533)</p>	<ul style="list-style-type: none"> • Battery operated • Tactile buttons for UP/DOWN/MY/STOP control • LED for visual feedback
 <p>myLink Interface Color: White (Part #1811403)</p>	<ul style="list-style-type: none"> • Smartphone and Tablet Interface 120V AC • App Control • Remote Access • Compatible and controls all Radio Technology Somfy RTS products. • Can control up to 5 channels of RTS motorized products using myLink apps for iOS and android devices.

PRODUCT COMPONENTS: WOVEN SHADES

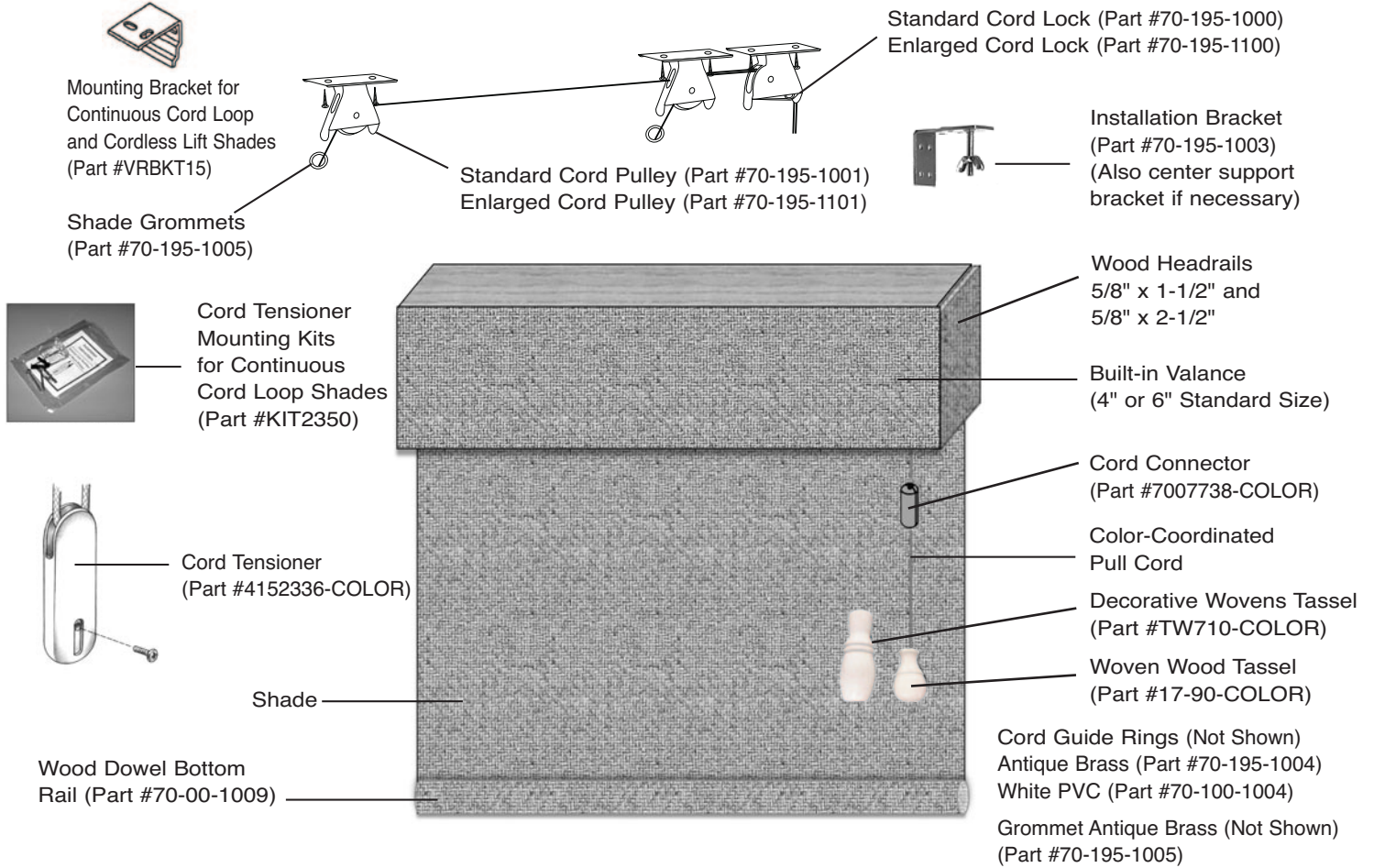

OPTIONAL BRACKETS AND COMPONENTS

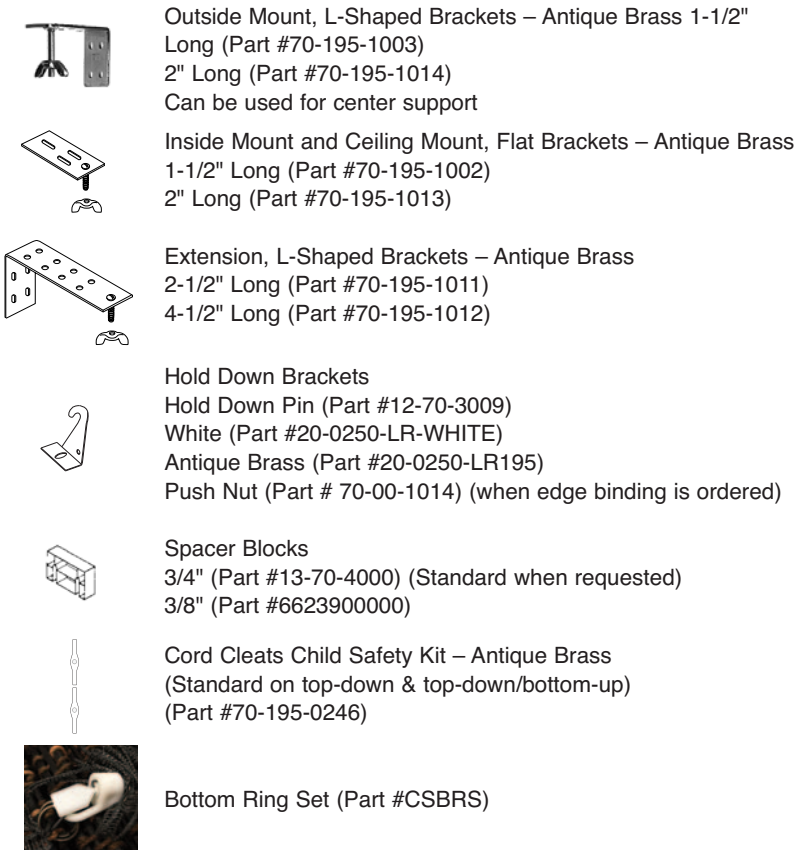

WOVEN SHADES CORDLESS TOUCHLIFT SYSTEM

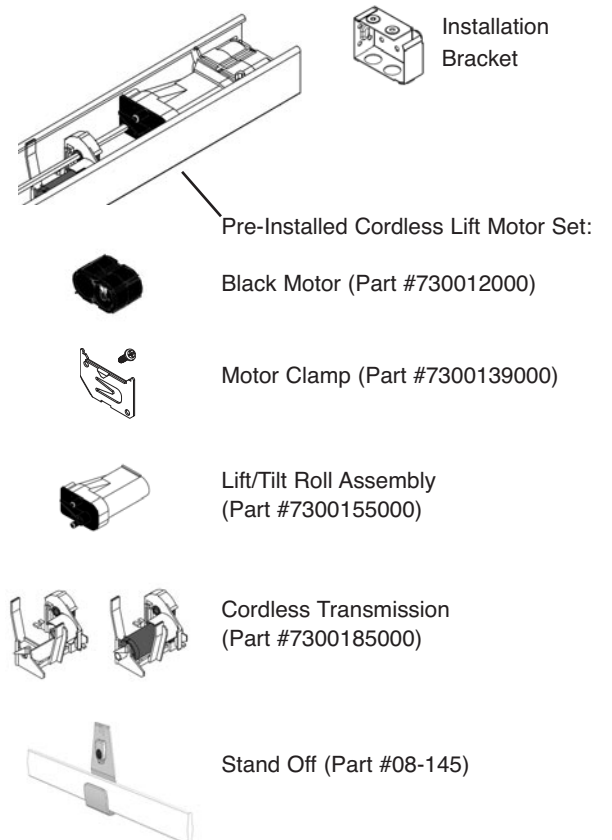

PRODUCT COMPONENTS: CORDLESS BREEZE™

Installation Brackets

1-1/2" Small head rail:

- 2 per PK (Part #KIT-WW-003) IB
- 2 per PK (Part #KIT-WW-005) OB
- 3 per PK (Part #KIT-WW-004) IB
- 3 per PK (Part #KIT-WW-006) OB

2-1/2" Large head rail:

- 2 per PK (Part #KIT-WW-007) IB
- 2 per PK (Part #KIT-WW-011) OB
- 3 per PK (Part #KIT-WW-008) IB
- 3 per PK (Part #KIT-WW-012) OB

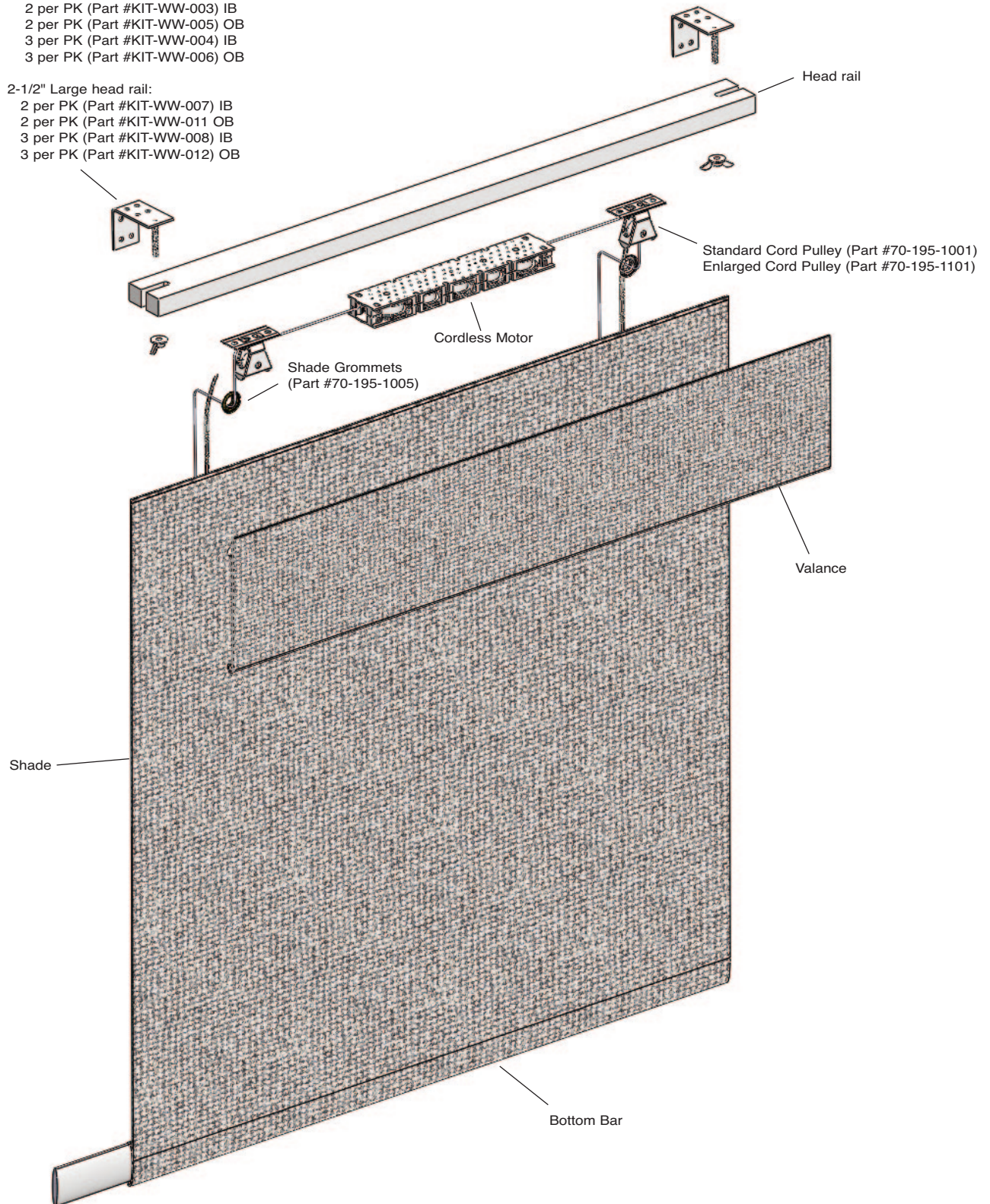

PRODUCT COMPONENTS: CONTINUOUS CORD LOOP WOVEN SHADES

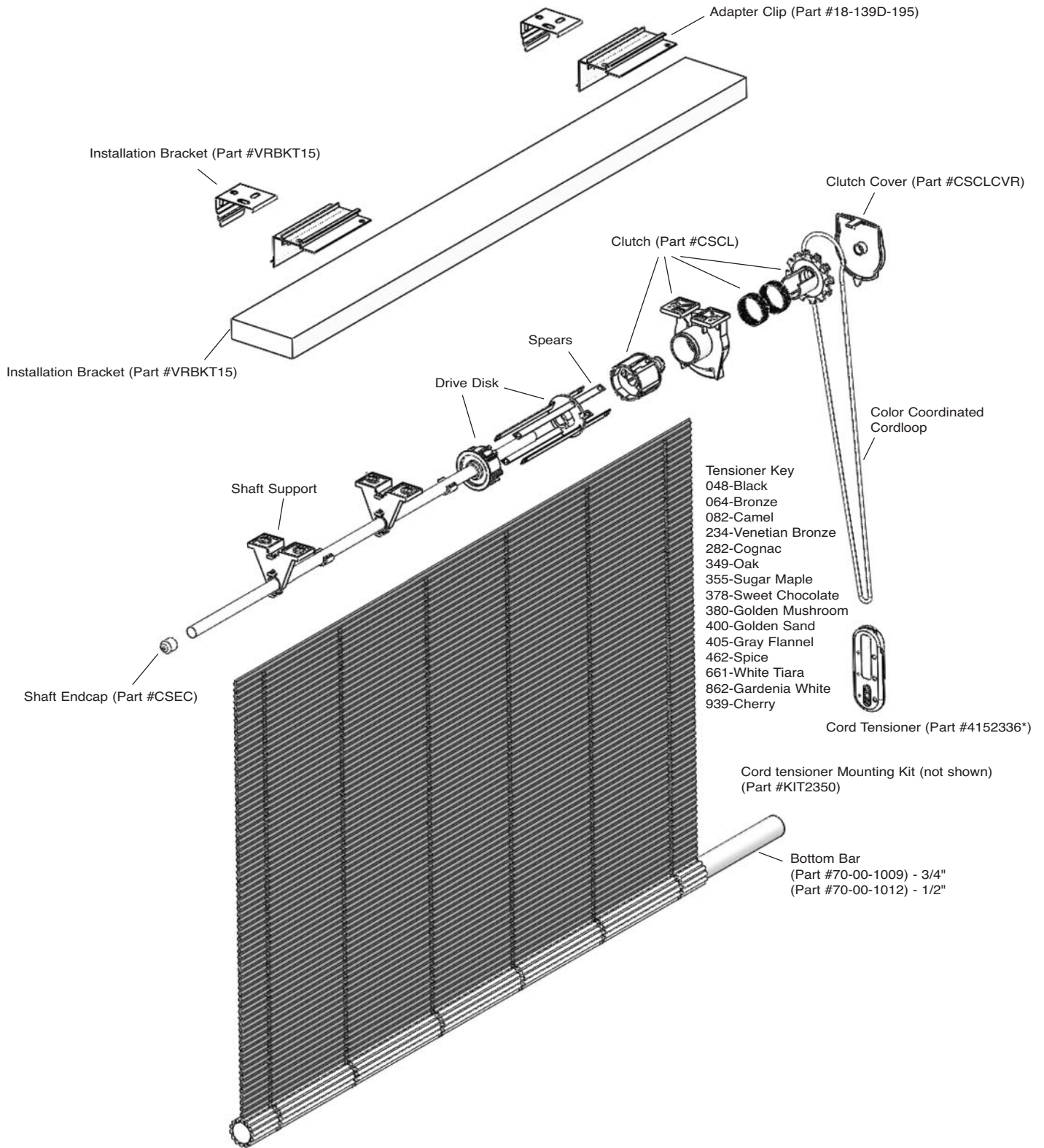

PRODUCT COMPONENTS: TANDEM™ SHADES

OPTIONAL (Standard when side seals are ordered)

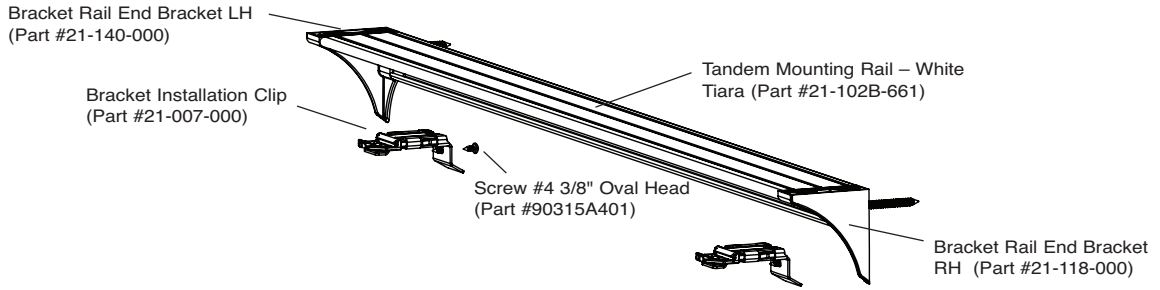

STANDARD

