

DAISY RUTH IGEL Rio de Janeiro 1927 – 2019 Rio de Janeiro



Daisy at work and play



John van der Meulen, Daisy Igel, Konrad Wachsmann
Photograph by Kay Harris

Lincoln Park Project, 1949-50

Mixed Residential Development for 1,000 Persons

Bounded by Belmont Avenue, Sheridan Road, Diversey Avenue and Lincoln Park to the East

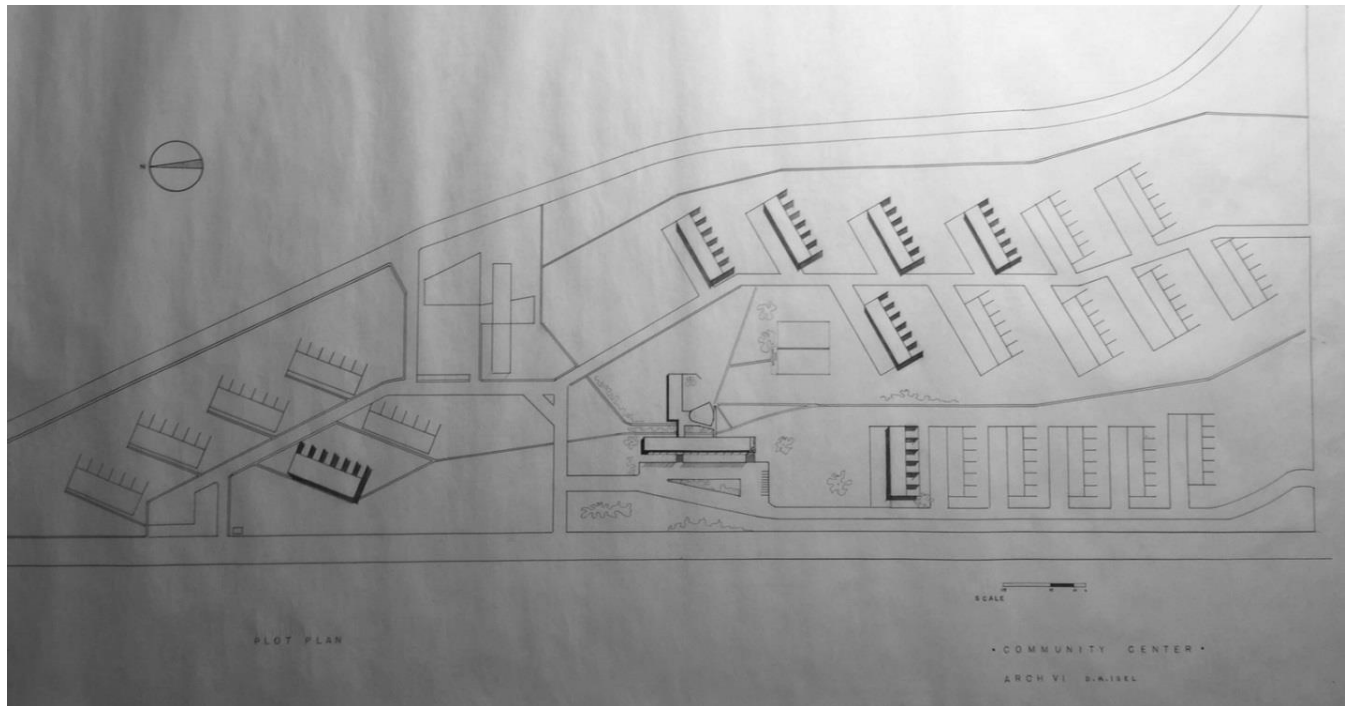

Site Plan

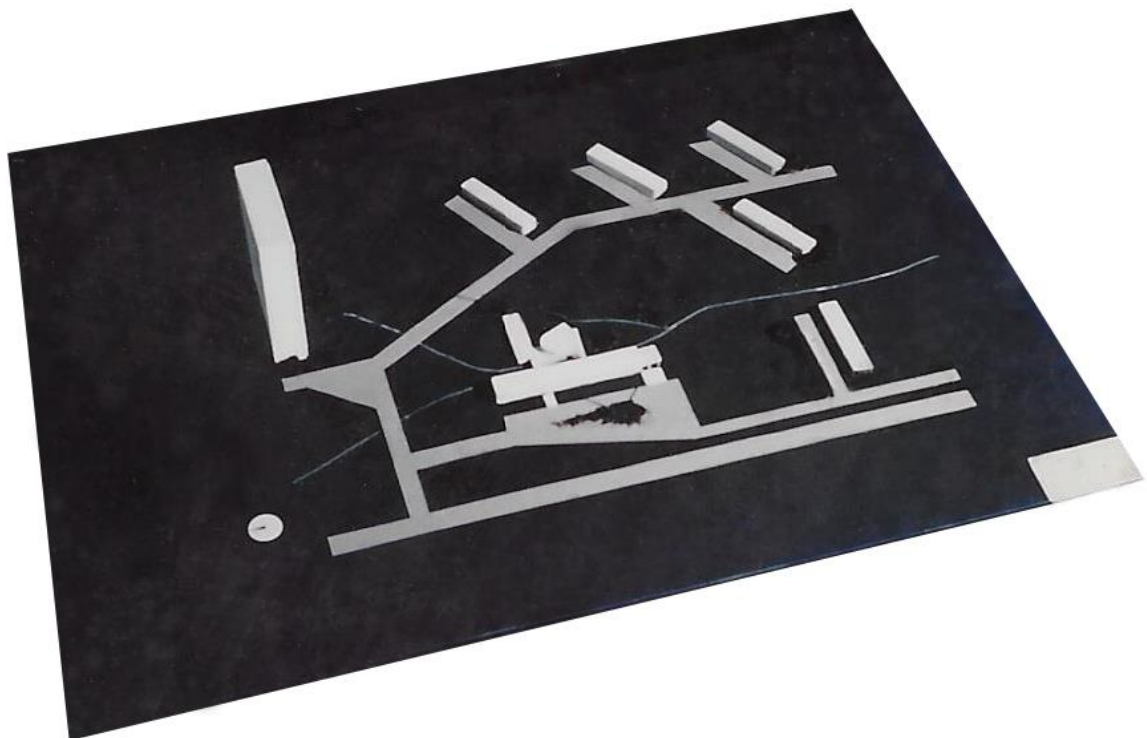

Study Model

Community Center, Lincoln Park Project, 1949

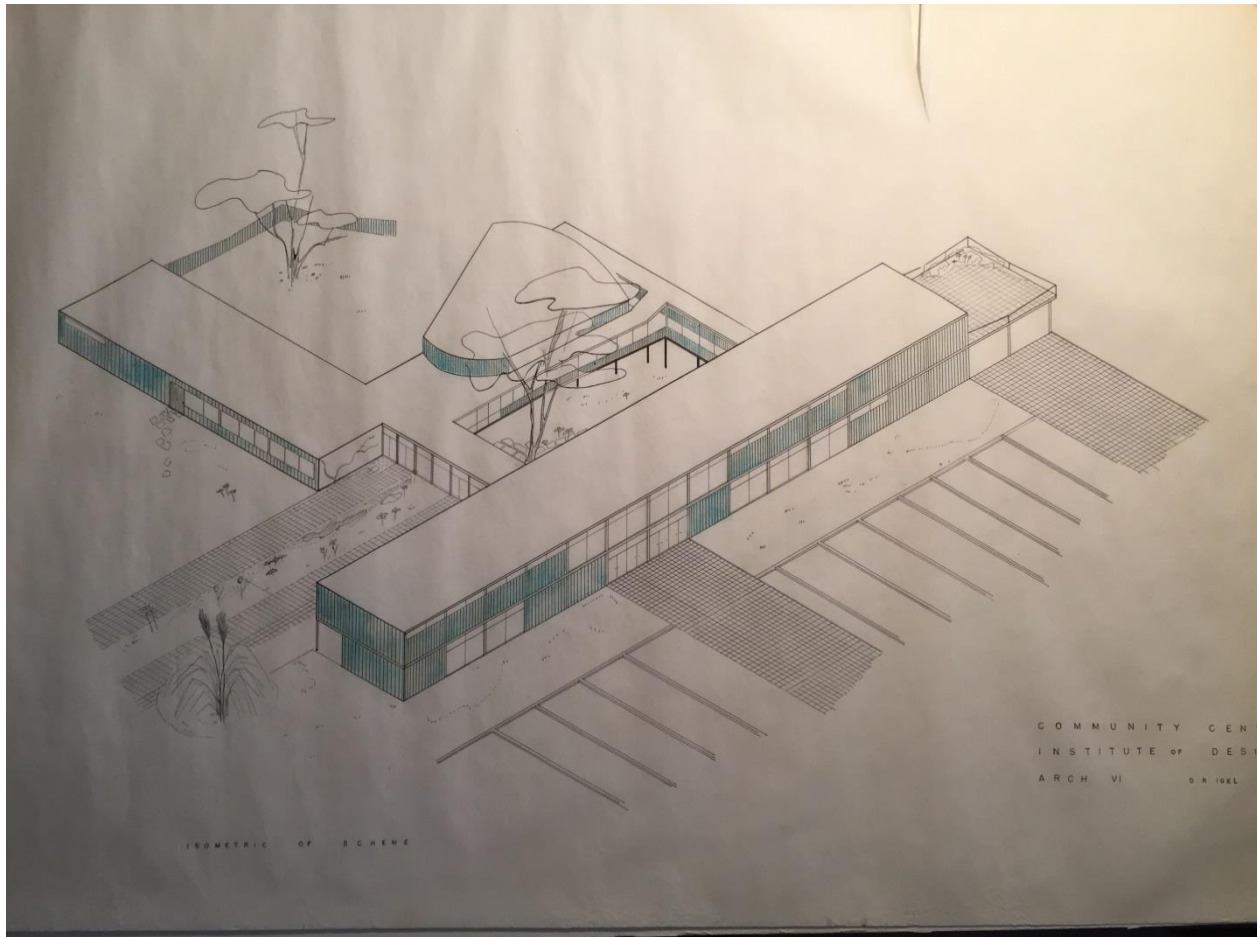

Community Center, Lincoln Park Project, 1949
Ground Floor Auditorium, Grocery and Drug Stores Craft Space, Nursery
Second Floor Administration, Lounge, Library, Restaurant and Bar

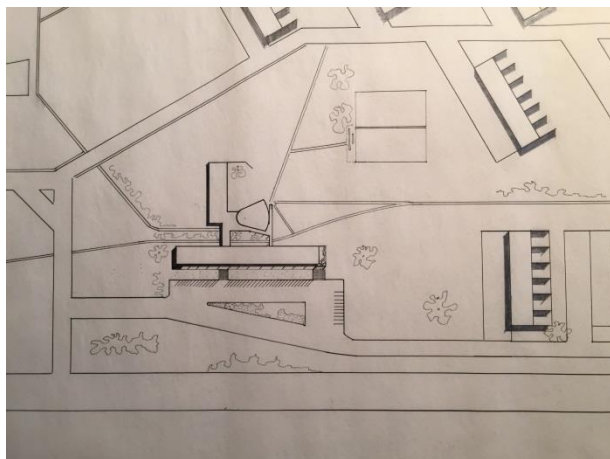

Partial Site Plan, Lincoln Park Project
Community Center and Row Housing

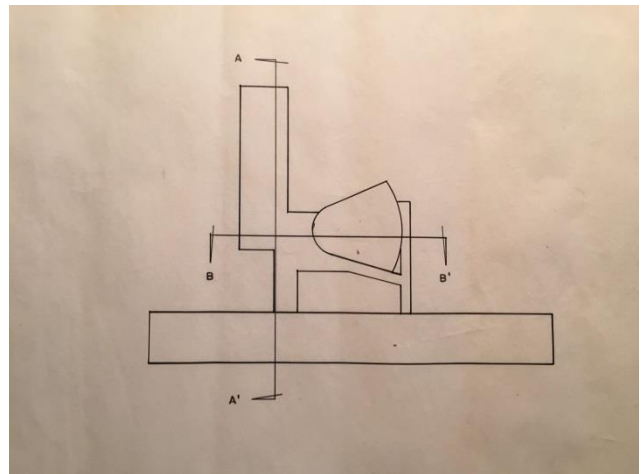

The Community Center

Aircraft Hangar, Group Student Project, Class of Konrad Wachsmann

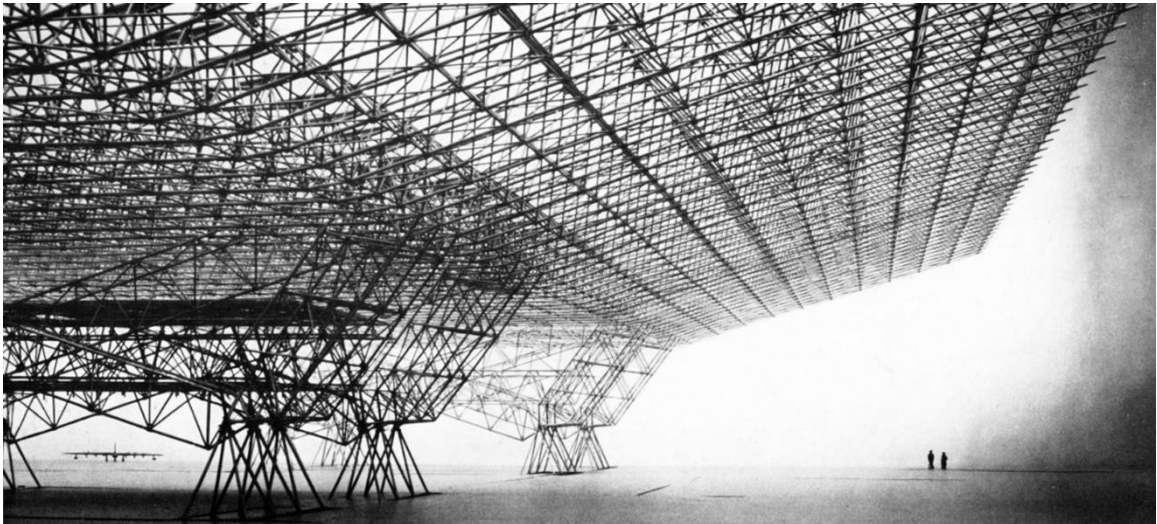

Building Research Project, 1951-53

Invention of a building element industrially produced in a not yet chosen material that would help to **guide forces** throughout a multistory structure, considering a possible new principle of distribution.

This research study was done in Konrad Wachsmann's 8th semester class, working with his ideas, guidance and supervision.

Student Study Team: Daisy Igel and Robert C. Burris

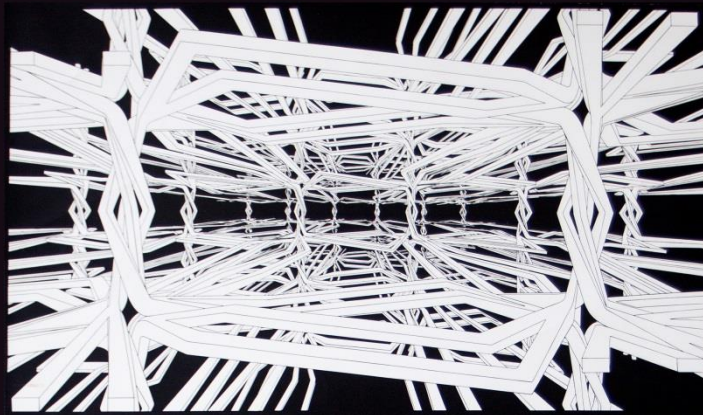

A theoretical study of relationships between space and structure, conducted at the Institute of Design of Illinois Institute of Technology, 1953, led to the development of a singular three-legged wishbonelike structural member. With its assumed modular and geometrical order the member demonstrated a new principle by which each structural element has a tendency to move away from other members of each grouping by increasing load. They therefore had to be joined by short tension members, cables which basically transform a compression structure into a tension structure.

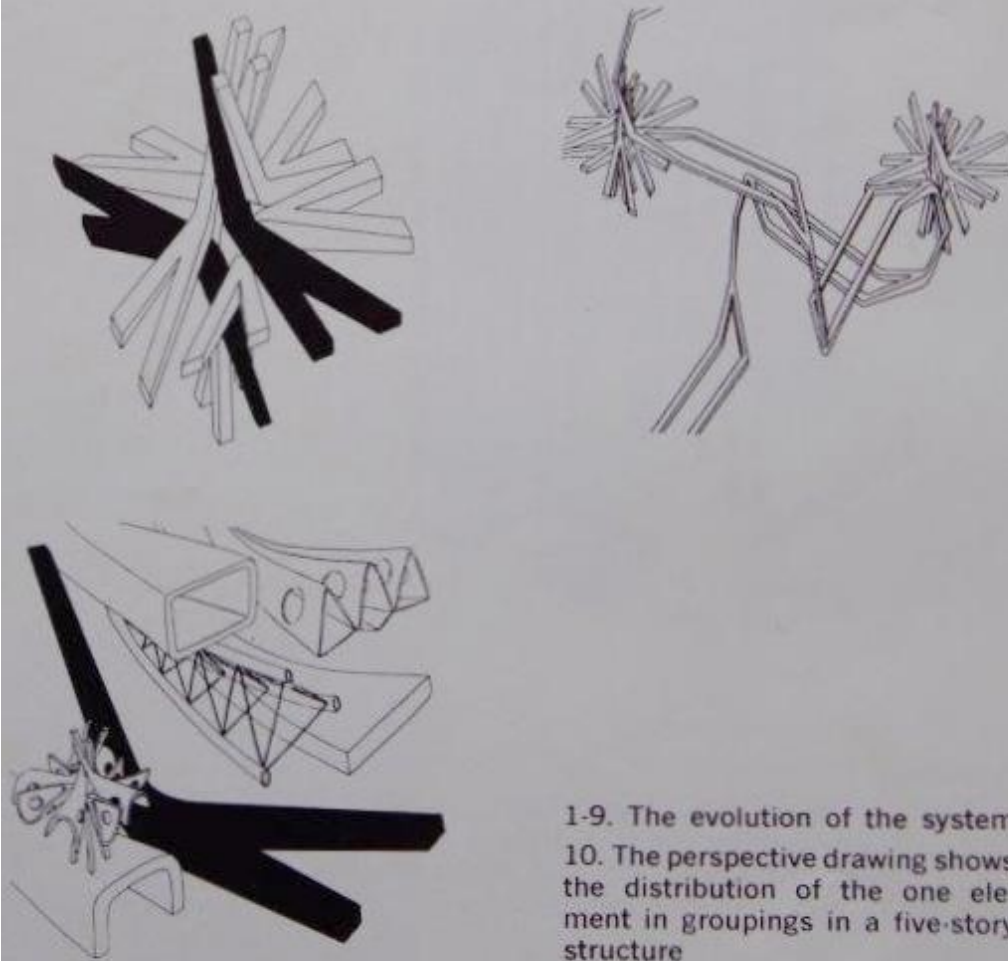

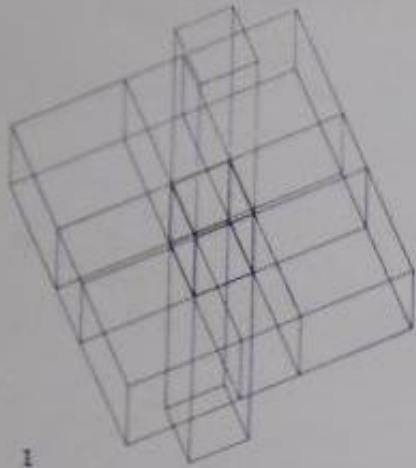

1

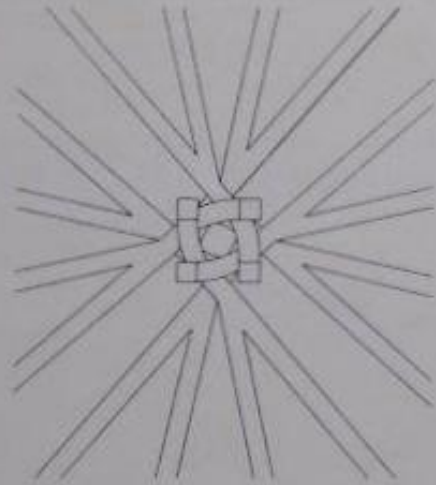
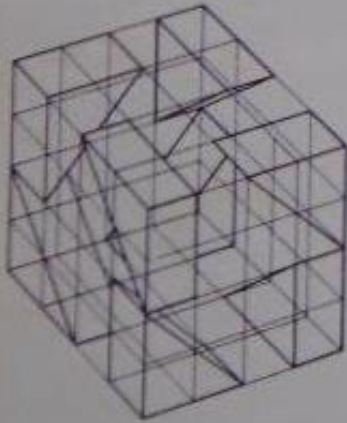
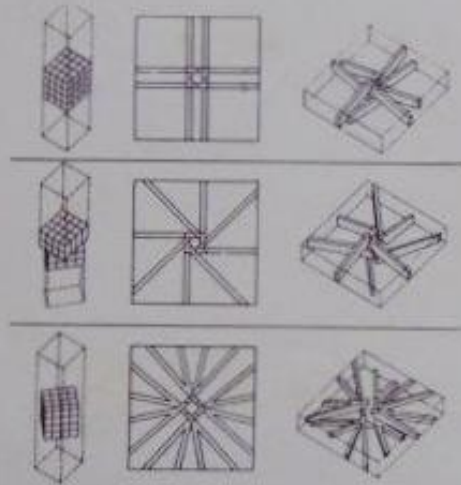
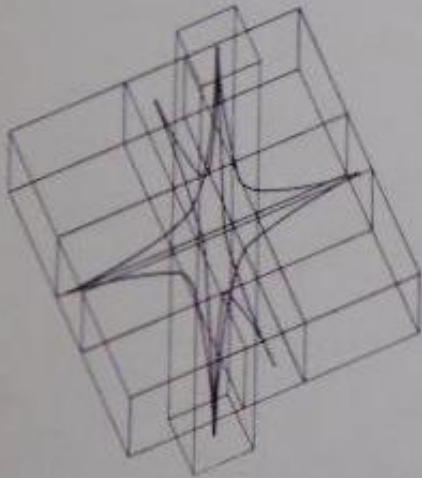
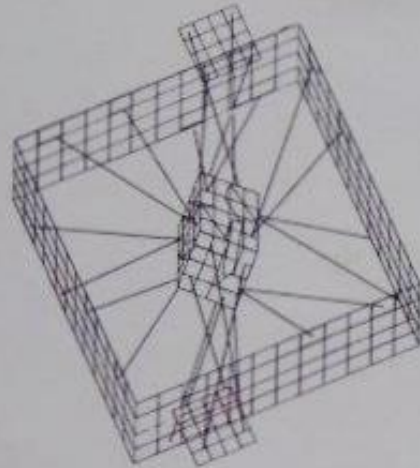

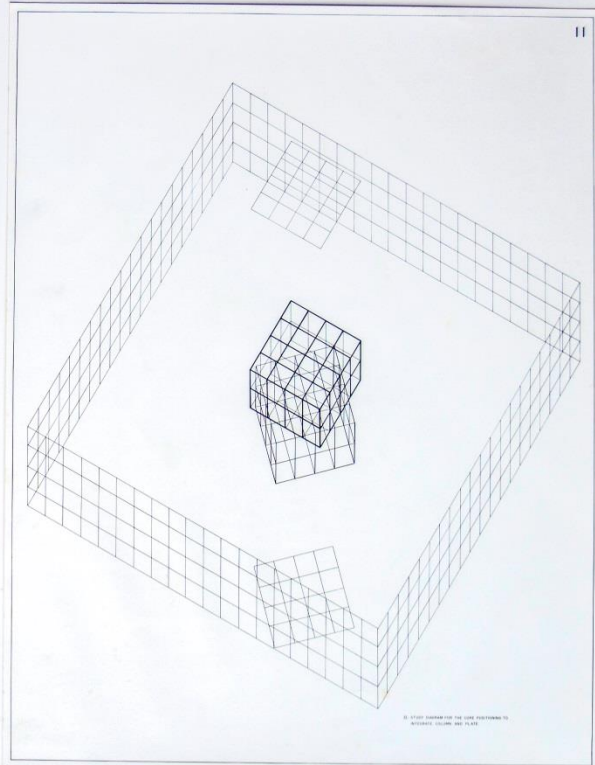
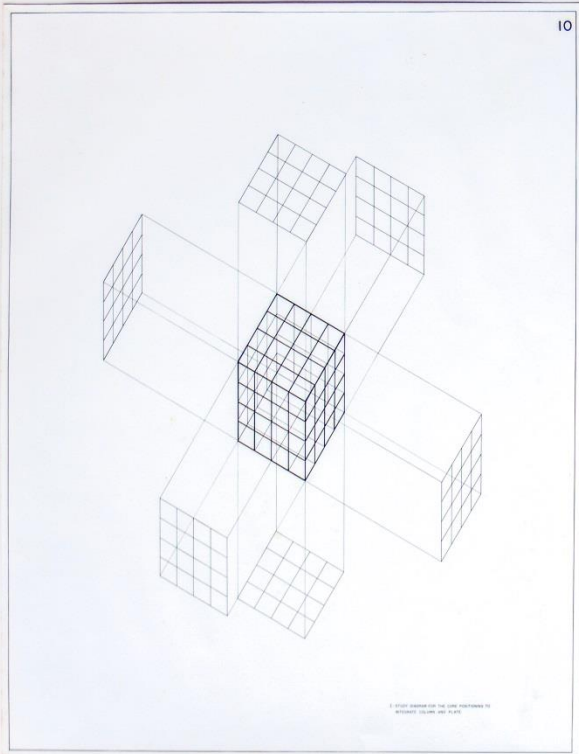

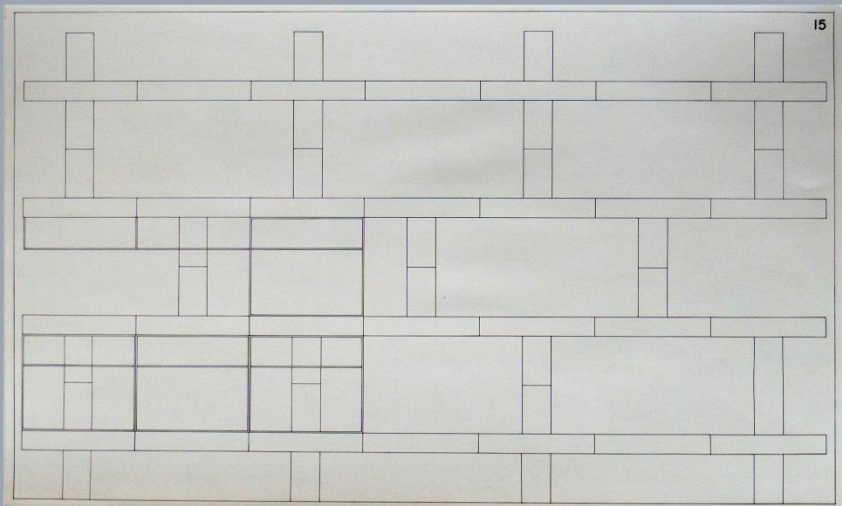
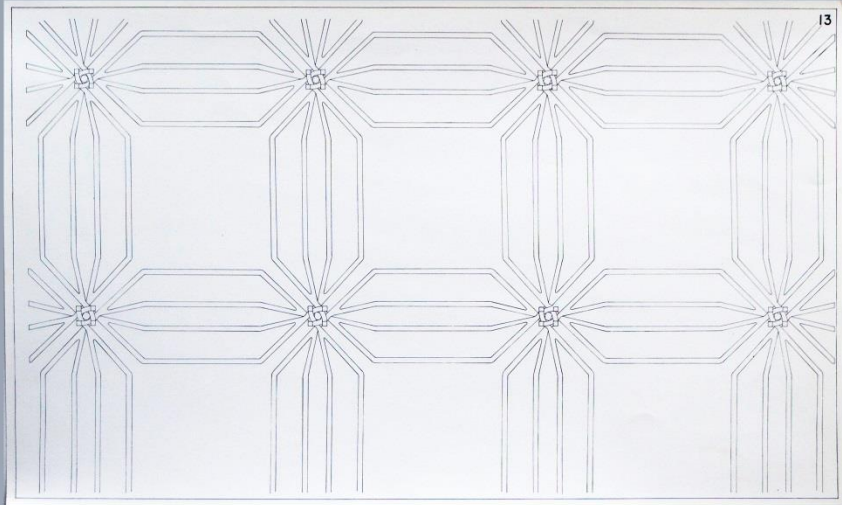

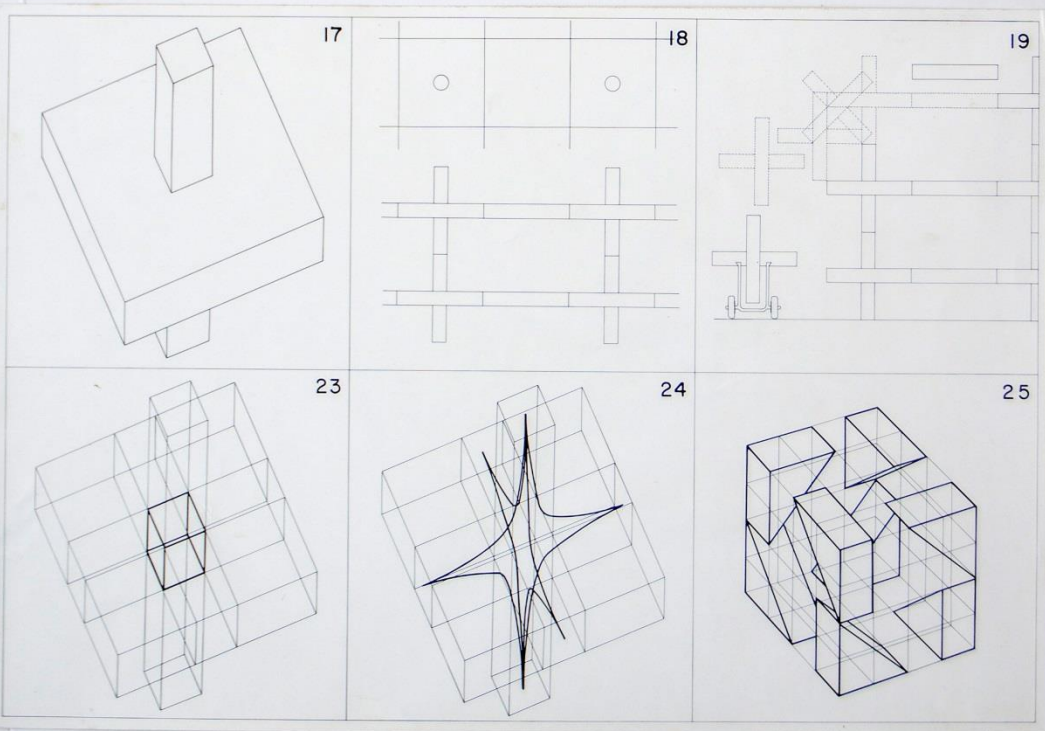
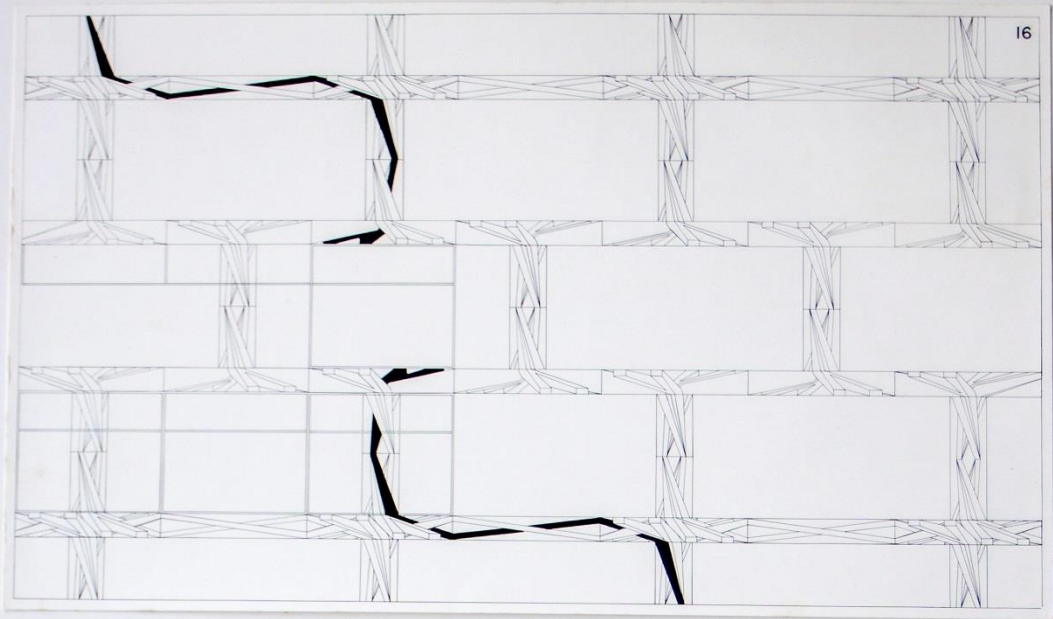

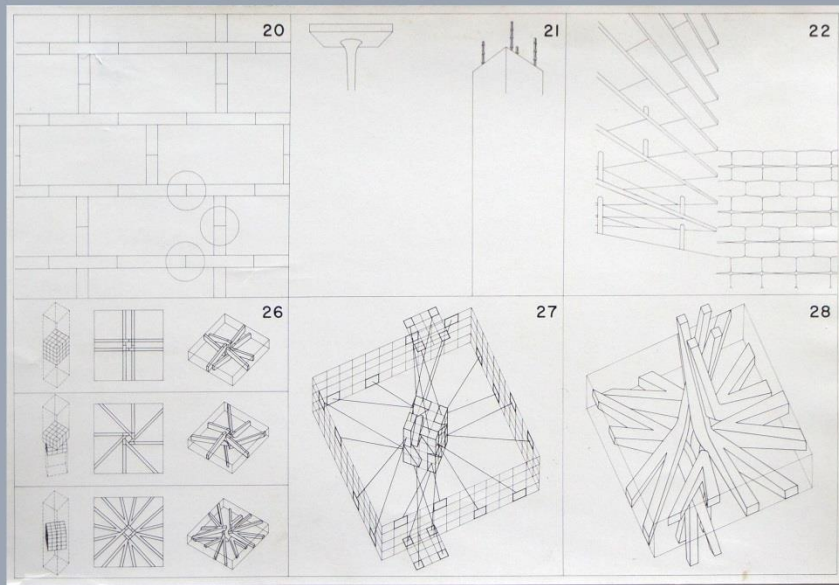

Konrad Wachsmann and company; note the above project drawing on the wall

Tensegrity Studies by Kenneth Snelson

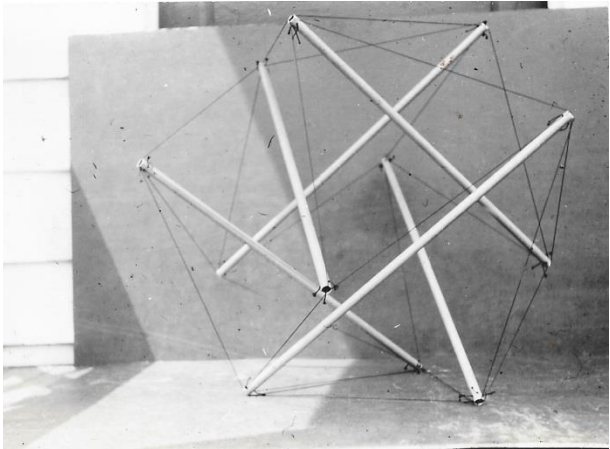
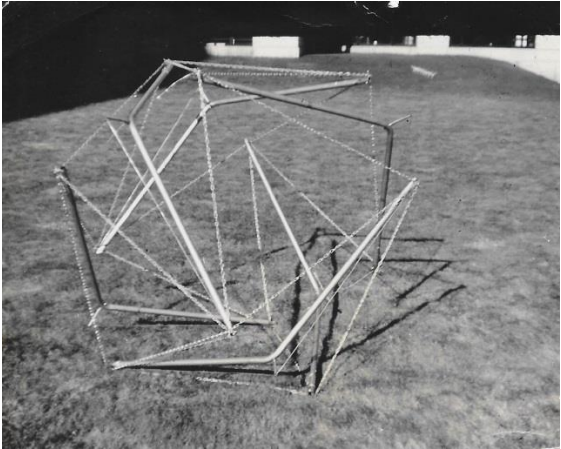
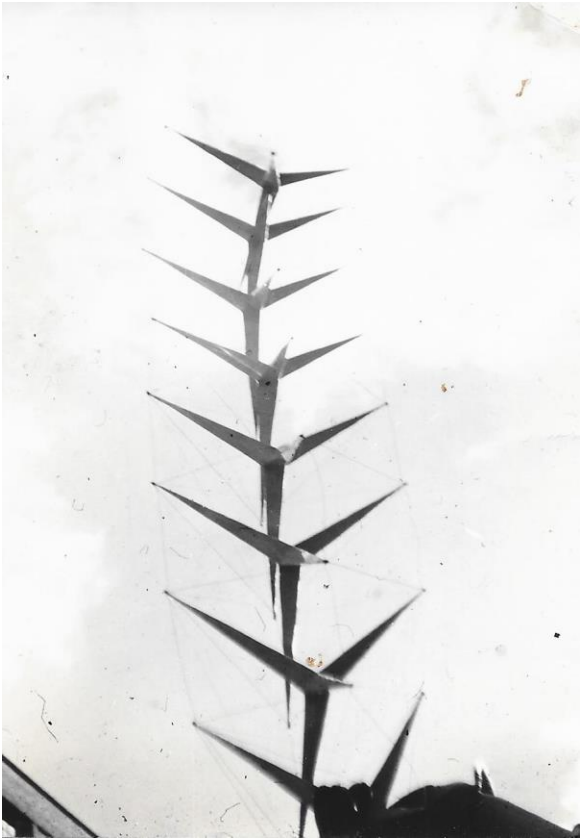

Daisy Igel Design for a Hand Brace, c1948

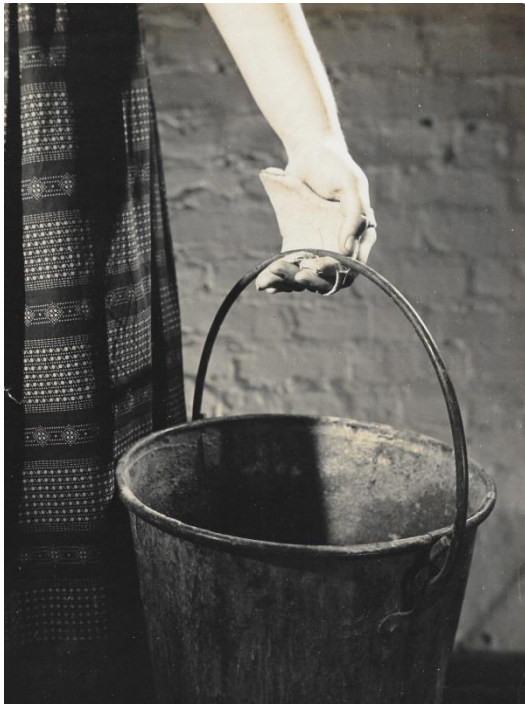

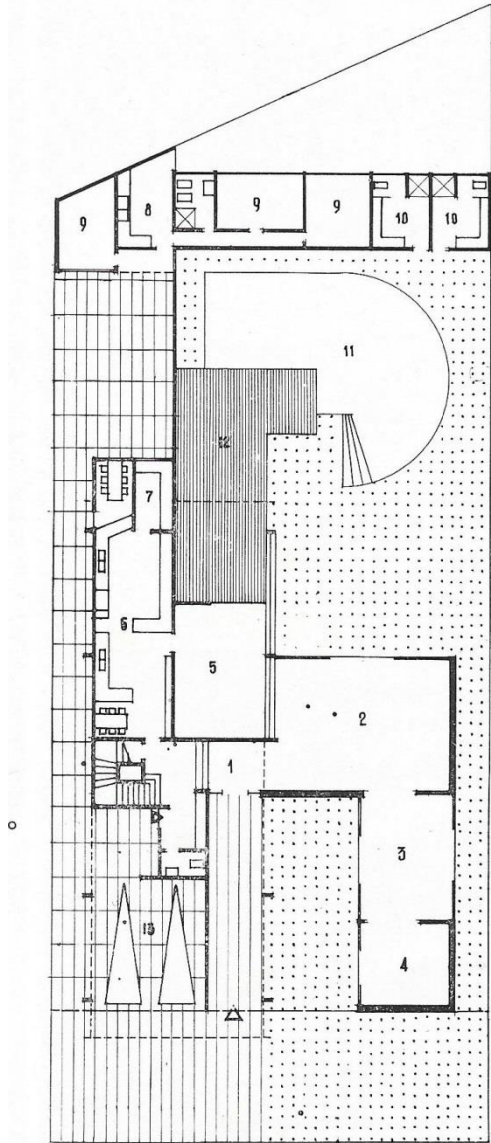

Pavimento térreo

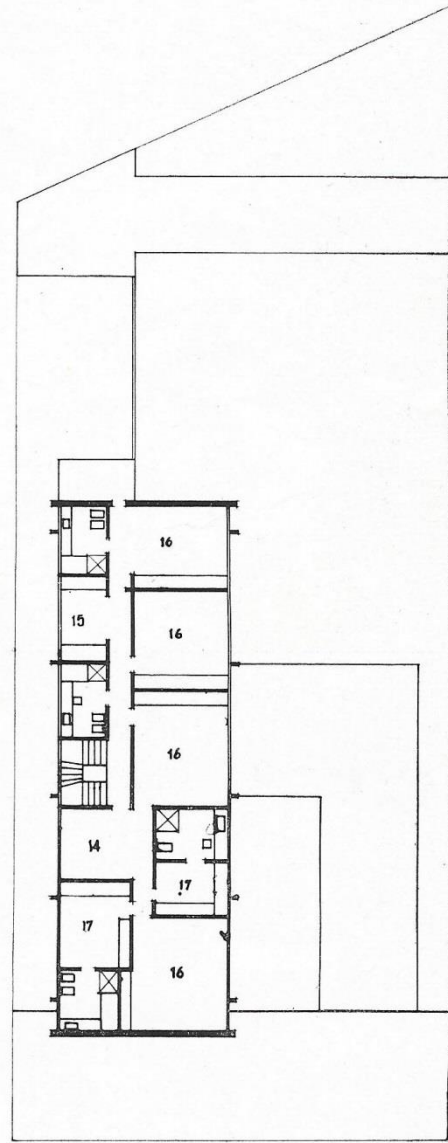

Pavimento superior

Dr. Pedro Franco Piva Residence, São Paulo, Brazil, 1959-60
 Architect Daisy Igel, Associated Architects Jon Maitrejean and Helmut Hein

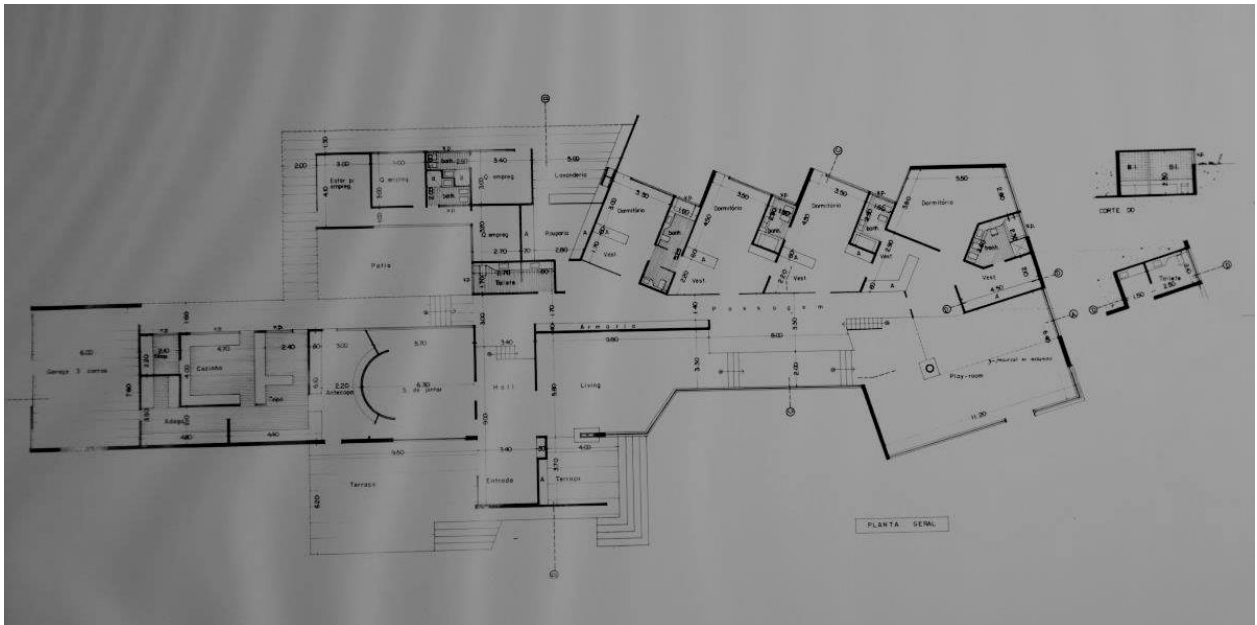
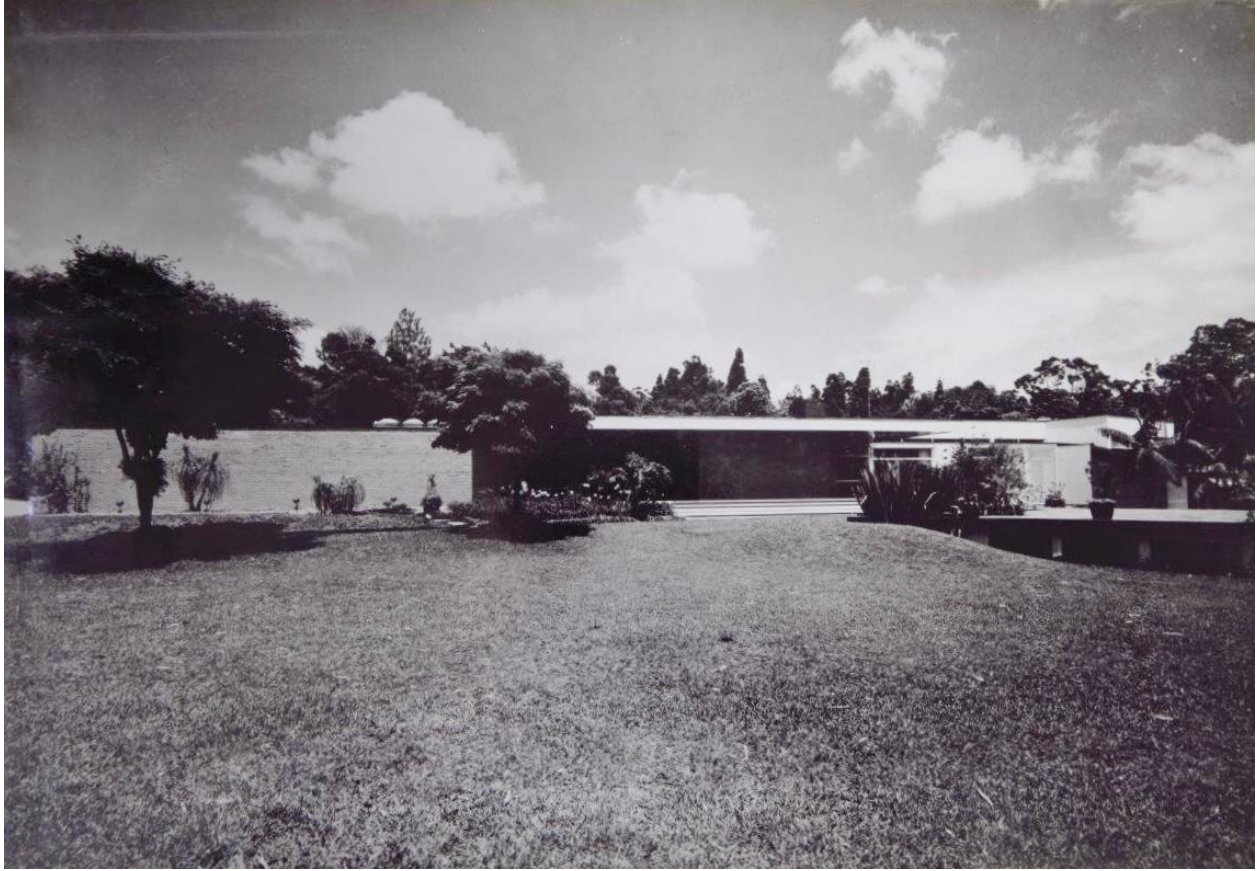

House for the Architect, Rio de Janeiro, Brazil 1960

**Student Work, Foundation Courses taught by Daisy Igel,
School of Industrial Design, Rio de Janeiro, Brazil**

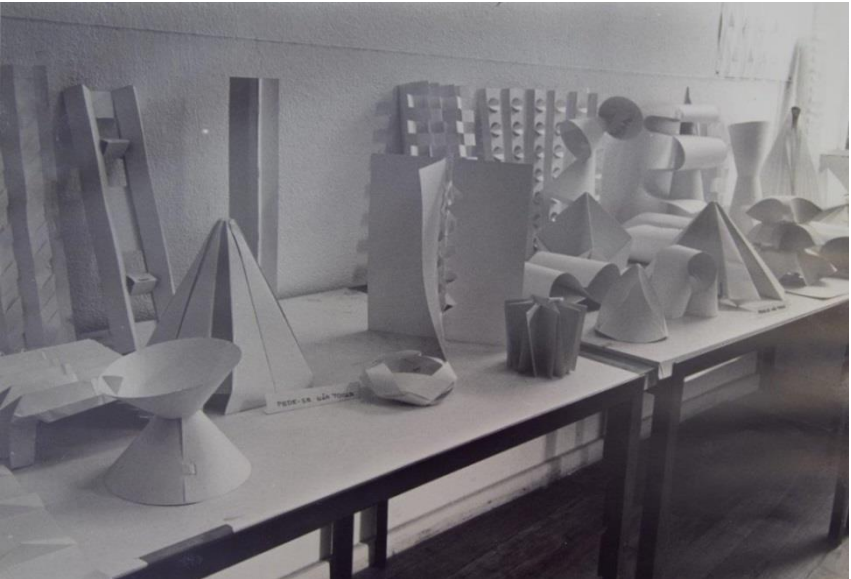
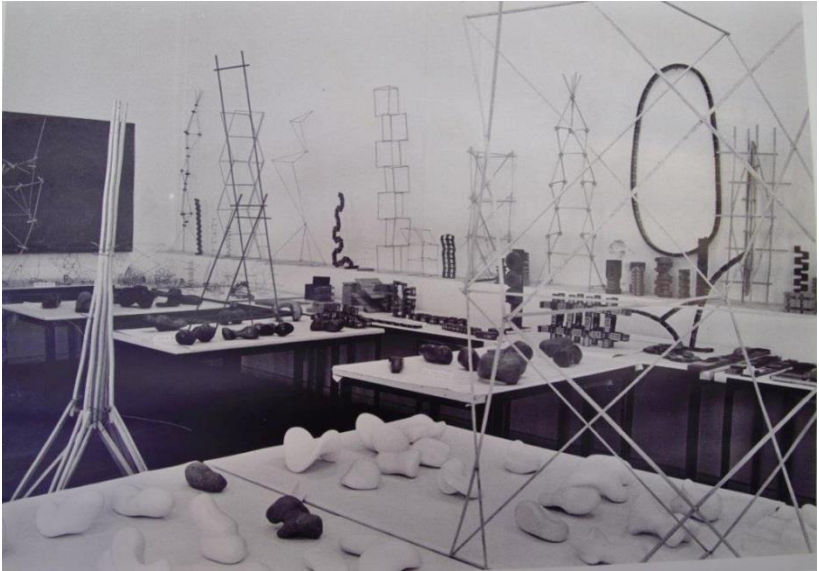
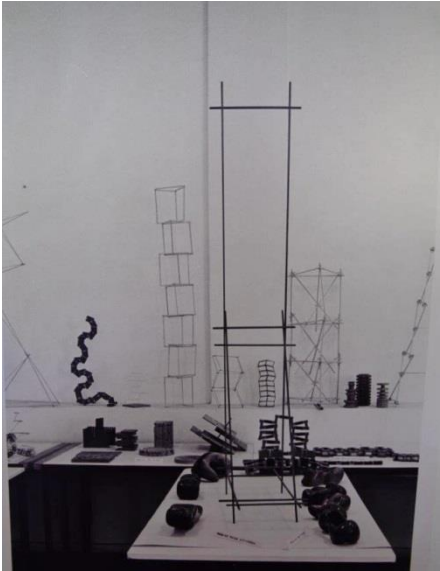

The following drawings represent instructions for Daisy's students to make the folded paper structures:

