

Turbo air
AIR CONDITIONER MANUFACTURER

4184 E. Conant St.
Long Beach, CA 90808
Tel. 888-900-1002
Fax. 310-900-1088
www.turboairinc.net

Project :

Model # :

Item # :

Qty :

Approval :

Top Mount Package Units (SMART 7)

Model : STX055LR404A3

SMART 7



≡ FEATURES / BENEFITS ≡

SM 1: Blue Anti-corrosion-fin and Coated Copper Tube protects aluminum and copper pipes from toxic gases generated from foods, retards refrigerant leakage, and prolongs the cooling capacity.

SM 2: Expansion Valve allows safe storage of foods with a feature that self-adjusts the circulation of refrigerant as the internal temperature changes, thus recovering the required temperature fast.

SM 3: Compressor Protected Solenoid Valve decreases the inflow of refrigerant into the compressor when it is restarted after a stop. This extends compressor life and reduces compressor failure.

SM 4: 18% Bigger Condenser than the Standard : The condenser's efficiency affects most of the refrigerator's performance. Particularly, when used in a small compartment under high ambient temperatures or a dusty area, the package unit's condenser needs to be bigger than standard ones in order to get the best performance. In consideration of the environments that our products may be subject to, condensers utilized in our products are 18% larger than competitors'.

SM 5: Energy Efficient EC Motor : Through the use of a highly efficient EC motors, our products reduce energy consumption and lower electricity costs, thus protecting the environment. Our products are designed with easy to replace motor and fan blades.

SM 6: Leak Free Patented Hot Gas Condensate System : The hot gas condensate system is an ideal system because of its fast evaporation of condensed water and its enhancing refrigeration efficiency. In spite of these advantages, many companies have stopped or stop the application of such a system because of its high risk of discarding the refrigerators due to the rapid corrosion of hot gas lines causing refrigerant leakage and water inflow into the cooling pipes. Such problems as this are completely resolved in our products, thanks to a patented technology that prevents pipes from corrosion.

SM 7: Highly Efficient Air Circulation Enclosure is designed to release hot air to the outside faster than competitors' and to enhance the cooling efficiency. At the same time, it retards elevation of compressor temperature and keeps refrigerant pressure from increasing, thus saving energy as a result.

Top Mount Package Units (SMART 7)

Model : STX055LR404A3

MODEL NOMENCLATURE

S	T	I	050	M	R404A	2
Model	Location	Capacity	Temp.	Refrigerant		
Turbo air	I = Indoor	BTUH	M = Medium	R404A	1 = 115V	
Top Mount	O = Outdoor	x 100	Temp.		1PH 60Hz	
Package Unit			L = Low		2 = 208-230V	
			Temp.		1PH 60Hz	
					3 = 208-230V	
					3PH 60Hz	

Performance Data - Low Temperature Models, Electric Defrost

Model	Capacity BTU/HR (Ambient Temp)														
	80°F			90°F			95°F			100°F			110°F		
	Room Temperature °F.														
	0°F	-10°F	-20°F	0°F	-10°F	-20°F	0°F	-10°F	-20°F	0°F	-10°F	-20°F	0°F	-10°F	-20°F
STX055LR404A3	8584	6707	4883	7789	6051	4179	7395	5406	4002	6478	5105	3696	5449	4215	3041

Unit Specifications - Indoor Type Low Temperature Models

Model Number	Power Supply			MCA	MOPD	Unit Amps	Evaporator CFM	Plug Supplied	Matching NEMA Receptacle	Dim. Fig.	Net Weight Lbs (kg)
	Voltage	PH	Hz								
STX055LR404A3	208-230	3	60	13.3	20	11	890	No	-	C	308 (140) / 317 (144)

Design and specifications subject to change without notice

■ **WARRANTY : 2 Year Compressor and Parts Warranty & 1 Year Labor Warranty**

PLAN VIEW

(unit : inch)

Figure C. OUTDOOR UNIT – Large Cabinet (Opening Size : 25 inch x 38.5 inch)

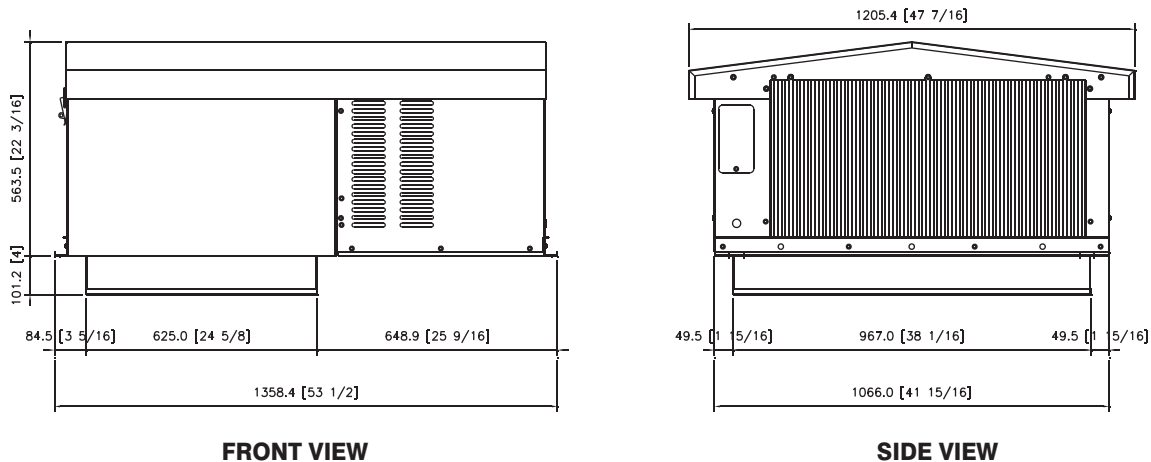

■ Toll Free : 888-900-1002

