

# Ingersoll Rand

Rotary Screw Air Compressors  
5-15 hp (4-11 kW)



*Innovation*

*Reliability*

*Efficiency*

## A New Standard of Performance

Welcome to Ingersoll Rand's rotary air solutions, a new standard of performance.

**Achieve highest productivity** and lowest total cost-of-ownership.

### Boost Your Profitability

Boosting your company's profits was the main goal that Ingersoll Rand had in mind when designing our revolutionary line of integrated rotary screw air solutions.

So how can a compressed air system help you increase profitability? The answer is really pretty simple: by ensuring that you achieve the highest productivity in your shop while reducing the total costs of ownership to the absolute lowest levels.

Our rotary screw compressors are more than integrated air systems; they are complete air solutions designed to maximize the key drivers of profitability in today's business:

- Ultimate reliability
- Shop productivity
- Flexibility of operation
- Energy efficiency and savings



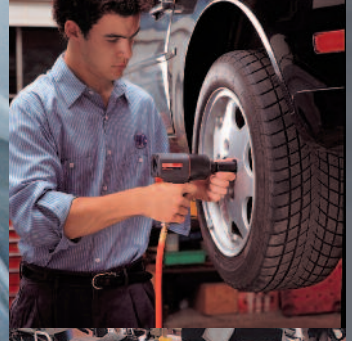

# Exceptional Value

## Ultimate Reliability

### Maximum Uptime

Ingersoll Rand is so confident in the performance of these compressors, that we offer a choice of extended warranty packages designed to provide you with maximum operating security.

### 70% Fewer Connections

Smart integration eliminates leaks and pressure drops, ensuring maximum reliability.

## Ultimate Efficiency

### More Air for Your Money

Industry-leading performance delivers more air for less horsepower, saving thousands of dollars per year on energy.

### Smart, Energy-efficient Controls

Eliminates wasteful unloaded running by cycling the compressor on/off.

## Ultimate Flexibility

### Compact Footprint

Small footprint frees up valuable floor space and reduces installation costs.

### Installation Close to Point-of-use

Whisper-quiet operation allows for installation closer to point-of-use, reducing costs and ensuring a better, safer work environment.

## Ultimate Productivity

### Closely Maintained Pressure

Closely maintained discharge pressure avoids excessive pressure bands and increases downstream tool and equipment life.



## Innovation

### High-efficiency Integrated Compression Module

- To provide maximum performance, efficiency and ease-of-service, the aircend, interconnecting piping and separation system have all been integrated into one simple design. Integration of the compression module eliminates leaks and pressure losses to increase efficiency and performance.
- Service and maintenance are made extremely easy through spin-on oil and separator cartridges.

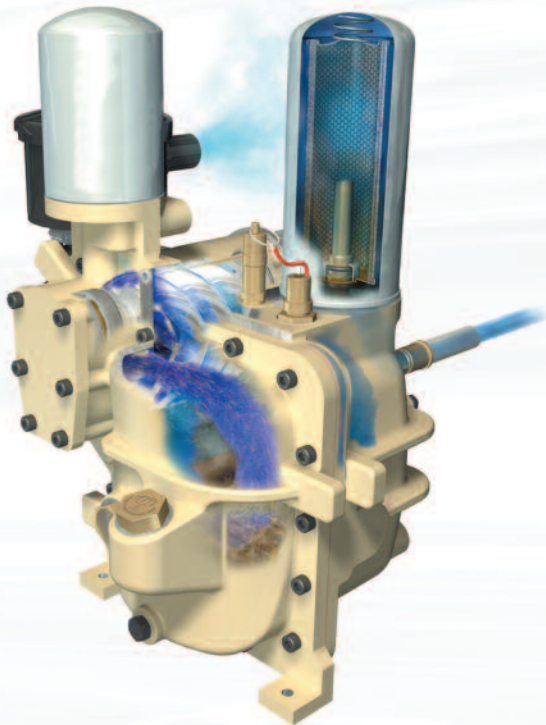

## Real World Advantages



**Whisper-quiet Operation**  
Oversized, high-efficiency motor mount blower. Sound levels as low as 65 dB(A).



**Dual-control Operation**  
Auto start/stop operation with constant speed control for maximum flexibility.

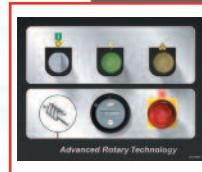

**Simple Diagnostics**  
Visual indication of operating status, hours and fault warnings for ease-of-operation and reduced downtime.

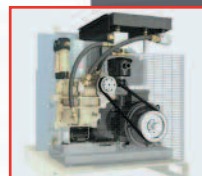

**Poly-V Belt Drive**  
Premium drive system to minimize belt stretching and increase air output.



**Advanced Cooling**  
High-efficiency, oversized combination cooler with roof mount discharge for ease of ducting.



**Generous Serviceability**  
Spacious design for ease of serviceability.

# Introducing the Total Air System by Ingersoll Rand

The high-efficiency  
compressor room... without  
the need for an actual room

## The Fully-integrated Air System

### The Right Choice to Maximize Productivity

At the same time as eliminating the task of selecting separate components, and reducing the extensive space requirements of the traditional compressed air system, the Total Air System will provide your business with maximum efficiency, reliability, flexibility and productivity.

## Smart Integration

### A Revolutionary Advancement

Going far beyond combining the compressor, dryer and filters in one package, smart integration also:

- Eliminates vulnerable interconnecting piping
- Minimizes pressure losses and drops
- Integrates the compressor, dryer and controls into an energy-reducing, optimized system
- Incorporates the entire supply-side system into one whisper-quiet package, enabling installation virtually anywhere
- Provides generous space to promote cooling and to allow unobstructed service

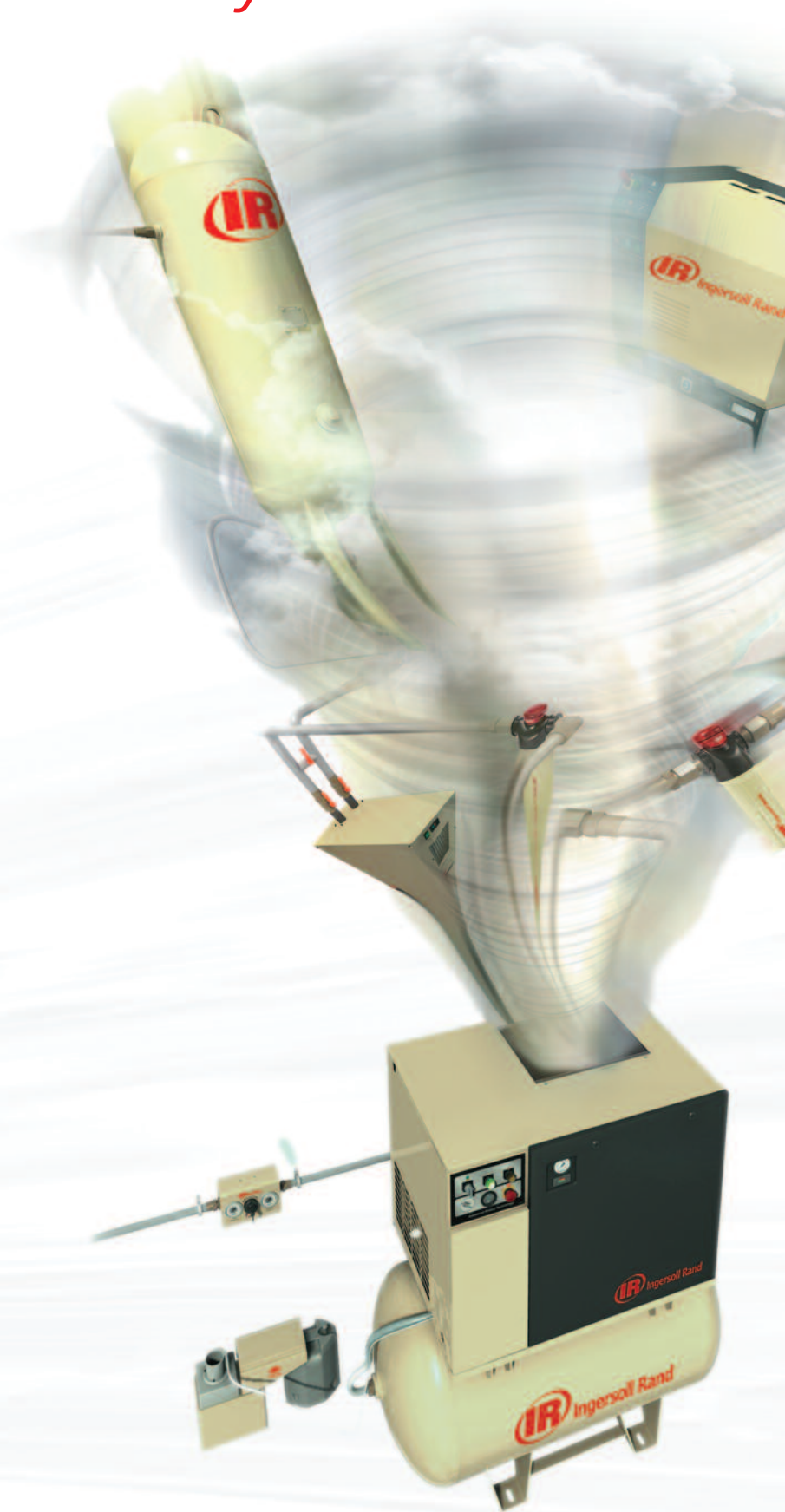



### **Dry and Clean Compressed Air**

#### **The Right Air Quality to Do the Job**

All Total Air System packages come fully equipped with an integral, energy-saving air treatment center including a high-performance air dryer and filtration pack to remove water, oil and particles from the air stream.

All components are perfectly matched to deliver the right air quality to increase air-powered tool and system equipment life.

### **High-efficiency Components**

#### **Setting the Standard in System Design**

The Total Air System incorporates only the highest quality components to ensure that both system efficiency and productivity are maximized—a high-efficiency compressor room without the hassle, complexity and costs of the traditional compressor room. Total Air System packages come fully equipped with:

- A high-efficiency rotary screw air compressor
- An energy-saving, cycling refrigerated air dryer
- A high-efficiency coalescing filter
- A high-efficiency particulate filter
- An integral air receiver storage tank
- Integrated compressor and dryer controls
- Low pressure drop piping
- A high-efficiency moisture separator
- Whisper-quiet, low sound operation

## **Lifetime Benefits**

Benefits are virtually endless ...

- Plug-and-play simplicity — eliminates the leading causes of failure in air systems: incorrect sizing and installation
- Virtually no install costs — eliminates 80% of install time, material and costs
- Integral packaging saves valuable floor space for other uses
- Lifetime power savings through highly efficient components
- Increased productivity through better air quality — eliminates water and corrosion resulting in extended tool and equipment life
- Whisper-quiet operation enables installation closer to point-of-use, which can eliminate hundreds of feet in piping and costly pressure drops

# Integral Air Treatment

## Dual Filtration Pack

### Clean Air to Drive Productivity

- Two stages of filtration deliver best performance, reduce pressure losses and extend operating life
- Particulate removal to industry-leading 1 micron
- Oil removal down to 0.01 micron
- Longer element life, lower pressure drop
- Better air quality delivered to tools and equipment results in longer life



## Energy-saving Refrigerated Air Dryer

### Dry Air-to-drive Productivity

- Cycling dryer – automatically shuts off with the compressor, saving energy compared to traditional dryers, which run continuously
- Stainless steel, braided heat exchanger for low losses, high thermal efficiency and long service life
- Solenoid drain valve and high-efficiency moisture separator to permanently discharge condensate
- Eliminates corrosion of piping—a cause of premature wear of tools and seals





### Smart Integration

#### Advanced Packaging to Drive Reliability and Uptime

- Integrally cooled with common blower to ensure cooling is achieved 100% of the time that compressor is running
- Spacious design promoting serviceability
- Package pre-filter for longer cooler life and lower pressure drops
- Simplified piping eliminates potential leaks
- Single-point condensate drain system instead of separate points – eliminates leaks
- Patented segregated package cooling compartment provides advanced cooling flow management and reduces noise level

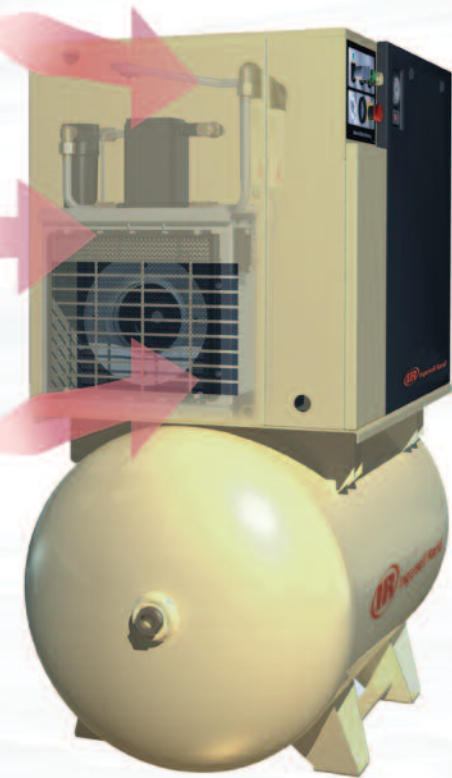

### Progress is greener with Ingersoll Rand

Ingersoll Rand offers industry-leading products and solutions that enable businesses around the world to reduce energy consumption and costs and decrease harmful environmental emissions. From air compressors that reduce energy consumption to electric-powered golf cars with near-zero emissions, Ingersoll Rand provides the knowledge, experience and solutions to help our clients achieve their sustainability goals.

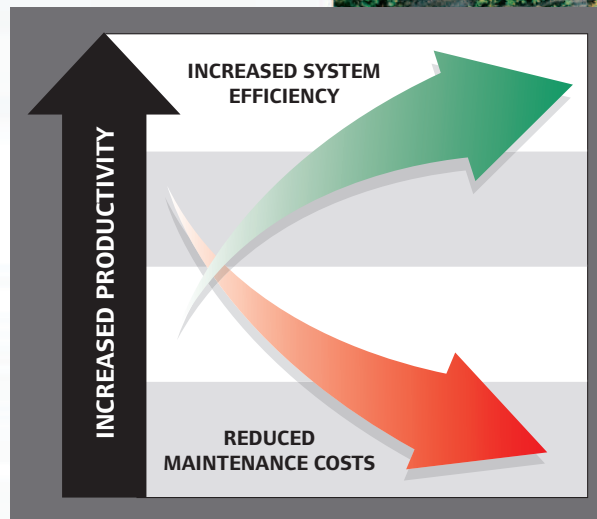

# Local Customer Support

## There is More to Value than Simply Price

The commitment of many thousands of dedicated compressed air specialists, either directly employed or members of a select market channel partnership, mean that friendly Ingersoll Rand support is close at hand. In addition to parts availability, qualified on-site service is available globally.



## Ease of Service

No matter what the industry or location, Ingersoll Rand is committed to serving you 24 hours a day, seven days a week. Our worldwide network of distributors, engineers and certified, factory-trained technicians, are a phone call away — ready to support you with innovative and cost-effective service solutions that will keep you running at peak performance.



## Ultra Coolant™

Save costs with the advanced synthetic compressor coolant supplied as standard. Ultra Coolant™ reduces friction and wear, has a long operating life, has simple condensate separation characteristics and is biodegradable.



PackageCare is a service contract designed to help customers get the most out of their air system investment. Whether it's Ingersoll Rand equipment or a competitor's, a new compressor or used, with PackageCare customers get hassle-free system reliability, backed by the most comprehensive service program in the industry. We're the only OEM in the industry offering this type of service coverage.



**PackageCare™**

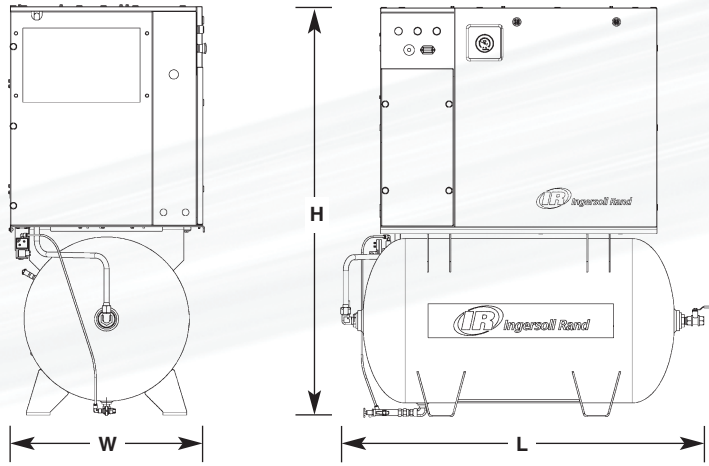

### Industry-leading Performance

60 Hertz Total Air System Specifications						
Model No.	hp	Discharge Pressure		Capacity*		
		Compressor	Package	cfm	m <sup>3</sup> /min	dB(A) <sup>†</sup>
		psig	psig			
UP6-5TAS-125	5	125	115	18.5	0.52	65
UP6-5TAS-150	5	150	140	16	0.45	65
UP6-7TAS-125	7.5	125	115	28	0.79	65
UP6-7TAS-150	7.5	150	140	25	0.25	65
UP6-7TAS-210	7.5	210	200	17.5	0.50	65
UP6-10TAS-125	10	125	115	38	1.08	68
UP6-10TAS-150	10	150	140	34	0.96	68
UP6-10TAS-210	10	210	200	24	0.68	68
UP6-15cTAS-125	15	125	115	55	1.55	69
UP6-15cTAS-150	15	150	140	50	1.42	69
UP6-15cTAS-210	15	210	200	38	1.08	69

60 Hertz Specifications - Without Air Treatment System					
Model No.	hp	Discharge Pressure		Capacity*	
		psig	cfm	m <sup>3</sup> /min	dB(A) <sup>†</sup>
UP6-5-125	5	125	18.5	0.52	65
UP6-5-150	5	150	16	0.45	65
UP6-7-125	7.5	125	28	0.79	65
UP6-7-150	7.5	150	25	0.25	65
UP6-7-210	7.5	210	17.5	0.50	65
UP6-10-125	10	125	38	1.08	68
UP6-10-150	10	150	34	0.96	68
UP6-10-210	10	210	24	0.68	68
UP6-15c-125	15	125	55	1.55	69
UP6-15c-150	15	150	50	1.42	69
UP6-15c-210	15	210	38	1.08	69

Dimensions & Weight	50 & 60 Hertz Baseplate and Receiver Mounted Units						Total Air System		Without Air Treatment System	
	Length		Width		Height		Weight		Weight	
	in	mm	in	mm	in	mm	lb	kg	lb	kg
<b>Base Mount</b>	41	1,042	28.9	734	36	914	725	330	650	295
80 Gallon Receiver Tank	53.6	1,361	28.9	734	60.7	1,541	1,000	454	925	419
120 Gallon Receiver Tank	74.7	1,897	28.9	734	60.7	1,541	1,035	470	960	435
272 Liter Receiver Tank	51.6	1,311	28.9	734	60.7	1,541	1,003	455	928	420
500 Liter Receiver Tank	81	2,059	28.9	734	60.7	1,541	1,080	490	1,005	455

50 Hertz Total Air System Specifications						
Model No.	kW	Discharge Pressure		Capacity*		
		Compressor	Package	m <sup>3</sup> /min	cfm	dB(A) <sup>†</sup>
		bar g	bar g			
UP5-4TAS-8	4	8	7.3	0.55	19.5	65
UP5-4TAS-10	4	10	9.3	0.45	16	65
UP5-5TAS-8	5.5	8	7.3	0.82	29	65
UP5-5TAS-10	5.5	10	9.3	0.74	26	65
UP5-5TAS-14	5.5	14.5	13.8	0.51	18	65
UP5-7TAS-8	7.5	8	7.3	1.08	38	68
UP5-7TAS-10	7.5	10	9.3	0.96	34	68
UP5-7TAS-14	7.5	14.5	13.8	0.68	24	68
UP5-11cTAS-8	11	8	7.3	1.60	56.5	69
UP5-11cTAS-10	11	10	9.3	1.42	50	69
UP5-11cTAS-14	11	14.5	13.8	1.08	38	69

50 Hertz Specifications - Without Air Treatment System					
Model No.	kW	Discharge Pressure		Capacity*	
		bar g	m <sup>3</sup> /min	cfm	dB(A) <sup>†</sup>
UP5-4-8	4	8	0.55	19.5	65
UP5-4-10	4	10	0.45	16	65
UP5-5-8	5.5	8	0.82	29	65
UP5-5-10	5.5	10	0.74	26	65
UP5-5-14	5.5	14.5	0.51	18	65
UP5-7-8	7.5	8	1.08	38	68
UP5-7-10	7.5	10	0.96	34	68
UP5-7-14	7.5	14.5	0.68	24	68
UP5-11c-8	11	8	1.60	56.5	69
UP5-11c-10	11	10	1.42	50	69
UP5-11c-14	11	14.5	1.08	38	69

\* Performance in accordance with ISO 1217 1996 annex C † Measured in accordance with CAGI-pneurop test code PN8NTC2.3



Ingersoll Rand Industrial Technologies provides products, services and solutions that enhance our customers' energy efficiency, productivity and operations. Our diverse and innovative products range from complete compressed air systems, tools and pumps to material and fluid handling systems and environmentally friendly microturbines. We also enhance productivity through solutions created by Club Car®, the global leader in golf and utility vehicles for businesses and individuals.

[www.air.ingersollrand.com](http://www.air.ingersollrand.com)

Distributed by:



Ingersoll Rand compressors are not designed, intended or approved for breathing air applications. Ingersoll Rand does not approve specialized equipment for breathing air applications and assumes no responsibility or liability for compressors used for breathing air service.

Nothing contained on these pages is intended to extend any warranty or representation, expressed or implied, regarding the product described herein. Any such warranties or other terms and conditions of sale of products shall be in accordance with Ingersoll Rand's standard terms and conditions of sale for such products, which are available upon request.

Product improvement is a continuing goal at Ingersoll Rand. Designs and specifications are subject to change without notice or obligation.

