

Energy for you and me

How we make solar panels to harness the sun's abundant power



RETURNING TO THE SUN



“Environmental ills and climate change pose global crises for our planet. Any answer to these problems must be powerful. Fortunately, we need only tap the power source of life’s history for answers: the sun and its ample energy.”

Dr.-Ing. E. h. Frank Asbeck, SolarWorld chairman and CEO

Energy crisis

Over the past two centuries, humans learned to harness fossil fuels on a vast scale to power an industrial revolution. This quantum advance in machine automation, mass production and labor division drove unparalleled improvements in the health, economics and comforts of citizens of industrialized nations.

But today, the benefits come at great, unpaid environmental costs. Fossil fuels cannot continue to be humanity’s primary source of energy. It’s time for an energy foundation in harmony with the planet. It’s time for a solar revolution.

Life’s power plant

Perpetually renewing power from the sun has fueled life on Earth since its first spark. From cellular to mammalian forms, the sun has supplied a critical ingredient in the recipe for living beings. More practically, humans have relied on solar power – to warm water, dry clothes and prepare food – as far as history’s record reaches.

The sun emits so much energy that solar experts compete to put the output in terms we can grasp. Here’s just one: Earth receives enough solar radiation in an hour to supply the planet’s electrical needs for a year.



PV FACT

Of the 92 elements, silicon (Si) is the Earth's most prevalent semiconductor – and second most common element of any kind, after oxygen. Appearing in silicon oxides such as sand (silica), quartz, rock crystal, amethyst, agate, flint, jasper and opal, silicon makes up about a quarter, by weight, of the Earth's crust. Photovoltaic manufacturing starts with polysilicon, a refinement of silicon materials.



WORD TO KNOW

Photovoltaic. The word photovoltaic comes from the words photo, meaning light, and volt, meaning electricity. In short, the term PV means electricity from light.

Gathering the sun's bounty

Now people are re-tapping their roots in a solar world by using panels of photovoltaic (PV) cells to generate power from the sun's rays. As reliable as the sun itself, the technology is simple and clean. Cells are built on wafers of silicon made from ordinary sand and quartz. Assembled into solar panels and exposed to the sun, the cells directly convert light into electricity – without polluting emissions, resource depletion or moving parts.

SolarWorld, extraordinary because it undertakes all phases of PV manufacturing and makes no other products, builds panels in four steps, starting with sand and ending with sun.

Turn the page to begin the story behind SolarWorld's core mission to put the technology to work for homes and businesses around the world.

ROOTS OF A RENEWABLE ENERGY SOURCE



The history of the solar industry and SolarWorld are intermixed, each with one foot squarely positioned in the United States and the other in Germany – the two markets that have led the industry’s development. In the U.S., SolarWorld began as ARCO Solar. Siemens and Shell then owned the unit before SolarWorld acquired it.

1954 Bell Labs announces invention of the first modern silicon solar cells, with energy-conversion efficiency of about 6 percent.

1955 Western Electric licenses commercial solar cell technologies.

1957 AT&T employees Gerald L. Pearson, Daryl M. Chapin and Calvin S. Fuller receive patent US2780765, “Solar Energy Converting Apparatus.”

1958 Hoffman Electronics-Semiconductor Division creates 9%-efficient solar cells.

Vanguard 1, the first solar-powered satellite, is launched with .1 watt solar panel.

1960 Hoffman Electronics creates a 14%-efficient solar cell.

1961 United Nations stages “Solar Energy in the Developing World” conference.

1962 The Telstar communications satellite is powered by solar cells.

1963 Viable photovoltaic panel is produced out of silicon solar cells.

1964 Yale University Press publishes Farrington Daniels’ landmark book, “Direct Use of the Sun’s Energy.”

1967 Soyuz 1 becomes first manned spacecraft using solar.

1973 Solar cells power Skylab, the first U.S. space station.

1974 A home in New Mexico is the world’s first to be powered only by solar and wind energy.

1975 Engineer and entrepreneur Bill Yerkes creates Solar Technology International.

1977 Yerkes sells his manufacturing startup to Atlantic Richfield Co., forming ARCO Solar, but he remains president.

1979 In Camarillo, Calif., ARCO Solar dedicates world’s largest PV factory to making silicon crystal ingots, wafers, photovoltaic cells and panels.

World annual PV array production (MWp)





PV FACT

Pioneering relativity theorist Albert Einstein won the Nobel Prize in 1921 – but not for his renowned relativity equation $E=mc^2$. The prize actually celebrated his 1905 discovery of exactly how light caused what was then called the photoelectric effect – essentially, photovoltaics. Today, SolarWorld issues its annual Einstein Awards to honor PV researchers.



WORD TO KNOW

Photon: A photon is neither a wave nor a particle, but instead a packet of light energy. Solar radiation arrives on the surface of photovoltaic cells in the form of photons, providing the main energy that activates cells to produce electricity.

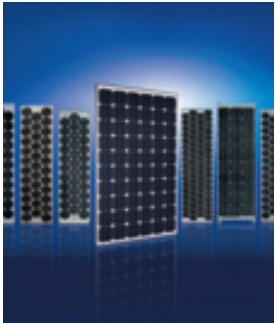

1980 ARCO Solar becomes first company to produce more than 1 megawatt of PV panels in one year.

A 105.6-kW system is dedicated at Natural Bridges National Monument in Utah, using panels of ARCO Solar, Motorola and Spectrolab.

1982 ARCO Solar commissions world's first 1 MW grid-connected PV installation in Hisperia, Calif., using panels on 108 dual-axis trackers.

1983 Worldwide photovoltaic production exceeds 20 MW and sales surpass \$250 million.

1985 Australia's University of New South Wales creates silicon cells with 20% efficiency in laboratory.

1990 Siemens acquires ARCO Solar, forming Siemens Solar.

1996 Siemens Solar celebrates 100 MW of installed power from panels made in Camarillo.

1997 Siemens becomes first company to offer 25-year warranty.

1998 SolarWorld forms as start-up business, entering Germany's burgeoning solar market.

1999 Germany requires utilities to pay "feed-in tariffs" at fixed premium rates to owners of solar systems for power contributed into grid.

2002 Royal Dutch Shell acquires Siemens Solar, creating Shell Solar.

2006 SolarWorld acquires Shell Solar.

2007 Investors begin offering free installation in return for long-term power purchase agreements (PPAs), which become common financing arrangements.

2008 SolarWorld opens 480,000-square-foot plant in Hillsboro, investing \$500 million to establish 500 MW of annual capacity and 1,000 employees there.

Yellow = SolarWorld's U.S. lineage

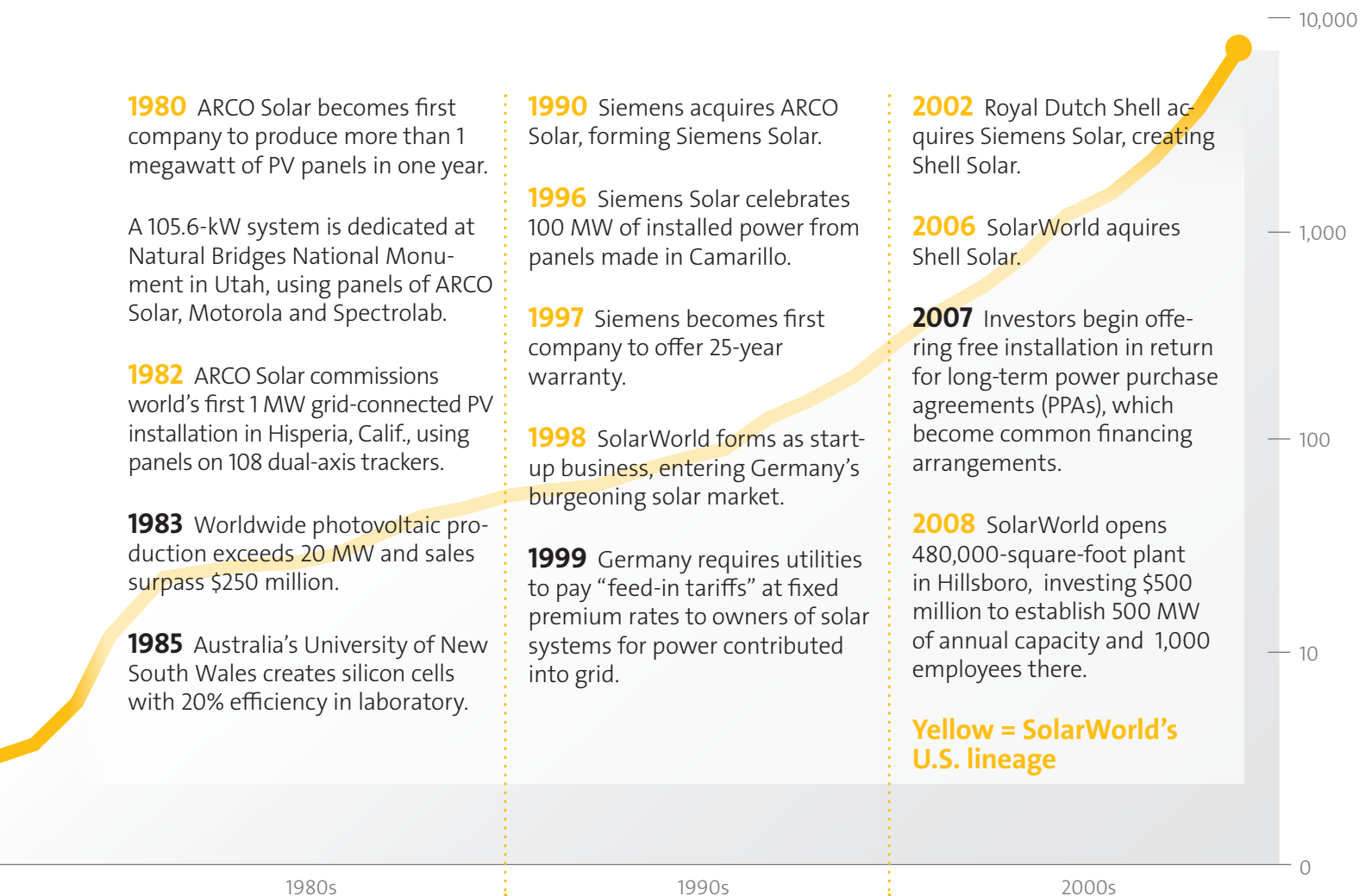

1980s

1990s

2000s

FROM SAND TO SOLAR PANEL

The journey that starts with silicon and ends with a large-scale solar facility is long, with many stops along the way. As one of the largest solar companies in the world, SolarWorld attaches great importance to the highest quality – at every stage of production.



Silicon

Silicon is the starting point of our solar production cycle. It is extracted from sand, which is made up primarily of silicon dioxide. As the second most common element of the earth's crust, there is an almost endless supply.

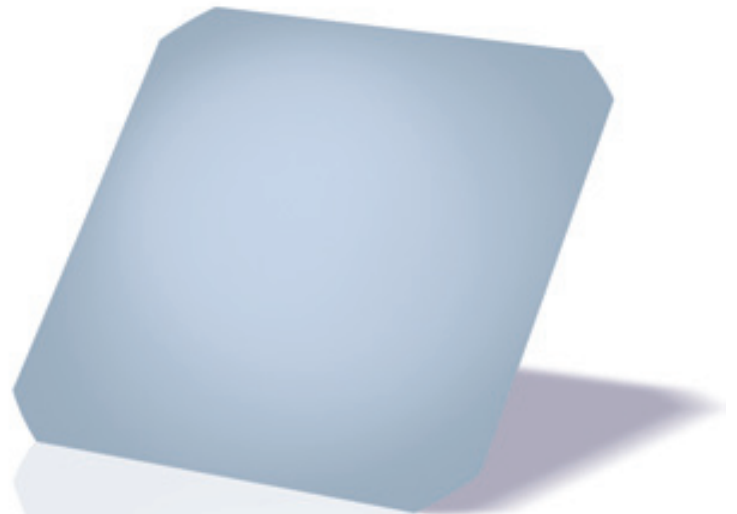

Solar wafer

In the second production step, highly pure silicon forms into crystal structure at 2,500 degrees Fahrenheit and it then hardens. The crystallized silicon is then shaped into rectangular columns. These columns are cut into extremely thin slices, or wafers, using state-of-the-art wire-cutting technology. After cleaning and thorough final testing, the monocrystalline and polycrystalline wafers form the basis for the production of solar cells.

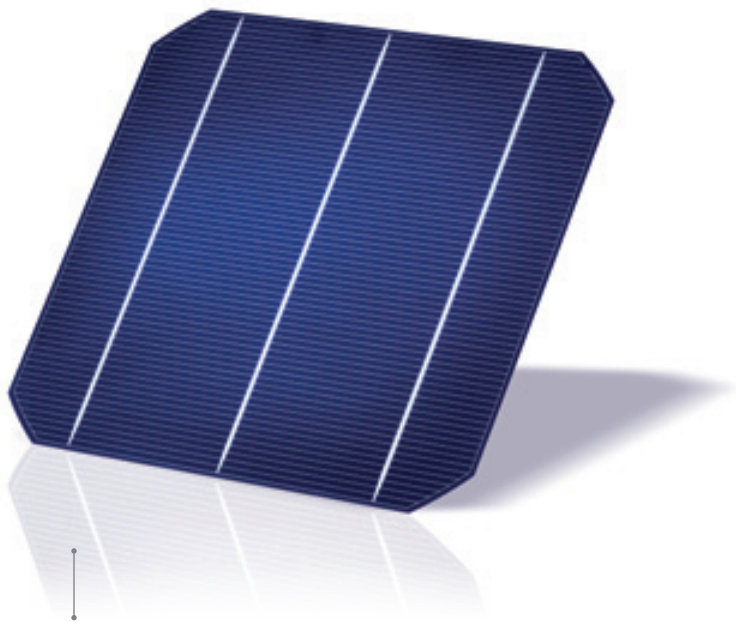

Solar cells

The wafers are further processed into solar cells in the third production step. They form the basic element of the resulting solar panels. The cells already possess all of the technical attributes necessary to generate electricity from sunlight. Positive and negative charge carriers are released in the cells through light radiation, causing electrical current (direct current) to flow.

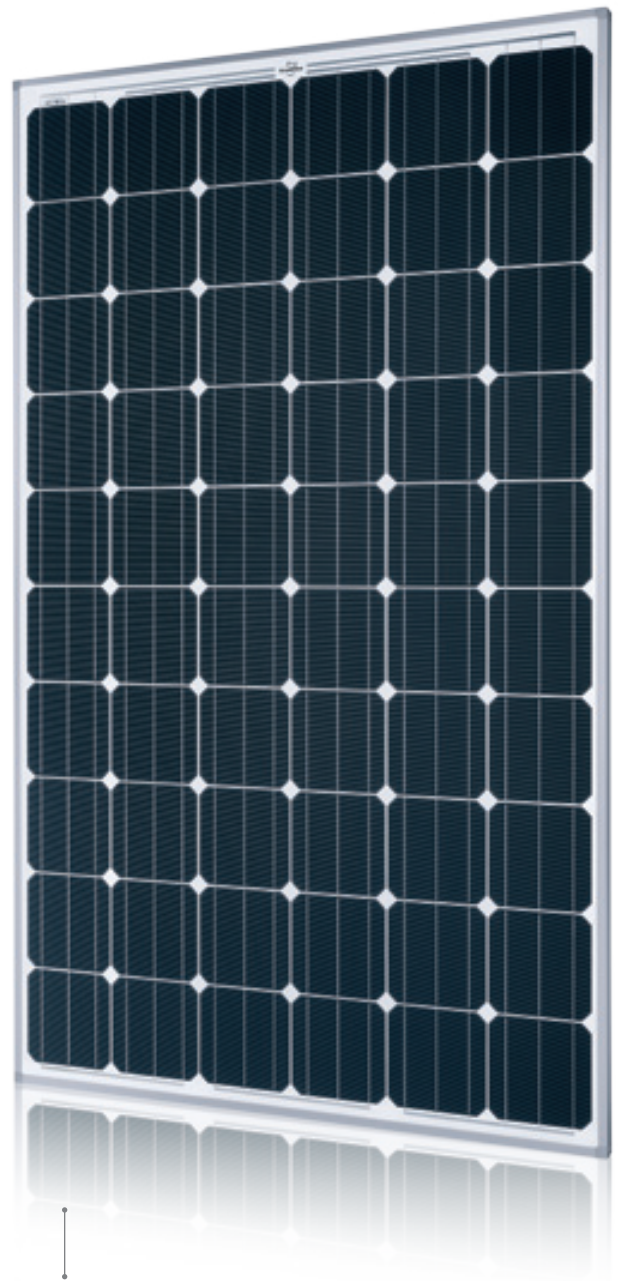

Solar panel

Solar cells are merged into larger units – the panels – in panel production. They are framed and weather-proofed. The solar energy panels are final products, ready to generate power. Sunlight is converted into electrical energy in the panels. The direct current produced this way is converted to alternating current by a device called an inverter so that it can be fed into the utility grid or, if applicable, straight into the house.

GROWING CRYSTAL FROM ROCK

In its monocrystalline process, SolarWorld heats and melts polysilicon rock until it forms a white-hot liquid, then re-solidifies the molten silicon into a single giant crystal in which all atoms are perfectly aligned in a desired structure and orientation.

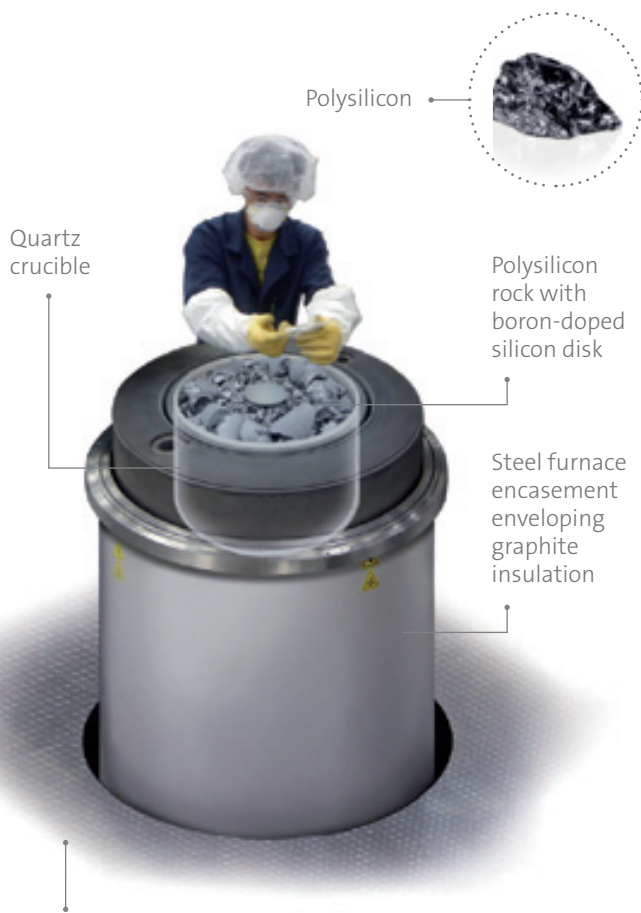

Charging

The magic starts with about 250 pounds of polysilicon rocks carefully stacked in a quartz crucible. The only other ingredient is a silicon disk impregnated with a tiny amount of boron. The addition of the boron dopant ensures that the resulting crystal will bear a positive potential electrical orientation. The crucible is encased within thick walls of insulating graphite and locked inside a cylindrical furnace.

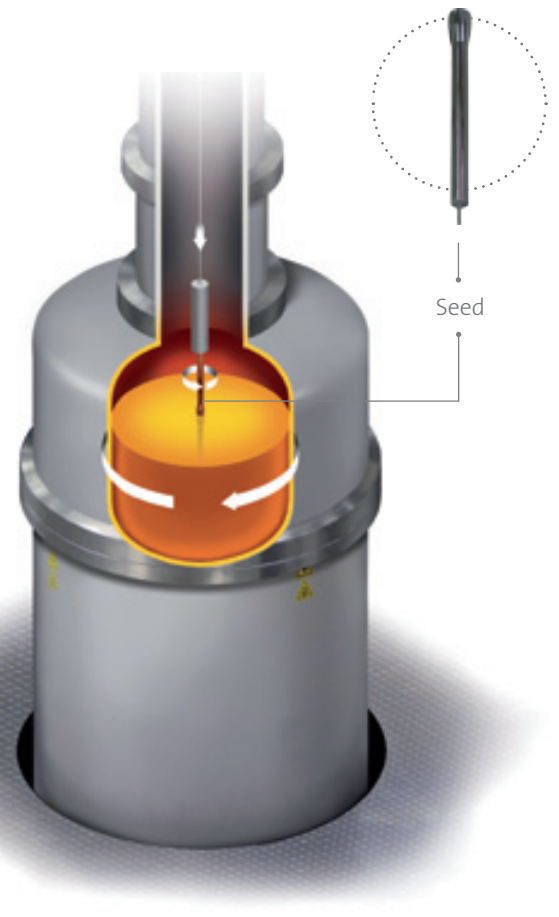

Melting

As the crystal-growing furnace heats up to temperatures ranging around 2,500 degrees Fahrenheit, its silicon contents liquefy into a shimmering melt. Once computerized monitors register the right temperature and atmospheric conditions, the alchemy begins. A silicon seed crystal, hung from a narrow cable attached to a rotary device atop the furnace, is slowly lowered into the melt.

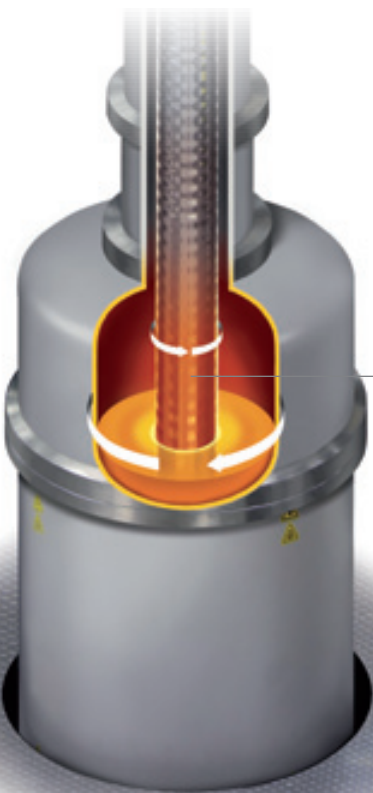

Growing

The crucible starts to turn, and the seed crystal begins to rotate in the opposite direction. The silicon melt freezes onto the seed crystal, matching the seed's crystalline structure. The crystal grows, the cable and seed slowly ascend, and the crystal elongates at a controlled diameter. As the growth depletes the silicon melt, the crucible also rises.

Crystal measuring 8 inches wide and about 5 ½ feet long

Crystal emerging from melt

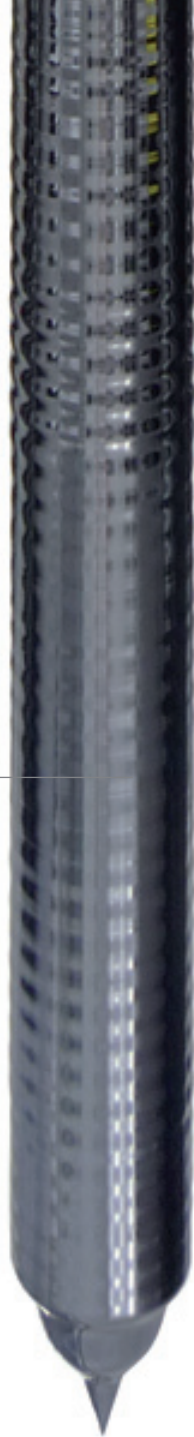

Cooling

Flash forward about 3½ days since the crucible was charged with polysilicon: After hours of cooling to about 300 degrees Fahrenheit, the furnace hood and shaft lift away from the crucible enclosure to reveal a completed cylindrical crystal, ready to move to the second step and next production room.



PV FACT

The method that SolarWorld uses in the United States to grow silicon crystal is known as "Cz" (pronounced CEE-ZEE). Cz is an abbreviation for the Czochralski process, named after Polish scientist Jan Czochralski, who discovered the method in 1916 as he researched crystallization rates of metals.



WORD TO KNOW

Crystal: A crystal is a solid with molecular building blocks, such as atoms or ions, that have arranged themselves in an identically repeating pattern along all three spatial dimensions.

CUTTING CRYSTAL INTO WAFERS

A silicon crystal must change shape several times before it winds up as the precisely calibrated wafers that form the foundations of photovoltaic cells.

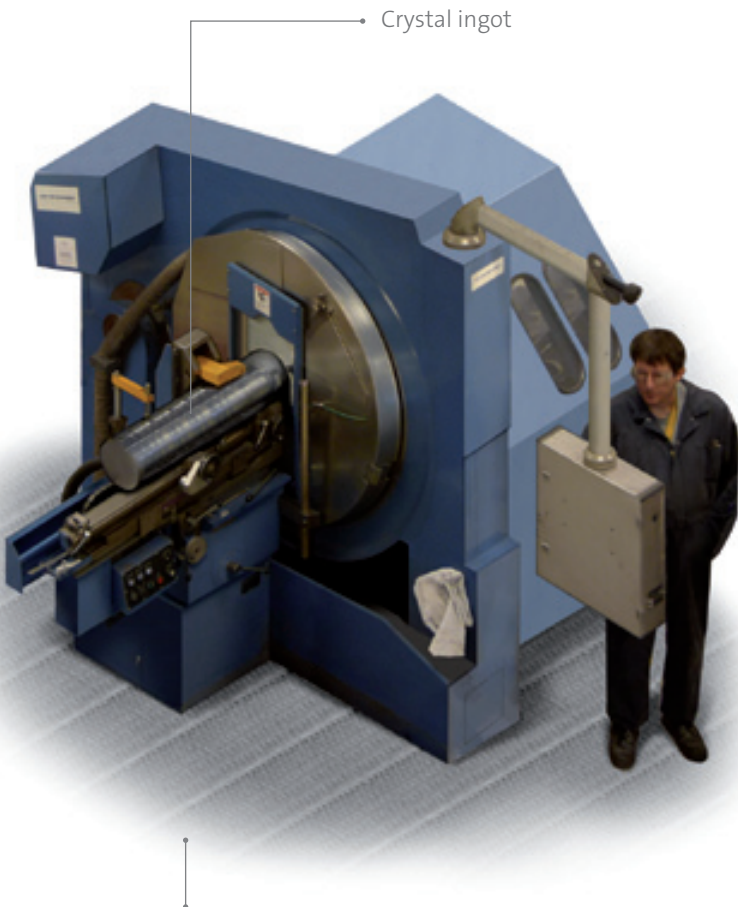

Cutting

First, a saw cuts off the crystal's so-called top and tail, so that a crystal of uniform width remains. Typically, wafering saws draw thin wire bearing a liquid abrasive across the crystal's surface. (Above, a machine mounted with a giant donutlike steel blade does the cutting.) Wire saws also cut the crystal into ingots measuring 2 feet long. Steel holders are mounted on one end of these ingots for the next step.

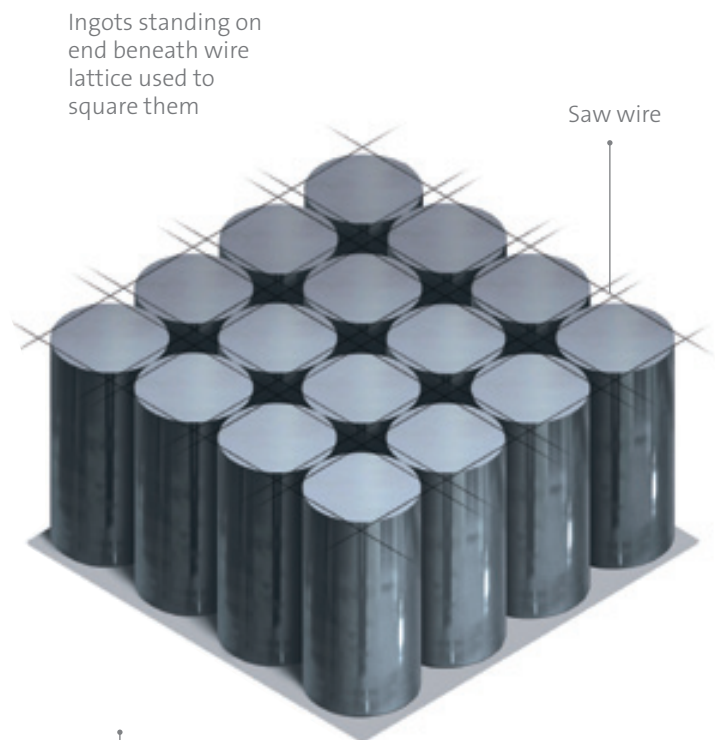

Squaring

Mounted ingots are placed standing on end in a rack bearing 16 at a time inside another wire-slicing machine. There, wire running in a lattice configuration descends on the ingots to shear off four rounded segments, leaving flat sides. The result: The ingots now have a square cross-section, except for still-rounded corners.



PV FACT

Wafering saws use spools of wire to carry the mineral abrasive silicon carbide, effectively forming a miniscule strand of sandpaper. The spools bear wire measuring about 400 miles long. Stretched out from SolarWorld's U.S. headquarters in Hillsboro, Ore., the wire would reach roughly to Missoula, Mont.



WORD TO KNOW

Silicon carbide: Silicon carbide (SiC), silicon bonded with carbon, is another member of the silicon family of materials used in the PV industry. It is a common abrasive in many industries, used in everything from grinding to sandblasting. At SolarWorld, crushed SiC is mixed into a water slurry and applied to saw wires. Silicon carbide, not wire, actually does the cutting.

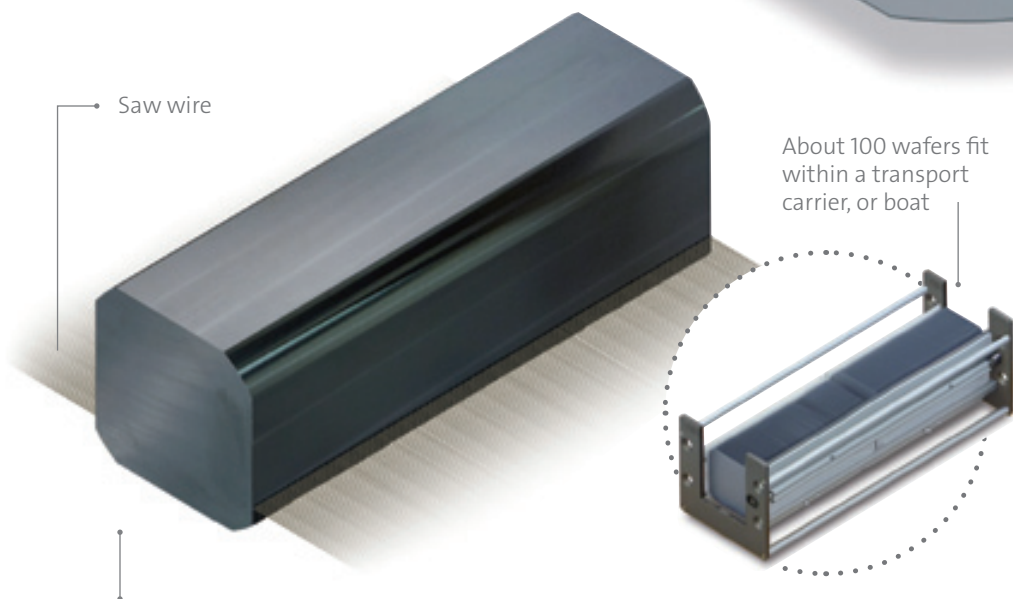

Slicing

The next wire saw is more intricate yet. A wire winding hundreds of times between two cylindrical drums forms a web of parallel, tightly spaced segments. As the wire unspools through the machine, ingots mounted sideways on glass and metal holders are pressed two at a time through the wire web, slicing them into the thickness of slim business cards. Each millimeter of crystal yields about 2½ wafers. Detached from their holders, the wafers are loaded into carriers, or boats, for transport to the next step.

CONVERTING WAFERS INTO CELLS

At this point, a wafer is no more capable of producing electricity than a sliver of river rock. The wafer is the main building block of a PV cell, but so far its only notable characteristics are its crystal structure and positive potential orientation. All of that changes in the third, multistep, cell-production phase of PV manufacturing.

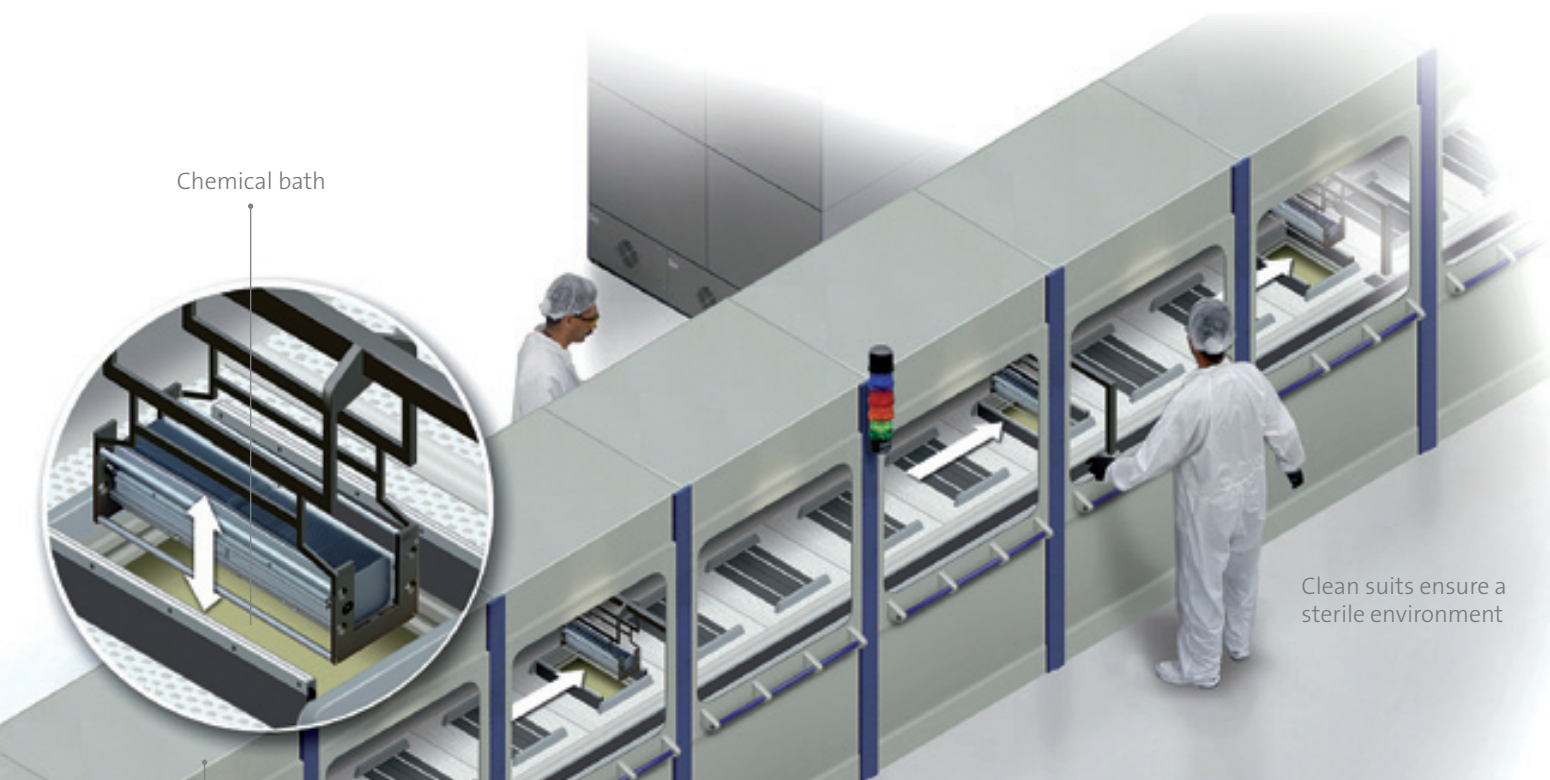
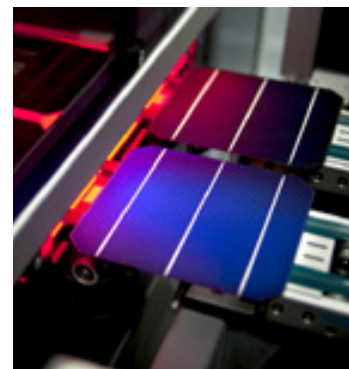

Texturing

In the only phase requiring a designated clean room, a series of intricate chemical and heat treatments converts the blank, grey wafers into productive, blue cells.

A so-called texture etch, for instance, removes a tiny layer of silicon, relying on the underlying crystal structure to reveal an irregular pattern of pyramids. The surface of pyramids – so small they're invisible to the naked eye – absorbs more light.

Diffusing

Next, wafers are moved in cartridges into long, cylindrical, oven-like chambers in which phosphorus is diffused into a thin layer of the wafer surface.

The molecular-level impregnation occurs as the wafer surface is exposed to phosphorus gas at a high heat, a step that gives the surface a negative potential electrical orientation. The combination of that layer and the boron-doped layer below creates a positive-negative, or P/N, junction – a critical partition in the functioning of a PV cell.

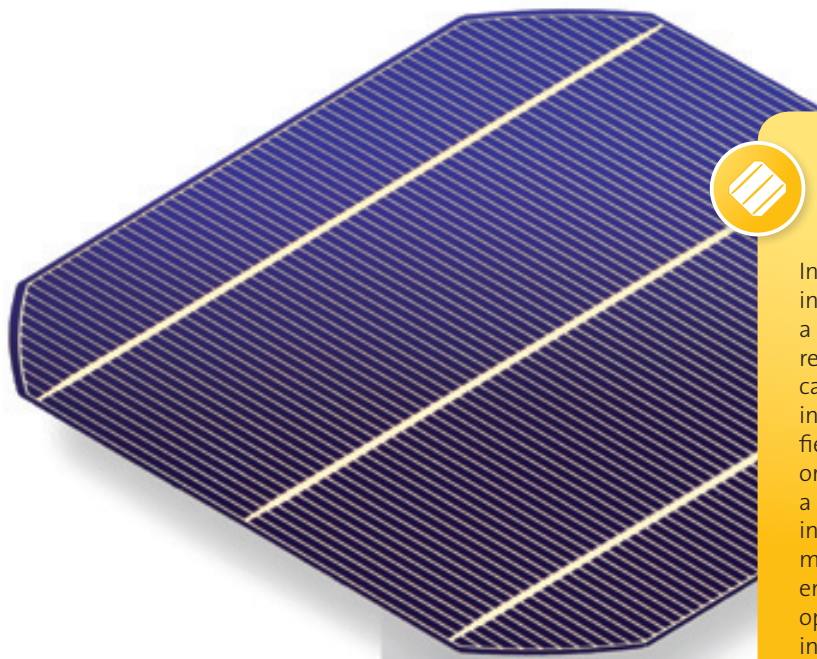

PV FACT

In the PV and semiconductor industries, the word tool has a special meaning. Instead of referring to an implement that can be applied to a manufacturing mechanism, tools in these fields refer to entire machines or assembly lines that perform a step or series of steps. In both industries, tools are highly automated so that most workers are employed to install, finetune and operate the tools, rather than lifting or moving product. Spider-like devices lift and move wafers and cells on and off conveyor belts for multiple tests along their journey from wafer to cell.

Drying oven

Printing template

Wafer

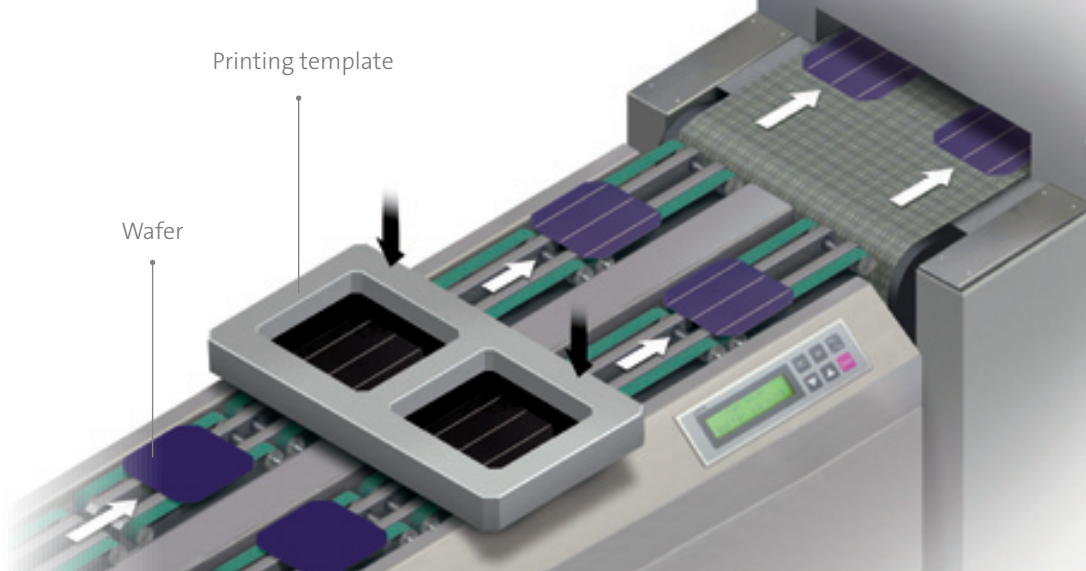

WORD TO KNOW

Micron: In cell production, manufacturing steps occur in dimensions measured in microns. In the metric system, a micron is one millionth of a meter, or one thousandth of a millimeter. For reference, a human hair measures about 100 microns across.

Coating

The burgeoning, still-grey cells move in trays into heavy vacuum chambers where blue-purple silicon nitride is deposited onto their tops. The coating with silicon nitride – yet another member of the silicon family of materials – is designed to reduce reflection even further in the energy-dense blue end of the light spectrum. It leaves the cells with their final, dark color.

Printing

Now, the cells can optimally gather photons and produce electricity. They lack, however, any mechanism to collect and forward the power. So, in a series of silkscreen-like steps, metals are printed on both sides of the cell, adding pin-stripe “fingers” and bus-bar circuitry. A functioning cell is born – only sunshine is needed to produce electricity.

STRINGING CELLS INTO PANELS

Each phase of production depends on processes with flavors all their own. Careful control of heating and cooling dominates crystal growing. Wafering employs abrasion and cutting. Cell production concentrates on chemistry. Any factory process would be incomplete without a final assembly step, and in PV such a step is known as panel assembly, or moduling.

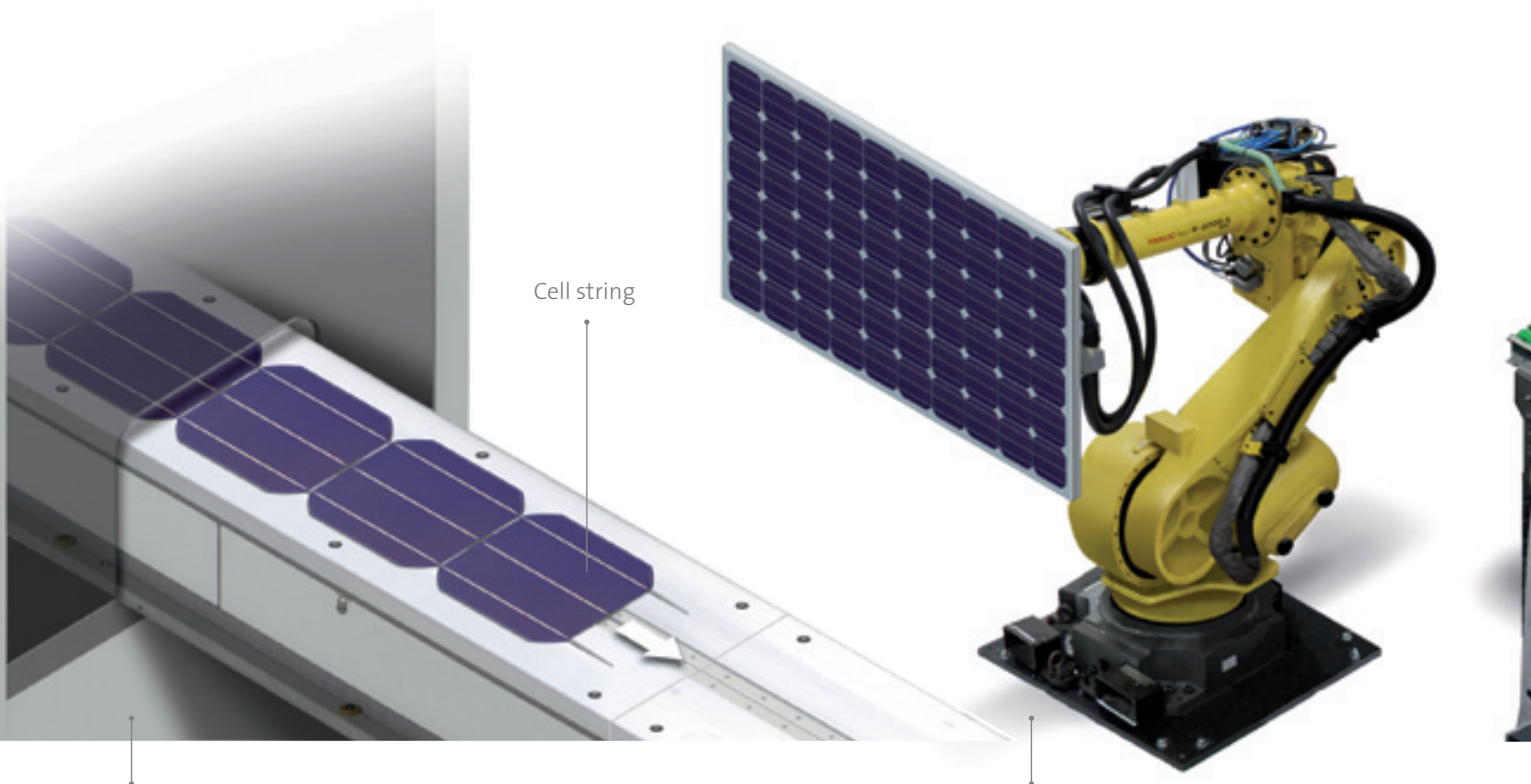

Soldering and laminating

At SolarWorld, panel manufacturing is a highly automated process, relying on robust steel robotics to undertake the increasingly heavy lifting of assembling lightweight PV cells into panels weighing around 45 pounds apiece. Each robotic tool works within a safety fence that, by design, prevents human access. First, cells are soldered together into strings of 10, using an over-under-over-under pattern of metal connectors to link the cells. Six strings are laid out to form a rectangular matrix of 60 cells. Each matrix is laminated onto special solar glass.

Framing

To become a solar panel, however, each laminate requires not only a frame to provide protection against weather and other impacts but also a junction box to enable connections among panels or with an inverter-bound conduit. Robots affix those, too.



PV FACT

SolarWorld is a manufacturer. It sells Sunmodule™ solar panels mostly through distributors, integrators and contractors. But the company also sells Sunkits® systems – configurations of panels, inverter and parts that include everything that licensed electrical contractors need for specific projects at specific locations. SolarWorld pioneered this approach in the 1990s.



WORD TO KNOW

Module: Within the industry, solar panels are called modules, because they link together evenly and interchangeably use electrical connectors to form a circuit within an array, with a building or with a utility grid. To make a module, cell-matrix laminants are mounted into sturdy aluminum frames. The resulting module is robust enough to withstand 50 mph hailstone impacts and up to 112 pounds per square foot of wind or snow load.



Inspecting and shipping

Careful cleaning and inspection provide final touches before each solar panel can be boxed for delivery to homes and businesses. However, inspection does not only take place at the end of the production line. Digitized and automated checks take place at key steps from silicon crystallization through panel assembly, and human inspection of each and every cell and panel.

HOW A PV CELL MAKES ELECTRICITY

Under the sun, a photovoltaic cell acts as a photosensitive diode that instantaneously converts light – but not heat – into electricity.

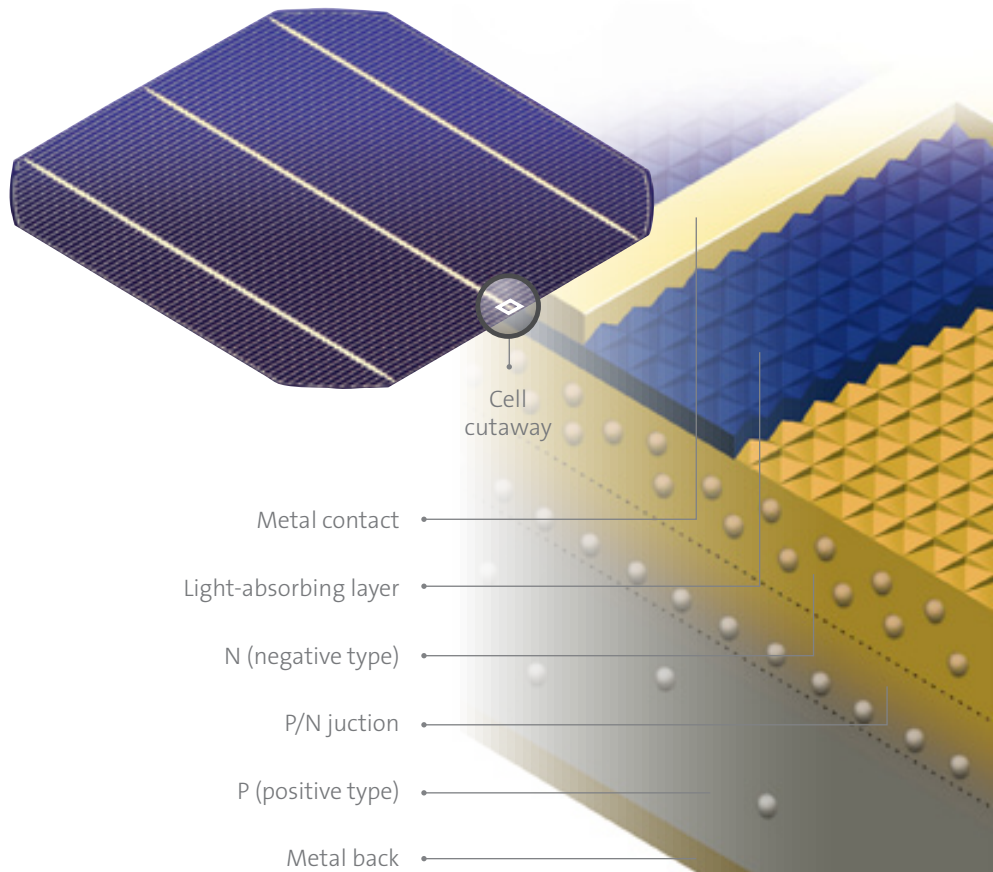
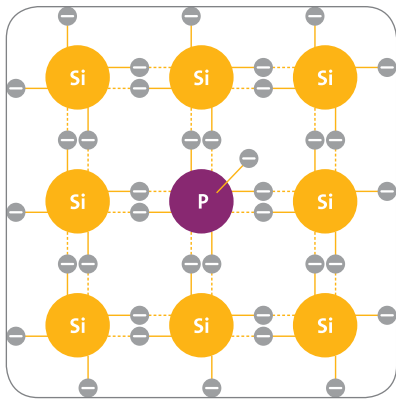
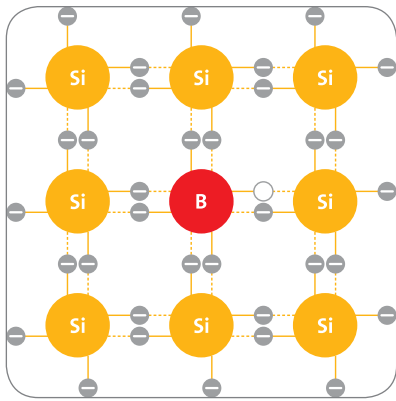

Positive doping

(1) Recall that in the crystallization step a small amount of the dopant boron was added to the polysilicon chunks before they were melted. Boron lacks one electron and therefore takes on an electron from silicon as an acceptor. Because the electron is missing, leaving an electron hole, the semiconductor becomes p-conductive (positive-conductive).

Negative doping

(2) Remember that in cell production phosphorus was applied to those layers of the silicon wafer closest to the surface. This dopant, as compared with silicon, has one extra electron, which it can easily release. Thus the silicon becomes n-conductive (negative-conductive).

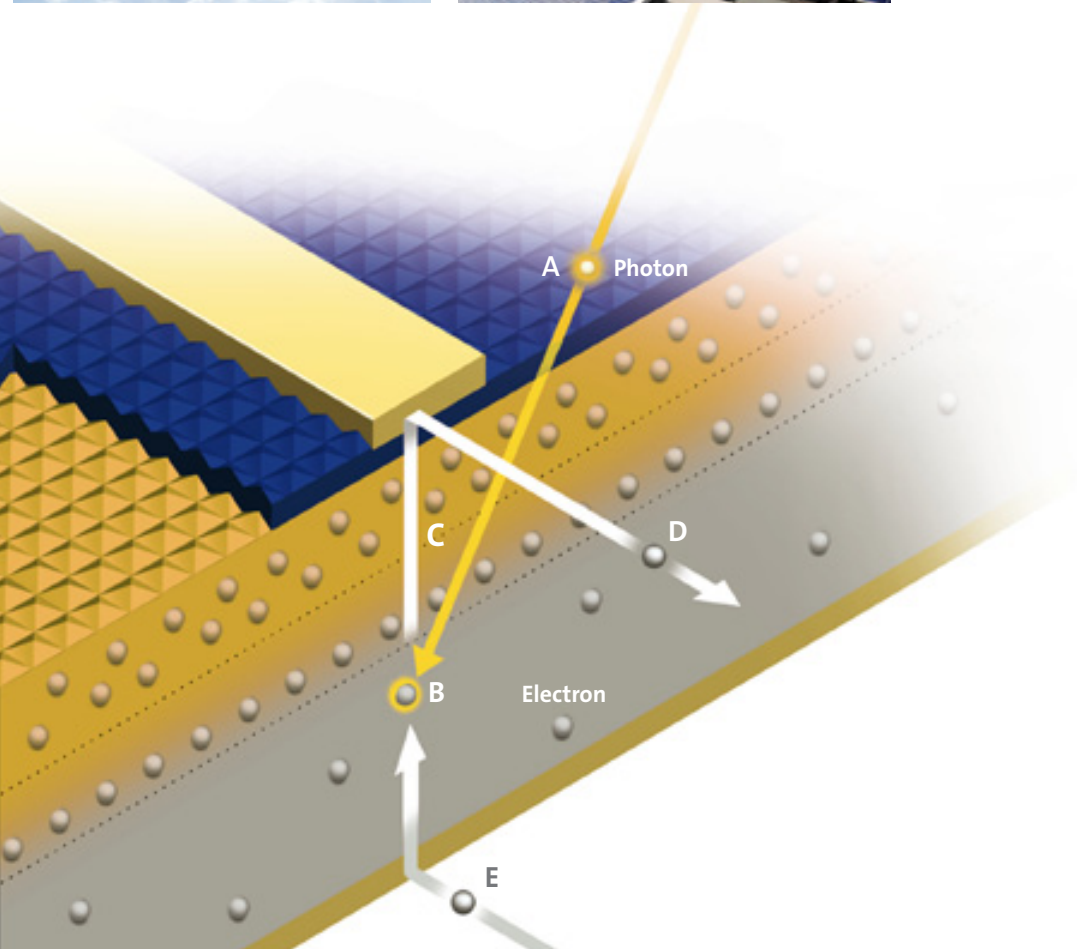
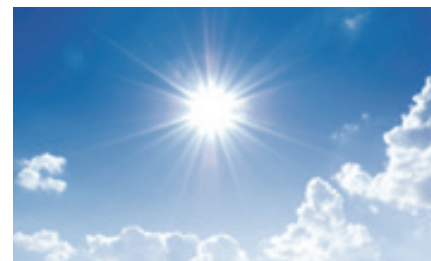

PV FACT

It takes all kinds of workers to produce PV, ranging from doctoral engineers troubleshooting arcane problems to entry-level machine operators learning basic process steps. Within SolarWorld, the four stages of production run as semi-autonomous but interdependent factories, all with teams of production engineers, maintenance engineers, technicians and operators.



WORD TO KNOW

Conversion efficiency: This measure gauges the percentage of solar (light) power reaching a panel that is converted into electrical power. Conventional cells now range in the high percentage teens. Theoretical and laboratory conversion rates typically are much higher than rates from mass production.

Cell layers

The top, phosphorus-diffused silicon layer therefore carries free electrons – unanchored particles with negative charges. The thicker, boron-doped bottom layer contains holes, or absences of electrons, that also can move freely. In effect, precise manufacturing has instilled an electronic imbalance between the two layers.

Sun activation

- A) Photons bombard and penetrate the cell.
- B) They activate electrons, knocking them loose in both silicon layers.
- C) Some electrons in the bottom layer sling-shot to the top of the cell.
- D) These electrons flow into metal contacts as electricity, moving into a circuit throughout a 60-cell panel.
- E) Electrons flow back into the cell via a solid contact layer at the bottom, creating a closed loop or circuit.

SOAK UP THE SAVINGS

The sun provides abundant clean energy every single day, even when it's cloudy – and it never sends a bill. The sun provides enough energy to serve the entire world's energy needs hundreds of times over.

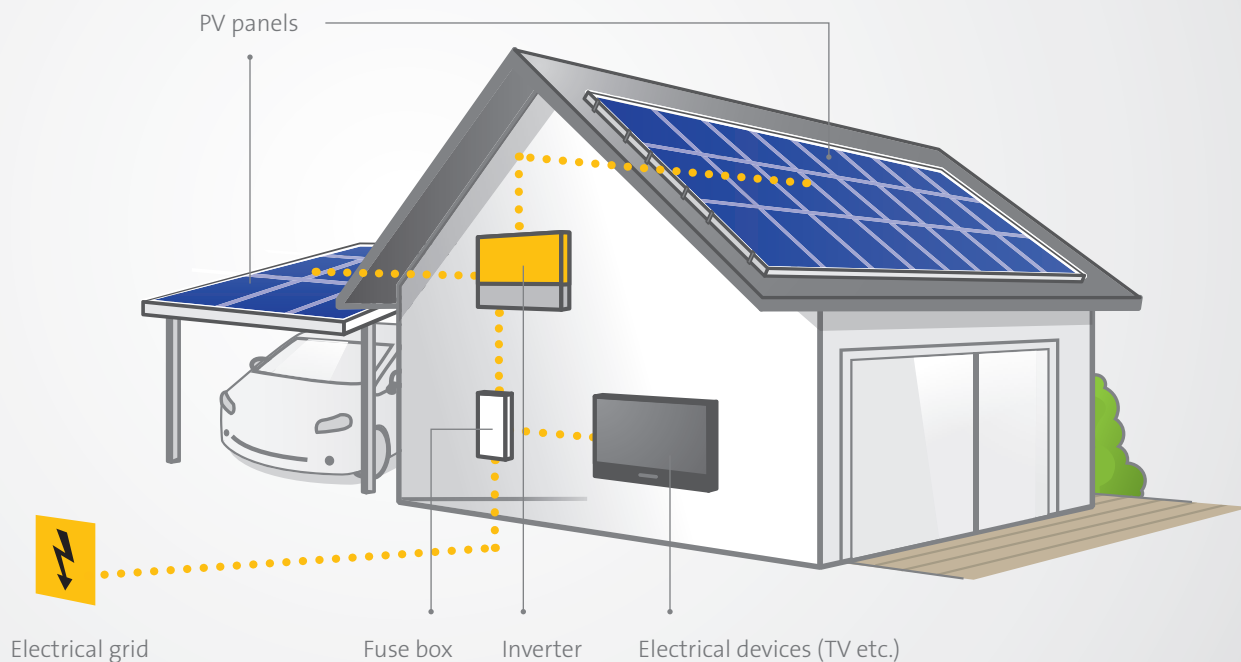

Powering homes and businesses

Current leaving a panel, or array of panels, passes through a wire conduit leading to an inverter. These devices, which are shaped like suitcases and come in various sizes, invert direct current, which flows with a fixed current and voltage, into alternating current, which flows with oscillating current and voltage. Appliances worldwide operate on AC.

From the inverter, the solar-generated power feeds into circuitry of a household, business or power plant and onto the region's electrical grid. A remote, or independent, power system also can form a self-contained circuit without connecting to the grid. The off-grid system, however, requires batteries to store power for times, such as night, when panels do not capture enough light energy from the sun.



GOOD FOR THE PLANET

* CO₂ emissions avoided over 25 years:

94 tons

* Equivalent miles not driven:

306,376

* Equivalent trees planted:

1.6 acres

* Based on a 3 kilowatt system in Southern California.



Environmental benefits

Solar panels reduce the amount of electricity coming from fossil fuels by supplying your home with clean, renewable energy from the sun. By providing more energy and lasting longer than other brands, SolarWorld Sunmodule™ panels are the best choice for cutting your carbon footprint down to size while maintaining a comfortable lifestyle.

SolarWorld Sunmodule panels are made from pure silicon, glass and aluminum. Our manufacturing processes avoid or minimize the use of toxic materials such as cadmium and arsenic, which are used in many low-grade thin film panels. SolarWorld factories strive to continuously improve these processes and lead the industry in sustainable manufacturing practices.

SolarWorld pioneered the high-yield process of recapturing the main components of silicon, glass and aluminum so that at the end of their useful lives Sunmodules can be reprocessed for reuse, instead of relegated to landfills. For products that can last more than 30 years, that's thinking ahead.

YOU ENTER THE EQUATION

PV technology is largely a U.S. original. But foreign ingenuity has grasped the industry's leadership by applying market mechanisms that jumpstart higher investment returns. Creating higher demand, these policies build economies of scale that force down pricing. But it takes people – you – to make choices for a better planet. Now the U.S. is reawakening to the promise of solar energy.



Solar energy's present

Grid parity – the point where energy costs the same whether from solar technology or fossil fuels – has arrived in many U.S. markets. It's about time, too. Though fossils have gotten us where we are today, they also have caused enormous environmental harms. The time has arrived to use slivers of rock – silicon – to reliably produce electricity for decades rather than burning up tons of rock and oil extracted from the Earth just one time.

To promote energy market competition, various government and nonprofit agencies offer an array of incentives for solar purchases. However, the cost of solar has already fallen so much that in some markets, those agencies are starting to phase out some incentives.



PV FACT

So how much power does a typical PV system produce – and at what cost? A modest rooftop system for a home might combine 1.5-3 kW in panels and produce the equivalent of about one-third of the home's power needs. In some locations, the ultimate costs to the system owners – figuring in all incentives – might amount to 30 cents on the dollar. In that case, a hypothetical system priced at \$25,000 actually would cost about \$7,500. Returns on investment in many cases exceed average typical interest on certificates of deposit.

Falling solar prices will cross rising prices of fossil fuels

With government incentives, then without, rising solar demand and falling unit pricing are leading to grid parity.

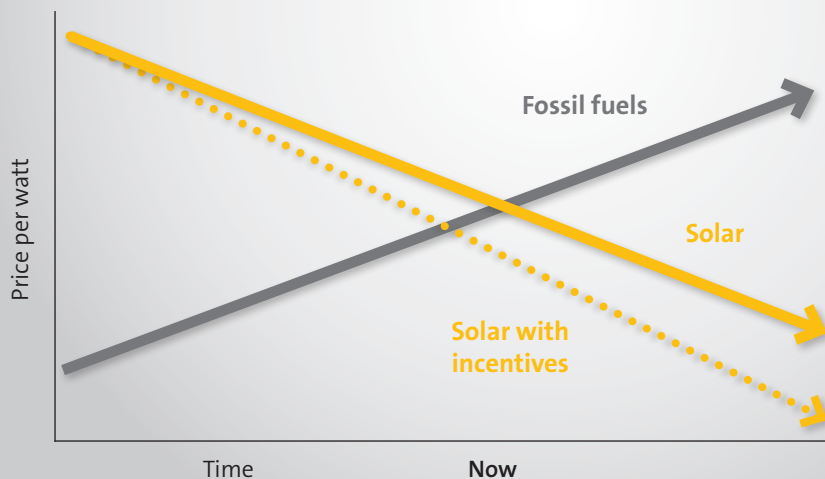

WORD TO KNOW

Insolation: Sunlight varies by region. Insolation is a measure of the solar radiation energy in a given region. It is usually expressed as the intensity of light energy per unit of land area. As a whole, the U.S., especially the sunny Southwest and Southeast, offers strong insolation. By comparison, Germany, the PV industry's leader, gets little better sun than Alaska.

Solar market incentives

Incentives vary among nations, states and even cities, but they typically fall into these categories:

Rebates: Some organizations distribute outright reimbursements for a portion of system costs.

Tax incentives: The U.S. government and several states may offer investment tax credits or accounting provisions allowing extraordinary terms for asset depreciation. On Jan. 1, 2009, for instance, the federal government removed a \$2,000 cap on a 30 percent credit for residential systems.

Net metering: This alternative to feed-in tariffs allows solar power producers to generate and use power with the same pricing and according to a single meter. When a home system, for instance, makes more power than it uses, its meter rolls backward.

Feed-in tariffs: Dozens of countries have implemented feed-in tariff systems – set premium rates that utilities are required to pay for power from solar systems. The rates remain fixed for a set number of years, perhaps 20. A power producer, such as a homeowner or business, separately pays normal market rates for power from the grid.

FOR ROOFTOPS AND BEYOND

These days, PV technology is extending beyond rooftops into locations that have never known the benefits of electricity. As on-grid applications bring cleaner power to wired homes, so, too, do off-grid systems empower those without electric refrigeration and lighting. Along the way, SolarWorld has led the world industry in rural electrification and sustainable practices.



Anywhere there's sky

While rooftop systems provide countless homes and businesses with power right where they most need it, such installations are far from the only kinds of PV projects harnessing photons.

Ground-mounted systems make sense where roofs are unavailable or inadequate. Panels are mounted on racks anchored into the ground.



Canopy systems can provide shelter and produce power in parking lots and exterior corridors.

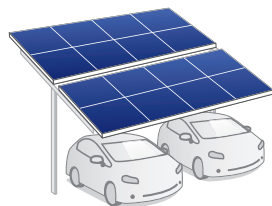

Utility-scale systems come in a variety of dimensions, but all produce enough electricity to power many buildings.



Tracker systems increase their output power by moving to follow the sun's path.





“Sustainable development is designed to lead to a situation where present generations can satisfy their own needs without jeopardizing the potential needs of future generations.”

Dr.-Ing. E. h. Frank Asbeck,
SolarWorld chairman and CEO



Recycling and reusing

SolarWorld has led the global PV industry in applying principles of sustainability.

Internally, SolarWorld uses residual and remnant silicon left in crucible bottoms or cut from ingots to reform crystal, and it strives in every imaginable direction to divert waste leaving its operations – plastic packaging, spent wire, even coffee cups – into second or new uses.

Externally, SolarWorld pioneered processes and practices for offering crystalline silicon photovoltaic recycling and helped spur the industry to develop recycling programs. The company accepts any returns of SolarWorld solar panels that otherwise might be discarded. Then, the panels undergo a high-yield process of recovering constituent materials for reuse.

A global vision

SolarWorld’s Solar2World program takes aim at the 2 billion people on the planet who go without electricity, a number that promises to rise with population growth. Working with local partners, the company donates its panels into rural electrification projects in some of the world’s poorest areas. With SolarWorld’s expansion in the United States, the Solar2World program there focuses on Latin America.

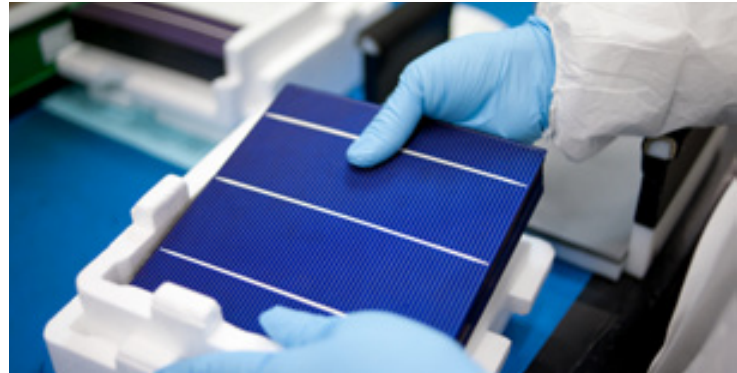
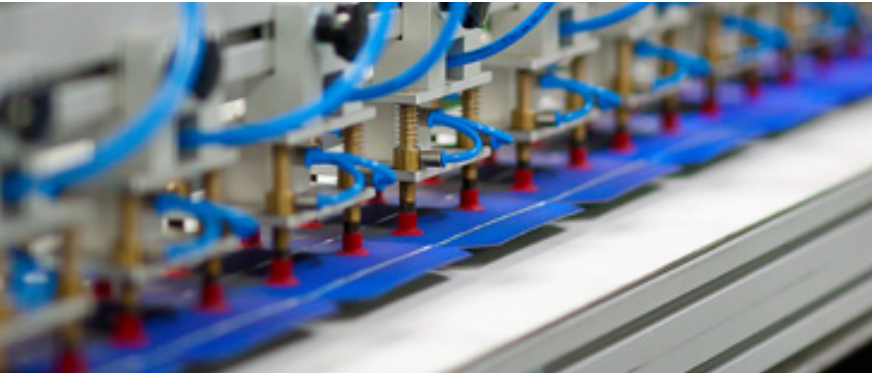

Benefits at a glance

> World-class quality

SolarWorld produces the highest-quality solar panels, manufacturing according to U.S. and German quality standards in fully automated ISO 19001 and 14001 factories.

> SolarWorld Plus sorting

Plus-sorting guarantees the highest system efficiency. Only the panels that achieve the designated nominal performance or more in performance tests are dispatched.

> 25-year linear performance guarantee and 10-year product warranty*

In addition to a 10-year product warranty, SolarWorld provides a 25-year performance guarantee that ensures an actual performance of at least 97 percent of the nominal power in the first year and an annual decrease of not more than 0.7 percent in each of the next 24 years.

> An experienced industry leader

With more than 35 years of experience in off-grid solar applications, SolarWorld delivers top products and technical experience at the highest levels. SolarWorld solar panels are installed in more than 100,000 telecommunications and industrial systems worldwide. No one else comes close.

* in accordance with the SolarWorld service certificate valid at the time of purchase | www.solarworld-usa.com/warranty

Locations:

SolarWorld Americas (Sales and marketing for USA, Canada, and South and Central America)

4650 Adohr Lane
Camarillo, CA 93012
Phone: +1 805 388 6200
Fax: +1 805 388 6395
customerservice@solarworld-usa.com

SolarWorld Industries America (U.S. headquarters)

25300 NW Evergreen Road
Hillsboro, OR 97124
Phone: +1 503 844 3400
Fax: +1 503 844 3403
customerservice@solarworld-usa.com



We turn sunlight into power.