

ARKANSAS VALLEY HORSE SHOW ASSOCIATION



2024 RULE BOOK

Table of Contents

BY-LAWS RULES AND REGULATIONS	5
NAME	5
PURPOSE	5
MEMBERSHIP	5
FEES	5
MEETINGS	5
BOARD OF DIRECTORS	6
OFFICERS	6
APPROVED SHOW	7
GENERAL SHOW RULES	7
RIDER AGE DIVISIONS	9
SHOW RESULTS	9
HIGH POINT AWARDS	9
ALL AROUND HIGH POINT AWARDS	10
HIGH POINT TIE BREAKER SYSTEM	10
JUNIOR AND SENIOR DIVISIONS	10
SHOW MANAGER	10
JUDGES	11
RINGMASTER	11
ANNOUNCER	11
OTHER SHOW PERSONNEL	12
FACILITIES	12
AMENDMENT OF BY-LAWS	12
STATE HORSE SHOW ASSOCIATION	12
APPROVED EVENTS	13
LEAD IN CLASS	13
BEGINNER WALK-TROT CLASS	13
BEGINNER BARRELS AND POLES	13
PEEWEE WALK-TROT	13
OPEN 11-49 WALK-TROT	13
50 + WALK-TROT	14
PONY WALK TROT	14

PONY UNDER SADDLE	14
BUCKAROO HORSEMANSHIP	14
YOUTH HORSEMANSHIP	14
ADULT HORSEMANSHIP	14
WESTERN PLEASURE	14
RANCH RIDING WITH PATTERN - YOUTH AND SENIOR	14
RANCH PLEASURE (RAIL ONLY) YOUTH AND SENIOR	15
JUNIOR HORSE PLEASURE	16
GAITED PLEASURE	16
LITE SHOD SLOW GAITED PLEASURE	17
HEAVY SHOD SLOW GAITED PLEASURE	17
OPEN HUNTER UNDER SADDLE	18
STAKE RACE	19
BARREL RACE	20
POLE BENDING	21
FLAG RACE	22
PONY SPEED	23
SPEED RACE	23
BARREL PICK UP	24
KEYHOLE RACE	25
REINING	25
REINING PATTERNS (ONLINE ONLY)	26
RANCH RIDING PATTERNS (ONLINE ONLY)	37

2020 OFFICERS AND DELEGATES

OFFICERS

President

Larry Brazil
Mobile#: 501-889-4134
E-mail: trigger2115@windstream.net

Co-President

Debbie Zinser
Mobile#: 501-977-6212
E-Mail: zinser@arbbs.net

Treasurer/Association Secretary

Toni Lancaster
Mobile#: 501-652-0730
Email: tml0804@gmail.com

Show Secretary

Debbie Zinser
Mobile#: 501-977-6212
E-Mail: zinser@arbbs.net

DELEGATES

Perry

Toni Lancaster
Mobile#: 501-652-0730
E-mail: tml0804@gmail.com

Debbie Zinser
Mobile#: 501-940-5809
E-mail: zinser@arbbs.net

Faulkner

Janice Thessing
Mobile#: 501-336-4471
E-mail:

Anita Mathes
Mobile#: 501-336-4292
E-mail:

Pope

Kenny Taylor
Mobile#: 479-567-1878
E-mail:

Ed White
Mobile#: 479-747-9730
E-mail:

ARKANSAS VALLEY HORSE SHOW ASSOCIATION

BY-LAWS RULES AND REGULATIONS

NAME

This Association shall be known as the Arkansas Valley Horse Show Association and shall at all times be operated and conducted as a non-profit organization in accordance with the laws of the State of Arkansas providing for such organizations, and by which all such rights granted to Associations of this kind.

PURPOSE

The purpose of this Association shall be to coordinate and encourage better horse shows; to prevent conflicting show dates; to set up and help regulate a standard of rules and regulations to be followed by all Association approved shows in this district; and to encourage good sportsmanship.

MEMBERSHIP

Membership in this Association is extended to horse clubs in the Central Arkansas area interested in the promotion of horse shows and willing to meet the requirements of this Association. Membership is contingent upon Board approval.

The Board of Directors shall have the power to drop from the roll, any club, which has failed to comply with the rules, by-laws, and regulations of this Association, or a club, which the Board thinks, has not given sufficient support to this Association's approved shows.

Members are required to sell 25 raffle tickets each show season to remain in good standing with AVHSA and to be eligible for State Show qualification and year end awards. Family membership=25 tickets, Individual membership=25 tickets.

All riders wishing to participate in year-end awards and the Arkansas State Horse Show must be a member in good standings of one of the participating clubs and the Association.

FEES

Dues to the Association must be paid each year before the first of March. These dues will be collected and paid by each riding club from their own membership. Dues must be submitted to AVHSA treasurer 1 week prior to show for member to be eligible for year end points and State show qualification. Additional assessments may be voted on as deemed necessary by the Board of Directors. State turn back money will go into the AVHSA treasury General Fund.

MEETINGS

The fiscal year of this Association shall be October 1 to September 30. The show season shall begin no earlier than April 1 and end no later than one week prior to the state show. The President of the Association will announce the time and place for the first meeting of the year and the Board of Directors will decide upon the dates and places of subsequent meetings. Special meetings may be called by the President or by a majority vote of the Board. In order for all members to be present at

a called meeting at a horse show, if the Board needs to take a vote on something other than an emergency for the show, it is to be announced at the beginning of the show.

BOARD OF DIRECTORS

The Board of Directors shall consist of two (2) representatives (voting delegates) from each club in good standing. Each representative must be at least 21 years of age, on January 1st. They shall be appointed by their clubs and shall serve until his or her successor is appointed. A club will have the right to send a substitute representative in the event their regular representative cannot attend a given meeting. The President of the Board will not be counted as a voting delegate.

The business and property of the Association shall be managed and controlled by the Board of Directors and its duly elected officers. A majority of the number of Directors shall constitute a quorum for the transaction of the business.

OFFICERS

Officers shall be elected at the final meeting of each fiscal year by a majority vote of the duly appointed representatives of each club in good standing. The Elected officers of the Association shall be the President, the Vice President, the Treasurer, and the Show Secretary. The President will appoint the Association Secretary.

PRESIDENT: The President shall be the chief executive officer of the Association and shall preside at all meetings of the Board of Directors. He or she shall see that the By-Laws, Rules, and Regulations of the Association are enforced and shall perform all other duties that may be prescribed from time to time by the Board. He or she shall vote only in the case of a tie.

VICE PRESIDENT: The Vice President, in the absence of the President, shall have the power and shall perform duties of the President, and have such other duties as may be prescribed by the Board of Directors.

ASSOCIATION SECRETARY: The Secretary shall keep the permanent records of the Association and the minutes of all its meetings, which shall be read, at the beginning of each meeting. He or she shall keep accurate membership records, including addresses and telephone numbers of each club's delegates, and shall handle all the administrative correspondence for the Association, including notices of meetings, rule changes, etc., whenever necessary.

TREASURER: The Treasurer shall receive all income for this Association and shall deposit it to the credit of the Arkansas Valley Horse Show Association in the bank of his or her choice. Disbursements shall be made by check upon itemized demands or by order of the Board, and an accurate record of all receipts and disbursements shall be kept in a manner permitting a clear report to be made at each meeting.

SHOW SECRETARY: The Show Secretary shall collect and keep all records of Association shows results including complete entry lists. Mail results to Show Secretary no later than Tuesday after each show. The Show Secretary will be responsible for furnishing all member clubs with the results after each approved show.

APPROVED SHOW

Clubs desiring to put on a horse show, which will be recognized by the Arkansas Valley Horse Show Association and which will include the awarding of points to the top five riders in each class must obtain the approval of the Board of Directors and meet the following requirements:

1. Be a member of one of the approved riding clubs and the Association in good standing with all dues paid;
2. Have a show date approved by the Board of Directors. Once the Association show dates are set at the beginning of the year, a date change must be brought up at one meeting and voted on at the following meeting. A majority vote is needed to change a date;
3. Agree to abide by all rules and regulations set forth by this Association;
4. Events adopted by the association may be scheduled in with mandatory events throughout the show.
5. Events shall be scheduled in the order prescribed by the Association which will provide an equitable rotation of all classes, except Lead In, Beginner Walk Trot, Walk Trot, Queen's, and Pony Under Saddle, which will be scheduled first at each show;
6. AVHSA will have a minimum of six shows.

GENERAL SHOW RULES

1. A rider may ride only one horse in each class. Each horse may have only one rider except in Beginner classes. In the speed events if you roll your time over for a double pointed show, no one else can ride that horse in the second show.
2. Riders in the Buckaroo and Junior age groups will not be allowed to show a stallion in any judged events, including Queen's Class and Pony Class; the only exception will be Junior Reining and speed events.
3. All riders must wear hats in judged events, except in gaited pleasure where hats for ladies are optional.
4. Numbers must be placed on both sides of the horse, attached to the saddle pad for all Western Pleasure events, Horsemanship and Reining. Hunter Under Saddle, Ladies and Men's Gaited may be worn on both sides of the pad or on the back of the rider.
5. No show is complete until all ties to fifth place have been worked off.
6. No exhibition rides will be made during a show, except classes approved by the board, but may be made after the show if arrangements are worked out with the sponsoring club.
7. Entry fees will not be refunded to a person pulling out of a class unless there is sickness or injury to rider or horse.
8. A rider in any event must ride with a saddle.
9. Riders wearing crop tops, muscle shirts, or any sleeveless garments will not be allowed to show. Tops must have sleeves and shirttails long enough to be tucked in. No cap or rolled up sleeves.
10. All contestants will wear boots, except for speed events where heel down type riding shoes will be allowed.
11. In case of a rain, if there are 10 or more classes remaining, these will be run the following day if at all possible, starting at 1:30 p.m. If not, the show will be scheduled at a later date and will be judged by the delegates. The books remain open.
12. Rain Out: The host club's President and 2 Delegates have the authority to call off a show because of rain until 8:00 am and notify the other club Delegates and the President of the Association so the judge can be notified by 8:00 am. If a show has to be called off after 7:00

am this task falls to the President of AVHSA and the Delegates. In the event of a rain out, AVHSA will pay for the judge to return and finish the show, or reschedule to a double point show.

13. If a judge fails to show up at a show, the show will be judged by the Delegates, or a club member selected by the Delegates. Two (2) Delegates will judge each class and their scores will be averaged out. A Delegate or a selected club member cannot judge a class in which a relative is competing.
14. Anyone moving up from Lead-In to Beginner Walk Trot or from Beginner Walk-Trot to Walk Trot cannot move back down and points accrued in the lower class will not count. All riders must ride in appropriate age division.
15. Entry fees for approved show events will be \$5.00 per entrant.
16. The contestant is responsible for errors on entry blanks and will forfeit any trophy and points awarded if later it is found he or she was ineligible for said event. A horse entered in the wrong class may be transferred to its correct class if discovered before the signup sheet goes to the announcers stand.
17. Any drug or medication administered internally or externally, which is of such character as could affect a horse's performance, is strictly forbidden and will result in disciplinary action by the Board.
18. Running horses or riding unmanageable horses in the vicinity of the arena where spectators and/or other horses and riders are located is strictly forbidden and will result in disciplinary action by the Board. Parents will be held responsible for the conduct of their children. It is permissible to work horses in an orderly manner at a safe distance from the arena area.
19. Any contestant or any immediate family member who, in the opinion of the Association Board, shall be declared guilty of misconduct or unsportsmanlike behavior during any Approved Show shall immediately be suspended from any other participation in said show. In addition, the Association can suspend such a person's right to participate in future Association Shows for such a period as deemed appropriate by the Board.
20. Every club secretary will furnish to the Association Secretary and Association Show Secretary a list of members in good standing in their club before the show season starts and update this list when new members join. For points to count toward year-end awards, the contestant's name must be on the list before the points are earned.
21. A current Coggins test (within 1 year of the show date.) will be required at all Arkansas Valley Horse Show Association approved shows.
22. In the event of a serious rule infraction, one member from each club (preferably a Delegate) will accompany the President to enforce the rule. The show may be stopped, if needed, to enforce this rule.
23. Barrels will be measured each time the arena is dragged unless barrels are staked.
24. **NO RIDER RESTRAINTS ARE ALLOWED IN SPEED EVENTS** except rubber bands on feet.
25. The use of headphones or any other communication devices on riders during class will not be allowed.
26. When signing up in the sign-in book you must sign up on the next available line.
27. Contestants must state on the signup sheet if there is to be a tack change.
28. Tack changes will be done at the back of the arena and there will be a (3) minute time limit.
29. When a Pleasure Class is called riders have three calls before the gate can be closed (the class sheet must be in the announcer's stand before the last call judged events). In Speed Events a rider has three calls before the rider is scratched and the next rider is called. Unless the rider is at the back of the arena making an attempt to enter.

30. No one is allowed to talk to the judge before or during a show. (Except: President of AVHSA, Club President from the Club having the show, and Club Members working the show.) The one thing that everyone should remember is the Judge is the official of the day and should receive the utmost respect.
31. Before any disciplinary action is taken by the Board all parties involved in the action shall have an opportunity to be heard by the Board, before the disciplinary action is voted on. This shall happen in a timely manner.
32. All Association members must represent only AVHSA at the Arkansas State Horse Show.
33. As a member of AVHSA all club members grant permission for their names, both adult and minor, to appear on the Web Site. (www.ArkansasValleyHorseShowAssociation.com)
34. No Tack Stalls are allowed at the Arkansas State Horse Show.
35. The use of mules, donkeys, burros, etc., in any event is not permitted.
36. Unless specifically addressed in the AVHSA Rule Book, the State Rule Book Rule is the guide.
37. Arena gate will be closed during the running of all speed events.
38. No club is allowed to place banners or any flapping material on the fencing or gates of the arena during and Arkansas Valley show date.
39. A rider who qualifies for state and doesn't attend must pay the entry fee to still be eligible for year end awards.

RIDER AGE DIVISIONS

(Age is determined on January 1st)

- Pee Wee Riders will be 10 and under.
- Buckaroo Riders will be 13 and under.
- Junior Riders will be 18 and under.
- Senior Riders will be 19 and over.

Riders must ride in only one age division when there are specific classes limited to their age division. (Example Junior Poles and Buckaroo Poles, Etc.) All riders must ride in their age division and cannot move up.

Ponies can be ridden in any age division unless otherwise specified.

HORSE AGE AND EQUIPMENT CONDITION

Junior horses that are shown with a bosal or snaffle bit may be ridden with two hands on the reins.

SHOW RESULTS

The results of any approved show must include all signup sheets and entries with their club affiliation, listing the top five riders in each class and shall be sent to the Show Secretary.

HIGH POINT AWARDS

The top five riders who are current Club and Association members of each class of an approved show shall receive points toward the High Point Awards in the following manner:

- 1st.....5 points
- 2nd.....4 points
- 3rd.....3 points
- 4th.....2 points
- 5th.....1 point

Points counted toward High Point Awards will be on the rider, not on the horse, and will only be credited to contestants who are active members of a club belonging to the Association at the time such points are earned.

At the end of the last approved show of the season, or shortly thereafter, the Association will present five place High Point Awards in each of the approved events to the five riders with the greatest number of accumulated points.

A person must ride in an event 50 percent of the shows in order to go to the state show and 70 percent to be eligible to receive their year-end high point award. If a person shows in two associations and qualifies in both, and they do not represent the AVHSA at the state show, they will not receive their year-end high point award for that year and they will not be eligible the next year. In the event a class does not have 5 qualified riders and a rider, who has not shown in 50 percent of AVHSA shows and shown in said event, may be considered to show at the State Horse Show. If a non-association rider places, his or her place points will be given to the next AVHSA Rider. When non-members are riding in pleasure events the judge will be asked to place enough riders to accommodate non-members.

ALL AROUND HIGH POINT AWARDS

All Around High Point Award will be awarded at the discretion of the AVHSA Board to the following age divisions, Pee Wee, Buckaroo, Junior, and Senior. Points will be calculated on an accumulative basis. Meaning, points earned by an individual, in an eligible class, will count toward the All Around High Point for that person in their age division.

- a. Lead In, all Beginner classes and non-State classes do not count toward All Around High Point.

HIGH POINT TIE BREAKER SYSTEM

All ties will be broken according to the following:

1. Most shows shown.
2. Most 1st, 2nd, 3rd, etc. that each rider has.
3. If a tie still exists after steps A & B a coin flip will break the tie. The rider with the first highest place will call the toss.

JUNIOR AND SENIOR DIVISIONS

Junior Division will consist of riders 18 years and under. Senior Division will consist of riders 19 years of age and older. Age is determined by person's age on January 1. (Junior riders must ride in their division, except in events which are open to all ages.)

In the event that a question arises on the age of a rider any time during the year, the Association can ask that birth certificates be furnished and all awards shall be held until proof of age is established.

SHOW MANAGER

The show manager shall be held responsible by the Association for enforcing all the Association's Rules and Regulations. He or she shall be the person in charge of the show. The manager shall be responsible for the maintenance of a clean and orderly show and enforce the starting time of the show as well as coordinate and expedite the movement of classes to the best of his or her ability. Before the show date, the Show Manager should make arrangements for having programs printed and some distributed to other clubs and preparing entry sheets which should contain places for name, age (except Seniors), club affiliation and/or town if a non-club member, and making

arrangements for having trophies at the show on time. The Association is responsible for obtaining the following personnel: Ringmaster/ Arena worker, Announcer /Time Keeper, Show Secretary, Sign up table worker, Gate/ Arena worker, and someone to collect gate fees from anyone entering the show and check Coggins papers.

The Show Secretary of the Association shall be responsible for collecting the results of the show.

JUDGES

Judges must be chosen from a list furnished by this Association. Neither the Judge nor member of his family may exhibit or act as agents or handlers of a horse in any class at a show where he/she is officiating. A Judge may order any person or horse from the arena for bad conduct of one or both. The Judge shall have the authority to place a horse and rider in whatever position he thinks is justified, and his decision shall be final. His authority shall be limited to decisions involving the merits of the horses and riders being judged. The Show Manager shall have the sole authority to enforce decisions involving the Rules and Regulations of the Association. The Judge may use the sifting method when class consists of 15 or more horses.

The Judge should not visit with any of the exhibitors or spectators prior to or during the show. Any conversation with the Judge should be done after the show, not prior to the show or during the show. The judge will be notified of this when contacted to judge the show.

No horse may be shown under a Judge if that Judge has been owner, trainer, or conditioner of that horse within the previous six months. If such a horse is entered in a show, its entry fee shall be refunded and it will not be exhibited. A judge may be suspended from the list of approved judges for infraction of this rule or by a majority vote of the Board of Directors of the Association.

RINGMASTER

A competent Ringmaster shall be required at all approved shows. He or she should be familiar with show procedure and etiquette. It shall be the Ringmaster's responsibility to check the qualifications as to the eligibility of each horse or pony in each event before the rider enters the ring and to excuse any ineligible riders before the judging begins. The Ringmaster shall make sure that no person rides more than one horse, or that no horse is ridden by more than one rider in any approved performance class.

By assembling the class promptly, the Ringmaster will be able to keep the judging program on schedule and eliminate delays between classes. He will notify the judge when all horses are present for the class. He will carefully refrain from advising or discussing the horses or riders with the judge.

The Ringmaster has charge of the activity in the arena. He should act as mediator between the Judge and the Announcer. He must not allow the horses to crowd up in the arena and at all times endeavor to keep the possibilities of an accident to a minimum. He has the authority to ask a rider to remove his horse for the safety of other horses, riders or spectators.

ANNOUNCER

The Announcer should give notice of approaching classes and any empty classes that will be canceled to help expedite the show, including having entrants ready to go three deep in the timed events. The Announcer should keep children away from the fence during the classes. He should be familiar with and announce the eligibility requirements of each class before the entrants start into the arena.

Announcer must keep his/her attention on the Ringmaster at all times during performance classes so as to promptly announce directions for the riders.

OTHER SHOW PERSONNEL

It is important that those responsible for taking entries be familiar with the eligibility requirements of the classes and be provided with proper entry forms containing places for name, age (except Seniors), and club affiliation, if any. (Entries must be paid and signed up before entry sheets are sent to the Announcer's stand at the end of the preceding class.)

It will be necessary to have at least two Arena helpers to help set up barrels, poles, and other markers for the events requiring such props and for removing them as necessary.

Unless otherwise specified, current AQHA rules will apply to those classes not covered in the AVHSA Rule Book.

FACILITIES

Show facilities should meet minimum safety standards deemed appropriate by the Board of Directors. Any club failing to comply will be subject to disciplinary action by the Board.

Each club must see that there are adequate toilet facilities on the show ground where an approved show is held.

AMENDMENT OF BY-LAWS

These By-Laws may be amended, repealed, or altered after being proposed at one meeting of the Association Board of Directors and voted on at the next meeting.

These By-Laws, Rules, and Regulations were accepted originally on 6/21/73. They were revised on 3/18/75, 4/5/82, 3/15/83, 4/3/85, 4/7/87, 3/8/89, 3/2/92, 3/12/93, 2/7/94, 2/6/95, 3/2/98, 3/1/99, 3/6/00, 3/3/03, 2/2/04, 2/28/05, 2/5/07, 2/25/07, 1/14/08, 1/9/09, 1/11/10, 1/6/11, 2/15/12, , 2013, 2014. 01/05/15, 3/3/18, 3/12/19, 3/20/20, 3/30/21, 3/25/24.

STATE HORSE SHOW ASSOCIATION

It should be noted that the AVHSA joined the Arkansas State Horse Show Association in January 1974. It is policy of the AVHSA Board of Directors to adopt and follow the rules and regulations of the State Association. Each year these are reviewed as they are changed or added to by the State Association. Ours will automatically change as the State Association Rules change. Each time the State Association adds or deletes new events to its approved list, the Board of AVHSA will add or delete those events deemed appropriate for our particular Association.

Each year in September, the State Association puts on a Championship Horse Show. The top five riders in each event from each of the member Associations are eligible to compete in this show. The Association must pay for five places in each event whether five people participate or not. In the event one of the top five riders is unable to go to state, substitution will be permitted moving first to 6th place and then to 7th place. Substitutions will not go beyond 7th place. Each Association must pay for assigned stalls in advance of State Show along with all entry money for participants in the Show.

Individual clubs shall be responsible for processing all forms for their entrants to the state show. Individuals shall pay their entry fees and stall fees for the state show to their respective clubs, not to AVHSA. Club Delegates or their designee shall ensure that all properly completed forms and fees in the form of a club check are forwarded to the AVHSA.

WORKERS

Announcer: Will announce the show. Keep all records.

Arena Gate Worker: Will work the gate and help with set up & break down of events in the arena.

Tractor Driver/Arena Setup Worker: Will do all drags/disc work during the show and help with setup / break down of events in the arena.

Sign Up Table: Will sign people up and collect money for each event.

Arena Setup Worker/Ring Steward: Will help the judge with ring steward duties and help with setup / breakdown of events in the arena (poles, barrels, cones /etc.)

Other duties may be added as determined by the Association Board.

APPROVED EVENTS

LEAD IN CLASS

Age 6 and under. Any size horse. To be judged 50% on appearance, 30% on horsemanship, and 20% on the horse.

BEGINNER WALK-TROT CLASS

Age 10 and under. Any size horse. The horse will be judged at a walk and a trot and will not be asked to back. Except for those considerations the class will be judged as a Western Pleasure Class. A child entering either of these classes cannot enter in any other judged event.

BEGINNER BARRELS AND POLES

The rules for Beginner Barrels and Poles will be the same as in the Barrel Race and Pole Race with these exceptions. The age limit for Beginner Barrels and Poles is 12 and under. A horse or pony may be ridden by more than one rider. A rider must be able to sit alone on a horse or pony. A rider may not be tied or secured to a horse or pony in any manner. The rider and his/her horse/pony may be led through the pattern. A contestant riding one or both of these events Can Not enter in any other speed event except as a jumper in Open Barrel Pick-Up. In the event that a rider moves up to another speed event, the points in these classes will be null and void and the rider will not be able to ride in these classes for the remainder of the show season.

PEEWEE WALK-TROT

The rider will be ten years old or younger, and the horse must be over 54" in height. The horse will be judged at a walk and a trot and will not be asked to back. Except for these considerations the class will be judged as a Western Pleasure Class.

OPEN 11-49 WALK-TROT

The rider will be 11 years old or older, and the horse must be over 54" in height. The horse will be judged at a walk and a trot and will not be asked to back. Except for these considerations the class will be judged as a Western Pleasure Class.

50 + WALK-TROT

The rider will be 50 years old or older, and the horse must be over 54" in height. The horse will be judged at a walk and a trot and will not be asked to back. Except for these considerations the class will be judged as a Western Pleasure Class.

PONY WALK TROT

Ponies 54" and under. Association president to ensure each pony is within size limit before sending entries to State. Rider must be 10 years old or younger.

PONY UNDER SADDLE

Ponies 54" and under. Association president is to ensure each pony is within size limit before sending entries to State. Ponies are not required to back. AQHA rules will apply. Must be shown with one hand at State.

BUCKAROO HORSEMANSHIP

Age 13 years and under. Horses and ponies are allowed. No rail work will be done. Pattern only. AQHA rules will apply. Pattern must be posted at least thirty (30) minutes prior to class.

YOUTH HORSEMANSHIP

Age 14-18 years. Horse must be over 54". AQHA rules will apply. Pattern must be posted at least thirty (30) minutes prior to class.

ADULT HORSEMANSHIP

Any 19 and older. Horse must be over 54". AQHA rules will apply. Pattern must be posted at least thirty (30) minutes prior to class.

WESTERN PLEASURE

Horse must be over 54". AQHA rules will apply. Only one had may be used unless otherwise specified.

BUCKAROO: 13 years and under.

JUNIOR: 14 to 18 years.

LADIES: 19 years and older.

MEN: 19 years and older.

RANCH RIDING WITH PATTERN - YOUTH AND SENIOR

Horse must be over 54". Points in this class will apply to the riders' ages according to the age divisions listed in this rulebook.

1. The Ranch Riding horse should reflect the versatility, attitude, and movement of a working horse.
2. The horse's performance should simulate a horse riding outside the confines of an arena and that of a working ranch horse. This class should show the horse's ability to work at a forward, working speed while under control by the rider. Light contact should be rewarded and horse does not have to be shown on a full drape of reins. The overall manners and responsiveness of the horse while performing the maneuver requirements, and the horse's quality of movement are the primary considerations.

3. Requirements:
 - a. No Horse less than 3 years of age.
 - b. Horses will work collectively in the arena on the pattern, no rail work will be performed.
 - c. The required maneuvers will include pattern 1-5 which will be chosen each week.
 - d. The overall cadence and performance of the gaits should that of a ranch riding horse, with an emphasis on forward movement, free-flowing, and ground covering for all gaits. Transitions should be performed where designated, with smoothness and responsiveness.
4. Apparel and Equipment:
 - a. No hoof polish.
 - b. No braided or banded manes or tail extensions.
 - c. Trimming inside ears is discouraged.
 - d. Trimming bridle path is allowed, also trimming of fetlocks or excessive (long) facial hair.
 - e. Equipment with silver should not count over a good working outfit. Silver on bridles and saddles is discouraged.
 - f. Protective boots, leg wraps, and bandages are allowed.
 - g. No nosebands or tie-downs.

RANCH PLEASURE (RAIL ONLY) YOUTH AND SENIOR

Horse must be over 54". Points in this class will apply to the riders' ages according to the age divisions listed in this rulebook.

1. The Ranch Riding horse should reflect the versatility, attitude, and movement of a working horse.
2. The horse's performance should simulate a horse riding outside the confines of an arena and that of a working ranch horse. This class should show the horse's ability to work at a forward, working speed while under control by the rider. Light contact should be rewarded and horse does not have to be shown on a full drape of reins. The overall manners and responsiveness of the horse while performing the maneuver requirements, and the horse's quality of movement are the primary considerations.
3. Requirements:
 - a. No Horse less than 3 years of age.
 - b. Riders will be asked to do rail work such as walk, jog, and lope both directions: and the extended jog and lope at least one direction, at judge's discretion; as well as stop, reverse, and back.
 - c. The overall cadence and performance of the gaits should that of a ranch riding horse, with an emphasis on forward movement, free-flowing, and ground covering for all gaits. Transitions should be performed where designated, with smoothness and responsiveness.
4. Apparel and Equipment:
 - a. No hoof polish.
 - b. No braided or banded manes or tail extensions.
 - c. Trimming inside ears is discouraged.
 - d. Trimming bridle path is allowed, also trimming of fetlocks or excessive (long) facial hair.
 - e. Equipment with silver should not count over a good working outfit. Silver on bridles and saddles is discouraged.
 - f. Protective boots, leg wraps, and bandages are allowed.
 - g. No nosebands or tie-downs.

JUNIOR HORSE PLEASURE

1. No horse older than five years of age during the current calendar year shall be allowed to participate.
2. Age of horses entered will be the responsibility of respective association presidents and will be checked only on protest. A veterinarian will be present during this class to settle any age dispute, and his decision will be accepted as final.
3. If horses are ridden with Bosal or a snaffle bit, horse may be shown with two hands.

GAITED PLEASURE

1. S.H.O.W. rules **6B** (Show Pleasure) will apply with the following exceptions.
2. This class is open to all gaited horse breeds.
3. Braids are optional for this class.
4. Shoeing of the horse is allowed, as permitted by the HPA and SHOW regulations.
5. A rest period not to exceed 10 minutes will be allowed for the last work off.
6. Horse is to be shown at a walk and favorite gait. Horse will enter the arena at a walk.
7. English or western equipment may be used.
8. The class will be judged on the performance and conformation of the horse at the discretion of the judge
9. The wearing of hats is optional for the ladies; the wearing of hats is mandatory for men.
10. One or both hands may be used on the reins.
11. Gaited horses will not be asked to back.
12. Beginning the 2005 State Show a DQP will be used to check all gaited horses prior to being shown in their class.
13. Bits with shanks in excess of 9 1/2" in length are prohibited. Shanks are measured from the very top of the metal to the very bottom of the medal including the rings to which the cheeks and reins are attached. See diagram B1.
14. Time outs will be governed by S.H.O.W. rule **F-10** (SHOW Rule Book Judges Section)
15. Required Gaits for Gaited Pleasure:
 - a. **Flat Walk (Walk):** The flat walk should be bold and four-cornered with an evenly timed 1-2-3-4 beat. In the flat walk the horse should break at the knees, reaching and pulling with the front legs with that movement originating from the shoulder. The horse should have impulsion and exhibit stride and drive with the hind legs. There should be no wringing or twisting of the hocks, nor any excessive hock action. The horse should demonstrate a loose way of going with plenty of motion. Over stride is important but should be in accord with the conformation and length of the back and legs of the horse. A horse with a good flat walk will naturally have a straight, up and down head motion timed with the overall rhythm of the walk.
 - b. **Running Walk (Favorite Gait):** The running walk has the same beat or evenly timed footfall (1-2-3-4) as the flat walk but is much smoother with greater stride, rhythm and natural motion. The increased rear leg stride and increased reach in the shoulder create this smoother ride and propel the horse at a faster speed without changing the cadence of the leg motion. As with the flat walk, the horse will naturally have a straight up and down vertical head motion timed with the overall rhythm of the running walk. A correctly performed running walk is truly a gait of ease, producing a clearly heard and easily counted 4-beat tempo.

16. S.H.O.W. rules 3-D (General Requirements and Equipment for Horses) will apply, except rule number 5; no communication devices may be used.

LITE SHOD SLOW GAITED PLEASURE

1. S.H.O.W. rules **5-D** (Country Pleasure) will apply with the following exceptions.
2. This class is open to all gaited horse breeds and no preference will be given to one particular gait.
3. Riders must wear and use western tack only. One or both hands may be used on the reins.
4. No whips, crops, or nose bands
5. Cavessons allowed with two fingers of relief under Cavesson, no cross chain Cavessons.
6. Horses in Lite Shod Slow Gaited will not be asked to back.
7. Beginning the 2005 State Show a DQP will be used to check all gaited horses prior to being shown in their class.
8. Horse is to be shown at a walk and favorite gait. Horses will enter the arena at a walk.
9. Shoeing of the horse is allowed as permitted by the HPA and SHOW regulations. Shoes will be steel-to-hoof (flat shod). Shoe may be attached to the foot with shoeing adhesive. Horses will be shod with the frog exposed. Maximum $\frac{3}{8}$ " thick X 1" wide stamped (poured or cast) hot or cold roll steel or aluminum keg shoe is allowed (both front and hind feet).) Poured or Cast Clips, if poured in the original cast. Poured or cast heels, (caulks) if poured in the original cast (may not be welded on) Borium is allowed on the toe (1 $\frac{1}{2}$ " wide at the toe and spots on heels no more than $\frac{1}{8}$ " thick). Hoof bands are prohibited.
10. Any standard horse bit may be used, except for gag bit with no shanks.
 - a. Bits with shanks in excess of 9 $\frac{1}{2}$ " in length are prohibited. Shanks are measured from the very top of the metal to the very bottom of the medal including the rings to which the cheeks and reins are attached. See bit diagram B1.
11. Required Gaits for Lite Shod Slow Gaited Pleasure:
 - a. **Walk:** This is a smooth slow four-beat gait that should be performed in a very relaxed manner. The horse should be alert, but not nervous. Animation is not desired in this gait.
 - b. **Favorite Gait:** This gait is to be performed at moderate speed where the horse extends its stride and covers more ground with each step and can be a variation of any gaited horse breed; with no preference given to any particular gait over another. The gait should be consistent and balanced and should appear easy and comfortable to ride. **Excessive speed and excessive animation is not desirable and will be penalized.**

Note: Animation is defined as high front knee action

HEAVY SHOD SLOW GAITED PLEASURE

1. This class is open to all gaited horse breeds and no preference will be given to one particular gait.
2. Riders must wear and uses western tack only. One or both hand may be used on the reins. Horse will be shown with split reins and with two (2) reins. No colored brow bands or ribbons are permitted; Nosebands of the western type, this noseband may have silver on it. Cavessons are allowed, cross chain cavessons are prohibited. Exhibitors are expected to present themselves in a professional manner.
3. Horse in Heavy Shod Slow Gaited will not be asked to back.

4. Horses to be shown at a Show Walk and Favorite Gait. Horses will enter the arena at a Show Walk.
5. Shoeing of the horse is allowed as permitted by the HPA and SHOW regulations. Shoes will be steel to hoof (flat shod). Shoe may be attached to the foot with shoeing adhesive. Horses will be shod with the frog exposed. Minimum shoe size $\frac{1}{2}$ " thick and 1" wide with the Maximum being $\frac{1}{2}$ " thick and 1 $\frac{1}{2}$ " wide. Hoof band are allowed and must meet HPA and SHOW regulations.
6. Any standard horse bit may be used, except for gag bit with no shanks.
 - a. Bits with shanks in excess of 9 $\frac{1}{2}$ " in length are prohibited. Shanks are measured from the very top of the metal to the very bottom of the medal including the rings to which the cheeks and reins are attached. See bit diagram B1.
7. Required Gaits for Heavy Shod Slow Gaited Pleasure:
 - a. **Show Walk:** This is a smooth four-beat gait that should be performed in a relaxed manner. The horse should be alert, but not nervous.
 - b. **Favorite Gait:** This gait is to be performed at moderate speed where the horse extends its stride and covers more ground with each step and can be a variation of any gaited horse breed; with no preference given to any particular gait over another. The gait should be consistent and balanced and should appear easy and comfortable to ride.

Diagram: B1

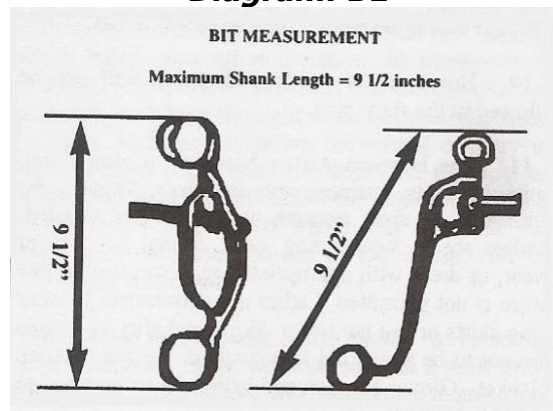

OPEN HUNTER UNDER SADDLE

1. AQHA rules will apply. Points in this class will apply to the riders' ages according to the age divisions listed in this rulebook.
2. Horses to be shown under saddle, not to jump.
3. Hunters under saddle should be suitable to purpose. They should move in a long, low frame and be able to lengthen their stride and cover ground, as in traversing hunt country following hounds. They should be obedient, alert and responsive to their riders. Quick, short strides should be penalized. Horses, which move in an artificial frame and are over flexed and behind the bit should also be penalized. Horses should be serviceably sound. Judges should emphasize free movement and manners. This class will be judged on the performance, condition and conformation of the horse; however a minimum of 20 percent of the judging shall be based on condition and conformation.
4. Horses are to be shown at a walk, trot and canter both ways of the ring. Horses should back easily and stand quietly.

- Horses may change gaits at the flatfoot walk or the trot at the judge's discretion. Light contact with the horse's mouth is recommended.
- In all English classes, exhibitors and judges should always bear in mind that; entries are being judged on ability rather than on personal attire. However, riders should wear hunt coats of traditional hunt seat style and conservative color, breeches of traditional shades of buff, gray or rust (or jodhpurs), high English boots or jodhpur shoes. Black, navy blue or brown hunting cap is mandatory. A tie or choker is required. Spurs of un-roweled type, crops or bats are optional. Hair must be neat and contained (as in a net or braid). Judges must penalize contestants who do not conform.

STAKE RACE

- This is a timed event.
- The start/finish line is 30 feet (9.15 m) wide and marked by two upright markers (cones or pylons) short enough to not interfere with the timer if one is used. Short pylons or cones are recommended.
- There are two stakes in the event. The stakes shall be 80 feet (24.38 m) apart. The first stake shall be 21 feet (6.4 m) from the start/finish line and the second stake shall be 101 feet (30.78 m) from the start/finish line if arena size permits. The pattern may be shortened depending upon arena size permits. The pattern may be shortened depending upon arena size; however the two stakes must always be placed 80 feet (24.38 m) apart, regardless of the distance between the first stake and the start/finish line.
- Exhibitor shall cross the start/finish line and run down the right side or left side of the poles to the second pole making either a right or left-hand turn. Exhibitor shall then run back to the second pole and repeat first turn then run straight back down either the left or right side of the poles (opposite side than when first crossing start line and running to second pole) and cross the start/finish line.
- A no-time is given if either of the upright poles or either of the two upright markers are knocked down.
- An exhibitor may not walk through the course in order to qualify for a placing position nor in the run-off for a tie.

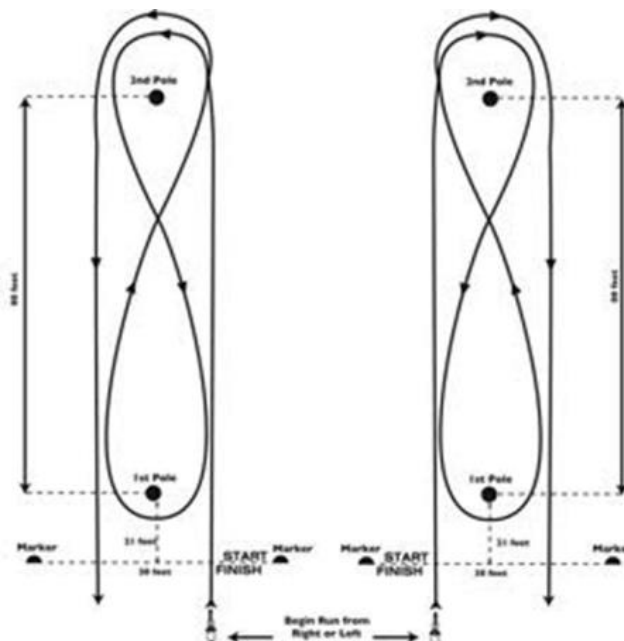

BARREL RACE

1. AQHA rules will apply except concerning wearing apparel of the riders.
2. Horses and rider may enter from either side as long as pattern is not broken and exit is made between two front barrels.
3. No barrel shall be placed closer than 15 feet from the fence.
4. Knocking over a barrel will result in disqualification.
- 5.
6. Touching of the barrel by rider is permissible.
7. If a rider makes a qualified run in this event and the timer fails to work properly, the rider must make a bona fide attempt in the re-ride and will receive time even though a barrel is knocked down. NOTE: Deliberate and intentional knocking down of a barrel in order to receive a faster time will not be tolerated, and the decision of the judge will be final.
8. In the event of timer failure, a contestant may have his choice regarding time for his re-ride. He/She may run immediately, or the rider may run at the end of the event. If he/she should be the last rider in the event when the timer fails, he/she will be given five (5) minutes to rest his/her horse.
9. Pee Wee riders 10 and under who ride ponies will ride in Pony Barrels only,. Pee Wee riders 10 and under who ride horses over 54" will ride in Buckaroo Barrels only; but cannot ride in both.

BUCKAROO: 13 and under, any size horse

JUNIORS: 14 to 18, any size horse

SENIORS: 19 and over, any size horse

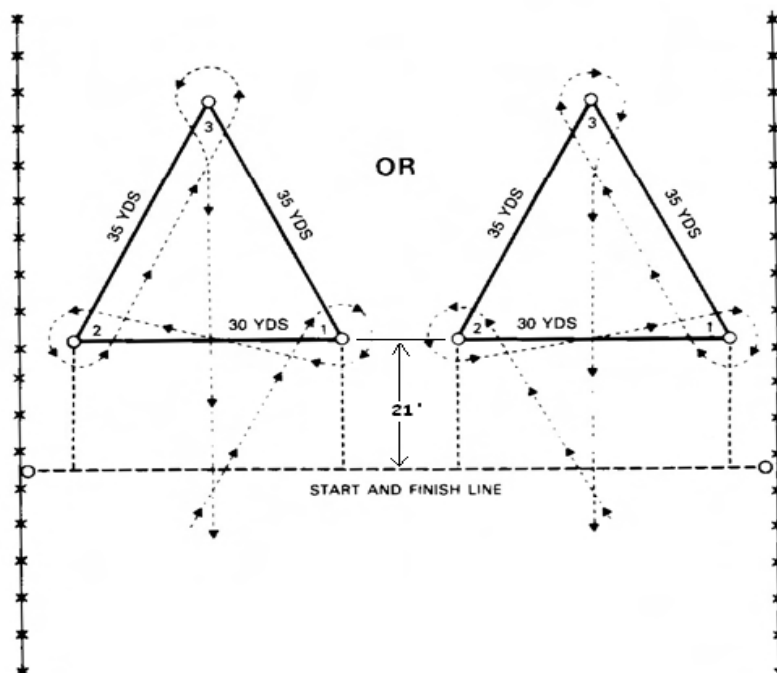

POLE BENDING

1. AQHA rules will apply except concerning wearing apparel of the riders.
2. The pole bending pattern is to be run around six (6) poles. Each pole is to be twenty-one (21) feet apart, and the first pole is to be at least twenty-one (21) feet from starting line with the last pole at least twenty (20) feet from the fence.
3. Failure to follow the pattern shall cause disqualification. If pole is knocked over, rider will be disqualified.
4. Touching of pole by a rider is permissible and will not result in disqualification.
5. If a rider makes a qualified run in this event and the timer fails to work properly, the rider must make a bona fide attempt in the re-ride and will still receive time even though a pole is knocked over. NOTE: Deliberate and intentional knocking over a pole in order to receive a faster time will not be tolerated, and the decision of the judge will be final.
6. Re-ride time due to timer failure same as barrel race, rule number seven.
7. Pee Wee riders 10 and under who ride ponies will ride in Pony Poles only. Pee Wee riders 10 and under who ride horses over 54" will ride in Buckaroo Poles only; but cannot ride both.
BUCKAROO: 13 and under, any size horse
JUNIORS: 14 to 18 any size horse
SENIORS: 19 and over, any size horse.

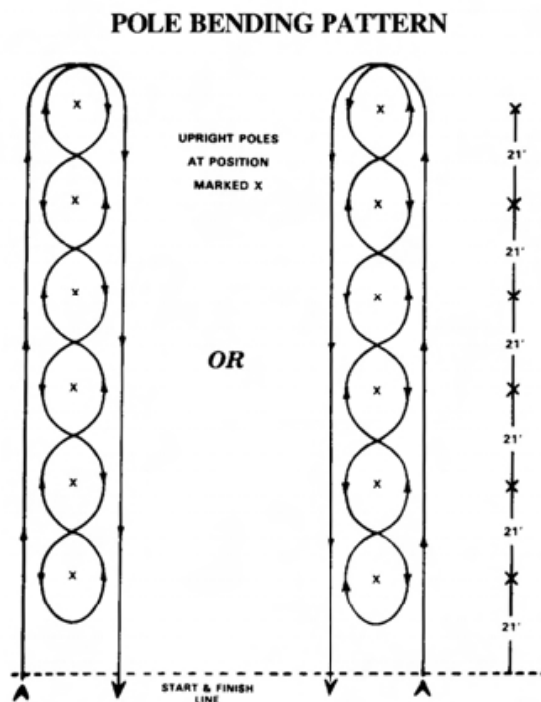

FLAG RACE

1. Flags will be 18" long with 8x9" cloth flag. Soft wood of a one (1) inch dowel rod should be used. Flag may be used as a quirt. Flagstick shall be marked three (3) inches above the bottom. Flag will be sharpened.
2. Buckets will be five (5) gallon size filled to within three (3) inches of top with masonry sand.
3. Buckets shall be placed to the inside of barrel. The flag for pick up shall be placed at the inside edge of the bucket.
4. Upon completion of ride, barrels and buckets must be standing upright. Flag must be stuck inside bucket.
5. If any barrel or bucket is knocked over, rider will be disqualified.
6. If a rider makes a qualified run in this event and the timer fails to work properly, the rider must make a bona fide attempt in the re-ride and will still receive the time even though the rider fails to stick the flag. NOTE: Deliberate and intentional illegal procedures executed in order to receive a faster time will not be tolerated and the decision of the judge will be final.
7. Re-ride time due to timer failure same as barrel race, rule number seven.
8. End barrel must be set in same position as for barrel race.
9. Barrels may be moved back or forward a certain distance to alleviate area around the barrels becoming dug out and dangerous.
10. Judge will place flag in pickup bucket.

Pony: 10 and under, pony 54" and under
Juniors: 18 and under, any size horse.
Seniors: 19 and over, any size horse

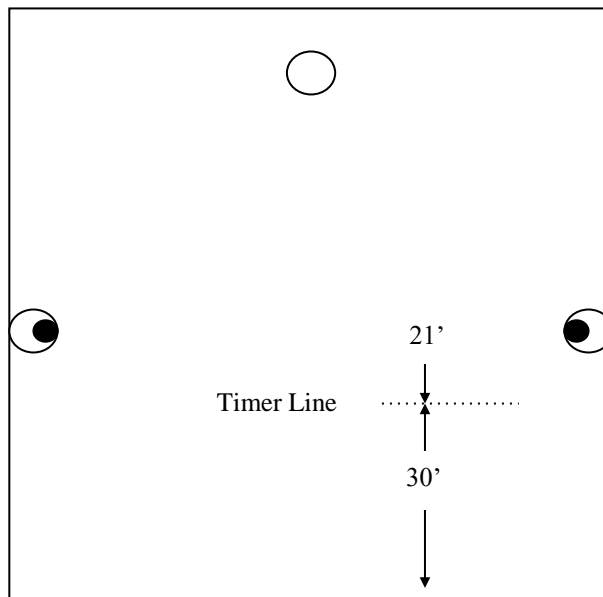

PONY SPEED

1. Rider will be disqualified if barrel is knocked over during run.
2. If a rider makes a qualified run in this event and the timer fails to work properly, the rider must run again, making a bona fide attempt in the re-ride to receive a time. NOTE: Deliberate and intentional illegal procedures executed in order to receive a faster time will not be tolerated and the decision of the judge will be final.
3. Re-ride time due to timer failure same as barrel race, rule number seven.

AGE: 10 YEARS OLD OR YOUNGER
PONY ONLY- 54" AND UNDER

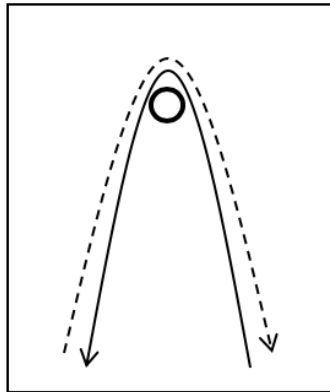

SPEED RACE

4. Rider will be disqualified if barrel is knocked over during run.
5. If a rider makes a qualified run in this event and the timer fails to work properly, the rider must run again, making a bona fide attempt in the re-ride to receive a time. NOTE: Deliberate and intentional illegal procedures executed in order to receive a faster time will not be tolerated and the decision of the judge will be final.
6. Re-ride time due to timer failure same as barrel race, rule number seven.
 - Pony: 10 and under, pony only 54" and under
 - Juniors: 18 and under, any size horse.
 - Seniors: 19 and over, any size horse.

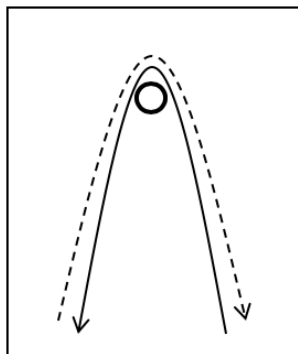

BARREL PICK UP

1. A contestant may enter only one time in this class, either as a rider or as a jumper, but not as both.
2. This race is to be run with a barrel at the opposite end of the arena. The barrel must be a least 20 feet from the fence, and the rider may ride to the right or left, circling the barrel.
3. For safety of riders in this class, the barrel is moved ten feet if necessary and is to be left to the discretion of the show manager.
4. The starting line should be at least 20 feet inside the arena.
5. The jumper must mount from the barrel and must be astride of the horse at the finish line.
6. Person being picked up must mount unassisted. Use of rider's hands at any time during the ride is not allowed and will result in disqualification.
7. If jumper touches the ground, it will be a disqualification and jumper must exit arena on foot.
8. Judge is to be on the ground back of the barrel so as to have a better view.
9. If a rider makes a qualified run in this event and timer fails to work properly, the rider must run again, making a bona fide attempt in a re-ride to receive a time. NOTE: Deliberate and intentional illegal procedures executed in order to receive a faster time will not be tolerated and the decision of the judge will final.
10. Re-ride time due to timer failure same as barrel race, rule number seven.
11. Open to all ages, any size horse.

Barrel Pick-up Pattern

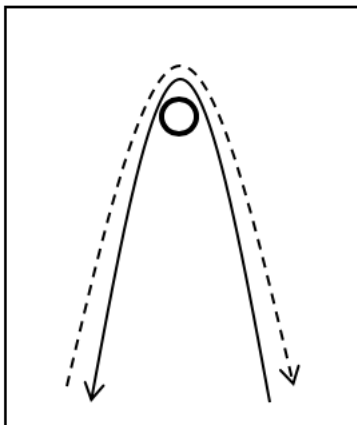

KEYHOLE RACE

1. Keyhole shall consist of a 12-foot circle with a 10 foot long by 5-foot wide throat (10'x5').
2. Horse may enter pattern with flying start. This is a timed event. Keyhole used will be outlined in white lime. Horse will follow directions as indicated in pattern diagram.
3. Horses must turn in circle not in throat or approach to circle.
4. If a horse steps in or over the line, it will be disqualified and no time will be given on the rider.
5. Judge must stand behind the keyhole or to the side at a safe distance.
6. If a rider makes a qualified run in this event and the timer fails to work properly, the rider must run again, making a bona fide attempt in the re-ride to receive a time. NOTE: Deliberate and intentional illegal procedures executed in order to receive a faster time will not be tolerated and the decision of the judge will be final.
7. Re-ride time due to timer failure same as barrel race, rule number seven.
8. Open to all ages, any size horse.

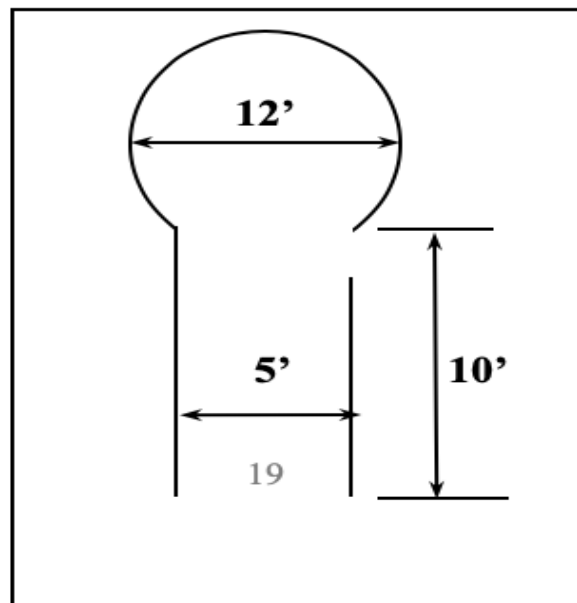

REINING

Junior age will be 18 and under.

Senior age will be 19 and over.

Current AQHA rules and patterns will apply. Reining patterns will be rotated at each show. Judge is to be notified as to which reining pattern will be used.

Reining patterns are available in our online rule book only.

REINING PATTERNS (ONLINE ONLY)

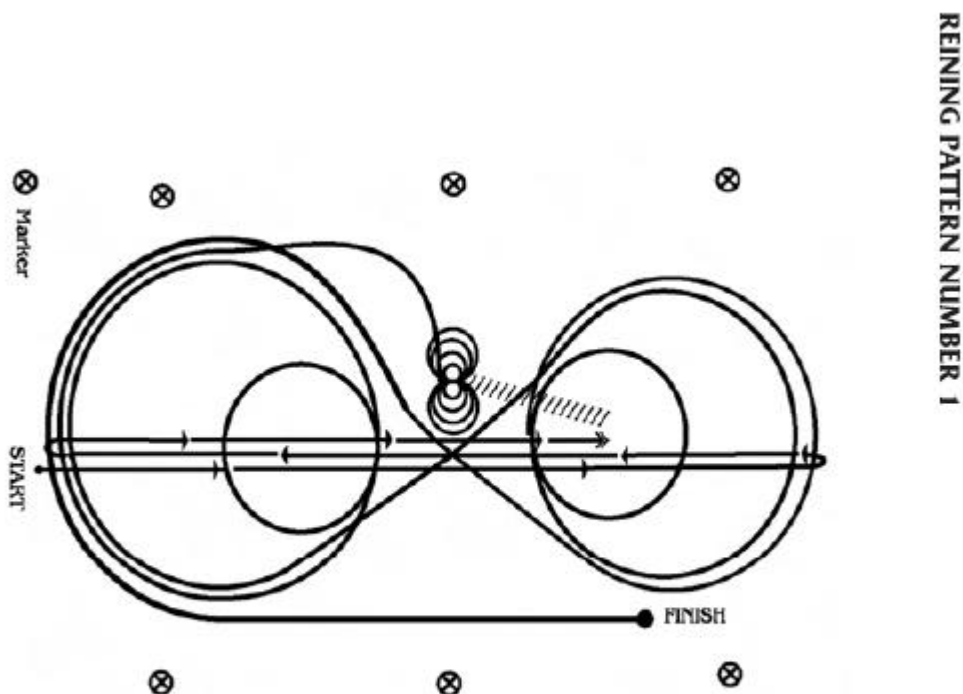

REINING PATTERN NUMBER 1

1. Run at speed to the far end of the arena past the end marker and do a left rollback - no hesitation.
2. Run to the opposite end of the arena past the end marker and do a right roll back - no hesitation.
3. Run past the center marker and do a sliding stop. Back up to center of the arena or at least ten feet. Hesitate.
4. Complete four spins to the right.
5. Complete four and one-quarter spins to the left so that horse is facing left wall or fence. Hesitate.
6. Beginning on the left lead, complete three circles to the left; the first circle large and fast; the second circle small and slow; the third circle large and fast. Change leads at the center of the arena.
7. Complete three circles to the right; the first circle large and fast; the second circle small and slow; the third circle large and fast. Change leads at the center of the arena.
8. Begin a large fast circle to the left but do not close this circle. Run straight up the right side of the arena past the center marker and do a sliding stop at least twenty feet from wall or fence. Hesitate to demonstrate the completion of the pattern.

Rider may drop bridle to the designated judge.

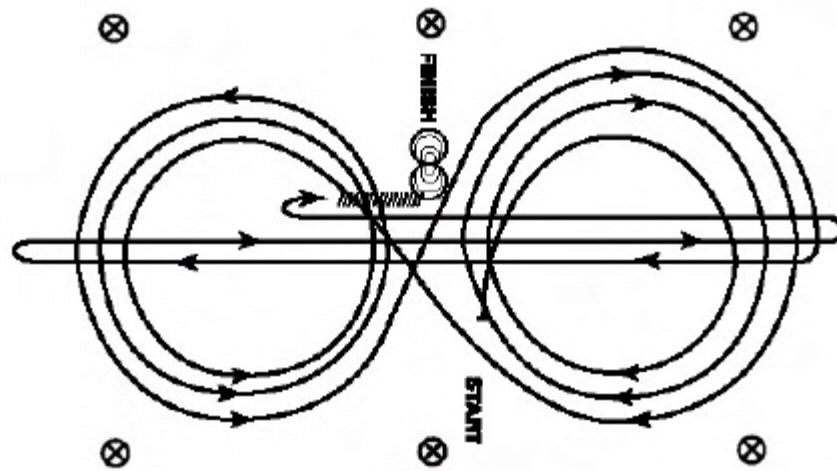

REINING PATTERN NUMBER 2

Beginning at the center of the arena facing the left wall or fence.

1. Beginning on the right lead, complete three circles to the right; the first circle small and slow; the next two circles large and fast. Change leads at the center of the arena.
2. Complete three circles to the left; the first circle small and slow; the next two circles large and fast. Change leads at the center of the arena.
3. Continue around previous circle to the right. At the top of the circle, run down the middle to the far end of the arena past the end marker and do a right rollback - no hesitation.
4. Run up the middle to the opposite end of the arena past the end marker and do a left rollback - no hesitation.
5. Run past the center marker and do a sliding stop. Back up to the center of the arena or at least ten feet. Hesitate.
6. Complete four spins to the right,.
7. Complete four spins to the left. Hesitate to demonstrate the completion of the pattern.

Rider may drop bridle to the designated judge.

REINING PATTERN NUMBER 3

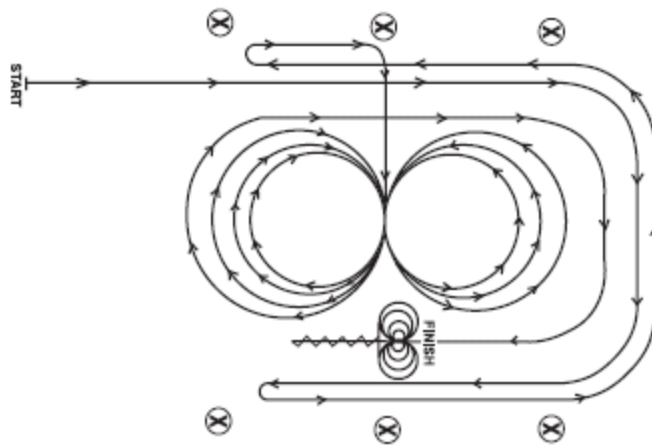

REINING PATTERN NUMBER 3

1. Beginning, and staying at least twenty feet from the walls or fence, lope straight up the left side of the arena, circle the top end of the arena, run straight down the opposite or right side of the arena past the center marker and do a left rollback - no hesitation.
2. Continue straight up the right side of the arena staying at least twenty feet from the walls or fence, circle back around the top of the arena, run straight down the left side of the arena past the center marker and do a right rollback - no hesitation.
3. Continue up the left side of the arena to the center marker. At the center marker, the horse should be on the right lead. Guide the horse to the center of the arena on the right lead and complete three circles to the right; the first two circles large and fast; the third circle small and slow. Change leads at the center of the arena.
4. Complete three circles to the left; the first two circles large and fast; the third circle small and slow. Change leads in the center of the arena.
5. Begin a large fast circle to the right but do not close this circle. Continue up the left side of the arena staying at least twenty feet from the walls or fence, circle the top of the arena, run straight down the opposite or right side of the arena past the center marker and do a sliding stop. Back up at least 10 feet. Hesitate.
6. Complete four spins to the right.
7. Complete four spins to the left. Hesitate to demonstrate completion of the pattern.
Rider may drop bridle to the designated judge.

REINING PATTERN NUMBER 4

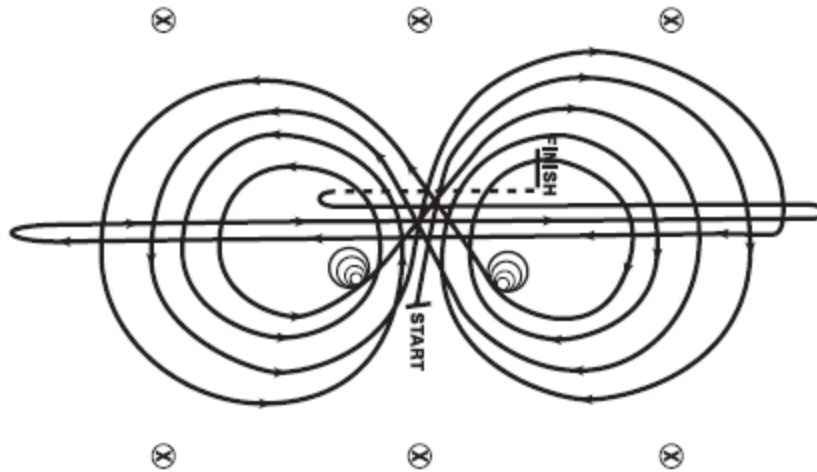

REINING PATTERN NUMBER 4

Beginning at the center of the arena facing the left wall or fence.

1. Beginning on the right lead, complete three circles to the right; the first two circles large and fast; the third circle small and slow. Stop at the center of the arena.
2. Complete four spins to the right. Hesitate.
3. Beginning on the left lead, complete three circles to the left; the first two circles large and fast; the third circle small and slow. Stop at the center of the arena.
4. Complete four spins to the left. Hesitate.
5. Beginning on the right lead, run a large fast circle to the right, change leads at the center of the arena, run a large fast circle to the left, and change leads at the center of the arena. (Figure 8)
6. Continue around previous circle to the right. At the top of the circle, run down the middle to the far end of the arena past the end marker and do a right rollback - no hesitation.,
7. Run up the middle to the opposite end of the arena past the end marker and do a left rollback - no hesitation.
8. Run past the center marker and do a sliding stop. Back up to the center of the arena or at least ten feet. Hesitate to demonstrate completion of the pattern.

Rider may drop bridle to the designated judge.

REINING PATTERN NUMBER 5

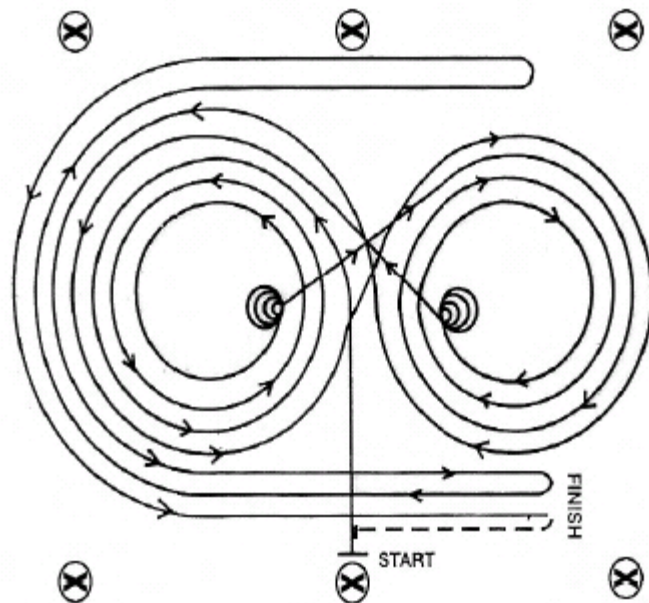

REINING PATTERN NUMBER 5

Beginning at the center of the arena facing the left wall or fence.

1. Beginning on the left lead, complete three circles to the left; the first two circles large and fast; the third circle small and slow. Stop at the center of the arena.
2. Complete four spins to the left. Hesitate.
3. Beginning on the right lead, complete three circles to the right; the first two circles large and fast; the third circle small and slow. Stop at the center of the arena.
4. Complete four spins to the right. Hesitate.
5. Beginning on the left lead, run a large fast circle to the left, change leads at the center of the arena, run a large fast circle to the right, and change leads at the center of the arena.
6. Continue around previous circle to the left but do not close this circle. Run up the right side of the arena past the center marker and do a right rollback at least twenty feet from the wall or fence - no hesitation.
7. Continue around previous circle but do not close this circle. Run up the left side of the arena past the center marker and do a left rollback at least twenty feet from the wall or fence - no hesitation.
8. Continue back around previous circle but do not close this circle. Run up the right side of the arena past the center marker and do a sliding stop at least twenty feet from the wall or fence. Back up at least ten feet. Hesitate to demonstrate completion of the pattern.

Rider may drop bridle to the designated judge.

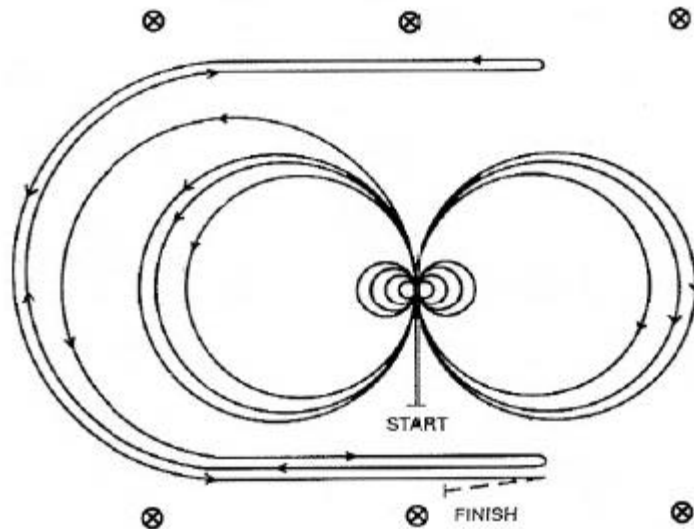

REINING PATTERN NUMBER 6

Beginning at the center of the arena facing the left wall or fence.

1. Complete four spins to the right.
2. Complete four spins to the left. Hesitate.
3. Beginning on the left lead, complete three circles to the left; the first two circles large and fast; the third circle small and slow. Change leads at the center of the arena.
4. Complete three circles to the right, the first two large and fast; the third circle small and slow. Change leads at the center of the arena.
5. Begin a large fast circle to the left but do not close this circle. Run up the right side of the arena past the center marker and do a right rollback at least twenty feet from the wall or fence - no hesitation.
6. Continue back around previous circle but do not close this circle. Run up the left side of the arena past the center marker and do a left rollback at least twenty feet from the wall or fence - no hesitation.
7. Continue back around previous circle but do not close this circle. Run up the right side of the arena past the center marker and do a sliding stop at least 20 feet from the wall or fence. Back up at least ten feet. Hesitate to demonstrate the completion of the pattern.

Rider may drop bridle to the designated judge.

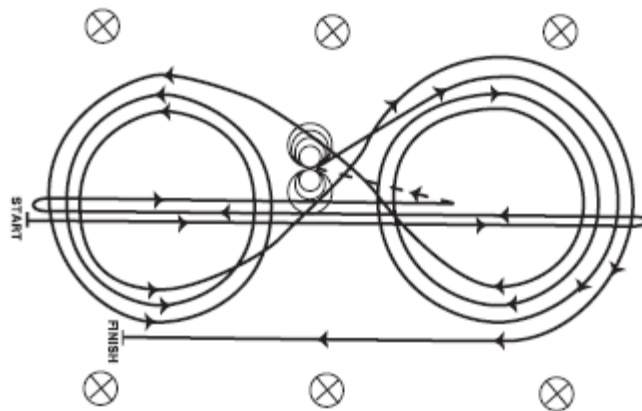

REINING PATTERN NUMBER 7

REINING PATTERN NUMBER 7

1. Run at speed to the far end of the arena past the end marker and do a left rollback - no hesitation.
2. Run to the opposite end of the arena past the end marker and do a right rollback - no hesitation.
3. Run past the center marker and do a sliding stop. Back up to the center of the arena at least ten feet. Hesitate.
4. Complete four spins to the right.
5. Complete four and one-quarter spins to the left so that horse is facing left wall or fence. Hesitate.
6. Beginning on the right lead, complete three circles to the right; the first two circles large fast; the third circle small and slow. Change leads at the center of the arena.,
7. Complete three circles to the left; the first two circles large and fast; the third circle small and slow. Change leads at the center of the arena.
8. Begin a large fast circle to the right but do not close this circle. Run straight down the right side of the arena past the center marker and do a sliding stop at least twenty feet from the wall or fence. Hesitate to demonstrate completion of the pattern.

Rider may drop bridle to the designated judge.

REINING PATTERN NUMBER 8

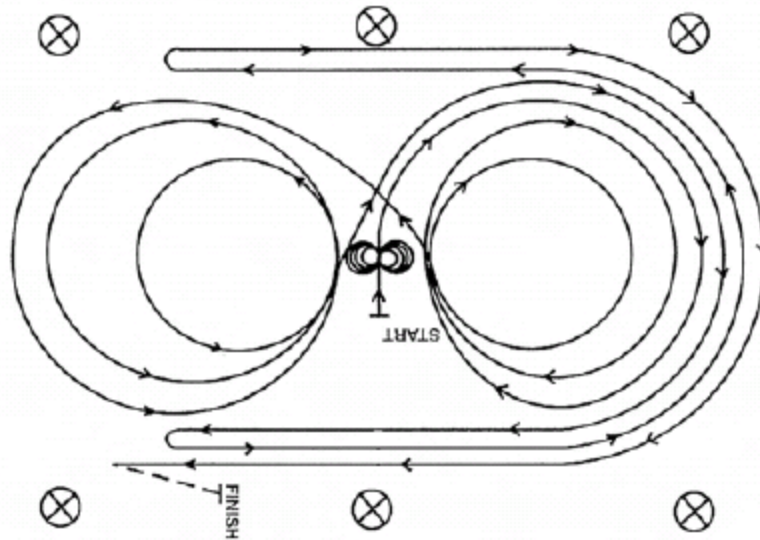

REINING PATTERN NUMBER 8

Beginning at the center of the arena facing the left wall or fence.

1. Complete four spins to the left.
2. Complete four spins to the right. Hesitate.
3. Beginning on the right lead, complete three circles to the right; the first circle large and fast; the second circle small and slow; the third circle large and fast. Change leads at the center of the arena.
4. Complete three circles to the left; the first circle large and fast; the second circle small and slow; the third circle large and fast. Change leads at the center of the arena.
5. Begin a large fast circle to the right but do not close this circle. Run straight down the right side of the arena past the center marker and do a left rollback at least twenty feet from the wall or fence - no hesitation.
6. Continue back around the previous circle but do not close this circle. Run down the left side of the arena past the center marker and do a right rollback at least twenty feet from the wall or fence - no hesitation.
7. Continue back around the previous circle but do not close this circle. Run down the right side of the arena past the center marker and do a sliding stop at least twenty feet from the wall or fence. Back up at least ten feet. Hesitate to demonstrate completion of the pattern.

Rider may drop bridle to the designated judge.

REINING PATTERN NUMBER 9

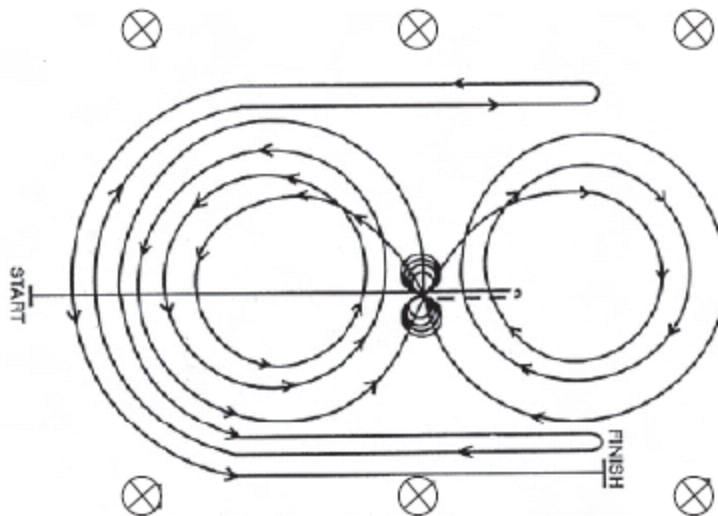

REINING PATTERN NUMBER 9

1. Run past the center marker and do a sliding stop. Back up to the center of the arena or at least ten feet. Hesitate.
2. Complete four spins to the right.
3. Complete four and one-quarter spins to the left so that horse is facing the left wall or fence. Hesitate.
4. Beginning on the left lead, complete three circles to the left; the first circle small and slow, the next two circles large and fast. Change leads at the center of the arena.
5. Complete three circles to the right, the first circle small and slow, the next two circles large and fast. Change leads at the center of the arena.
6. Begin a large fast circle to the left but do not close this circle. Run up the right side of the arena past the center marker and do a right rollback at least twenty feet from the wall or fence - no hesitation.
7. Continue back around the previous circle but do not close this circle. Run up the left side of the arena past the center marker and do a left rollback at least twenty feet from the wall or fence - no hesitation.
8. Continue back around previous circle but do not close this circle. Run up right side of the arena past the center marker and do a sliding stop at least twenty feet from the wall or fence. Hesitate to demonstrate completion of the pattern.

Rider may drop bridle to the designated judge.

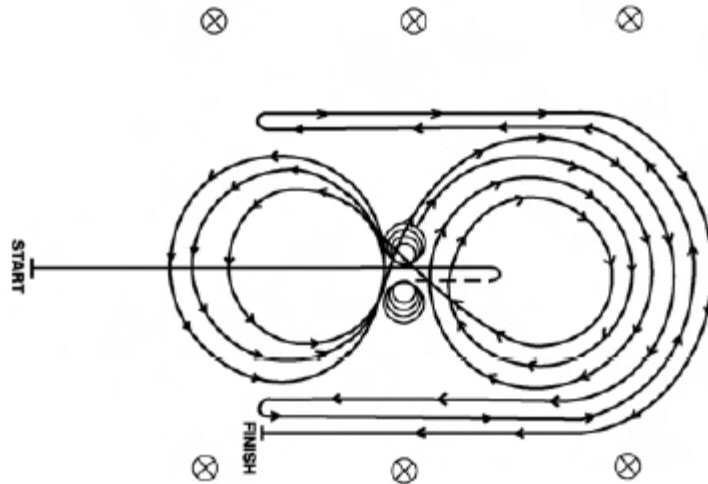

REINING PATTERN 10

1. Run past the center marker and do a sliding stop. Back up to the center of the arena or at least ten feet. Hesitate.
2. Complete four spins to the right.
3. Complete four and one-quarter spins to the left so that the horse is facing the left wall or fence. Hesitate.
4. Beginning on the right lead, complete three circles to the right; the first two circles large and fast, the third circle small and slow. Change leads at the center of the arena.
5. Complete three circles to the left; the first circle small and slow, the next two circles large and fast. Change leads at the center of the arena.
6. Begin a large fast circle to the right but do not close this circle. Run down the right side of the arena past the marker and do a left roll back at least twenty feet from the wall or fence - no hesitation.
7. Continue back around the previous circle but do not close this circle. Run down the left side of the arena past the center and do a right roll back at least twenty feet from the wall or fence - no hesitation.
8. Continue back around previous circle but do not close this circle. Run down the right side of the arena past the center marker and do a sliding stop at least twenty feet from the wall or fence. Hesitate to demonstrate completion of pattern.

Rider may drop bridle to the designated judge.

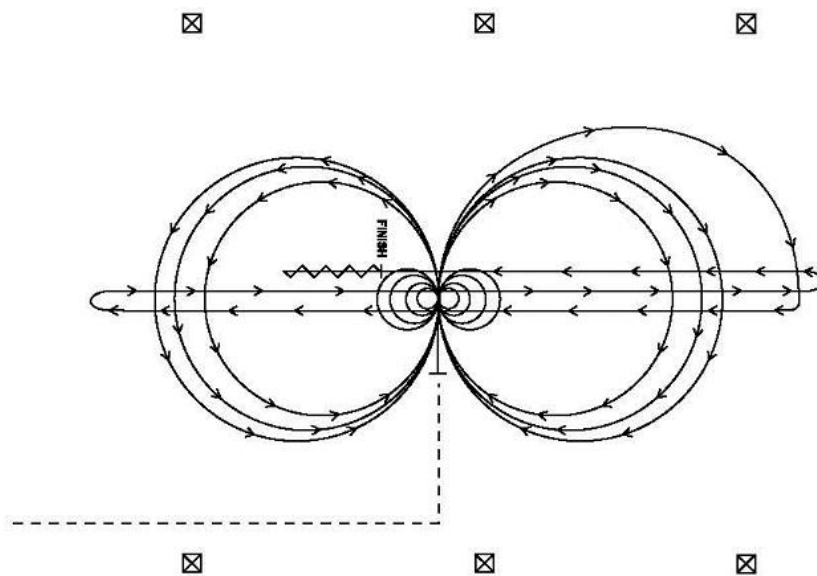

REINING PATTERN NUMBER 11

REINING PATTERN NUMBER 11

Horses must trot to the center of the arena. Horses must walk or stop prior to starting pattern. Beginning at the center of the arena facing the left wall or fence.

1. Complete four spins to the left. Hesitate.
2. Complete four spins to the right. Hesitate.
3. Beginning on the right lead, complete three circles to the right; the first circle small and slow; the next two circles large and fast. Change leads at the center of the arena.
4. Complete three circles to the left; the first circle small and slow; the next two circles large and fast. Change leads at the center of the arena.
5. Begin a large circle to the right, but do not close this circle. Run down the center of the arena past the end marker and do a right rollback – no hesitation.
6. Run up the middle to the opposite end of the arena past the end marker and do a left rollback – no hesitation.
7. Run past the center marker and do a sliding stop. Back up to the center of the arena or at least ten feet (three meters).

Hesitate to demonstrate completion of the pattern.

Rider may drop bridle to the designated judge.

RANCH RIDING PATTERNS (ONLINE ONLY)

RANCH RIDING - PATTERN I

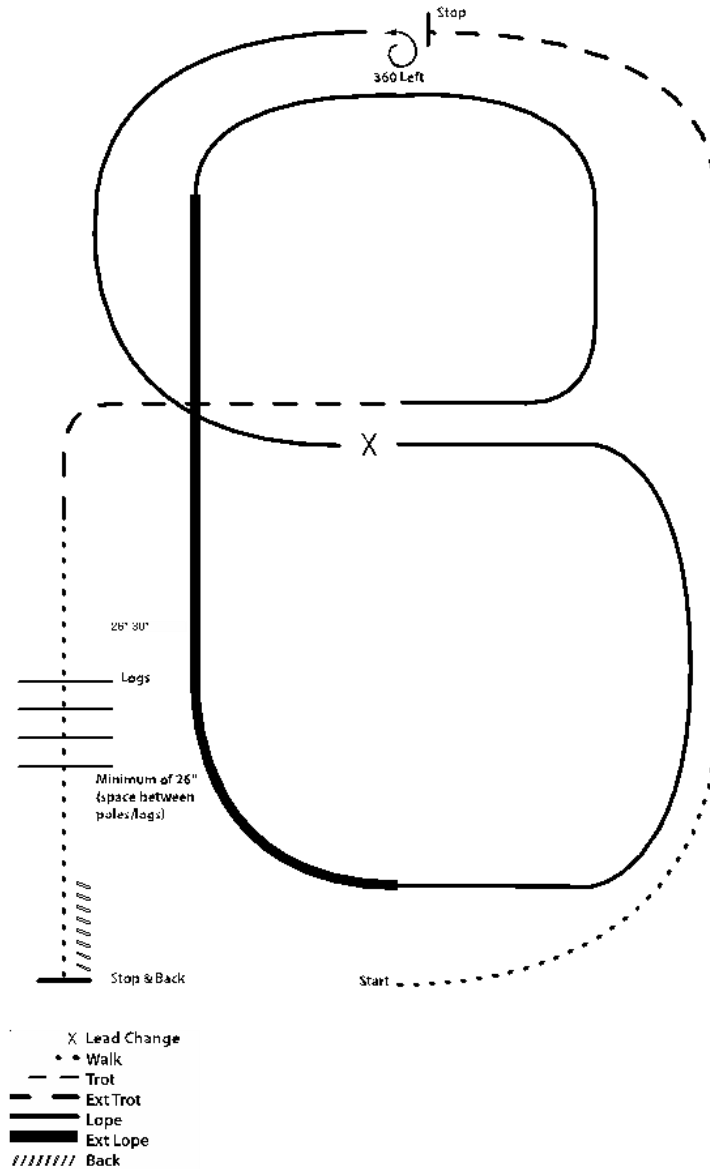

1. Walk
2. Trot
3. Extend the trot, at the top of the arena ,stop
4. 360 degree turn to the left
5. Left lead 1/2 circle, lope to the center
6. Change leads (simple or flying)
7. Right lead 1/2 circle
8. Extended lope up the long side of the arena (right lead)
9. Collect back to a lope around the top of the arena and back to center
10. Break down to an extended trot
11. Walk over logs
12. Stop and back

RANCH RIDING - PATTERN 2

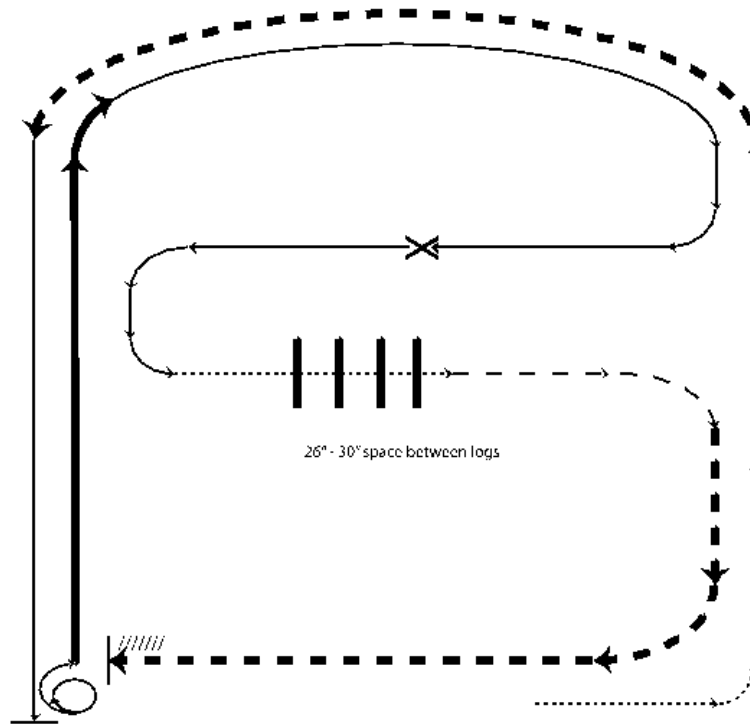

- X Lead Change
- Walk
- - Trot
- - - Ext Trot
- ==== Lope
- ==== Ext Lope
- /////// Back

1. Walk
2. Trot
3. Extended trot
4. Left lead lope
5. Stop, 1 1/2 turn right
6. Extended lope
7. Collect to working lope-right lead
8. Change leads (simple or flying)
9. Walk
10. Walk over logs
11. Trot
12. Extended trot
13. Stop and back

RANCH RIDING - PATTERN 3

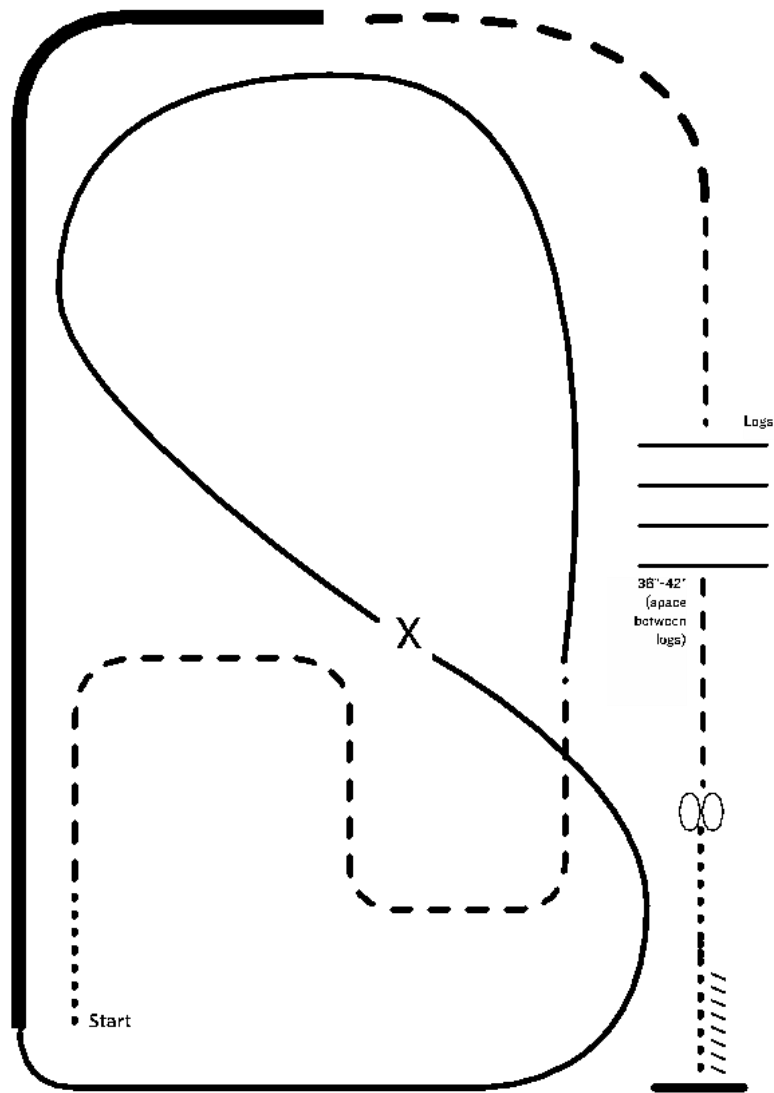

- X Lead Change
 - • Walk
 - - - Trot
 - - - Ext trot
 - Lope
 - Ext Lope
 - //// Back
- I. Walk
 2. Trot serpentine
 3. Lope left lead around the end of the arena and then diagonally across the arena
 4. Change leads (simple or flying) and
 5. Lope on the right lead around end of the arena
 6. Extend lope on the straight away and around corner to the center of the arena
 7. Extend trot around corner of the arena
 8. Collect to a trot
 9. Trot over logs
 10. Stop, do 360 degree turn each direction (either direction 1st) (L-R or R-L)
 - II. Walk, stop and back

RANCH RIDING - PATTERN 4

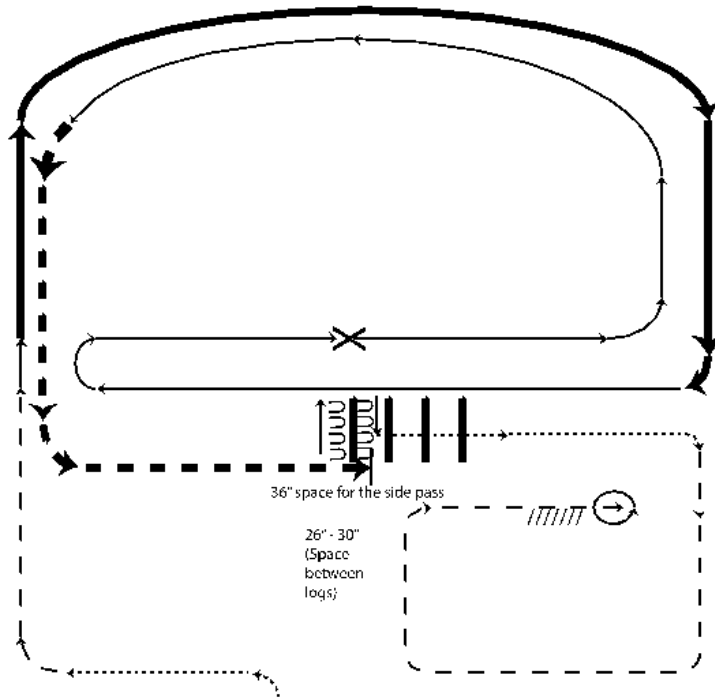

- X Lead Change
- • Walk
- - Trot
- - - Ext Trot
- — — Lope
- — — — Ext Lope
- /////// Back

1. Walk
2. Trot
3. Extended lope-right lead
4. Lope-right lead
5. Change leads(simple or flying)
6. Lope left lead
7. Extended trot
8. Stop, side pass left, side pass right, 1/2 way
9. Walk over logs
10. Walk
11. Trot square
12. Stop, 360° turn left, back

RANCH RIDING - PATTERN 5

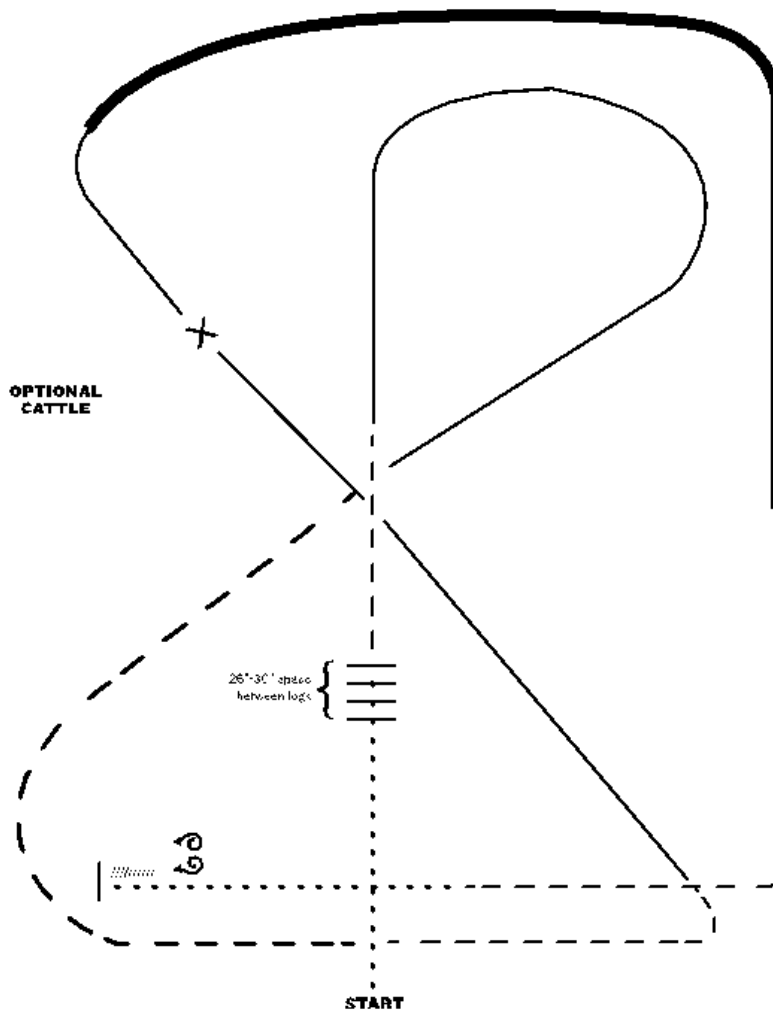

1. Walk
2. Walk over logs
3. Trot
4. Lope right lead
5. Extended trot
6. Trot
7. Lope left lead
8. Change leads (simple or flying)
9. Right lead, extended lope
10. Collect Lope
11. Trot
12. Walk
13. Stop and back
14. 360 degree turn each direction (either direction 1st) (L-R or R-L)

Note: The drawn description of this pattern is only intended for the general depiction of the pattern. Exhibitors should utilize the arena space to best exhibit their horses.

RANCH RIDING – PATTERN 6

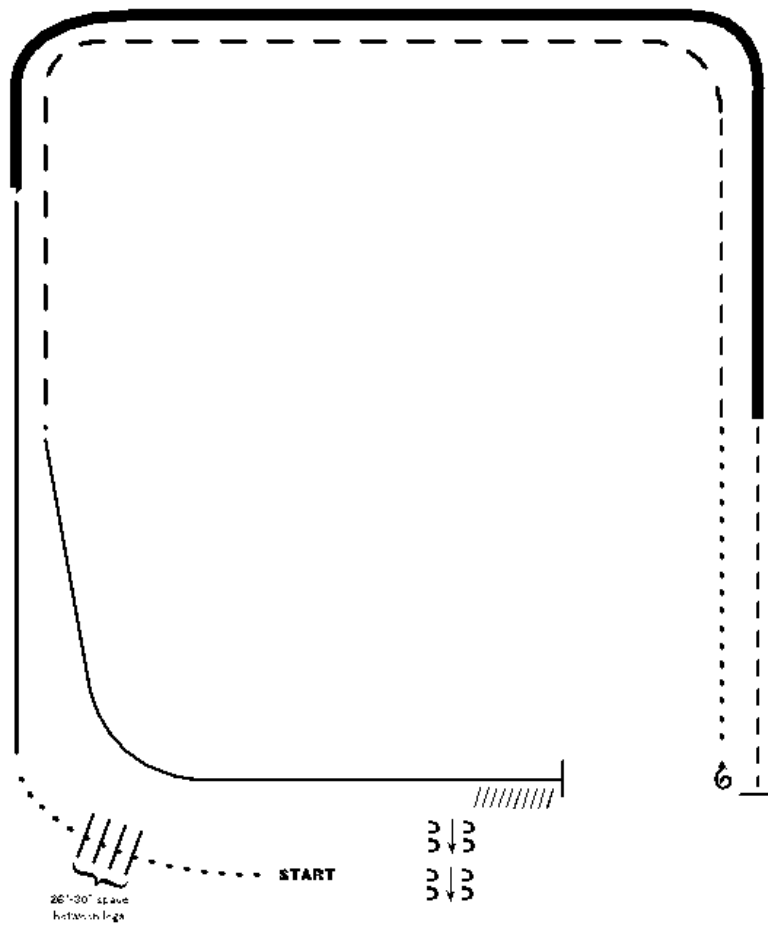

1. Walk
2. Walk over logs
3. Lope right lead
4. Extended lope (right lead)
5. Trot
6. Stop, 1 1/2 turns right
7. Walk
8. Trot
9. Extended trot
10. Lope left lead
11. Stop and Back
12. Side pass right

Note: The drawn description of this pattern is only intended for the general depiction of the pattern. Exhibitors should utilize the arena space to best exhibit their horses.

RANCH RIDING - PATTERN 7

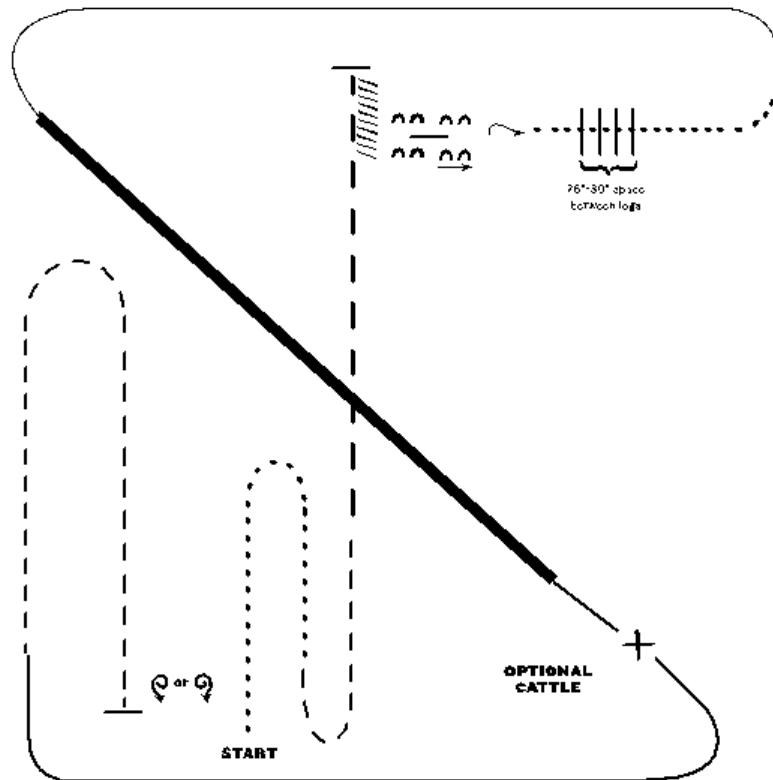

1. Walk
2. Trot
3. Extended trot
4. Stop and back
5. Side pass over log right
6. 1/4 turn right, walk over logs
7. Walk
8. Lope left lead
9. Extended lope (left lead)
10. Collect lope, change leads (simple or flying)
11. Lope right lead
12. Trot
13. Stop. one 360 degree turn either direction

Note: The drawn description of this pattern is only intended for the general depiction of the pattern. Exhibitors should utilize the arena space to best exhibit their horses.

RANCH RIDING - PATTERN 8

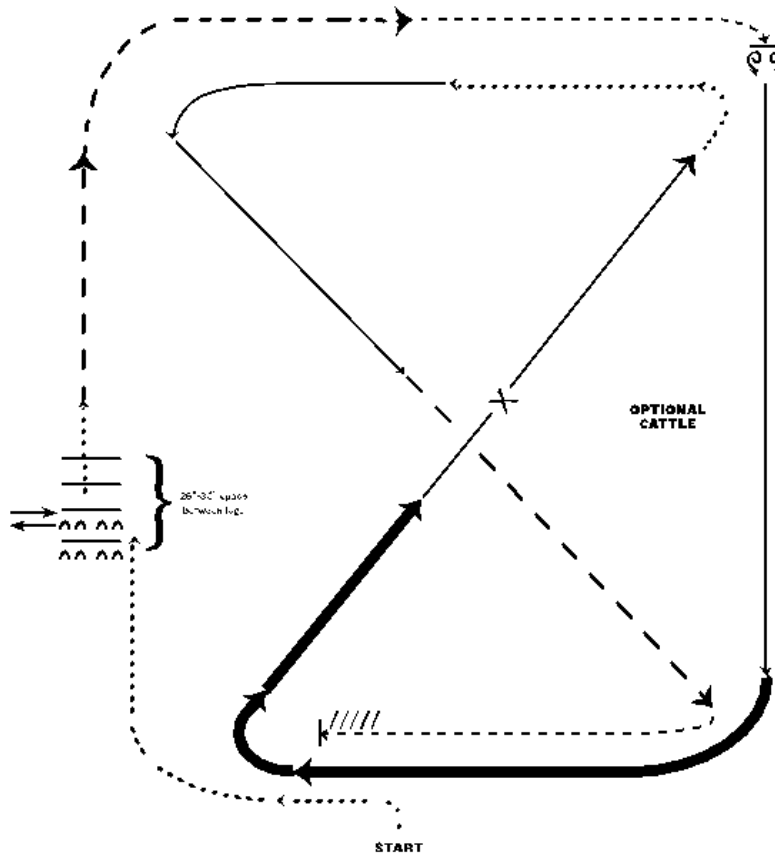

1. Walk
2. Side pass left across first log, side pass 1/2 way to right
3. Walk across logs
4. Extended trot
5. Trot
6. Stop, 360 degree turn each direction (either direction 1st) (L-R or R-L)
7. Lope right lead
8. Extended lope (right lead)
9. Collect lope, change leads (simple or flying)
10. Walk
11. Lope left lead
12. Extended trot
13. Trot
14. Stop and back

Note: The drawn description of this pattern is only intended for the general depiction of the pattern. Exhibitors should utilize the arena space to best exhibit their horses.

RANCH RIDING – PATTERN 9

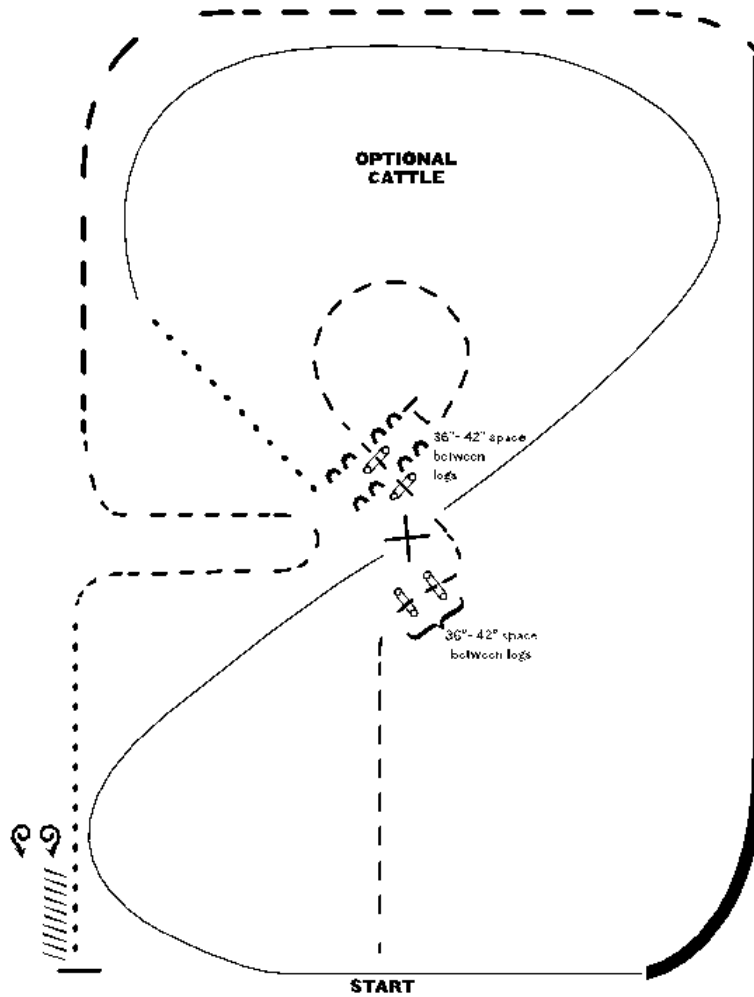

1. Trot
2. Trot two sets of logs
3. Trot circle, stop and side pass log left
4. Walk
5. Lope right lead
6. Change leads (simple or flying)
7. Lope left lead
8. Extended lope (left lead)
9. Extended trot
10. Trot
11. Walk
12. Stop and back
13. 360 degree turn each direction (either direction 1st) (L-R or R-L)

Note: The drawn description of this pattern is only intended for the general depiction of the pattern. Exhibitors should utilize the arena space to best exhibit their horses.

RANCH RIDING - PATTERN 10

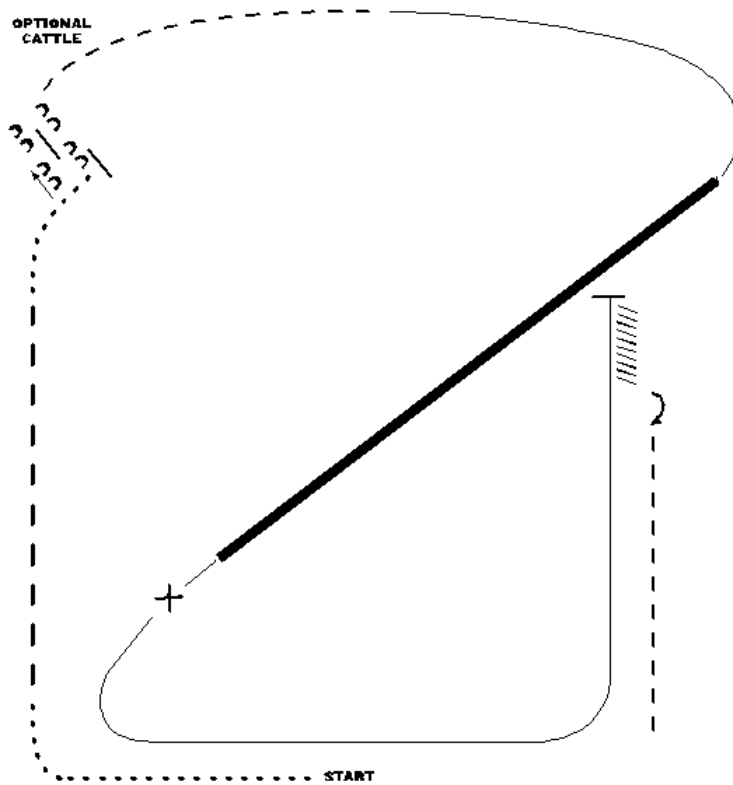

1. Walk
2. Extended trot
3. Walk
4. Stop, side pass log left
5. Trot
6. Lope right lead
7. Extended Lope (right lead)
8. Collect lope and change leads (simple or flying)
9. Lope left lead
10. Stop and back
11. 180 turn to right
12. Trot

Note: The drawn description of this pattern is only intended for the general depiction of the pattern. Exhibitors should utilize the arena space to best exhibit their horses.

RANCH RIDING - PATTERN II

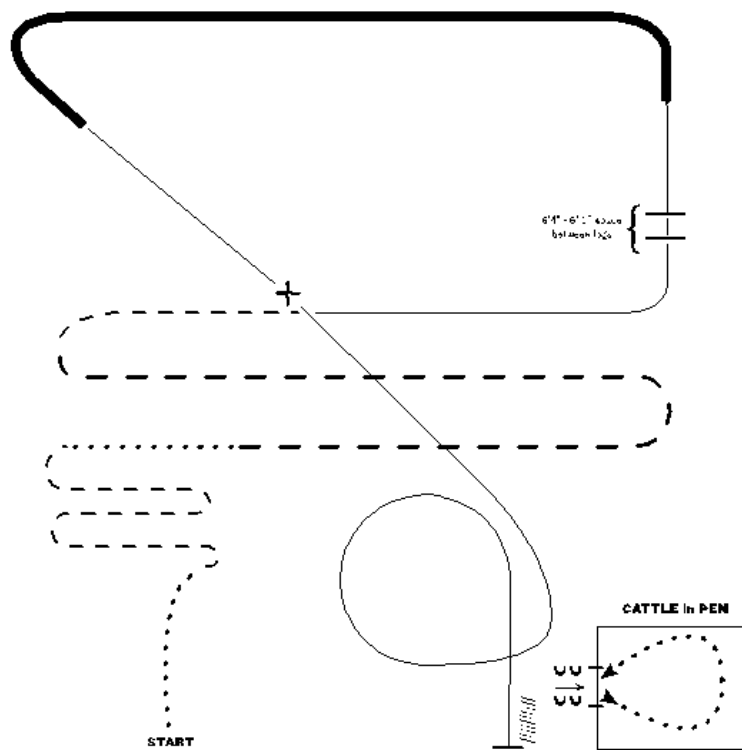

1. Walk
2. Trot serpentine
3. Walk
4. Extended trot
5. Trot
6. Lope left lead
7. Lope over logs
8. Extended lope (left lead)
9. Collect lope, change leads (simple or flying)
10. Lope right lead
11. Lope circle
12. Stop and back
13. Side pass to gate, left hand push into pen
14. Walk through cattle, right hand push out

Note: The drawn description of this pattern is only intended for the general depiction of the pattern. Exhibitors should utilize the arena space to best exhibit their horses.

RANCH RIDING - PATTERN 12

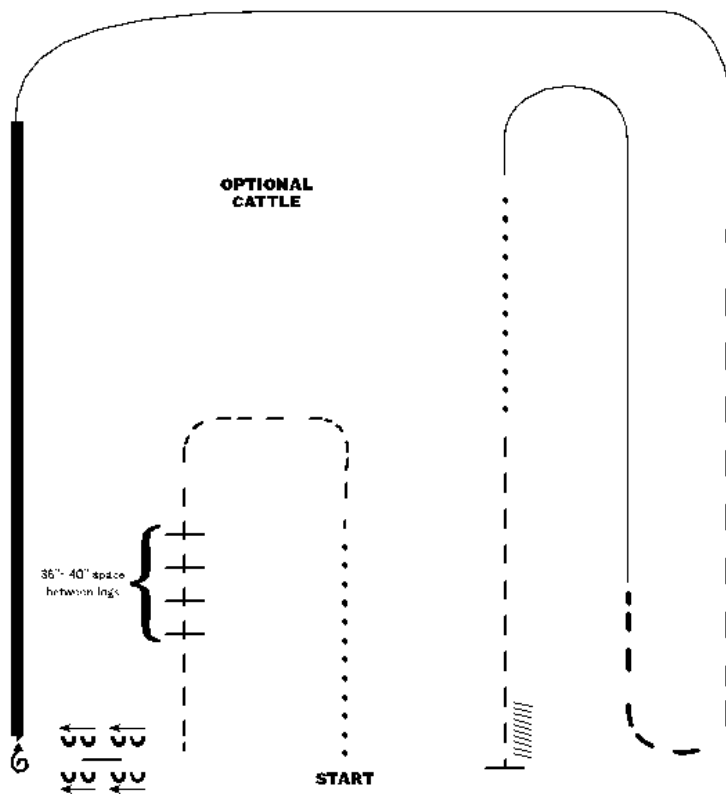

1. Walk
2. Trot
3. Trot logs
4. Side pass right
5. 1/2 turns right
6. Extended lope (right lead)
7. Lope right lead
8. Extended trot
9. Lope left lead
10. Walk
11. Trot
12. Stop and back

Note: The drawn description of this pattern is only intended for the general depiction of the pattern. Exhibitors should utilize the arena space to best exhibit their horses.

RANCH RIDING - PATTERN 13

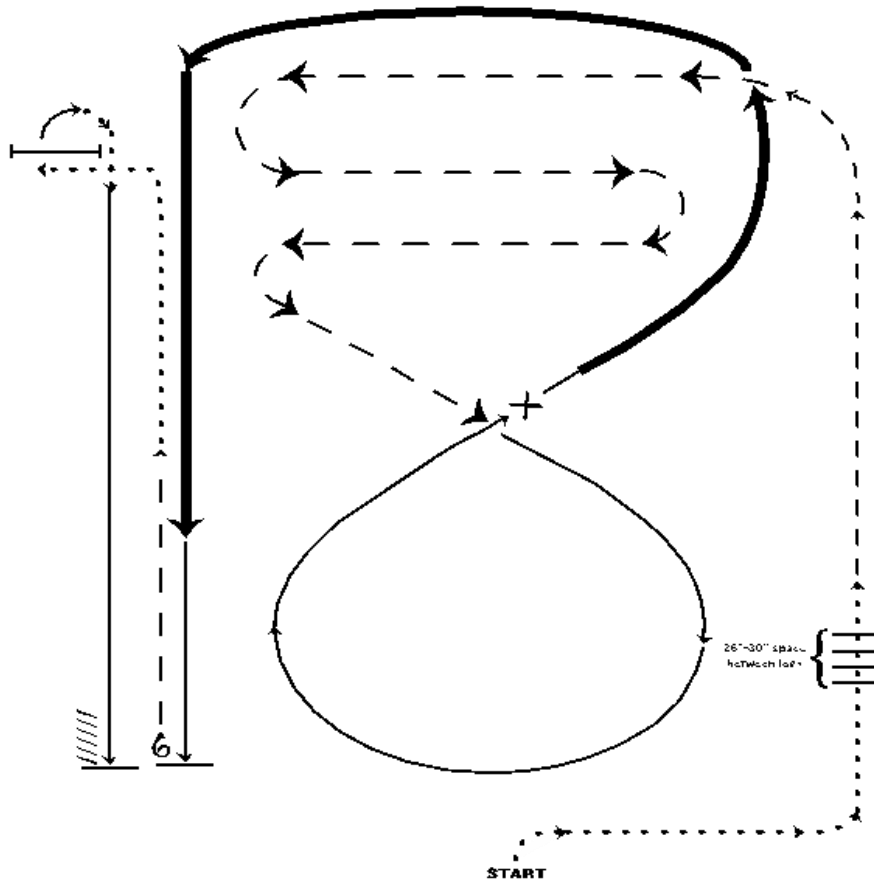

1. Walk
2. Walk over logs
3. Trot
4. Extended trot serpentine
5. Lope right lead
6. Change leads (simple or flying)
7. Extended lope (left lead), collect lope
8. Stop, 1 1/2 turn, either direction
9. Trot
10. Walk to gate
11. Right hand push gate
12. Walk, lope left lead
13. Stop and back

Note: The drawn description of this pattern is only intended for the general depiction of the pattern. Exhibitors should utilize the arena space to best exhibit their horses.

RANCH RIDING – PATTERN 14

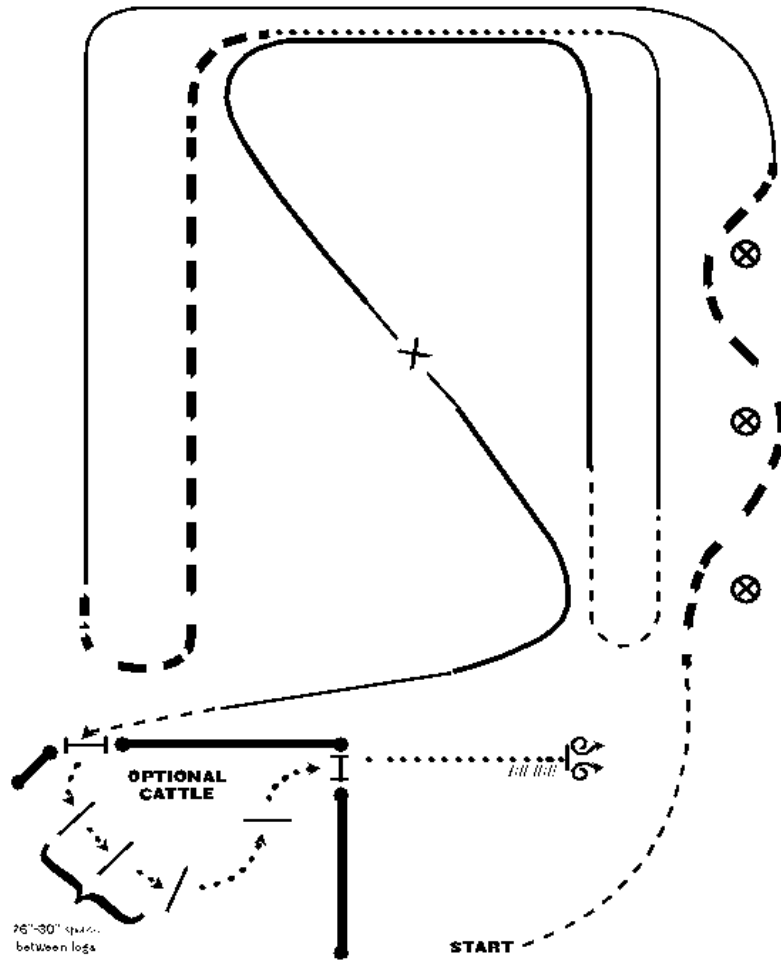

1. Trot
2. Extended trot
3. Lope left lead
4. Extended trot
5. Walk
6. Lope right lead
7. Trot
8. Extended lope (left lead)
9. Collect lope, change leads (simple or flying), extended lope (right lead), collect lope
10. Trot
11. Left hand push gate into pen
12. Walk over logs
13. Right hand push gate out of pen
14. Walk
15. Stop, 360 degree turn each direction (either direction 1st) (L-R or R-L)
16. Back

Note: The drawn description of this pattern is only intended for the general depiction of the pattern. Exhibitors should utilize the arena space to best exhibit their horses.

RANCH RIDING – PATTERN 15

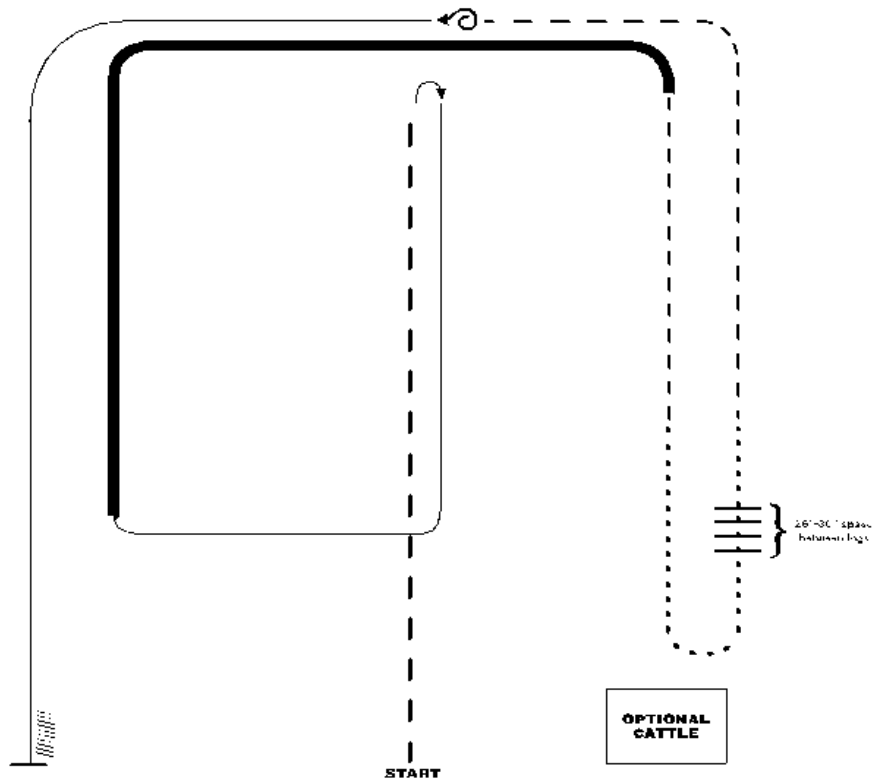

1. Extended trot
2. Stop, rollback right
3. Lope right lead
4. Extended lope (right lead)
5. Trot
6. Walk
7. Walk over logs
8. Walk
9. Trot
10. Stop, 360 left
11. Lope left lead
12. Stop and back

Note: The drawn description of this pattern is only intended for the general depiction of the pattern. Exhibitors should utilize the arena space to best exhibit their horses.