

SUPER-MECLAB.T40

Bench-top Laser Micrometer



The SUPER-MECLAB.T40 Bench Top Laser Micrometer is a high precision instrument for ultra-high accuracy diameter measurements of fluted part, with odd or even flutes. It is ideal for the off-line checking of

- drill bits
- end mills
- cutting tools
- toothed pulleys
- small gears

In addition it can be also used to check the diameter, ovality and the straightness of

- hard metal blanks
- ground pins or cylinders

The Xactum Tecnology

The Xactum XLS40/1200/B Laser Micrometer is an extremely accurate and repeatable measuring instrument, featuring:

Wide measuring field: 40 mm

Any diameter between 0.06 mm and 38 mm can be measured without the need of pre-setting the gauge.

Excellent linearity: $\pm 0.5 \mu\text{m}$

Every different diameter can be measured very accurately, without the need of re-calibrating the gauge on a specific master.

Outstanding repeatability: $\pm 0.07 \mu\text{m}$

This excellent repeatability is even better when measuring diameters lower than 38 mm, and can be as low as $\pm 0.05 \mu\text{m}$ on smaller parts, with diameters up to 10 mm. The repeatability when measuring fluted parts is typically better than $\pm 0,5 \mu\text{m}$.

Permanent self-calibration

You do not need to periodically re-calibrate the instrument. A steel master is permanently installed in the gauge and it is checked at every scan, 1200 times per second. An excellent long term stability is achieved.



No measuring drift due to changing room temperature !

The **NO-VAR** (No Variation) technology allows to get simply perfect diameter measurements even in non thermally controlled environments. In addition, it is possible to program the thermal expansion coefficient of the material being measured in order to automatically compensate the thermal expansion of any part.

Benefits

Unique for checking odd fluted parts!

Contactless measurement: no part damage or scratches

Objective and highly reproducible results: no matter about the operator's skillness

Extremely easy and quick to use: reduce inspection time and improve measurement capability

Highly flexible: different components and sizes can be measured without system pre-setting or re-mastering.

Ultra accurate: measure to an accuracy that before you could only get in a metrology room, using much more expensive equipment and specialized personnel.

System Composition

The basic system consists of:

- XLS40/1200/B Xactum Intelligent Laser Sensor
- Flat granite baseplate
- Precision linear stage, manually driven, with magnetic digital scale
- Fixture for the part, with a pair of V blocks and a stopper
- Motor driven device to rotate the part, with driving wheel and its driver for the stepper motor
- All-in-one PC with 15.6" Touch Screen LCD monitor
- Super-Meclab.T software pre-installed in the PC
- Power supplies and connecting cables

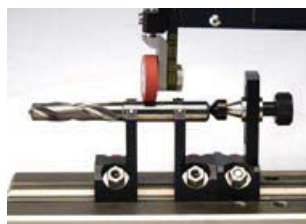

System operation

The part being checked is inserted on a double V fixture, which is mounted on a manually driven slide equipped with a magnetic digital read out scale to display the displacement of the part itself; the position is continuously displayed on the screen.

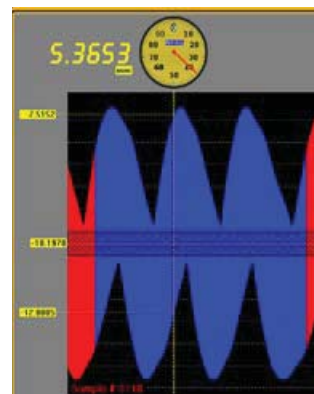

Using a special guided procedure, the operator seeks the starting point, moves the part to the measurement position and starts the measuring cycle: the part is rotated by a special motor driven device using a rubber wheel laying on the part. This keeps it pushed against the V blocks and assures a "zero run-out" rotation, that is a rotation around a perfectly fixed axis.

During the rotation period, which is automatically set by the computer, the laser sensor scans the part at 1200 samples/second and stores all the measurements related to the positions of the upper and lower edge of the part.

Exclusive data processing software performs an accurate and repeatable diameter measurement of the part, for both odd or even fluted parts. As a set up choice, different processing algorithms are applied, to fit the part geometry and to calculate different parameters. The measurement cycle can be repeated at several positions along the part axis.

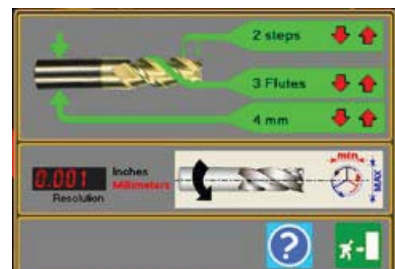

Measuring Mode

Mode 1: each flute/cutting edge is measured separately and the processor computes the effective diameter of the circle determined by the cutting edge during the rotation.



The following dimensions are computed and displayed

- Maximum diameter or "effective cutting diameter"
- Minimum diameter
- Diameter Range ($\varnothing \text{ max} - \varnothing \text{ min}$)
- Run-out



Mode 2: the measurements are processed assuming the hypothesis that all the edges have the same radius from the center of the section and they are equally spaced in angle. The diameter of the section is calculated, as well as the concentricity, between the center of the section and the rotation axis determined by the shank. In addition the "effective cutting diameter" is computed which should coincide with the sum of the section diameter + 2 times the Run-out of the centre position, provided that the real section geometry fits the model.



The following dimensions are computed and displayed

- Effective Cutting Diameter
- Tool Diameter
- Run-out of the centre position

Mode 3:

This is a menu dedicated to check round parts (i.e. hard metal blanks).

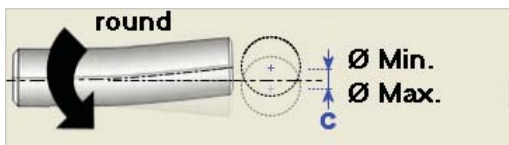

The following dimensions are computed and displayed

- Maximum diameter
- Minimum diameter
- Range of the center position ($\text{max } C - \text{min } C$)
- Diameter Range ($\varnothing \text{ max} - \varnothing \text{ min}$)

Measuring the range of the center position at different locations along the blank, it is possible to check the straightness of the blank.

Mode 4:

Use this menu when no hypothesis about the section geometry can be made



The following dimensions are computed and displayed

- Maximum diameter
- Minimum diameter
- Effective Cutting Diameter
- Diameter Range ($\varnothing \text{ max} - \varnothing \text{ min}$)

The Super-Meclab.T Software

The Super-Meclab.T software has been designed to be extremely user friendly and very flexible. Thanks to the large 15" LCD display and the Touch Screen feature, you can browse the Menu and select the different working functions with a finger touch.

Automatic seeking of the "zero point"

A special guided procedure is available to reset the position reading at the part starting point.

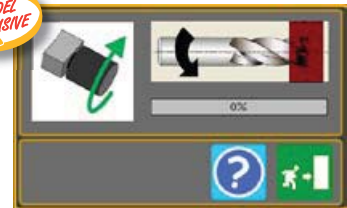

Quick tolerance check

Each measured dimension can be compared with a pre-set nominal value and a tolerance range: a "traffic light" will immediately display the tolerance status of the part.



Multiple Measurements on the same Part

Several measurements can be taken on the same part, at different locations along the axis, to check the taper or the bending.

PART NUMBER: 5			
STEP:	1	2	3
Average	19.978	6.201	19.970
Minimum	19.969	6.201	19.969
Maximum	19.990	6.202	19.970
Range		0.001	
Average	-8.087		
Minimum	-8.091		
Maximum	-8.082		
Range	0.009		

Data recording and exporting.

The measurement results are listed on the screen and they can be saved in the computer memory or exported in "text" or "Excel" format.

Report printing

A measurement report can be immediately printed by using a standard PC printer. A statistical report is available for each measured dimension the average, max and min values will be computed, as well as Standard Deviation and Cp and Cpk values.

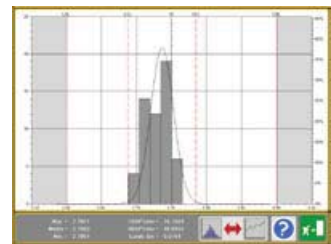

Part library for easy programming

An almost unlimited number of control sets (tolerance limits, measuring mode, etc.) can be stored in a "part library"



Multiple-point user re-mastering capability

It is possible to run a Multiple-point re-mastering procedure, to get a perfect match between the readings and the user's masters.

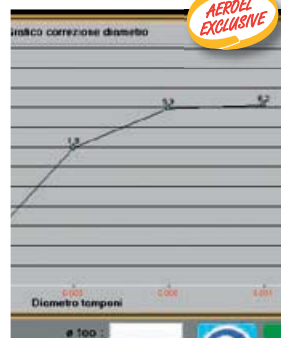

Digital oscilloscope

The waveform of the light pulse is sampled inside the gauge and transmitted to the PC. On the display screen you can see the actual signal as if you were using a digital oscilloscope.



Help on line

During operation, you can open a Help window where you will find the information you need to use the system. No hardcopy manual is needed.

Specifications

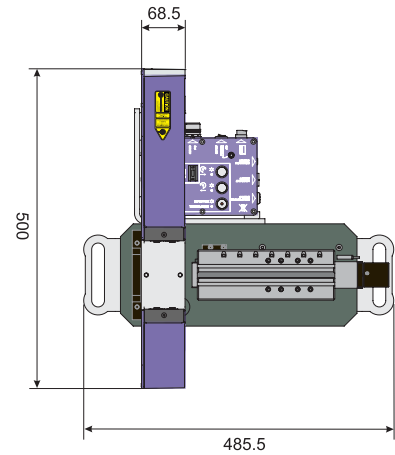
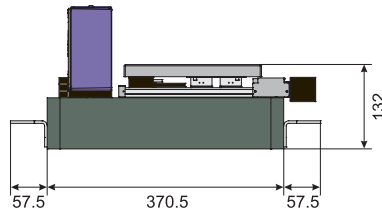
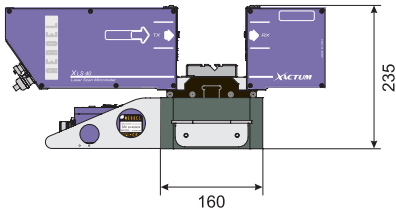

All dimensions are in mm.

Xactum XLS40/1200/B Laser Micrometer		
Measurable Diameters	(mm)	0.06 - 38
Linearity (Centred Product)	(μm)	± 0.5
Linearity (in the Measuring Plane)	(μm)	± 0.5
Repeatability ($T=1s, \pm 2\sigma$)	(μm)	± 0.07
Single Shot Repeatability ($\pm 2\sigma$)	(μm)	± 1.5
Beam Spot Size (s,l)	(mm)	0.06 x 0.1
Scanning Frequency	(Hz)	1200
Gauge Thermal Coefficient	($\mu\text{m}/\text{m}^\circ\text{C}$)	- 11.5
Laser Source		VLD (Visible Laser Diode); $\lambda = 650 \text{ nm}$
Super-Meclab.T40 System		
Dimensions	(mm)	500 x 485.5 x 235
Weight	(kg)	25

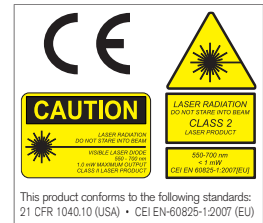

Specifications subject to change without notice. For additional details and complete specifications please see the gauge data sheet.

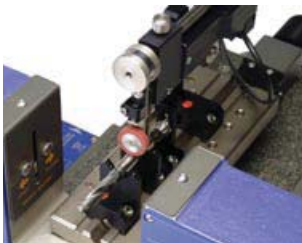

FIXTURE

Precision linear slide on a flat granite base: stainless steel table with V groove, overall length 210 mm, range 90 mm, manual and micrometric drive with knob, 1 mm/rev

Position transducer: magnetic digital read out, resolution 0.005 mm

Part holding: with a couple of 90° V blocks and a stopper, adjustable along the slide. Bearing on hard metal bars, with special cover, for low friction coefficient (0.05) and high hardness (2000 – 4000 HV).

Fixture capacity: shank diameter from 1 to 20 mm, shank length from 22 to 100 mm, max part length 200 mm.

Rotation device: motor driven, with pushing wheel and stepper motor driver, local or automatic control (from PC)



TOUCH-SCREEN PC

LCD Display: 15.6" wide screen 1366x768 TFT color LCD - resistive touch screen

Hard disk: SATA HD 2.5" 250GB

LAN standard: Fast Ethernet 10/100 Base T

USB: 4 x USB 2.0 + integrated card reader (SD/MMC/MS/MS-pro)

Dimensions: 391 x 327 x 36 mm

Weight: kg 3.6

Power: External Adapter 19VDC, 40W



AEROEL S.R.L.
Via Pier Paolo Pasolini 35/3
Pradamano (UD)
33040 - ITALY
Phone +39 0432 671301
Fax +39 0432 671543
e-mail: aeroel@aeroel.it
<http://www.aeroel.it>



ISO 9001:2008

