



A PEPPERL+FUCHS BRAND

Integrating efficiency.
Maximizing safety.
Enabling digitization.

Mobile Communication and Safety

Learn more at www.ecom-ex.com



+91-80-3352 6000

pa-info@in.pepperl-fuchs.com

 **PEPPERL+FUCHS**

Your automation, our passion.

PROTECT YOUR ASSETS

High-Performance Safety Systems

A total system approach to meet new
API670 safety level standards.



DECADES OF EXPERIENCE INTEGRATED INTO A TOTAL SOLUTION THAT PROTECT YOUR ASSETS

The new API670 standards require a total systems approach to meet the safety levels required in the industry. Woodward is a leader in delivering steam turbine safety systems to meet these new standards. Woodward's SIL-3 enabled safety systems with integrated package of ProTech, QuickTrip, and certified sensors reduce installation costs and allow you to meet the safety requirements for small, medium, or large steam turbine applications.

Woodward turbine safety systems precisely and reliably scan rotor speed and other key turbine operating parameters over 40 times per second. Purpose built with deterministic behavior and fast scan rate safety logic solvers and sensors combined with the speed and reliability of our fully integrated trip block assembly with on-line test capability enable our customers to have a stand-alone SIL-3 safety system you can trust.



PROTECH

Woodward ProTech safety logic solvers were designed in collaboration with turbine manufacturers to ensure fast response times required to shut down large, medium and small turbines quickly and safely.



QUICKTRIP

Woodward's QuickTrip fault tolerant trip block design makes it ideal for critical steam turbine applications, where turbine up-time and availability are essential. This trip block assembly's 2-out-of-3 voting design provides users with a very high level of system reliability as well as compliance with industry standard API-670.



SIL SENSORS

Woodward's SIL-3 certified speed sensors provides a complete certified safety system solution when combined with our safety logic solver, trip block and approved trip and throttle valve.



TURBOMACHINERY CONTROL EXPERTS
Turbines | Compressors | Safety | Actuation

india_sales@woodward.com
Phone: +91-124-4399500

 **WOODWARD**



since 1963

Legacy of Expertise. Solutions for the Future.

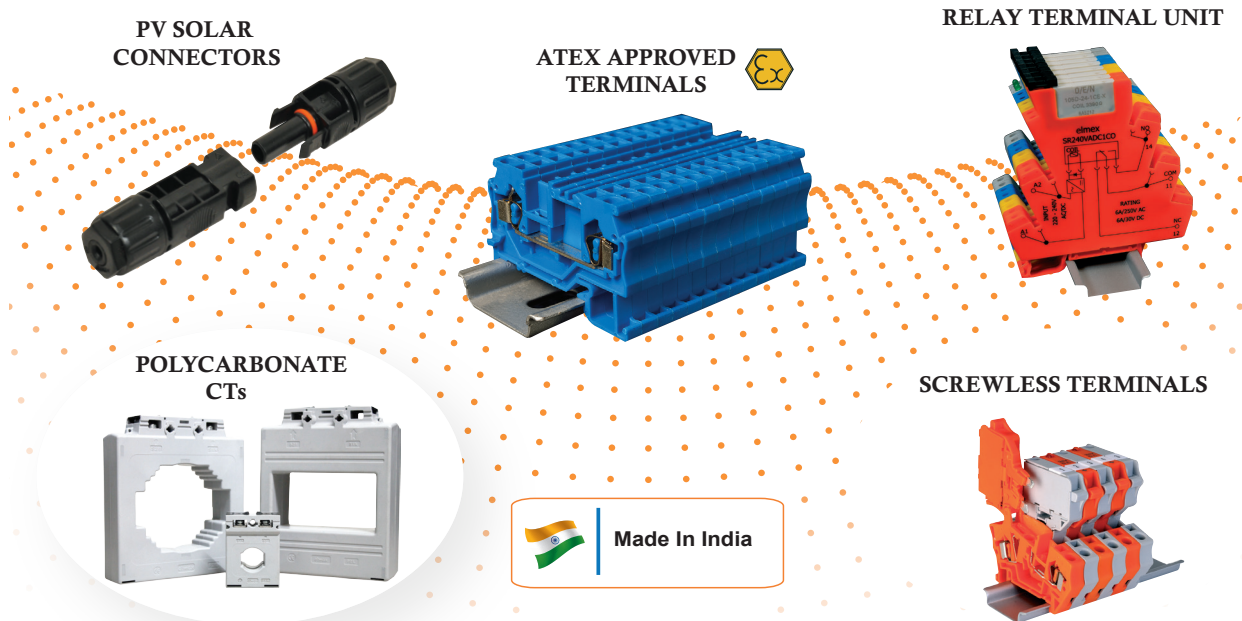

- Global footprint with customers in more than 35 countries
- ISO 9000-2008 & ISO 14000-2004 accredited management, quality & environment system
- Vertically integrated infrastructure with in-house facilities from design to manufacturing

**Solutions For
Solar Photovoltaic**

**Solutions For
Connectivity**

**Solutions For
Control & Instrumentation**

**Solutions For
Metering & Protection**

**Solutions For
Oil & Gas Industry**



Converging
Innovations  Expanding
Solutions

Elmex Controls Pvt. Ltd. | Elmex Electric Pvt. Ltd.

12, GIDC Estate, Makarpura, Vadodara - 390010, Gujarat, India

☎ : 0265-2642021 / 23 ✉ : marketing@elmex.net 🌐 : www.elmex.net



Engineering For The Future

ROTEX AUTOMATION LIMITED

_ Your Ideal Business partner

REDUNDANT CONTROL SYSTEMS

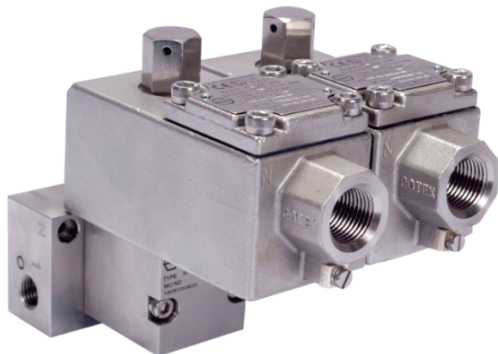
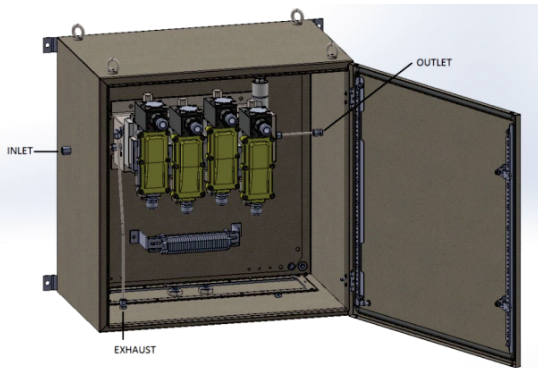

2oo2 Voting System
- in Manifold .

ROTEX AUTOMATION LITIMED UNIT 1

987/11, GIDC Makarpura,
Vadodara - 390010, Gujrat, INDIA.
Ph.: +91 265 2638136/ 2638795/46
Fax: +91 265 2638130
Email: rotexvun@rotexautomation.com

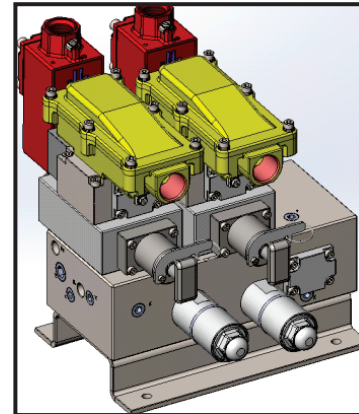

2oo2 VOTING SYSTEM
DOUBLE MODULAR REDUNDANCY

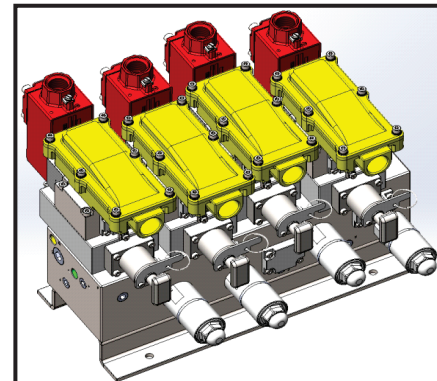

2oo3 VOTING SYSTEM
TRIPLE MODULAR REDUNDANCY

ROTEX AUTOMATION LITIMED UNIT 2

C - 1 B/ 1501, 4 & 5, GIDC
Viyhal Udyognagar- 388121,
Gujrat, INDIA.
Ph.; +91 2692 236224 / 236292 / 236399
Fax: +91 2992 236442
Email: rotexvun@rotexautomation.com

VELAN

Quality that lasts.



- ▼ Velan has a wide exposure in valve automation for varied application & customized solution for application such as coker, power, oil & gas, etc for many decades.
- ▼ Velan offers automation with engineered solution for multi-turn & quarter turn valves with utmost care in sizing, selection of actuators and necessary accessories.
- ▼ Valve and Actuator integration designed for its life cycle with structural rigidity and functional performance.
- ▼ Each valve is shop tested with actuator and certified before despatch.
- ▼ Velan ABV has recently developed a patented cable drive actuator for quarter turn valves to ensure maximum dynamic control performance under most demanding condition. Product developed to deliver up to 50,000 Nm Torque.

AUTOMATED VALVES

For Extensive Range Of Applications

Registered / Plant Address

Velan Valves India Pvt Ltd.

(A wholly owned subsidiary of Velan Inc.)

S.F.No : 337/1, Thennampalayam - Annur Road,
Naranapuram Village, Coimbatore - 641 659,
Tamil Nadu, India.

Sales Offices

S-203, II nd Floor, Kanishka Complex,
D.D.A Market, Mayur Vihar,
Ph-1 (Extn.), Delhi - 110091,
India.

Tel : +91 (11) 47025630

No.78, Pratham Upvan Tandalia,
Sun Pharama Road, Vadodara
Gujarat - 390 012,
India.

Mob : +91 98259 90250

Tel : +91 (421) 2267000 | Fax : +91 (421) 2267048 | Email : sales.india@velan.com | Web Site : www.velan.com



IS MANAGING CRITICAL INDUSTRIAL APPLICATIONS YOUR DAILY CHALLENGE? **THAT'S WHERE WE COME IN.**

AC UPS & BATTERY CHARGERS TO MEET YOUR SPECIFIC INDUSTRIAL NEEDS.

Managing industrial environments is a huge responsibility but it doesn't have to be a huge challenge too. You need reliable, industrial-grade UPS systems, battery chargers, inverters, and rectifiers for heavy duty, industrial use. We provide configured or custom-made products to meet your specific industrial needs.



Liebert® HIPULSE-D
AC UPS System
5-160 kVA



Liebert® FP 30ZM
Modular AC UPS



Liebert® FP 60Z
AC UPS System
1-phase or 3-phase output



Liebert® UTILITYSURE
Industrial Modular Rectifier
Battery Charger-
110VDC & 220VDC



YOUR VISION, OUR PASSION

Corporate Office : Plot C-20, Rd No.19, Wagle Ind Estate,
Thane (W), 400604. India

Explore solutions at VertivCo.com/en-in

Call Tollfree : **1-800-2096070**

E-mail : marketing.india@vertivco.com

The Perfect Solution for Process Industry

ISA 100 WIRELESS
Wireless Transmitters

DP Harp
FOR THE DIGITAL WORLD
Multivariable Transmitter

ADMAG AXF
digital VORFLO
Magnetic Flowmeter
Digital Vortex Flowmeter

Pressure & Differential Pressure Transmitter

DAQ STATION
DAQ MASTER
Paperless Recorders & Data Acquisition Units

CENTUM VP
SCADA & Distributed Control Systems

Test & Measuring Instruments

ACE
FA-M3V
VITESE

TUNABLE DIODE LASER ANALYZER
TOL5200 TruePeak
Gas Analyzers

GREEN
Gas Analyzers

FCN-RTU
STARDOM
Controllers

FAST/TEELS
Supervisory Systems

Technology you can trust..
...systems you can rely on



For Further Information please contact:

Yokogawa India Ltd.
Product Marketing Dept.,
Plot No.96, Electronic City,
Hosur Road, Bangalore 560100

Phone: (080) 41586000 Fax: 080 28528656
E Mail: marketing@in.yokogawa.com
Website: www.yokogawa.com/in



ICE (ASIA) PRIVATE LIMITED

Instruments * Controls * Equipments
Established in 1983



Reg. No.:
44 100 18391635

INSTRUMENTS FOR OIL AND GAS PROCESS APPLICATIONS



ALPHA MOISTURE SYSTEM, UK

Portable / Online Dew Point Analyzer
PPM Moisture Analyzer



DELTA PHASE, USA

Portable & Online Laser Light Scattered Dust Monitors
Level & Flow measurement
Water analyser & Gas Analyser



AMI, USA

Complete Range of Portable / Online percent and ppm Trace
Oxygen Analyzers
Portable & online Trace Hydrogen Sulfide Analyzers (H2S)



GALVANIC APPLIED SCIENCES INC. CANADA

On-line Sulphur & H2S Analyzer, Process GC. GC for measuring calorific
value of fuel gas.
Online analyzers for viscosity, oil in water, chlorine, COD, BOD etc.
Online Oil / Hydrocarbon in water, water in NMP, Chlorine.



Analysen-, Mess- und
Systemtechnik

Wobbe index, density and calorific value analyser
Trace analyser for toxic gases
Residual oxygen and flue gas measurement based on zirconia sensor



LUMASENSE, USA (E² TECHNOLOGY, MIKRON & IMPAC)

Portable & Online Non-contact Infrared Temperature Measurement Thermometer
Infrared Thermal Imaging Camera for furnace temperature measurement
E² T Pulsar Pyrometer for sulfur recovery application
E² T Quasar Infrared flare stack monitoring system



AUBURN SYSTEMS, USA

Complete line of Dust & Particulate Monitoring
Fugitive Dust Monitor
Solid Flow Monitor



NOVA ANALYTICAL SYSTEMS INC, CANADA

H2 Purity Analyzer
Portable and Online system for H2 Cooled Generators and Converters,
Heat Treating Analyzers
Portable / Online Gas analyzers for Process Gas Analysis and sample
conditioning equipment for industrial applications

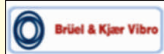

BRUEL & KJAER VIBRO, GERMANY

Protective / Safety Monitoring and knowledge based Condition
monitoring systems
Vibration monitoring sensors & systems
Turbine supervisory systems B K VIBRO



PROTEA, UK

In-situ CEMS System
Process & Lab Ambient Environment analyzers
FTIR Analyzer



COMET SYSTEM S.R.O. CZECH REPUBLIC

Online & Portable Humidity Meters
Portable / Online Temperature Meter
Portable / Online CO2 Meter



SENKO, KOREA

Portable & Online Gas detector
Multigas Gas Detector
Gas leak detector



K-TRON (SCHWEIZ) GMBH SWITZERLAND

Gravimetric & Volumetric Feeders,
Belt Feeders
Flow meters (For Plastics, Petrochemical, Polymer,
Pharmaceutical Textile, Industries)



Atac, UK

Spectrophotometer
H2s & moisture analyser by TDL method
Flashpoint, Vapour Pressure and Viscometer
Colour analyser



Netware Computers Pvt. Ltd (NC), an IT , Security and surveillance with infrastructure company based in Delhi, established in 1991, having 27 years of experience in industrial IT & security solutions .

Now, the organization is a leading, next-generation Technology Company with strong business interests in designing, engineering, commissioning and maintenance of large network for Information & Technology, security surveillance, installation and industrial automation.

Our Solutions Offering:



Industrial Surveillance



Industrial Security



Industrial Communication



Fire Protection



Networking

Our Clientele:



OEM Partners:



Head Office:
 Netware Computers
 D6- 6108 / 5 Vasant Kunj,
 New Delhi – 110070

Phone Number : +91 11 -421 47610
 Mobile Number: +91 9810129785
 Email : nitin@netware.co.in
 sales@netware.co.in



MACHINERY PROTECTION & CONDITION MONITORING

Basic Protection

Reliable cost-effective devices to prevent unexpected downtime and expensive repairs. From the industry leader in field-proven solutions preferred by leading OEMs. Metrix pioneered the concept of simple, affordable machinery protection with our mechanical vibration switch offerings, revolutionary 4-20mA vibration transmitter, robust high temperature velocity sensors, smart digital proximity probe transmitter system, and innovative impact transmitter technology for reciprocating machinery.



Digital Proximity System (DPS)

Eliminate the need for dozens of different drivers and transmitters with a field-configurable device. MX8030 probe and MX 8031 cable comes with standard Vibelock™ Connectors and triaxial cables. For installations with limited clearances at the sides of the probe tip. Choose the New TightView™ Proximity System.



INDUSTRIAL WIRELESS FOR:

WIRELESS: SCADA/ TELEMETRY/ MONITORING/ CONTROL



About Sheetal Wireless:

Founded in 1996, aiming to provide Trusted & Reliable Wireless Solutions.

Consulting Solutions for customized projects in Data & Voice communication in Industrial sectors.

Experts in HF,VHF,UHF, Microwave link networks & V-SAT, GSM/ GPRS Modems for SCADA Systems.

Can provide Communication Systems for various mission critical SCADA Systems.

Consultancy Services, RF Surveying, Supply, Installation, Commissioning, After Sales.

HO: Pune. Employees 60+
Regional Presence – Bangalore, Kolkata, Vishakhapatnam, Udaipur

❖ 25+ Plants: Wireless AAQMS

❖ Wireless Solutions For:

- ✓ Stacker/Reclaimer
- ✓ Paddle Feeder
- ✓ Remote Pumping Station
- ✓ Video Surveillance



❖ Reliance Shahdol:

- ✓ 250+ CBM Well Pads
- ✓ RTU Wireless Comms.
- ✓ CCTV Real Time Comms.



❖ GAIL: PAN India Gas Distribution, 500+ Locations Up & Running GPRS Based



❖ DMR: Digital Mobile Radio

❖ SIMULCAST REPEATERS



Trusted Wireless Solutions – Only @

Sheetal Wireless Technologies Pvt. Ltd.
17 Sheshadri Society, Rambaug Colony, Kothrud, Pune-411038, (MAH)(INDIA).
sales@sheetalwireless.com, www.sheetalwireless.net



www.havi.in

PREFABRICATED HOOK-UPS DBB VALVES INSTRUMENT VALVES & FITTINGS

ONGC
GNFC
BHEL
ESSAR
GSFC
ADCO
ADGAS
GASCO
BOROUGE
TAKREER
ADWEA
PETRONAS

India & International End User Approvals



DBB VALVES



INSTRUMENT VALVES



MANIFOLD VALVES



TUBE FITTINGS



HAVI is the registered Brand of Vipal Enterprises Pvt Ltd. The manufacturing unit is completely Air-Conditioned and Dust Free with latest Technology. The Plant is in compliance with OHSAS 18001 & ISO 14001 spreaded over 25000 sq.feet. It has got In-house Type Testing and R&D Facility. The Company is on the Approved Vendor List of major End Users in India, UAE and Malaysia with exports in over 13 Countries. We have got our Distributor / Agency Agreement in 8 Countries Worldwide.

vipal enterprises pvt ltd.

ISO 9001:2015 certified
2014/68/EU Module H
CE Marked Valves
ASTM F 1387 Re 2012, Type Tested Fittings
MSS SP 99 Type Tested Valves
API 607 Fire Test Design

Bldg No.1, Jhelum Paradise Industrial Estate,
Off Waliv Phata, Behind IPOL, Sativali Road, Vasal East,
District: Palghar, Pin Code: 401208, Maharashtra, INDIA.
Tel.: +91 7410079682.
Email: sales@havi.in



Enabling fluent processes – at any time

Barco's RGB laser rear-projection video walls for the Utilities & Process Control market is optimized for 24/7 use in mission-critical applications. Thanks to our technological leadership and expertise, our video walls have been successfully deployed in multiple applications around the world. With 2x more brightness than mainstream LED-lit rear-projection video walls, Barco's RGB laser series can operate under all lighting conditions, including daylight. Furthermore, unmatched colors, focus and contrast levels ensure immaculate image quality. With an incredible lifetime – up to 11.5 years of uninterrupted operation – this video wall series lasts longer and requires less maintenance. And as they provide higher brightness levels while consuming 25% less power than LED-lit models, Barco's RGB laser rear-projection video walls deliver a very low TCO.



RGB Laser video walls



Controls . Protects . **Performs**

World-class technology in Control valves, in your reach now

KSB MIL, the technology leader in control valves with over 3 decades of providing critical control solutions to the global players in Energy, Oil & Gas, Fertilizer and other process industries.

Our technology. Your Success. And that's a promise. Welcome to KSB

Regd. Office & Works: KSB MIL Controls Limited
Meladoor, Annamanada, Pin 680 741, Thrissur Dist., Kerala, India
Tel: +91 (480) 2695700 · Email: sales.mil@ksb.com · Web : www.ksb-mil.com

► Our technology. Your success.
Pumps • Valves • Service





**ADVANCED TECHNOLOGY
FOR LEVEL AND DENSITY
MEASUREMENT**

**TRUE PROCESS LEVEL, VOLUME AND 3D PROFILE
SILOS / BUNKERS / STOCKPILES**

3D MultiVision

90°
67.5°
45°

Changing the market from level to volume

**MAXIMUM DURABILITY, PERFORMANCE
AND VALUE WITHOUT THE MESS**



**HIGH TEMP
1600°C
94 / 135GHz RADAR
LEVEL TRANSMITTER**

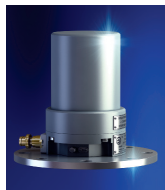
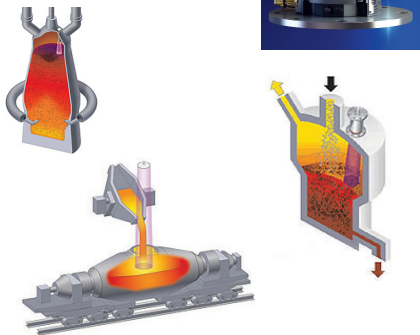

Density measurement
of liquid media and slurries in pipelines, channels and reservoirs

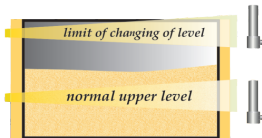

**NON CONTACT NUCLEONIC
DENSITY / LEVEL MEASUREMENT**

**Na-22 SOURCE (EXEMPTED)
NO RADIATION APPROVAL REQUIRED**

Continuous measurement
of level and boundary surface of liquid and loose media

Alarm indication
of level and boundary surface of liquid and loose media

EIP ENVIRO LEVEL CONTROLS PVT LTD
B-45, SECTOR-8, NOIDA-201301, (INDIA)
MOB: 9810181109
TEL. NO.: 91-120-4243333
EMAIL: rgoyal@eipenviroindia.com

INDUSTRIAL SOFTWARE SOLUTIONS

AUTOMATION SOLUTIONS

IT & TRADING SOLUTIONS

Raj Palace, Opp. Sterling App., Priya Hotel Lane,
Athwagate, Surat - 395 001

mkt@ssminfotech.com

www.ssminfotech.com

+91 74900 07267



SSM Infotech Solutions Pvt. Ltd. an ISO 9001:2015 certified company; is India's one of the leading organization since 2001 providing solutions in the field of Industrial Software, IT and Automation solutions.

X-FORCE SOFTWARE SOLUTIONS

X-Force is the brand of SSM InfoTech Solutions and has been a legacy from more than 16 years. There is a wide range of software for discrete needs of Industries including Alarm & Information Management, Energy Management, Calibration Mangement, Documentation Node and many more customized software according to the customers needs.

Alarm & Information Management System

Energy Management System

Calibraiton Management System

E-Logsheet System

Documentation Management System

Availability Base Tariff

Historian System

X-Info CRM Solution

Reporting System

X-Interface System for Pollution Control

Complaint Portal

Event Messaging System

AUTOMATION SOLUTIONS

SSM is partner for Wonderware - the automation software products covering from HMI to MES solutions, OPC software from Matrikon, change management from MDTSoft, PLC and drives from Schneider-Electric, vast range of automation products from Phoenix Contacts, Thin Client from Rockwell ThinManager.



IT & TRADING SOLUTIONS

SSM provide FMS and Networking services as well as Industrial networking products like MOXA, CISCO, AdvanTech & Arista, Time synchronization by Masterclock, Specific Solutions like Acronis backup, WhatsUp Gold, McAfee, QuickHeal and cyber security setup, device monitoring and backup.



SSM InfoTech Solutions Pvt. Ltd. also provides training in Software programming as well as Automation & PLC Programming. The training is provided for students, working professionals as well as to corporate employee teams.

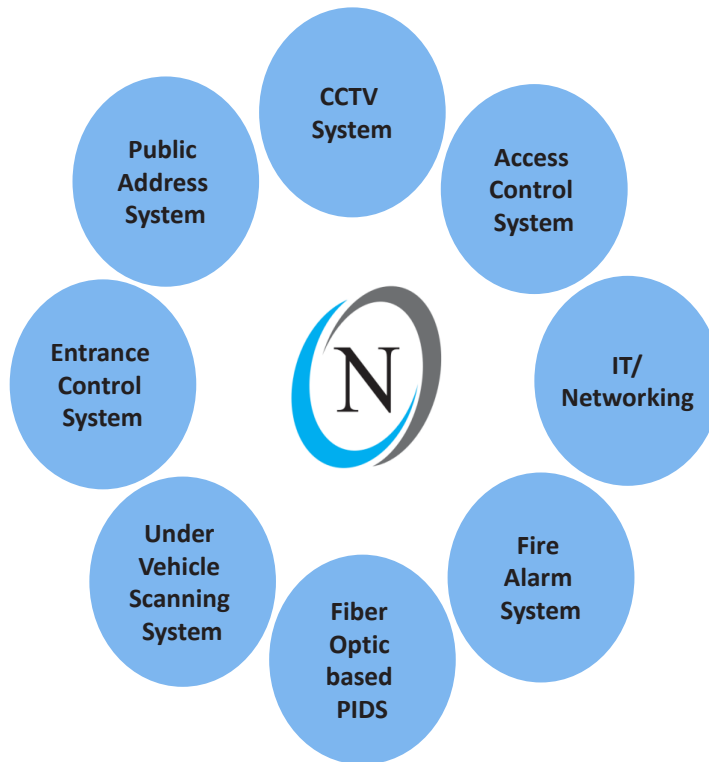

Our Technology Partners

- **CCTV System**
 - Indigo Vision
 - Pelco
- **ACCESS CONTROL SYSTEM**
 - Tyco
 - CEM Systems
- **IT/NETWORKING**
 - Dell
 - Comnet
 - Redlion
- **ENTRANCE CONTROL**
 - Automatic Systems
- **Fiber Optic Based PIDS**
 - Future Fiber Technologies (FFT)

Our Prestigious Customers



Neural Integrated Systems Pvt Ltd,

Unit 117, Sector 1, Building 2, Millenium Business Park, Mahape, Navi Mumbai-400710.

Tel No.022-40996200 Fax: 022-40996266

Email:sales@neuralindia.com

Website: www.neuralindia.com



SAVE ENERGY WITH FINDER

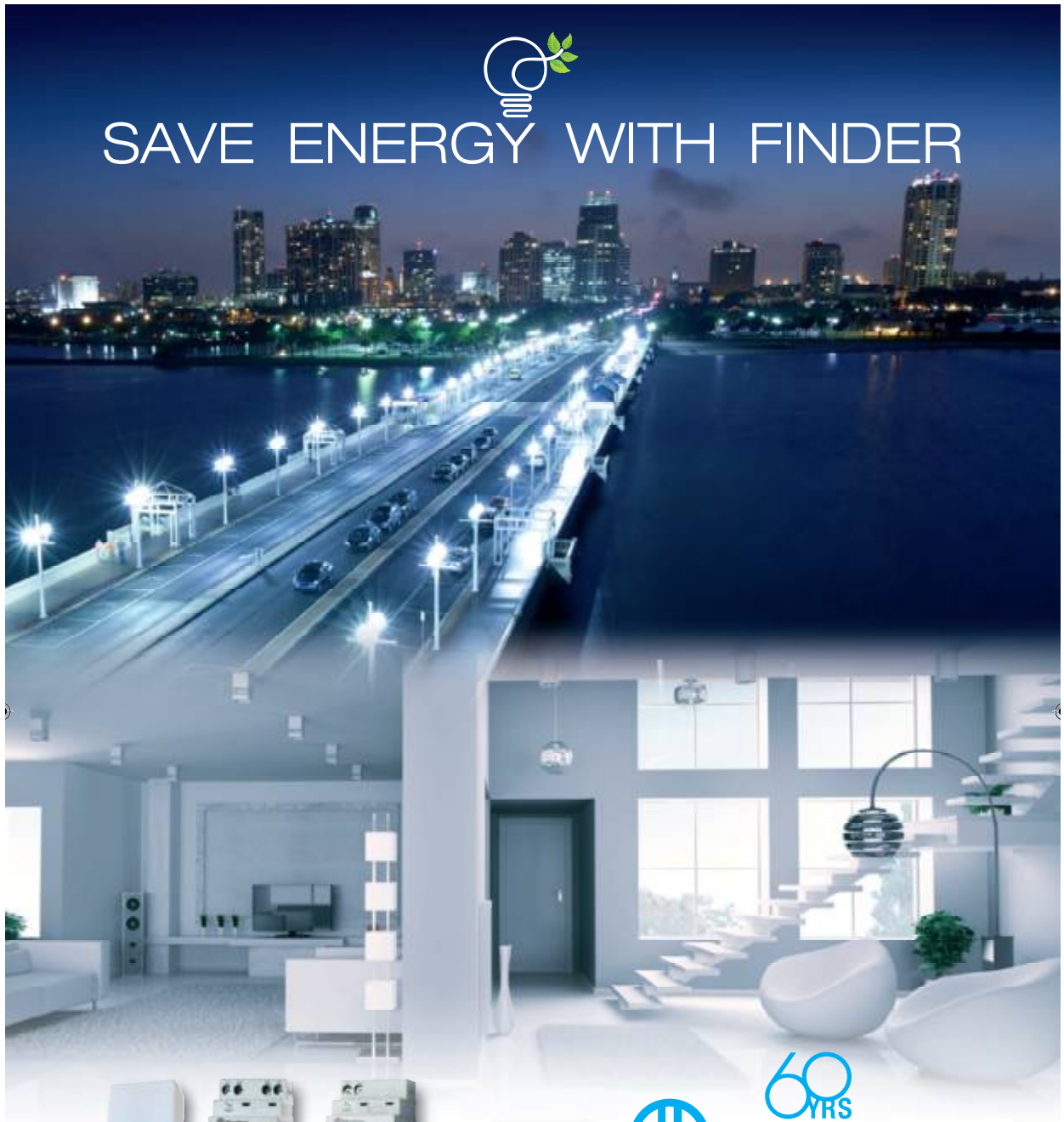

10 - 11 Series
Light dependent relays
Energy saving in a new light !



12 Series
Saves energy
wherever you are
Time switches with
joystick programming



18 Series
An expanding range of
movement and presence
detectors with added
versatility and functionality



FINDER INDIA PVT. LTD.
Unit: No.902 - R.G. Trade Tower,
Nalaji Subhash Place,
Wazirpur District Centre,
Pitampura - Delhi - 110034 - India
Tel. +91-11-47564343
Fax +91-11-47564344
finder.in@findernet.com
www.findernet.com



NOCLE SYSTEMS and CONTROLS PVT LTD

ISO 9001: 2015 Certified

COMPANY OVERVIEW:

Nocle Systems is an engineering solution provider and pioneer in Industrial Automation, Integrated Solutions and Services. We also offer and undertake need for all types of Fire and Gas detection System/Fire Protection & Extinguishing Systems. Provide turnkey solution, Annual service contract, Repairs/Modifications to existing system, Consultancy, Supply of Spares and Services. We offer economically viable solution to customer to meet their need, improve performance & profitability. Our large portfolio and domain expertise enable us to select more suited products and smooth project execution as per customer requirements and schedule. We execute turnkey solutions by applying PMBOK process & knowledge while managing the project by PMP certified professionals.

Our customer includes End Users, OEM, EPC, Panel Manufacturer and Consultants. We understand the requirement of each segment and provide dedicated support and services. Our focus products are Rockwell Automation control system, Information solution-SCADA, Variable Frequency Drives, ProSoft Connectivity Solution, Sensation Fire & Gas detection systems, Aska Fire Protection/Extinguishing system and MSA Personnel Protection Equipment's (PPE's).

- Formerly Elcon Systems Pvt Ltd
- We provides end-to-end, Solutions & Products targeted at various strategic Market Verticals.

SOLUTIONS

- Integrated Architecture Control System
- Plant PAx Process Automation DCS System
- PLC Control & SCADA System.
- Fire & Gas Detectors/ Fire Protection/Extinguishing System.
- ProSoft Connectivity Solution
- Variable Frequency Drives & Soft-Starter Systems
- Instrumentation and Electrical System
- Turnkey Solution & MAC project

Visit us at
www.noclesys.com



SERVICES

- Onsite Commissioning Support
- Online Troubleshooting Support
- Consultancy for Automation/ Fire & Gas systems/Protections(FEED- Front End Engineering & Design)

FOCUSED SEGMENTS:

- Metal, Mining & Cement
- Oil & Gas, Fertilizer
- Transportation (Metro + Railways & Automatic Car Parking)
- Substation Automation & Utility SCADA
- Thermal, PV Solar Power, Water & Waste Water
- Automobile, Paint shop & Assembly Shop Automation

TECHNOLOGY PARTNERS:

- Rockwell Automation
- ProSoft Technology, USA
- Fire & Gas Detection System IMX-SRL, Italy
- Fire & Gas Extinguishing System APPOLO ,UK
- Personal Protection Equipment's KARAM, USA

Offices:

Branch Office:

Corporate Office: A-46, Sector-67, Noida-201301117/110, N Market, Kakadev

Sales Office: C-249, Sector-63, Noida-201301 Opposite Devki Cinema,

Phone: +91-120 4279 380, 4149 992 Kanpur, U.P, India

E-mail: enquiry@noclesys.com, sales@noclesys.com

Registered Office: D-1/299, New Kondli, Delhi-110096



Visit us at

www.noclesys.com

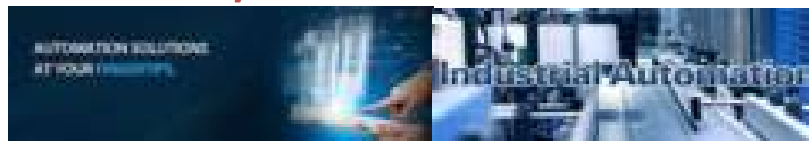



SIEMENS

EATON

(An ISO 9001:2008 Company)
Providing World-Class Technologies & Solutions

ABOUT US

M/S Wissen Automation India Pvt. Ltd. is a private limited company promoted by well-qualified and experienced engineering professionals with years of experience in the field of INDUSTRIAL AUTOMATION SOLUTIONS in association with M/S SIEMENS LTD. WA IPL is guided by the philosophy to provide innovative solutions that follow best manufacturing practices to deliver quality and reliability.



CNC Controller



Siemens Logo



Programmable Logic Controller



Variable Frequency Drive

Corporate Office: E-176, Sector – 63, Noida – 201307 (U.P.) india
Website: www.wissenautomation.com

Regd. Offices: B-994, gharoli dairy farm
Mayur Vihar- III, Delhi - 110096

TOTAL SOLUTIONS



10/10, SECTOR 1, FAWAZA, NEW DELHI - 110079
PHONE: 011-26100000/00001/00002/00003/00004/00005/00006/00007/00008/00009/00010/00011/00012/00013/00014/00015/00016/00017/00018/00019/00020/00021/00022/00023/00024/00025/00026/00027/00028/00029/00030/00031/00032/00033/00034/00035/00036/00037/00038/00039/00040/00041/00042/00043/00044/00045/00046/00047/00048/00049/00050/00051/00052/00053/00054/00055/00056/00057/00058/00059/00060/00061/00062/00063/00064/00065/00066/00067/00068/00069/00070/00071/00072/00073/00074/00075/00076/00077/00078/00079/00080/00081/00082/00083/00084/00085/00086/00087/00088/00089/00090/00091/00092/00093/00094/00095/00096/00097/00098/00099/00100

NETWORK ANALYZERS & POWER
SUPPLY REGULATORS
PRECISE TEMPERATURE & ELECTRIC
CHARACTERS & TEST MACHINES
SERVICING MACHINES & GAS ANALYZERS

Extensive range of Electromechanical Products



1000's of products
across 18 different ranges
Internationally available in
over 65 countries

- ① Control Units
- ② Pilot Lights
- ③ Control Boxes
- ④ Foot Switches
- ⑤ Limit Switches
- ⑥ Sensors
- ⑦ Basic Switches
- ⑧ Rotary Cam Switches
- ⑨ Industrial Plugs & Sockets
- ⑩ Signaling Devices
- ⑪ Motor Protection Circuit Breakers
- ⑫ Level Control Float Switches
- ⑬ Contactors
- ⑭ Industrial Relays & Sockets
- ⑮ Electronic Products
- ⑯ Crane Products
- ⑰ Lift Products
- ⑱ Cable Carriers



Inspiring innovation



www.emasas.com.tr | +90 212 549 2252

Congmax Electro | Unit No.201 RG Trade Tower
Netaji Subhash Place Pitam Pura Delhi-110034
Ph: +91 11-45700559 Email: info@congrmax.co.in

SMART LEVEL TRANSMITTERS



**NON CONTACT
RADAR LEVEL TRANSMITTER**



**GUIDED WAVE
RADAR LEVEL TRANSMITTER**

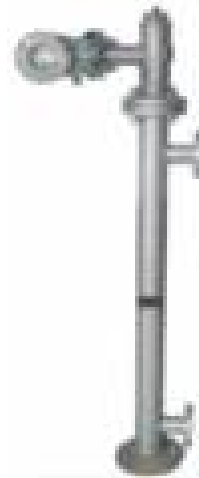

**DISPLACEMENT LEVEL TRANSMITTER
SMART WITH HART / FF PROTOCOL**

ELECTRONIC BOILER DRUM LEVEL INDICATOR

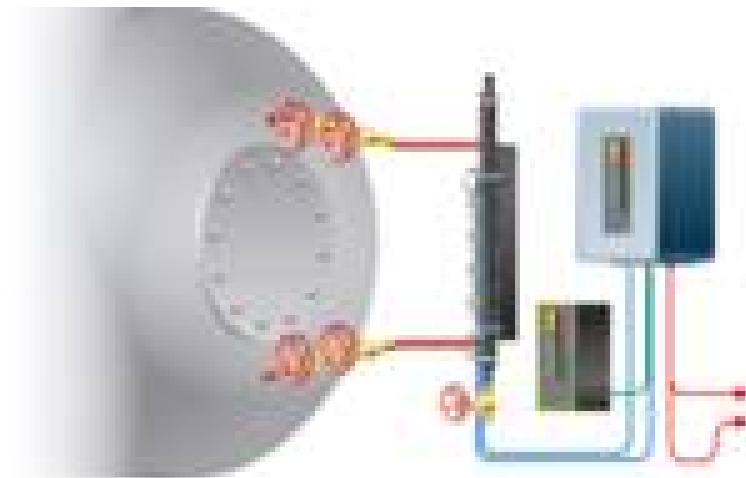

V. AUTOMAT & INSTRUMENTS (P) LTD.

AUTOMAT HOUSE, F-81, Okhla Industrial Area, Phase-I, New Delhi - 110 020, INDIA

Phone : 47627200 (40 Lines) Fax : +91-11-25819440

Email: vautomat@airtelmail.in; sales@vautomat.com;

HITTING TOP QUARTILE MEANS

Reclaiming the dead money buried in your operation

Emerson.com/Reliability



EMERSON

CONSIDER IT SOLVED™

The Emerson logo is a trademark and a service mark of Emerson Electric Co. © 2011 Emerson Electric Co.

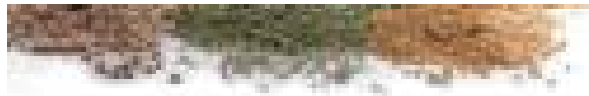

**ADVANCED TECHNOLOGY
FOR LEVEL AND DENSITY
MEASUREMENT**

**TRUE PROCESS LEVEL, VOLUME AND 3D PROFILE
SILOS / BUNKERS / STOCKPILES**

Changing the market from level to volume

**MAXIMUM DURABILITY, PERFORMANCE
AND VALUE WITHOUT THE MESS**



**HIGH TEMP
1600°C
94 / 135GHz RADAR
LEVEL TRANSMITTER**

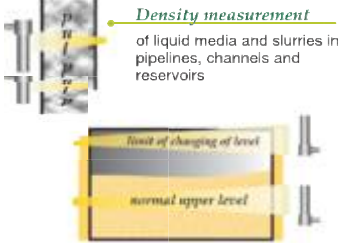
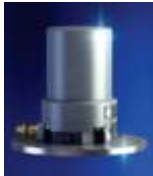

**NON CONTACT NUCLEONIC
DENSITY / LEVEL MEASUREMENT**

**Na-22 SOURCE (EXEMPTED)
NO RADIATION APPROVAL REQUIRED**

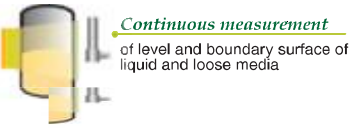

Alarm indication
of level and boundary surface of liquid and loose media

EIP ENVIRO LEVEL CONTROLS PVT LTD
B-45, SECTOR-8, NOIDA-201301, (INDIA)
MOB: 9810181109
TEL. NO. : 91-120-4243333
EMAIL: rgoyal@eipenviroindia.com

Safety Instrumented Systems (SIS) for process industries

Mitigate risks and optimise processes with our Functional Safety (IEC 61511) program.

TÜV SÜD is a one-stop-solution provider for Safety Instrumented Systems (SIS) driven Functional Safety (IEC 61511) programs, catering to highly-critical process industries like petroleum, chemical, oil, gas and power plants. Thus, enabling you to carry out your SIS life-cycle activities effectively and efficiently.

www.tuv-sud.in



South Asia

**Choose certainty.
Add value.**

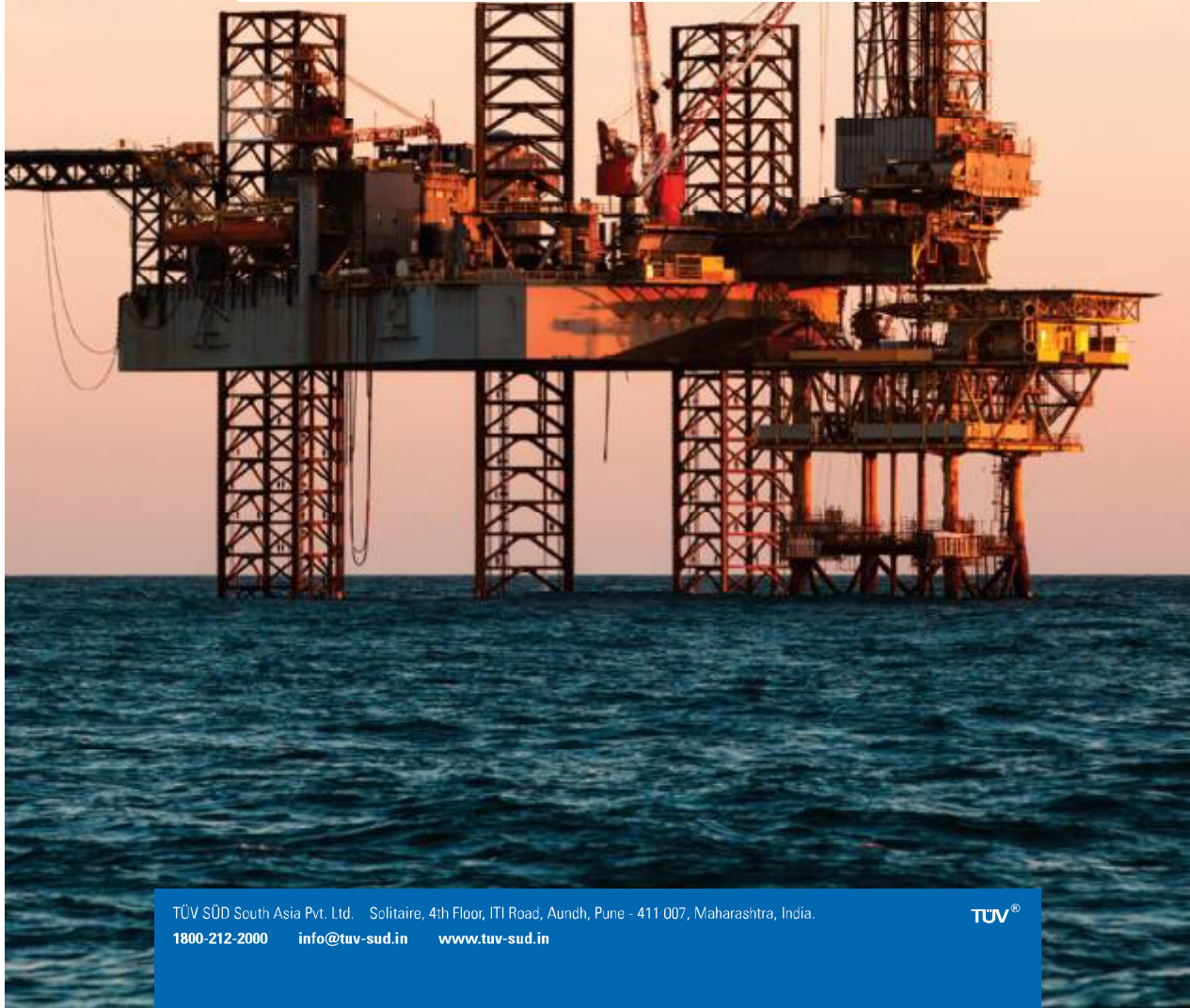

TÜV SÜD South Asia Pvt. Ltd. Solitaire, 4th Floor, ITI Road, Aundh, Pune - 411 007, Maharashtra, India.
1800-212-2000 info@tuv-sud.in www.tuv-sud.in

TÜV®

INDUSTRY ORIENTED RESEARCH CENTRES @ AJAY KUMAR GARG ENGINEERING COLLEGE

TRAINING | CONSULTANCY | RESEARCH | INNOVATION | PROTOTYPING | SOLUTIONS

"Knowledge and Skills beyond books, beyond boundaries"

International Certification

Industry Relevant Training Program

State of Art Infrastructure

Research & Need Based Project



Centre of Excellence in Automation Technology



Advance Manufacturing Centre



Industrial Robotics Training Centre



Advance Welding Technology & Research Centre



NI-LabVIEW Academy



Digital Manufacturing PLM Centre



Reverse Engineering Centre

Key Training & Research Areas

- Industrial Hydraulics
- Industrial Pneumatics
- Reverse Engineering
- Factory Automation
- Sensorics
- PLC & Drives
- Motion Control
- Virtual Instrumentation
- Robot Programming
- Robotic Welding
- Robotic Milling
- Advance Welding



KUKA

fronius

SIEMENS

Rexroth
Bosch Group

AIA

MESSER
Control Systems

stratasys

MITSUBISHI ELECTRIC

NATIONAL INSTRUMENTS

FAIR

JANATICS

FP

SCHMALZ

schunk



27th Km Stone, NH-24, Delhi - Hapur Bypass Road Adhyatmik Nagar, Ghaziabad - 201009

support@akgecskills.in

+91 -0120 -2762084, + 91 -0120 -762086

Follow us



To know more about Training, Research & Consultancy Call Us at: TOLL FREE : 1800-3000-6292, 1800-3000-6484





ISA Delhi Section

ISA Delhi Section

Program Details

Date-21st-22nd April-2017

“Hotel Eros, Nehru Place, New Delhi”

DAY-1	21-Apr-17		Pg no.
Inauguration Session	Time		
Registration	08:30 AM	09:30 AM	
Arrival of Chief Guest	09:30 AM	9:45 AM	
Welcome of Dignitaries	09:45 AM		
Lamp Lighting	09:50 AM		
Welcome address by ISA-D President	09:55 AM		
Address by Guest of Honour	10:00 AM		
Address by Guest of Honour	10:15 AM		
Address by Guest of Honour	10:30 AM		
Address by Chief Guest	10:45 AM		
Release of Souvenir by Chief Guest	11:05 AM		
Vote of Thanks by Convener	11:10 AM		
Inauguration of Exhibition by Chief Guest and Dignitaries	11:15 AM		
Networkig Tea Break	11:30 AM	12:00 PM	
Session-1 :	12:00 PM	01:00PM	
Process and Operation expectations from Automation			
	EIL	Ms. Jayati Ghosh	
	NTPC	Mr. Sudip Nag	
	IOCL	Mr. Sanjay Raizada	
Networking Lunch Break	01:00 PM	02:00 PM	
Session-2	02:00 PM	03:30 PM	
Deploying automation solutions for effective operation and energy management			
1. Li-Fi Instrument Communication Network	Fluor Daniel India Pvt. Ltd	Mr. Sheikh Rafik Manihar Ahmed	3
2. Unified HMIPIS	NTPC	Mr. Somenath Kundu	107
3. Technical Presentation on Comprehensive Lightning protection solution” as per the recently release NBC – 2016 (National Building Code)	DEHN INDIA (P) Limited	Mr. Brijesh Malik	13

4. New Ways of Sampling System Efficiencies in Power Plants	Forbes Marshal	Mr. Mukesh Vyas	17
Smart Quiz with Special Prizes			
Networking Tea Break	03:30 PM	04:00 PM	
Session-3	04:00 PM	06:00 PM	
Workshop & Hands on – Control valve and Analyser system			
Workshop	04:00 PM	05:00 PM	
Control Valve for Severe Service	CCI VALVES	Mr. Tarak Chhaya Mr. Pavitran Kottarathil	35
Physical display of Valve Internals			
Control Valve functioning			
Practical issues faced in valve operation and its solution.			
Case Study			
Workshop	05:00 PM	06:00 PM	
Analyser (Measurement in SRU)	AMETEK	Mr. Jochen Geiger Mr. Ananth Kukkuvada	37
Safety feature in desingining of Anlayser for Hardeous area and Selection			39
Sample handling			
Displaying of Analyser Probe -ASR Probe / HAG Probe			
Analyser Installation : Problem/Issues			
TIME TO VISIT EXHIBITIONS	06:00 PM	07:30 PM	
Networking Dinner	07:30 PM	10:00 PM	
Day-2	22-Apr-17		
Session-4	09:30 AM	11:00 AM	
Cutting edge automation for Environment Management			
1. Critical Steps Towards Healthy Environment Emission and Immission Monitoring	Chemtrols Industires Pvt. Ltd.	Mr. Pankaj Kumar Rai	42
2. Process Mass Spectrometry	Spectrum Automation & Controls	Mr. Brijesh Chowdhary Mr. Mukesh Arora	75
3. Problems when measuring TOC-COD with UV Light	HACH	Mr. G. B. Diwakar	119
4. Non-invasive Ultrasonic high temp flow and concentration solutions.	FLEXIM Instruments Asia Pte Ltd	Mr. Lalit Mohan	133
5. Predictive Emission Monitoring System (PEMS)	EIL	Mr. Sourav Mukherjee	167
Smart Quiz with Special Prizes			
Networking Tea Break	11:00 AM	11:45 AM	

Session-5		11:45 AM	01:30 PM	
Futuristic Automation and Standard & Practices				
1	Industry 4 as Futuristic Automation	Holdor Topsoe	Mr. Atanu Ghoshal Mr. Vidhya Ratna Pal	177
2	Designing THERMOWELLS in Accordance with ASME PTC 19.3 TW-2016	BECHTEL	Mr. Vikas Lodhi	181
3	Secuirty in COTS	NPCIL	Mr. Neeraj Agrawal	187
4	"Electricity Generation by Bicycle And Its Use In Villages To Overcome Health Diseases"	ISA Student Section	Mr. Abhishek Matlotia Mr. Ajay Kumar	209
Smart Quiz with Special Prizes				
Networking Lunch Break		01:30 PM	02:30 PM	
Session-6		02:30 PM	04:30 PM	
Workshop & Hands on – Valves and Level measurement				
Workshop		02:30 PM	03:30 PM	
On-Off Valves		Advance Valves		217
Type Valves for Control Application				
Relative features of different type of Control Valves				
Use of Triple Offset Butterfly Valves for Control Application				
Sizing & Selection of Valves for Control application				
Case Studies				
Demostration of Live Model				
Advance Valves Corporate Presentation				
Workshop		03:30 PM	04:30 PM	
Level Measurement		EIP Enviro Level Controls Pvt. Ltd.	Mr. Abhishek Goyal Mr. Rajat Goyal	219
Solid & Liquid level measurement : Different types & Selection techiques				
Different Technologies/Types & their calibration.				
Troubleshooting steps				
Display & Handson on : Radar ,Ultrasonic, Level Switches etc.				
Panel discussion				
		04:30 PM	05:30 PM	
		End User		
		Automation System Suppliers		
		Consultant		
Felicitations Ceremony		05:30 PM	06:00 PM	
Networking Tea Break and END of the PPAM 2017		06:00 PM	06:30 PM	

