

6. Electric Pitch trim installation



Section objective: Fabrication of the pitch trim tab and inspection hole, and servo motor installation.

Required parts: Right elevator, Ray Allen servo kit T2-7A, Aluminum angle stock 1" by 1" 0.0625" thick, Aluminum piano hinge 18" long 1" open 3/32" pin MS20257-2,

Required hardware: 4 1" long #6 counter sunk screws, 4 #6 timmermann washers, 4 AN365-632 elastic stop nuts, 4 #8 nut plates, 4 #8 1/2" long counter sunk screws, 3/32" counter sunk aluminum rivets.

Required tools: Lightning tool kit. Dremel tool or equivalent, cut-off wheel, sanding blocks, west systems G/5 5 minute epoxy parts A&B, cotton floc, aeropoxy PR2032 resin, aeropoxy PH3660 hardener, epoxy mixing cups, stir sticks, scale, rivet puller.

Required Conditions: Temperature above 60F for 24 hours.

Skills or training: Simple knowledge of hand tools and use, ability to read CAD drawings, ability to properly mix epoxy.

Date
Completed

1. Use the picture below as a reference for locating the cut out for servo, trim tab, and push rod exit.
2. Measure up from the trailing edge 3.25" in several places and draw a line
3. From where this line touches the inboard end, measure out 28.0". This will be the end of the tab, the end of the tab is to be perpendicular to the elevator leading edge.
4. Measure from the same point inboard 9", this is where the pushrod will exit, the motor and tab horn will be inline with this. Draw a line at this point perpendicular to the LE of the trim tab marked earlier.
5. Mark a line to the outboard side of this 2.125" and parallel to it.
6. Mark a line to the inboard side of this 1.625" and parallel to it.
7. Measure forward 5.25" of the LE of the trim tab, draw a line parallel to it
8. Measure forward 9" of the LE of the trim tab, draw a line parallel to it.
9. This should complete a box shape in the correct position which will serve as the trim motor inspection hole.
10. The trim motor inspection hole should measure 3.75" by 3.75".

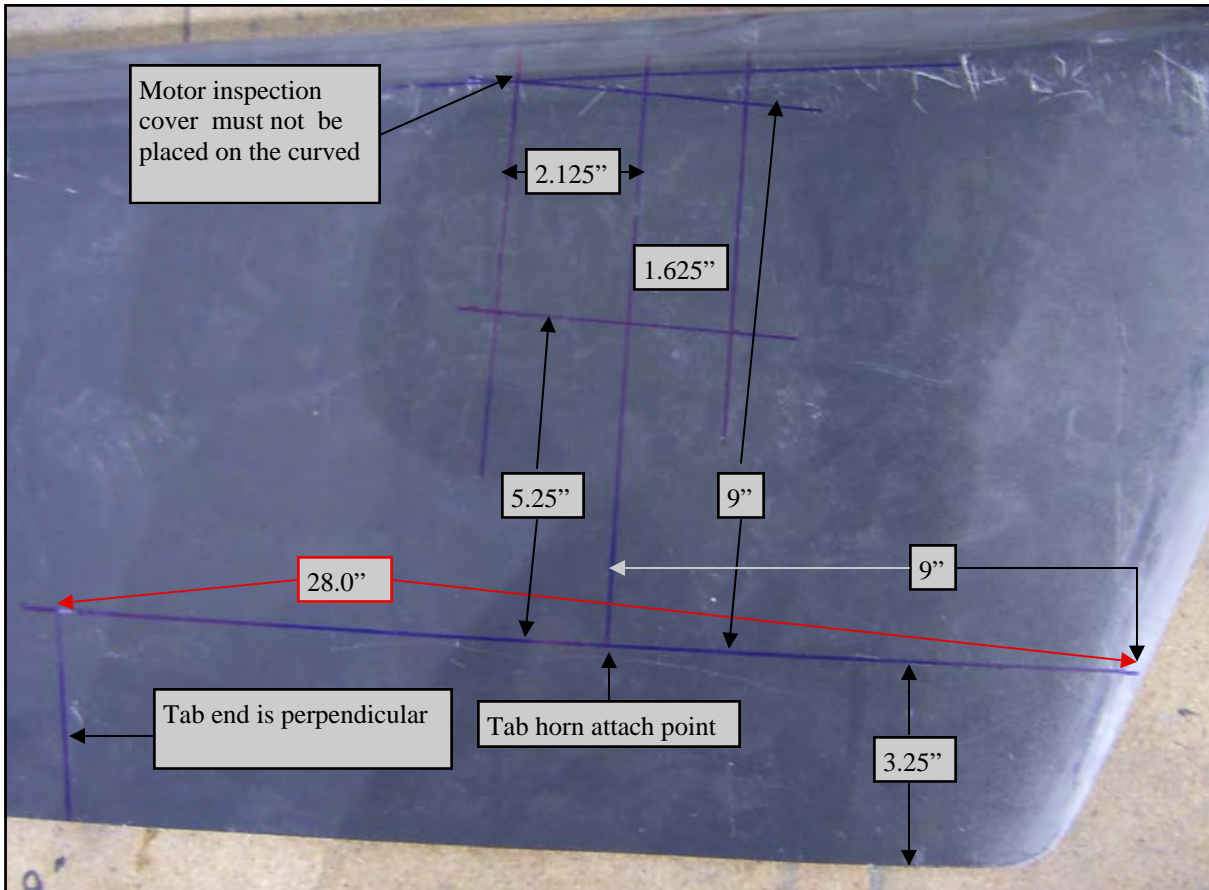

Date
Completed

6. Electric Pitch trim installation



- Carefully cut away the trim tab, a straight cut will keep the hinge line straight. Block sand the cut line that the hinge will bond to, it must be straight.



- Cut the aluminum hinge and pin down to 28".

- Completely sand both side of the hinge flange, that is both hinges both sides.

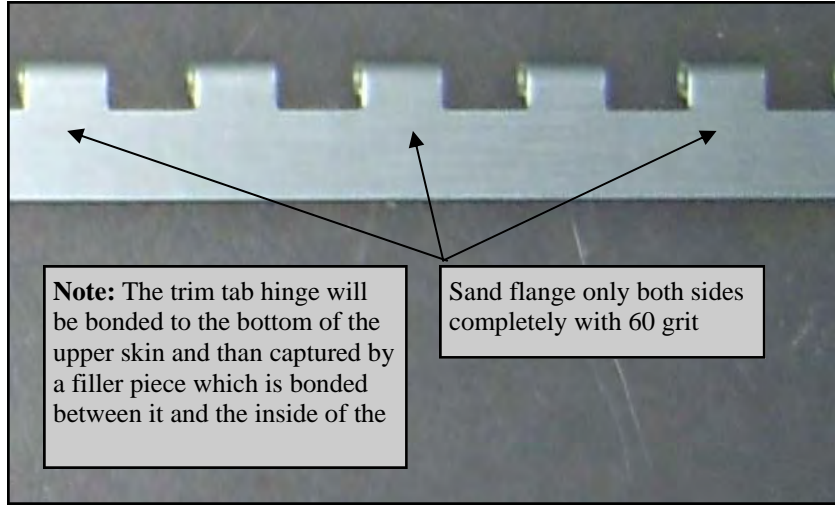

Caution: Sanding the aluminum piano hinge, insides of the elevator and inside of the trim tab skins are very important! Failure to sand these areas well may result in a poor bond and loss of the trim tab.

- Sand the entire length of the opening in the elevator with 60 grit sandpaper.

- The top and bottom must be sanded well for the first 1/2" of depth into the elevator.

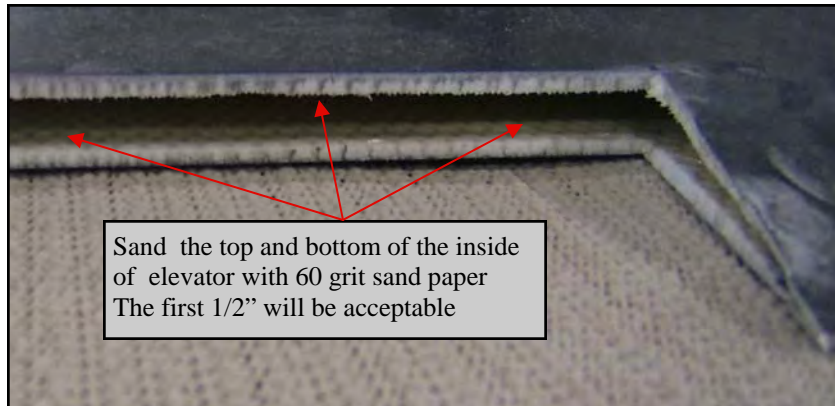

- Sand the entire length of the opening in the trim tab with 60 grit sandpaper.

- The top and bottom must be sanded well for the first 1/2" of depth into the elevator.

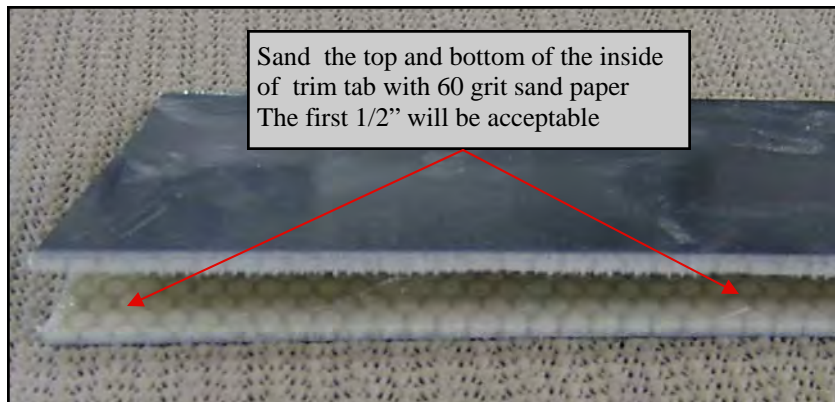

Date
Completed

6. Electric Pitch trim installation



18. Clean all sanded surfaces with acetone.
19. Mix about 2 ounces of 24 hour epoxy.
20. Wet out the contact side of the aluminum hinges and the inside of the upper skin of the elevator and the trim tab. Do this by lightly brushing on the epoxy resin mix.

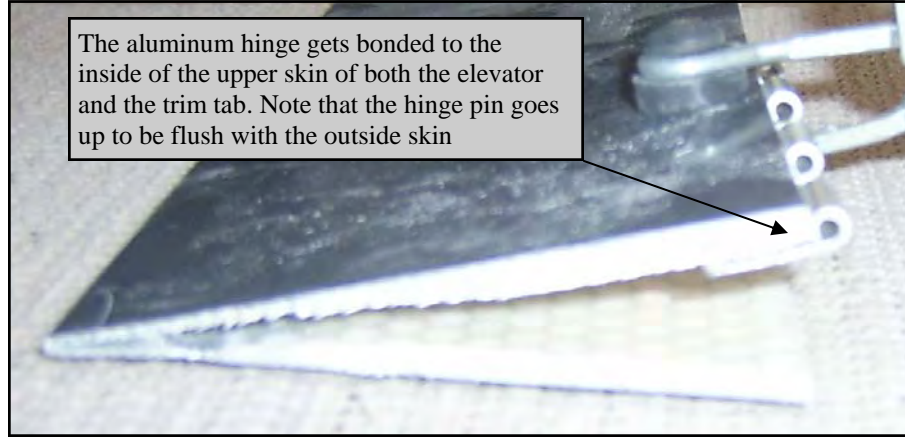

21. Mix the rest of the epoxy with cotton flox until the mixture is like mash potatoes.
22. Spread a 1/16" thick pile on the contacting surface of the aluminum hinge.
23. Clamp the hinge in place as shown in the pictures.



24. The elevator side of the hinge should be spaced so the last leaf has 1/8" clearance to the end of the opening, this will set the tab to elevator spacing.



25. The trim tab hinge should be flush with the outboard end of the tab.



26. Let cure for 24 hours.

Date
Completed

6. Electric Pitch trim installation



- 27. When the trim tabs are cured, Slide the pin thru and check the hinge for binding. It may be necessary to sand the excess glue that may have pushed out under the hinge to get the tab to move freely.
- 28. Once the tab moves freely, check the down travel .The down travel of the tab should be 30 degrees make sure it will go down to 45 degrees for clearance.
- 29. If the tab does not, trim away material carefully from the bottom skin of the tab until the correct travel is obtained.

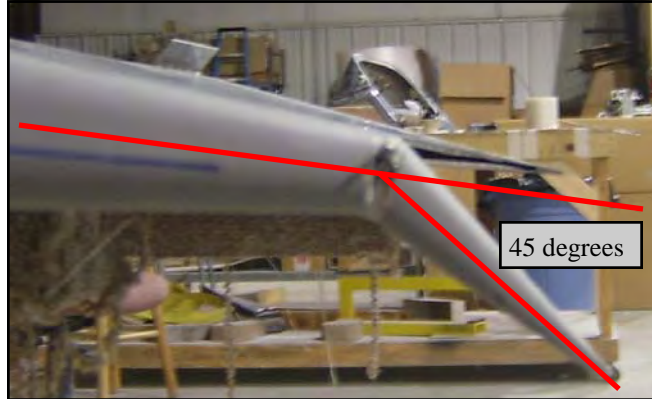

- 30. The kit contains 3 flat 1/4" thick fiberglass foam boards. These are for the baggage area. The flat rectangle ones are the ones you want. Cut a 1" strip off of the end that measure 20.5". The boards are over sized and this will be used to make the filler piece for the elevator and trim tab.
- 31. Take one piece and trim it's length to fit the opening in the elevator.
- 32. Sand the material well on both side to provide a rough



- surface to bond to.
- 33. Mix up about 1.5 ounces total 24 hour aeropoxy.
- 34. Wet the inside of the elevator top skin and bottom skin. Wet both side of the foam insert as well.
- 35. Mix the rest of the glue with cotton flox and apply a good amount to the inside skins of the elevator.
- 36. Push the foam plug into the elevator until flush with the trailing edge, clamp in place.
- 37. Clean up all excess glue with acetone, take time to clean well the piano hinge it self, no glue can be in the hinge leafs.

- 38. As with the elevator, make a foam plug to fit the inside of the trim tab LE.
- 39. The insert in this part must have a bevel to fit the opening correctly.
- 40. Do not glue in at this time.

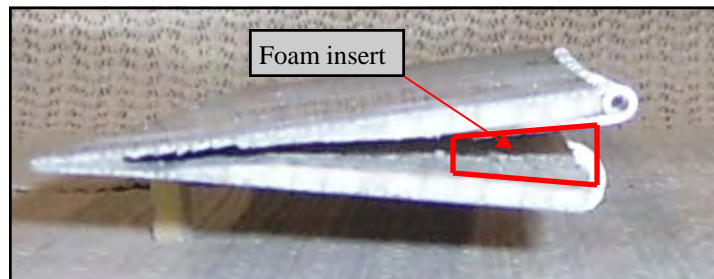

6. Electric Pitch trim installation



Date Completed

41. Use the CAD drawing below to fabricate the trim tab control horn.

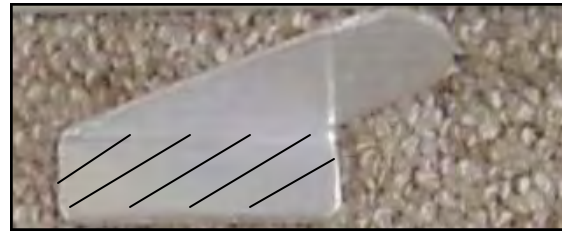

42. Note the picture on the first page, it show the position of the trim tab horn.

43. Cut a slot in the bottom skin of the trim tab that the horn will protrude out of. Do not cut into the upper skin. This slot must be long enough so that the horn can slide into the tab allowing the push rod attach hole in the horn to be even with the hinge line.

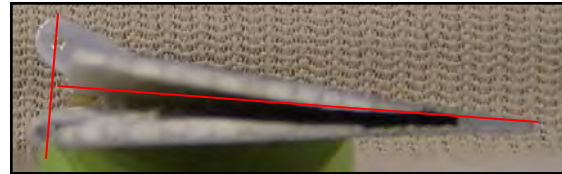

44. When the fit is good, sand the base of the horn and the top of the base of the horn.

45. Mix 1/2 oz of aeropoxy. Wet the horn base and the inside of the trim tab where the horn will be.

46. Mix the rest of the epoxy with cotton flox. Apply a bed of this to the control horn and pack some in the tab.

47. Slide the tab into place, pack more mix in around it to completely capture the horn in the tab, let cure.

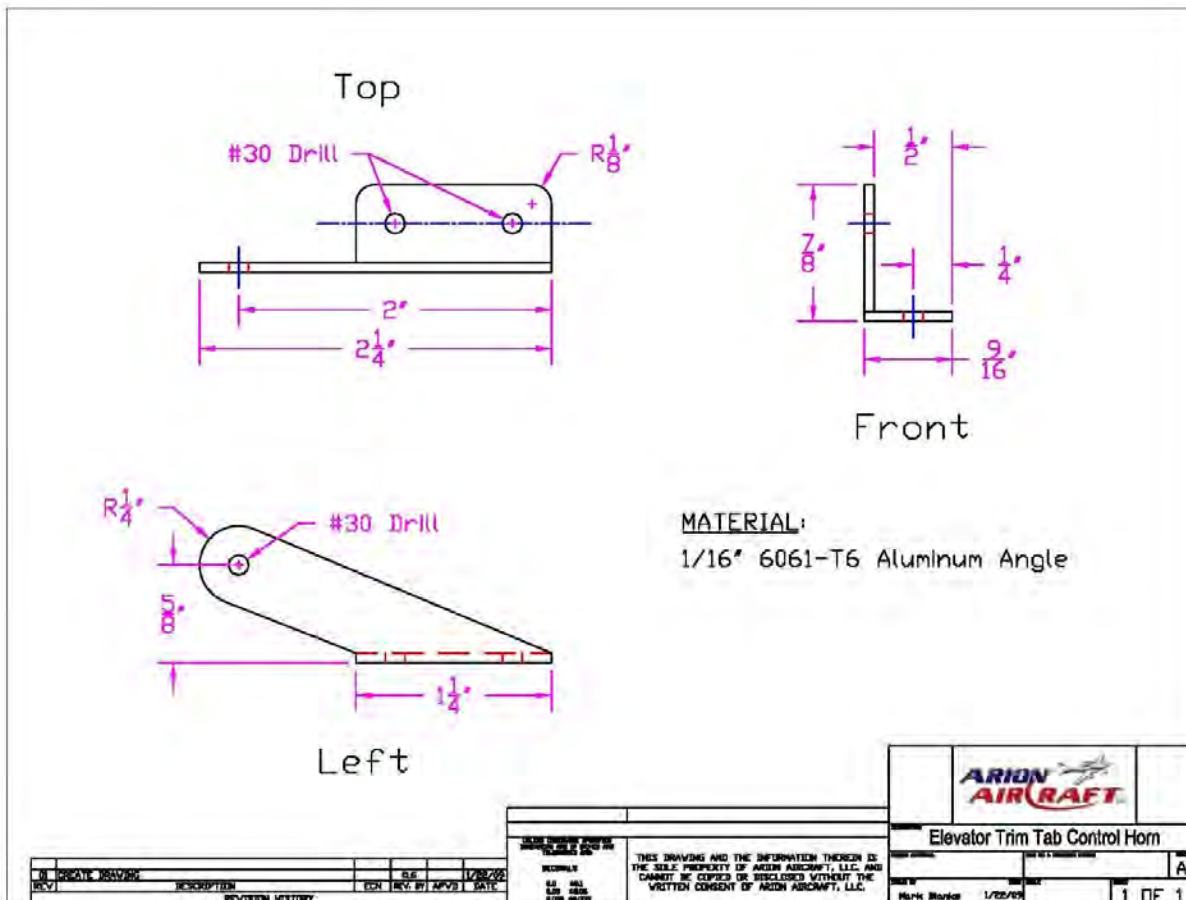

Date
Completed

6. Electric Pitch trim installation



- 48. Cut the filler piece you made earlier to fit each side of the trim tab horn.
- 49. Mix 2 oz of aerpoxy, wet out the inside of the trim tab and both sides of the filler piece's.
- 50. Mix the rest of the aerpoxy with cotton flox.
- 51. Put a bead of flox mix on the inside of the upper and lower skins.
- 52. Push the inserts into the trim tab and wipe up any mix which comes out, it is very important that no mix gets into the piano hinge, and is cleaned up.
- 53. Use small clamps to hold the tab together and let cure for 24 hours. Set aside until latter.

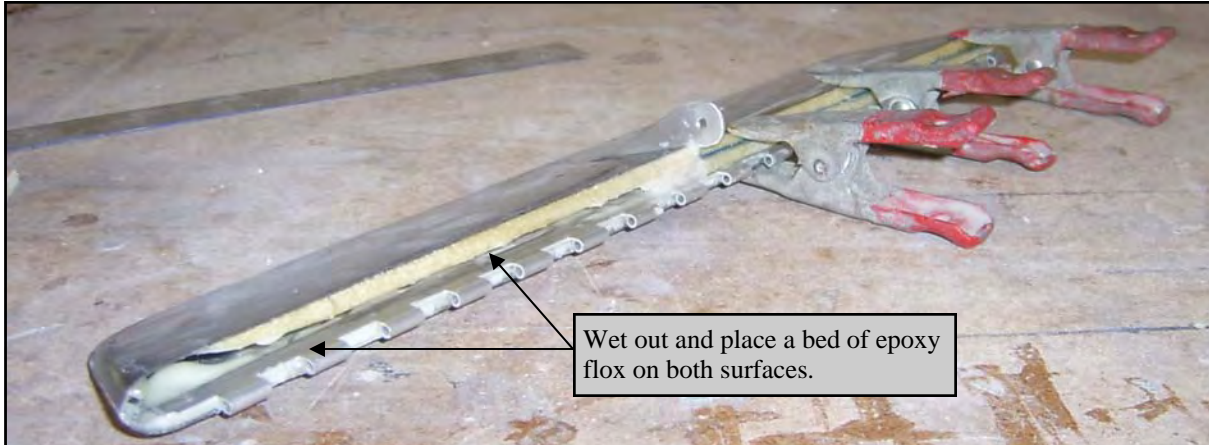

- 54. Cut out the inspection hole drawn earlier on the bottom skin of the elevator. Cut slightly inside the lines so a sanding block can be used to sand the edges straight. Also do not cut the corners a perfect 90, stop short and sand a small radius in the corner.
- 55. Next will be to make the inspection hole flanges for the cover.
- 56. Locate the canopy skins. You may remove 6" mold over run of the skin that will go around the back top of the canopy. If unsure what this looks like check section 43 for pictures.

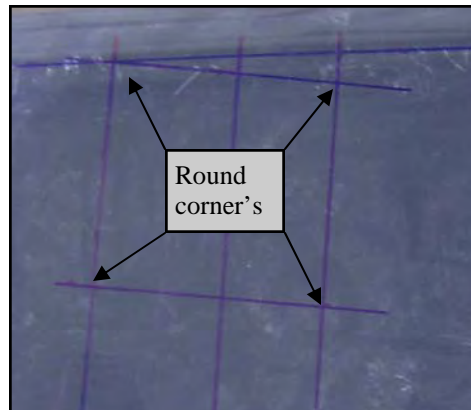

- 57. Cut the fiberglass skin into 4, 1" strips and into 4, 1/2" strips.

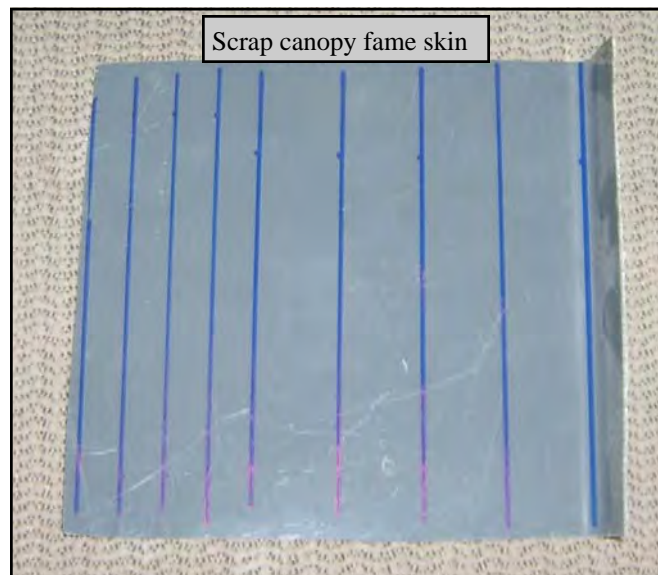

Date
Completed

6. Electric Pitch trim installation



58. The 1" wide strips will be used to fabricate the main flange. The 1/2" strips will be used to make the flange doubler. The elevator skin is thicker than the material to be used for the inspection plate, therefore a doubler is needed.
59. Fabricate 4 main flanges from the 1" wide strips.
60. Fabricate 4 flange doublers from the 1/2" wide strips.
61. Sand the fiberglass side of each main flange.
62. Mix up 5 minute epoxy and add a little flox to it.
63. Spread epoxy flox mix to the wide side of each flange and bond them to the inside skin.
64. Sand the fiberglass side of the doubler
65. Bond the doublers to the main flanges as in the photo at right.
66. Use the scrap material from the other canopy skin to fabricate an inspection cover that fits the hole.
67. Drill 4 evenly matched 3/32" pilot holes thru the cover and flanges. These should be centered in the flanges width and length.
68. In each hole in the flanges install a #8 nut plate.

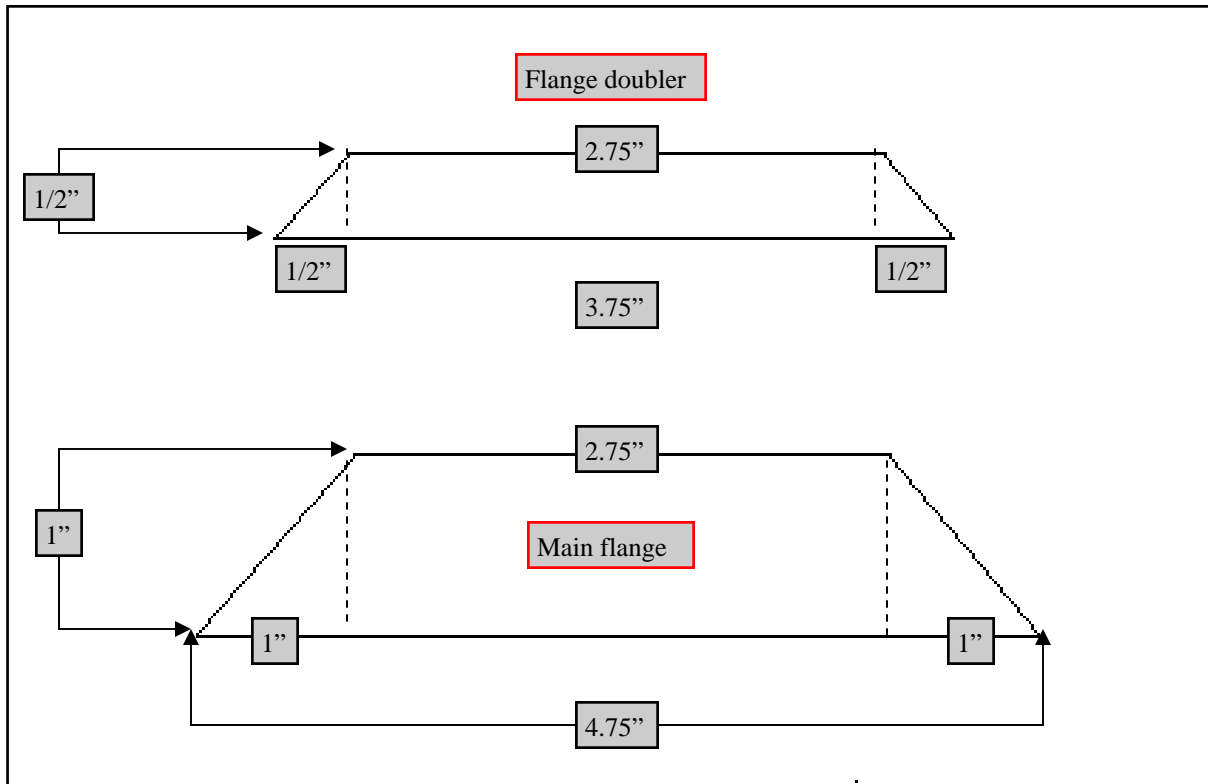
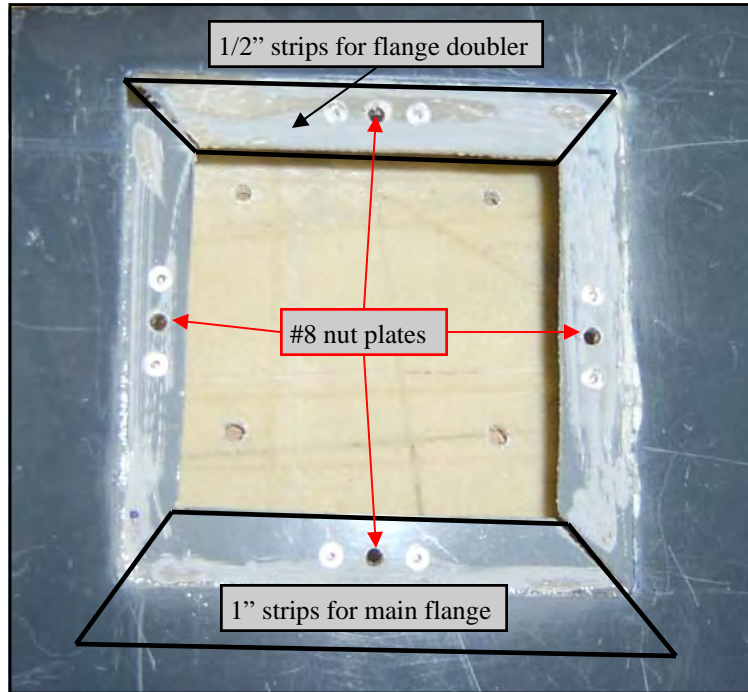

Date
Completed

6. Electric Pitch trim installation



69. Position the trim motor in the opening as shown in the picture. The motor should be centered in the opening.
Note: the flange is omitted in this picture for clarity.



70. Match drill the holes in the motor thru the upper elevator skin with a 9/64" drill bit.

71. Counter sink the holes in the top side of the elevator skin slightly. Use a #6

timmermann washer for reference to the depth required.

72. Do not install the trim motor at this time.

73. The trim motor comes from Ray Allen in the neutral position.

74. Assemble the end of push rod which will connect to the motor. The picture shows the proper placement of the parts, the motor assembly instructions show this too. Do not install the tab end clevis yet.



75. Place the motor in position with the push rod thru the exit hole.

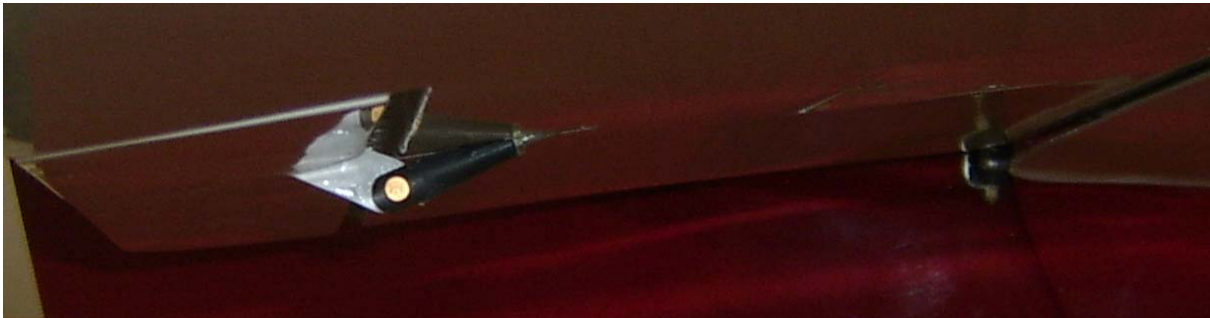

76. Install the trim tab to the elevator.

77. Temporarily pin the clevis to the trim tab horn.

78. The threaded rod should go at least a 1/2" into the clevis. Mark the pushrod to the correct length. Remove the motor and push rod and cut the pushrod to length.

Note: The following steps should be completed after paint and during the final assembly process.

79. Re-install the motor for the final time with 1" #6 counter sunk screws and timmermann washers under the head and nyloc nuts on the back.

80. Thread a jam nut on to the threaded rod as with the motor end of the push rod.

81. Set the trim tab to the neutral position and adjust the clevis accordingly.

82. Assemble the clevis, washers, pin, and cotter key as with the other end.

83. Lock down the jam nuts when finished with the pushrod adjustment.

6. Electric Pitch trim installation



Note: The elevators should be installed for the final time and the servo wired to the leads running to the cockpit at this time. Refer to section 21 for elevator final install and the Lightning wiring diagrams provided at the back of this manual for

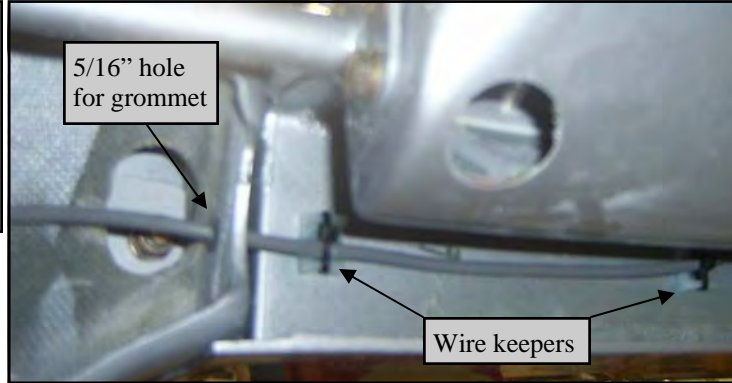

Date Completed

84. A hole must be drilled in the forward face of the elevator spar inline with the trim servo.

85. Drill this hole to 5/16".

86. A 1/4" ID grommet will fit.

87. Run the wires out and along the rear horizontal spar. Use 3 evenly spaced wire keepers to hold in place.

88. Mount the keepers by drilling a 3/32" pilot hole thru the keeper and secure in-place with a 1/2" long #6 sheet screw.

89. A 5/16" hole must be drilled in the side of the tail root near the center of horizontal tail for the wire to pass thru. Use a 1/4" ID grommet here also to prevent the wire from chaffing.

90. Run the wire thru the vertical stab spar in the same manner where ever it fits best in your installation.

91. Typical installation is thru the bulkhead above the 3" access hole. Than thru the bulk head just ahead of the horizontal stabs. Run the wires to the cockpit area along the center of the belly of the aircraft.

92. In your kit a trim indicator and a switch are provided. Install and wire these as per the wiring diagram at the back of this manual..

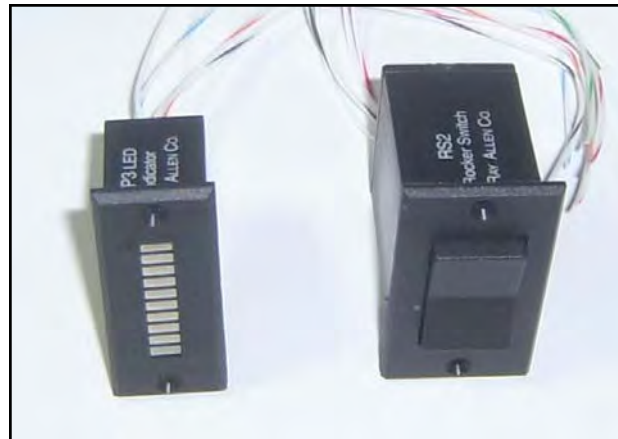

93. When the wiring is complete and power can be applied check the operation of the system. When pushing the top of the switch you will be trimming the aircraft down. This will move the trim tab up and fly the elevator down. When pushing the bottom of the switch this will trim the aircraft up. This moves the trim tab down and flies the elevator up.

94. Also insure that the indicator is operating accordingly.



Warning: The operation check of the trim tab is very important as incorrect operation will be hazardous to the pilot and operation of the aircraft. The tab must move in the correct direction to achieve the correct flying operation.