

*America's oldest, continuous, manufacturer
of archery equipment, pays tribute to our nation's
bicentennial and the twenty-first olympiad.*

1776

stemmler

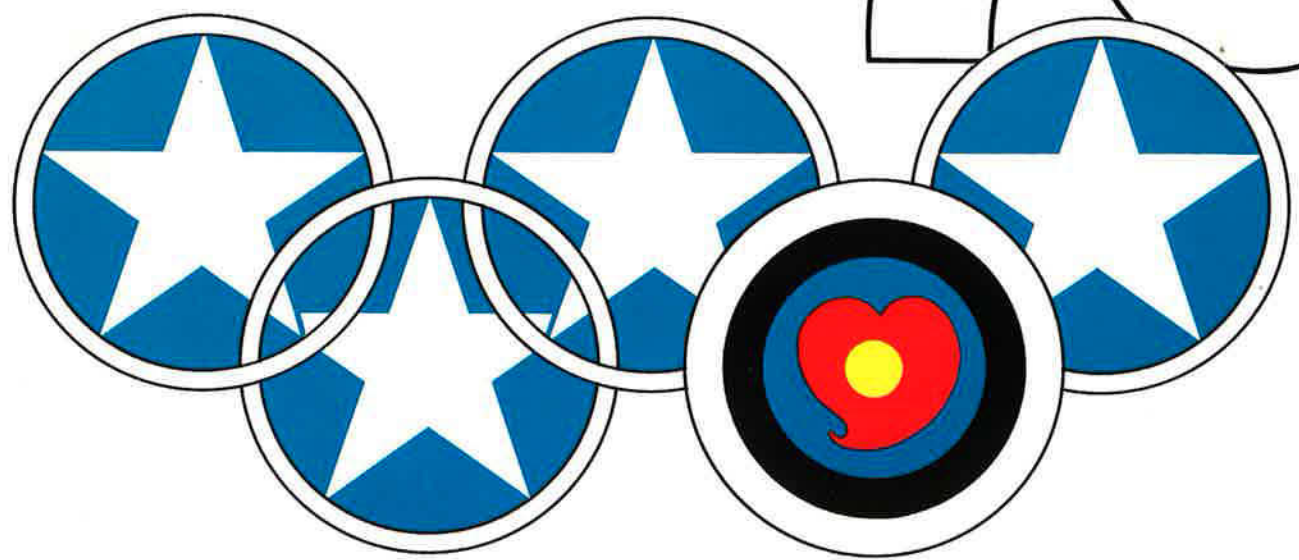

Stemmler Archery

Stemmler is the oldest continuous producer of archery equipment in the United States. For more than sixty years, we have been making bows and arrows and all forms of archery tackle. We feel that our success stems from our meeting the demand for materials and products of high quality.

PROMISES COUNT. Stemmler keeps its promises. We've promised to provide what sportsmen have looked for in quality archery equipment. We have been attentive to the sport we serve, providing important and necessary changes to meet the sportsman's demand. We've continued to deliver where others have failed. Delivery, in fact, has become one of our watch words.

THE DEALER COUNTS. At Stemmler, the dealer counts. He can count on guaranteed fast delivery of quality products and a sufficient back-up of stock to ensure customer satisfaction on re-orders. He can also count on delivery of modern packaging and displays which takes most of the work out of selling our product.

THE CUSTOMER COUNTS. Since selling the customer is the dealer's first priority, Stemmler is continually striving to make your job easier. We deliver and guarantee complete satisfaction of performance in the field, where it really counts. Merchandising of Stemmler products includes new packaging and other sales promotion techniques designed to let the manufacturer assist with more of the point of sales responsibility. Most of the information the customer needs, to let our products 'literally sell themselves,' will be furnished to you.

Stay with America's most experienced archery manufacturer. A progressive company where promises are kept today the same as over sixty years ago.

The Six-Sixty

The all-powerful SIX-SIXTY is the pride of the proficient bowman, commanding respect of the expert. It is a masterpiece of styling, balance and stability, perfect for target or the open range.

Design features reduce vibration, provide effortless draw and negligible recoil. The center-shot handle of exotic imported wood has a superbly formed pistol grip that incorporates a comfortably blended thumb rest. It is hand rubbed to a satin finish.

The SIX-SIXTY has 1-3/4" limbs of fiberglass laminated to inner strips of precision tapered selected maple, providing a remarkably smooth draw. There are laminations at the bow tips for extra reinforcements.

Model No. 2420
Draw weight 30-50 lbs.
Draw length 30 inches
Bow length AMO 66
Left-hand model available.

Hunting and Field Bows

Stalker

Once in a lifetime, the perfect hunting bow comes along. The STALKER, the ultimate companion for the professional archer who puts his skill on the line. In field, or forest, the odds are with the hunter who carries this superb bow.

Strength, stability and effortless draw all combine to add pleasure and satisfaction for the bow hunter who is tired of second best. No compromise on quality or materials results in one of the best hunting bows ever manufactured.

Design features include a full working recurve, laminated fiberglass over selected maple, pistol grip handle with fitted thumb rest, added laminations at the tips for extra strength and the assurance that there's over 60 years of experience that stands behind the STALKER.

Model No. 2440

Draw weight 45-50-55 lbs.

Draw limit 30 inches

Bow length AMO 54

Left-hand model available.

Jaguar

When the experienced hunter takes to the field or forest, he depends on two things, his skill and his bow. He can't afford to have either let him down. The JAGUAR is one of the most dependable hunting bows on the market, and considering its medium price, is perfect for the bowman who doesn't want to compromise quality.

Its lightweight adds to its versatility but doesn't effect the strength of its recurved limb design. Superior stock and laminated fiberglass present an appearance of hand rubbed beauty. The serious bow hunter can take pride in the JAGUAR, secure in the knowledge that it will complement his skill.

Model No. 2450

Draw weight 45-50-55 lbs.

Draw length 29 inches

Bow length AMO 60

Left-hand model available.

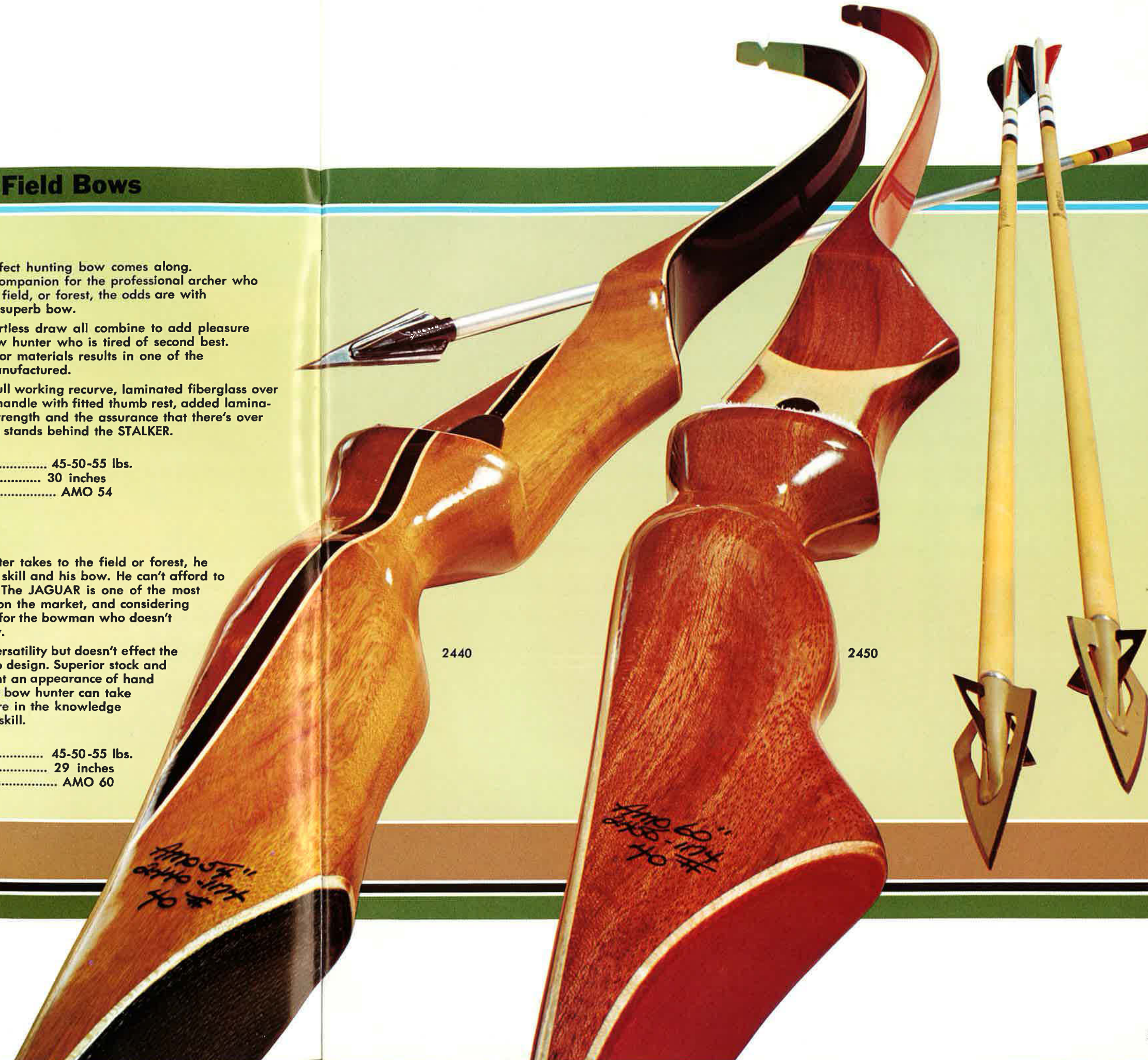
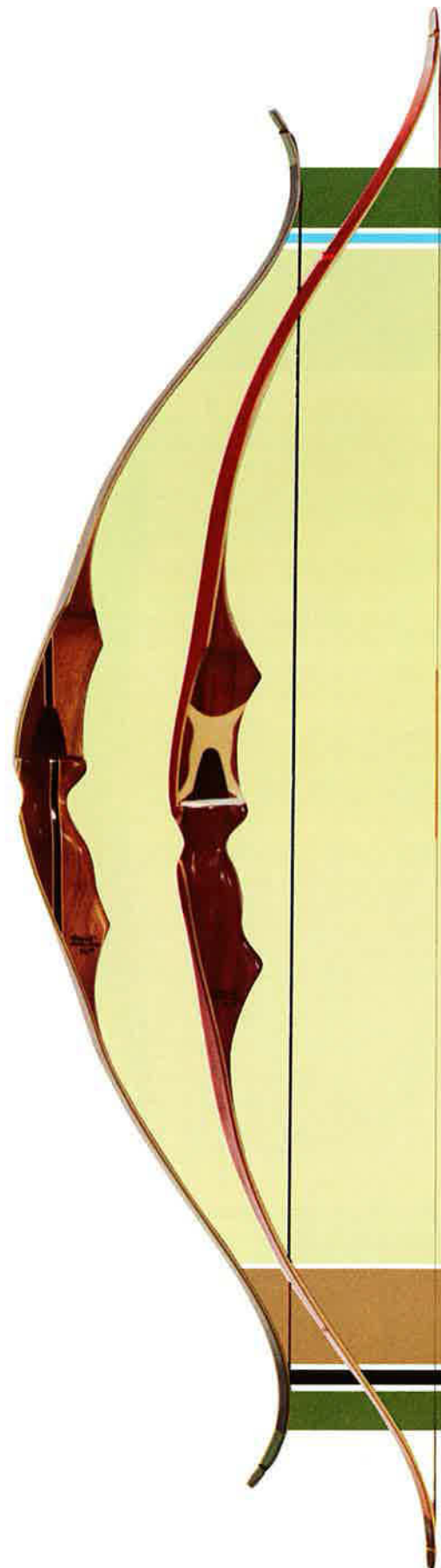

Field and Target Bows

Monarch

When the skilled archer demanded a truly versatile bow, Stemmler responded with the Monarch. Whether nocking a target or hunting arrow, this bow demonstrates how design features can be perfectly blended to provide outstanding performance.

No compromise on quality either. Seldom will you find a moderately priced bow that delivers the punch of Monarch. Sight down its wide window, feel the powerful draw of full-working, recurved limbs.

To ensure consistent accuracy, a professionally sculptured handle incorporates a contoured thumb rest to aid in a smooth draw and provide stability on release.

Model No. 2430
Draw weight ... 25-50 lbs. Draw limit ... 29 inches
Bow length ... AMO 64 Left hand model available

Squire

Like the West Wind, the SQUIRE is designed to carry your arrow to the target with ease and grace. If you've never felt the thrill of the sport of archery, but want to get started in the right direction, this is the perfect bow for you. Even though we've designed it as a beginner's bow, we haven't skimped on quality or professional features.

With a bow like this, it won't take you long to gain proficiency, and when you do, you'll appreciate the center pistol grip, powerful cast and a durability that will give you years of enjoyment on the range.

Model No. 2470
Draw weight ... 20-40 lbs. Draw length ... 28 inches
Bow length ... AMO 60 Left-hand model available.

Hawk

Many of the innovative features highlighted in our best bows are incorporated in the HAWK. Now, the beginner can make his debut in the sport of archery with a bow that ranks among the finest anywhere.

The pistol grip handle and fitted thumb rest assure the young bowman an easy progression to more professional models as he gains proficiency in the sport. Whether the beginning archer is young in age, or just young in heart, the HAWK is the perfect bow to get started.

Model No. 2490
Draw weight ... 20-35 lbs. Draw length ... 26 inches
Bow length ... AMO 48

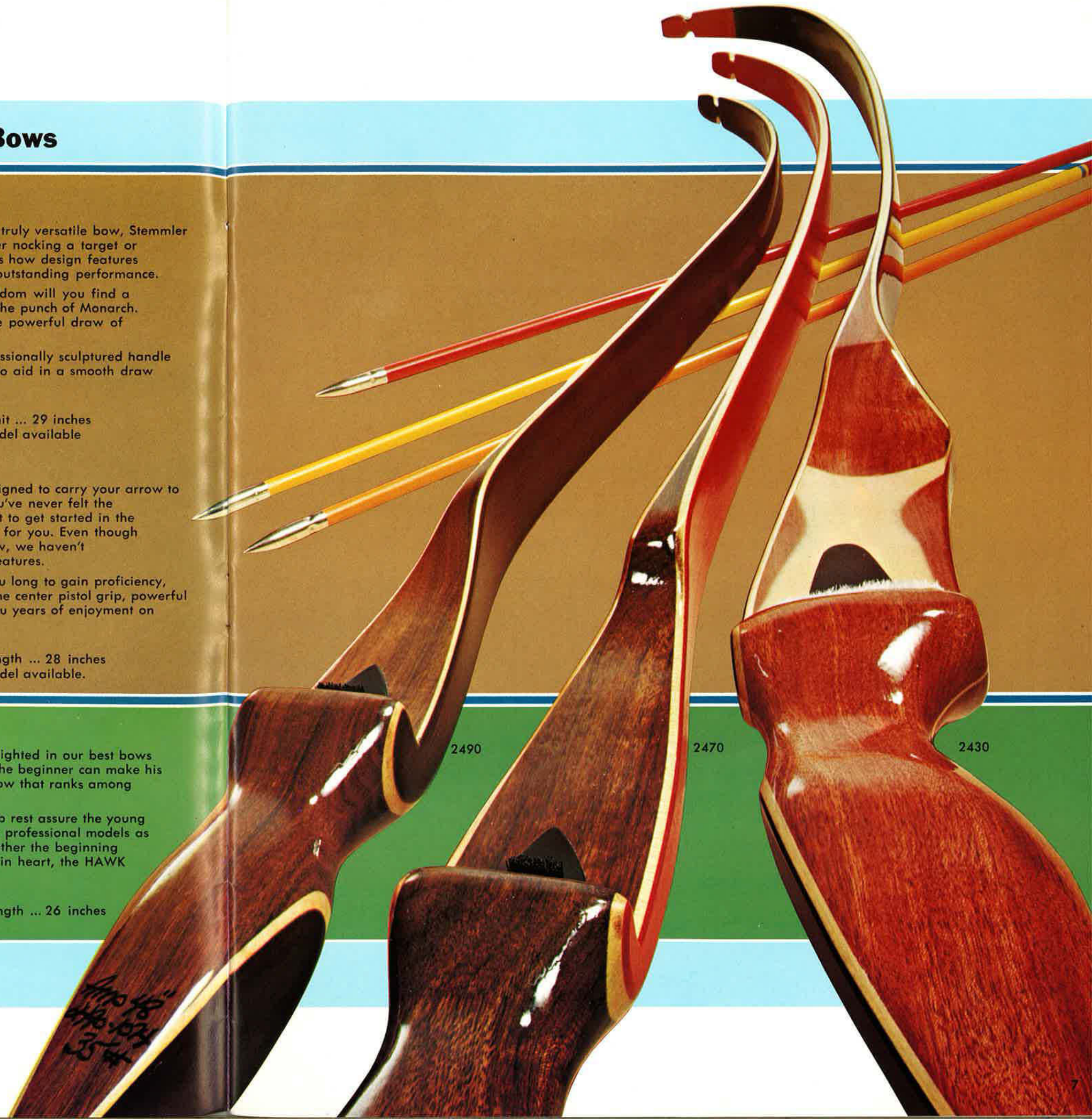

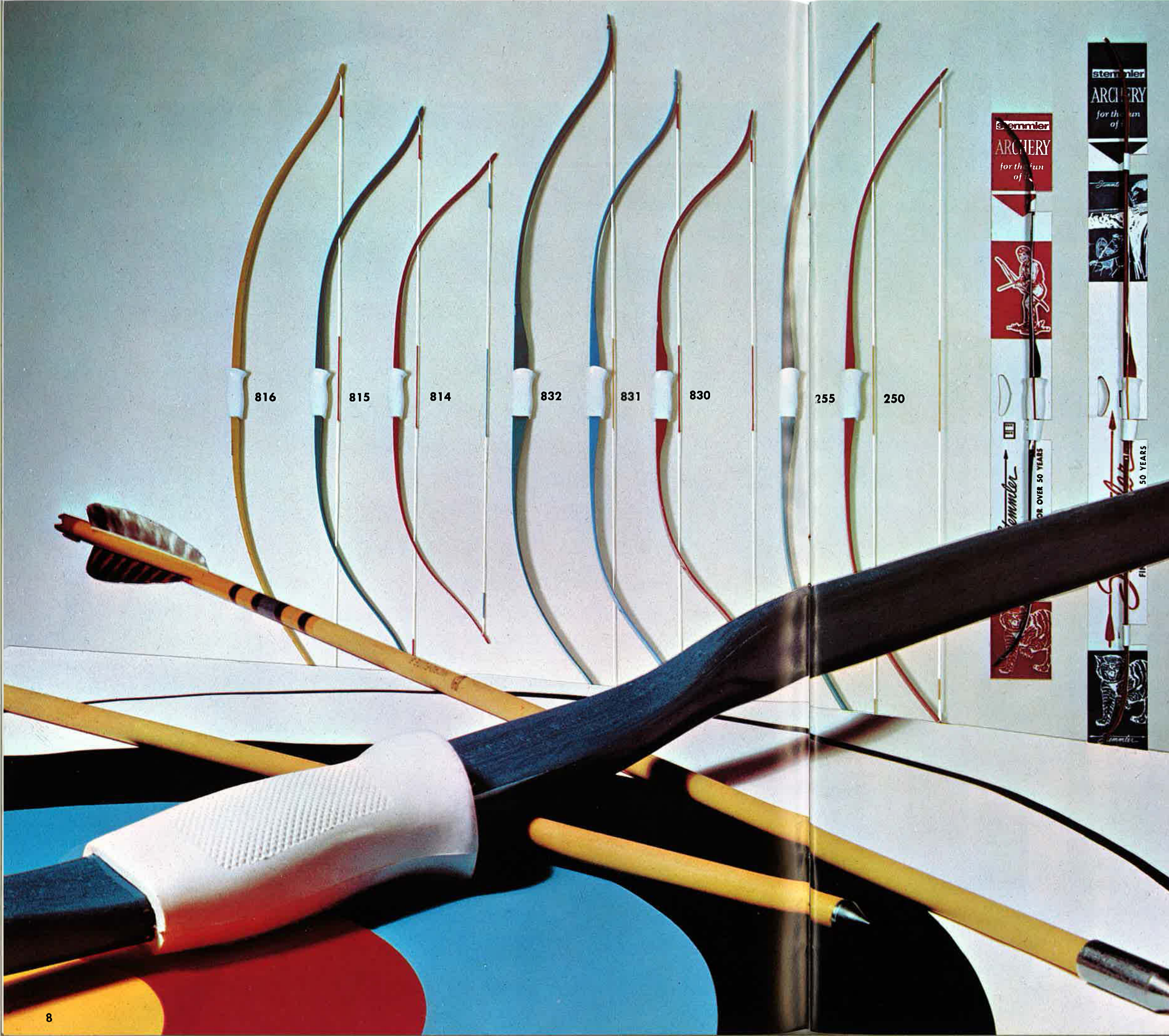

Solid Fiberglass Bows

Years of experience have resulted in our production of the finest glass bows on today's market. Both recurved and straight limb models are handcrafted from pre-stressed and hand laid fiberglass strands. Our process ensures maximum arrow cast as well as bows that are practically unbreakable.

DELUXE RECURVED FIBERGLASS BOWS

Our semi-pistol grip allows comfortable and accurate shooting. Six-inch center shot window eliminates arrow whip. Deluxe, double looped, Dacron Bow String. These three bows offer the finest in beauty and style at a moderate price.

Number	Length	Draw Weight #
830	AMO 46	18 to 20
831	AMO 52	25 to 35
832	AMO 58	25 to 50

POPULAR PRICED FIBERGLASS BOWS

Beautifully finished fiberglass bows with dual arrow rests for right and left hand shooters. Molded plastic handle and braided dacron bowstring.

Number	Length	Draw Weight #
814	AMO 40	15
815	AMO 46	15 to 25
816	AMO 52	25 to 35
As above with Custom Bow String		
822	AMO 52	20 to 35
823	AMO 58	25 to 40

STRAIGHT LIMB FIBERGLASS BOWS

Popular school and camp bows with straight limbs. Great for beginners and constructed to take playground abuse.

Number	Length	Draw Weight #
250	AMO 52	20 to 30
255	AMO 58	25 to 40

STEMMLER ARROWS.

As the sport of archery develops more sophisticated bows, the demand for arrow materials, styles and types becomes more varied. In order to serve these demands, we have one of the broadest arrow selections in style, price and versatility available anywhere. Ordering arrows calls for care. Here are some important things to keep in mind. The length of an arrow is measured from the bottom of the nock slot, to the back of the head. When ordering arrows complete, we need to know the arrow length, and the draw weight of the bow to be used. All of our arrows conform to AMO arrow standards. Proper arrow selection is extremely important for consistent performance.

SWAP point system

Every archer soon recognizes the need for three arrow types when in the field or on the range; HUNT, FIELD and TARGET. The SWAP-POINT system is designed to meet this need head on, creating greater versatility and economy. No longer does the archer have to be restricted to the permanently bound head. No special tools are required, the threading is standardized.

THE ELEMENTS:

No. 8911 INTERNAL ADAPTER.

Designed to fit (internal diameter) fiberglass and aluminum shafts. When ordering be sure to specify shaft size, or the sizes of your present stock.

No. 88 BROADHEAD ADAPTER. Has an external taper that matches the internal taper of our hunting heads (92, 95, 96).

No. 8912 WOOD ARROW ADAPTER. Fits $\frac{5}{16}$ " and $\frac{11}{32}$ " shafts. When ordering there is no need to specify size.

No. 89 FIELD SWAP-POINT.

No. 8910 TARGET SWAP-POINT.

No. 9610 RAZORHEAD fitted with SWAP-POINT broadhead adapter.

We now have in stock all components of the system that enables the archer to create his own multi-purpose arrows. The only element where you must order by shaft size is No. 8911, SWAP-POINT internal adapter.

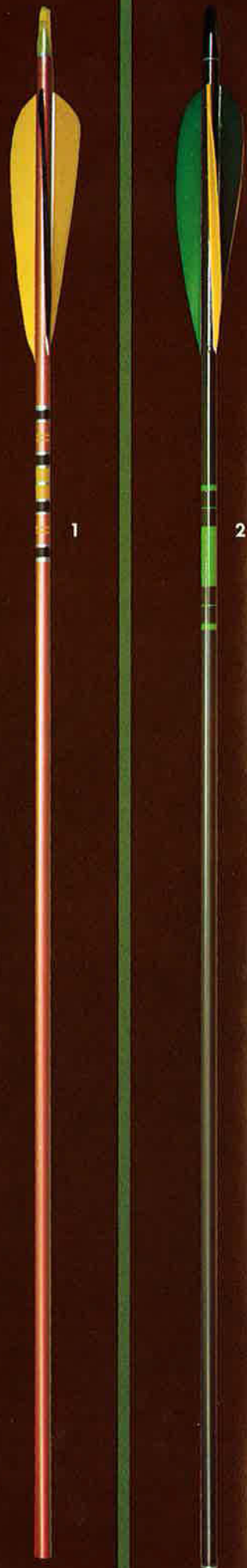
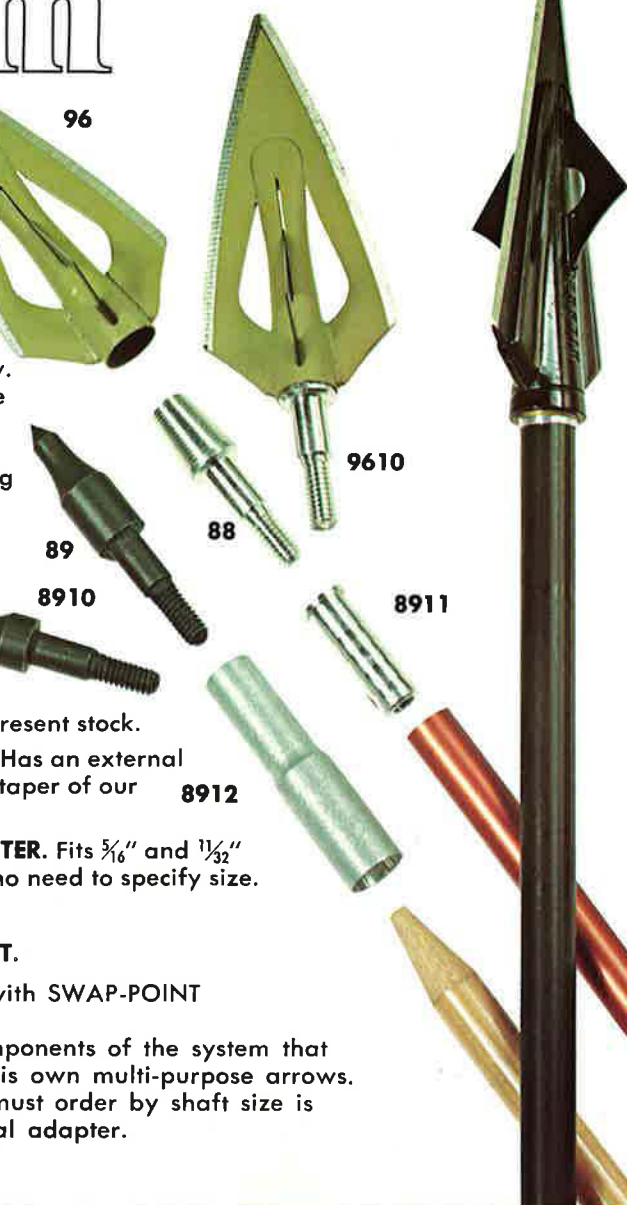

The Arrow For The Most Demanding Archer

1 STEMMLER 'AUTUMN ORANGE' ALUMINUM ARROWS

New AUTUMN ORANGE, non-glare, anodized shaft in sizes for the lightest recurve and all compounds. Stemmler Swap-Point System offers an interchangeability of arrow points to meet the needs of both TARGET ARCHERS and BOW HUNTERS. This EASTON XX75 shaft provides the ultimate in precision and quality. Premium turkey feather fletching, and Pro Fletch Vanes available in full length and specified draw length. Bow draw weights 30/35, 35/40, 40/45, and 50/55.

No. 9010 STEMMLER 'AUTUMN ORANGE' XX75 ARROWS. 1 Dozen Pack. For those who do custom work, these arrows are packed full length with (No. 8911) internal adapters in a separate packet for shop installation. Specify bow draw weight.

No. 9020 STEMMLER 'AUTUMN ORANGE' XX75 ARROWS. 1 Dozen Pack. Fitted with internal adapter. Swap-Point components may be purchased separately for arrow versatility. Specify arrow length and bow draw weight.

NOTE: Add suffix 'P' to style numbers for Pro-Fletch Vanes.

2 STEMMLER EASTON ALUMINUM ARROWS.

No other material lends itself to closer tolerances, and better matching between spine and weight than aluminum. Experienced tournament archers and hunters count on the Easton Swift and Game-Getter shafts for these demanding qualities. A new archer delights in the difference in performance when he first steps up to aluminum. Fletched with premium turkey feathers. All of our aluminum arrows accept our Swap-Point System.

TARGET ARROWS. A good arrow to select for excellent economy, high quality and that competitive edge. Available in full length 26", 28" and 31" draw lengths. Bow draw weights 25/30, 30/35, 35/40 and 40/45.

No. 9210 STEMMLER EASTON ALUMINUM ARROWS. 1 Dozen Pack. For those who do custom work, these arrows are packed full length with (No. 8911) internal adapters in a separate packet for shop installation. Specify bow draw weight.

No. 9220 STEMMLER EASTON ALUMINUM ARROWS. 1 Dozen Pack. Fitted with Swap-Point target points. Specify arrow length and bow draw weight.

HUNTING AND FIELD ARROWS. The popular Easton Game-Getter Shafts Anodized Green for both field use and bow hunting. Available in full length; 29" and 31" draw lengths. Bow draw weights 40/45, 45/50 and 50/55. Also in Pro-Fletch Plastic Vanes. Add suffix 'P' to style number for plastic fletching.

No. 9200 STEMMLER GAME-GETTER ALUMINUM ARROWS. 1 Dozen Pack. For those who do custom work, these arrows are

packed full length with (#8911) internal adapters in a separate packet for shop installation. Specify bow draw weight.

No. 9250 STEMMLER GAME-GETTER ALUMINUM HUNTING ARROWS. 1 Dozen Pack. Fitted with Super Hilbre hunting points. Specify arrow length and bow draw weight.

No. 9255 As above 1/2 dozen pack.

No. 9260 STEMMLER GAME-GETTER HUNTING ARROWS. 1 Dozen Pack. Fitted with Razorhead hunting points. Specify arrow length and bow draw weight.

No. 9265 As above 1/2 Dozen Pack.

3 STEMMLER DURAFILITE YELLOW FIBERGLASS ARROWS.

Fiberglass arrows have no match for toughness. They will not warp, and for strength in the field or in schools and camps they are tough to beat. The Durafilite yellow shafts are the finest fiberglass shafts on the market. We heartily recommend them for schools, camps and hunters. All of these arrows accept our Swap-Point System.

TARGET ARROWS. Durability and consistency combine to make this arrow a top performer for the accomplished archer and an economical arrow for the demands of school and camp use. Available in full length 29" and 31" draw lengths and 25/30, 30/35, 35/40 and 40/45 draw weights.

No. 8010 STEMMLER DURAFILITE ARROWS. 1 Dozen Pack. For those who do custom work, these arrows are packed full-length with (No. 8911) internal adapters in a separate pack for shop installation. Specify bow draw weight.

No. 8020 STEMMLER DURAFILITE ARROWS. 1 Dozen Pack. Fitted target points, #8910.

No. 8025 As above in 1/2 dozen pack.

HUNTING AND FIELD. Fitted with Swap-Point components and furnished in bow draw weights suitable for pre-season field practice and in-season hunting use. Available in full length, 29" and 31" draw lengths. Bow draw weights 40/45, 45/50, 50/55 and 55/60. Also comes with Pro-Fletch Vanes. Add suffix 'P' to style number for plastic vanes.

No. 8030 STEMMLER DURAFILITE FIELD ARROWS. 1 Dozen Pack. Full length shafts with #8911 internal adapter and #89 field points in separate packets.

No. 8510 STEMMLER DURAFILITE HUNTING ARROWS. 1 Dozen Pack. Full length shafts with No. 8911 internal adapter and #88 broadhead adapter in separate packets. Specify bow draw weight.

No. 8550 STEMMLER DURAFILITE HUNTING ARROWS. 1 Dozen Pack. Super hilbre heads attached. Specify arrow length and bow draw weights.

No. 8555 As above in 1/2 Dozen Pack.

No. 8560 STEMMLER DURAFILITE HUNTING ARROWS. 1 Dozen Pack. Razorheads attached. Specify arrow length and bow draw weights.

No. 8565 As above in 1/2 Dozen Pack.

4 STEMMLER GREEN FIBERGLASS ARROWS.

A fine economy arrow constructed with the same fiberglass as top-flight, Duraflite shafts, perfect for the archer and bow hunter who wants performance with economy.

TARGET ARROWS. Specifically designed for schools and camps that require good durability with performance. Available in full length, 26", 28", and 31" draw lengths. Bow draw weights: 25/30, 30/35, 35/40 and 40/45.

No. 8210 STEMMLER GREEN FIBERGLASS ARROWS. 1 Dozen Pack. For those who do custom work, these arrows are packed full length with No. 8911 internal adapters in a separate packet for shop installation. Specify bow draw weight.

No. 8220 STEMMLER GREEN FIBERGLASS ARROWS. 1 Dozen Pack. Fitted with Swap-Point target points. Specify arrow length and bow draw weight.

No. 8225 As above ½ Dozen Pack.

HUNTING AND FIELD ARROWS. The dual purpose flexibility and olive drab color make this arrow a favorite of bow hunters. Available in full length, 29" and 31" draw lengths. Bow draw weights 40/45, 45/50 and 50/55.

No. 8200 STEMMLER GREEN FIBERGLASS ARROWS. 1 Dozen Pack. For those who do custom work, these arrows are packed full length with #8911 internal adapters in a separate packet for shop installation. Specify bow draw weight.

No. 8230 STEMMLER GREEN FIBERGLASS FIELD ARROWS. 1 Dozen Pack. Fitted with No. 89 field point. Specify arrow length and bow draw weight.

No. 8250 STEMMLER GREEN FIBERGLASS ARROWS. 1 Dozen Pack. Fitted with Super hilbre hunting points. Specify arrow length and bow draw weight.

No. 8255 As above ½ Dozen Pack.

No. 8260 STEMMLER GREEN FIBERGLASS ARROWS. 1 Dozen Pack. Fitted with razor-head hunting points. Specify arrow length and bow draw weight.

No. 8265 As above ½ Dozen Pack.



STEMMLER DELUXE MATCHED CEDAR ARROWS.

The finest grade Port Orford cedar arrows, matched to close 5 pound tolerances. Turkey feather fletching at proper length for target, field, or hunting arrows. Target arrows suitable for school or campus competition and hunting arrows for rugged adult use.

5 TARGET ARROWS. Selected and polished cedar shafts with a metal pile head make this arrow perfect for use with high quality equipment. Supplied in 24", 26", 28", and 30" lengths. Stocked in 26" and 28".

No. 5020 MATCHED TARGET ARROWS. 1 Dozen Pack. Specify bow draw weight 20/30, 30/35, 35/50, 40/45 or 45/50.

No. 5025 MATCHED TARGET ARROWS. Pack of 6. Same as No. 5020 but in standard pack of 6.

FIELD ARROWS. Our top quality cedar field arrow closely matched to bow draw weight and fletched to the identical specs of hunting arrows. A good pre-hunting practice arrow. Fitted with 125 grain heads. Top quality 5" helical fletching for excellent flight characteristics. Available in lengths 29" and 31". Bow draw weights 40/45, 45/50, 50/55 and 55/60.

No. 7020 MATCHED FIELD ARROWS. 1 Dozen Pack. Specify both bow draw length and draw weights.

No. 7025 MATCHED FIELD ARROWS. ½ Dozen Pack. Same as No. 7020 but packed ½ dozen.

6 HUNTING ARROWS. Matched cedar shafts selected for rugged hunting use. Premium turkey feather 5" fletching with long low vanes to give maximum accuracy without wind planning. These arrows are for serious bowhunters. Available in lengths 29" and 31". Bow draw weights 40/45, 45/50, 50/55 and 55/60. Specify both bow draw length and draw weight.

No. 1500 MATCHED HUNTING ARROWS. 1 Dozen Pack. Full length shafts without points. Specify bow draw weight. (You cut to length and attach points.)

No. 1530 MATCHED HUNTING ARROWS. 1 Dozen Pack. Three blade heads attached. Specify bow draw weight length.

No. 1550 MATCHED HUNTING ARROWS. 1 Dozen Pack. Super hilbre 4-blade heads attached. Specify arrow length and bow draw weight.

No. 1555 Same as No. 1550 but packed ½ Dozen.

No. 1560 MATCHED HUNTING ARROWS. 1 Dozen Pack. Razor heads attached. Specify arrow length and bow draw weight.

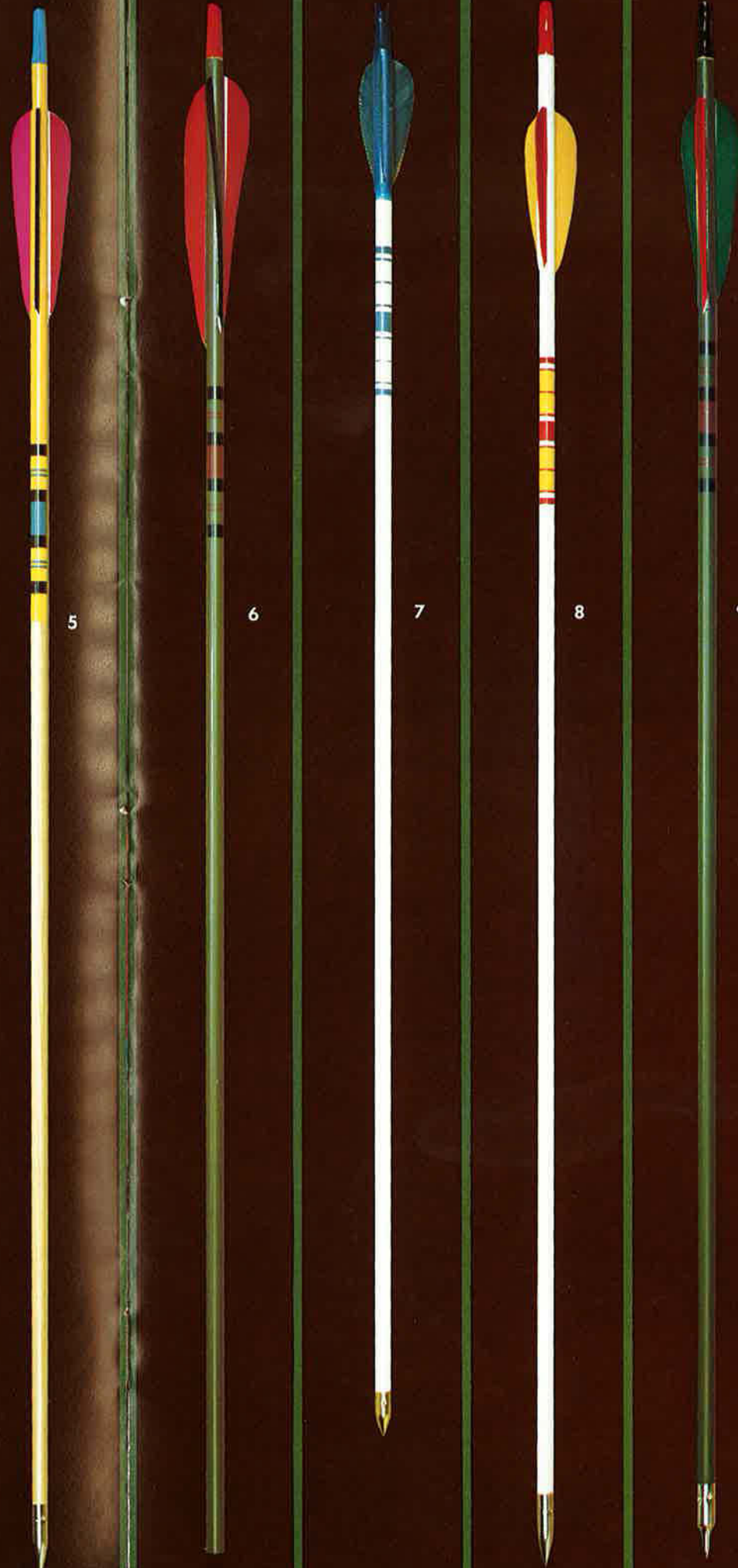

GROSS DISPLAY PACKED ARROWS.

Arrows attractively displayed for self-service selection. Fully lacquered shafts; crested, in popular lengths.

7 PRACTICE ARROWS. Youngster's practice arrows fitted with metal heads and fine-line crests. Lengths: 24", 26", 28". (Standard pack is ⅓ of each length.) May be had in any one length specified.

No. 2210 PRACTICE ARROWS. 1 Gross Pack.

No. 2220 PRACTICE ARROWS. 1 Dozen Pack.

8 TARGET ARROWS. Select Port Orford cedar arrows recommended for schools, camps and ranges. Colorful lacquer shafts with precision fine-line crestring. Turkey feather fletching and fitted with long bullet jacket heads. Lengths: 24", 26", 28". Standard pack is one-half 26" and 28".

No. 3010 TARGET ARROWS. 1 Gross Pack.

No. 3020 TARGET ARROWS. 1 Dozen Pack.

9 FIELD ARROWS. Select grade Port

Orford cedar arrows with non-skid field points. Assorted color shafts with full length lacquer and fine-line crestring. Appropriate turkey feather fletching length to assure excellent flight. Standard length 29".

No. 4010 FIELD ARROWS. 1 Gross Pack. Spined for lightweight bows, 5/16" shafts.

No. 4100 FIELD ARROWS. 1 Gross Pack. Spined to bows up to 50 pound bows, 1/32" shafts.

No. 4115 FIELD ARROWS. ½ Gross Pack. Same as No. 4100, but in standard pack of ½ gross.

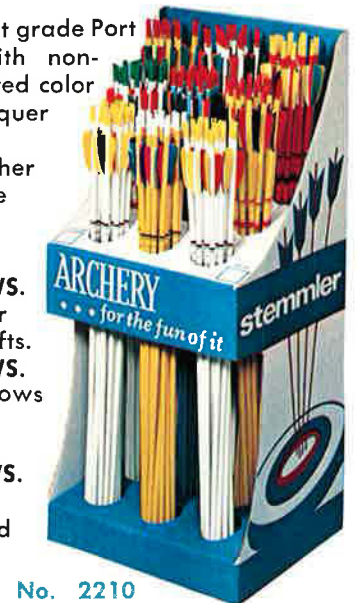

No. 2210

FLU FLU ARROWS. A fine roving arrow for confined areas and as a hunting arrow for tree-perched animals. Spiral fletching acts as an air brake. After initial flight, the arrow slows quickly and dips sharply allowing its easy recovery.

No. 7500 FLU FLU ARROW. 3 Dozen Pack. 5/16" diameter. 30/40 Bow draw weight.

No. 7510 FLU FLU ARROW. 3 Dozen Pack. 1/32" diameter. 40/50 Bow draw weight.



HEAVY LEATHERETTE QUIVERS

These quivers simulate in color and embossing the appearance of genuine leather.

No. 31 BELT QUIVER. This round 16" long belt quiver has earned great popularity with the beginning archer. Holds a dozen arrows easily. Belt loop for attaching.

No. 32 SHOULDER QUIVER. A moderately priced shoulder quiver measuring 2-1/2" round, and 18" long with leather bottom.

No. 35 JUNIOR HUNTING QUIVER. A popular over-the-shoulder quiver with extra large capacity. Contrasting leatherette cuff and heavy leather bottom.

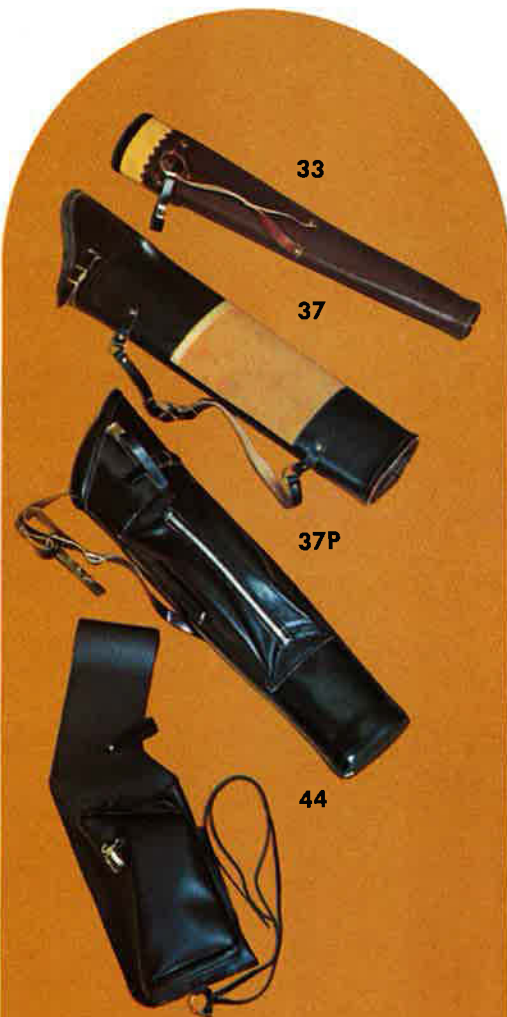

TARGET AND FIELD QUIVERS

No. 33 SIDE SLUNG QUIVER. Top grain leather quiver with comfortable side sling harness.

No. 37 QUIVER. New style belt quiver for field and target archers. Top grain leather with side score card pocket and arrow divider strap. Will hold twelve field arrows easily. Adjustable harness attaches to belt for proper positioning.

No. 37P QUIVER. As above except with full zipper accessory pocket.

No. 44 HOLSTER STYLE QUIVER. Large accessory pocket, score card holder, pencil slot, holds 6-8 arrows, divider loop.



GENUINE LEATHER HUNTING QUIVERS

No. 34 HUNTING QUIVER. Top grain leather hunting quiver with arrow divider strap. Contour leather shoulder strap and buckle for easy shoulder carry. 20" long.

No. 36 DELUXE HUNTING QUIVER. 7" top, 18" long. Leather pocket 3-1/2" x 8-1/2" with zipper. Shoulder harness. All leather.

No. 38 HUNTING QUIVER. All leather quiver with contrasting leather cuff. Shoulder harness and buckle strap for comfortable shoulder carry. Leather bottom and large capacity for hunting arrows.



No. 588 SHIRT AND BLOUSE PROTECTOR. Mesh material for comfort. Specify large or small.

No. 29 FINGER TAB. Tough smooth leather. Small or large.

No. 29M FINGER TAB. Top grain leather in popular Marshall tab design. Specify small, medium or large.



ARMGUARDS FOR TARGET & HUNTING

No. 25N ARMGUARD. Top grain leather with steel reinforcing stay. Elastic cord attachment.

No. 26N ARMGUARD. Intermediate and adult vinyl armguard, reinforced steel.

No. 27 ARMGUARD. Top grain skeleton-type. Spring steel center stay, maximum wrist protection. Leather lining.

No. 28A ARMGUARD. A 7" hunting and target armguard of top grain leather. Fully lined with a reinforcing steel stay. Sturdy leather straps.

No. 28L ARMGUARD. Extra long armguard for maximum protection. Top grain leather with steel stay and adjustable straps.

No. 2810 VENTILATED ARMGUARD of Skeleton Design for cool comfort with maximum protection.



SHOOTING GLOVES

No. 30 SHOOTING GLOVE. A well designed shooting glove, soft vinyl back, single seam finger tips, adjustable wrist strap. Specify small, medium, large, or X-large.

No. 30S DELUXE SHOOTING GLOVE. Single seam top grain leather. Wide elastic form-fitting back and adjustable wrist strap. Specify small, medium, large, or X-large.

Stemmler Archery Sets . . . Fun for the Beginner and Intermediate Archer

Pick an "All-In-One" Archery Package, and the backyard fun begins. The beginner will find a complete package that includes a recurved fiberglass bow, arrows, fidgetab, armguard and paper target, plus Stemmler's ABC's of Archery.

No. 454 RECURVED FIBERGLASS BOW 42" includes four 21" practice arrows with point tip, armguard, fidgetab, target face and instructions. Draw weight: 15 lbs.

No. 456 RECURVED FIBERGLASS BOW 54" Fun for the whole family, including Dad. This larger bow is matched with four 26" cedar arrows. Also included are target face, armguard, fidgetab, instructions and a braided Dacron bowstring. Draw weight: 25, 30 and 35 lbs.

No. 457 RECURVED FIBERGLASS BOW 54" Bow features a full sight window and custom Dacron bowstring. It is perfect for hours of friendly backyard competition. Included are four 26" cedar arrows, target face, armguard, belt quiver, fidgetab and instructions. Draw weight: 25, 30 and 35 lbs.

No. 458 Sure-shot archery can be achieved with this 60" recurved fiberglass bow. Includes four 28" target arrows, armguard, target face, fidgetab, belt quiver, instructions and a custom Dacron bowstring. Specify draw weight: 25, 30, 35 and 40 lbs.

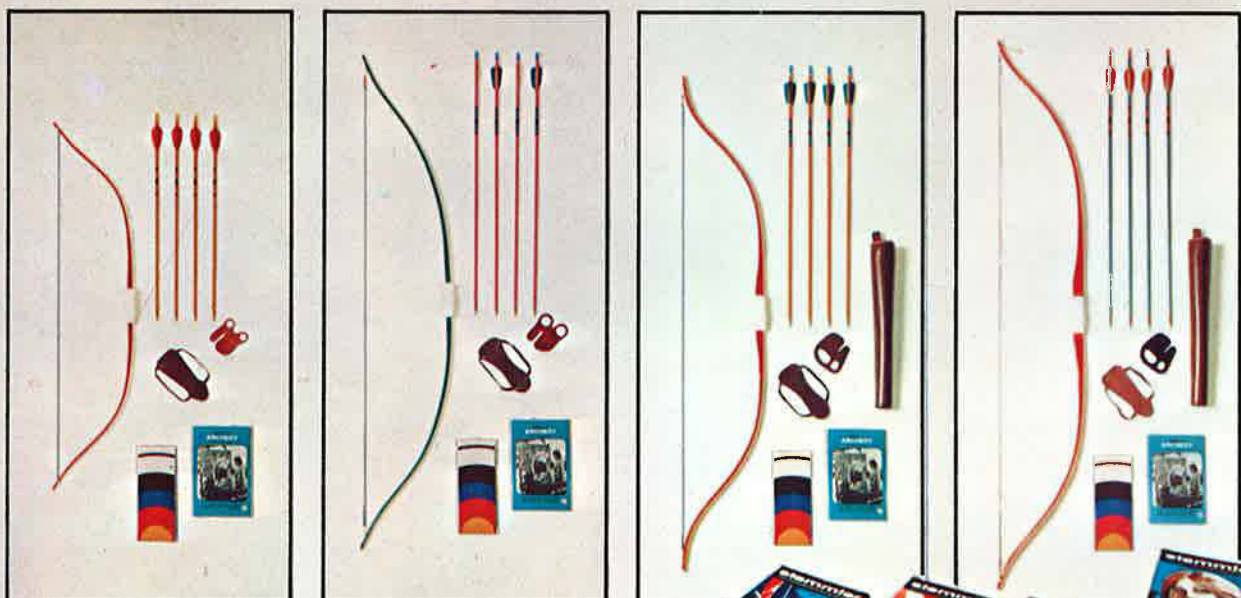

No. 4500 ARCHERY DISPLAY RACK

Attractive floor display . . . features complete archery set. Compact! Free standing, wire fixture makes excellent self-sell unit, weighs only 11 pounds, flat black finish. Assembles easily, quickly! No tools required! An instant archery department that takes less than 4-1/2 square feet. Holds 30 sets of any mix. We recommend twelve #454, six #456, six #457 and six #458.

No. 4510 ARCHERY DISPLAY RACK

As above, but holds 18 sets of any mix.



stemmler
THIS SET INCLUDES: CUSTOM CRAFTED STEMMLER BOW, CEDAR ARROWS, ARM-GUARD, SHOOTING TAB, TARGET FACE, ABC'S OF ARCHERY, DACRON BOWSTRING.



Stemmler Sets . . . for the Advanced Archer

Assemblage for the more serious archer might include a full working limb composite bow with camouflaged backing, four matched hunting arrows, a Hush Bow Quiver. Here is instant archery by Stemmler, providing enough variation of packaging to please the beginner or expert, adult or youngster, target shooter or hunter.



633



634

No. 633 A perfect target archery set, featuring our HAWK Bow for a young archer. Four cedar arrows, armguard, finger-tab, target face, and the ABC's of Archery. Bow length AMO 48. Specify draw weight: 20, 25, or 30 lbs. Packed six per standard carton. Weights assorted.

No. 634 A custom crafted SQUIRE Bow target archery set, great for a family outfit. High quality cedar arrows, armguards, finger-tab, belt quiver, target face and complete instructions. Bow length AMO 60. Specify draw weight: 20, 25, 30, 35, or 40 lbs. Packed six per standard carton. Weights assorted.



633

634

Stemmler Sets . . . for the Bow Hunter

No. 431 This bow hunter's outfit boasts our SQUIRE, a composite bow. The modest price includes four select hunting arrows, bow quiver, armguard and fingerguard, plus practice target face and instructions. Draw weight: 20-40 lbs.

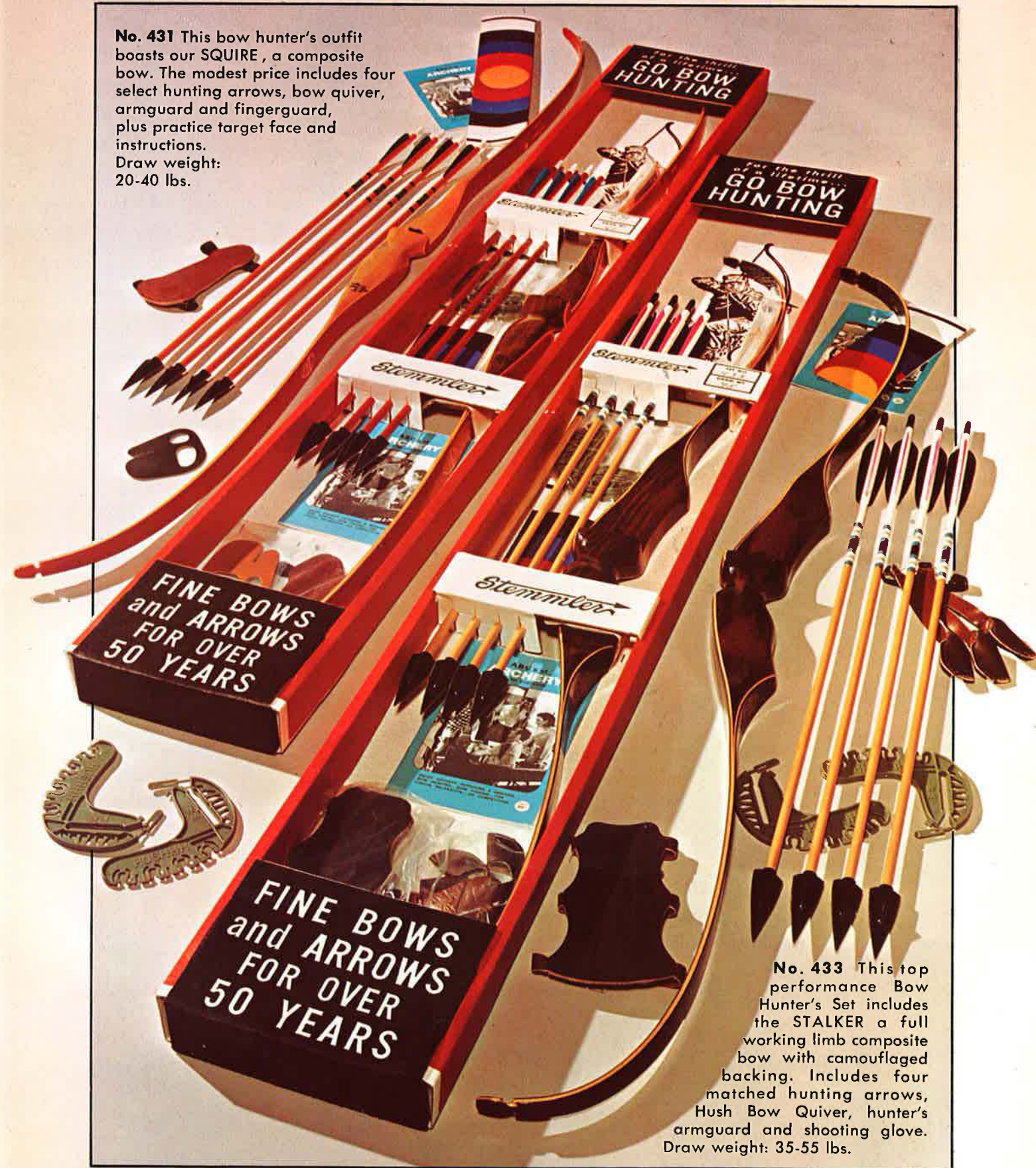

No. 433 This top performance Bow Hunter's Set includes the STALKER a full working limb composite bow with camouflaged backing. Includes four matched hunting arrows, Hush Bow Quiver, hunter's armguard and shooting glove. Draw weight: 35-55 lbs.

Stemmler Sets . . . for the Versatile Archer

No. 430 An introductory set that takes you out-of-doors for field shooting or hunting. Your fast 60" center-shot fiberglass bow will provide many a thrill. It comes with three hunting and three field arrows, bow quiver, armguard, fingerguard, target face and instructions. Draw weight: 40-55 lbs.

No. 432 Here's the JAGUAR with powerful recurve design, fiberglass laminated to wood, the perfect backwoods companion. Includes four two-blade hunting arrows, Hush Bow Quiver, hunter's armguard and shooting glove, target face and instructions. Draw weight: 25-45 lbs.

No. 631 Backyard Targeteer Family Fun. Includes 54" recurved fiberglass bow, six 28" target arrows, armguard, 24" crintex target, belt quiver, aluminum target stand, shooting tab and instructions. Draw weights: 25, 30 and 35 lbs.

No. 632 Sportsman Kit. Fun for the Backyard Hunter. Includes 54" recurved fiberglass bow, six 28" target arrows, armguard, 24" crintex target with animal face, belt quiver, aluminum target stand, shooting tab, camouflage bow cover and instructions. Draw weights: 25, 30 and 35 lbs.

JC 44 Youngsters archery set with four cedar arrows and target face. Bow length AMO 40. Draw weights: 15 lbs.



No. 632



No. 631



JC44

Bow-Fishing Equipment

You move towards the big fellow as he treads momentarily close to the surface. You're very careful that your shadow does not betray you. You nock your arrow onto the bowstring and soundlessly draw back. Steady. Release. Below, there's a momentary thrashing at the surface. The fish begins to lung and take line. Then silence.

Reel him in. He's yours. And so is all the fun of one of the oldest sports the world has to offer . . . BOW FISHING.

No. BFS-1 SPECIAL BOW-FISHING SET. Handsomely boxed. Fiberglass Arrow, Aluminum Bow Reel. 60 feet of line.

No. 86 DOUBLE BARB FISH POINT. Pointed tip unscrews and barbs may be removed. Head then is a fine Field or Target Point. Packed three heads per blister card.

No. 91 THREE INCH ALUMINUM FISH POINT. Sharp point with side fluke. A very efficient head that holds fish. Packed three heads per blister card.

No. 314-2 DELUXE ALUMINUM BOW REEL. Sturdy 6" diameter. Reel bracket tapes to bow. Reel dismounts from bracket. Rubber grommet holds line firmly before shot. Beautifully finished. Sixty feet of line included.

BOW-FISHING ARROWS

No. 14 DOUBLE BARB FISH SPEAR HEAD. Port Orford Cedar 11/32" Shaft. Plastic Nocks. Air-Flow Turkey Feathers. Painted and decorated Shaft.

No. F-14-G SOLID FIBERGLASS FISH ARROW FLETCHED WITH RUBBER FINIS. The 3" aluminum head is very sharply pointed and has a movable fluke. An exceedingly efficient fish arrowhead that really penetrates.

No. 14-G SOLID FIBERGLASS MINIATURE HARPOON. Plastic Nocks. The 3" very sharp aluminum head with side fluke. makes it a very practical fish arrow.

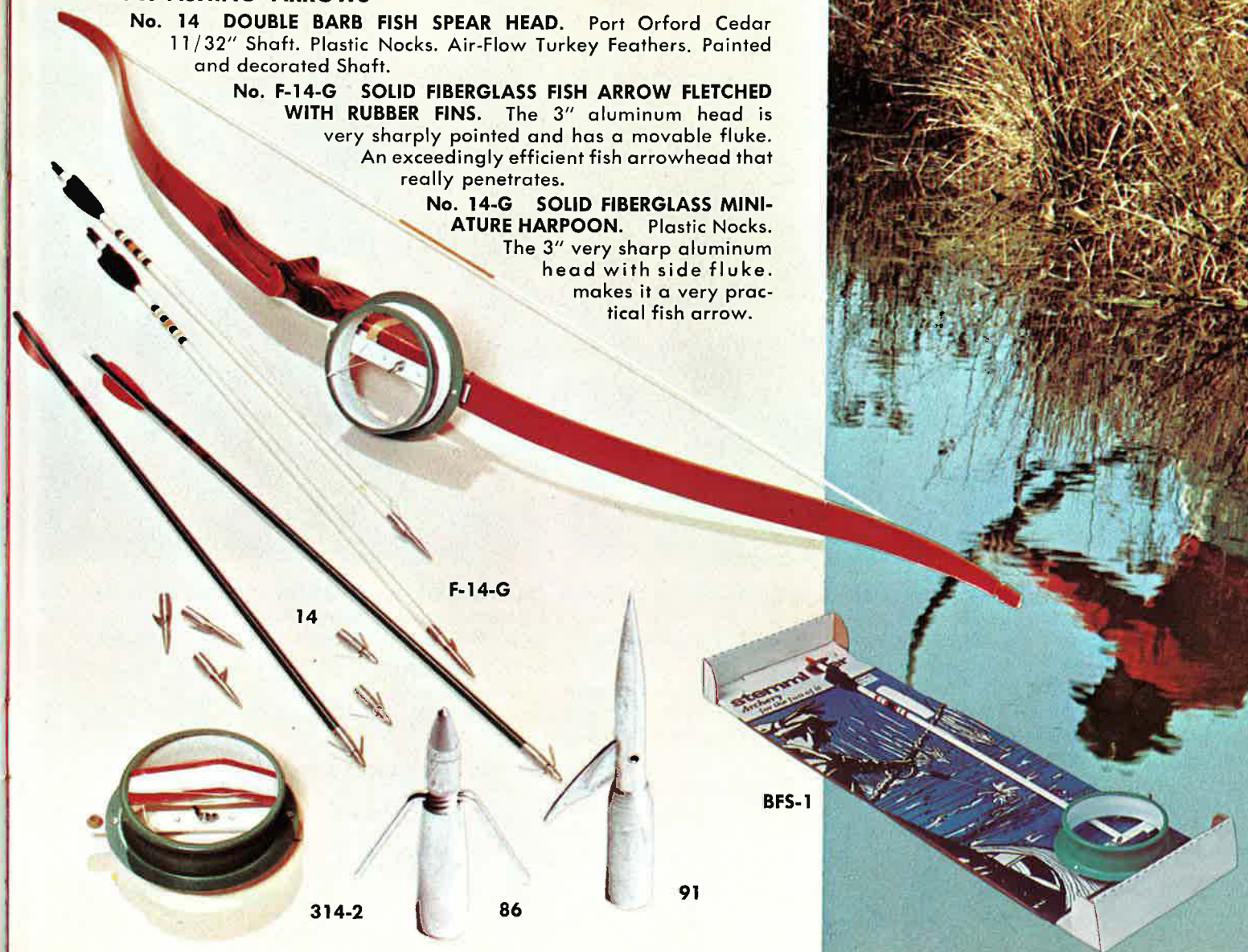

Stemmler Accessories

Round out your inventory with these specialized items and you will find the advanced archer your regular customer. Here is merchandise that stimulates interest and increases sales.

Stemmler bow and arrow accessories are of the highest standards of quality.



No. 514 WILSON-ALLEN NOCK LOCKS. These soft rubber bowstring attachments provide positive nocking point on the bowstring. Ensures consistent and quick arrow nocking.

No. 520 NOCK RITE BOWSTRING ATTACHMENT. For fast accurate shooting. Balanced three finger action. Smooth arrow release. No slippage of arrow on string.



No. 510 Bow Cover A heavy flannel bow cover with a soft nap interior. The down flap adjusts to bow length.

No. 511 Bow Case A deluxe heavy duty bow case with saddle stitched handles. Perfect protection for better bows.

No. 528 NOK-SET. A positive Nocking Point that will not slip. Suitable for any size bow string diameter. 6 per package.

No. 529 As above. 100 per package.
No. 530 Nok-Set Tool. 1 per package. Necessary to apply Nok-Sets.

ARCHERY BOOKLETS

No. 518 THE ESSENTIALS OF ARCHERY. An informative handbook dealing with all phases of Archery. How to shoot and aim. General information.

No. 540 AAHPER ARCHERY PLANNING GUIDE An invaluable source for archery instruction layouts, equipment recommendations, games, contents, and drills.

No. 541 ARCHER'S DIGEST — by Jack Lewis, Editor of Bow and Arrow magazine; 320 pages, 8½" x 11" heavily illustrated. The basic resource for archers of all ages and levels of skill; packed with the latest changes in a fast changing sport.



No. 501 SIX ARROW BOW QUIVER. Made of compounded rubber to fit all bows. Bulldog grip on bow limbs but permits easy removal.

No. 502 DELUXE KWIKIE KWIVER. Best quality bow quiver. Clings tightly to bow limbs and holds four arrows snugly. Fits all bows.

No. 503 HUSH-H-H BOW QUIVER. Holds 4 arrows on any bow without screws or tape. Holds ½" to 1½" shafts.

No. 504 GROUND QUIVER. Ideal for camps and schools. Rugged design. Holds both bow and arrows. A must for group participation.

BOW SIGHTS

Beautifully constructed for precise shooting. Anodized aluminum frame with changeable paper for exact sight markings.

No. SB Pin Sight.

No. GL Glass Lens.

No. HB Hooded Ball

No. H Hunting.

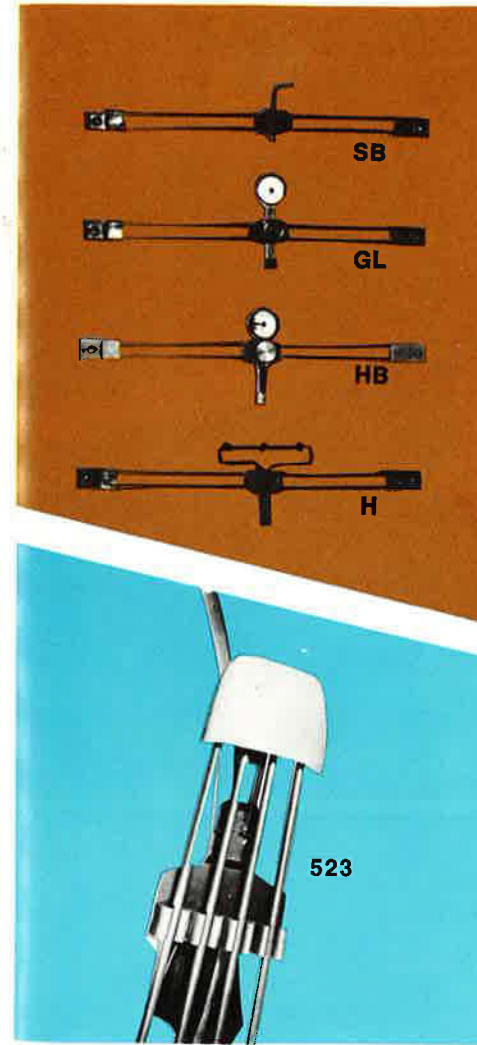

No. 523 QWIFFER BOW QUIVER. One model fits all bows — right or left hand. Sturdy lightweight construction. Complete broadhead protection. Attaches instantly without marring bow. Sturdy arrow clip fits any size hunting arrow. Does not affect bow performance.

TURKEY FEATHERS

Long Turkey Points. Select Grade. Specify right or left wing. Grey and Colored. (Red, yellow, orange, green or blue.)

No. 517 ARROW HOLDER. Holds arrow in ready-to-shoot position while moving through woods. Releases automatically upon drawing. Great in cold weather hunting.

No. 5121 Mohair Arrow Rest and Arrow Plate. A quiet arrow leaving the bow may mean success. Adhesive backing allows easy application. One assembly per card.

No. 5122 As above packed bulk — 48 per box.

No. 527 HOYT PRO ARROW REST. Approved by top shooters as an outstanding rest. 1 per package.



No. 3GBS Streamlined, die-cut 3" sections, 24 greys and 12 colored. Sufficient cut feather sections to fletch 1 dozen target arrows.

No. 4GBH Die-cut 5" feathered sections for hunting arrows. 24 greys and 12 colored. Sufficient cut feather sections to fletch 1 dozen hunting arrows.

No. 524 ARROGUIDE. A holding and guiding device for target archers and beginners. Holds arrow in shooting position on either right or left handed bow.

No. TT-1 TENON TOOL FOR — 5/16" SHAFT. 11 degree Nock Taper, 9/32" I.D. Parallel Point Tenon.

No. TT-3 TENON TOOL FOR — 11/32" SHAFT. 11 degree and 5 degree Point Taper.

No. 522 KWIKIE KOVER. Feather-weight broadhead shield attaches to arrow and allows easy arrow removal.

No. 521 KWIKIE SILENCER. Bowstring attachment to deaden "twang" of bowstring.

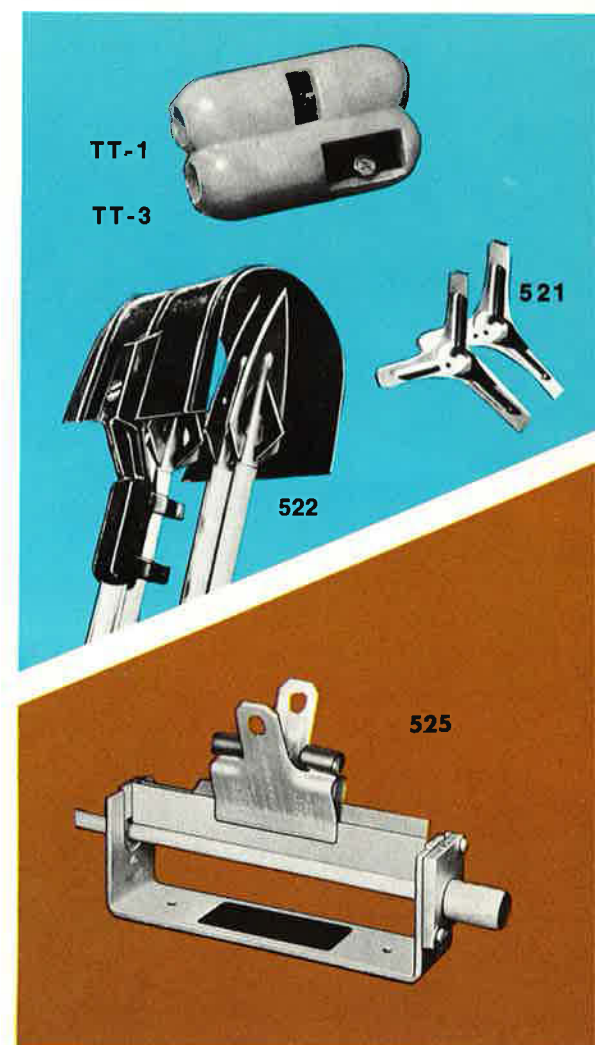

No. 525 PRECISION FLETCHER. For fletching 3 feather arrows with feathers up to 6" long.

PRO FLETCH VANES — Revolutionary arrow fletching. Waterproof and extremely flexible to minimize arrow deflection. Bonds easily. Colors: white, yellow, black, fluorescent orange. 36 vanes per package. Not illustrated.

#535 PRO FLETCH VANES — 2¾" 3 doz. pack.

#536 PRO FLETCH VANES — 4" 3 doz. pack.

#537 PRO FLETCH VANES — 5" 3 doz. pack.

No. 513 BOW STRING KEEPER. Bowstring is kept neatly attached to unstrung bow. Twist is retained in string.

No. 515 WILSON-ALLEN BOW TIP PROTECTORS. Bow tips are protected during bracing and storage. Also retains string on bow.

No. 516 BRUSH NOCKS. A must for bow hunters. Stop brush from jamming under bowstring at bow nocks.

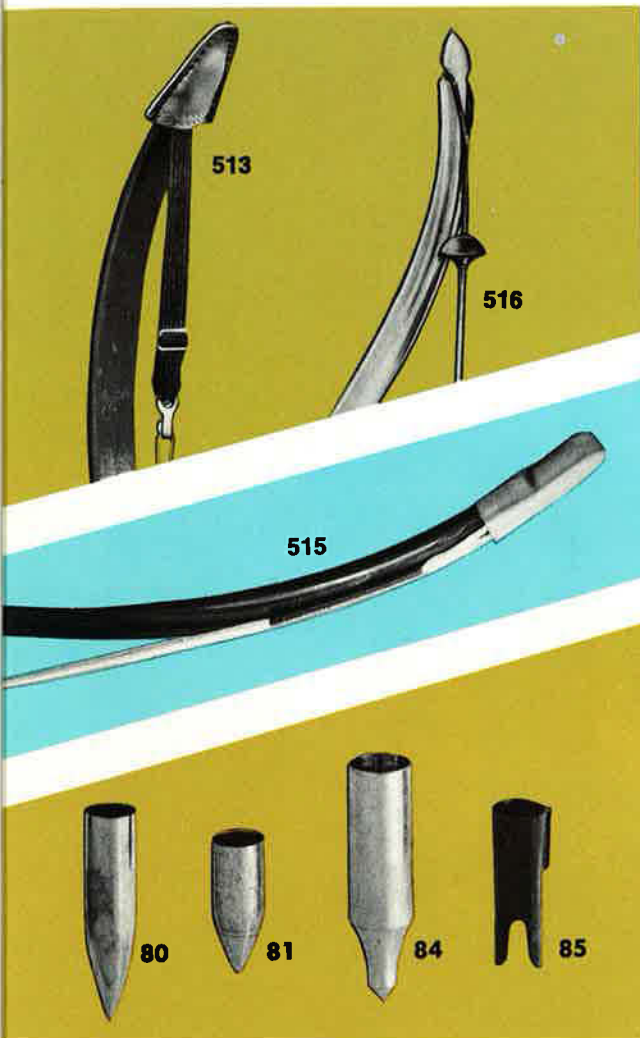

TARGET ARROWHEADS

No. 80 Bullet Jackets 5/16" x 11/32" O.D.

No. 81 Parallel Target Heads 5/16" dia.

No. 84 Steel Field and Roving Points. 5/16" & 11/32" I.D.

No. 85 Finger Formed Plastic Nocks 5/16" & 11/32".

No. 8510 Bjorn Nocks 3/32" and 5/16". 1 doz. pack. Snap-on design. Specify size. Lime and ruby available.

No. 8515 As above in 100 pack. Specify size and color.

CEDAR ARROW SHAFTS

Selected for Straightness 30" length.

No. 76 5/16" dia. Spined for bows up to 45 lbs. Specify bow weight.

No. 79 11/32" dia. Spined for bows up to 65 lbs. Specify bow weight.

No. 97 Select 11/32" dia.

HUNTING ARROWHEADS

No. 92 Three-Blade Hunting Heads four per blister card.

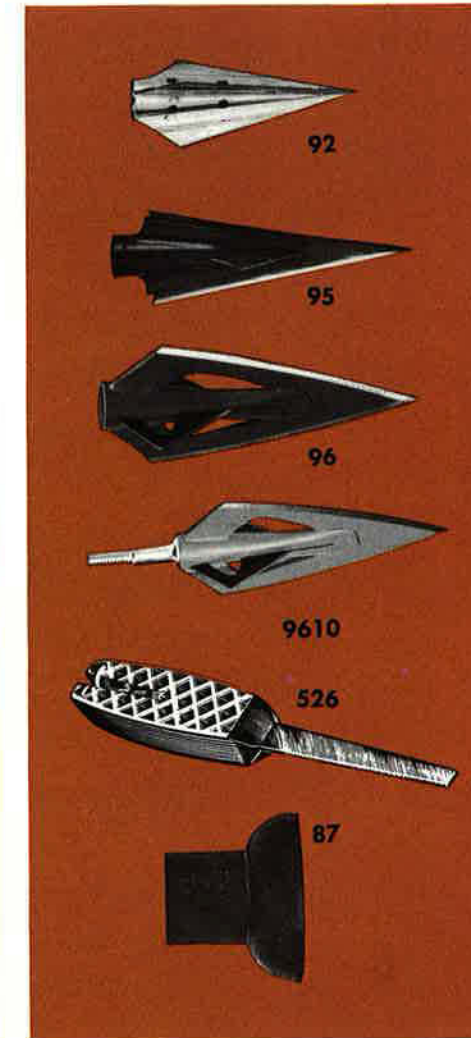

No. 95 Super Hilbre four-blade Hunting Heads four per blister card.

No. 96 Razor Four-blade Hunting Head. Packed four per blister card.

No. 9610 Razor head Fitted with swap-point broad head adapter.

No. 9611 Razor head auxiliary blades. Twelve per blister pack.

No. 526 Broadhead Sharpener. A combination broadhead sharpener for keen razor-sharp edges.

No. 87 Rubber Suction Cups. Twelve per blister card.

No. 88 SWAP POINT broad head adapter. A screw-in adapter made to accept all broad heads and tapered field points.

No. 89 SWAP POINT field point adapter. A screw-in arrow point provides quick change to a field.

No. 8910 SWAP POINT target point. A screw-in arrow point. Provides arrow versatility.

No. 8911 SWAP POINT internal adapter. Made to accept broad head adapter screw-in field point and screw-in target point. Specify shaft size.

No. 8912 WOOD ARROW SWAP POINT ADAPTOR internally tapered to fit all of our cedar shafts. Threading accepts field and target points No. 88 and No. 89. Four per blister card.



No. 512 BOWSTRINGER. Provides an easy and safe method to brace your bow without causing limb twist.

No. 586 KAMO BOW COVER. Camouflage elasticized cloth cover to fit all bows.

Stemmler Accessory Displays

ACCESSORY DISPLAY RACK #6001

Quantity	No.	Description
8 cards	85	Plastic Nocks, 5/16"
8 cards	85	Plastic Nocks, 11/32"
8 cards	80	Bullet Heads, 5/16" & 11/32"
8 cards	81	Target Heads, 5/16"
8 cards	73	Bowyer's Wax
8 cards	401	Braided Dacron Bowstring
8 cards	22	Dacron Bowstring
8 cards	84	Field Points, 5/16"
8 cards	84	Field Points, 11/32"
8 cards	92	Hunting Arrowheads, 3 blade
8 cards	96	Hunting Arrowheads, 4 blade
8 cards	95	Hunting Arrowheads, sup. Hilbre
8 cards	87	Suction Cups
8 cards	509	Fletching Glue
8 cards	512	Bow Stringer
8 cards	514	Nock Locks
8 cards	515	Bow Tip Protectors
8 cards	516	Brush Nocks
8 cards	519	Feather Arrow Rest
8 cards	520	Nock-Rite Attachment
8 cards	521	Bowstring Silencer
24 cards	29	Fingertab
24 cards	29M	Fingertab

Holds 216 product cards. Complete with wire rack and display header.

Your Stemmler Self-Service Display Rack makes for customer awareness . . . puts many items at eye level. Attractive see-through packaging will deliver maximum sales. Provides archery replacement parts and materials for the do-it-yourself. Reorder inventory couldn't be easier.

ACCESSORY DISPLAY RACK #6002

Quantity	No.	Description
16 cards	25N	Armguard
8 cards	26N	Armguard
8 cards	28A	Armguard
32 cards	30	Shooting Glove (8 ea. size)
32 cards	30S	Shooting Glove (8 ea. size)
8 cards	586	Kamo Bow Cover
8 cards	503	Hush Bow Quiver
8 cards	502	Kwikee Kwiver

Holds 120 product cards. Complete with wire rack and display header.

Minimum space and maximum return. The possibilities are unlimited. Use on wall, counter or for window dressing. Provides the close-at-hand extra sale that makes your Archery Department a real asset to your business.



ACCESSORY DISPLAY RACK #6001

ACCESSORY DISPLAY RACK #6002

Targets and Accessories

OFFICIAL FULL COLOR PAPER TARGET FACES. Printed in red, gold, blue, and black. Fine for mounting on corrugated box or target mat to make a practical target.

- P-16 Standard Pack — one dozen.
- P-24 Standard Pack — one dozen.
- P-36 Standard Pack — 1/2 dozen.
- P-48 Standard Pack — 1/4 dozen.
- P-24SK 24" Paper face with skirt.
- P-36SK 36" Paper face with skirt.
- P-48SK 48" Paper face with skirt.

SKIRTED VINYL CLOTH ALL-WEATHER TARGET FACES.

- No. 24-F 24" diameter polybagged with hanger.
- No. 36-F 36" diameter polybagged with hanger.
- No. 48-F 48" diameter polybagged with hanger.

FLAT ALL-WEATHER TARGET FACES.

- No. 24-FF 24" Vinylcloth face without skirt.
- No. 36-FF 36" Vinylcloth face without skirt.
- No. 48-FF 48" Vinylcloth face without skirt.

TARGETS. Vinyl Cloth Target Covers. Weather resistant cover to protect target matt.

- No. 24C To fit 24" diameter matt.
- No. 36C To fit 36" diameter matt.
- No. 48C To fit 48" diameter matt.

TARGET FACE PINS

No. 590 Attach target faces to target matts. Four per blister card.

TARGET EASEL AND CARRIER. Heavy welded steel frame with rubber tire wheels.

- No. 365 For 36" and 48" targets.

ALL TARGET MATS, STANDS AND CARRIERS
F.O.B. FACTORY



RHD-36

NEW BUDGET PRICED TARGETS

- No. 6336 A RHD-36 Target with a target stand mounted ready for immediate use. Perfect for quick backyard fun. Packed two per carton.
- No. RHD-24 Polyurethane foam 24" target. Good for bows up to 35 lbs. Packed 4 per shipper.
- No. RHD-36 New polyurethane foam 36" diameter target. This resilient and tough target has a bulldog grip. A fine lightweight backyard target for bows up to 40 lbs. Comes with a 36" four color target face with cloth bind band. Packed 2 per shipper.
- No. RHD-48 Same as above only 48" dia., 15 lbs. Packed one per shipper.

ARCHERY BACK-STOP NETTING

No. 587 9' x 10'. Ideal for target backstop indoors or outside. Heavy gauge nylon netting stops arrows without damage to inside walls or to arrows. For other sizes, request quotation.

No. 6336

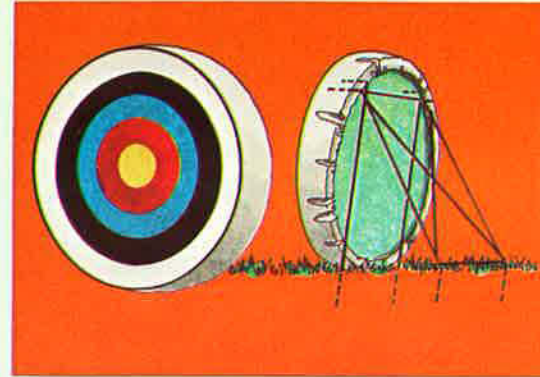

No. 601

No. CA-1



ANIMAL TARGET FACES

- No. CA-1 24" Deer or Lion, specify, 12 pack.
- No. 601 Bobcat Target Faces, 4 per film pack.
- No. 602 Fox Target Faces, 3 per film pack.
- No. 603 Deer Target Faces, 2 per film pack.

BOX TARGETS

- No. BX-24 A low priced Practice and Field Target, printed in the regulation archery colors. Made in box form of 200 lb. test corrugated. Rye straw filler. Size 24" x 4" thick. Minimum Standard Pack — 6 to shipping carton.
- No. KD-24 The same target as BX-24, but in knockdown form. Standard pack — 12 to a shipping carton.



No. 365

REGULATION TOUGH, FIBROUS, SPARTANA INDIAN CORD GRASS TARGET MATS OR BACKS ONLY. Chemically treated against rats, mice or other rodents. Spirally wound by machine.

- No. 24M 24" diameter, 20 lbs.
- No. 36M 36" diameter, 40 lbs.
- No. 48M 48" diameter, 70 lbs.



No. 590



No. 6050

DELUXE TARGET STANDS.

All new versatile target stand for indoors as well as outdoors. Constructed for heavy matts and lightweight targets. Chains provided to hold tripod in place. Shipped knocked down.

- No. 6040 For 24" targets.
- No. 6050 For 36" and 48" targets.

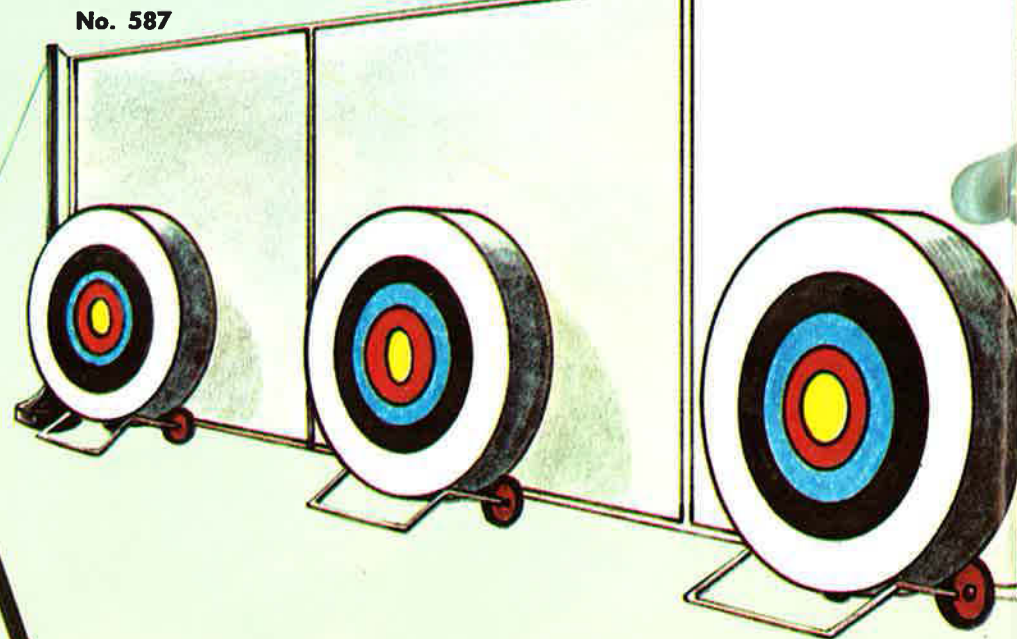

No. 587

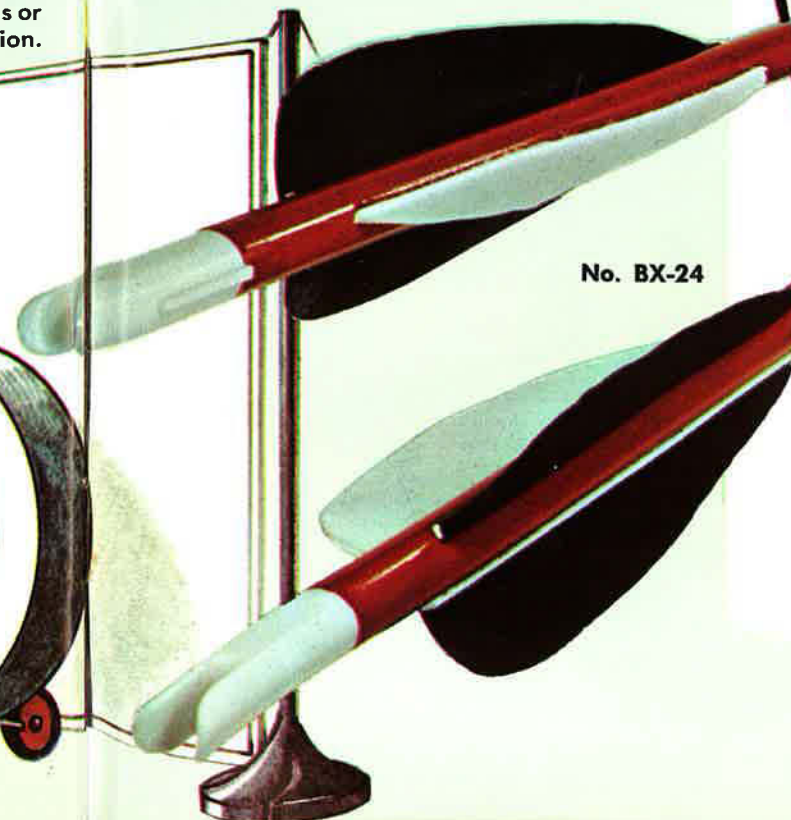

No. BX-24

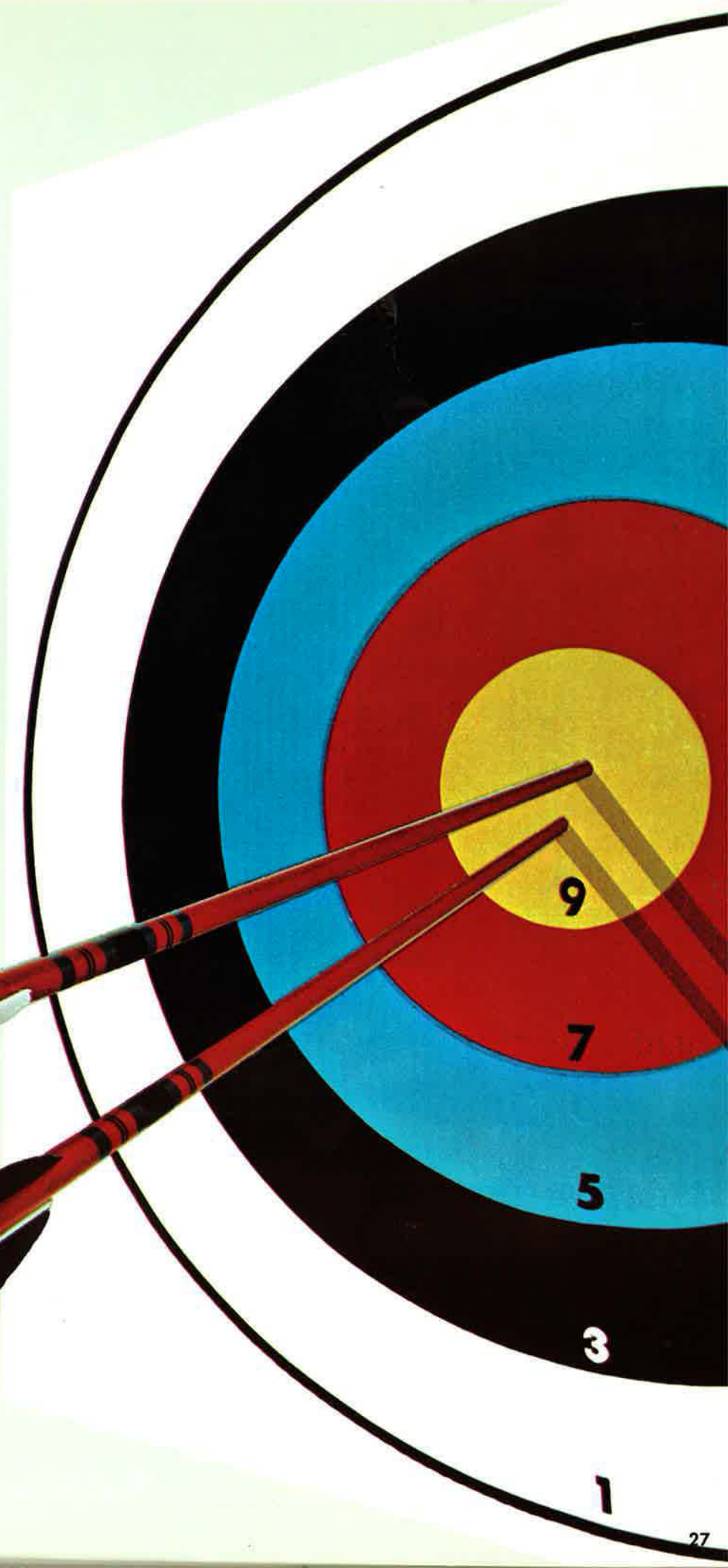

Bow Strings and Displays

SINGLE LOOP BOWSTRINGS

For all bow lengths. Single loop and tie end. Tie end is attached to a bow with a Timber Hitch. Blister Packed.

No. 20 Extra strong, cable laid hemp, single loop. For bows to 30 lbs.

No. 401 Braided Dacron. Center served. For bows up to 35 lbs.

No. 21 Single loop Dacron, nylon center served. For bows up to 40 lbs.

No. 22 Single loop Deluxe Dacron, center served. For bows up to 65 lbs.

DOUBLE LOOP BOWSTRINGS

No. 402 Braided Dacron Bowstrings. Center served. Specify bowstring length. For bows up to 35 lbs. Handy reusable vial pack. AMO lengths: 36, 42, 45, 48, 50, 52, 54, 56.

No. 22T Fully served Custom Dacron Bowstrings. Ply-wax finish for durability. Specify AMO bowstring length and bow draw weight. In handy reusable vial pack. For any weight bow. AMO lengths: 42 to 66

No. 72D DACRON BOWSTRING THREAD. The proper material for fine, handmade strings. 4 oz. tube.

No. 23 BOWSTRING DISPLAY. Thirty-six double loop Dacron Bowstrings. Professional grade quality. In popular AMO lengths for assorted draw weight bows. Each string in reusable vial pack. 9 popular AMO lengths: 48 to 64

No. 400 BOWSTRING DISPLAY. Thirty-two double-looped braided Dacron Bowstrings for bows up to 35 lbs. draw weight. 8 popular AMO lengths for 42 Juvenile and Adult Bows. Each bowstring in plastic vial.

No. 73 BOWYER'S WAX. Special formula. Large cake.



No. 23

stemmler

STEMMLER ARCHERY INC., Southford Road, Middlebury, Conn. 06762
STEMMLER ARCHERY INC., River Road, Manorville, L.I., N.Y. 11949



For export orders: write
International Division
222 Rimmon Road
North Haven, Conn. 06473
Cable: Conintrade

MEMBER ARCHERY
MANUFACTURERS ORGANIZATION