

Corbelstone, Inc.

5831 Hilltop Drive
770-967-0076

Flowery Branch, Ga. 30542
www.corbelstone.com

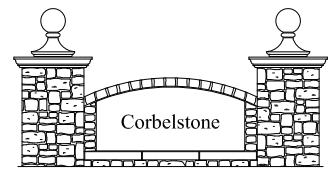

Keys Pages 1, 2, 3, and 4

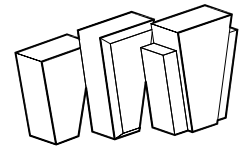

Quoins Page 5

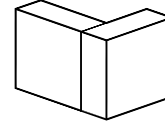

Medallions Page 6

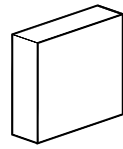

Headers, Bands and Trim Pages 7 and 8

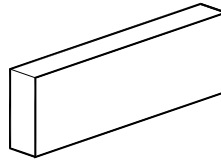

Multi-Piece and Pages 9 and 10
Segmented Jack Arches

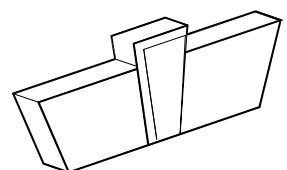

Sills, Watertables Pages 11 and 12
and Bands

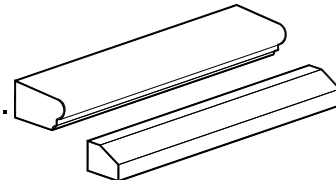

Steps, Risers and Pavers Pages 13 and 14

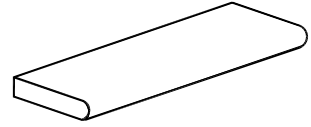

Wall Caps and Coping Pages 15 and 16

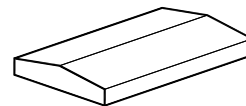

Pier Caps Pages 17, 18, 19, and 20
and Ball Finials

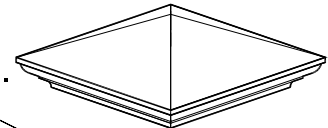

Balustrades Page 21

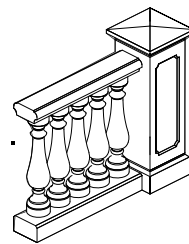

Number Blocks Page 22

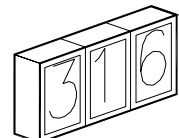

Wall Veneer Pages 23 and 24

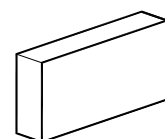

Corbelstone, Inc.

5831 Hilltop Drive
770-967-0076

Flowery Branch, Ga. 30542
www.corbelstone.com

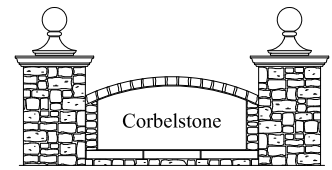

KEYS

PART #	DIMENSIONS			
	"A"	"B"	"C"	"D"
SK1S CHAMFERED KEY BULLSEYE OR BABY KEY	4 1/8"	3 7/8"	2 1/4"	3 5/8"
SK2S CHAMFERED KEY BULLSEYE KEY	6 3/4"	5 5/8"	3"	3 5/8"
SK3S CHAMFERED KEY 3 COURSE STANDARD BRICK SIZE	7 5/8"	6"	3"	3 5/8"
SK4S CHAMFERED KEY 4 COURSE STANDARD BRICK SIZE	10 1/4"	8"	4"	3 5/8"
SK5S CHAMFERED KEY 5 COURSE STANDARD BRICK SIZE	12 3/4"	9"	4"	3 5/8"
SK6S CHAMFERED KEY 6 COURSE STANDARD BRICK SIZE	15 5/8"	10 1/8"	4"	3 5/8"
SK2Q CHAMFERED KEY 2 COURSE QUEEN BRICK SIZE	6 3/4"	5 5/8"	3"	3 5/8"
SK3Q CHAMFERED KEY 3 COURSE QUEEN BRICK SIZE	9 1/4"	7 5/8"	4"	3"
SK4Q CHAMFERED KEY 4 COURSE QUEEN BRICK SIZE	12 3/8"	8 7/8"	4"	3"
SK5Q CHAMFERED KEY 5 COURSE QUEEN BRICK SIZE	15 5/8"	10 1/8"	4"	3"
CK4S* CHAMFERED KEY 4 COURSE STANDARD - "NEW CONCEPT"	10 1/8"	9"	4"	3 5/8"
CK4Q* CHAMFERED KEY 4 COURSE QUEEN - "NEW CONCEPT"	12 1/8"	9 5/8"	4"	3 5/8"

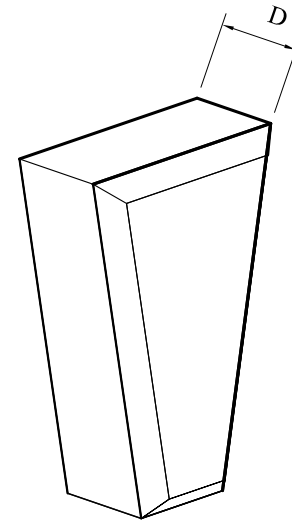

3/4" BEVEL EXTRUSION

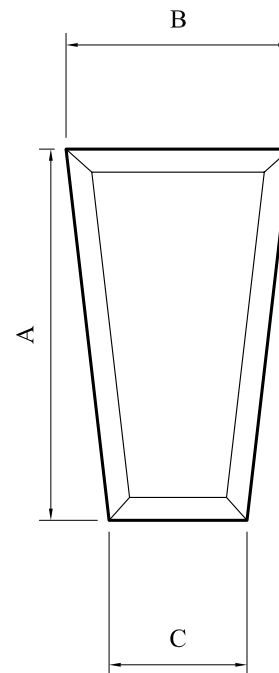

Corbelstone, Inc.

5831 Hilltop Drive
770-967-0076

Flowery Branch, Ga. 30542
www.corbelstone.com

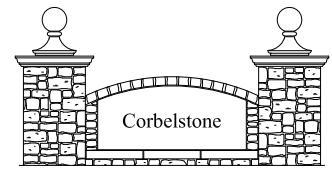

KEYS

PART #	DIMENSIONS				PRODUCT
	"A"	"B"	"C"	"D"	
FK1S* FLAT KEY BULLSEYE OR BABY KEY	4 1/8"	3 7/8"	2 1/4"	3 5/8"	
FK2S* CHAMFERED KEY BULLSEYE KEY	6 3/4"	5 5/8"	3"	3 5/8"	
FK3S* FLAT KEY 3 COURSE STANDARD BRICK SIZE	7 5/8"	6"	3"	3 5/8"	
FK4S* FLAT KEY 4 COURSE STANDARD BRICK SIZE	10 1/4"	8"	4"	3 5/8"	
FK5S* FLAT KEY 5 COURSE STANDARD BRICK SIZE	12 3/4"	9"	4"	3 5/8"	
FK6S* FLAT KEY 6 COURSE STANDARD BRICK SIZE	15 5/8"	10 1/8"	4"	3 5/8"	
FK3Q* FLAT KEY 3 COURSE QUEEN BRICK SIZE	9 1/4"	7 5/8"	4"	3"	
FK4Q* FLAT KEY 4 COURSE QUEEN BRICK SIZE	12 3/8"	8 7/8"	4"	3"	

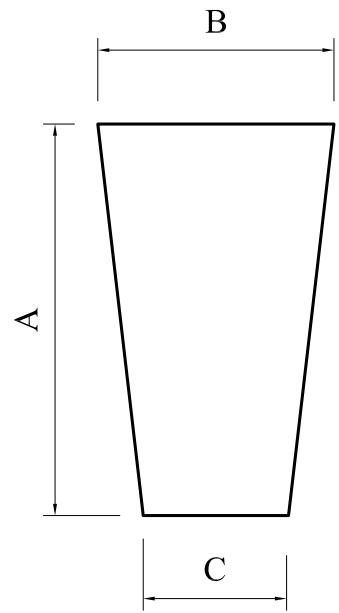
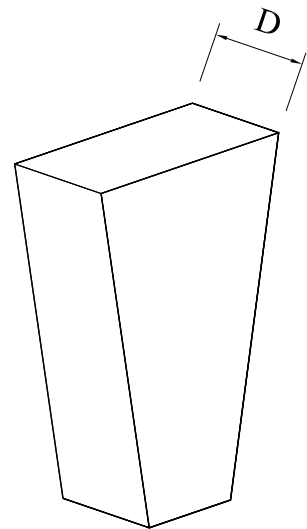

Corbelstone, Inc.

5831 Hilltop Drive
770-967-0076

Flowery Branch, Ga. 30542
www.corbelstone.com

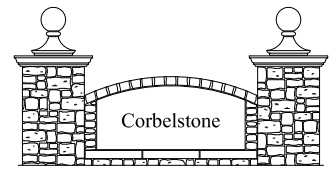

KEYS

PART #	DIMENSIONS				PRODUCT
	"A"	"B"	"C"	"D"	
RK1S* ROCK FACE KEY BULLSEYE OR BABY KEY	4 1/8"	3 7/8"	2 1/4"	3 5/8"	
RK3S* ROCK FACE KEY 3 COURSE STANDARD BRICK SIZE	7 5/8"	6"	3"	3 5/8"	
RK4S* ROCK FACE KEY 4 COURSE STANDARD BRICK SIZE	10 1/4"	8"	4"	3 5/8"	
RK5S* ROCK FACE KEY 5 COURSE STANDARD BRICK SIZE	12 3/4"	9"	4"	3 5/8"	
RK6S* ROCK FACE KEY 6 COURSE STANDARD BRICK SIZE	15 5/8"	10 1/8"	4"	3 5/8"	
RK3Q* ROCK FACE KEY 3 COURSE QUEEN BRICK SIZE	9 1/4"	7 5/8"	4"	3"	
RK4Q* ROCK FACE KEY 4 COURSE QUEEN BRICK SIZE	12 3/8"	8 7/8"	4"	3"	

* CALL FOR AVAILABILITY

Corbelstone, Inc.

5831 Hilltop Drive
770-967-0076

Flowery Branch, Ga. 30542
www.corbelstone.com

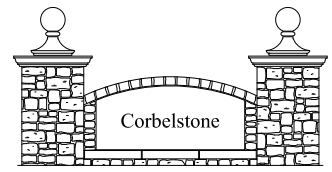

KEYS

PART #	DIMENSIONS					PRODUCT
	"A"	"B"	"C"	"D"	"E"	
DK4S* DBL KEY - BEVELED FACE / FLAT WINGS 4 COURSE STANDARD BRICK SIZE	10 1/4"	8"	4"	3 5/8"	7 5/8"	
DK5S* DBL KEY - BEVELED FACE / FLAT WINGS 5 COURSE STANDARD BRICK SIZE	12 3/4"	9"	4"	3 5/8"	10 1/4"	
DKCQ-4* DBL KEY - FLAT FACE / FLAT WINGS 4 COURSE SPECIAL QUEEN BRICK SIZE	12 1/8"	7"	2 1/4"	3 5/8"	9"	

* CALL FOR AVAILABILITY

Corbelstone, Inc.

5831 Hilltop Drive
770-967-0076

Flowery Branch, Ga. 30542
www.corbelstone.com

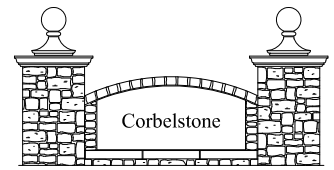

QUOINS					
PART #	DIMENSIONS				PRODUCT
	"A"	"B"	"C"	"D"	
SQ4S CHAMFERED QUOIN 4 COURSE STANDARD BRICK SIZE	10 1/4"	11 5/8"	3 5/8"	11 5/8"	
SQ5S CHAMFERED QUOIN 5 COURSE STANDARD BRICK SIZE	12 3/4"	11 5/8"	3 5/8"	11 5/8"	
SQ6S CHAMFERED QUOIN 6 COURSE STANDARD BRICK SIZE	15 5/8"	15 5/8"	3 5/8"	15 5/8"	
SQ4Q* CHAMFERED QUOIN 4 COURSE QUEEN BRICK SIZE	12 3/8"	11 5/8"	3"	11 5/8"	
SQ5Q* CHAMFERED QUOIN 5 COURSE QUEEN BRICK SIZE	15 5/8"	15 5/8"	3"	15 5/8"	
FQ4S FLAT QUOIN 4 COURSE STANDARD BRICK SIZE	10 1/4"	11 5/8"	3 5/8"	11 5/8"	
FQ5S FLAT QUOIN 5 COURSE STANDARD BRICK SIZE	12 3/4"	11 5/8"	3 5/8"	11 5/8"	
FQ4Q FLAT QUOIN 4 COURSE QUEEN BRICK SIZE	12 3/8"	11 5/8"	3"	11 5/8"	
FQ5Q FLAT QUOIN 5 COURSE QUEEN BRICK SIZE	15 5/8"	15 5/8"	3"	15 5/8"	

* CALL FOR AVAILABILITY

Corbelstone, Inc.

5831 Hilltop Drive
770-967-0076

Flowery Branch, Ga. 30542
www.corbelstone.com

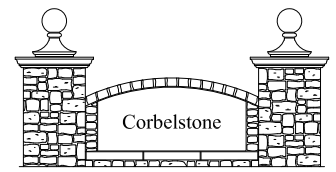

MEDALLIONS				
PART #	DIMENSIONS			PRODUCT
	"A"	"B"	"C"	
SM3S CHAMFERED MEDALLION 3 COURSE STANDARD BRICK SIZE	7 5/8"	7 5/8"	3 5/8"	
SM4S CHAMFERED MEDALLION 4 COURSE STANDARD BRICK SIZE	10 1/4"	10 1/4"	3 5/8"	
SM5S* CHAMFERED MEDALLION 5 COURSE STANDARD BRICK SIZE	12 3/4"	12 3/4"	3 5/8"	
SM6S* CHAMFERED MEDALLION 6 COURSE STANDARD BRICK SIZE	15 5/8"	15 5/8"	3 5/8"	
SM4Q* CHAMFERED MEDALLION 4 COURSE QUEEN BRICK SIZE	12 3/8"	12 3/8"	3"	
SM5Q* CHAMFERED MEDALLION 5 COURSE QUEEN BRICK SIZE	15 5/8"	15 5/8"	3"	
FM3S FLAT MEDALLION 3 COURSE STANDARD BRICK SIZE	7 5/8"	7 5/8"	3 5/8"	
FM4S FLAT MEDALLION 4 COURSE STANDARD BRICK SIZE	10 1/4"	10 1/4"	3 5/8"	
FM5S FLAT MEDALLION 5 COURSE STANDARD BRICK SIZE	12 3/4"	12 3/4"	3 5/8"	
FM6S FLAT MEDALLION 6 COURSE STANDARD BRICK SIZE	15 5/8"	15 5/8"	3 5/8"	
FM4Q FLAT MEDALLION 4 COURSE QUEEN BRICK SIZE	12 3/8"	12 3/8"	3"	
FM5Q FLAT MEDALLION 5 COURSE QUEEN BRICK SIZE	15 5/8"	15 5/8"	3"	

* CALL FOR AVAILABILITY

Corbelstone, Inc.

5831 Hilltop Drive
770-967-0076

Flowery Branch, Ga. 30542
www.corbelstone.com

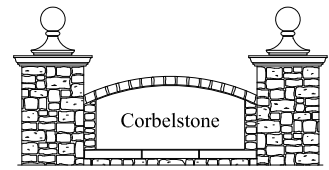

HEADERS / BANDS / TRIM				
PART #	DIMENSIONS			PRODUCT
	"A"	"B"	"L"	
CH3S-32 CHAMFERED HEADER 3 COURSE STANDARD BRICK SIZE	7 5/8"	3 5/8"	31 5/8"	
CH4S-32 CHAMFERED HEADER 4 COURSE STANDARD BRICK SIZE	10 1/4"	3 5/8"	31 5/8"	
CH5S-32* CHAMFERED HEADER 5 COURSE STANDARD BRICK SIZE	12 3/4"	3 5/8"	31 5/8"	
CH3Q-32* CHAMFERED HEADER 3 COURSE QUEEN BRICK SIZE	9 1/4"	3"	31 5/8"	
CH4Q-32* CHAMFERED HEADER 4 COURSE QUEEN BRICK SIZE	12 3/8"	3"	31 5/8"	
FH3S-32 FLAT HEADER 3 COURSE STANDARD BRICK SIZE	7 5/8"	3 5/8"	31 5/8"	
FH4S-32 FLAT HEADER 4 COURSE STANDARD BRICK SIZE	10 1/4"	3 5/8"	31 5/8"	
FH5S-32 FLAT HEADER 5 COURSE STANDARD BRICK SIZE	12 3/4"	3 5/8"	31 5/8"	
FH6S-32 FLAT HEADER 6 COURSE STANDARD BRICK SIZE	15 5/8"	3 5/8"	31 5/8"	
FH3Q-32 FLAT HEADER 3 COURSE QUEEN BRICK SIZE	9 1/4"	3"	31 5/8"	
FH4Q-32 FLAT HEADER 4 COURSE QUEEN BRICK SIZE	12 3/8"	3"	31 5/8"	
FH5Q-32 FLAT HEADER 5 COURSE QUEEN BRICK SIZE	15 5/8"	3"	31 5/8"	

* CALL FOR AVAILABILITY

Corbelstone, Inc.

5831 Hilltop Drive
770-967-0076

Flowery Branch, Ga. 30542
www.corbelstone.com

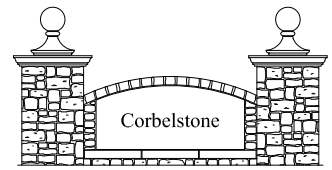

HEADERS / BANDS / TRIM

PART #	DIMENSIONS			PRODUCT
	"A"	"B"	"L"	
RH3S-32 ROCK FACE HEADER 3 COURSE STANDARD BRICK SIZE	7 5/8"	3 5/8"	31 5/8"	
RH4S-32 ROCK FACE HEADER 4 COURSE STANDARD BRICK SIZE	10 1/4"	3 5/8"	31 5/8"	
RH5S-32* ROCK FACE HEADER 5 COURSE STANDARD BRICK SIZE	12 3/4"	3 5/8"	31 5/8"	
RH3Q-32* ROCK FACE HEADER 3 COURSE QUEEN BRICK SIZE	9 1/4"	3"	31 5/8"	
RH4Q-32* ROCK FACE HEADER 4 COURSE QUEEN BRICK SIZE	12 3/8"	3"	31 5/8"	

* CALL FOR AVAILABILITY

Corbelstone, Inc.

5831 Hilltop Drive
770-967-0076

Flowery Branch, Ga. 30542
www.corbelstone.com

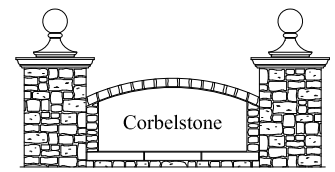

MULTI-PIECE JACK ARCHES

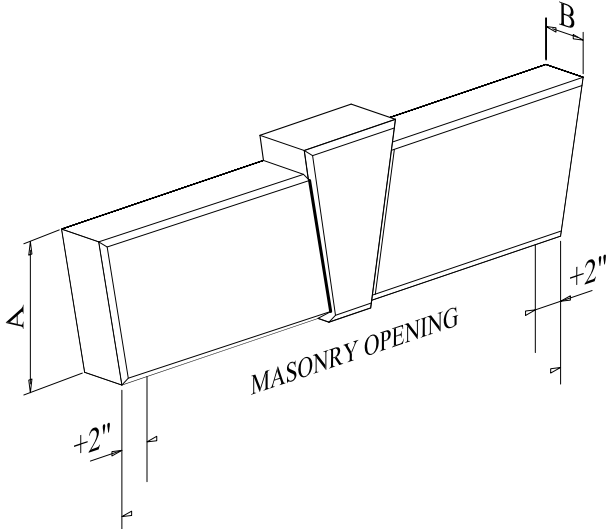
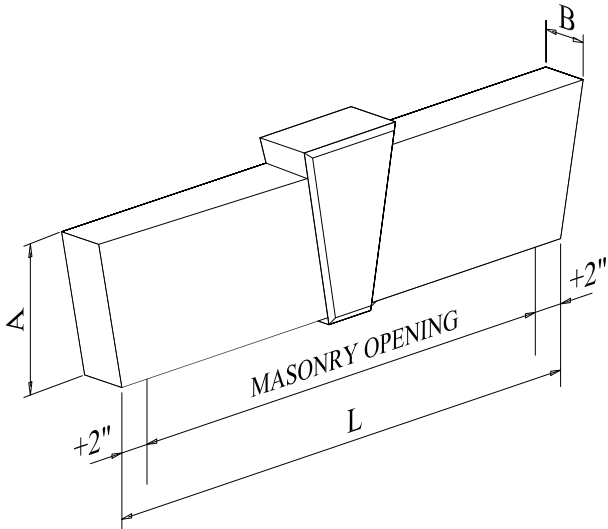
PART #	DIMENSIONS			PRODUCT
	"A"	"B"	"L"	
CA3S CHAMFERED JACK ARCH 3 COURSE STANDARD BRICK SIZE	7 5/8"	3 5/8"	SPECIFY	 <p>WHEN ORDERING MULTI-PIECE JACK ARCHES, ALWAYS NOTE THE OPENING WIDTH AND ADD OVERHANG ON EACH SIDE AS REQUIRED, OR NOTE IF NO OVERHANG IS REQUIRED. ALWAYS NOTE KEY TYPE. ALWAYS USE LINTEL SUPPORT</p>
CA4S CHAMFERED JACK ARCH 4 COURSE STANDARD BRICK SIZE	10 1/4"	3 5/8"	SPECIFY	
CA5S CHAMFERED JACK ARCH 5 COURSE STANDARD BRICK SIZE	12 3/4"	3 5/8"	SPECIFY	
CA3Q* CHAMFERED JACK ARCH 3 COURSE QUEEN BRICK SIZE	9 1/4"	3"	SPECIFY	
CA4Q* CHAMFERED JACK ARCH 4 COURSE QUEEN BRICK SIZE	12 3/8"	3"	SPECIFY	
FA3S FLAT JACK ARCH 3 COURSE STANDARD BRICK SIZE	7 5/8"	3 5/8"	SPECIFY	 <p>WHEN ORDERING MULTI-PIECE JACK ARCHES, ALWAYS NOTE THE OPENING WIDTH AND ADD OVERHANG ON EACH SIDE AS REQUIRED, OR NOTE IF NO OVERHANG IS REQUIRED. ALWAYS NOTE KEY TYPE. ALWAYS USE LINTEL SUPPORT</p>
FA4S FLAT JACK ARCH 4 COURSE STANDARD BRICK SIZE	10 1/4"	3 5/8"	SPECIFY	
FA5S FLAT JACK ARCH 5 COURSE STANDARD BRICK SIZE	12 3/4"	3 5/8"	SPECIFY	
FA3Q FLAT JACK ARCH 3 COURSE QUEEN BRICK SIZE	9 1/4"	3"	SPECIFY	
FA4Q FLAT JACK ARCH 4 COURSE QUEEN BRICK SIZE	12 3/8"	3"	SPECIFY	

* CALL FOR AVAILABILITY

Corbelstone, Inc.

5831 Hilltop Drive
770-967-0076

Flowery Branch, Ga. 30542
www.corbelstone.com

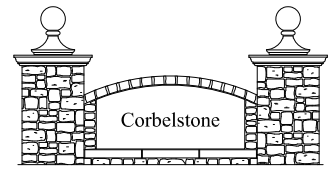

SEGEMENTED JACK ARCHES

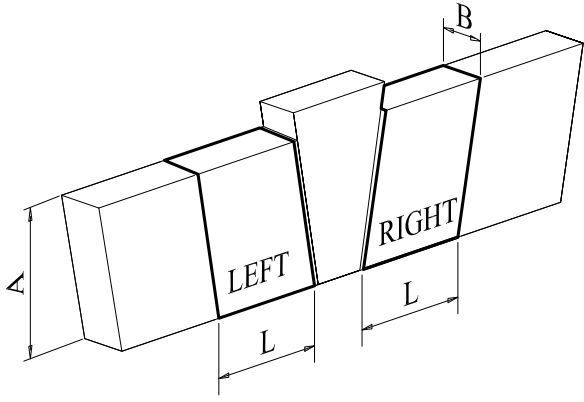
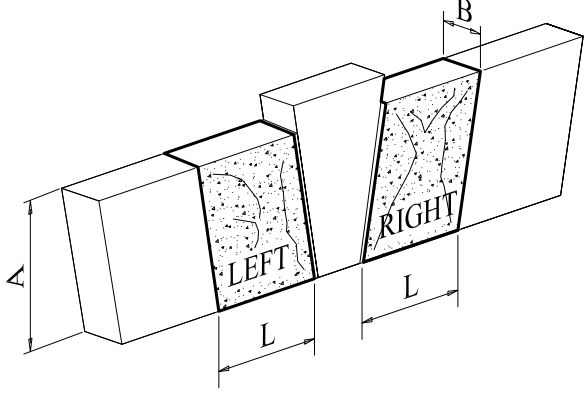
PART #	DIMENSIONS			PRODUCT
	"A"	"B"	"L"	
FS3S FLAT JACK ARCH BLOCKS 3 COURSE STANDARD BRICK SIZE	7 5/8"	3 5/8"	7 5/8"	 <p>NOTE NUMBER OF SETS AND KEY TYPE - WHEN ORDERING</p>
FS4S FLAT JACK ARCH BLOCKS 4 COURSE STANDARD BRICK SIZE	10 1/4"	3 5/8"	9 1/4"	
FS5S FLAT JACK ARCH BLOCKS 5 COURSE STANDARD BRICK SIZE	12 3/4"	3 5/8"	12 3/8"	
FS3Q FLAT JACK ARCH BLOCKS 3 COURSE QUEEN BRICK SIZE	9 1/4"	3 5/8"	10 1/4"	
FS4Q FLAT JACK ARCH BLOCKS 4 COURSE QUEEN BRICK SIZE	12 3/8"	3 5/8"	12 3/4"	
RS4S ROCK FACE JACK ARCH BLOCKS 4 COURSE STANDARD BRICK SIZE	10 1/4"	3 5/8"	9 1/4"	 <p>NOTE NUMBER OF SETS AND KEY TYPE - WHEN ORDERING</p>
RS3Q ROCK FACE JACK ARCH BLOCKS 3 COURSE QUEEN BRICK SIZE	9 1/4"	3 5/8"	10 1/4"	

* CALL FOR AVAILABILITY

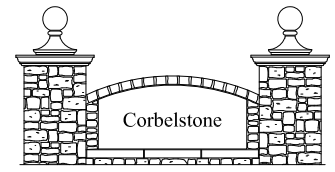

SILLS, WATERTABLES, OR BANDS

PART #	STOCK DIMENSIONS					PRODUCT
	"A"	"B"	"C"	"D"	"L"	
SL-01-32 SLOPED SILL	3 5/8"	2"	2"	5"	31 5/8"	
SL-03-32 SLOPED SILL	6"	4 7/8"	3 1/4"	6"	31 5/8"	
SL-05-32 SLOPED SILL	7 5/8"	6"	1/4"	6"	31 5/8"	
SL-08-32 SLOPED SILL	5 1/2"	3 1/2"	5"	7"	31 5/8"	
SL-09-32 SLOPED SILL	3 1/2"	2"	4 1/8"	7 5/8"	31 5/8"	
SL-10-32 SLOPED SILL	7 5/8"	6 1/2"	6"	7 5/8"	31 5/8"	
SL-15-32 SLOPED SILL	4 1/2"	NA	1 11/16"	6 1/2"	31 5/8"	
SL-16-32 SLOPED SILL	3"	NA	5"	6 1/2"	31 5/8"	
SL-17-32 SLOPED SILL	4 1/2"	NA	NA	8"	31 5/8"	
SL-20-32 SLOPED SILL	7 5/8"	NA	4"	7 13/16"	31 5/8"	
SL-21-32 SLOPED SILL	3 5/8"	NA	3 5/8"	5 7/16"	31 5/8"	
SL-22-32 SLOPED SILL	3 5/8"	NA	6 7/16"	8"	31 5/8"	
SL-23-32 SLOPED SILL	2 7/8"	NA	3 7/16"	5 1/4"	31 5/8"	
SL-30-32 SLOPED SILL	7 5/8"	7 3/8"	4 3/4"	5"	31 5/8"	

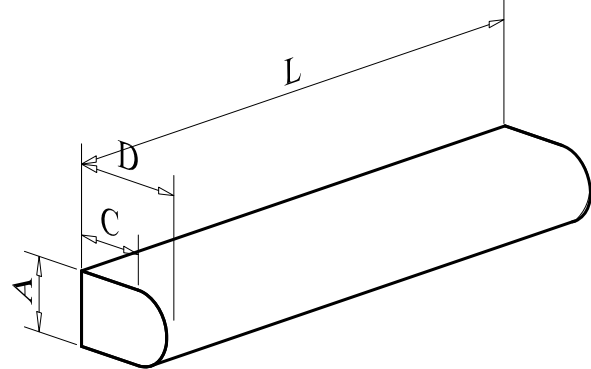
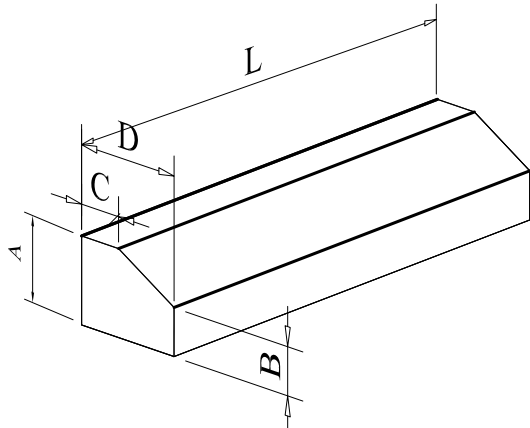

Corbelstone, Inc.

5831 Hilltop Drive
770-967-0076

Flowery Branch, Ga. 30542
www.corbelstone.com

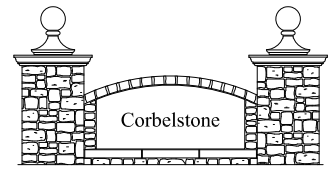

SILLS, WATERTABLES, OR BANDS

PART #	DIMENSIONS			PRODUCT
	"A"	"B"	"L"	
SL31-32 ROCK FACE BAND 1 COURSE STANDARD BRICK SIZE	2 1/4"	3 5/8"	31 5/8"	
SL32-32 ROCK FACE BAND 4" MODULAR SIZE	3 5/8"	3 5/8"	31 5/8"	
SL33-32 ROCK FACE BAND 12" MODULAR SIZE	11 5/8"	3 5/8"	31 5/8"	

* CALL FOR AVAILABILITY

Corbelstone, Inc.

5831 Hilltop Drive
770-967-0076

Flowery Branch, Ga. 30542
www.corbelstone.com

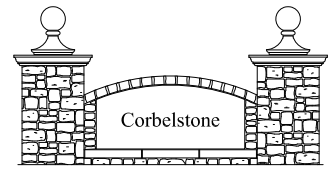

STEP TREADS

PART #	DIMENSIONS			PRODUCT
	"A"	"B"	"L"	
ST12-32 BULLNOSE STEP TREAD	2 1/4"	12"	31 5/8"	
ST14-32 BULLNOSE STEP TREAD	2 1/4"	14"	31 5/8"	
ST16-32 BULLNOSE STEP TREAD	2 1/4"	16"	31 5/8"	
ST18-32 BULLNOSE STEP TREAD	2 1/4"	18"	31 5/8"	
RT12-32 EASED EDGE STEP TREAD	2 1/4"	12"	31 5/8"	
RT14-32* EASED EDGE STEP TREAD	2 1/4"	14"	31 5/8"	
RT16-32* EASED EDGE STEP TREAD	2 1/4"	16"	31 5/8"	
RT18-32* EASED EDGE STEP TREAD	2 1/4"	18"	31 5/8"	

* CALL FOR AVAILABILITY

Corbelstone, Inc.

5831 Hilltop Drive
770-967-0076

Flowery Branch, Ga. 30542
www.corbelstone.com

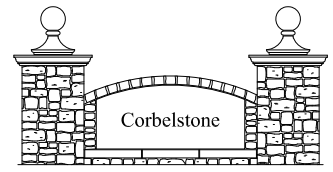

RISERS AND PAVERS

PART #	DIMENSIONS			PRODUCT
	"A"	"B"	"L"	
STR6-32 FLAT RISER	5 1/2"	2	31 5/8"	
PV1212 SQUARE FLAT PAVER	2"	11 5/8"	11 5/8"	
PV1218 RECTANGULAR FLAT PAVER	2"	11 5/8"	17 5/8"	
PV1224 RECTANGULAR FLAT PAVER	2"	11 5/8"	23 5/8"	
PV1818 SQUARE FLAT PAVER	2"	17 5/8"	17 5/8"	
PV1824 RECTANGULAR FLAT PAVER	2"	17 5/8"	23 5/8"	
PV2424 SQUARE FLAT PAVER	2"	23 5/8"	23 5/8"	

* CALL FOR AVAILABILITY

Corbelstone, Inc.

5831 Hilltop Drive
770-967-0076

Flowery Branch, Ga. 30542
www.corbelstone.com

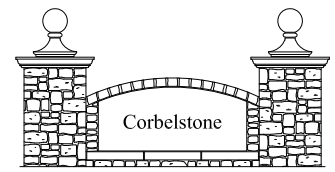

WALL COPING

PART #	DIMENSIONS				PRODUCT
	"A"	"B"	"C"	"L"	
CS-08-32* SINGLE SLOPED COPING	8"	4 7/16"	3"	31 5/8"	
CS-10-32* SINGLE SLOPED COPING	10"	4 3/4"	3"	31 5/8"	
CS-12-32* SINGLE SLOPED COPING	12"	5 1/8"	3"	31 5/8"	
CS-14-32* SINGLE SLOPED COPING	14"	5 1/2"	3"	31 5/8"	
CS-16-32* SINGLE SLOPED COPING	16"	5 7/8"	3"	31 5/8"	
CS-18-32* SINGLE SLOPED COPING	18"	6 1/4"	3"	31 5/8"	
CS-20-32* SINGLE SLOPED COPING	20"	6 1/2"	3"	31 5/8"	
CS-22-32* SINGLE SLOPED COPING	22"	6 7/8"	3"	31 5/8"	
CS-24-32* SINGLE SLOPED COPING	24"	7 1/4"	3"	31 5/8"	
CD-10-32* DOUBLE SLOPED COPING	10"	3 7/8"	3"	31 5/8"	
CD-12-32* DOUBLE SLOPED COPING	12"	4"	3"	31 5/8"	
CD-14-32* DOUBLE SLOPED COPING	14"	4 1/4"	3"	31 5/8"	
CD-16-32* DOUBLE SLOPED COPING	16"	4 1/2"	3"	31 5/8"	
CD-18-32* DOUBLE SLOPED COPING	18"	4 5/8"	3"	31 5/8"	
CD-20-32* DOUBLE SLOPED COPING	20"	4 7/8"	3"	31 5/8"	
CD-22-32* DOUBLE SLOPED COPING	22"	5"	3"	31 5/8"	
CD-24-32* DOUBLE SLOPED COPING	24"	5 1/8"	3"	31 5/8"	
CD-26-32* DOUBLE SLOPED COPING	26"	5 3/8"	3"	31 5/8"	
CD-32-32* DOUBLE SLOPED COPING	32"	5 7/8"	3"	31 5/8"	

* CALL FOR AVAILABILITY

Corbelstone, Inc.

5831 Hilltop Drive
770-967-0076

Flowery Branch, Ga. 30542
www.corbelstone.com

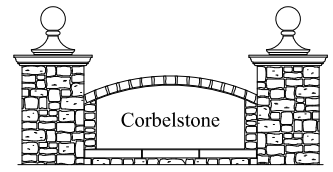

WALL COPING

PART #	DIMENSIONS				PRODUCT
	"A"	"B"	"C"	"L"	
CB-10-32* FLAT DBL BULLNOSED COPING	10"	2 3/4"		31 5/8"	
CB-12-32* FLAT DBL BULLNOSED COPING	12"	2 3/4"		31 5/8"	
CB-14-32* FLAT DBL BULLNOSED COPING	14"	2 3/4"		31 5/8"	
CB-18-32* FLAT DBL BULLNOSED COPING	18"	2 3/4"		31 5/8"	
CC-12-32* CROWN DOUBLE SLOPED COPING	12"	5 3/8"	4"	31 5/8"	<p>ENLARGED EDGE DETAIL</p>
CC-14-32* CROWN DOUBLE SLOPED COPING	14"	6 3/4"	5"	31 5/8"	
CC-18-32* CROWN DOUBLE SLOPED COPING	18"	7 1/8"	5"	31 5/8"	
CC-24-32* CROWN DOUBLE SLOPED COPING	24"	7 5/8"	5"	31 5/8"	

* CALL FOR AVAILABILITY

Corbelstone, Inc.

5831 Hilltop Drive
770-967-0076

Flowery Branch, Ga. 30542
www.corbelstone.com

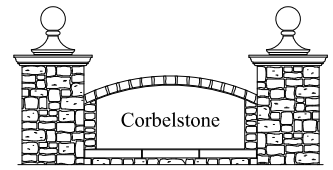

PIER CAPS

PART #	DIMENSIONS			PRODUCT
	"A"	"B"	"C"	
PC-12 PYRAMID PIER CAP	12"	3 1/16"	2"	
PC-16 PYRAMID PIER CAP	16"	3 7/16"	2"	
PC-18 PYRAMID PIER CAP	18"	3 9/16"	2"	
PC-20 PYRAMID PIER CAP	20"	3 3/4"	2"	
PC-24 PYRAMID PIER CAP	24"	5 1/8"	3"	
PC-26 PYRAMID PIER CAP	26"	5 1/4"	3"	
PC-28 PYRAMID PIER CAP	28"	5 1/2"	3"	
PC-30 PYRAMID PIER CAP	30"	5 5/8"	3"	
PC-32 PYRAMID PIER CAP	32"	6 7/8"	4"	
PC-36 PYRAMID PIER CAP	36"	7 1/4"	4"	
PC-12F FLAT PIER CAP	12"		4"	
PC-16F FLAT PIER CAP	16"		4"	
PC-18F FLAT PIER CAP	18"		4"	
PC-20F FLAT PIER CAP	20"		4"	
PC-24F FLAT PIER CAP	24"		4"	
PC-26F FLAT PIER CAP	26"		4"	
PC-28F FLAT PIER CAP	28"		4"	
PC-30F FLAT PIER CAP	30"		4"	
PC-32F FLAT PIER CAP	32"		4"	
PC-36F FLAT PIER CAP	36"		4"	

* CALL FOR AVAILABILITY

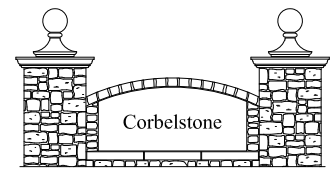

PIER CAPS

PART #	DIMENSIONS			PRODUCT
	"A"	"B"	"C"	
PC01-12 PYRAMID CROWN PIER CAP	12"	5 1/2"	4"	<p>ENLARGED EDGE DETAIL</p>
PC01-16 PYRAMID CROWN PIER CAP	16"	5 3/4"	4"	
PC01-18 PYRAMID CROWN PIER CAP	18"	6"	4"	
PC01-20 PYRAMID CROWN PIER CAP	20"	6 1/8"	4"	
PC01-24* PYRAMID CROWN PIER CAP	24"	7 5/8"	5"	
PC01-26 PYRAMID CROWN PIER CAP	26"	7 7/8"	5"	
PC01-28* PYRAMID CROWN PIER CAP	28"	8"	5"	
PC01-30* PYRAMID CROWN PIER CAP	30"	8 1/16"	5"	
PC01-32* PYRAMID CROWN PIER CAP	32"	8 3/8"	5"	
PC01-36* PYRAMID CROWN PIER CAP	36"	8 3/4"	5"	
PC02-12 FLAT CROWN PIER CAP	12"		4"	<p>ENLARGED EDGE DETAIL</p>
PC02-16 FLAT CROWN PIER CAP	16"		4"	
PC02-18 FLAT CROWN PIER CAP	18"		4"	
PC02-20 FLAT CROWN PIER CAP	20"		4"	
PC02-24 FLAT CROWN PIER CAP	24"		5"	
PC02-26 FLAT CROWN PIER CAP	26"		5"	
PC02-28 FLAT CROWN PIER CAP	28"		5"	
PC02-30 FLAT CROWN PIER CAP	30"		5"	
PC02-32 FLAT CROWN PIER CAP	32"		5"	
PC02-36 FLAT CROWN PIER CAP	36"		5"	

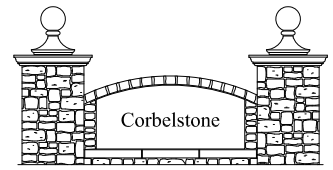

PIER CAPS

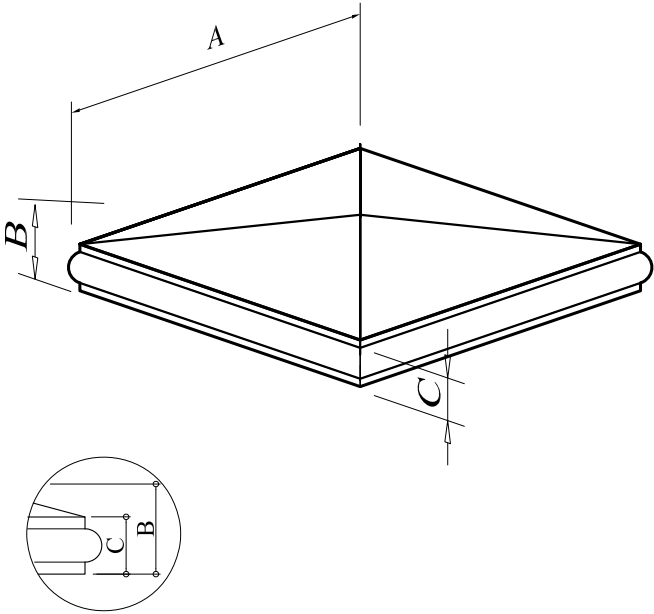
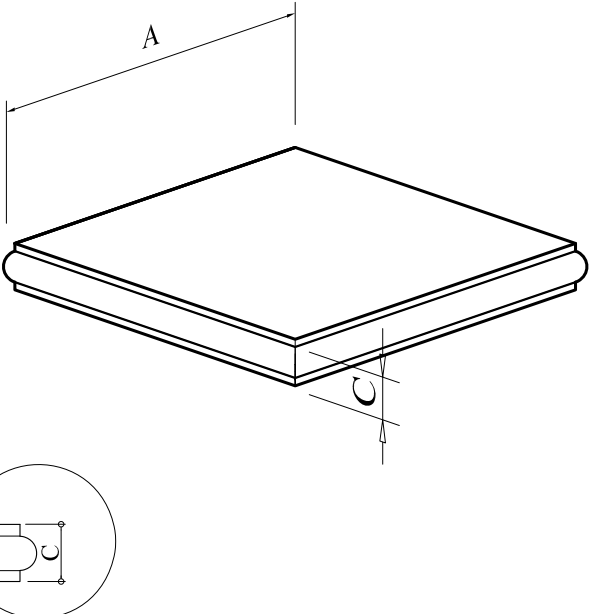
PART #	DIMENSIONS			PRODUCT
	"A"	"B"	"C"	
PC03-12* PYRAMID BULLNOSE PIER CAP	12"	5 1/16"	4"	 <p>ENLARGED EDGE DETAIL</p>
PC03-16* PYRAMID BULLNOSE PIER CAP	16"	5 3/8"	4"	
PC03-18* PYRAMID BULLNOSE PIER CAP	18"	5 9/16"	4"	
PC03-20* PYRAMID BULLNOSE PIER CAP	20"	5 3/4"	4"	
PC03-24* PYRAMID BULLNOSE PIER CAP	24"	6 1/8"	4"	
PC03-26* PYRAMID BULLNOSE PIER CAP	26"	6 3/8"	4"	
PC03-28* PYRAMID BULLNOSE PIER CAP	28"	6 1/2"	4"	
PC03-30* PYRAMID BULLNOSE PIER CAP	30"	6 5/8"	4"	
PC03-32* PYRAMID BULLNOSE PIER CAP	32"	6 7/8"	4"	
PC03-36* PYRAMID BULLNOSE PIER CAP	36"	7 1/8"	4"	
PC04-12* FLAT BULLNOSE PIER CAP	12"		4"	 <p>ENLARGED EDGE DETAIL</p>
PC04-16* FLAT BULLNOSE PIER CAP	16"		4"	
PC04-18* FLAT BULLNOSE PIER CAP	18"		4"	
PC04-20* FLAT BULLNOSE PIER CAP	20"		4"	
PC04-24* FLAT BULLNOSE PIER CAP	24"		4"	
PC04-26* FLAT BULLNOSE PIER CAP	26"		4"	
PC04-28* FLAT BULLNOSE PIER CAP	28"		4"	
PC04-30* FLAT BULLNOSE PIER CAP	30"		4"	
PC04-32* FLAT BULLNOSE PIER CAP	32"		4"	
PC04-36* FLAT BULLNOSE PIER CAP	36"		4"	

* CALL FOR AVAILABILITY

Corbelstone, Inc.

5831 Hilltop Drive
770-967-0076

Flowery Branch, Ga. 30542
www.corbelstone.com

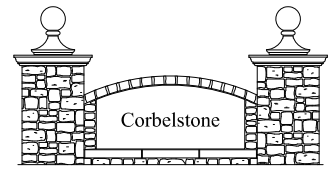

FINIALS

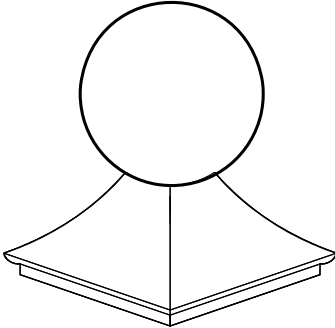
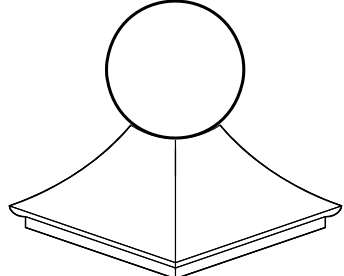
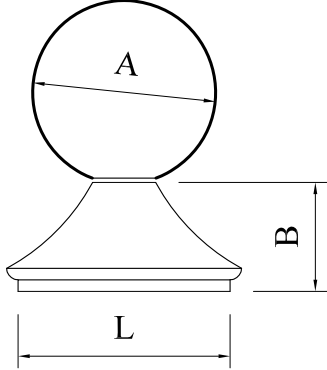
PART #	DIMENSIONS			PRODUCT
	"A"	"B"	"L"	
12" BALL	12"			 <p>FINIAL AND 16" BALL</p>
16" BALL	16"			
				 <p>FINIAL AND 12" BALL</p>
BALL FINIAL		9 1/2"	18 1/2"	
				

* CALL FOR AVAILABILITY

Corbelstone, Inc.

5831 Hilltop Drive
770-967-0076

Flowery Branch, Ga. 30542
www.corbelstone.com

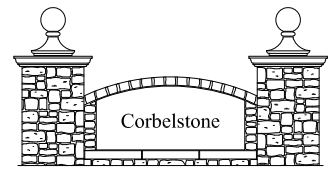

BALUSTRADE, BALUSTERS AND PIERS

PART #	"A"	"B"	"C"	"D"	"E"
BLU-01 BALUSTRADE	36"	6 3/4"			
BLU-02 BALUSTRADE	41"	6 3/4"			
BHR-01 HAND RAIL			3 3/8"	28 7/8"	
BBR-01 BASE RAIL			4 3/8"	28 7/8"	
BL-01 BALUSTERS			27 1/4"	5 1/8"	5 3/4"
BPU-01 PIER UNIT			41 1/2"	15"	13 1/2"

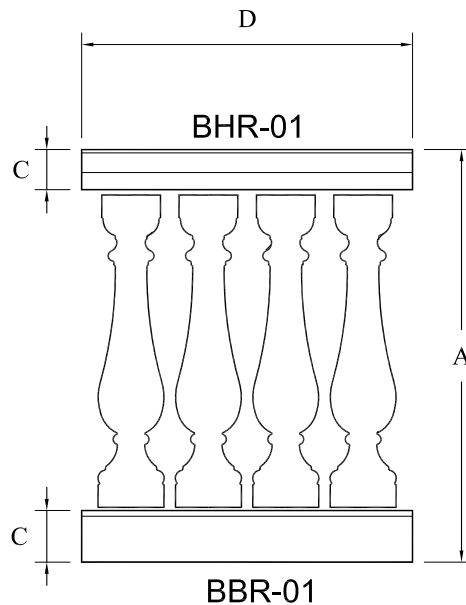
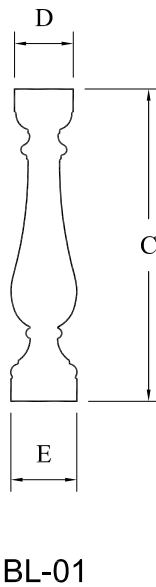
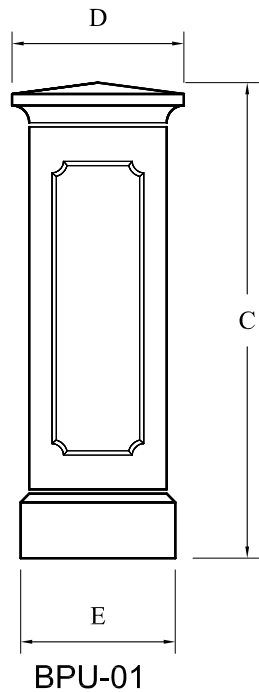
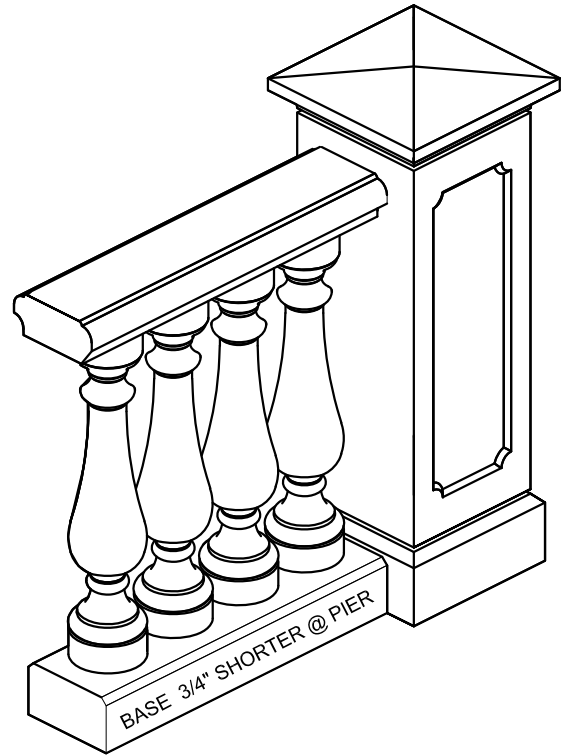

Corbelstone, Inc.

5831 Hilltop Drive
770-967-0076

Flowery Branch, Ga. 30542
www.corbelstone.com

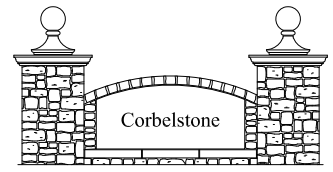

NUMBER BLOCKS

PART #	DIMENSIONS			PRODUCT
	"A"	"B"	"L"	
SN00 SMALL NUMBER BLOCK "0"	5 1/8"	3"	3"	
SN01 SMALL NUMBER BLOCK "1"	5 1/8"	3"	3"	
SN02 SMALL NUMBER BLOCK "2"	5 1/8"	3"	3"	
SN03 SMALL NUMBER BLOCK "3"	5 1/8"	3"	3"	
SN04 SMALL NUMBER BLOCK "4"	5 1/8"	3"	3"	
SN05 SMALL NUMBER BLOCK "5"	5 1/8"	3"	3"	
SN06 SMALL NUMBER BLOCK "6"	5 1/8"	3"	3"	
SN07 SMALL NUMBER BLOCK "7"	5 1/8"	3"	3"	
SN08 SMALL NUMBER BLOCK "8"	5 1/8"	3"	3"	
SN09 SMALL NUMBER BLOCK "9"	5 1/8"	3"	3"	

* CALL FOR AVAILABILITY

Corbelstone, Inc.

5831 Hilltop Drive
770-967-0076

Flowery Branch, Ga. 30542
www.corbelstone.com

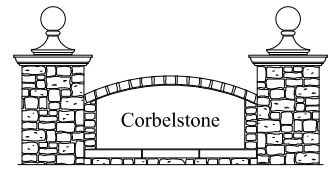

WALL VENEER

PART #	DIMENSIONS			PRODUCT
	"A"	"B"	"L"	
CV-0424* 4 SIDES CHAMFERED VENEER BLOCK 3 5/8" THICK x 3 5/8"HIGH x 23 5/8" LONG	3 5/8"	3 5/8"	23 5/8"	
CV-0824* 4 SIDES CHAMFERED VENEER BLOCK 3 5/8" THICK x 7 5/8"HIGH x 23 5/8" LONG	7 5/8"	3 5/8"	23 5/8"	
CV-1224* 4 SIDES CHAMFERED VENEER BLOCK 3 5/8" THICK x 11 5/8"HIGH x 23 5/8" LONG	11 5/8"	3 5/8"	23 5/8"	
CV-1624* 4 SIDES CHAMFERED VENEER BLOCK 3 5/8" THICK x 15 5/8"HIGH x 23 5/8" LONG	15 5/8"	3 5/8"	23 5/8"	
FV-0424* FLAT VENEER BLOCK 3 5/8" THICK x 3 5/8"HIGH x 23 5/8" LONG	3 5/8"	3 5/8"	23 5/8"	
FV-0824* FLAT VENEER BLOCK 3 5/8" THICK x 7 5/8"HIGH x 23 5/8" LONG	7 5/8"	3 5/8"	23 5/8"	
FV-1224* FLAT VENEER BLOCK 3 5/8" THICK x 11 5/8"HIGH x 23 5/8" LONG	11 5/8"	3 5/8"	23 5/8"	
FV-1624* FLAT VENEER BLOCK 3 5/8" THICK x 15 5/8"HIGH x 23 5/8" LONG	15 5/8"	3 5/8"	23 5/8"	

* CALL FOR AVAILABILITY

Corbelstone, Inc.

5831 Hilltop Drive
770-967-0076

Flowery Branch, Ga. 30542
www.corbelstone.com

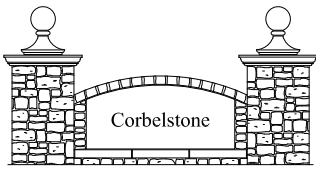

WALL VENEER

PART #	DIMENSIONS			PRODUCT
	"A"	"B"	"L"	
RV-0424* ROCK FACED VENEER BLOCK 3 5/8" THICK x 3 5/8"HIGH x 23 5/8" LONG	3 5/8"	3 5/8"	23 5/8"	
RV-0824* ROCK FACED VENEER BLOCK 3 5/8" THICK x 7 5/8"HIGH x 23 5/8" LONG	7 5/8"	3 5/8"	23 5/8"	
RV-1224* ROCK FACED VENEER BLOCK 3 5/8" THICK x 11 5/8"HIGH x 23 5/8" LONG	11 5/8"	3 5/8"	23 5/8"	
RV-1624* ROCK FACED VENEER BLOCK 3 5/8" THICK x 15 5/8"HIGH x 23 5/8" LONG	15 5/8"	3 5/8"	23 5/8"	

* CALL FOR AVAILABILITY