















Superior[™]
FIREPLACES

Our name is our promise.

TRADITIONAL

Value and quality construction come together to provide long-lasting warmth in a traditional hearth setting.

FEATURES

-  Available in 36" and 42" models
-  Radiant smooth-faced or circulating rolled louver models
-  Fully insulated firebox (on select models)
-  White stacked refractory panels
-  Log grate
-  Push/pull damper control
-  Includes mesh fire screens
-  Barometric outside air damper
-  Fan kit available (for circulating models only)
-  Durable textured powder coat finish
-  Uses IHP 8 DM (1700°) double wall air cooled wood burning chimney
-  20 year limited warranty

INTERIOR

(Required)



White Stacked

APPLIANCE SPECIFICATIONS

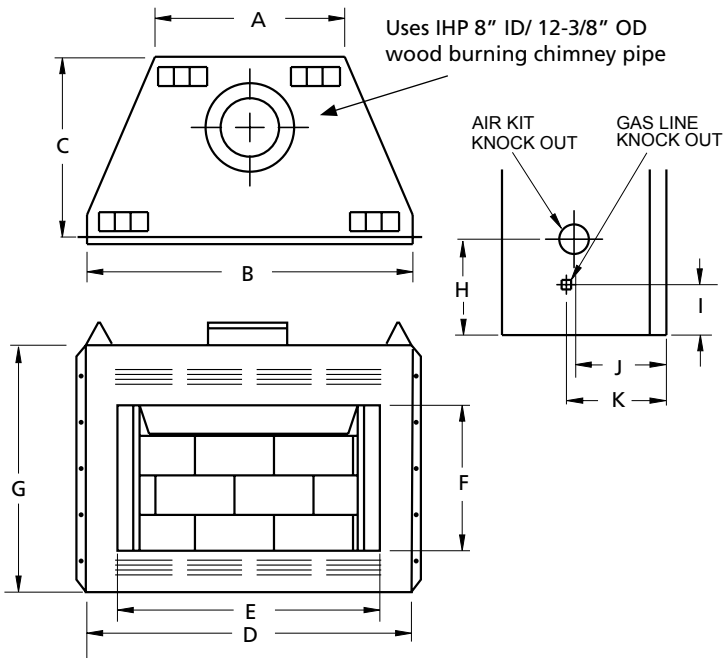

OPTIONAL ACCESSORIES

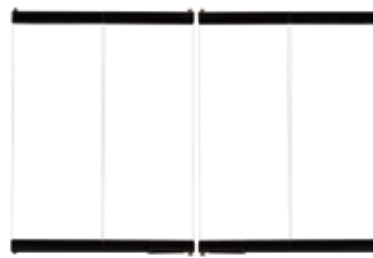

Bi-Fold Glass Doors



Black



Brushed Brass



Platinum

ADDITIONAL ACCESSORIES

- A.** Outside air kit
- B.** Gas Logs

FRAMING SPECIFICATIONS

	WRT/WCT2036	WRT/WCT2042
WIDTH	38-1/4"	44-1/4"
HEIGHT	38-5/8"	37-5/8"
DEPTH	22"	22"

	WRT/WCT2036	WRT/WCT2042
A	22-1/2"	28-1/2"
B	36"	42"
C	21-1/8"	21-18"
D	38"	44"
E	36"	42"
F	21-1/2"	21-1/2"
G	34"	33"
H	13-7/8"	13-7/8"
I	9-1/8"	8-1/4"
J	9-5/8"	9-5/8"
K	10-3/16"	10-3/16"

ON THE COVER: WCT2036 with white stacked refractory panels

IMPORTANT NOTES:

As with any fireplace, this appliance is extremely hot during operation. Read and understand all operating instructions before using this appliance. For further information, consult your dealer.

Local conditions, such as elevation, wind, vent configuration and choice of fuel will affect overall appearance of the fire and heating performance. Performance can also vary with home design and insulation, climate, condition and type of fuel used, appliance location, burn rate, accessories chosen, chimney installation and how the appliance is operated.

Diagrams, illustrations and photographs are not to scale—consult installation instructions. Product designs, materials, dimensions, specifications, colors and prices are subject to change or discontinuance without notice.

Visit us online



SuperiorFireplaces.us.com



© 2014 Innovative Hearth Products

785356M 07/14

