

MECHANICAL ADVANTAGE

Name _____

What is the mechanical advantage of the following simple machines?

$$MA = \frac{F_R}{F_E} \quad \text{where } F_R = \text{resistance force}$$

$$F_E = \text{effort force}$$

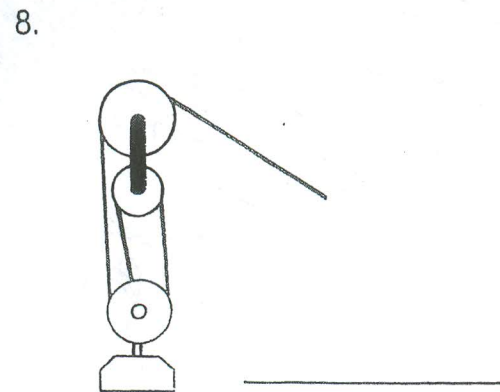
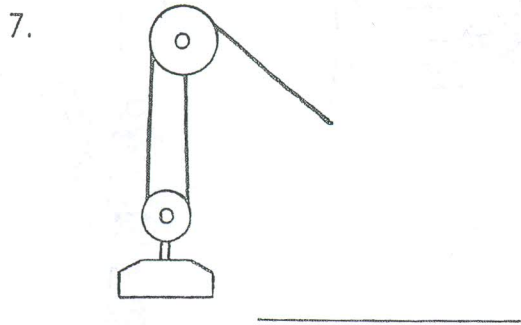
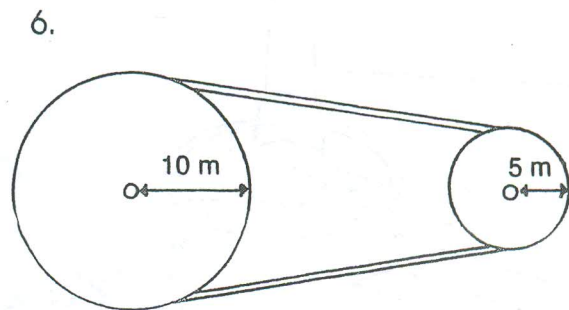
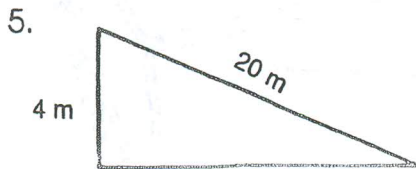
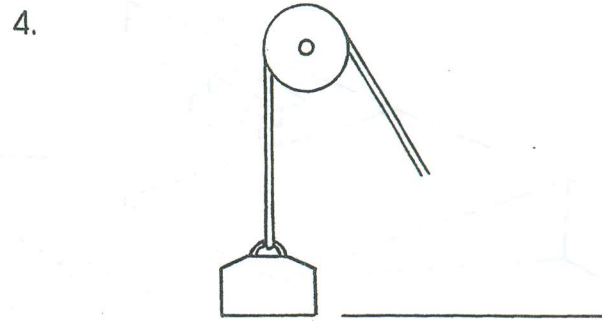
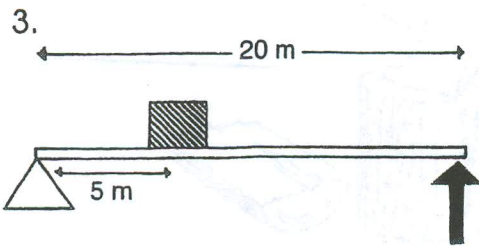
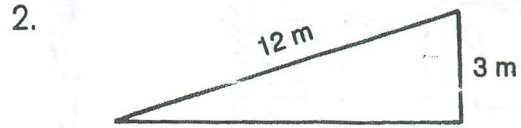
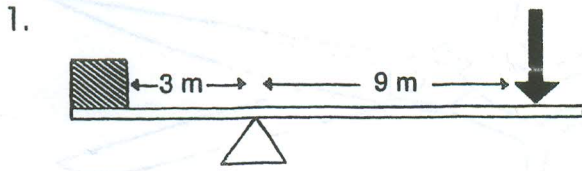

SIMPLE MACHINES

Name _____

What types of simple machines are shown in the following pictures?

